

Marc Pansu  
Jacques Gautheyrou

# of Handbook SOIL ANALYSIS

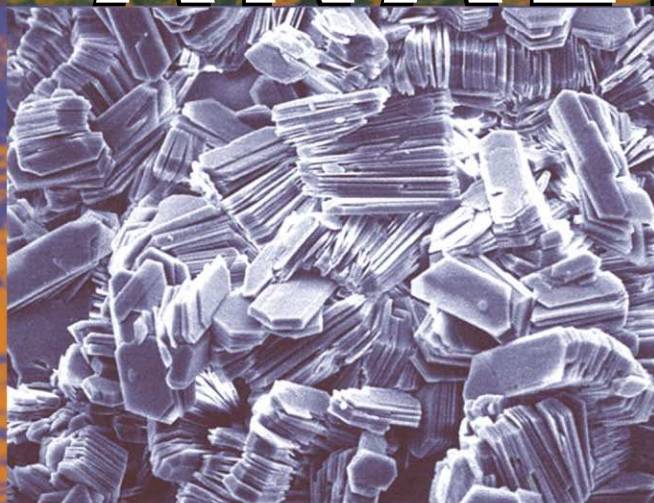

MINERALOGICAL,  
ORGANIC  
AND INORGANIC  
METHODS

 Springer

---

Marc Pansu  
Jacques Gautheyrou  
**Handbook of Soil Analysis**  
Mineralogical, Organic and Inorganic Methods

Marc Pansu  
Jacques Gautheyrou

# **Handbook of Soil Analysis**

Mineralogical, Organic  
and Inorganic Methods

with 183 Figures and 84 Tables

 Springer

Dr Marc Pansu  
Centre IRD BP 64501  
Avenue Agropolis 911  
34394 Montpellier Cedex 5  
France

*E-mail* : pansu@mpl.ird.fr

Jacques Gautheyrou  
Avenue de Marinville 6  
94100 St. Maur des Fossés  
France

---

Updated English version, corrected by Daphne Goodfellow. The original French book "L'analyse du sol, minéralogique et minérale" by Marc Pansu and Jacques Gautheyrou, was published in 2003 by Springer-Verlag, Berlin Heidelberg New York.

---

Library of Congress Control Number: 2005938390

ISBN-10 3-540-31210-2 Springer Berlin Heidelberg New York  
ISBN-13 978-3-540-31210-9 Springer Berlin Heidelberg New York

This work is subject to copyright. All rights are reserved, whether the whole or part of the material is concerned, specifically the rights of translation, reprinting, reuse of illustrations, recitation, broadcasting, reproduction on microfilm or in any other way, and storage in data banks. Duplication of this publication or parts thereof is permitted only under the provisions of the German Copyright Law of September 9, 1965, in its current version, and permission for use must always be obtained from Springer-Verlag. Violations are liable to prosecution under the German Copyright Law.

**Springer is a part of Springer Science+Business Media**  
springer.com  
© Springer-Verlag Berlin Heidelberg 2006  
Printed in The Netherlands

The use of general descriptive names, registered names, trademarks, etc. in this publication does not imply, even in the absence of a specific statement, that such names are exempt from the relevant protective laws and regulations and therefore free for general use.

Cover design: E. Kirchner, Heidelberg  
Production: Almas Schimmel  
Typesetting: SPI Publisher Services  
Printing: Krips bv, Meppel  
Binding: Stürtz AG, Würzburg

Printed on acid-free paper 30/3141/as 5 4 3 2 1 0



---

## FOREWORD

This new book by Marc Pansu and Jacques Gautheyrou provides a synopsis of the analytical procedures for the physicochemical analysis of soils. It is written to conform to analytical standards and quality control. It focuses on mineralogical, organic and inorganic analyses, but also describes physical methods when these are a precondition for analysis. It will help a range of different users to choose the most appropriate method for the type of material and the particular problems they have to face. The compiled work is the product of the experience gained by the authors in the laboratories of the Institute of Research for Development (IRD) in France and in tropical countries, and includes an extensive review of the literature. The reference section at the end of each chapter lists source data from pioneer studies right up to current works, such as, proposals for structural models of humic molecules, and itself represents a valuable source of information.

IRD soil scientists collected data on Mediterranean and tropical soils in the field from West and North Africa, Madagascar, Latin America, and South East Asia. Soil materials from these regions are often different from those found in temperate zones. As their analysis brought new problems to light, it was essential to develop powerful and specific physicochemical methods. Physicists, chemists and biologists joined forces with IRD soil scientists to contribute knowledge from their own disciplines thereby widening its scope considerably. This work is the fruit of these experiments as applied to complex systems, involving soils and the environment.

The methodological range is particularly wide and each chapter presents both simple analyses and analyses that may require sophisticated equipment, as well as specific skills. It is aimed both at teams involved in practical field work and at researchers involved in fundamental and applied research. It describes the principles, the physical and chemical basis of each method, the corresponding analytical procedures, and the constraints and limits of each. The descriptions are practical, easy to understand and implement. Summary tables enable a rapid overview of the data. Complex techniques are explained under the heading 'Principle' and concrete examples of methods include: spectra (near and far IR, UV-visible,  $^1\text{H}$ -NMR,  $^{13}\text{C}$ -NMR, ESR, ICP-AES, ICP-MS, X-ray fluorescence, EDX or WDX microprobe, neutron activation analysis), diffractograms (XRD, electron microdiffraction), thermograms (DTA, DTG, TGA), chromatograms (GPC, HPLC, ionic chromatography, exclusion chromatography), electrophoregrams, ion exchange methods, electrochemistry, biology, different physical separation techniques, selective dissolutions, and imagery.

---

The book will be valuable not only for researchers, engineers, technicians and students in soil science, but also for agronomists and ecologists and others in related disciplines, such as, analytical physical chemistry, geology, climatology, civil engineering and industries associated with soil. It is a basic work whose goal is to contribute to the scientific analysis of the environment. The methodologies it describes apply to a wide range of bioclimatic zones: temperate, arid, subtropical and tropical. As with the previous books by the same authors (Pansu, Gautheyrou and Loyer, 1998, Masson, Paris, Milan, Barcelona; Pansu, Gautheyrou and Loyer, 2001, Balkema, Lisse, Abington, Exton, Tokyo), this new book represents a reference work for our laboratories. We are confident its originality and ease of use will ensure its success.

Alain Aventurier, Director of Analytical Laboratories of CIRAD<sup>1</sup>  
Christian Feller, Director of Research at IRD<sup>2</sup>  
Pierre Bottner, Director of Research at CNRS<sup>3</sup>

---

<sup>1</sup> CIRAD, *Centre International pour la Recherche Agronomique et le Développement* (France).

<sup>2</sup> IRD, *Institut de Recherche pour le Développement* (ex ORSTOM, France).

<sup>3</sup> CNRS, *Centre National de la Recherche Scientifique* (France).

---

# CONTENTS

## PART 1 - MINERALOGICAL ANALYSIS

### CHAPTER 1 Water Content and Loss on Ignition

<b>1.1 Introduction</b> .....	3
<b>1.2 Water Content at 105°C (H<sub>2</sub>O<sup>-</sup>)</b> .....	6
1.2.1 Principle .....	6
1.2.2 Materials .....	6
1.2.3 Sample .....	6
1.2.4 Procedure .....	7
1.2.5 Remarks .....	7
<b>1.3 Loss on Ignition at 1,000°C (H<sub>2</sub>O<sup>+</sup>)</b> .....	8
1.3.1 Introduction .....	8
1.3.2 Principle .....	11
1.3.3 Equipment .....	11
1.3.4 Procedure .....	11
1.3.5 Calculations .....	12
1.3.6 Remarks .....	12
<b>Bibliography</b> .....	12

### CHAPTER 2 Particle Size Analysis

<b>2.1 Introduction</b> .....	15
2.1.1 Particle Size in Soil Science .....	15
2.1.2 Principle .....	17
2.1.3 Law of Sedimentation .....	18
2.1.4 Conditions for Application of Stokes Law .....	24
<b>2.2 Standard Methods</b> .....	26
2.2.1 Pretreatment of the Sample .....	26
2.2.2 Particle Suspension and Dispersion .....	31
2.2.3 Pipette Method after Robinson-Köhn or Andreasen .....	35
2.2.4 Density Method with Variable Depth .....	42
2.2.5 Density Method with Constant Depth .....	47
2.2.6 Particle Size Analysis of Sands Only .....	48
<b>2.3 Automated Equipment</b> .....	50
2.3.1 Introduction .....	50
2.3.2 Method Using Sedimentation by Simple Gravity .....	51
2.3.3 Methods Using Accelerated Sedimentation .....	53
2.3.4 Methods Using Laser Scattering and Diffraction .....	54
2.3.5 Methods Using Optical and Electric Properties .....	55
2.3.6 Methods Allowing Direct Observations of the Particles .....	55
2.3.7 Methods Using Conductivity .....	56
<b>References</b> .....	56
<b>Bibliography</b> .....	58
Generality .....	58

---

Pre-treatment.....	58
Pipette Method.....	61
Hydrometer Method .....	62
Instrumental Methods .....	62
<b>CHAPTER 3 Fractionation of the Colloidal Systems</b>	
<b>3.1 Introduction .....</b>	<b>65</b>
<b>3.2 Fractionation by Continuous Centrifugation .....</b>	<b>66</b>
3.2.1 Principle.....	66
3.2.2 Theory .....	69
3.2.3 Equipment and reagents .....	73
3.2.4 Procedure.....	75
<b>3.3 Pretreatment of the Extracted Phases .....</b>	<b>79</b>
<b>References.....</b>	<b>81</b>
<b>Bibliography .....</b>	<b>81</b>
<b>CHAPTER 4 Mineralogical Characterisations by X-Ray Diffractometry</b>	
<b>4.1 Introduction .....</b>	<b>83</b>
4.1.1 X-Ray Diffraction and Mineralogy.....	83
4.1.2 Principle.....	86
4.1.3 XRD Instrumentation .....	87
<b>4.2 Qualitative Diffractometry .....</b>	<b>90</b>
4.2.1 Overview of Preparation of the Samples .....	90
4.2.2 Preparation for Powder Diagrams .....	90
4.2.3 Preparation for Oriented Diagrams.....	94
4.2.4 Pretreatment of Clays .....	99
4.2.5 Qualitative Diffractometry .....	113
<b>4.3 Quantitative Mineralogical Analysis .....</b>	<b>118</b>
4.3.1 Interest .....	118
4.3.2 Quantitative Mineralogical Analysis by XRD.....	118
4.3.3 Multi-Instrumental Quantitative Mineralogical Analysis.....	124
<b>References.....</b>	<b>126</b>
<b>Bibliography .....</b>	<b>127</b>
General.....	127
Preparation of Oriented Aggregates on Porous Ceramic Plate .....	128
Saturation of Clays by Cations .....	129
Saturation, Solvation, Intercalation Complex, Dissolution .....	129
Preparation of Iron Oxides.....	130
Quantitative XRD.....	130
<b>CHAPTER 5 Mineralogical Analysis by Infra-Red Spectrometry</b>	
<b>5.1 Introduction .....</b>	<b>133</b>
5.1.1 Principle.....	133
5.1.2 IR Instrumentation .....	135
<b>5.2 IR Spectrometry in Mineralogy .....</b>	<b>138</b>
5.2.1 Equipment and Products .....	138
5.2.2 Preparation of the Samples .....	139
5.2.3 Brief Guide to Interpretation of the Spectra.....	146
5.2.4 Quantitative Analysis .....	152

---

<b>5.3 Other IR Techniques</b> .....	156
5.3.1 Near-infrared Spectrometry (NIRS).....	156
5.3.2 Coupling Thermal Measurements and FTIR Spectrometry of Volatile Products .....	158
5.3.3 Infrared Microscopy.....	159
5.3.4 Raman Scattering Spectroscopy .....	159
<b>References</b> .....	161
<b>Chronobibliography</b> .....	162

## CHAPTER 6 Mineralogical Separation by Selective Dissolution

<b>6.1 Introduction</b> .....	167
6.1.1 Crystallinity of Clay Minerals.....	167
6.1.2 Instrumental and Chemical Methods .....	169
6.1.3 Selective Dissolution Methods.....	172
6.1.4 Reagents and Synthetic Standards .....	174
<b>6.2 Main Selective Dissolution Methods</b> .....	180
6.2.1 Acid Oxalate Method Under Darkness (AOD).....	180
6.2.2 Dithionite-Citrate-Bicarbonate Method (DCB).....	187
6.2.3 EDTA Method .....	192
6.2.4 Pyrophosphate Method.....	196
6.2.5 Extraction in Strongly Alkaline Mediums .....	201
<b>6.3 Other Methods, Improvements and Choices</b> .....	206
6.3.1 Differential Sequential Methods .....	206
6.3.2 Selective Methods for Amorphous Products .....	210
6.3.3 Brief Overview to the Use of the Differential Methods .....	214
<b>References</b> .....	215

## CHAPTER 7 Thermal Analysis

<b>7.1 Introduction</b> .....	221
7.1.1 Definition.....	221
7.1.2 Interest.....	223
<b>7.2 Classical Methods</b> .....	226
7.2.1 Thermogravimetric Analysis.....	226
7.2.2 Differential Thermal Analysis and Differential Scanning Calorimetry	235
<b>7.3 Multi-component Apparatuses for Thermal Analysis</b> .....	246
7.3.1 Concepts.....	246
7.3.2 Coupling Thermal Analysis and Evolved Gas Analysis.....	247
<b>References</b> .....	249
<b>Chronobibliography</b> .....	250

## CHAPTER 8 Microscopic Analysis

<b>8.1 Introduction</b> .....	253
<b>8.2 Preparation of the Samples</b> .....	254
8.2.1 Interest.....	254
8.2.2 Coating and Impregnation, Thin Sections.....	255
8.2.3 Grids and Replicas for Transmission Electron Microscopy .....	261
8.2.4 Mounting the Samples for Scanning Electron Microscopy .....	263
8.2.5 Surface Treatment (Shadowing, Flash-carbon, Metallization) .....	265



<b>8.3 Microscope Studies</b> .....	267
8.3.1 Optical Microscopy .....	267
8.3.2 Electron Microscopy, General Information .....	270
8.3.3 Transmission Electron Microscopy, Micro-diffraction .....	271
8.3.4 Scanning Electron Microscopy.....	279
8.3.5 Ultimate Micro-analysis by X-Ray Spectrometry.....	282
<b>References</b> .....	283
<b>Chronobibliography</b> .....	284

## PART 2 - ORGANIC ANALYSIS

### CHAPTER 9 Physical Fractionation of Organic Matter

<b>9.1 Principle and Limitations</b> .....	289
9.1.1 Forms of Organic Matter in Soil .....	289
9.1.2 Principle.....	289
9.1.3 Difficulties .....	291
<b>9.2 Methods</b> .....	293
9.2.1 Classification .....	293
9.2.2 Extraction of Plant Roots .....	293
9.2.3 Dispersion of the Particles .....	296
9.2.4 Separation by Density. ....	309
9.2.5 Particle Size Fractionations .....	314
9.2.6 Precision of the Fractionation Methods .....	320
<b>9.3 Conclusion and Outlook</b> .....	321
<b>References</b> .....	322

### CHAPTER 10 Organic and Total C, N (H, O, S) Analysis

<b>10.1 Introduction</b> .....	327
10.1.1 Soil Organic Matter.....	327
10.1.2 Sampling, Preparation of the Samples, Analytical Significance.....	330
<b>10.2 Wet Methods</b> .....	333
10.2.1 Total Carbon: General Information .....	333
10.2.2 Organic Carbon by Wet Oxidation at the Temperature of Reaction .....	335
10.2.3 Organic Carbon by Wet Oxidation at Controlled Temperature .....	340
10.2.4 Organic Carbon by Wet Oxidation and Spectrocolorimetry.....	342
10.2.5 Total Nitrogen by Wet Method: Introduction .....	342
10.2.6 Total Nitrogen by Kjeldahl Method and Titrimetry .....	344
10.2.7 Kjeldahl N, Titration by Spectrocolorimetry.....	349
10.2.8 Kjeldahl N, Titration by Selective Electrode .....	351
10.2.9 Mechanization and Automation of the Kjeldahl Method.....	353
10.2.10 Modified Procedures for NO <sub>3</sub> <sup>-</sup> , NO <sub>2</sub> <sup>-</sup> and Fixed N .....	354
<b>10.3 Dry Methods</b> .....	355
10.3.1 Total Carbon by Simple Volatilization .....	355
10.3.2 Simultaneous Instrumental Analysis by Dry Combustion: CHN(OS).....	356
10.3.3 CHNOS by Thermal Analysis .....	362

---

10.3.4 C and N Non-Destructive Instrumental Analysis.....	363
10.3.5 Simultaneous Analysis of the Different C and N Isotopes .....	364
<b>References</b> .....	365
<b>Bibliography</b> .....	367

## CHAPTER 11 Quantification of Humic Compounds

<b>11.1 Humus in Soils</b> .....	371
11.1.1 Definitions.....	371
11.1.2 Role in the Soil and Environment .....	373
11.1.3 Extractions.....	374
<b>11.2 Main Techniques</b> .....	375
11.2.1 Extraction .....	375
11.2.2 Quantification of the Extracts.....	379
11.2.3 Precision and Correspondence of the Extraction Methods .....	383
11.2.4 Purification of Humic Materials .....	389
<b>11.3 Further Alternatives and Complements Methods</b> .....	392
11.3.1 Alternative Method of Extraction .....	392
11.3.2 Fractionation of the Humin Residue.....	392
<b>References</b> .....	395
Humic Materials .....	395
Extraction, Titration, Purification and Fractionation of Humic Materials .....	396

## CHAPTER 12 Characterization of Humic Compounds

<b>12.1 Introduction</b> .....	399
12.1.1 Mechanisms of Formation.....	399
12.1.2 Molecular Structure.....	400
<b>12.2 Classical Techniques</b> .....	401
12.2.1 Fractionation of Humic Compounds.....	401
12.2.2 Titration of the Main Functional Groups .....	408
12.2.3 UV-Visible Spectrometry .....	410
12.2.4 Infra-Red Spectrography.....	413
<b>12.3 Complementary Techniques</b> .....	415
12.3.1 Improvements in Fractionation Technologies .....	415
12.3.2 Titration of Functional Groups.....	418
12.3.3 Characterization by Fragmentation .....	419
12.3.4 Nuclear Magnetic Resonance (NMR) .....	424
12.3.5 Fluorescence Spectroscopy.....	433
12.3.6 Electron Spin Resonance (ESR) Spectroscopy .....	435
12.3.7 Measurement of Molecular Weight and Molecular Size .....	437
12.3.8 Microscopic Observations .....	440
12.3.9 Other Techniques .....	441
<b>References</b> .....	442
Molecular Models.....	442
Fractionation, Determination of Molecular Weights and Molecular Sizes ..	443
Functional Group of Humic Compounds .....	445
Spectrometric Characterizations .....	446
UV-Visible, IR, Fluorescence, ESR Spectrometries .....	446
Nuclear Magnetic Resonance.....	447

Methods of Characterization by Fragmentation .....	449
Other Methods (Microscopy, X-ray, Electrochemistry, etc.) .....	451

### CHAPTER 13 Measurement of Non-Humic Molecules

<b>13.1 Introduction</b> .....	453
13.1.1 Non-Humic Molecules .....	453
13.1.2 Soil Carbohydrates .....	453
13.1.3 Soil Lipids .....	456
13.1.4 Pesticides and Pollutants .....	457
<b>13.2 Classical Techniques</b> .....	458
13.2.1 Acid Hydrolysis of Polysaccharides .....	458
13.2.2 Purification of Acid Hydrolysates .....	462
13.2.3 Colorimetric Titration of Sugars .....	464
13.2.4 Titration of Sugars by Gas Chromatography .....	467
13.2.5 Quantification of Total Lipids .....	472
13.2.6 Quantification of the Water-Soluble Organics .....	474
<b>13.3 Complementary Techniques</b> .....	475
13.3.1 Carbohydrates by Gas Chromatography .....	475
13.3.2 Carbohydrates by Liquid Chromatography .....	475
13.3.3 Fractionation and Study of the Soil Lipid Fraction .....	478
13.3.4 Measurement of Pesticide Residues and Pollutants .....	483
<b>References</b> .....	492
Soil Carbohydrates .....	492
Soil Lipids .....	494
Aqueous Extract .....	495
Pesticides and Pollutants .....	495

### CHAPTER 14 Organic Forms of Nitrogen, Mineralizable Nitrogen (and Carbon)

<b>14.1 Introduction</b> .....	497
14.1.1 The Nitrogen Cycle .....	497
14.1.2 Types of Methods .....	499
<b>14.2 Classical Methods</b> .....	500
14.2.1 Forms of Organic Nitrogen Released by Acid Hydrolysis .....	500
14.2.2 Organic Forms of Nitrogen: Simplified Method .....	509
14.2.3 Urea Titration .....	511
14.2.4 Potentially Available Nitrogen: Biological Methods .....	513
14.2.5 Potentially Mineralizable Nitrogen: Chemical Methods .....	521
14.2.6 Kinetics of Mineralization .....	526
<b>14.3 Complementary Methods</b> .....	531
14.3.1 Alternative Procedures for Acid Hydrolysis .....	531
14.3.2 Determination of Amino Acids .....	532
14.3.3 Determination of Amino Sugars .....	535
14.3.4 Proteins and Glycoproteins (glomalin) .....	538
14.3.5 Potentially Mineralizable Nitrogen by EUF .....	538

---

<b>References</b> .....	540
Organic Nitrogen Forms: General Articles .....	540
Nitrogen Forms by Acid Hydrolysis and Distillation .....	541
Improvement of Acid Hydrolysis .....	541
Determination of Amino Acids .....	541
Determination of Amino Sugars.....	542
Glomalin .....	542
Urea Titration.....	543
Potentially Mineralizable Nitrogen: General Papers .....	543
Potentially Mineralizable Nitrogen: Biological Methods .....	544
Potentially Mineralizable Nitrogen: Chemical Methods.....	545
Potentially Mineralizable Nitrogen by EUF .....	545
Mineralization Kinetics .....	546

### PART 3 - INORGANIC ANALYSIS – Exchangeable and Total Elements

#### CHAPTER 15 pH Measurement

<b>15.1 Introduction</b> .....	551
15.1.1 Soil pH .....	551
15.1.2 Difficulties .....	553
15.1.3 Theoretical Aspects .....	554
<b>15.2 Classical Measurements</b> .....	556
15.2.1 Methods .....	556
15.2.2 Colorimetric Method.....	557
15.2.3 Electrometric Method .....	560
15.2.4 Electrometric Checking and Calibration .....	564
15.2.5 Measurement on Aqueous Soil Suspensions .....	565
15.2.6 Determination of the pH-K and pH-Ca .....	567
15.2.7 Measurement on Saturated Pastes .....	567
15.2.8 Measurement on the Saturation Extract.....	568
15.2.9 Measurement of the pH-NaF .....	569
<b>15.3 In Situ Measurements</b> .....	570
15.3.1 Equipment.....	570
15.3.2 Installation in the Field .....	570
15.3.3 Measurement on Soil Monoliths.....	572
<b>References</b> .....	574
<b>Bibliography</b> .....	575
<b>Appendix</b> .....	576
Appendix 1: Table of Electrode Potentials .....	576
Appendix 2: Constants of Dissociation of Certain Equilibriums.....	577
Appendix 3: Buffer Solutions.....	577
Appendix 4: Coloured Indicators.....	579

#### CHAPTER 16 Redox Potential

<b>16.1 Definitions and Principle</b> .....	581
<b>16.2 Equipment and Reagents</b> .....	583
16.2.1 Electrodes .....	583
16.2.2 Salt Bridge for Connection .....	584
16.2.3 System of Measurement .....	584
16.2.4 Calibration Solutions .....	585

<b>16.3 Procedure</b> .....	585
16.3.1 Pretreatment of the Electrode .....	585
16.3.2 Measurement on Soil Sample .....	586
16.3.3 Measurement on Soil Monolith .....	586
16.3.4 In Situ Measurements.....	587
16.3.5 Measurement of Oxygen Diffusion Rate .....	588
16.3.6 Colorimetric Test of Eh .....	589
<b>References</b> .....	589
<b>Bibliography</b> .....	590

## CHAPTER 17 Carbonates

<b>17.1 Introduction</b> .....	593
<b>17.2 Measurement of Total Carbonates</b> .....	595
17.2.1 Introduction .....	595
17.2.2 Volumetric Measurement by Calcimetry .....	596
17.2.3 Acidimetry.....	599
<b>17.3 Titration of Active Carbonate</b> .....	601
17.3.1 Principle.....	601
17.3.2 Implementation .....	601
17.3.3 Index of Chlorosis Potential.....	603
<b>References</b> .....	604

## CHAPTER 18 Soluble Salts

<b>18.1 Introduction</b> .....	605
<b>18.2 Extraction</b> .....	606
18.2.1 Soil/solution Ratio .....	606
18.2.2 Extraction of Saturated Paste .....	607
18.2.3 Diluted Extracts .....	608
18.2.4 In Situ Sampling of the Soil Water .....	609
18.2.5 Extracts with Hot Water .....	610
<b>18.3 Measurement and Titration</b> .....	610
18.3.1 Electrical Conductivity of Extracts.....	610
18.3.2 In Situ Conductivity.....	613
18.3.3 Total Dissolved Solid Material .....	614
18.3.4 Soluble Cations .....	615
18.3.5 Extractable Carbonate and Bicarbonate (Alkalinity) .....	616
18.3.6 Extractable Chloride .....	618
18.3.7 Extractable Sulphate, Nitrate and Phosphate .....	620
18.3.7 Extractable Boron .....	620
18.3.8 Titration of Extractable Anions by Ionic Chromatography.....	622
18.3.9 Expression of the Results .....	625
<b>References</b> .....	626

## CHAPTER 19 Exchange Complex

<b>19.1 Introduction</b> .....	629
<b>19.2 Origin of Charges</b> .....	630
19.2.1 Ionic Exchange .....	630



---

19.2.2 Exchange Complex .....	631
19.2.3 Theory .....	633
<b>References</b> .....	636
<b>Chronobibliography</b> .....	637
 <b>CHAPTER 20 Isoelectric and Zero Charge Points</b>	
<b>20.1 Introduction</b> .....	645
20.1.1 Charges of Colloids .....	645
20.1.2 Definitions .....	647
20.1.3 Conditions for the Measurement of Charge .....	649
<b>20.2 Main Methods</b> .....	651
20.2.1 Measurement of pH <sub>0</sub> (PZSE), Long Equilibrium Time .....	651
20.2.2 Point of Zero Salt Effect (PZSE), Short Equilibrium Time .....	652
<b>References</b> .....	655
 <b>CHAPTER 21 Permanent and Variable Charges</b>	
<b>21.1 Introduction</b> .....	657
<b>21.2 Main Methods</b> .....	661
21.2.1 Measurement of Variable Charges .....	661
21.2.2 Determination of Permanent Charges .....	662
<b>References</b> .....	664
<b>Bibliography</b> .....	665
 <b>CHAPTER 22 Exchangeable Cations</b>	
<b>22.1 Introduction</b> .....	667
22.1.1 Exchangeable Cations of Soil .....	667
22.1.2 Extracting Reagents .....	668
22.1.3 Equipment .....	669
<b>22.2 Ammonium Acetate Method at pH 7</b> .....	671
22.2.1 Principle .....	671
22.2.2 Procedure .....	671
<b>22.3 Automated Continuous Extraction</b> .....	674
<b>References</b> .....	674
<b>Bibliography</b> .....	676
 <b>CHAPTER 23 Exchangeable Acidity</b>	
<b>23.1 Introduction</b> .....	677
23.1.1 Origin of Acidity .....	677
23.1.2 Aims of the Analysis .....	678
<b>23.2 Method</b> .....	680
23.2.1 Principle .....	680
23.2.2 Reagents .....	680
23.2.3 Procedure .....	681
<b>23.3 Other Methods</b> .....	683
<b>References</b> .....	684
<b>Chronobibliography</b> .....	685

---

**CHAPTER 24 Lime Requirement**

<b>24.1 Introduction</b> .....	687
24.1.1 Correction of Soil Acidity.....	687
24.1.2 Calculation of Correction.....	688
<b>24.2 SMP Buffer Method</b> .....	690
24.2.1 Principle .....	690
24.2.2 Reagents .....	691
24.2.3 Procedure .....	691
24.2.4 Remarks .....	692
<b>References</b> .....	693
<b>Chronobibliography</b> .....	693

**CHAPTER 25 Exchange Selectivity, Cation Exchange Isotherm**

<b>25.1 Introduction</b> .....	697
<b>25.2 Determination of the Exchange Isotherm</b> .....	702
25.2.1 Principle .....	702
25.2.2 Reagents .....	702
25.2.3 Procedure.....	703
25.2.4 Remarks .....	704
<b>References</b> .....	705
<b>Chronobibliography</b> .....	706

**CHAPTER 26 Cation Exchange Capacity**

<b>26.1 Introduction</b> .....	709
26.1.1 Theoretical Aspects .....	709
26.1.2 Variables that Influence the Determination of CEC.....	711
<b>26.2 Determination of Effective CEC by Summation (ECEC)</b> .....	718
26.2.1 Principle.....	718
26.2.2 Alternative Methods.....	718
<b>26.3 CEC Measurement at Soil pH in Not-Buffered Medium</b> .....	719
26.3.1 Principle.....	719
26.3.2 Methods Using Not-Buffered Metallic Salts .....	719
26.3.3 Procedure Using Not-Buffered Organo Metallic Cations .....	722
26.3.4 Not-Buffered Methods Using Organic Cations .....	728
<b>26.4 CEC Measurement in Buffered Medium</b> .....	730
26.4.1 Buffered Methods — General Information .....	730
26.4.2 Ammonium Acetate Method at pH 7.0.....	732
26.4.3 Buffered Methods at pH 8.0–8.6.....	738
26.4.4 Buffered Methods at Different pH .....	743
<b>References</b> .....	745
<b>Bibliography</b> .....	750
CEC General Theory.....	750
Barium Method at soil pH .....	751
Buffered Method at pH 7.0 .....	751
Cobaltihexamine CEC .....	752
Silver-Thiourea .....	753
CEC with Organic Cations (Coloured Reagents) .....	753
Buffered Methods at pH 8.0–8.6.....	753
Barium Chloride-Triethanolamine at pH 8.1 .....	753

---

**CHAPTER 27 Anion Exchange Capacity**

<b>27.1 Theory</b> .....	755
<b>27.2 Measurement</b> .....	758
27.2.1 Principle .....	758
27.2.2 Method .....	760
<b>27.3 Simultaneous Measurement of AEC, EC, CEC and net CEC</b> .....	760
27.3.1 Aim .....	760
27.3.2 Description .....	761
<b>References</b> .....	763

**CHAPTER 28 Inorganic Forms of Nitrogen**

<b>28.1 Introduction</b> .....	767
28.1.1 Ammonium, Nitrate and Nitrite .....	767
28.1.3 Sampling Problems .....	768
28.1.4 Analytical Problems .....	768
<b>28.2 Usual Methods</b> .....	769
28.2.1 Extraction of Exchangeable Forms .....	769
28.2.2 Separation by Micro-Diffusion .....	770
28.2.3 Colorimetric Titration of Ammonium .....	773
28.2.4 Colorimetric Titration of Nitrites .....	775
28.2.5 Colorimetric Titration of Nitrates .....	778
28.2.6 Extracted Organic Nitrogen .....	779
<b>28.3 Other Methods</b> .....	780
28.3.1 Nitrate and Nitrite by Photometric UV Absorption .....	780
28.3.2 Ammonium Titration Using a Selective Electrode .....	782
28.3.3 Measurement of Nitrates with an Ion-Selective Electrode .....	785
28.3.4 In situ Measurement .....	788
28.3.5 Non-Exchangeable Ammonium .....	790
<b>References</b> .....	791
<b>Bibliography</b> .....	792

**CHAPTER 29 Phosphorus**

<b>29.1 Introduction</b> .....	793
<b>29.2 Total Soil Phosphorus</b> .....	794
29.2.1 Introduction .....	794
29.2.2 Wet Mineralization for Total Analyses .....	795
29.2.3 Dry Mineralization .....	798
<b>29.3 Fractionation of Different Forms of Phosphorus</b> .....	799
29.3.1 Introduction .....	799
29.3.2 Sequential Methods .....	800
29.3.3 Selective Extractions – Availability Indices .....	804
29.3.4 Isotopic Dilution Methods .....	813
29.3.5 Determination of Organic Phosphorus .....	814
<b>29.4 Retention of Phosphorus</b> .....	818
29.4.1 Introduction .....	818
29.4.2 Determination of P Retention .....	819

<b>29.5 Titration of P in the Extracts</b> .....	821
29.5.1 Introduction .....	821
29.5.2 Titration of <i>Ortho</i> -phosphoric P by Spectrocolorimetry .....	823
29.5.3 P Titration by Atomic Spectrometry .....	828
29.5.4 Titration of Different Forms of P by <sup>31</sup> P NMR .....	828
29.5.5 Separation of P Compounds by Liquid Chromatography .....	829
<b>29.6 Direct Speciation of P in situ, or on Extracted Particles</b> .....	830
<b>References</b> .....	830
<b>Chronobibliography</b> .....	833

## CHAPTER 30 Sulphur

<b>30.1 Introduction</b> .....	835
30.1.1 Sulphur Compounds .....	835
30.1.2 Mineralogical Studies .....	838
<b>30.2 Total Sulphur and Sulphur Compounds</b> .....	839
30.2.1 Characteristics of Fluvio marine Soils .....	839
30.2.2 Soil Sampling and Sample Preparation .....	840
30.2.3 Testing for Soluble Sulphur Forms .....	841
30.2.4 Titration of Total Sulphur .....	842
30.2.5 Total S Solubilisation by Alkaline Oxidizing Fusion .....	843
30.2.6 Total Solubilisation by Sodium Hypobromite in Alkaline Medium .....	844
30.2.7 S titration with Methylene Blue Colorimetry .....	845
30.2.8 Sulphate Titration by Colorimetry with Methyl Thymol Blue .....	850
30.2.9 Total Sulphur by Automated Dry CHN(OS) Ultimate Analysis .....	853
30.2.10 Titration of Total SO <sub>4</sub> <sup>2-</sup> -S by Ionic Chromatography .....	855
30.2.11 Total S Titration by Plasma Emission Spectrometry .....	857
30.2.12 Titration by X-ray Fluorescence .....	857
30.2.13 Titration by Atomic Absorption Spectrometry .....	857
30.2.14 Analytical Fractionation of Sulphur Compounds .....	858
30.2.15 Titration of Organic S bound to C .....	859
30.2.16 Titration of Organic S not bound to C .....	861
30.2.17 Extraction and Titration of Soluble Sulphides .....	863
30.2.18 Titration of Sulphur in Pyrites .....	865
30.2.19 Titration of Elementary Sulphur .....	867
30.2.20 Titration of Water Soluble Sulphates .....	869
30.2.21 Titration of Na <sub>3</sub> -EDTA Extractable Sulphates .....	871
30.2.22 Titration of Jarosite .....	873
30.2.23 Sequential Analysis of S Forms .....	876
<b>30.3 Sulphur of Gypseous Soils</b> .....	878
30.3.1 Gypseous Soils .....	878
30.3.2 Preliminary Tests .....	879
30.3.3 Extraction and Titration from Multiple Extracts .....	881
30.3.4 Gypsum Determination by Acetone Precipitation .....	882
<b>30.4 Sulphur and Gypsum Requirement of Soil</b> .....	883
30.4.1 Introduction .....	883
30.4.2 Plant Sulphur Requirement .....	884
30.4.3 Gypsum Requirement .....	886
<b>References</b> .....	888
<b>Chronobibliography</b> .....	890

---

**CHAPTER 31 Analysis of Extractable and Total Elements**

<b>31.1 Elements of Soils</b> .....	895
31.1.1 Major Elements .....	895
31.1.2 Trace Elements and Pollutants.....	897
31.1.3 Biogenic and Toxic Elements .....	899
31.1.4 Analysis of Total Elements .....	900
31.1.5 Extractable Elements.....	901
<b>31.2 Methods using Solubilization</b> .....	901
31.2.1 Total Solubilization Methods.....	901
31.2.2 Mean Reagents for Complete Dissolutions .....	903
31.2.3 Acid Attack in Open Vessel .....	906
31.2.4 Acid Attack in Closed Vessel.....	911
31.2.5 Microwave Mineralization .....	913
31.2.6 Alkaline Fusion .....	915
31.2.7 Selective Extractions .....	920
31.2.8 Measurement Methods.....	925
31.2.9 Spectrocolorimetric Analysis.....	927
31.2.10 Analysis by Flame Atomic Emission Spectrometry.....	931
31.2.11 Analysis by Flame Atomic Absorption Spectrometry .....	932
31.2.12 Analysis of Trace Elements by Hydride and Cold Vapour AAS .....	937
31.2.13 Analysis of Trace Elements by Electrothermal AAS .....	940
31.2.14 Analysis by Inductively Coupled Plasma-AES .....	941
31.2.15 Analysis by Inductively Coupled Plasma-Mass Spectrometry .....	946
<b>31.3 Analysis on Solid Medium</b> .....	952
31.3.1 Method .....	952
31.3.2 X-ray Fluorescence Analysis .....	954
31.3.3 Neutron Activation Analysis .....	962
<b>References</b> .....	969
<b>INDEX</b> .....	975
<b>PERIODIC TABLE OF THE ELEMENTS</b> .....	993



# Part 1

## Mineralogical Analysis

## Water Content and Loss on Ignition

### 1.1 Introduction

Schematically, a soil is made up of a solid, mineral and organic phase, a liquid phase and a gas phase. The physical and chemical characteristics of the solid phase result in both marked variability of water contents and a varying degree of resistance to the elimination of moisture.

For all soil analytical studies, the analyst must know the exact quantity of the solid phase in order to transcribe his results in a stable and reproducible form. The liquid phase must be separate, and this operation must not modify the solid matrix significantly (structural water is related to the crystal lattice).

Many definitions exist for the terms “moisture” and “dry soil”. The water that is eliminated by moderate heating, or extracted using solvents, represents only one part of total moisture, known as hygroscopic water, which is composed of (1) the water of adsorption retained on the surface of solids by physical absorption (forces of van der Waals), or by chemisorption, (2) the water of capillarity and swelling and (3) the hygrometrical water of the gas fraction of the soil (ratio of the effective pressure of the water vapour to maximum pressure). The limits between these different types of water are not strict.

“Air-dried” soil, which is used as the reference for soil preparation in the laboratory, contains varying amounts of water which depend in particular on the nature of secondary minerals, but also on external forces (temperature, the relative humidity of the air). Some andisols or histosols that are air dried for a period of 6 months can still contain 60% of water in comparison with soils dried at 105°C, and this can lead to unacceptable errors if the analytical results are not compared with a more realistic

reference for moisture.<sup>1</sup> Saline soils can also cause problems because of the presence of hygroscopic salts.

It is possible to determine remarkable water contents involving fields of force of retention that are sufficiently reproducible and representative (Table 1.1). These values can be represented in the form of capillary potential ( $\rho F$ ), the decimal logarithm of the pressure in millibars needed to bring a sample to a given water content (Table 1.1). It should be noted that because of the forces of van der Waals, there can be differences in state, but not in form, between water likely to evaporate at 20°C and water that does not freeze at -78°C. The analyst defines remarkable points for example:

- *The water holding capacity*, water content where the pressure component of the total potential becomes more significant than the gravitating component; this depends on the texture and the nature of the mineral and approaches *field capacity* which, after suitable drainage, corresponds to a null gravitating flow.
- *The capillary frangible point*, a state of moisture where the continuous water film becomes monomolecular and breaks.
- *The points of temporary and permanent wilting* where the pellicular water retained by the bonding strength balances with osmotic pressure; in this case, except for some halophilous plants, the majority of plants can no longer absorb the water that may still be present in the soil.
- *The hygroscopic water* which cannot be easily eliminated in the natural environment as this requires considerable energy, hygroscopic water evaporates at temperatures above 100°C and does not freeze at -78°C.
- *The water of constitution* and hydration of the mineral molecules can only be eliminated at very high pressures or at high temperatures, with irreversible modification or destruction of the crystal lattice.

These types of water are estimated using different types of measurements to study the water dynamics and the mechanisms related to the mechanical properties of soils in agronomy and agricultural engineering, for example:

- usable reserves (UR), easily usable reserves (EUR), or reserves that are easily available in soil-water-plant relations.
- thresholds of plasticity, adhesiveness, liquidity (limits of Atterberg, etc.).

---

<sup>1</sup> It should be noted that for these types of soil, errors are still amplified by the ponderal expression (because of an apparent density that is able to reach 0.3) this is likely to make the analytical results unsuitable for agronomic studies.

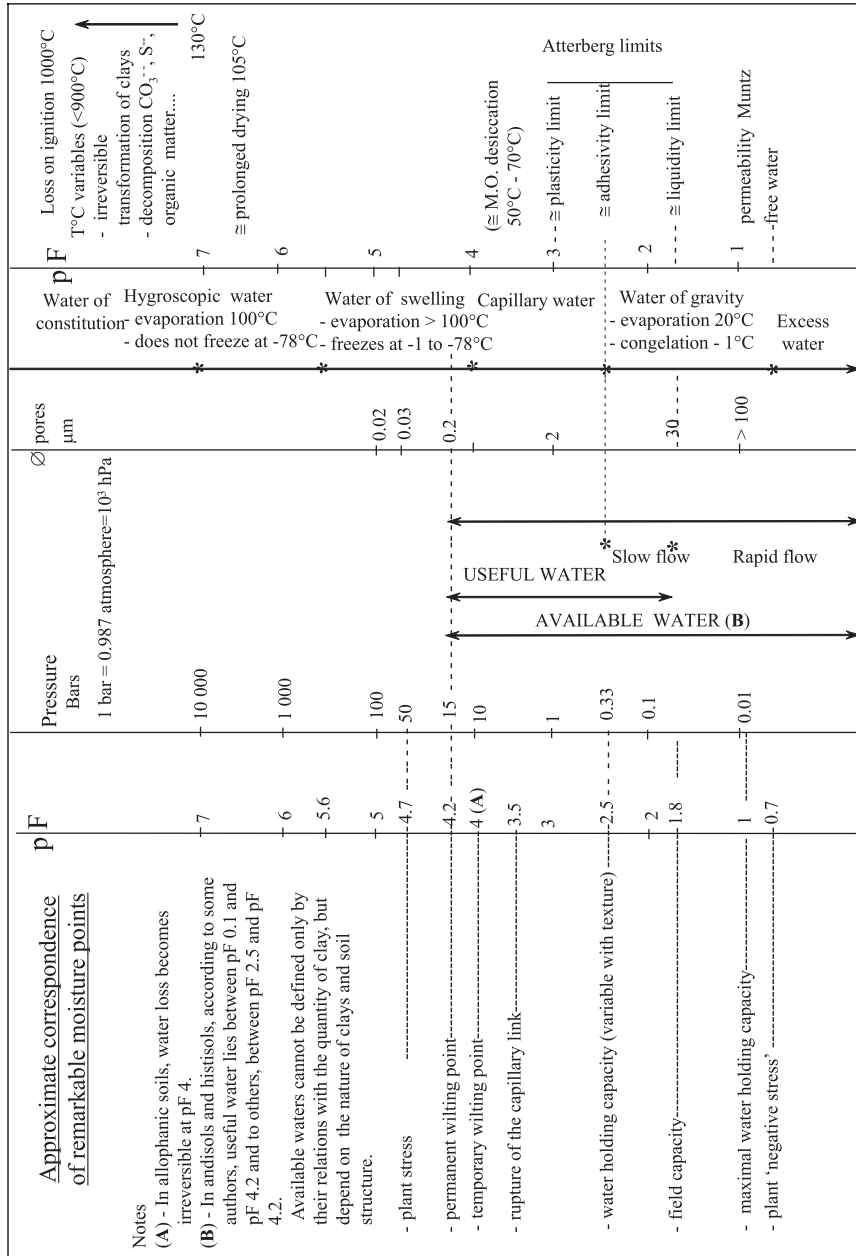

Table 1.1 - Approximate correspondence moistures - pressure - diameter of the pores - types of water and critical points in soils with respect to plant requirements

This brief summary gives an indication of the complexity of the concept of soil moisture and the difficulty for the analyst to find a scientifically defined basis for dry soil where the balance of the solid, liquid and gas phases is constant.

## **1.2 Water Content at 105°C (H<sub>2</sub>O<sup>-</sup>)**

### **1.2.1 Principle**

By convention, the term “moisture” is considered to be unequivocal. Measurement is carried out by gravimetry after drying at a maximum temperature of 105°C. This increase in temperature maintained for a controlled period of time, is sufficiently high to eliminate “free” forms of water and sufficiently low not to cause a significant loss of organic matter and unstable salts by volatilization. Repeatability and reproducibility are satisfactory in the majority of soils if procedures are rigorously respected.

### **1.2.2 Materials**

- 50 × 30 mm borosilicate glass low form weighing bottle with ground flat top cap.
- Vacuum type Ø 200 mm desiccator made of borosilicate glass with removable porcelain floor, filled with anhydrous magnesium perchlorate [Mg(ClO<sub>4</sub>)<sub>2</sub>].
- Thermostatically controlled drying oven with constant speed blower for air circulation and exhausting through a vent in the top of oven – temperature uniformity ± 0.5–1°C.
- Analytical balance: precision 0.1 mg, range 100 g.

### **1.2.3 Sample**

It is essential to measure water content on the same batch of samples prepared at the same time (fine earth with 2 mm particles or ground soil) for subsequent analyses. It should be noted that the moisture content of the prepared soil may change during storage (fluctuations in air moisture and temperature, oxidation of organic matter, loss or fixing of volatile substances, etc.).



This method can be considered “destructive” for certain types of soils and analyses, as the physical and chemical properties can be transformed. Samples dried at 105°C should generally not be used for other measurements.

#### 1.2.4 Procedure

- Dry tared weighing bottles for 2 h at 105°C, let them cool in the desiccator and weigh the tare with the lid placed underneath:  $m_0$
- Place about 5 g of air-dried soil (fine earth sieved through a 2 mm mesh) in the tare box and note the new weight:  $m_1$
- Place the weighing bottles with their flat caps placed underneath in a ventilated drying oven for 4 h at 105°C (the air exit must be open and the drying oven should not be overloaded)
- Cool in the desiccator and weigh (all the lids of the series contained in the desiccator should be closed to avoid moisture input):  $m_2$
- Again place the opened weighing bottles in the drying oven for 1 h at 105°C and weigh under the same conditions; the weight should be constant; if not, continue drying the weighing bottles until their weight is constant

$$\% \text{ water content at } 105^\circ\text{C} = 100 \times \frac{m_1 - m_2}{m_1 - m_0} .$$

#### 1.2.5 Remarks

The results can also be expressed in pedological terms of water holding capacity (HC) by the soil:  $\text{HC} = 100 \times \frac{m_1 - m_2}{m_2 - m_0} .$

The point of measurement at 105°C with constant mass is empirical (Fig. 1.1). A temperature of 130°C makes it possible to release almost all “interstitial water”, but this occurs to the detriment of the stability of organic matter. The speed of drying should be a function of the temperature, the surface of diffusion, the division of the solid, ventilation, pressure (vacuum), etc.

Respecting the procedure is thus essential:

- For andisols and histosols, the initial weighing should be systematically carried out after 6 h.
- For saline soils with large quantities of dissolved salts, the sample can be dried directly, soluble salts then being integrated into the “dry soil” or eliminated beforehand by treatment with water.

Fig. 1.1 - Theoretical diagrammatic curve showing water moved at a given temperature as a function of time (180°C = end of H<sub>2</sub>O losses in allophanes)

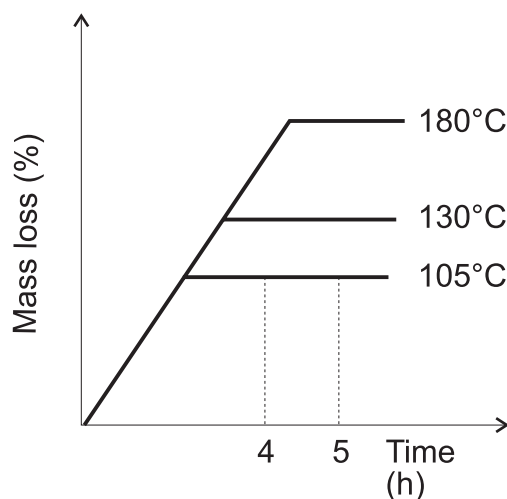

### 1.3 Loss on Ignition at 1,000°C (H<sub>2</sub>O<sup>+</sup>)

#### 1.3.1 Introduction

As we have just seen, the reference temperature (105°C) selected for the determination of the moisture content of a “dry soil” represents only a totally hypothetical state of the water that is normally referred to as H<sub>2</sub>O<sup>-</sup>.

When a sample undergoes controlled heating and the uninterrupted ponderal variations are measured, curves of “dehydration” are obtained whose inflections characterize losses in mass at certain critical temperatures (TGA).<sup>1</sup> If one observes the temperature curve compared to a thermally inert substance (Fig. 1.2), it is possible to determine changes in energy between the sample studied and the reference substance, this results in a change in the temperature which can be measured (DTA–DSC).<sup>2</sup>

- If the temperature decreases compared to the reference, an endothermic peak appears that characterizes loss of H<sub>2</sub>O (dehydration), of OH<sup>-</sup> (dehydroxylation), sublimation, or evaporation, or decomposition of certain substances, etc.
- If the temperature increases compared to the reference, an exothermic peak appears that characterizes transformations of crystalline structures, oxidations (Fe<sup>2+</sup> → Fe<sup>3+</sup>), etc.

<sup>2</sup> TGA thermogravimetric analysis; DTA differential thermal analysis; DSA differential scanning calorimetry (cf. Chap. 7).

Fig. 1.2 - Schematized example of thermal analysis curves  
TGA (solid line) and DTA (dashed line)

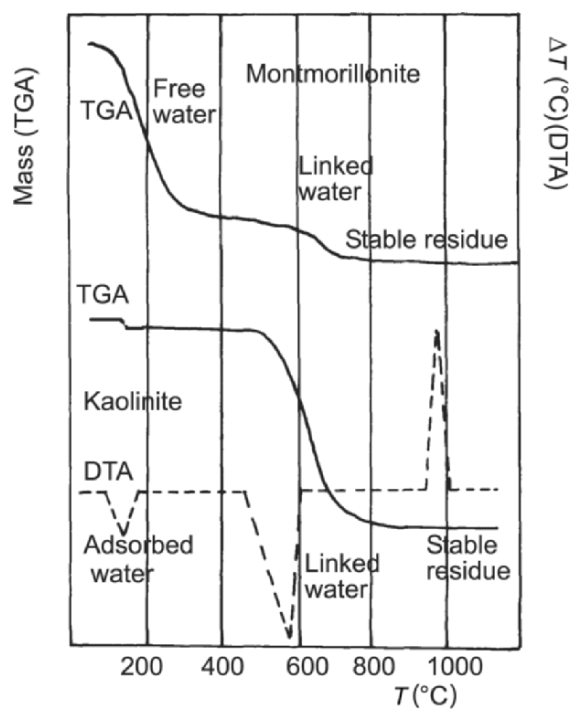

The simultaneous analysis of the gases or vapours that are emitted and X-ray diffraction (cf. Chap. 4) of the modifications in structure make it possible to validate the inflections of the curves or the different endo- and exothermic peaks.

As can be seen in the highly simplified Table 1.2, the most commonly observed clays are completely dehydroxylated at 1,000°C, oxides at 400°C or 500°C, carbonates, halogens, sulphates, sulphides are broken down or dehydrated between 300°C and 1,000°C, and free or bound organic matter between 300°C and 500°C. The temperature of 1,000°C can thus be retained as a stable reference temperature for loss on ignition, the thermal spectra then being practically flat up to the peaks of fusion which generally only appear at temperatures higher than 1,500°C or even 2,500°C.

### 1.3.2 Principle

The sample should be gradually heated in oxidizing medium to 1,000°C and maintained at this temperature for 4 h.

Table 1.2 Dehydration and dehydroxylation of some clays, oxides and salts as a function of temperature in °C

type	name	dehydration <sup>a</sup>	dehydroxylation <sup>b</sup>
clays 1:1	Kaolinite–halloysite	350	1,000
clays 2:1	smectites – montmorillonite	370	1,000
clays 2:1	Illite – micas	350–370	1,000
clays 2:1	vermiculite	700	1,000
clays 2:1:1	chlorite	600	800
fibrous clays	Sepiolite–	300	800–900
	palygorskite allophane	200	900–1,000
iron oxides	Hematite $\alpha$ Fe <sub>2</sub> O <sub>3</sub>	(flat spectrum)	1,000
	goethite $\alpha$ FeO–OH	100	370
	magnetite Fe <sub>2</sub> O <sub>3</sub>	375	650
Al oxides	gibbsite $\gamma$ -Al(OH) <sub>3</sub>	100	350
Ca carbonate	Calcite–aragonite CaCO <sub>3</sub>	–	950–1,000
Mg carbonate	magnesite MgCO <sub>3</sub>	–	710
Ca–Mg carbonate	dolomite CaMg(CO <sub>3</sub> ) <sub>2</sub>	–	800–940
halogenous compounds	sodium chloride NaCl	–	800 (fusion)
sulphate	gypsum CaSO <sub>4</sub> , 2H <sub>2</sub> O	–	300
sulphide	pyrite FeS <sub>2</sub>	–	615
organic compounds	free or linked organic matter	–	300–500

<sup>a</sup> Dehydration: loss of water adsorbed on outer or inner surfaces, with or without reversible change in the lattice depending on the types of clay, water organized in monomolecular film on surface oxygen atoms or around exchangeable cations.

<sup>b</sup> dehydroxylation (+ decarbonation and desulphurization reactions), loss of water linked to lattice (OH<sup>-</sup>), irreversible reaction or destruction of the structure, water present in the cavities, O forming the base of the tetrahedrons.

Loss on ignition is determined by gravimetry. It includes combined water linked to the crystal lattice plus a little residual non-structural adsorbed water, organic matter, possibly volatile soluble salts ( $F^-$ ,  $S^{2-}$ ) and carbonates ( $CO_3^{2-}$ ,  $CO_2$ ). The use of an oxidizing atmosphere is essential to ensure combustion of the organic matter and in particular oxidation of reduced forms of iron, this being accompanied by an increase in mass of the soils with minerals rich in  $Fe^{2+}$ . A complete analysis generally includes successive measurements of  $H_2O^-$  and  $H_2O^+$  on the same sample.

### 1.3.3 Equipment

- Platinum or Inconel (Ni–Cr–Fe) crucible with cover, diameter 46 mm.
- Analytical balances (id.  $H_2O^-$ )
- Desiccator (id.  $H_2O^-$ )
- Muffle electric furnace (range 100–1,100°C) with proportional electronic regulation allowing modulation of the impulses with oscillation of about 1°C around the point of instruction; built-in ventilation system for evacuation of smoke and vapour
- Thermal protective gloves
- 300 mm crucible tong

### 1.3.4 Procedure

- Tare a crucible, heat it to 1,000°C and cool it in the desiccator with its lid on:  $m_0$
- Introduce 2–3 g of air-dried soil crushed to 0.1 mm:  $m_1$
- Dry in the drying oven at 105°C for 4 h
- Cool in the desiccator and weigh:  $m_2$
- Adjust the lid of the crucible so it covers approximately 2/3 of the crucible and put it in the electric furnace
- Programme a heating gradient of approximately 6°C per minute with a 20-min stage at 300°C, then a fast rise at full power up to 1,000°C with a 4-h graduation step (the door of the furnace should only be closed after complete combustion of the organic matter)
- Cool the crucible in the desiccator and weigh:  $m_3$

### 1.3.5 Calculations

$$m_1 - m_0 = \text{weight of air-dried soil}$$

$$m_1 - m_2 = \text{moisture at 105°C}$$

$$\begin{aligned}
 m_2 - m_0 &= \text{weight of soil dried at } 105^\circ\text{C} \\
 m_2 - m_3 &= \text{loss on ignition} \\
 \text{H}_2\text{O}^- \% &= 100 \times \frac{m_1 - m_2}{m_1 - m_0} \quad \text{related to air-dried soil} \\
 \text{H}_2\text{O}^+ \% &= 100 \times \frac{m_2 - m_3}{m_2 - m_0} \quad \text{related to soil dried at } 105^\circ\text{C}
 \end{aligned}$$

### 1.3.6 Remarks

Knowing the moisture of the air-dried soil, it is possible to calculate the weight of air-dried soil required to work with a standard weight soil dried at  $105^\circ\text{C}$ , thus simplifying calculations during analyses of the samples.

To obtain the equivalent of 1 g of soil dried at  $105^\circ\text{C}$ , it is necessary to weigh:

$$\frac{100}{100 - wc} \text{ with } wc = \% \text{ water content of air dried soil.}$$

Platinum crucibles are very expensive and are somewhat volatile at  $1,000^\circ\text{C}$ , which means they have to be tared before each operation, particularly when operating in reducing conditions.

Combustion of organic matter with insufficient oxygen can lead to the formation of carbide of Pt, sulphides combine with Pt, chlorine attacks Pt, etc.

### Bibliography

- Campbell GS, Anderson RY (1998) Evaluation of simple transmission line oscillators for soil moisture measurement. *Comput. and Electron. Agric.*, 20, 31–44
- Chin Huat Lim, Jackson ML (1982) Dissolution for total elemental analysis. In *Methods of Soil Analysis, Part 2*, Page A.L., Miller R.H., Kenny D.R. ed. Am. Soc. Agronomy, pp. 1–11
- Dixon JB (1977) Minerals in soil environments. *Soil Sci. Soc. Am.*
- Dubois J, Paindavoine JM (1982) Humidité dans les solides, liquides et gaz. *Techniques de l'ingénieur.*, (P 3760)
- Gardner WH (1986) Water content. In *Methods of Soil Analysis, Part 1*, Klute ed. Am. Soc. Agronomy, Soil Sci. Soc. Am., pp. 493–544
- Henin S (1977) *Cours de physique du sol: l'eau et le sol tome II.*, Editest, Paris: 1–164
- Lane PNJ, Mackenzie DH, Nadler AD (2002) Note of clarification about: Field and laboratory calibration and test of TDR and capacitance techniques for indirect measurement of soil water content. *Aust. J. Soil Res.*, 40, 555–1386

- 
- Lane PNJ, Mackenzie DH (2001) Field and laboratory calibration and test of TDR and capacitance techniques for indirect measurement of soil. *Aust. J. Soil Res.*, 39, 1371–1386
- NF ISO 11465 (X31-102) (1994) Détermination de la teneur pondérale en matière sèche et en eau. In *Qualité des sols*, AFNOR, 1996, 517–524
- Rankin LK, Smajstrla AG (1997) Evaluation of the carbide method for soil moisture measurement in sandy soils. *Soil and Crop Science Society of Florida*, 56, pp. 136–139
- Skierucha W (2000) Accuracy of soil moisture measurement by TDR technique. *Int. Agrophys.*, 14, 417–426
- Slaughter DC, Pelletier MG, Upadhyaya SK (2001) Sensing soil moisture using NIR spectroscopy. *Appl. Eng. Agric.*, 17, 241–247
- Walker JP, Houser PR (2002) Evaluation of the Ohm Mapper instrument for soil moisture measurement. *Soil Sci. Soc. Am. J.*, 66, 728–734
- X31-505 (1992) Méthode de détermination du volume, apparent, et du contenu en eau des mottes. In *Qualité des sols*, AFNOR, 1996, 373–384
- Yu C, Warrick AW, Conklin MH (1999) Derived functions of time domain reflectometry for soil moisture measurement. *Water Resour. Res.*, 35, 1789–1796

## Particle Size Analysis

### 2.1 Introduction

#### 2.1.1 Particle Size in Soil Science

Determination of grain-size distribution of a sample of soil is an important analysis for various topics in pedology, agronomy, sedimentology, and other fields such as road geotechnics.

Soil texture has an extremely significant influence on the physical and mechanical behaviours of the soil, and on all the properties related to water content and the movement of water, (compactness, plasticity, thrust force, slaking, holding capacity, moisture at different potentials, permeability, capillary movements, etc.).

Particle size analysis of a sample of soil, sometimes called “mechanical analysis”, is a concept that has been the subject of much discussion (Hénin 1976). Soil is an organized medium including an assemblage of mineral and organic particles belonging to a continuous dimensional series. The first difficulty is to express the proportion of these different particles according to a standard classification, which is consequently somewhat artificial.

One classification scale was proposed by Atterberg (1912). Today this scale is recognized at different national and international levels and includes two main fractions: fine earth (clay, silts and sands with a grain diameter  $<2$  mm) and coarse elements (gravels, stones with a grain diameter  $>2$  mm). The particle size series (Fig. 2.1) for fine earth is generally expressed after analysis in three size fractions (clay fraction less than 0.002 mm, silt fraction from 0.002 to 0.02 mm, and sand fraction from 0.02 to 2 mm). In some countries, or for the purpose of a particular type of pedological interpretation, a more detailed scale of classes is sometimes used, for example five fractions: fine clays, silts, coarse silts or very fine sands, fine sands, and coarse sands (Fig. 2.1).



Fine earth										Coarse elements				NC	SC
0.1 $\mu$ m	1 $\mu$ m	2 $\mu$ m	10	20	50	100	200 $\mu$ m	500 $\mu$ m	1 mm	2 mm	20 mm	75 mm	250 mm		
	0.002		0.02		0.1		0.2	0.5							
FC	Coarse clays	FSi	Medium silts	FS	VFS	Fine sands	MS	Coarse sands	Very coarse sands	Gravels	Stones			10	CSSC
	0.002	0.02	0.05	0.10	0.20	0.50	1.00	2.00							
	Clays	Fine silts	FS (1)	FS (2)	CS (1)	Coarse sands (2)	Coarse sands (3)							8	France
	0.002	0.05	0.10	0.25	0.50	1.00	2.00								
	Clays	Silts	VFS	Fine sands	MS	Coarse sands	Very coarse sands	Gravels	Stones					7	USDA
	Clays	Fine silts	FS	Fine sands	Coarse sands	Gravels								5	AFNOR
	0.002	0.02	0.20	2.00											
	Clays (I)	Silts (II)	FS <sub>1</sub>	FS <sub>2</sub>	CS <sub>1</sub>	CS <sub>2</sub>	CS <sub>3</sub>	Gravels	ISSS					4	ISSS
	Fines (silts and clays)	Fine sands	Medium sands	Gravels	CG	Stones								3	ASTM
		200 $\mu$ m	35 $\mu$ m	10 $\mu$ m	1/2	3									
		75 $\mu$ m	500 $\mu$ m	2 mm											

**Fig. 2.1.** Ranges of particle size used for soils (NC number of classes; FSi fine silts, CSi coarse silts; FS, VFS, CS fine, very fine and coarse sands, respectively; FC fine clays; FG, CG fine gravels and coarse gravels), from top to bottom: (CSSC) Canadian Soil Survey Committee (1978): 10 particle size ranges < 2 mm; France (before 1987): 8 ranges; USDA United States Department of Agriculture (1975): 7 ranges; AFNOR Association Française de Normalisation (1987): 5 ranges; ISSS = International Soil Science Society (1966): 4 ranges; ASTM = American Society for Testing Materials (1985): 3 ranges

However, it should be noted that the terminology used does not provide much information about the real nature of the classes; thus clay defined as having a diameter equal to or less than 0.002 mm does not contain only clay corresponding to this mineralogical definition but can also contain sesquioxides, very fine silts, organic matter, carbonates, or compounds without colloidal properties. In the same way, sands, which generally result from fragmentation of the parent rock, can also include pseudo-sands, small ferruginous concretions, small limestone or cemented nodules that are resistant to dispersion treatments. The presence of these pseudo-sands can render the conclusions of particle size analysis illusory.

Another difficulty appears with the fractionation of elementary particles by dissociating them from their original assembly. Here too analytical standards exist, but it should be recognized that in certain cases the rupture of all the forces of cohesion is not complete (the case in hardened cemented soils), or on the contrary the forces are too energetic.

Lastly, particle size analysis accounts for the size but not for the shape of the particles, or their nature. If necessary, these are the subject of

specific morphoscopic and mineralogical analyses. The result of particle size analysis is expressed in classes of which the relative proportions can be summed up in the form of a triangular diagram enabling the texture of a sample, a horizon, or a soil to be defined. Depending on the school, there are several different types of triangles that represent textures: GEPPA (*Groupe d'Etude des Problèmes de Pédologie Appliquée*, AFES, Grignon, France) includes 17 textural classes; the USDA's (United States Department of Agriculture) includes 12 classes (Gras 1988); others are simplified to a greater or lesser extent depending on the pedological or agronomic purpose of the study. Starting from these results, different interpretations are usually made in terms of pedogenesis (comparison of the vertical sand percents to check the homogeneity of a given material in a given soil profile, calculation of different indices of leaching, clay transport, etc.); others are more practical (definition of the relation of texture to hydric characteristics for the initial calculation of the amounts and frequencies of irrigation, or for the choice of machinery for cultivation).

### 2.1.2 Principle

Particle size analysis is a laboratory process, which initially causes dissociation of the material into elementary particles; this implies the destruction of the aggregates by eliminating the action of cements. But this action should not be too violent to avoid the creation of particles that would not naturally exist; the procedure of dispersion must thus be sufficiently effective to break down the aggregates into individual components, but not strong enough to create neo-particles.

Measurements (Table 2.1, Fig. 2.2) then will link the size of the particles to physical characteristics of the suspension of soil after dispersion (cf. Sect. 2.1.3). These measurements may be distorted by the presence of some compounds in the soil: organic matter, soluble salts, sesquioxides, carbonates, or gypsum. The latter compound can be particularly awkward because it can result in two opposing actions (Vieillefon 1979): flocculation due to soluble calcium ions (relative reduction in clay content), and low density of gypsum compared to other minerals (increase in clay content). Particle size analysis thus generally starts with a pre-treatment of the sample that varies with the type of soil; the characteristics of different soils are given in Table 2.3.

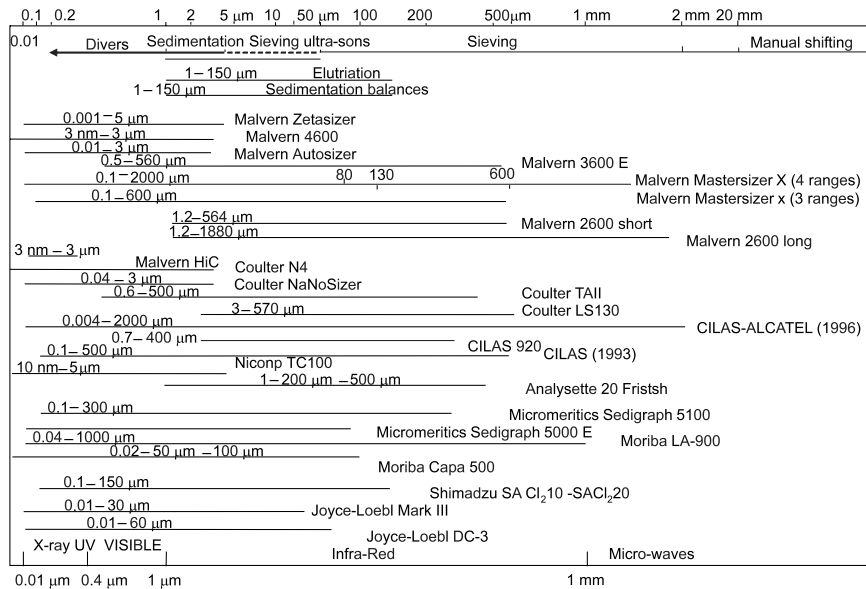

Fig. 2.2. Particle size ranges of some automated particle-measurement instruments

### 2.1.3 Law of Sedimentation

After possible pretreatment (cf. Sect. 2.2.1), the sample is suspended in aqueous medium in the presence of a dispersant (cf. Sect. 2.2.2). During sedimentation, the particles are then subjected to two essential forces: a force of gravity that attracts them to the bottom, and a force of viscous resistance of the medium in the opposite direction to their displacement. By comparing the particles to spheres of radius  $r$ , the force of gravity  $F_g$  (dynes) is expressed by:

$$F_g = \frac{4}{3} \pi r^3 (\rho_s - \rho_f) g$$

$r$  = equivalent radius of the spherical particle in cm;

$g$  = gravity constant,  $981 \text{ cm s}^{-2}$ ;

$\rho_s$  = density of the particles in  $\text{g cm}^{-3}$  (between 2.4 and 2.8 for soils);

$\rho_f$  = density of the liquid of dispersion in  $\text{g cm}^{-3}$ ;

The force of resistance of the medium  $F_r$  (dynes) is expressed by:

$$F_r = 6 \pi r \eta V,$$

$V$  = falling speed in  $\text{cm s}^{-1}$ ;

$\eta$  = viscosity of the medium in Poises ( $\text{g cm}^{-1} \text{s}^{-1}$ ), at temperature  $\theta^\circ\text{C}$  (Table 2.2).

When the particles reach equilibrium, the forces  $F_r$  and  $F_t$  are equal, from which their drop speed can be estimated according to the law originally established by Stokes (1851):

$$V = \frac{2 (\rho_s - \rho_f) g r^2}{9 \eta}. \quad (2.1)$$

For calculations, the average density of the solid particles in dispersions of soils is often selected with  $\rho_s = 2.65$  or  $2.60 \text{ g cm}^{-3}$ . Empirical relationships have been established for the calculation of  $\rho_f$  and  $\eta$  in aqueous solutions of hexametaphosphate generally used for particle-size distribution of soils (Gee and Bauder 1986):

$$\rho_t = \rho_0 (1 + 0.630 C_{\text{HMP}}), \quad (2.2)$$

$$\eta = \eta_0 (1 + 4.25 C_{\text{HMP}}), \quad (2.2')$$

$\rho_0$  = density of water ( $\text{g cm}^{-3}$  at the working temperature (Table 2.2);

$\eta_0$  = viscosity of water (poise) at the working temperature (Table 2.2);

$C_{\text{HMP}}$  = hexametaphosphate concentration in  $\text{g cm}^{-3}$ .

The constant of Stokes for the medium can thus be defined by:

$$C = 2 (\rho_s - \rho_f) g / 9 \eta.$$

Equation (2.1) shows that the falling speed is proportional to the square of the particle radius and remains constant throughout sedimentation if certain conditions are strictly respected (cf. Sect. 2.1.4). The speed can also be defined by  $V = h/t$  where  $T$  is the time (s) spent by the particle of radius  $r(\text{cm})$  to fall a height  $H(\text{cm})$ . Either the depth of its sedimentation over a given period, or the time needed for sedimentation to a given depth is determined by:

$$t = \frac{9 h \eta}{2 (\rho_s - \rho_f) g r^2} = h C^{-1} r^{-2}. \quad (2.3)$$

**Table 2.1.** Systems of particulate characterization for particle size distribution of soils

individualization of particles	<ul style="list-style-type: none"> <li>- destruction of organic matter (H<sub>2</sub>O<sub>2</sub>, Na hypochlorite), hypobromite... acid or basic media</li> <li>- destruction of cements (Al, Fe, Si):               <ul style="list-style-type: none"> <li>-</li> <li>- reducer or complexing media</li> </ul> </li> <li>- in water               <ul style="list-style-type: none"> <li>desaturation (elimination cations<sup>2+</sup>)</li> <li>acid medium (some andosols)</li> </ul> </li> </ul>									
suspension (dispersion)	<ul style="list-style-type: none"> <li>- preliminary treatments               <ul style="list-style-type: none"> <li>chemical                   <ul style="list-style-type: none"> <li>choice of pH</li> <li>various surfactants</li> <li>ultrasounds</li> </ul> </li> <li>physical                   <ul style="list-style-type: none"> <li>mechanical agitation (disintegration: 40 reversals/min)</li> <li>limiting concentrations</li> </ul> </li> </ul> </li> <li>- choice of concentration               <ul style="list-style-type: none"> <li>wall-attachment effects</li> </ul> </li> </ul>									
	separation – techniques used – measurements	size range	phase recovery	principle	advantages	drawbacks	1990 firms			
measurement of particles	1. sieving	dry	2 mm	separation on sieve with vibration with or without ultrasonic waves	simple	fragility of sieves, mesh defects, mesh obtrusions, etc.	Saulas Tamisor, etc			
	2. surface measurement (for memorandum)	wet	0.050 (5 μm)	weighing of the fractions (discontinuous) measurement of weight of a molecular film (nitrogen, EGME...) retained at the surface of the particles (preliminary separation of phases)	internal and external surface	when dry, fine powders stick to coarse ones		difficult to measure	micromeritics	

<p>density soils = 2.65</p> <p>dry 3. elutriation wet</p>	<p>1 – 150 <math>\mu\text{m}</math>      yes</p> <p>separation measurement inverse of sedimentation: breakdown of gravity force by a gaseous or liquid flow Per Ascensum (discontinuous)</p> <p>very slow used for sediment studies</p>	<p>Mettler, Becker, Cahn, Sartorius, Prolabo</p>
<p>dry or wet samples</p>	<p>radioactivity (for memorandum)</p> <p>by fluctuation of conductivity (or photometrics)</p> <p>4. counting by microscopic measurement: optical, MEB, MET ... and image analysis</p> <p>no</p> <p>no</p> <p>0.5 – 500 <math>\mu\text{m}</math>      no</p> <p>for labelled elements</p> <p>calibrated hole, distribution of given particles by proportional changes in displaced electrolyte or proportional extinction</p> <p>counting on image analyzer or manual counting</p> <p>elimination of density effect</p> <p>shape, <i>habitus</i></p> <p>equipment is expensive</p>	<p>Coulter Quantimat 720 Micro-Videomat (Zeiss) Integramat (Leitz)</p> <p>very slow analysis</p>
<p>sedimentation balances</p>	<p>1 – 150 <math>\mu\text{m}</math>      no</p> <p>gravimetric determination by cumulating vs. time</p>	<p>Mettler, Becker, Cahn, Sartorius, Prolabo</p>

separation techniques used – measurement	size range	phase recovery	principle	advantages	drawbacks	1990 firms
<p>pipette methods (Robinson, Andreasen) reference method AFNOR standardization</p> <p>simple gravity photo-sedimentation (turbidimetry) diffusion diffraction laser.</p>	1 – 150 $\mu\text{m}$	yes	volumetric sampling of fine particles, sieving for silts and sands	sedimentation at fixed level vs. time. Critical concentration per unit of volume		
			optical method: absorption, diffusion or dispersion of light (white or monochromatic light or laser)	laser: high intensity lighting of small volume low concentration	influence of shape of colour of particles on extinction coefficient, influence of wavelength diffraction effect for small particles	Stanton Maivern... Cilas
5. sedimentation						
X-ray soft $\gamma$ attenuation neutron scattering	0.1 – 100 $\mu\text{m}$	no	measurement by electromagnetic radiation – X-ray or $\gamma$	good detection	concentration higher than photometry	Micromeritics 5100...
density variable depth	1 – 50 $\mu\text{m}$		bouyoucos: measurement of densimeter depth	densimeter (Casagrande, ASTM...)	influence of density, temperature, viscosity, verticality of cylinders	

only one

method cannot be used for

	<p>hydrometer constant depth</p> <p>continuous centrifugation</p> <p>5: centrifugation</p> <p>discontinuous centrifugation</p> <p>Stokes law: speed of solid fractionation: one static liquid phase – one solid mobile phase, no deformation, no reaction with liquid phase, homogeneously dispersed. Effect of temperature (viscosity, convection flows), effect of density, particle diameter. Repulsive electrostatic effect of particles</p> <p>6) M Brownian movement Zeta potential</p>	<p>De Leenher: densimeter with chain</p> <p>increase in gravity force by centrifugation force. Change of concentration at a given depth, photo detection</p> <p>0.02 – 500 <math>\mu\text{m}</math></p> <p>No</p> <p>– weighing of cumulated deposits or measurement of height of deposits – possible approximate separation of phases – pipette centrifuge analyser</p> <p>the frequency of displacements is inversely proportional to particle size</p>	<p>surface evaporation</p> <p>Shimadzu 500 Capa Horiba 300 Horiba 700 Horiba Beckman</p> <p>Sharples Simcar ...</p> <p>mobility of particles, effective surface charge</p> <p>fine particles only Malvern</p>
<p>all classes of particles</p>			



Particle size analysis by sedimentation consists in determining the content of particles below or equal to a given threshold. Known volumes of solution (pipette method) are generally used for the depth and time of sedimentation chosen as the threshold for a cut point. After drying the pipette sample, weighing and correcting the volume, the content of particles that are smaller than the selected threshold can be determined. In the example in Table 2.2, a pipette sample at a temperature of 20°C, a depth of 10 cm and 8 h 08 min of sedimentation will give the content of the clay fraction (diameter of particle < 2 μm).

In the densimetry method, the relation between the size of the particles (radius  $r$ ) and the time of sedimentation  $t$  can be expressed by:

$$r = S t^{-1/2}, \quad (2.4)$$

where  $S$  is the parameter of sedimentation. Taking into account (2.3), it can be expressed by:

$$S = C^{-1/2} H_r^{1/2}, \quad (2.4')$$

where  $H_r$  is the depth of balance of the densimeter (hydrometer) which represents the effective measurement depth of the particles of radius  $r$ .

#### 2.1.4 Conditions for Application of Stokes Law

The formula of Stokes is theoretically only valid for particles with a diameter of less than 0.1 mm, but according to Mériaux (1954), it can be used up to 0.2 mm or even 0.05 mm. Above this value, it is advisable to apply the formula of Oseen; however, particles more than 0.1 mm in diameter can be more precisely sorted by sieving.

For particle size analysis, sedimentation cylinders are used whose walls slow down the falling speed of the particles by friction. Thus, for 0.05 mm quartz spheres, the falling speed at a distance of 0.1 mm from the walls is reduced by 12%, and disturbance becomes negligible at 1 mm (0.28%). In practice, it may be advantageous to use sedimentation tubes (cylinders) with a rather large diameter, at least 5 cm.

In addition, the constant of Stokes is established for minerals with an average density of 2.60 or 2.65, whereas soil materials can contain illite with a density of 2.1 – 2.7, montmorillonite with a density of 1.7 – 2.6 and so on. But the main difficulty is the fact that the particles are neither spherical, nor smooth, which obliges the analyst to introduce the concept of equivalent radius.

**Table 2.2.** Densities  $\rho$  and viscosities  $\eta$  of water and 5% hexametaphosphate solutions related to temperature  $\theta$  ( $^{\circ}\text{C}$ ); corresponding to Stoke C constants and falling time  $t$  at 10 cm depth for clay particles  $\geq 2 \mu\text{m}$  ( $\rho_s = 2.60 \text{ g cm}^{-3}$ ) in hexametaphosphate solution

$\theta$	$\rho$ water	$\eta$ water	$\rho$ corrected	$\eta$ corrected	C	C	$t$ (2.3)
( $^{\circ}\text{C}$ )	( $\text{g cm}^{-3}$ )	Poise	(2.2; $C_{\text{HMP}} = 0.05$ $\text{g cm}^{-3}$ )	(2.2'; $C_{\text{HMP}} = 0.05$ $\text{g cm}^{-3}$ )	(eau)	( $C_{\text{HMP}} =$ 0.05 $\text{g cm}^{-3}$ )	for $h = 10 \text{ cm}$ $r = 0.0001$ $\text{cm}$ $C_{\text{HMP}} =$ 0.05
		( $\text{g cm}^{-1} \text{ s}^{-1}$ )	( $\text{g cm}^{-3}$ )	( $\text{g cm}^{-1} \text{ s}^{-1}$ )	( $\text{cm}^{-1} \text{ s}^{-1}$ )	( $\text{cm}^{-1} \text{ s}^{-1}$ )	
15	0.999126	0.01139	1.030598	0.01381	30640	30038	9 h 15 min
16	0.99897	0.01109	1.030438	0.01345	31472	30853	9 h 00 min
17	0.998802	0.01081	1.030264	0.01311	32290	31656	8 h 46 min
18	0.998623	0.01053	1.030080	0.01277	33153	32502	8 h 33 min
19	0.998433	0.01027	1.029884	0.01245	33996	33329	8 h 20 min
20	0.998232	0.01002	1.029676	0.01215	34849	34165	8 h 08 min
21	0.998021	0.009779	1.029459	0.01186	35712	35012	7 h 56 min
22	0.997799	0.009548	1.029230	0.01158	36581	35864	7 h 45 min
23	0.997567	0.009325	1.028990	0.01131	37462	36727	7 h 34 min
24	0.997325	0.009111	1.028741	0.01105	38347	37596	7 h 23 min
25	0.997074	0.008904	1.28482	0.01080	39245	38476	7 h 13 min

Particle size analysis is concerned with sedimentation of particles of different sizes. Some particles sediment more quickly than others and this results in variations in viscosity during the course of the experiment and also variations in the density of the fluid. Thus, in order to not diverge too much from the theoretical conditions established for mono-dispersed systems, a too significant concentration of the soil sample should be avoided (never higher than 1%).

The graph of the sedimentation of a heterogeneous sample corresponds to a poly-dispersed system. This construction (Fig. 2.3) makes it possible to evaluate the percentage of particles with a diameter larger than a value "A" corresponding to a sedimentation time ' $t_x$ '.

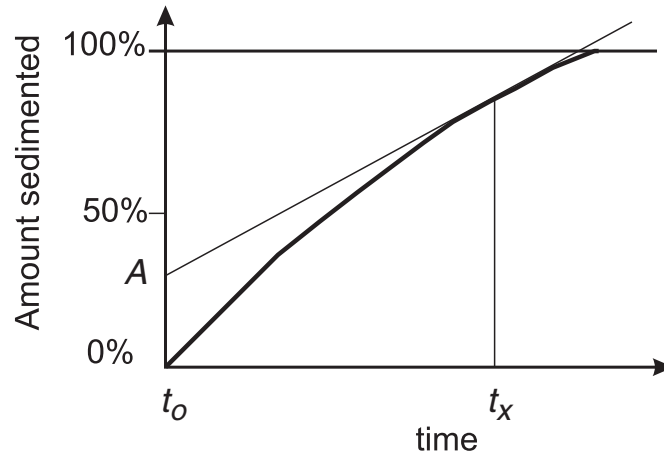

**Fig. 2.3.** Curve of sedimentation of a complex sample (poly-dispersed system);  $t_x$  is time representing the value of the sum of particles X. The intersection of the tangent at point X of the curve with the y-coordinate gives in A the quantity of particles larger than X

## 2.2. Standard Methods

### 2.2.1 Pretreatment of the Sample

#### *Adaptation to Soil Type*

The sample is dried at room temperature, sieved to 2 mm and carefully partitioned with a manual riffle sampler (Pansu et al. 2001). The weight of the test sample is 10 g; this quantity can be increased to 20 g for soils which are not very rich in clays. The treatments below are defined with respect to the different cases (A – H) listed in Table 2.3.

**Carbonated Soils (B)****Reagents**HCl 1 mol L<sup>-1</sup>**Table 2.3.** Characteristic of soils subjected to analysis and preliminary treatments

organo-mineral complex	characterization	treatment
A: complex more or less saturated	few drops of concentrated HCl do not cause any release of CO <sub>2</sub> , pH H <sub>2</sub> O < 7	treatment with H <sub>2</sub> O <sub>2</sub> at 1%, then 30%
B: presence of carbonates	HCl causes release of CO <sub>2</sub> pH H <sub>2</sub> O > 7	perform two analyses: one without carbonate destruction, and one with destruction
C: rich in organic matter	OM content > 15% dried <2mm thin earth	suitable treatment with H <sub>2</sub> O <sub>2</sub>
D: rich in organo-mineral cements and amorphous or individualised sesquioxides	(SiO <sub>2</sub> + Al <sub>2</sub> O <sub>3</sub> ) > 10% of thin earth – ferrallitic, ferruginous tropical soils	– dissolution of mineral cements with HCl and organic cements with H <sub>2</sub> O <sub>2</sub> – treatment with Tamm reagent
E: rich in sodic salts, no gypsum	conductivity 1/5 > 0.3 mS cm <sup>-1</sup> ; to 5 mL of aqueous extract, add 5 mL acetone – no precipitate	elimination of salts by washing and decantation–filtration
F: presence of MnO <sub>2</sub>	strong reaction with H <sub>2</sub> O <sub>2</sub> ; violet colour of permanganate after oxidation	pretreatment with bisulphite before destruction of organic matter
G: presence of gypsum ≤ 10%	positive reaction to acetone test	elimination of gypsum by washing before agitation
H: presence of gypsum > 10%	estimation of gypsum by heating to 60°, then to 105°C (cf. Sect. 2.2.4)	results difficult to interpret. Special techniques should be used

### *Procedure*

The analytical standard X 31-107 (1983) recommends carrying out this treatment after destruction of organic matter with hydrogen peroxide ( $\text{H}_2\text{O}_2$ ). However, oxidation of the organic matter can temporarily produce oxalic acid which results in the neo-formation of calcium oxalate. It is thus preferable to eliminate the limestone at the pretreatment stage.

- Put the sample (equivalent to 10 g soil dried at  $105^\circ\text{C}$  for example) weighed at  $\pm 1$  mg in a low form 1,000 mL Pyrex beaker.
- Add 100 mL water.
- Agitate and with a burette slowly add the diluted hydrochloric acid ( $1 \text{ mol L}^{-1}$ ) until complete destruction of the limestone present.
- The pH should not go below 3.0.

When all carbon dioxide is eliminated, boil gently for 5 min. Wash by decantation to eliminate calcium and excess acid (chloride test).

### *Remarks*

- Avoid adding too much hydrochloric acid which can destroy the chlorites in certain trioctahedric chlorites.
- Sodium acetate at pH 5 can be used to avoid attacking the lattice of certain clays.
- In the presence of limestone particles involved in the grain-size distribution of the soil, an additional measurement will be required without destroying the  $\text{CaCO}_3$  (Baize 2000).

### ***Destruction of Organic Matter***

Organic matter has a high aggregation capacity. It should thus be destroyed in the majority of soils (A – F in Table 2.3). Generally hydrogen peroxide at 30% (110 volumes) is used or stabilized hydrogen peroxide (Perhydrol or similar) in tropical climates. Some authors propose sodium hypochlorite or bromine in an alkaline medium ( $2 \text{ mol (KOH) L}^{-1}$  solution).

### *Reagents*

- Pure hydrogen peroxide (30% – 110 volumes)
- Ammonia (20%,  $d = 0.92$ )
- Dispersant, 5% sodium hexametaphosphate solution
- Sodium bisulphite  $\text{NaHSO}_3$

### ***Case of Soils with Less Than 15% of Organic C***

Place the test specimen in a 1,000 mL Pyrex beaker. Add 100 mL of 1% hydrogen peroxide. Leave in contact in the cold for one hour avoiding

excess foaming by agitating, or by using an aerosol to modify the surface charges (alcohol, etc.).

Heat to 60°C and add a little 30% hydrogen peroxide to start the attack again. Add H<sub>2</sub>O<sub>2</sub> in small fractions until effervescence stops and there is discolouration of the supernatant. Bring to controlled boiling to destroy surplus H<sub>2</sub>O<sub>2</sub> and to reduce the volume without bringing to dry.

#### *Case of Soils Very Rich in Organic Matter (Histosols, Andosols, etc.)*

It is important to work on soils preserved in their natural moisture to avoid irreversible changes due to drying as these soils become hydrophobic. A sample equivalent to soil dried at 105°C should be used. The attack must be very gentle at the beginning because as soon as the oxidation reaction starts, it becomes violent; there is a sudden rise in temperature and a risk of overflow of foam.

When sampling wet soil, add distilled water to form slurry. Add 50 mL hydrogen peroxide diluted to 1% and leave in contact in the cold.

Heat each beaker to 60°C to start the reaction. If necessary, adjust the temperature by adding an ice cube made of deionized water.

Add small fractions of hydrogen peroxide until there is no more foam, then bring to the boil. The liquid supernatant should be clear. Wash by decantation and continue the analysis.

#### *Remarks*

In certain cases, the organic matter may be “protected” by homogeneous mixture with carbonates and hydrogen peroxide then cannot act. If preliminary destruction of the carbonates (cf. “Carbonated Soils”) is not sufficient, the organic matter should be attacked with hypobromite: 3 mL of bromine in 100 mL of frozen 2 mol (KOH) L<sup>-1</sup> solution.

Mix 50 mL of this mixture with the sample and wait 1 h; boil for 30 min, let cool, add 200 mL distilled water; leave overnight, transfer on a filter and wash (three washings are sufficient) before dispersion.

#### *Presence of MnO<sub>2</sub> (F)*

The presence of manganese salts can cause the rapid destruction of hydrogen peroxide. In this case the treatments should be renewed and the colour of the supernatant liquid monitored. Free manganese dioxide is soluble in hydrogen peroxide (Jackson 1969).

Since manganese dioxide causes violent breaking up of hydrogen peroxide, it should first be reduced with sodium bisulphite (Pétard, 1993). Before adding hydrogen peroxide, add 1 g of sodium bisulphite or 10 mL of an aqueous bisulfite solution at 37.5% to the sample. Add 50 mL

deionized water and boil for 20 min to reduce the manganese dioxide in  $\text{Mn}^{2+}$  ion. Then initiate the attack with hydrogen peroxide as described above.

### ***Presence of Amorphous Organo-Mineral Cements (D)***

#### ***Reagents***

- Tamm (1922) buffer: 10.92 g of oxalic acid + 16.11 g of ammonium oxalate for 1,000 mL; adjust to pH 3;
- Hydrochloric acid 2 mol  $\text{L}^{-1}$  solution: dissolve 166 mL concentrated HCl ( $d = 1.18$ ) in 800 mL water, agitate, cool and complete to 1 L.

#### ***Procedure with Tamm Reagent***

Add 800 mL of Tamm reagent to a sample weighing 20 g; agitate cold, store in the dark for 4 h, centrifuge, and then filter.

#### ***Procedure with HCl/H<sub>2</sub>O<sub>2</sub> Reagent***

Treat with 300 mL 2 mol (HCl)  $\text{L}^{-1}$  solution in a sand bath for 1 h at 60°C. Elutriate and wash with deionized water. The acid solution and washing water should be collected and dried at 105°C. Weighing gives the mass  $M_m$  of the soluble mineral fraction. If  $m$  represents the initial test specimen of soil, the mineral soluble fraction  $F_m$  expressed as a percentage is calculated by  $F_m = 100 M_m/m$ . This value should be taken into account for the calculation of the balance of particle size fractionation.

After dissolving mineral cements, organic cements should be dissolved as described in above “Destruction of Organic Matter”.

### ***Presence of Gypsum (G and H)***

#### ***Procedure for Rough Estimate of Gypsum***

Put a test specimen of 10 g of soil sieved to 2 mm in an aluminium capsule. Place in a ventilated drying oven at 60°C for 24 h to eliminate the water of hydration. Cool in the desiccator and weigh =  $P_1$ ; place in a ventilated drying oven regulated at 105°C (for minimum 3 h) to eliminate the water of constitution; cool in the desiccator and weigh =  $P_2$ .

Approximate percentage gypsum =  $100 \frac{P_1 - P_2}{10} \times \frac{172}{36} \approx 50(P_1 - P_2)$ .

***Procedure in Case of Gypsum  $\leq 10\%$  (case G)***

At 25°C, gypsum is water soluble at a rate of 2 g L<sup>-1</sup>. After destruction of organic matter (cf. “Destruction of Organic Matter”) and after destruction or not of limestone (cf. “Carbonated Soils”), put the sample (10 g) in a 500 mL beaker with 300 mL distilled water on a magnetic stirrer with agitation. After 1 h, allow it to settle and elutriate the clear part, again add 300 mL distilled water and repeat the operation (usually once again) until the acetone test is negative.

For this test (cf. Chap. 30), use 5 mL aqueous extract, add 5 mL acetone, mix well; in the absence of gypsum, no precipitate will be formed.

***Procedure in Case of Gypsum  $> 10\%$  (case H)***

Determination of the exact particle size is difficult and it is advisable to adapt a specific method, for example, that of Vieillefon (1979). Complete dissolution of the gypsum enables the elementary composition of the non-gypseous part of the soil to be determined, but not of the total soil. Instrumental methods are more precise because only a short measurement time is required. Combined with desaturation using ion exchange resins, these methods make it possible to obtain satisfactory results before flocculation occurs.

**2.2.2 Particle Suspension and Dispersion*****Introduction***

Ions that can flocculate clay particles are ranked in descending order:

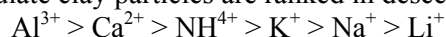

The replacement of the natural compensation cations with high flocculating capacity is thus necessary to enable dispersion of the soil, i.e. the maintenance of the elementary particles in suspension. The stability of the suspensions is only obtained thanks to interactions between the diffuse layers of the same sign as clays and with control of the forces of attraction of van der Waals.

Coulomb repulsion depends on the concentration of electrolytes and the valence of the ions. If the forces of van der Waals are higher than the force of Coulomb repulsion, the potential energy of the resulting interaction leads to flocculation. The aim is to chemically modify the distribution of charges and pH.

For example, inversion of the edge charges can eliminate edge lattice attractions and produce negative particles with a weak attraction potential. For example hexametaphosphate is fixed by chemisorption on



the octahedral cations present on the side faces of crystallites resulting in good dispersion. This dispersant is most often used when analyses are not required on the fractions after measurement of particle size.

The pH should preferably be fixed at a value which is far from the zone of the isoelectric point (cf. Chap. 20) at which flocculation occurs. Generally it should be basic (approximately 10). A too high pH can induce solubilization phenomena.

For oxides like  $\text{Fe}(\text{OH})_3$ , which can exist in a dispersed state with a positive or negative charge, adjustment of the pH to allow dispersion is a function of the isoelectric point. For Andisols, the pH for dispersion will often be acid (around pH 3.5) and always far from the isoelectric point.

These treatments do not avoid lattice associations which are observed in kaolinites with a low negative charge or in micas (illites, muscovite, etc.). In this case it is necessary to use ultrasound for an additional mechanical effect.<sup>1</sup> The optimal amount of dispersant will depend on the effectiveness of the pre-treatments. Optimal effectiveness is obtained with an amount of sodium hexametaphosphate of between 20 and 50 times the CEC. An excess of this reagent should be avoided as it causes flocculation while being adsorbed on colloids. For this reason, and when the fractions are needed for later analysis, it is better to use ion-exchange resins in  $\text{Na}^+$  form as dispersants, e.g. Amberlite IR 120 Na (Rouiller et al. 1972). These have the advantage of not causing any additional ionic charge of the medium, which is very favourable in the case of horizons with low clay content where a saline medium adds significant weight to the clay content.

Among the dispersants that can be used are ammonia, soda, sodium carbonate, and sodium pyrophosphate. All these agents avoid compression of the double layer of crystallites and avoid raising the Zeta

---

<sup>1</sup> Ultrasounds: (see complementary bibliography for effects on soils). Ultrasonic vibrations are generated by magnetostrictive oscillators. When a bar of a ferromagnetic material is subjected to a magnetic field, it changes length by magnetostriction. When this alternative field is applied in the axis of the bar, this causes an oscillation that is double of the applied field frequency. This vibration is transmitted to the suspended particles by the aqueous medium. The effect of cavitation with a frequency from 20 to 30 kHz makes it possible to break the forces of cohesion of the aggregates without causing significant damage to the elementary particles, as long as the application time is short. The treatment causes a rise in temperature which should be controlled. The apparatus are built so as to avoid the zones of resonance waves which are most destructive. Two types of apparatus are used, either with tanks or with probes with mechanical agitation by blades. Agitation with a bar magnet is not used except to recover magnetic particles if required.

potential, thus maintaining inter-particle forces of repulsion. It should be noted that at a rate of 17 mL per litre, ammonia does not cause an overload for weighing, and that soda dissolves the organic matter and precipitates iron, whereas pyro- and hexametaphosphate maintain it in solution. Aluminium is put in solution in the form of aluminates with soda, but not with ammonia. The responses are thus always slightly different.

As the mixed hexametaphosphate–ammonia dispersant has one component with a higher density than water and one component with a lower density, the resulting density is close to that of water.

### **Equipment and Reagents**

- *Sedimentation cylinders.* graduated 1,000 mL cylinders with ground stoppers (45/40 mm), 400 mm in length and 60 mm in diameter are generally used, but equivalent results can be obtained using transparent PVC tubes with an internal diameter of 71 mm and a length of 30 cm, with a filling mark at 1,000 mL, a square base, and stopped with a rubber stopper for agitation.
- *Dispersing solution.* 15% sodium hexametaphosphate solution (calgon,  $(\text{NaPO}_3)_6$ ) in deionized water.
- 20% ammonia ( $d = 0.92$ ) solution.
- Ion exchange resin (Amberlite IR120 Na or similar).

### **Procedure**

#### ***Treatment Using the Mixed Dispersant Hexametaphosphate – Ammonia***

After subjecting the soil sample to suitable pretreatments, quantitatively place it on an unfolded analytical filter and wash it with deionized water until dispersion begins. Pierce the filter and with jets of water from a washing bottle direct the soil into a cylinder (Fig. 2.4). Add 10 mL of 15% sodium hexametaphosphate solution and 5 mL of 20% ammonia solution. Supplement with approximately 500 mL water, close and place on the rotary agitator for 2 h (4 h for clay soils). In the case of soils of andosol–histosol type, first carry out ultrasonic treatment for 15 min).

After agitation, the sample should be well dispersed and its elementary particles (sands, silts, clays) quite separate from each other. After a few minutes, check there is no flocculation. Bring the volume to 1,000 mL with deionized water and homogenize.

### *Treatment Using Na Form IR 120 Resin*

Before treatment, the resin should be removed from particles smaller than 200  $\mu\text{m}$  by sieving.

Place samples that have been subjected to suitable pretreatment quantitatively on a filter and wash with deionized water until dispersion begins. Pierce the filter and place the soil on a 200- $\mu\text{m}$  mesh sieve in a funnel on a sedimentation cylinder to recover coarse sands. Wash, dry, and filter the recovered sands (cf. "Washing and Measuring Fine and Coarse Sands").

Place the fine particles in the cylinder. Add 50 mL wet Na form resin, then approximately 500 mL deionized water and agitate with the rotary agitator for 4 h (5 h for soils containing < 10% gypsum).

After agitation, recover the resin on a 200  $\mu\text{m}$  mesh sieve placed in a funnel in a 1,000 mL sedimentation cylinder, then wash separately and recover the washing water (the resin can be regenerated for another operation).

The sample can also be brought to 1,000 mL directly with deionized water for sampling of the fine particles, which can be needed for later analyses. It is also possible to add 10 mL of 15% sodium hexametaphosphate solution and 5 mL 20% ammonia, as in the procedure described in "Treatment Using the Mixed dispersant Hexametaphosphate – Ammonia", the densities and viscosities are then similar.

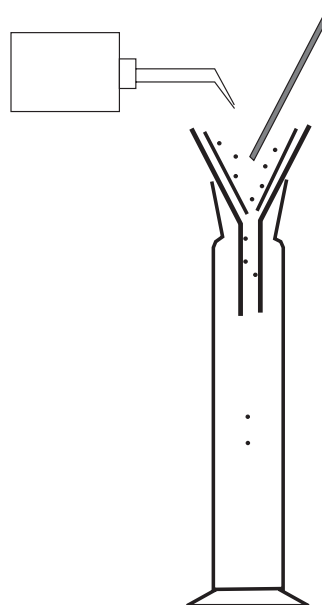

**Fig.2.4.** Transfer in sedimentation cylinders for dispersion after pretreatment, filtration and washing

### 2.2.3 Pipette Method after Robinson-Köhn or Andreasen

#### **Principle**

The pipette method is based on sedimentation of the particles by gravity according to the law of Stokes (2.1). Recovery of the aliquot at a given depth and a given time makes it possible to identify a specific class of particles when all the particles bigger than the selected diameter have been eliminated.

#### **Equipment**

- Sand bath.
- Robinson pipette on moveable frame with toothed rack (Fig. 2.5), aspiration by micropump with flow regulated at  $60 \text{ mL min}^{-1}$ . The pipette should have undergone preliminary treatment to make it non-wetable (cf. “Hydrophobic Treatment of a Sampling Pipette”).
- Fine aluminium capsules with a capacity of 30–40 mL.
- Drying oven with ventilation, regulated at  $105^\circ\text{C}$ .
- Thermometer.
- Balances, range: 120 g, sensitivity: 0.1 mg.
- Sets of two sieves with 0.2 and 0.05 mm mesh, with a vibrating sieving machine.
- Rotary agitator able to receive 10 or 20 cylinders, (30 rpm).
- Standard tributylchlorosilane.
- Standard 1-chloronaphtalene.

#### **Preparation of Pipette**

##### *Hydrophobic Treatment of a Sampling Pipette*

This treatment (Walker method) makes the walls of the pipette non-wetable and eliminates the need for rinsing between sampling.

Prepare the smallest possible quantity of 4% solution of tributylchlorosilane in chloronaphtalene. Clean, carefully degrease the pipette, dry it well then treat the inside of the pipette by aspiration; drain, leave to dry for a minimum of 24 h at room temperature.

##### *Calibration of the Pipette – Overload Reagent*

This calibration should be done periodically. The same dispersing liquid used for the analyses is used again but the temperature should be checked as it influences viscosity. Put five fractions of 20 mL in tarred capsules, then weigh ( $\pm 1/10 \text{ mg}$ ). The average weight corresponds to the volume

removed. Dry for 5 h at maximum 105°C, weigh the capsules ( $\pm 1/10$  mg) to determine overload due to the reagent.

### Procedure

All operations should be carried out at 20°C in an air-conditioned room, and equipment and reagents should be kept at the same temperature.

### Control of Dispersion

After agitation, lay the sedimentation cylinders out in line on the lab table, and open, taking care to include any deposits on the stopper.

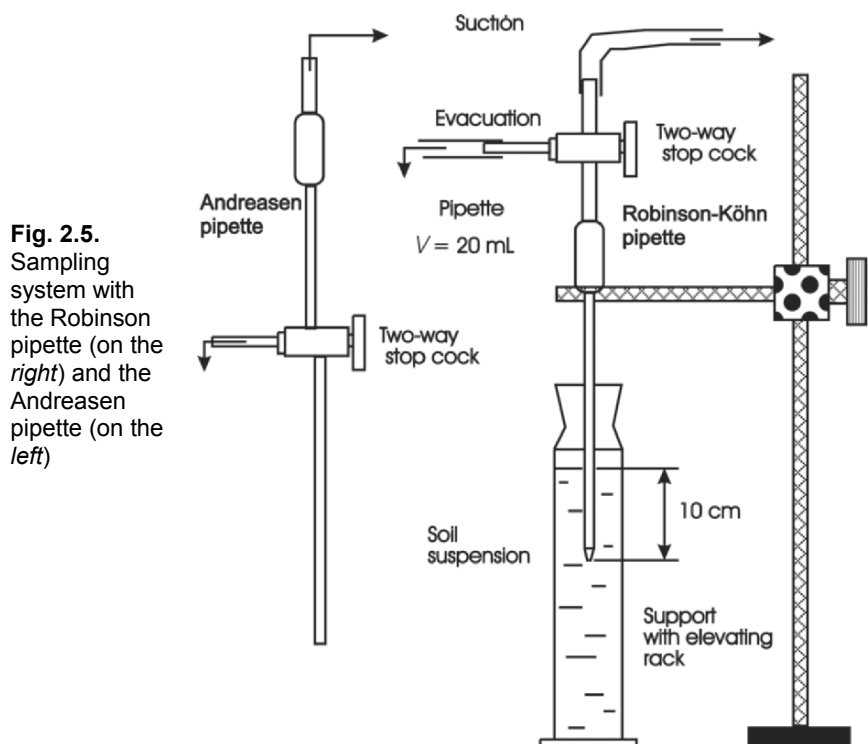

**Fig. 2.5.** Sampling system with the Robinson pipette (on the right) and the Andreasen pipette (on the left)

First check the state of the suspension. Carefully check whether flocculation has occurred although this may be only partial and impossible to see. In case of doubt, complete the following steps: measure the temperature of the suspension, calculate (2.1) the falling time at 5 cm and 10 cm (for particles of 0.02 mm), hand shake the cylinder by turning it upside down and back for 1 min; start the chronometer, lower the pipette to 5 cm. Ten

seconds before the time is up, remove a 10 mL sample and place it in a capsule. Lower the pipette to 10 cm and remove a sample at the corresponding time under the same conditions. Dry the capsules containing the samples in the drying oven at 105°C for 24 h, then weigh them ( $\pm 1$  mg); the two weights should be identical, any difference indicates flocculation and its extent. If any doubt remains about possible flocculation, it is better to start the analysis again.

Certain apparatus make it possible to identify the optimal zone of dispersion for certain clays by bringing into play their property of orientation in an electric field.

#### *First Sampling (Clay + Silts)*

In the case of big series, a team of two people can be used, who should respect the timing very strictly (Table 2.4). Hand shake the cylinder containing the 1,000 mL suspension by turning it upside down and back to put all the deposits in suspension then place it on the counter top and start the chronometer (remove the stopper after the particles have been removed by agitation).

– Close the three-way stopcock of the pipette; lower the pipette until the tip touches the surface of the suspension. Note the position of the index on the scale. Approximately 30 s before the time is up, (4 min 48 s at 20°C for 10 cm, see Table 2.5), carefully lower the pipette in the first agitated cylinder to the selected depth (here 10 cm).

– Exactly 10 s before the sampling time, begin aspiration of 20 mL (speed intake  $1 \text{ mL s}^{-1}$ ) by slowly opening the stopcock. The distribution around the exact sampling time gives the “average”. When the liquid rises above the top of the stopcock, turn it off and run the overflow off through the side nozzle.

**Table 2.4.** Procedure for stirring a series of sedimentation cylinders

stirring first cylinder 1 min	1 min	stirring second cylinder 1 min	1 min	etc.
when stirring is finished, start the chronometer: this is the beginning of the timed period	lag time		lag time	

Remove the pipette, quickly wipe the outside of the tube, and empty its contents into a previously tared 50 mL weighing bottle. Evaporate to dry and dry in the drying oven at maximum 105°C for 3 h. Weigh dry residue to precisely 1/10 mg. Correct the weight for overload due to the reagent.

### Remarks

Aspiration should not be too fast to limit turbulence and to avoid aspirating particles with a larger diameter than those of the selected sampling range. Aspiration must also be regular.

The pipette does not need to be rinsed between sampling since it has received hydrophobic treatment (cf. “Hydrophobic Treatment of a Sampling Pipette”) and any error due to retention is negligible compared with other causes of error.

Blank assays should be made with the dispersant alone (cf. “Calibration of the Pipette – Overload Reagent”). Weigh the sample and the blank after 24 h in the drying oven at 105°C.

### Second Sampling: Clay

**Table 2.5.** *right:* Sampling time of particles ( $d = 2.65$ ) by sedimentometry with a Robinson-Köhn pipette at a depth of 10 cm.  
*left:* Sampling depth of the clay-size fraction at different times

clays $\leq 2 \mu\text{m}$				tempe- rature $T$ (°C)	clays $\leq 2 \mu\text{m}$	$\leq 5 \mu\text{m}$	$\leq 20 \mu\text{m}$	$\leq 50 \mu\text{m}$
depth of sampling in cm after								
5 h	6 h	7 h	8 h					
6.2	7.5	8.8	10.0	20	8 h 00 min	1 h 16 min 48 s	0 h 04 min 48 s	0 min 47 s
6.4	7.7	9.0	10.3	21	7 h 48 min	1 h 15 min 00 s	0 h 04 min 41 s	sedimenta- tion
6.5	7.9	9.2	10.5	22	7 h 37 min	1 h 13 min 12 s	0 h 04 min 34 s	method
6.7	8.1	9.4	10.8	23	7 h 26 min	1 h 11 min 30 s	0 h 04 min 28 s	not
6.9	8.3	9.7	11.0	24	7 h 16 min	1 h 09 min 54 s	0 h 04 min 22 s	possible
7.0	8.5	9.9	11.3	25	7 h 06 min	1 h 08 min 18 s	0 h 04 min 15 s	

Proceed as above after 8 h of sedimentation at 20°C (if necessary, a smaller depth can be used to sample clay on the same day: for example, 7 h at 8.8 cm at 20°C – see Table 2.5).

Weigh the residue exactly ( $\pm 1/10$  mg) and correct the weight for overload due to the reagent (blank).

Intermediate sampling can be performed; remember to take suspensions containing the coarsest phases first and the finest last. For this it is better to use an Andreasen pipette.

### *Washing and Measuring Fine and Coarse Sands*

After the last sampling of clays, siphon off the supernatant liquid to 5 cm from the bottom; decant the deposit in 1,000 mL beakers. Add deionized water with a little hexametaphosphate (approximately 700–800 mL); agitate vigorously to put the deposit in suspension; after the time necessary for 0.02 mm particles to fall below the limit of aspiration of the siphon, siphon off the supernatant liquid (Fig. 2.6).

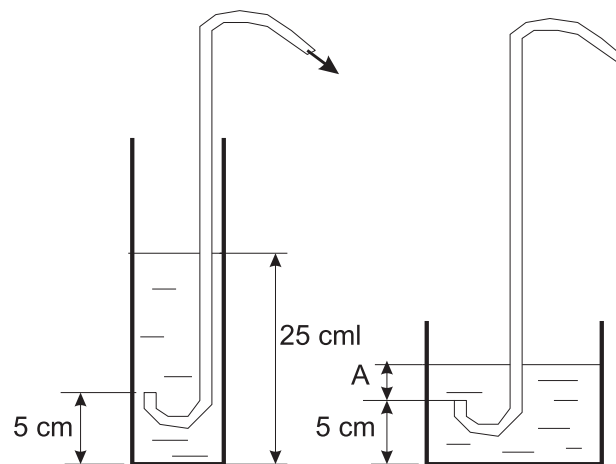

**Fig. 2.6.** Washing of sands by decantation: *left*, first siphon off, *right*, continue siphoning until supernatant is clear ( $A$  = falling height of 0.02 mm particles)

Again add water with a little hexametaphosphate; continue washing until the liquid supernatant is clear; finish with one final washing with distilled water; eliminate the maximum amount of water possible per decantation, quantitatively decant the deposit of sands in a capsule, put to dry in a ventilated drying oven at 105°C; after cooling, weigh total sands; put the sands on the top of two superimposed sieves, one with a 0.2 mm mesh (AFNOR 24), the other with a 0.05 mm mesh (AFNOR 18); sieving with a vibrating apparatus must be complete; check there are no cemented aggregates or plant debris. The mesh of the 0.2 mm sieve represents coarse sands, and the mesh of the 0.05 mm sieve represents fine sands.

The coarse silts or very fine sands are determined by calculating the difference between total sands and the sum of coarse sands and fine sands.



**Remark**

The washing–decantation operations are long and tiresome, particularly as many samples are required in routine analyses. It is possible and advisable to use an automated system to wash the sands, e.g. the one developed by Susini (1978).

**Causes of Error**

A strict procedure is required to ensure the temperature remains stable for the duration of sedimentation. This can be achieved by immersing the cylinders in a thermostat bath, but this device is not really suitable for the treatment of the large series required in many laboratories. Consequently the cylinders are simply laid out in line on the lab table. The temperature should be taken in one of the cylinders at the beginning. Since the liquid medium presents good thermal inertia, variation is not very great over a short period, i.e. for the first sampling of about 4 – 5 min. The most favourable temperature is between 15°C and 25°C; above 30°C there is a risk of flocculation; below 15°C the times needed for sedimentation will be too long. For these reasons, in the absence of a thermostat, it is best to work in an air-conditioned room.

But the main causes of error are:

- Too abrupt entry of the pipette in the suspension.
- Error in the depth of sampling.
- Irregular or too rapid aspiration; certain authors recommend a time of 20 s per aspiration for a volume of 10 mL. These requirements exclude aspiration with the mouth.

Optimal working conditions are guaranteed by making sure there is no variation between the way the operators perform the series of operations, i.e. moving the pipette, lowering the pipette into the suspension, exact timing of the beginning of the sampling, very regular sampling, exact volume, careful removal of the pipette, draining of the sample into the capsule, next sampling. The ideal solution is to use a simple automatic unit like that described in Pansu et al. (2001). However, even if the traditional manual system has to be used it is preferable to carry out aspiration with a small electric pump with a fixed flow; peristaltic pumps fulfil this function well.

**Calculations****Collected Data**

Mass of soil sample (air dried) =	$m$
Moisture correction coefficient =	
mass sample after drying at 105°C / $m$ =	$K$
Volume of the sample =	$V_p$
Mass of blank (reagents without sample) after drying 105°C =	$m_B$
Mass of first sample (clay + silt) after drying 105°C =	$m_1$
Mass of second sample (clay) after drying 105°C =	$m_2$
Mass of total sands after drying 105°C =	$m_3$
Mass of coarse sands (rejected by 0.2 mm sieve) after drying at 105°C =	$m_4$
Mass of fine sands (rejected by 0.05 mm sieve) after drying at 105°C =	$m_5$

**Calculation of the Results in% of Soil Dried at 105°C**

Clays = $C$ =	$(m_2 - m_B) \times 1000 \times 100 / (V_p \times m \times K)$
Silts = $Si$ =	$(m_1 - m_2) \times 1000 \times 100 / (V_p \times m \times K)$
Fine sands = $FS$ =	$100 \times m_5 / (m \times K)$
Coarse sands = $CS$ =	$100 \times m_4 / (m \times K)$
Total sands = $S$ =	$100 \times m_3 / (m \times K)$
Coarse silts = $CSi$	$S - (FS + CS)$

If limestone is present (Table 2.3, B), and particle size analysis was performed without destruction of carbonates, carbonates should be determined on the separated fractions which provides information about the distribution of limestone.

**Checking and Correction of the Results**

Taking into account the moisture correction factor (cf. "Calculations" under Sect. 2.2.3), the sum: clays + silts + total sands + organic matter + if necessary, carbonates, soluble salts, gypsum, must be between 95 and 102%, preferably between 98 and 102%. Soils rich in organic matter can provide too high balances: in the event of incomplete destruction during pretreatment, organic matter can be counted twice.

A too small sum results from losses during the pretreatments. In the majority of cases, it is impossible to determine the exact proportions of losses in organic matter, soluble salts, carbonates and gypsum. An overall estimate of the losses can be made as follows: using the cylinder in which the samplings were made, add 10 mL of 1 mol (CaCl<sub>2</sub>) L<sup>-1</sup> solution and 1 mL of 1 mol (HCl) L<sup>-1</sup> to flocculate colloids and prevent the formation of

calcium carbonate during drying in the drying oven. Allow the particles to deposit, completely remove the clear solution, put the deposit in a tared capsule, dry in the drying oven at 105°C, and then weigh. This gives mass  $m_r$  from which losses during the treatments (organic matter, etc.) can be determined and the balances corrected.

## 2.2.4 Density Method with Variable Depth

### *Principle*

This type of analysis is advantageous because it avoids fractionation of the sediment in dimensional classes and allows the construction of curves of distribution. In the density method proposed by Bouyoucos (1927, 1935, 1962), the heterogeneous suspension is considered to behave in the same way as a homogeneous liquid with the same density. Casagrande (1934) showed that it is then acceptable to use a float densimeter to measure the average density in the suspension column with the float. The plan of average density is located at a distance  $H_R$  from the highest level of the suspension. From (9.4) and (9.4') it separates the particles from the radius:

$$r = C^{-1/2} \left( \frac{H_R}{t} \right)^{1/2},$$

( $t$  = sedimentation time), and allows particle size analysis.

The density method can be performed with permanent immersion, which fulfils the conditions of continuous measurement, or by temporary immersion, which resembles discontinuous measurement described in Chap. 1, without the same precision, but for routine measurements it has the advantage of avoiding sampling and weighing. On the other hand, the density method requires a larger number of samples than the pipette method.

### *Equipment and Reagents*

- Cylinders identical to those described in “Equipment” under Sect. 2.2.3, special conical hydrometers to avoid accumulation of the particles on the surface, thermometer, pycnometers, magnifier with long effective focal spot.
- Dispersing reagents of “Equipment and Reagents”, isoamylic alcohol.

### ***Checking the Hydrometer***

#### ***Calculation of Falling Height of the Particles***

The relation of Casagrande makes it possible to calculate the value  $H_r$ , giving the effective depth selected as falling height of the particles. For this calculation, the measurements shown on the hydrometer in Fig. 2.7 are required. The volume of the hydrometer is obtained by liquid displacement.

$$H_r = h_1 + 0.5 (h - V/S) \quad (2.5)$$

$V$ : volume in  $\text{cm}^3$

$S$ : section in  $\text{cm}^2$

A graph can be drawn representing depths  $H_r$  as a function of the densities. This makes it possible to draw up the table giving the size of the particles as a function of temperature, time, and depth, for an unknown hydrometer.

#### ***Checking the Graduations on the Hydrometer***

This test is made with pure water and a 2% solution of barium nitrate or chloride. Use a pycnometer to measure the density of water (note the temperature) then the density of the 2% solution (4 significant decimals).

Take the same measurements by submerging the hydrometer in the test-tube successively containing the two liquids; read the densities with the help of a magnifier with a long focal spot (5 or 6 cm).

Note the differences in the measurements obtained with the pycnometer and the hydrometer. If the relative values are the same, the hydrometer is valid even if the indications are not exact, because in the calculations the differences in density are used.

If the differences between the pycnometer and hydrometer measurements are not constant, an abacus of transposition has to be established: values read on the hydrometer/actual values (this is very seldom the case).

This method is similar to that described in Sect. 2.2.3 using 30 g of fine earth (soil air dried and sieved to 2 mm). For dispersion, add 30 mL of 102 g  $\text{L}^{-1}$  hexametaphosphate solution. Agitate for 4 h by upside down and back rotary shaker, transfer in the cylinders and complete to 1,000 mL.

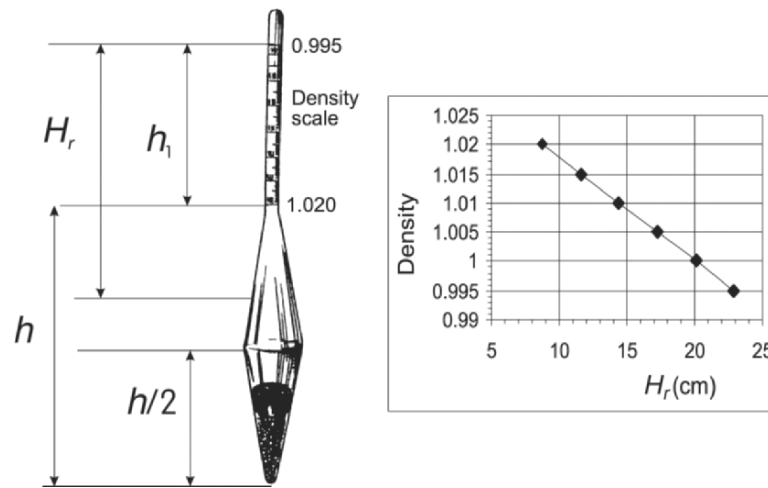

**Fig. 2.7.** Relation between density and falling height of the particles  $H_r$  (2.5) for a hydrometer with the following characteristics:  $V = 45 \text{ cm}^3$ ,  $S = 28.26 \text{ cm}^2$ ,  $h = 17 \text{ cm}$ ,  $h_1 = 15.2 \text{ cm}$ ).

## Procedure

### *Preparation of the Sample*

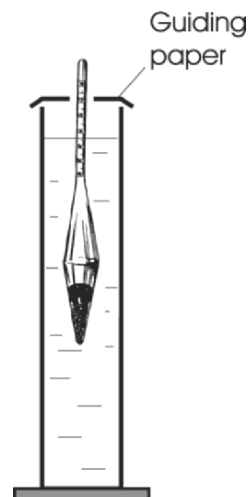

**Fig. 2.8.** Positioning of hydrometer

*Measurement of the Clay + Silt (0.02 mm) Fraction***Table 2.6.** Sizes of the particles as a function of temperature, time and the depth: valid for a standard hydrometer (laboratory of sedimentary sequences, IRD Bondy, France, unpublished data)

Particle Size	t (°C)	density→ (min ↓)	1.020 8.7 cm	1.015 11.6 cm	1.010 14.4 cm	1.005 17.2 cm	1.000 20.1 cm	
	4		21 µm	24.7 µm	27.4 µm	30.1 µm	32.5 µm	
	15	6	17.4	20.1	22.4	24.5	26.5	
		8	15	17.4	19.4	21	23	
		9	14.2	16.4	18.2	20	21.6	
20 µm	4		20	23	25.8	28.2	30.3	
	6	6	16.4	19	21	23	24.5	
		20	8	14.2	16.3	18.2	19.8	21.4
			9	13.4	15.4	17.2	18.8	20.2
(clays + silts)	25	3	21.8	25.2	28.1	30.7	33.2	
		4	19.9	21.8	24.3	26.6	28.7	
		6	15.4	17.8	19.8	21.6	23.4	
		8	13,4	15,4	17,2	18,8	20,3	
particle size	t (°C)	density→ (hours ↓)	1.020	1.015	1.010	1.005	1.000	
2 µm	15	6	2.2 µm	2.6 µm	2.9 µm	3.1 µm	3.4 µm	
		8	1.9	2.2	2.5	2.7	2.9	
		24	1.1	1.3	1.4	1.58	1.7	
(clays)	20	6	2.1	2.4	2.7	2.9	3.2	
		8	1.8	2.1	2.3	2.5	2.7	
	25	24	1	1.2	1.4	1.5	1.6	
		6	2	2.3	2.6	2.8	3	
	25	8	1.4	2	2.2	2.4	2.6	
		24	1	1.1	1.2	1.4	1.5	

If possible measurements should be made in an air-conditioned room at a constant temperature of 20°C. The cylinders containing the suspensions are grouped; check their volume has been completed to 1,000 mL, measure the temperature by referring to a table (such as Table 2.6) giving

times of sedimentation for measurements at the selected temperature (for example 4–6–8–9 minutes).

Hand shake the first cylinder by it turning upside down and back for 1 min, add an isoamyl alcohol drop anti-foamer, start timing, introduce the hydrometer very gently so as not to disturb the suspension (this is the most delicate part and a significant cause of error), take care that the hydrometer is maintained in the centre of the suspension, (if need be, make a paper guide see Fig. 2.8), take the readings at the top of the meniscus at 4–6–8 and 9 min. Continue in the same way with the following cylinder.

Take a reading of the blank in a cylinder containing only the dispersant.

#### *Measurement of Clay Fraction (< 0.002 mm)*

The time counted starts at the beginning of agitation of the first cylinder during the first reading (clay + silt). To define this time, the average temperature has to be calculated from the beginning of sedimentation until the reading; take readings with the hydrometer at 6–8–24 h carefully respecting the 2 min interval used for the first sampling; transfer the hydrometer very carefully from one cylinder to another in order to avoid disturbances.

**Fig.2.9.** Example of abacus: sizes of particles are a function of the time of sedimentation for a given hydrometer and a density close to 1.010.

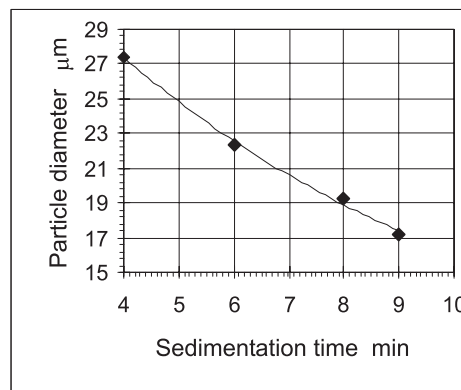

#### Remarks

As can be seen in Table 2.6, that selected times do not correspond exactly to the selected particle size; however, in a small space of time, variation in particle size is considered to be continuous; this makes it possible to plot an abacus around a given depth (Fig. 2.9) which then makes it possible to define an exact falling time for a given particle size.

### Calculations

The percentage of particles  $P$  corresponding to a given density is obtained from the equation:

$$P = \frac{100 \rho_s}{m(\rho_s - \rho_f)} \left( (\rho \pm \delta_\rho) - \rho_f \right) V. \quad (2.6)$$

$\rho_s$  = density of solid = 2.65 for soil;

$\rho_f$  = density of the dispersing solution; in our conditions at  $t^\circ\text{C}$ , one can calculate  $\rho_f$  by means of (2.2);

$\rho$  = density read at  $t^\circ\text{C}$ ;

$\delta_\rho$  = corrections + or - on readings to bring them to  $20^\circ\text{C}$  (Table 2.6);

$V$  = volume, 1,000 mL;

$m$  = soil sample, 30 g;

The calculation can be simplified by calculating  $K = 100 \rho_s / m (\rho_s - \rho_f)$

which gives  $P\% = K [(\rho \pm \delta_\rho) - \rho_f] V$

with  $m = 30$  g, at  $20^\circ$ , it gives  $K = 5.35$

### Determination of Sands

Use the same technique as that described in Sect. 2.2.3.

### 2.2.5 Density Method with Constant Depth

The density method with variable depth (cf. 2.2.4) has the advantage of greater speed compared to the pipette method as well as allowing uninterrupted measurements if required. However, as the depth of immersion is not constant, the degree of precision is lower and calculations are longer.

The chain hydrometer (de Leenheer system) makes it possible to measure the density of the suspension to a given constant depth of approximately 20 cm, which in turn, makes it possible to approach the principle and the precision of the pipette method while avoiding sampling and weighing (De Leenheer and Macs 1952; De Leenheer et al. 1955; De Leenheer and van Hove 1956; van Ruymbeke and de Leenheer, 1954).

The apparatus (Fig. 2.10) is composed of an immersion body at the end of an arm with (1) a pointer that identifies the level of the liquid and (2) at the top, a support that can receive overload weights in the form of riders, and an equilibrium chain that allows a very fine fit when the pointer locates the surface of the liquid. The depth of sedimentation is represented by the distance from the point of the needle located in the middle of the body of the hydrometer.



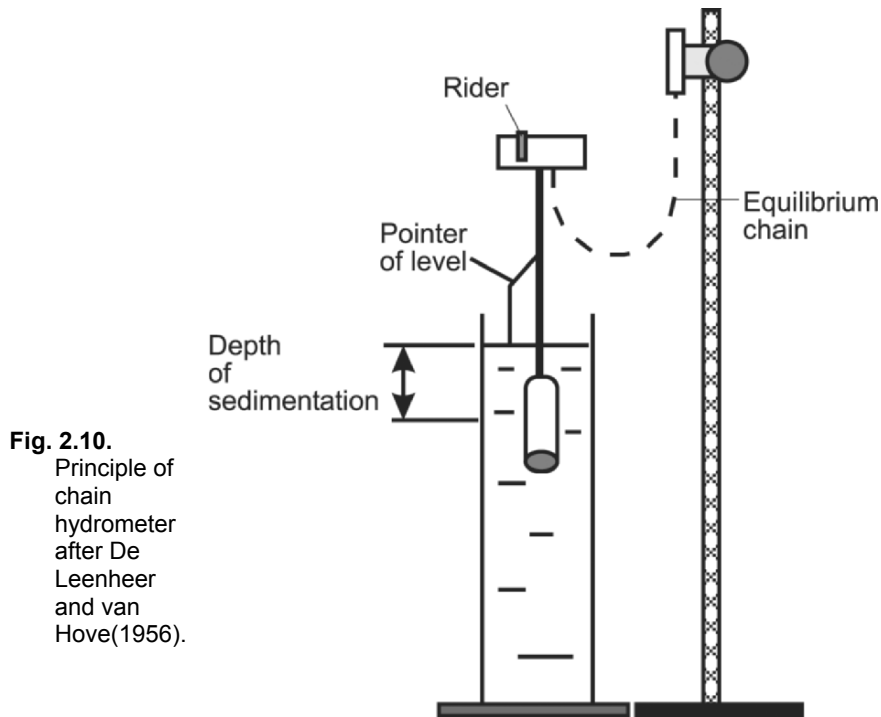

**Fig. 2.10.**  
Principle of  
chain  
hydrometer  
after De  
Leenheer  
and van  
Hove(1956).

One minute before measuring time, carefully introduce the hydrometer into the suspension; add the weights in such way that the reference mark of the needle is 1 – 2 cm above the level of the liquid. At the precise time of the sampling, adjust the needle so that it is in contact with the liquid by quickly adjusting the chain with the screw device. The chain can cause an overload of 100 mg. The reading for total overload gives the weight of the hydrometer. Having determined in advance the volume of the hydrometer (by immersion in distilled water), one thus obtains:

$$\text{density } (\rho) = \text{weight of the hydrometer} / \text{hydrometer volume}$$

Continue the calculations in the same way as for the density method with variable depth (2.6).

### **2.2.6 Particle Size Analysis of Sands Only**

Place 100 g of fine earth (standard 2 mm preparation from a perfectly homogenized batch) in a 1,000 mL beaker with 100 mL hydrogen peroxide brought to 30 volumes; leave to act in a cold place overnight, then transfer on a moderately heated hotplate; add hydrogen peroxide in small fractions until complete destruction of the organic matter, then eliminate excess hydrogen peroxide by boiling without going to dry.

**Table 2.7.** The two sieving columns used successively for particle size analysis of sands

column 1		column 2	
mm	AFNOR standard	mm	AFNOR standard
2	34	0.315	26
1.6	33	0.25	25
1.25	32	0.20	24
1	31	0.16	23
0.8	30	0.125	22
0.63	29	0.100	21
0.50	28	0.08	20
0.40	27	0.063	19
		0.050	18

Transfer the residue in a cylinder and add 500 mL distilled water and 25 mL of 52 g L<sup>-1</sup> sodium hexametaphosphate solution. Place in a rotating shaker for 4 h in the same way as for complete particle size analysis.

After this operation, transfer the content of the cylinder on a 0.05 mm mesh sieve (French standard AFNOR NF-X-11-504 module<sup>o</sup>18); wash the residue under running water.

Place the well-washed sands of the 0.05 mm sieve in a 250 mL beaker. Add 100 mL of 6 mol (HCl) L<sup>-1</sup> solution, cover with a beaker cover, and boil gently for 2 h to dissolve iron.

After cooling, decant and wash by successive decantation until complete elimination of the acid; transfer again on a 0.05 mm sieve, wash, and transfer quantitatively the sands in a capsule; dry for 24 h in drying oven at 105°C. Let cool and weigh total sands.

Sieve dry total sands successively on the two columns of sieves (Table 2.7). Place the columns successively on a vibrating sieve machine (Pansu et al., 2001).

Transfer in column 2 the fraction collected at the bottom of column 1. Sieve 10 min and weigh each fraction ( $\pm 0.01$  g).

Checking: sum of weighings of each fraction = total sands.

## 2.3. Automated Equipment

### 2.3.1 Introduction

The phenomena of slaking of the soils requires precise knowledge of the grain-size distribution of the 2–20  $\mu\text{m}$  fraction; sediment studies require a distribution of the fine phases down to 0.1  $\mu\text{m}$  or even lower. In agronomy, the horizons comprising the formation of clay are studied using ratios for “coarse clay < 2  $\mu\text{m}$ /fine clay < 0.2  $\mu\text{m}$ ”. Since gravity methods cannot provide all the answers, a range of different techniques is required.

Table 2.1 summarizes the main methods used for measurement of the particle-size distribution of soils. Some methods are well suited for the repetitive measurements needed for studies in the fields of pedology, agronomy, geology or sedimentology; others are more suitable for detailed and in-depth studies. The choice of a method will depend on:

- the degree of precision required, reproducibility and repeatability, and a good correlation with the pipette reference method (cf. 2.2.3) despite its defects;
- the extent of the particle size field and possibility of extending it to sub-micronic or nanometric particles;
- the speed of execution, the time needed to produce a result, the flexibility of use, the possibility to significantly increase the number of analyses;
- the possibility of recovering the particle fractions for later measurements, or of taking other measurements simultaneously (continuous analyses, etc.);
- the cost of equipment and personnel, the importance of the request and available space;
- continuous data acquisition and exploitation (monitoring, calculations, histograms and cumulative frequency curves).

Given the wide granular spectrum of soils, combinations of individual methods that do not cover the complete spectrum are often used. There should be a significant overlap between the methods. The pipette method remains the reference method for all comparisons; analysis by laser diffraction makes it possible to extend the spectrum to the sub-micronic field but still identify silts. The true representativeness of equivalent diameters in a given class can be checked using a microscopic method and image analysis.

### 2.3.2 Methods Using Sedimentation by Simple Gravity

The majority of apparatus designed to mechanize the pipette method are not widely distributed, as each laboratory tends to develop devices suitable for its own needs. For example, the automatic particle-measurement instrument distributed by “Technology Diffusion France” (Pansu et al., 2001) is based on sedimentation in a thermostated cupboard with an automated pipette.

Analysts, especially those in the industrial sector, need methods that obtain rapid results with good repeatability and the possibility of calibrating the apparatus (using calibrated microball powders). For the main types of automated equipment available and the names of manufacturers see Pansu et al. (2001).

#### ***Sedimentation Balances and Automated Sieve Machines for Wet Measurements***

These balances (Sartorius, Cahn, Mettler, etc.) make it possible to continuously record the process of sedimentation between approximately 1 and 150  $\mu\text{m}$  (Fig. 2.11), the higher fractions being in the domain of automated wet or dry sieve test machines (Micromeritics, Seishin, etc.).

**Fig. 2.11.** Diagram of a particle size balance with constant equilibration

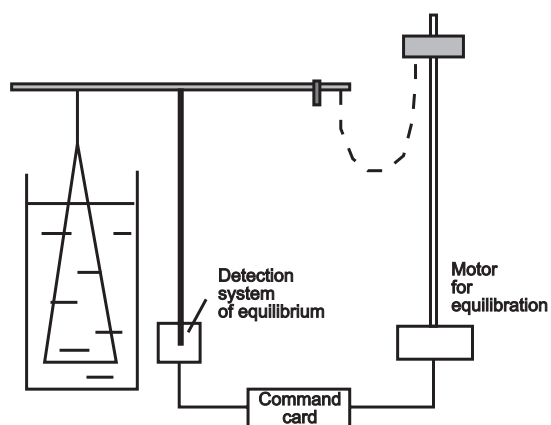

Sedimentation is carried out after dispersion on samples of reduced weight, i.e. about 1–2 g, in a thermostatic enclosure. Continuous automatic recording of the weight of the sediments deposited makes it possible to create cumulative mass curves as a function of time. Depending on the degree of automation and calculation, frequency charts can also be created. The measurements are reproducible, but require a long time to perform and are thus not suitable for series analysis.

---

**Systems Using Simple Gravity and Measurement by X-ray**

The particles are prepared and put in suspension (as described in sections X-ray beam). The particles absorb a quantity of X-ray proportional to their number. The resulting intensity is measured by a scintillation counter.

At the beginning, the resulting intensity of X-rays is at a minimum, then the falling particles cause an increase in the intensity transmitted. To reduce measurement time, the cell containing the suspension gradually moves downwards and the fixed X-ray beam sweeps a portion of the suspension increasingly close to the surface. All these movements are controlled by computer, and the position of the cell is a logarithmic function of time, coupled with the  $x$ -axis of the recorder, which makes it possible to determine the diameter that corresponds to the position of the cell. The smallest diameter it is possible to measure is 0.1  $\mu\text{m}$  and the largest is 100 – 300  $\mu\text{m}$ , depending on the model.

Continuous measurements make it possible to express the results in the form of cumulative curves or histograms of weight, or number of surface particles, etc. Computer interfaces make it possible to store the results of the analyses, and a sampler equipped with a carousel allows uninterrupted treatment of several samples.

It should be noted that X-rays with wavelengths of less than 10 nm are well suited for the measurement of particles which would be impossible to measure in visible light (100 – 800 nm i.e. similar to the diameter of fine clay particles). Repeatability is satisfactory and measurement up to 2  $\mu\text{m}$  takes about 10 min.

This type of equipment has been the subject of comparative studies with the pipette method for the analyses of soils (e.g. Delaune et al., 1991). It is useful for the 50–1  $\mu\text{m}$  fraction, but needs a longer time for finer particles (< 0.2  $\mu\text{m}$  in 50 min). However, undervaluation of coarse silts has been observed when they comprise more than 20% of the soil.

**System Using Simple Gravity and Measurement by Light Absorption or Scattering**

Methods based on photo-sedimentation (nephelometry, turbidimetry) are subject to many interferences. Their reproducibility and repeatability are low due to the use of white light or monochromatic light in the visible spectrum.

These methods should only be used for rapid comparisons within homogeneous families.

### ***Methods Using Elutriation***

In these methods, the falling speed of the particles (the mobile solid phase which is easy to measure) is lower, equal or higher than the speed of the fluid (non-stationary mobile liquid phase).

The liquid phase circulates in the reverse direction to the particles, making it possible to sort them; the finest particles migrate upwards or fall by gravity. The different fractions can be recovered. This system is suitable for certain studies on sediments, but measurements take a long time and are not really suitable for repetitive analysis.

### **2.3.3 Methods Using Accelerated Sedimentation**

#### ***Principle***

In practice, methods using simple gravity cannot be used for particle sizes  $< 2 \mu\text{m}$  because of the extremely long time needed for sedimentation of the finest particles. It is difficult to maintain the cylinders of sedimentation without convection currents for long periods and to withdraw the particles from the Brownian movement. However, acceleration of gravity by centrifugation makes it possible to exceed the limits and to mitigate the effect of Brownian movement.

The techniques of separation and the recovery of granulometric phases by this process are discussed in Chap. 3.

#### ***Apparatus Using Centrifugal Discs***

Some equipment uses successively first simple gravity with the vertical rotor remaining stationary for the largest particles, and second gravity with centrifugation at speeds of 1,800 to 8,000g (Horiba, Shimadzu, Seishin, Union-Giken, Joyce-Loebl-Vickers, etc.).

Analysis is continuous, and recording makes it possible to automatically create curves and histograms. Masses of soil of the order of 1 g can be treated in this way.

Depending on the manufacturer, the measuring cells are intersected either by a filtered incandescent light with measurement of absorption, or – very exceptionally – by laser or X-ray detection (Brook Haven). Particles of  $0.01 \mu\text{m}$  to  $100 \mu\text{m}$  can be identified. Other manufacturers use horizontal discs and samplings at a given distance and at a given time. The fractions are dried, weighed and possibly subjected to other analyses (Fritsch, Simcar, Joyce-Loebl, etc.).

The performances of these apparatus are not always equal for series analysis, and repeatability is not always within the range usually obtained with the pipette method.

For sub-micrometric analysis, one manufacturer offers an ultracentrifuge with a titanium disc at 100,000g in a partial vacuum to avoid heating and noise. A UV scanner (280 nm) makes it possible to analyze soil particles of less than 500 nm (Beckmann Spinco).

Micro-methods using Field flow fractionation (FFF) are still not reliable enough for widespread use in soil studies.

### **2.3.4 Methods Using Laser Scattering and Diffraction**

Laser particle-measurement instruments have undergone spectacular development and can now be used for an increasing range of particle sizes. Certain equipment make it possible to cover ranges from 0.1 to 2,000  $\mu\text{m}$ , but in general, apparatus are particularly powerful for a more limited range. One range is dedicated to sub-micronic, or even nanometric particles, while others with a wider range are particularly useful for the particle size analysis most usually required by soil laboratories.

These measurements are not based on sedimentation and must consequently be calibrated.

A dispersing liquid containing suspended particles circulates in a measuring cell intersected by a monochromatic Laser beam collimated by a condenser on a window of analysis of a defined surface. The light of the Laser is diffracted on the outside of the particles and the angles of diffraction are inversely proportional to the size of the particles. An optical system collects the signals which are analyzed by Fourier transformation and discriminated on a detector engraved with pre-determined angles. The signal is treated to extract the distribution of the particles. The results can be expressed in the form of curves: by average diameter (particle size distribution) expressed as a percentage of total weights, by histograms of weight, surface, number of particles, volume, etc. 32 – 64 classes of sizes can be measured (Malvern, Cilas-Alcatel, Coulter, etc.).

Certain apparatus allow either proportioning on a suspension, or on dry powder, which can be useful for analyzing silts. Serial deflocculation on line is possible by ultrasound. Loading 40 samples with a sample distributor and a using distributor for reagents makes it possible to work without continuous monitoring.

Analytical files enable methods to be pre-determined, including the dispersants. The procedures are simple but vary considerably with the

apparatus and it is consequently impossible to give a detailed procedure here.

### **2.3.5 Methods Using Optical and Electric Properties**

Analysis of the distribution of sub-micron particles (3 nm to 3  $\mu\text{m}$ ) combines measurements of pH, temperature, conductivity, and relative viscosity making it possible to control the stability of a suspension and the electro-kinetic potential (Zeta potential, potential difference between the dispersed surface layer and the medium of dispersion).

The ionic force is measured in an electrophoresis quartz tank with a Pt–Mo electrode on particles measuring from 1 to 1,000  $\mu\text{m}$  (Malvern, Brookhaven, Coulter, Micromeritics, Mono-Research Lab., Zetameter Inc., Matec Applied Science, etc.).

The effective surface charge of the particles is determined by the measurement of mobility in a liquid–solid system, the permittivity of the liquid being known. This enables the study of the phenomena of flocculation and dispersion.

Other apparatus are designed for the study and optimization of the dispersion of certain clays for industrial use. They make it possible to differentiate flocculated and deflocculated particles. For example, primary Kaolinite particles consist of regular hexagonal discs. The nature of these particles means that in the presence of an electric field a dipole is induced, causing alignment with the field. The neo-aggregates formed by flocculation consist of clusters of randomly arranged primary particles, out of alignment with the electric field. To measure the relative proportions of flocculated and dispersed particles, the suspension is intersected by a Laser beam and the diffused light is analyzed. The result is quantified. Measurements made in different conditions (dispersing concentration, the nature of the dispersant, pH, etc.) enable optimization of the analyses.

### **2.3.6 Methods Allowing Direct Observation of the Particles**

#### ***Optical and Electronic Microscopy – Radiation Counter and Image Analyzer***

These direct methods are based on the use of optical microscopy, or possibly of electronic microscopy (cf. Chap. 8). Particle fractions isolated by gravity can be used among others. In electronic microscopy, the preparations must be dried and presented on grids or plates (MET-MEB).



Microscopy makes it possible to directly observe the population of particles and their morphological parameters. Shape, length, width, thickness or diameter can be defined on micro-samples, and the fractal properties estimated. Comparison of the particles of the same fraction makes it possible to judge the quality of fractionation (use of tests of bulky diatoms, regularity, influence of density, etc.). Counting can be done by a radiation counter, or by an image and texture analyzer.

In electronic microscopy with an EDX probe it is possible to perform chemical analyses; and in optical microscopy, to use infra-red radiation. This equipment offers a wide range of possibilities (Quantachrome, Zeiss, Leitz, etc.) and makes it possible to establish percentages of cumulated mass, distribution by size of particles, in terms of number, mass and specific surface area (0.1 – 300  $\mu\text{m}$ ).

### 2.3.7 Methods Using Conductivity

While passing through a gauged opening, a particle displaces a volume of electrolyte which modifies electric resistance (differential conductivity). This change in resistance is a function of volume. Counting allows particles to be grouped in classes using an amplitude discriminator.

The results are expressed in 16 counter channels as total percentage weight or the number of particles of a specific dimension; results can be presented in the form of graphs or tables.

The apparatus based on this principle are counters that make it possible to ignore density which can be useful when dealing with soils rich in iron oxides with a high density (4 – 5), i.e. well above the mean of 2.65 used for sedimentation by simple gravity. The shape of the particles is significant for the accuracy of the measurements. Measurements are possible between 1 and 5,000  $\mu\text{m}$  (Coulter), but the optimal field of measurement depends on the choice of a suitable opening. Particles of less than 1  $\mu\text{m}$  are often underestimated. The preparation of the samples is identical to the standard method (cf. Sects. 2.2.1 and 2.2.2).

## References

- Atterberg A (1912) Die mechanische Bodenanalyse und die klassifikation der mineral böden sechwedens. *Int. Mitt. Bodenk.*, 2, 312–342
- Baize D (2000) *Guide des analyses courantes en pédologie.*, INRA, France, 257 P
- Bouyoucos GS (1927) The hydrometer as a new method for mechanical analysis of soils. *J. Soil Sci.*, 23, 343

- Bouyoucos GS (1935) A hydrometer method for making mechanical analysis of soils. *Bull. Am. Ceram. Soc.*, 14, 259
- Bouyoucos GS (1962) Hydrometer method improved for making particle size analysis of soils. *Agron. J.*, 54, 464–465
- Casagrande A (1934) Die Aräometer-methode zur Bestimmung der Kornverteilung von Boden und anderen Materialien. *Springer J.*
- De Leenheer L and Van Hove J (1956) Werkwijze voor de mechanische analyse met de kettingshydrometer. *Rijksland Bouwhogeschool (Gand)*, XXI, 249–274
- De Leenheer L and Maes L (1952) Analyse granulométrique avec l'hydromètre à chaîne. *Bull. Soc. Belge de Géologie*, 61, 138–164
- De Leenheer L, Van Ruymbeke M and Maes L (1955) L'analyse mécanique au moyen de l'hydromètre à chaîne. *Silicates Industriels*, Tome XX, n° 6–7, 1–7
- Delaune M, Reiffsteck M and Feller C (1991) L'analyse granulométrique de sols et sédiments à l'aide du microgranulomètre sédigraph 5000 et comparaison avec la méthode à la pipette Robinson. *Cahiers ORSTOM sér. Pédol.*, 26, 183–189
- Gee GW and Bauder JW (1986) Particle-size analysis. In *Methods of Soil Analysis. Part 1 Physical and Mineralogical Methods*, Klute A. Ed. Chap. 15. *American Society of Agronomy. Soil Sci. Soc. Am.*, 383–411
- Gras R (1988) *Physique du sol pour l'aménagement*, Masson, Paris, 587 p
- Hénin S (1976) *Cours de physique du sol*, vol. 1. Orstom-Editest, Bruxelles, 159 p
- Jackson (1969) *Soil Chemical Analysis – Advanced Course*, 2nd ed. University of Wisconsin, Madison, WI
- Mériaux S (1954) Contribution à l'étude de l'analyse granulométrique. *Ann. Agro.*, I, 5–53, II, 149–205
- Pansu M, Gautheyrou J and Loyer JY (2001) *Soil Analysis – Sampling, Instrumentation and Quality Control*, Balkema publishers, Lisse, Abington, Exton, Tokyo, 512 p
- Pétard J (1993) *Les méthodes d'analyse. T1 Analyse de sols*, Notes techniques laboratoires communs d'analyse, Orstom, Nouméa, Paris
- Rouiller J, Burtin G and Souchier B (1972) La dispersion des sols dans l'analyse granulométrique. Méthode utilisant les résines échangeuses d'ions. *Bull. ENSAIA, Nancy, France*, 14, 183–204
- Stokes GG (1851) On the effect of the lateral friction of fluids on the motion of pendulums. *Trans. Cambridge Phil. Soc.*, 9, 8–106
- Susini J (1978) Réalisation d'un ensemble automatique de lavage des sables de l'analyse granulométrique. *Cah. ORSTOM Série Pédol.*, 16, 339–344
- Tamm O (1922) Eine Methode zur Bestimmung der anorganischen Komponenten des Gelkomplexes im Boden. *Meddel. Statens Skogsforsöksanst (Suède)*, 19, 385–404
- Van Ruymbeke M and De Leenheer L (1954) Etude comparative d'analyses granulométriques par décantations successives et par l'hydromètre à chaîne. *Actes et C. R. du Vème Congrès International de la Science du Sol (Leopoldville)*, II, 322–328

- Vieillefon J (1979) Contribution à l'amélioration de l'étude analytique des sols gypseux. *Cah. ORSTOM Sér. Pédol.*, XVII, 195–223
- X 31-107 (1983) *Analyse granulométrique par sédimentation. Méthode de la pipette*. In *Qualité des sols 3<sup>e</sup>ed.*, AFNOR, 357–371

## Bibliography

### Generality

- Barth HG and Shao-Tang Sun (1991) Particle size analysis. *Anal. Chem.*, 63, 1R–10R.
- Chamayou H and Legros JP (1989) *Les bases physiques, chimiques et minéralogiques de la Science du sol*, Tech. Vivantes, ACCT Presses Univ. de France, 593 p.
- Guillet B and Rouiller J (1979) La granulométrie. In *Pédologie, constituants et propriétés des sols*, Bonneau and Souchier ed., Masson, 317–321.
- Johnston, Farina MPW and Lawrence JY (1987) Estimation of soil texture from sample density. *Commun. Soil Sci. Plant Anal.*, 18, 1173–1180.
- Jones JL, Kay JJ, Park JJ and Bishop CK (1980) The determination of particle size distribution in soil. A collaborative study. *J. Sci. Food Agric.*, 31, 724–729.
- Loveland PJ and Whalley WR (1991) Particle size analysis. In *Soil Analysis: Physical Methods.*, Smith KA, Mullins CEJ ed., Dekker, New York 271–328.
- Smith RB and Pratt DN (1984) The variability in soil particle size test results by various sub sampling techniques. *J. Soil Sci.*, 35, 23–26.
- Syvitski JPM (1991) Principles, methods and applications of particle size analysis. *Cambridge Univ. Press.*, 366 pages.

### Pre-treatment

#### Organic Matters

- Douglas LA and Fiessinger F (1971) Degradation of clay minerals by H<sub>2</sub>O<sub>2</sub> treatments to oxidize organic mater. *Clays Clay Miner.*, 19, 67–68
- Fisher WR (1984) The oxidation of sol organic matter by KBrO for particle size determination. *Commun. Soil Sci. Plant Anal.*, 15, 1281–1284
- Harada Y and Inoko A (1977) The oxidation products formed from soil organic matter by hydrogen peroxide treatment. *Soil Sci. Plant Nutr.*, 23, 513–521

- Langeveld AD Van, Gaast SJ Van der and Eisma D (1978) A comparison of the effectiveness of eight methods for the removal of organic matter from clay. *Clays Clay Miner.*, 26, 361–364
- Lavkulich LM and Wiens JH (1970) Comparison of organic matter destruction by hydrogen peroxide and sodium hypochlorite and its effects on selected mineral constituents. *Soil Sci. Soc. Am. Proc.*, 34, 755–758
- Omueti JAI (1980) Sodium hypochlorite treatment for organic matter destruction in tropical soils of Nigeria. *Soil Sci. Soc. Am. J.*, 44, 878–880
- Sequi P and Aringhieri R (1977) Destruction of organic matter by hydrogen peroxide in the presence of pyrophosphate and its effect on soil specific surface area. *Soil Sci. Soc. Am. J.*, 41, 340–342
- Visser SA and Caillier M (1988) Observations on the dispersion and aggregation of clays by humic substances. I – Dispersive effects of humic acids. *Geoderma*, 42, 331–337
- Vodyannitskii Yu N, Trukhin VT and Bagina OL (1989) The action of perhydral upon iron oxides in soil. *Dokuchzer soil Sci. Inst. (Moscou)*, 1, 20–21

### **Eliminate Organo-Minerals Compounds**

- Harward ME, Theisen AA and Evans DD (1962) Effect of iron removal and dispersion methods on clay mineral identification by X-Ray diffraction. *Soil Sci. Soc. Am. Proc.*, 26, 535–541
- Mehra OP and Jackson ML (1960) Iron oxide removal from soils and clays by a dithionite-citrate system buffered with sodium bicarbonate. In *Clays and Clay Minerals. Proc. Seventh Conf. Natl Acad. Sci. Natl Res. Council. Pub.*, 237–317

### **Eliminate Soluble Salts – Gypsum**

- Rengasamy P (1983) Clay dispersion in relation to changes in the electrolyte composition of dialysed red-brown earth. *J. Soil Sci.*, 34, 723–732
- Rivers ED, Hallmark CT, West LT and Drees LR (1982) A technique for rapid removal of gypsum from soil samples. *Soil Sci. Soc. Am. J.*, 46, 1338–1340

### **Suspension – Dispersion – Flocculation**

- Balli P (1965) Critères de la qualité de la suspension en vue de l'analyse granulométrique. *Science du sol*, 1, 15
- Bartoli F, Burtin G and Herbillon AJ (1991) Disaggregation and clay dispersion of oxisols: Na Resin, a recommended methodology. *Geoderma*, 49, 301–317
- Brewster GR (1980) Effects of chemical pretreatment on X-Ray powder diffraction characteristics of clay minerals derived from volcanic ash. *Clays Clay Miner.*, 28, 303–310
- Colmet-Daage F, Gautheyrou J, Gautheyrou M, Kimpe C de (1972) Dispersion et étude des fractions fines des sols à allophane des Antilles et

- d'Amérique latine. 1ère partie: Techniques de dispersion. *Cah. Orstom, Sér. Pédol.*, Vol. X(2), 169–191
- Demolon A and Bastisse E (1935) Sur la dispersion des colloïdes argileux. Applications à leur extraction. *Annales Agronomiques*, 1–15
- Dong A, Chesters G and Simsman GV (1983) Soil dispersibility. *Soil Sci.*, 136, 208–212
- Egashira K (1981) Flocculation of clay suspensions separated from soils of different soil type. *Soil Sci. Plant Nutr.*, 27, 281–287
- Forsyth P, Marcelja S, Mitchell DJ and Ninham BW (1978) Stability of clay dispersions. In *Modification of Soil Structure.*, Emerson, Bond, Dexter Ed. Wiley, New York. 2, 17–25
- Goldberg S and Forster HS (1989) Flocculation of reference clays and arid soil clays as affected by electrolyte concentration, exchangeable section percentage, sodium adsorption ratio, pH and clay mineralogy. *Annual Meeting – Clay Minerals Society*, 26, 35
- Gupta RK, Bhumbra DK and Abrol IP (1984) Effect of sodicity, pH, organic matter and calcium carbonate on the dispersion behavior of soils. *Soil Sci.*, 137, 245–251
- Keren R (1991) Adsorbed sodium fraction's effect on rheology of montmorillinite–kaolinite suspensions. *Soil Sci. Soc. Am. J.*, 55, 376–379
- Manfredini T, Pellacani GC, Pozzi P and Corradi AB (1990) Monomeric and oligomeric phosphates as deflocculants of concentrated aqueous clay suspensions. *Appl. Clay Sci.*, 5, 193–201
- Miller WP, Frenkel H and Newman KD (1990) Flocculation concentration and sodium/calcium exchange of kaolinitic soil clays. *Soil Sci. Soc. Am. J.*, 54, 346–351
- Ohtsubo M and Ibaraki M (1991) Particle-size characterization of flocs and sedimentation volume in electrolyte clay suspensions. *Appl. Clay Sci.*, 6, 181–194
- Oreshkin NG (1979) Device for tating suspension samples for the particle-size analysis of soils. *Soviet Soil Sci.*, 4, 136–138
- Reddy SR and Fogler HS (1981) Emulsion stability: determination from turbidity. *J. Colloid Interface Sci.*, 79, 101–104
- Reddy SR, Fogler HS (1981) Emulsion stability: delineation of different particle loss mechanisms. *J. Colloid Interface Sci.*, 79, 105–113
- Robinson GW (1933) The dispersion of soils in mechanical analysis. *Bur. Soil Sci. Tech. Commun.*, 26, 27–28
- Shaviv A, Ravina I and Zaslavsky P (1988) Flocculation of clay suspensions by an anionic soil conditioner. *Appl. Clay Sci.*, 3, 193–203

### **Ultrasonic Dispersion**

- Arustamyants YEI (1990) Optimizing the ultrasonic preparation of soils for particle-size analysis. *Pochvovedeniye*, 12, 55–68

- Busacca AJ, Aniku JR and Singer MJ (1984) Dispersion of soils by an ultrasonic method that eliminates probe contact. *Soil Sci. Soc. Am. J.*, 48, 1125–1129
- Edwards AP and Bremner JM (1967) Dispersion of soil particles by sonic vibrations. *J. Soil Sci.*, 18, 1
- Feller C, Burtin G and Herbillon A (1991) Utilisation des résines sodiques et des ultra-sons dans le fractionnement granulométrique de la matière organique des sols. Intérêt et limites. *Science du sol*, 29, 77–93
- Gregorich EG, Kachandski RG and Voroney RP (1988) Ultrasonic dispersion of aggregates: distribution of organic matter in size fractions. *Can. J. Soil Sci.*, 68, 395–403
- Hinds AA and Lowe LE (1980) Dispersion and dissolution effects during ultrasonic dispersion of gleysolic soils in water and in electrolytes. *Can. J. Soil Sci.*, 60, 329–335
- Hinds AA and Lowe LE (1980) The use of an ultrasonic probe in soil dispersion and in the bulk isolation of organo-mineral complexes. *Can. J. Soil Sci.*, 60, 389–392
- Ilnicki P and Matelska U (1984) Ultrasound application for dispersion of soil samples for particle size analysis. *Rozniki Gleboznaweze*, 35, 15–24
- Mikhail EH and Briner GP (1978) Routine particle size analysis of soils using sodium hypochlorite and ultrasonic dispersion. *Aust. J. Soil Res.*, 16, 241–244
- Minkin MB, Mulyar IA and Mulyar AI (1985) An ultrasonic method of analysing of water extracts from soils. *Pochvovedeniye*, 3, 136–140
- Moen DE and Richardson JL (1984) Ultrasonic dispersion of soil aggregates stabilized by polyvinyl alcohol and T 403-glyoxal polymers. *Soil Sci. Soc. Am. J.*, 48, 628–631
- Morra MJ, Blank RR, Freeborn LL and Shafil B (1991) Size fractionation of soil organo-mineral complexes using ultrasonic dispersion. *Soil Sci.*, 4, 294–303
- Schulze DG and Dixon JB (1979) High gradient enzymatic separation of iron oxides and other magnetic minerals from soils clays. *Soil Sci. Soc. Am. J.*, 43, 793–799

### Pipette Method

- Andreasen AHM and Andersen J (1930) Etude de l'influence de la dilution sur les résultats de l'analyse granulométrique par sédimentation. *Kolloid Z.*, 50, 217
- Bloom PR, Meter K and Crum JR (1985) Titration method for determination of clay-sized carbonates. *Soil Sci. Soc. Am. J.*, 49, 1070–1073
- Godse NG and Sannigrahi AK (1988) Comparative study on methods of particle-size analysis for vertisols. *J. Indian Soc. Soil Sci.*, 36, 780–783

- Indorante SJ, Follmer LR, Hammer RD and Koenig PG (1990) Particle-size analysis by a modified pipette procedure. *Soil Sci. Soc. Am. J.*, 54, 560–563
- Krumbein WC (1935) A time chart for mechanical analyses by the pipette method. *J. Sediment. Petrol.*, 5, 93–95
- Miller WP and Miller DM (1987) A micro-pipette method for soil mechanical analysis. *Commun. Soil Sci. Plant Anal.*, 18, 1–15
- Oreshkin NG (1979) Device for taking suspension samples for the particle-size analysis of soils. *Soviet Soil Sci. (Pochvovedeniye)*, 4, 136–138
- Richter M and Svartz H (1984) Analisis granulometrico de suelos en escala reducida. *Ciencia del suelo*, 2, 1–8
- Shetron SG and Trettin CC (1984) Influence of mine tailing particle density on pipette procedures. *Soil Sci. Soc. Am. J.*, 48, 418–420

### Hydrometer Method

- American Society for Testing and Materials (1972) Standard test method for particle-size analysis of Soils – D 422-463. *Annual Book of ASTM*, 1985
- Barthokur NN (1986) Clay fraction determinations with Beta-ray gauge. *Commun. Soil Sci. Plant Anal.*, 17, 533–545
- Fontes LEF (1982) A new cylinder for sedimentation of soil suspension in the determination of the clay fraction by the hydrometer method. *Revista brasileira de Ciencia do Solo*, 6, 152–154
- Gee GW and Bauder JW (1979) Particle size analysis by hydrometer, a simplified method for routine textural analysis and a sensitivity test of measurement parameters. *Soil Sci. Soc. Am. J.*, 43, 1004–1007
- Johnson JE, Bowles JA and Knuteson JA (1985) Comparison of pretreatments and dispersants on clay determination by the hydrometer method. *Commun. Soil Sci. Plant Anal.*, 16, 1029–1037
- Sur HS and Kvkal SS (1992) A modified hydrometer procedure for particle size analysis. *Soil Sci.*, 153, 1–4

### Instrumental Methods

- Arustamyants YEI (1992) Instrumental methods for determining the particle-size composition of soils. *Scr. Tech.*, 101–117
- Barth, HG (1984) *Modern Methods of Particle Size Analysis.*, Wiley, New York, 209 pages
- Cooper LR, Haverland RL, Hendricks DM and Knisel WG (1984) Microtrac particle-size analyzer: an alternative particle-size determination method for sediment and soil. *Soil Sci.*, 132, 138–146

- Devyatykh GG, Karpov YU A, Krylov VA and Lazukina OP (1987) Laser-ultra microscopic method of determining suspended particles in high-purity liquids. *Talanta*, 34, 133–139
- Hendrix WP and Orr C (1970) Automate sedimentation size analysis instrument. *Particle Size Analysis*, 133–146
- Hutton JT (1955) A method of particle size analysis of soils (balance de Plummet). *CSIRO, Report*, 11/55.
- Karsten JHM and Kotze WAG (1984) Soil particle analysis with the gamma alternation technique. *Commun. Soil Sci. Plant Anal.*, 15, 731–739
- Kirkland JJ and Yau WW (1983) Simultaneous determination of particle size and density by sedimentation field flow fractionation (FFF). *Anal. Chem.*, 55, 2165–2170
- Kirkland JJ, Rementer SW and Yav WW (1981) Time-delayed exponential field-programmed sedimentation field flow fractionation for particle-size distribution analysis. *Anal. Chem.*, 53, 1730–1736
- Marshall TI (1956) A Plummert Balance for measuring the size distribution of soil particles. *Aust. J. Appl. Sci.*, 7, 142–147
- Mc Connel ML (1981) Particle size determination by quasielastic light scattering. *Anal. Chem.*, 53, 1007–1018
- Novich BE and Ring TA (1984) Colloid stability of clays using photron correlation spectroscopy. *Clays Clay Miner.*, 32, 400–406
- Oakley DM and Jennings BR (1982) Clay particle sizing by electrically induced birefringence. *Clay Miner.*, 17, 313–325
- Pennington KL and Lewis GC (1979) A comparison of electronic and pipet methods for mechanical analysis of soils. *Soil Sci.*, 28, 280–284
- Rybina VV (1979) Use of conductimetry for the determination of the particle-size composition of soils. *Pochvovedeniye*, 7, 134–138
- Salbu B, Bjornstad HE, Linstrom NS, Lydersen E (1985) Size fractionation techniques in the determination of elements associated with particulate or colloidal material in natural fresh waters. *Talanta*, 32, 907–913
- Svarovsky L and Allen T (1970) Performance of a new X-Ray sedimentometer. *Particle Size Analysis*, 147–157
- Yang KC and Hogg R (1979) Estimation of particle size distributions from turbidimetric measurements. *Anal. Chem.*, 51, 758–763
- Yonker CR, Jones HK and Robertson DM (1987) Non aqueous sedimentation field flow fractionation. *Anal. Chem.*, 59, 2574–2579



## Fractionation of the Colloidal Systems

### 3.1 Introduction

The identification and the quantification of the finest soil fractions are essential to explain the transformation of minerals, as these fractions are directly related to pedogenesis and, in agronomy, to potential fertility.

The nature and properties of these particles are of interest to agronomists (soil chemistry and physics: textural class, fertility, pore system, water storage, cohesion, slaking, etc.), soil scientists (pedogenesis, characterization and functioning of soils, lithological nature, products of alteration, etc.), geologists of the quartz period (sedimentology: origin of wind, marine, or lake deposits, typology of volcanic ash and heavy minerals, etc.), mineralogists and geochemists (assessments of alterations, mineral stocks liable to alteration, origin and nature of materials, etc.).

The majority of the instrumental methods used for the determination of the texture of the soils (cf. Chap. 2) do not enable isolation of the fractions measured, but discontinuous methods based on sedimentation do enable reuse of the sand, silt and clay fractions, as long as no contaminating dispersants are used. In practice, the limit of simple gravity methods is fractionation up to approximately 1  $\mu\text{m}$ . Under certain conditions, ultracentrifugation makes it possible to reach the nanometric domain.

Fractions below 0.5  $\mu\text{m}$  contain practically no more quartz or primary minerals. Fractions below 0.2  $\mu\text{m}$  enable better characterization of argillization horizons. This threshold, proposed around 1931, was at that time regarded as representative of the limit of "the colloidal state" because after elimination of oxides and hydroxides, the fraction presented homogeneous chemical composition comparable to a mono-dispersed system, i.e. the same exchange capacity, the same structural composition of the 0.2  $\mu\text{m}$ , 0.1  $\mu\text{m}$ , and 0.05  $\mu\text{m}$  particles.

When the final purpose of fractionation of the particles is physical or chemical determination, the different treatments that are carried out to put

the very fine fractions in suspension can differ considerably from the methods used for textural analysis because secondary products cannot be significantly modified, in particular clays and oxides. In certain cases, it is possible to simply put fine fractions in suspension by ultrasound and to use ion exchange resin for desaturation. Dispersants of the hexametaphosphate or pyrophosphate type (cf. Chap. 2) should not be used.

The criteria of Stokes law are suitable for centrifugation and the same problems will occur with particles whose speed is changing. By quantitatively isolating all the fractions, chemical and physical determination can be refined, and more detailed distribution curves established for the particle continuum.

## 3.2 Fractionation by Continuous Centrifugation

### 3.2.1 Principle

After the treatments needed to isolate the primary particles (cf. Chap. 2), the sample is put in suspension for later analyses using a non-contaminating dispersant. The fine fractions (less than 2  $\mu\text{m}$ ) are first separated from the coarse fractions by several siphoning operations, which take the falling time of the silts into account. Five to six siphonings are sufficient for a quantitative recovery.

Because of the volumes being dealt with, fractionation of the fine phases is carried out in a centrifuge with continuous inputs per ascensum made up of a vertical tube able to rotate at 52,000g (Fig. 3.1a). A transfer paper placed inside the tube makes it possible to collect the particles that sediment on the wall (Fig. 3.1b). The effluents are collected at the top of the bowl by a single or double chute (depending on the model).

The suspension does not completely fill the tube but forms a concentric ring, the centre being a cylinder of air,  $R_1$  (Fig. 3.1b). The thickness of the film of suspension is  $R_2 - R_1$ . The particles gradually sediment on the walls of the bowl as a function of their density and of their diameter. They follow a parabolic trajectory starting from the point of deposit of the effluents.

The radial application of the centrifugal force is accompanied by a vertical force. A particle of a given diameter and density will deposit according to the resulting force vector. Viscosity can be modified in the course of centrifugation by variations in temperature, the influence of the

pressures created at high speeds and possibly by the presence of thixotropic materials. With soils containing allophanes, it is sometimes possible to observe flocculation if the dispersing medium is not homogeneous throughout the iterative extractions, or due to loss of part of the swelling water. It should be noted that fibres of imogolite, mica plates, tests of diatoms, etc. do not follow Stokes' law and are separated in a random way.

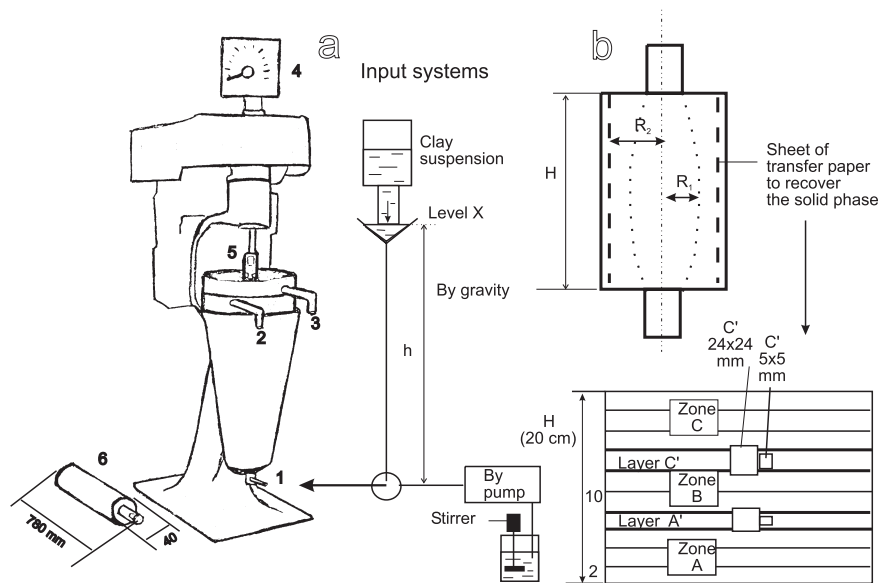

**Fig. 3.1.** (a) Uninterrupted ultracentrifuge system using compressed air – 45,000g (1 input nozzle for injection; 2, 3 exit chutes for effluents; 4 rev counter; 5 connecting with bowl; 6 centrifugation bowl). (b) Centrifugation bowl with transfer paper for recovery (division of the delivery points according to procedure in “Fractionation in Four Phases”).

The component perpendicular to the axis can be easily calculated starting from Stokes law (cf. Sect. 3.2.2), however, it should be noted that with centrifugation, the deposit rate of the particles is not constant due to variations in the intensity of the field of centrifugation which depend on the diameter of the rotor. The vertical component must be calculated as a function of the flow, which itself depends on the input, on the diameter of the injector channel, and on the diameter of the ring outfall.

In practice, the formulas for computation of the standard Sharples centrifuge cannot be rigorously applied at the bottom and the top of the bowl because of turbulence at these levels (injector channel and deflector at the bottom, ring outfall at the top). Too much deposit can also modify the radius at the bottom of the bowl. However, the height of the deposit can be determined with sufficient accuracy by following a strict procedure. It may be advantageous to collect a relatively small quantity of sediments (not exceeding 10 g) at each treatment.

Under certain operating conditions (number of revolutions, flow, etc.), the finest particles can pass across the bowl without sedimentation because the time of passage is insufficient for the centrifugal force to transfer them to the wall. However, if one of the variables is modified, for example, the flow is slowed down by changing the input tube; these particles can also be collected. With a low flow, separation is differentiated more satisfactorily than with a high flow. For satisfactory separation, it is better to use tubes with a small diameter and a not too high charge. For simple separation (for purification by enrichment) a 2 mm tube and a higher charge (75 cm for example) can be used. The drain may still contain fine particles depending on the number of revolutions applied. The system makes it possible to use the drain again with a lower flow rate and to collect the solid fraction on a new transfer paper placed in the bowl.

**Table 3.1.** Deposit of particles of various minerals by continuous ultracentrifugation (flow 730 mL min<sup>-1</sup> speed 20,000g, viscosity 1)

mineral	density	diameter of particles which sediment at a height of 10 cm in the bowl (in $\mu\text{m}$ )
opal	2.10	360
gibbsite	2.40	320
quartz	2.65 (average used for the soils)	280
hematite	5.26	115

It is important to choose a speed and a flow which allow non-uniform deposit to obtain satisfactory classification of the particles. It is difficult to include all the variables in the calculation, and the forecast will be uncertain if the average density of 2.65 used for the soils is not regular. Indeed, if a mixture of minerals of different densities is used whose

micro-particles are individualized in the suspension, very different particles with the same diameter will be found at any level (Table 3.1).

At one time, it seemed that graphic methods would be both adequate and fast. Saunders (1948) studied a nomographical representation applicable to continuous ultracentrifugation (1936–1940), and was able to determine that certain factors in the equation of Hauser and Lynn (cf. Sect. 3.2.2) remained constant for a given procedure thus allowing simplification and a move to a nomographical representation with five variables that could be extended to six variables using the method of Davis (1943).

It thus became possible to rapidly determine the height of deposit of elementary particles with different densities but the same diameter.

### 3.2.2 Theory

The method of Hauser and Lynn (1940) to calculate the size of the particles is one of the most powerful for use with an ultracentrifuge with continuous input. The equation makes it possible to express the vertical distance ( $Y$  in cm) from the deposit of a particle of a given size, measured starting from the bottom of the bowl of the centrifugal machine by

$$Y = C \frac{18 K_1 Q \eta}{\pi(R_2^2 - R_1^2)D^2 \omega^2 \delta\rho} \quad (3.1)$$

where

$$C = \frac{R_2^2}{2} \ln \frac{R_2}{X_0} - \frac{R_1^2}{2} \left( \ln \frac{R_2}{X_0} \right)^2 + \frac{X_0^2 - R_2^2}{4} \quad (3.1')$$

$R_2$  = distance from the axis of rotation to the side of the bowl (cm);

$R_1$  = distance from the axis of rotation on the surface of the liquid in the bowl (cm);

$X_0$  = distance from the axis of rotation at which a given particle must start to deposit on the side of the bowl (cm);

$K_1$  = function of the construction of the bowl ( $\text{cm}^{-2}$ )

$$= \frac{R_2^2 - R_1^2}{(3/4)R_1^4 + (1/4)R_2^4 - R_1^2 R_2^2 - R_1^4 \ln(R_1/R_2)} \quad (3.2)$$

$Q$  = throughput speed (flow of the suspension  $\text{mL s}^{-1}$ );

$\eta$  = viscosity of the dispersion medium (poise);

$D$  = sphere equivalent diameter of the particles which sediment at  $Y$  cm;

$\omega$  = angular speed of rotation (radian per second);

$\delta\rho$  = difference in density between the dispersed particles (Table 3.2) and the medium of dispersion ( $\text{g mL}^{-1}$ ).

Under standard conditions (flow and range of the particles), the equation of Hauser and Lynn is related to  $X_0$  and  $D$ . For particles of a given diameter, the equation is a function of only  $X_0$ , which makes it possible to plot the curve of  $C$  vs  $Y$ . On this basis, Saunders (1948) established a system of monograms which allows the equivalent diameter of the particles settling in the bowl to be calculated with satisfactory precision.

By defining the constant  $A = \frac{18 K_1}{\pi(R_2^2 - R_1^2)}$ , (3.1) becomes:

$$\frac{Y}{C} = \frac{A \eta Q}{D^2 \omega^2 \delta\rho} \quad (3.3)$$

**Table 3.2.** Specific density of some minerals (average density used for the soils = 2.65)

	minerals	density		minerals	density
Al	boehmite $\text{AlO}(\text{OH})$	3.07	Fe	akaganeite $\text{Fe}^{3+}\text{O}(\text{OH}, \text{Cl})$	3.55
	diaspore $\text{AlO}(\text{OH})$	3.40		goethite $\text{FeO}(\text{OH})$	4.0– 4.4
	bayerite $\text{Al}(\text{OH})_3$	2.53		lepidocrocite $\text{FeO}(\text{OH})$	3.85
	gibbsite $\text{Al}(\text{OH})_3$	2.40		hematite $\text{Fe}_2\text{O}_3$	5.26
	nordstrandite $\text{Al}(\text{OH})_3$	2.43		maghemite $\text{Fe}_2\text{O}_3$	5.10
	corundum $\text{Al}_2\text{O}_3$	4.10		magnetite $\text{Fe}_3\text{O}_4$ ( $\text{Fe}^{2+}\text{Fe}_2^{3+}\text{O}_4$ )	5.17
	akdalaite $4\text{Al}_2\text{O}_3, \text{H}_2\text{O}$	3.68		ilmenite $\text{FeO}-\text{TiO}_2$	4.44– 4.90
	bauxite $\text{Al}_2\text{O}_3, 2\text{H}_2\text{O}$	2.55		pyrite $\text{FeS}_2$	5.02
Mn	manganosite $\text{MnO}$	5.36	clays	kaolinite	2.60
	pyrolusite $\text{MnO}_2$	5.06		halloysite	2.10
	ramsdelite $\text{MnO}_2$	4.50		dickite	2.60
	manganite $\text{MnO}(\text{OH})$	4.33		montmorillonite	2–3.00
	feitknechtite $\text{MnO}(\text{OH})$	3.80		nontronite	2–3.00
	groutite $\text{MnO}(\text{OH})$	4.15		beidellite	2–3.00

	pyrochlorite $Mn(OH)_2$	3.25	micas: biotite	3.00
	nsutite $Mn^{+2}Mn^{+4}O_2(OH)_2$	4.50	phlogopite	2.80
	hausmanite $Mn^{+2}Mn^{+3}O_4$	4.84	glauconite	2.60
			muscovite	2.80
			illite	2.6– 2.9
Si	coesite $SiO_2$	2.93	feldspar white feldspar $Na_2O, Al_2O_3, 6SiO_2$	2.61– 2.64
	cristobalite $SiO_2$	2.33	andesine $(CaO, Na_2O, Al_2O_3, 4SiO_2)$	2.65– 2.69
	quartz $SiO_2$	2.65	oligoclase $NaAlSi_3O_8 + CaAl_2Si_2O_8$	2.62– 2.67
	tridymite $SiO_2$	2.26	orthoclase $KAlSi_3O_8$	2.56
	silhydrite $3SiO_2, H_2O$	2.14		
	opal $SiO_2, nH_2O$	2.10		
Ca	calcite $CaCO_3$	2.7–2.9		
	aragonite $CaCO_3$	2.9	gypsum $CaSO_4, 2H_2O$	2.3

This equation can be treated using the “nomographical method” according to Davis (1943) and gives a value of  $Y/C$  to each value of  $Y$ . If  $\eta$  is expressed in centipoises,  $Q$  in  $mL \min^{-1}$ ,  $D$  in  $nm$ ,  $\omega$  in  $rotations \min^{-1}$ ,  $\delta\rho$  in  $g mL^{-1}$ ,  $Y$  in  $cm$  and  $C$  in  $cm^2$  the equation is written:

$$\frac{Y}{C} = 1.52 \times 10^{12} \frac{A \eta Q}{D^2 \omega^2 \delta\rho} \quad (3.3')$$

This equation can be reduced to four equations with three variables and three parameters  $\alpha$ ,  $\beta$  and  $\gamma$ :

$$\begin{aligned} \log \alpha &= \log \eta - \log \frac{Y}{C} \\ \log \beta &= \log \delta\rho - 2 \log \omega \\ \log \gamma &= \log \alpha + \log \beta \\ 2 \log D &= \log \gamma + \log Q \end{aligned}$$

The nomographical method of Davis (1943) provides a solution by tracing four lines which represent the solution of one of these equations (Fig. 3.2). Constant  $A$  is included starting from a scale representing a numerical solution of (3.3'). For example, for a centrifugation tube where  $R_1 = 2.175 \text{ cm}$  and  $R_2 = 0.735 \text{ cm}$ , constant  $A$  is equal to  $2.44 \times 10^{12}$ . The final formula for direct calculation will be:

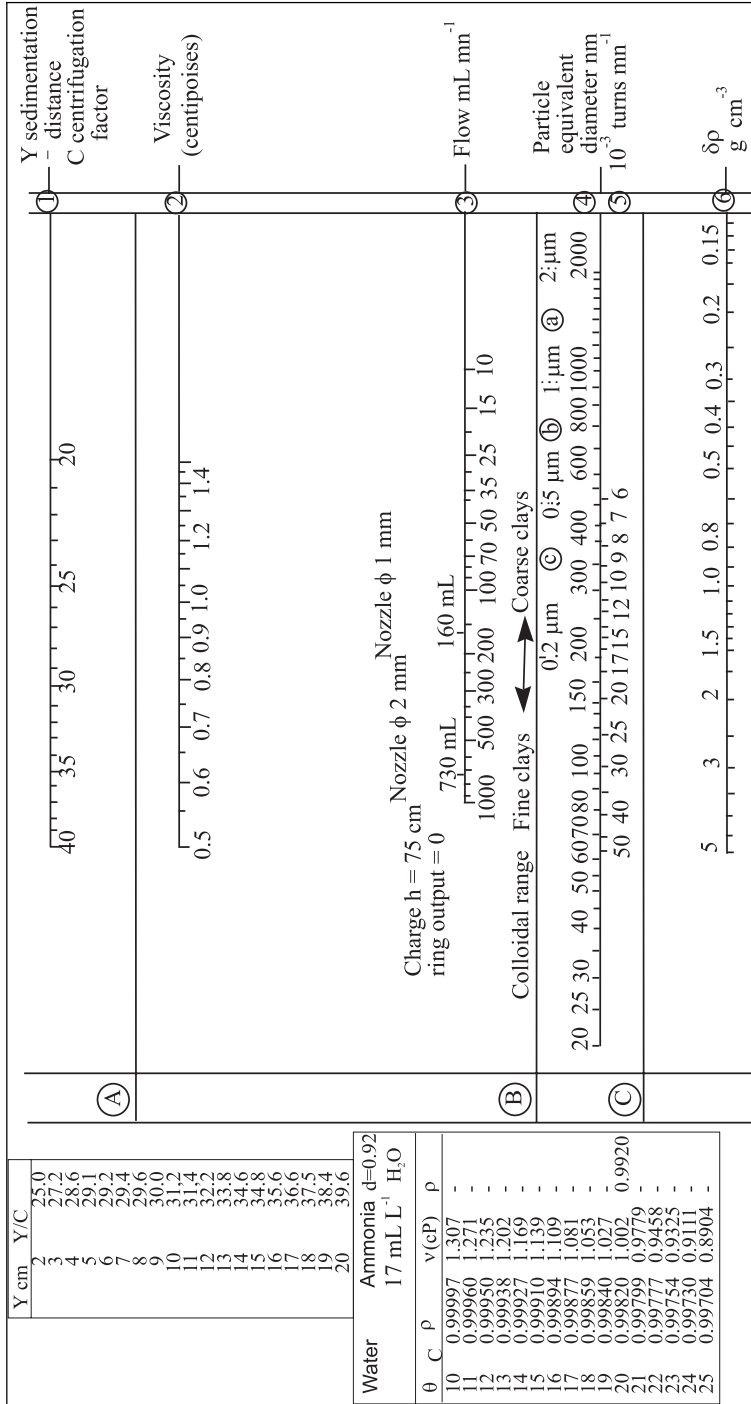

**Fig. 3.2.** Nomograph: (1) trace 1-2 while cutting A, (2) trace 5-6 while cutting C, (3) trace AC while cutting B, (4) trace B-3 while cutting 4, the equivalent diameter is obtained in nanometres of the particles deposited at the height selected (Y) in the centrifugation bowl



$$D = 2.44 \times 10^{12} \frac{\eta Q}{(\omega^2 \delta \rho Y / C)^{1/2}}$$

with value  $Y/C$  for the height  $Y$  and the units of (3.3').

### 3.2.3 Equipment and reagents

#### Equipment

- Standard Sharples T1 ultracentrifuge with continuous circulation and a turbine equipped with an 8RY stainless steel bowl with a diameter of 44 mm
- 6 L Pyrex bottle with broad neck with stopper
- Stopper pierced with a glass tube with an interior diameter of 10 mm cut in bevel (for input of suspension)
- 12 cm Conical forceps with jaw punts (to retrieve the transfer paper)
- Small plastic spatula
- Stylet (to lift the transfer paper for removal with the grip)

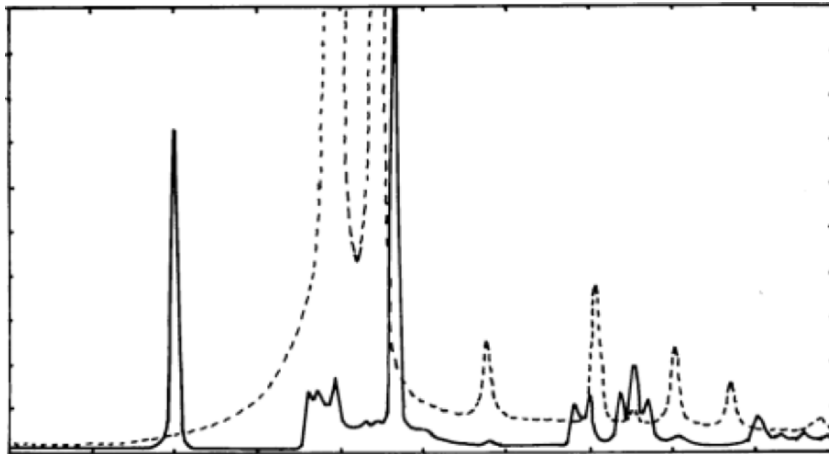

**Fig. 3.3.** Spectra of X-ray diffraction:

- ..... dashed line = Tymek support alone,
- solid line = kaolinite on Tymek support (sufficiently thick to avoid contamination).

– Plastic transfer papers with frosted interior (Integraph, Invar 75  $\mu\text{m}$ , Kodatrace, Chronaflex or Tymek Dupont de Nemours) 204 $\times$ 150 mm sheets; the thickness of this support must be homogeneous, it must have a constant weight per surface unit, be resistant to water, have a flat DRX spectrum or well-defined peaks outside the zones of measurement of the sample (Fig. 3.3)

– 1/10 mg balances

– Set of suitable pillboxes and micro-bottles (plastic, single use, Fig. 3.4)

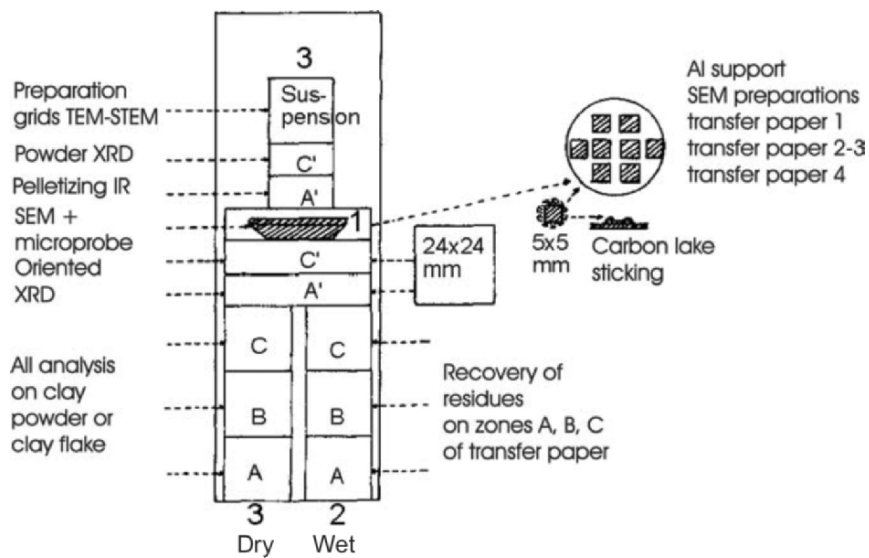

**Fig. 3.4.** Example of system for processing the fine fractions separated on transfer paper (Fig. 3.1), 1 = regrouping on MEB support, 2 = only andisols–histosols, 3 = pillbox, micro-bottles

– Aluminium supports for scanning electron microscopy

### Reagents

Cf. Chap. 2

### 3.2.4 Procedure

#### **Standard Continuous Ultracentrifugation**

- Choose the diameter of the injector channel, the diameter of the ring outfall, and the height  $h$  of level  $X$  (Fig. 3.1).
- Place in the bowl of the centrifuge a tared transfer paper with the selected cutting plan drawn on the back (the weight of the transfer paper  $P_0$  makes it possible to calculate the weights  $P_{01}$ ,  $P_{02}$ ,  $P_{03}$ , corresponding to the respective surfaces of zones A, B, C in Fig. 3.1).
- Suspend the bowl on the rotor and place the container for the recovery of the effluents under the chute.
- Fill the funnel to a constant level  $X$  with the same dispersant as the samples, taking care not to trap air in the adduction tube.
- Homogenize the bottle containing the clay suspension.
- Remove an aliquot of 2 mL (for grid TEM).
- Rock the bottle on the funnel; switch on the centrifugal machine at the selected speed.
- Place the injector channel under the bowl and open the input cock.

When all the liquid has gone, add 200 mL of the dispersion liquid to drive out all the suspension remaining in the bowl (approximately 150 mL). Adjust to a maximum speed of 52,000g for 2–3 min to stabilize the deposit.

Disconnect the input tube and stop the centrifuge (collect the liquid remaining in the tube in a crystallizer and discard it if it is clear).

Remove the transfer paper carefully by holding the bowl obliquely to not contaminate the top of the bowl with coarse particles. Spread the paper out flat. Recover any trace of deposit on the deflector and add it to the bottom of the transfer paper.

Leave to dry at room temperature (if necessary recover wet clay with a spatula and place it on the appropriate zone of the transfer paper before drying).

Weigh the transfer paper and dried clay:  $P_1$ . Deposited clay corresponds to  $P_1 - P_0$

Cut the transfer paper following the plan on the back. This makes it possible to weigh zones A, B, C (Fig. 3.1), i.e.  $P_{11}$ ,  $P_{12}$ ,  $P_{13}$ .

#### **Continuous Fractionation of the Colloidal Particles**

The complex and time-consuming method of Hauser and Lynn (1940) enables isolation of the fine fractions from a suspension (Fig. 3.5) and the

establishment of cumulative curves of distribution of the particles which can nowadays be accomplished continuously with an automatic apparatus for the measurement of particle size (cf. Chap. 2). This type of apparatus has two centrifugation speeds and seven different flows, i.e. 11 passages in the centrifuge to classify particles between 1  $\mu\text{m}$  and 24 nm with a Sharples continuous centrifuge with a turbine.

This method cannot be used for routine tasks because of the length of the operations, or for fragile samples that are difficult to maintain in suspension like soils with allophane.

The method is nevertheless useful in metallogeny to identify the enriched fractions (release mesh). The suspensions must be diluted to accomplish fractionation without an awkward piston effect.

### ***Fractionation in Four Phases***

The method of Gautheyrou and Gautheyrou (1967) is based on the equations of Hauser and Lynn and the nomographical system of Saunders (cf. Sect. 3.2.2). The transfer paper shown in Fig. 3.1b is an example of one layout suited to the needs of mineralogical analysis, but other alternatives are possible considering that the particles deposited in a horizontal plane are similar and that the solid phase varies upwards.

Zones A, B, C (Figs. 3.1 and 3.4) allow separation of the particle size phases whose significance depends on the procedure used (these fractions are used for chemical and physical analyses). Zones A' and C' (Figs. 3.1 and 3.4) enable fractions to be isolated for X-ray diffraction either after crushing for powder diagrams, or pretreatments, or directly for oriented diagrams on the  $24 \times 24 \text{ mm}^2$  (cf. Chap. 4). After sticking the  $5 \times 5 \text{ mm}^2$  on a suitable support with carbon lacquer (cf. Chap. 8) they can be used for electronic scan microscopy with EDX microanalysis.

After dilution and preparation of the grids, a 1 mL sample of each suspension enables observation by transmission electronic microscopy (cf. Chap. 8).

### ***Adjustments***

Charge  $h$ : 75 cm (Fig. 3.1); temperature: 20°C; tube: 2 mm diameter; flow:  $730 \text{ mL min}^{-1}$ ; time of passage in the bowl: 15 s; average density: 2.65; ring outfall: 0.

Charge, flow, temperature remain constant; only the speed is modified at each centrifugation: 6,000, 10,000, 25,000, 50,000g (at 50,000g, if the sample contains very fine particles, it may be necessary to use a 1 mm tube corresponding to a flow of 160 mL per minute to fix all the very fine phase).

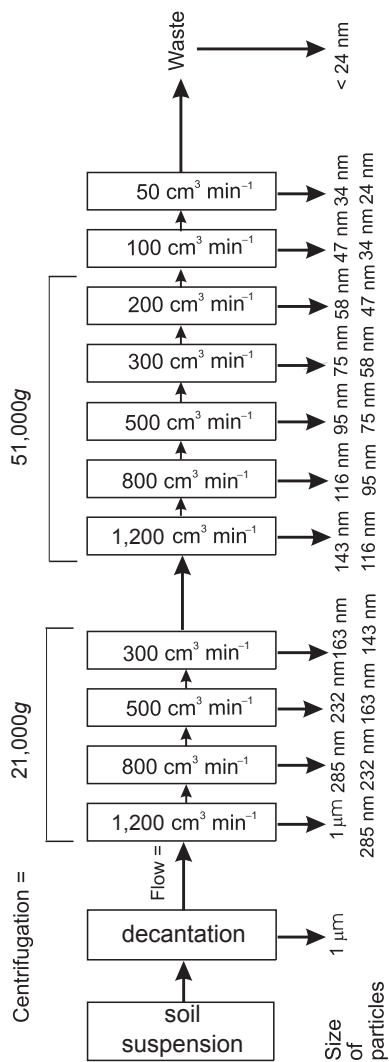

**Fig. 3.5.** Diagram of fractionation by method "Continuous Fractionation of the Colloidal Particles"

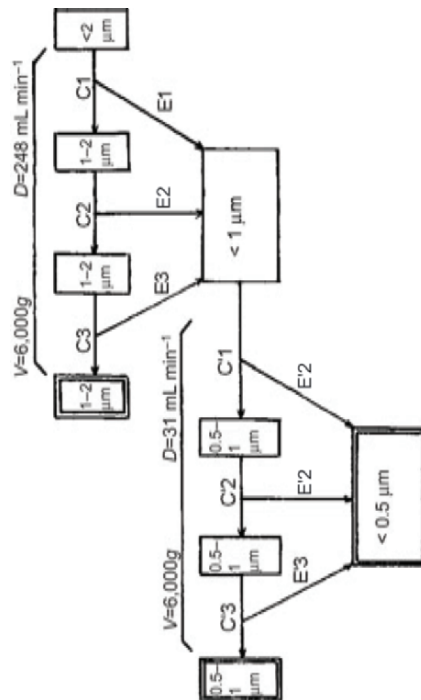

**Fig. 3.6.** Diagram of fractionation by method "Fractionation with Different Flows"

**Fraction 2–1  $\mu\text{m}$** 

This fraction is separated at a centrifugation speed 6,000g and recovered on the first transfer paper (TP): weight TP alone:  $P_{01}$ , TP + deposit:  $P_{11}$ , weight clay: 2–1  $\mu\text{m}$ :  $P_{11}-P_{01} : P_{c1}$  Express in % compared to the initial weight of soil.

**Fraction 1–0.5  $\mu\text{m}$** 

Recovered on the second TP at 10,000g:  $P_{c2}$

**Fraction 0.5–0.2  $\mu\text{m}$** 

On the third TP at 25,000g:  $P_{c3}$

**Fraction 0.2–0.05  $\mu\text{m}$** 

On the fourth TP at 50,000g and lower flow of  $160 \text{ mL min}^{-1}$ , 1 mm tube:  $P_{c4}$

**Clay < 0.05  $\mu\text{m}$** 

This very fine clay is contained in the last draining water and can be recovered by flocculation. This fraction is generally a clear extract that can be discarded because it contains the majority of the residual impurities of the reagents used for the initial preparation of clay. Electronic microscopy can also be used, but concentration by evaporation can result in risks of hydrolysis and neo-formation.

**Remarks**

If the deposit is too thick, irregular cracking can occur in clays with a high shrinkage coefficient, which makes it impossible to cut the  $5 \times 5 \text{ mm}^2$  for oriented XRD. In this case, the squares are not used but instead a sliver of clay is stuck down with carbon lacquer.

In certain soil samples the finest fractions are practically non-existent. In this case it is possible to stop at the second or the third centrifugation.

If major variations are observed between the coarsest phase and the finest phase, preparation and analyses of sub-samples should be performed progressively.

Certain studies may require conservation of part of fresh clay without drying. In this case, the transfer paper should have an additional vertical separation. Fresh clay should be recovered immediately at the outlet of the bowl with a plastic spatula and quickly stored in a pillbox. Quantification can be checked on the fraction which is dried but there is a risk of error due to transformations during drying.

The same method can also be used to:

- Separate and enrich two phases; for example two phases with the same mineral density but different particle size (micro-micas and coarser crystallized kaolinite).
- Separate two products of the same particle size but different density, for example aluminous products with a density <3.0 and ferrous or ferric products with a density of 4–5.
- Collect the particles of a given diameter and density on a narrow zone (metallogeny – separation meshes), etc.

Chlorite, vermiculite, or kaolinite enrichment is often observed in the coarse fractions. Well-crystallized kaolinite is generally present in fractions >0.5  $\mu\text{m}$ . Quartz and muscovite are almost eliminated in the fractions <0.5  $\mu\text{m}$ , which makes it possible “to clean” the spectra.

Gibbsite is mostly retained in the coarse fractions and is only present in very small amounts in the very fine phases.

Halloysite enrichment can be also observed, as well as enrichments in substances with short distance crystalline arrangement in fractions <0.5  $\mu\text{m}$  or 0.2  $\mu\text{m}$ , whereas well-crystallized kaolinite disappears.

Deferrization increases the smoothness of the particles revealing the incorporating effect of iron.

Studying the different fractions by X-ray diffraction enables observation of possible crystallochemical heterogeneity of the colloidal fraction and identification of mineral filiations which occurred during evolution and weathering. Minerals whose spectral signature is readable only above 5% (for example Sepiolite) can also be detected.

### ***Fractionation with Different Flows***

In this technique (Biological Centre of Pedology, Nancy, France), the clay suspension >2  $\mu\text{m}$  at a concentration not exceeding 1%, is subjected to an initial series of centrifugation at fixed speed and flows (Fig. 3.6).

A second series of centrifugation with a much lower flow (31  $\text{mL min}^{-1}$ ) makes it possible to separate the finer fractions. Thanks to repeated centrifugation and the weak concentration of the medium, the separation of the fractions is considered quantitative.

### **3.3. Pretreatment of the extracted phases**

Mineralogical analyses performed directly on total soil samples provide information on all the most abundant components, but do not allow

detection of the presence of low concentration phases because of the lack of sensitivity of the instrumental techniques and the occurrence of much interference. These low-concentration phases (<5 %), which can be highly significant in explaining certain processes of soil genesis, are masked by background noise even when they are above their threshold of detection.

It is thus necessary to eliminate interference and to concentrate the “mineralogical clay” phase.

Using a suitable fractionation method, clays are purified and concentrated and appear in a homoionic form:  $\text{NH}_4^+$ ,  $\text{Ca}^{2+}$ , or  $\text{H}^+$  depending on the case. As mineral cements and the organomineral links have been destroyed, it is possible to obtain satisfactory separation of the particles.

The use of ultrasound enables good separation of elementary particles, and complementary pretreatments can be performed on clays to allow the use of specific instrumental techniques.

Selective dissolution makes it possible to eliminate the iron oxides which can obstruct XRD (cf. Chap. 4), fluorescence with a copper tube) and DTA–TGA (cf. Chap. 7), oxidation  $\text{Fe}^{2+}$ ). Different pretreatments make it possible to carry out analyses using NMR, ESR, Mossbauer, etc.

Gels and substances that are amorphous to X-ray and have crystal lattices with short distance arrangement can be dissolved, enabling their quantification and the production of differential spectra (DXRD) to identify them.

Any calcium carbonate that is still present can be eliminated by complexing  $\text{Ca}^{2+}$  ions with a solution of normal EDTA.

Pretreatments also help improve the orientation of clays (which is disturbed by iron, for example in coatings), the intensity of the spectra of diffraction and the ratio of diffraction to background noise.

Clays often have to be studied after homoionic saturation by a cation (such as  $\text{Mg}^{2+}$  which regulates the adsorption of water by clays with an expansible interfoliaceous space, or  $\text{K}^+$  which limits the adsorption of water and thus the swelling of the layers).

Other treatments, like solvation by polar solvents, or the creation of complexes of intercalation, make it possible to identify certain clays. Heat treatments are also used specifically to cause the collapse of the lattices or to modify surface properties. These methods are described in detail in Chaps. 4–7.



## References

- Davis DS (1943) Empirical Equations and Nomography. Mc Graw Hill, New York, 1, 104–114
- Gautheyrou J and Gautheyrou M (1967) *Mode opératoire pour l'extraction et la purification de la fraction argileuse < 2 μm*. Notes de laboratoire, Orstom-Guadeloupe, mars 1968, 1–9, Orstom
- Hauser EA and Lynn JE (1940) Separation and fractionation of colloidal systems. *Ind. Eng. Chem.*, 32, 659–662
- Saunders E (1948) Nomograph for particle size determination with the Sharples supercentrifuge. *Anal. Chem.*, 20, 379–381

## Bibliography

- Atterberg A (1912) Die mechanische bodenanalyse und die klassifikation der mineralböden schwedens. *Intern. Mitt. Bodenk.*, 2, 312–342
- Coca Prados J and Bueno de las Heras J (1977) Dinamica de particulas en suspensions solido–liquido. I – Sedimentacion de particulas. *Ingeniera quimica*, 153–162
- Colmet-Daage F, Gautheyrou J, Gautheyrou M, Kimpe de C, Fusil G and Sieffermann G (1972) Dispersion et étude des fractions fines de sols à allophane des Antilles et d'Amérique latine. IIème partie : Modifications de la nature et de la composition de la fraction inférieure à 2 microns selon la taille des particules. *Cahiers Orstom, série. Pédol.*, X, 219–241
- Davis JM (1986) General retention theory for sedimentation Field-Flow-Fractionation. *Anal. Chem.*, 58, 161–164
- Essigton ME, Mattigod SV and Ervin JO (1985) Particles sedimentation rates in the linear density gradient. *Soil Sci. Soc. Am. J.*, 49, 767–771
- Gautheyrou J and Gautheyrou M (1982) Fractionnement des systèmes colloïdaux argileux par centrifugation continue. Notes laboratoire Orstom Bondy, 1–38
- Hauser EA and Reed CE (1936) Studies in thixotropy. I – Development of a new method for measuring particle-size distribution in colloidal systems. *J. Phys. Chem.*, 40, 1169–1182
- Horrocks M (2005) A combined procedure for recovering phytoliths and starch residues from soils, sedimentary deposits and similar materials. *J. Archaeological Sci.*, 32, 1169–1175
- Jackson ML, Whittig LD and Pennington RP (1949) Segregation procedure for the mineralogical analysis of soils. *Soil Sci. Soc. Am. Proc.*, 14, 77–81
- Jacobsen AE and Sullivan WF (1946) Centrifugal sedimentation method for particle size distribution. *Ind. Eng. Chem.*, 18, 360–364
- Jaymes WF and Bigham JM (1986) Concentration of iron oxides from soil clays by density gradient centrifugation. *Soil Sci. Soc. Am. J.*, 50, 1633–1639

- Johnson L (1956) Particle size analysis and centrifugal sedimentation. *Trans. Bull. Ceram Soc.*, 55, 267–285
- Kamack HJ (1951) Particle size determination by centrifugal pipet sedimentation. *Anal. Chem.*, 23, 844–850
- Kittrick JA and Hure EW (1963) A procedure for the particle-size separation of soils for X-Ray diffraction analysis. *Soil Sci.*, 96, 5, 319–325
- Koch T and Giddings JC (1986) High-speed separation of large (> 1  $\mu\text{m}$ ) particles by steric Field-Flow-Fractionation. *Anal. Chem.*, 58, 994–997
- Levitz PE (2005) Confined dynamics, forms and transitions in colloidal systems: from clay to DNA. *Magn. Reson. Imaging*, 23, 147–152
- Marshal CE (1931) Studies in the degree of dispersion of the clays, I – Notes on the technique and accuracy of mechanical analysis using the centrifuge. *J. Soc. Chem. Ind.*, SDT, 444–450
- Muog E, Taylor JR, Pearson RW, Weeks AE and Simonson RW (1936) Procedure for special type of mechanical and mineralogical soil analysis. *Soil Sci. Soc. Am. Proc.*, 101–112
- Rouiller J, Brethes A, Burtin G and Guillet B (1984) Fractionnement des argiles par ultra-centrifugation en continu: évolution des illites en milieu podzolique. *Sci. Géol. Bull.*, 37, 319–331
- Schachman HK (1948) Determination of sedimentation constants in the Sharples supercentrifuge. *J. Phys. Colloid. Chem.*, 52, 1034–1045
- Tan KH (1996) *Soil Sampling, Preparation and Analysis*. Dekker, New York, 278–361
- Tanner CB and Jackson ML (1947) Nomographs of sedimentation times for soil particles under gravity or centrifugal acceleration. *Soil Sci. Soc. Am. Proc.*, 12, 60–65
- Tran-Vinh-Ann and Ndejuru E (1972) Analyse granulométrique de la fraction argileuse par centrifugation en flux continu. Mise au point d'une méthode et application à quelques sols tropicaux. *Pédologie*, XXII, 366–382
- Truo E, Taylor JR, Simonson RW and Week ME (1936) Mechanical and mineralogical subdivision of the clay separate of soils. *Soil Sci. Soc. Proc.*, 175–179
- Tu Y, O'Carroll JB, Kotlyar LS, Sparks BD, Ng S, Chung KH and Cuddy G (2005) Recovery of bitumen from oilsands: gelation of ultra-fine clay in the primary separation vessel. *Fuel*, 84, 653–660
- Whittig LD and Allardice WR (1986) X-Ray diffraction techniques – separation of particle – size fraction. In Klute A (ed.), *Method of Soil Analysis Part Physical and Mineralogical Methods*, second edition, American Society or Agronomy, 340–342

## **Mineralogical Characterization by X-Ray Diffractometry**

### **4.1 Introduction**

#### **4.1.1 X-Ray Diffraction and Mineralogy**

Methods using optical microscopy in petrography are not suitable for the identification of mineralogical clays with small particles whose crystal lattices vary with water content and with their ionic environment and whose chemical composition is often unclear (Tables 4.1 and 4.2). Among other available methods, X-ray diffraction (XRD) is one of the most efficient. Coherent scattering of the incidental radiation in XRD makes it possible to clearly identify both the parameters of the crystal lattice and the geometrical distribution of the atoms in the crystal mesh.

XRD can be combined with or supplemented by geochemical and isotopic analyses (AAS, ICP, ICP-MS, EXAFS, etc.), thermal analyses (DTA-TGA, DSC, EGD, EGA, etc.), analyses that enable evaluation of interatomic or intermolecular binding energies and order–disorder relations (e.g. FTIR, Raman spectrometry, Mossbauer spectrometry, NMR), high resolution transmission electronic microscopy (+ electron micro-diffraction) and electronic scan microscopy. EDX or WDX probes make it possible to link in situ chemical composition with the shapes of the particles to be observed. Total chemical composition is determined by total analyses after mineralization in mediums that enable solubilization of all the components; selective dissolution makes it possible to subdivide the sample into fractions of different chemical resistance; these sub-divisions are essential both for quantification and for purification of the samples before analysis by instrumental methods (e.g. XRD, IR or NMR spectroscopy).

**Table 4.1.** Classification of clays proposed by the international association for the study of clays (AIPEA<sup>1</sup>)

type	group ( $x$ = charge by unit formula)	sub-group ( $n$ = number of cations of octahedral layers)	species
1:1	kaolinite – serpentine ( $x = 0$ )	kaolinite ( $n = 2$ ) serpentine ( $n = 3$ )	kaolinite, halloysite, chrysotile, lizardite, antigorite
	pyrophyllite – Talc ( $x = 0$ )	pyrophyllite ( $n = 2$ ) talc ( $n = 3$ )	pyrophyllite talc
2:1	smectites montmorillonite	dioctahedral smectites or montmorillonites ( $n = 3$ )	montmorillonite, beidellite, nontronite
	saponite ( $x = 0.25-0.6$ )	trioctahedral smectites or saponite ( $n = 3$ )	saponite, hectorite, sauconite
	vermiculite ( $x = 0.6-0.9$ )	dioctahedral vermiculites ( $n = 2$ ) trioctahedral vermiculites ( $n = 3$ )	dioctahedral vermiculite trioctahedral vermiculite
	micas <sup>2</sup> ( $x = 1$ )	dioctahedral micas ( $n = 2$ )	muscovite, paragonite
	breakable micas ( $x = 2$ )	trioctahedral micas ( $n = 3$ ) dioctahedral breakable micas ( $n = 2$ ) trioctahedral breakable micas ( $n = 3$ )	biotite, phlogopite margarite clintonite
2:1:1	chlorite ( $x$ variable)	dioctahedral chlorites ( $4 < n < 5$ )	donbassite
		di-trioctahedral chlorites	cookeite, sudoïte
		trioctahedral chlorites ( $5 < n < 6$ )	penninite, clinochlore, prochlorite

Inter-analytical tests can be performed at different levels: on the structure of clays (geochemical relations, pedological differentiation

<sup>1</sup> AIPEA *Association Internationale pour l'Etude des Argiles*, GPO Box 2434, Brisbane, Qld 4001 Australia

<sup>2</sup> Illites (or hydromica), Sericite, etc., many materials labelled illites can be inter-stratified.

within a profile and spatial differentiation), hydrous properties (porosity, permeability, functional waterlogging generated by the nature and the proportion of clays), adsorbing complexes (charge distribution, CEC, etc.).

For a detailed quantitative study, in addition to the clay particle fraction, it is generally necessary to analyse the fine silt fraction which can contain interstratified minerals, particularly in the case of micas and well crystallized kaolinite. A balance takes into account clay and associated phases, oxides, hydroxides, etc. making it possible to explain apparently unmatched results (excessive  $\text{Si}^{4+}$  content due to diatoms, very fine quartz, high percentages of  $\text{K}^+$  originating from potassic feldspars, micas, etc.).

**Table. 4.2.** Structural lexicon (AIPEA, 1972)

English	French
(atomic) plane	plan (atomique)
(tetrahedral or octahedral) sheet (plane combination)	couche (tétraédrique ou octaédrique, combinaison de plans)
1:1 or 2:1 layer (sheet combination)	feuillelet 1:1 ou 2:1 (combinaison de couches)
interlayer space	espace interfoliaire
unit structure = combination of layers + interlayer materials	assemblage de feuillelets + matériel interfoliaire = unité Structurale
lattice	Réseau

**Fig. 4.1.** The crystal mesh

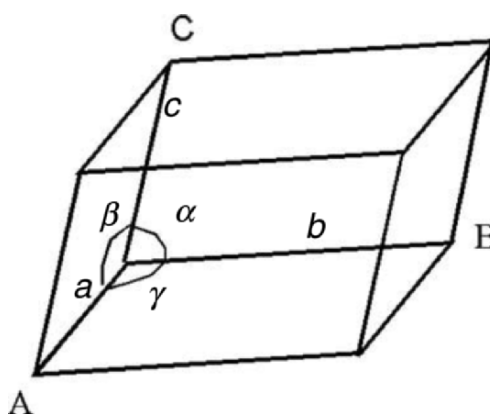

### 4.1.2 Principle

A crystal is defined as a solid made up of atoms assembled in a three-dimensional periodic model. Lengths  $a$ ,  $b$ ,  $c$  and angles  $\alpha$ ,  $\beta$ ,  $\gamma$  between the planes define the mesh parameters of the basic unit (Fig. 4.1).

When monochromatic X-ray beams of suitable wavelength strike a crystalline plane, the X-rays are reflected by the atoms of the crystal. The signal is reinforced in a particular direction if the rays reflected by the different planes (Fig. 4.2) are in phase. This phenomenon corresponds to Bragg's law

$$2 d \sin \vartheta = n\lambda \quad (4.1)$$

where  $d$  is the space between atomic planes or the inter-reticular distance in the crystal ( $d(hkl)$ );  $\lambda$  is wavelength and  $\theta$  is angle between beam and atomic plane and  $n$  is the order of diffraction (integer number).

All the planes of a crystal diffract the X-ray when the crystal is tilted at certain angles  $\theta$  of the incidental beam of wavelength  $\lambda$  in accordance with the law (4.1).

The angles  $\theta$  are linked to wavelength  $\lambda$  and distance  $d$ , which are expressed in Angstroms or nanometres ( $1 \text{ \AA} = 0.1 \text{ nm} = 10^{-10} \text{ m}$ ). If the wavelength is known, measuring the angle of reflection makes it possible to determine the inter-reticular spaces.

#### *Remarks*

Certain minerals can be "amorphous" to X-ray either because they do not have a specific crystalline arrangement (true of glasses) or because they have short-range organization that is too small to be detected at a wavelength of 1–2  $\text{\AA}$ .

XRD is not the best technique for the study of non-crystalline solids such as allophanes which are made up of clusters of Si atoms presenting structural elements with interlayer distances corresponding to 1 or 2 neighbouring atoms.

Atoms of silicon in a tetrahedral position and atoms of aluminium in octahedral coordination but with no regular symmetry, cannot give well defined peaks, but only broad and badly defined peaks that appear around 0.33 and 0.22 nm.

### 4.1.3 XRD Instrumentation

X-rays were discovered in 1895 by Roentgen, but the phenomenon of crystal diffraction was discovered only in 1912.

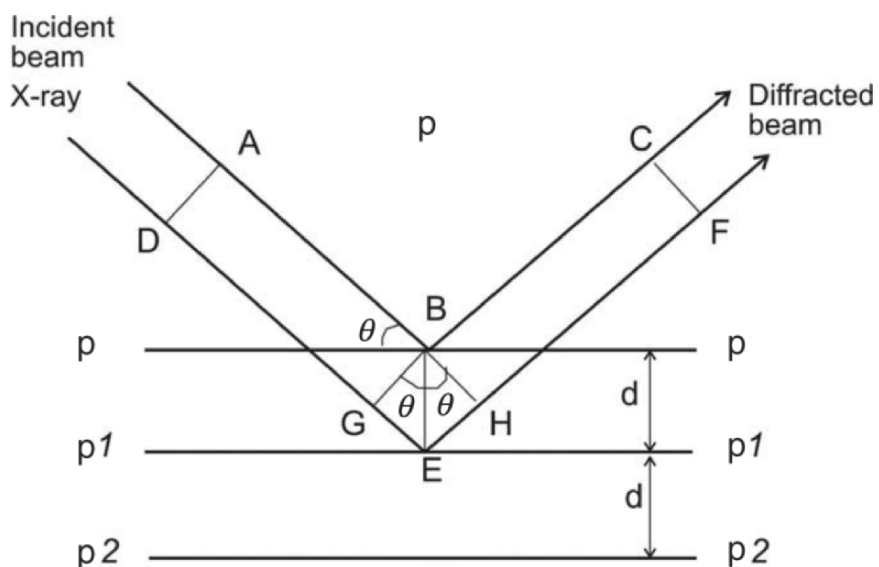

**Fig. 4.2** Diffraction of an incidental beam by crystalline reticular planes. Lines p, p1, p2 represent the parallel and equidistant reticular planes separated by space d. An X-ray beam striking the higher plane p will be reflected in the incidental angle  $\theta$ . To obtain a measurable reflection, all the rays reflected by planes p, p1, p2, etc, must be in phase. To achieve this,  $GE + EH$ , the path difference between radiations ABC and DEF must be equal to a whole number of the wavelength. As  $GE = EH = d \sin \theta$ , the condition is thus the law of Bragg (1).

X-rays are located between UV and gamma radiation wavelengths, i.e. approximately 10 to  $10^{-2}$  nm. In XRD, “hard” radiation is used with wavelengths from 1.5 to 1.9 Å depending on the anti-cathode used (1 Å = 0.1 nm). Radiation X-ray is propagated in a straight line. It is necessary to ensure the radiation is as monochromatic as possible by using a set of filters, slits and a monochromator. The apparatus comprises:

- a generator with stabilized high voltage and micro-intensity which supplies the X-ray tube and the counter
- a sealed X-ray tube, including a source of electrons maintained from 20 to 50 kV by means of a high negative potential and an anode or anti-cathode (Table 4.3) made of thick metal, cooled by a water circuit;

high speed bombardment of the electrons causes transfer of energy to the atoms of the anode-target bringing them to a higher energy level, thus creating orbital vacancies of electrons; the quantum of energy produced is characteristic of the atoms of the anode; X-ray photons leave the tube by 300  $\mu\text{m}$  thick beryllium windows that are transparent to the X-ray (the spot must be as small as possible to concentrate the energy of the electrons on a limited zone of the anode and to ensure a high intensity X-ray source); the power of the tube is limited by the quantity of heat likely to be dissipated by the anode and is expressed by the maximum acceptable value in mA for a given voltage (1–3 kV or more in the case of a rotating anode); characteristic radiations are obtained only starting from a given critical voltage of excitation, thus strict regulation of the voltage and intensity is required to avoid modifying the wavelength

- a *goniometer*, which makes it possible to rotate the sample and the counter under the conditions fixed by the Bragg equation; this provides a support both for the sample whose plane is adjusted very precisely and for the focused detector which turns around the same axis in the same direction at a suitable speed ratio
- a linear beam is obtained by means of the Soller slits and the degree of divergence which limits the opening of the beam; variable slits are now used with openings linked to the angle making it possible to irradiate a constant surface, which is particularly useful with small angles because the effects of the direct beam are limited
- a reception slit limits the width of the beam in the focal plane; the narrower the slit, the higher the resolution, though there is a loss in intensity; a graphite back monochromator limits fluorescence radiation, incoherent radiations and the Compton effect; the perfect alignment of all the different elements determines the quality of the measurements
- a *detection system* (counter) makes it possible to measure the intensity of the X-ray transmitted; the number of pulsations per unit of time is proportional to the quantity of X-ray transmitted; the counter can be linear or proportional, or detection can be by scintillation, or occasionally by semiconductor (semiconductor counter must be kept in liquid nitrogen at  $-196^\circ\text{C}$ ).

### **Safety**

X-ray radiation is dangerous and can cause burns, genetic modifications, cancers, etc. The risks associated with high voltage must be also taken into account.

Careful prevention is essential and strict regulations apply to all apparatuses, which must be equipped with safety devices:



- the sealed tube must be protected by thick walls to eliminate risk of radiation
- the goniometer must be insulated with lead glass or lead plastic to protect the whole apparatus; it should only be opened when the tube is switched off
- the operator must wear a monitoring badge with a sensitive film (dosimeter) that accounts for possible whole-body irradiation (which must be checked regularly), as well as a ring to measure irradiation of the hands
- operators must have regular medical check-ups to detect changes in the blood count (white blood cell count, etc.)
- a Geiger counter must be used to check for radiation leaks: fluorescent screens should be placed on supports made of zinc doped with nickel to identify the zones struck by the beam while alignment is being adjusted.

**Table 4.3.** Characteristics of some anti-cathodes

anti-cathode	$K_{\alpha}$ wavelength $\text{\AA}$	$K_{\beta}$ filter	induced fluorescence	excitation potential (KV)	operating potential (KV)	remarks
Cu	1.542	Ni	Co-Fe	9.0	25–45	penetration and average dispersion, not much affected by air
Co	1.791	Fe	Mn-Cr	7.8	25–35	weak penetration capacity, great dispersion, not much affected by air
Fe	1.947	Mn	Cr-V	7.1	25–35	Weak penetration capacity, great dispersion

## 4.2. Qualitative diffractometry

### 4.2.1 Overview of Preparation of the Samples

See Fig. 4.3.

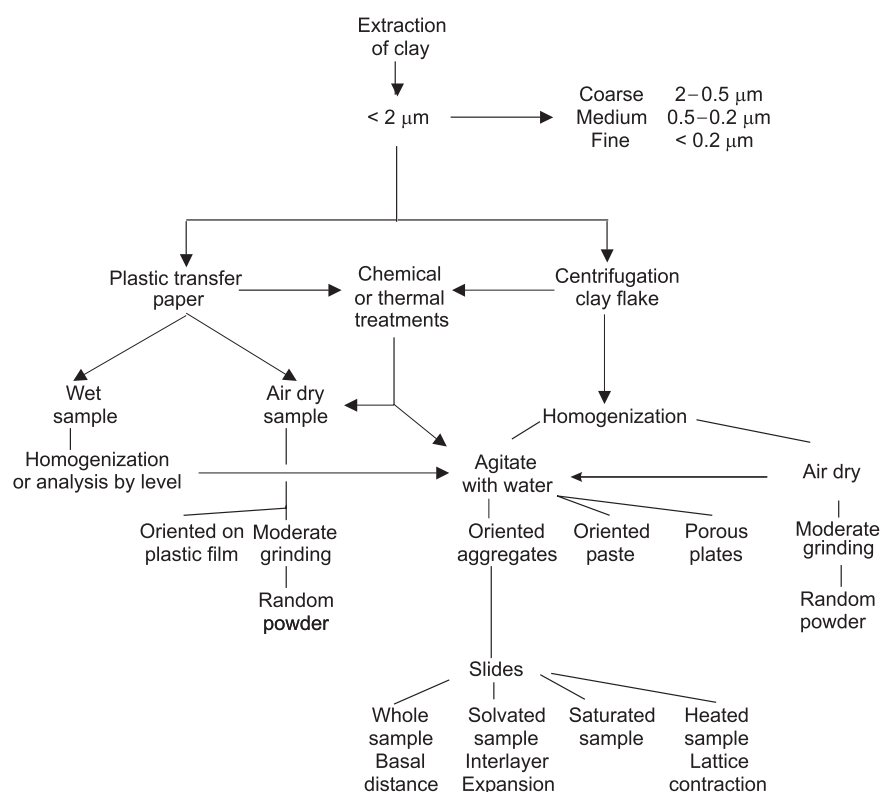

Fig. 4.3. Preparation of samples for X-ray diffractometry

### 4.2.2. Preparation for Powder Diagrams

#### **Objective**

This method is a general way to identify mineral species without preferential orientations. It enables quantitative analysis as the

relative intensity of maxima diffractions is approximately proportional to the number of crystals present if the level of anisotropy is low.

### **Principle**

In the method based on the “spectrum of random powder” (Thomson et al., 1972; Peterson et al., 1986; Decarreau, 1990), the crystal is examined in the form of a fine isotropic powder under a monochromatic X-ray beam. Random orientation must statistically represent all possible orientations of the different particles and provide a complete spectrum of minerals likely to diffract the X-ray (clays, oxides, hydroxides, oxyhydroxides, non-weathered primary minerals, various salts, etc.).

Each particle is considered to be a micro-crystal or an assembly of micro-crystals and the powder mass can be compared with a single crystal turning not in only one axis but in all possible axes. The powder spectrum makes it possible to fix the relative intensities of the peaks indexed by JCPDS<sup>3</sup> and for this reason it should always be carried out before any other operation.

After compression in the support at the semi-microscale, the “powder” sample includes micro-aggregates of fractal dimensions with a piled-up structure with open porosity – the grains being only very slightly connected – and its characteristics depend on the crushing, compression and homogeneity of the medium. The total average orientation at this scale is very weak.

On the other hand, at the sub-microscale (a few tens or hundreds of nanometers), the primary morphological units are mixed stacks of clayey crystallites and can consequently present an orientation with a varying degree of disorder depending on the types of clay present. The use of a revolving support improves the level of randomization, but requires a relatively large quantity of powder, i.e. approximately 400 mg.

### **Procedure**

A powder diagram can be performed on whole soil or on soil fractions (cf. Chap. 3). Clay obtained by centrifugation (centrifugation pellet or plastic transfer paper) is air dried and then crushed in an agate mortar to obtain a homogeneous powder:

- With a spatula place in a hollow support (Fig. 4.4) the quantity of powder needed to almost fill the cavity.

---

<sup>3</sup>JCPDS – ICDD = Joint Committee on Powder Diffraction Standards – International Center for Diffraction Data, Newtown Square Corporate Campus, 12 Campus Bdv, Newtown Square Pennsylvania 19073-3273 (USA).

- With a ground glass slide, gently flatten the powder
- Gradually add powder to fill the remaining cavity and pack gently to bring the surface of the powder up to the reference plane

### **Observations**

#### *Randomization*

The powder must be sufficiently compact to provide cohesion without using a binding agent or needing to smooth the surface. Too much pressure can cause orientation. It is thus necessary to exploit the degree of “randomization–orientation” by preparing the powders as regularly as possible. Indeed, as the clay layers are planes, they tend to be oriented, which is likely to give irregular results.

This effect can be limited by using a binding agent that is inactive both with respect to the X-ray and the sample (acetone, lake gum + alcohol, collodion + acetate of butyl or amyl, gum tragacanth, etc.). These treatments make the powders more stable. However, the use of a vertical goniometer prevents separation of the powder when it is placed in the beam which makes this kind of preparation unnecessary in the majority of the cases.

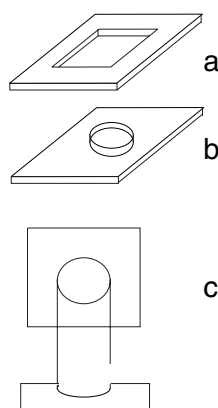

**Fig 4.4.** Supports hollowed out for diffraction: plastic support **(a)**, Siemens revolving support **(b)**, hollowed glass support **(c)**

When only a small quantity of sample is available, double-sided adhesive Scotch tape can be used; this is powdered with the sample (the surplus can be removed by light tapping) or better still, by placing the sample on a silicon support.

Freeze-drying makes it possible to obtain less oriented samples (although there is a risk of a few packages of layers displaying residual orientation). Rotating the sample enables maximum possible reflection,

which decreases the risk of error by improving randomization and by limiting fluctuations in intensity due to an insufficient number of particles. The rotating support requires larger quantities of powder.

#### *Granulometry – Focusing*

The use of a sample plane is required for satisfactory focusing of the beam. The roughness of the surface has a marked effect on the relative intensities of the lines. If the surface is rough, as is true in the case of a coarse powder, the absorption coefficient will be high and the intensities at small angles will consequently be exceptionally low. The powder must be fine (a particle size of about 10  $\mu\text{m}$ ) to avoid such fluctuations in absorption, but not too finely ground to avoid an artificial increase in amorphous minerals:

- at 10  $\mu\text{m}$ , fluctuations will not exceed 2%
- at 50  $\mu\text{m}$ , fluctuations can reach 20%.

On the other hand, with a particle size lower than 0.02  $\mu\text{m}$ , diffractions are diffuse and the intensity decreases.

The width of the diffraction curve increases with a decrease in the thickness of the crystal. The structure of “amorphous” substances is characterized by the absence of periodicity or by short-range organization. In the latter case, they show only one statistical preference for an interatomic distance and XRD cannot give satisfactory results but only broad and badly defined peaks (Fig. 4.5).

**Fig. 4.5.** Diffraction diagrams typical of (a) a well crystallized substance and (b) an amorphous substance with short-range organization

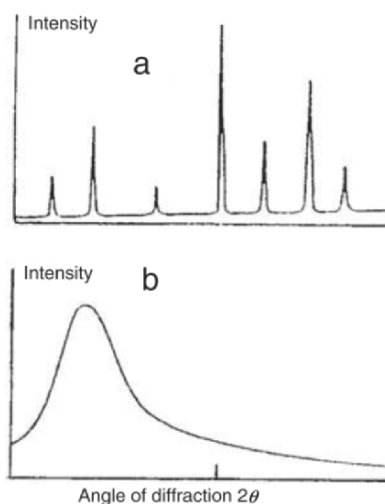

#### *Particular uses of Powder Diagrams*

A powder diagram can be used to identify non-transformed primary minerals (quartz, calcite, etc.) or oxides and hydroxides of iron and

aluminium, etc, as the degree of crystallinity in the case of kaolinites and the “fire-clays” will be distinguished more clearly: since the mode of stacking of the layers is different, certain peaks of kaolinite do not exist in “fire-clays”, which may consequently not be seen on a oriented diagram.

The di- or tri-octahedral nature of the layers can be highlighted by using ray 060 [filling of octahedral cavities by bivalent (1.54 Å) or trivalent (1.49 Å) cations].

Polymorphous illites can provide data that are characteristic of the mode of formation.

### 4.2.3 Preparation for Oriented Diagrams

#### ***Oriented Diagrams on Glass Slides***

##### ***Objective***

The objective is to identify certain clayey minerals capable of being oriented and to observe basal variations by means of heat or chemical treatments. The number of treatments needed depends on the mixture of minerals in the sample.

##### ***Principle***

In diagrams of oriented aggregates, special weight is given to the crystalline planes parallel to the surface of the layers. The preferential orientation of silicates causes an increase in the maximum of basal differentiation  $d(00l)$ , which makes it possible to detect small quantities of crystalline species present in the mixture.

With this method better diffraction is obtained of the species and fluctuations that are theoretically lower than with randomized powders since the particles do not exceed 2  $\mu\text{m}$ . On the other hand, preferential orientation decreases the number of planes ( $hkl$ ) in a position of diffraction.

##### ***Procedure***

- (a) Starting from a well-homogenized clay paste obtained by centrifugation, remove a small aliquot (approximately 400 mg) with the spatula and place it in a tube with 5 mL water; agitate to suspend particles.
- (b) Starting from a powder (for example recovery of the clay used in Chap. 9), weigh approximately 200 mg of clay, place it in a plastic tube

with 5 mL water and a 8 mm glass ball and agitate for 2–3 min to disperse the clay.

- (c) Starting from a or b, pipette approximately 1 mL of suspension and spread it evenly on a 24 × 24 mm glass slide. The deposit must be spread evenly over the whole surface of the slide with no areas of extra thickness. If the deposit is too thin, there may be an effect of the support, if it is too thick, diffraction will occur only on the finest clay and the clay film may reticulate itself. Allow to dry at room temperature, then dry in the desiccator. Prepare three slides:
- the first for examination of the rough sample without treatment
  - the second for examination of the sample after glycerol or glycol treatment
  - the third for heating the sample in the oven at 490°C (depending on requirements, this slide can be used for several thermal treatments at increasing temperatures).

### **Observations**

After the suspension has been spread on the glass slide, micro-fractionation will occur as a function of the size of the clay particles since coarse clay sediments faster than fine clay. However, if drying is rapid, this segregation will not disturb qualitative interpretation.

In contrast to powder techniques (cf. Sect. 4.2.2) that have to be sufficiently thick to limit the effects of orientation, oriented slides must be sufficiently thin so that the maximum number of basic units are suitably oriented. Plotting a black line on the support before use is a good way to judge the quality of the preparation: it should remain very slightly visible through the almost transparent clay film.

In comparative semi-quantitative analysis, the suspended deposit of each sample should contain about the same quantity of clay. This is easy starting from dry clay which can be weighed before suspension. The removal of an aliquot of the sample during agitation results in slides with almost the same quantity of mineral material spread over the same area. From a suspension after agitation and homogenization, quickly remove an aliquot of the same volume and dry and weigh one of the samples to determine the concentration.

For suspensions of wet materials, recover clay on a film of a given surface area and weigh an identical aliquot after drying.

Amorphous minerals can mask part of the diagram. It is often necessary to eliminate them before recording the diffraction diagram.

### ***Diagram on Oriented Paste***

#### ***Principle***

This method is particularly suitable for minerals of the 2:1 type and halloysite-4H<sub>2</sub>O, the wet sample should be dried at room temperature and maintained at a relative humidity of approximately 80%.

#### ***Procedure***

After insulation of clay to the required dimension by centrifugation (cf. Chap. 3), recover the wet centrifugation pellet, homogenize with a small stainless steel spatula, deposit it on a hollowed support (Fig. 4a), spread it out in the cavity, then smooth it with a glass slide to a perfect plane suitably located on the reference plane. Allow to dry slowly at ambient temperature taking care to avoid excessive desiccation.

#### ***Observations***

On coarse 2 μm clays, the clay paste needs to be homogenized after centrifugation, as the part near the surface is able to concentrate fibrous clays which do not respect Stokes law. Smectites deposit preferentially at the surface whereas chlorites and illites sediment more quickly at depth and accumulate more extensively at the base of the centrifugation pellet. The same is true for iron oxides (density 4.5–5) which are heavier than aluminium oxides (density approximately 3).

During drying, clays with a high coefficient of retraction can fissure and detach. A binding agent can be added, though there is a risk of introducing a variable that is not easy to control (disturbed orientation, flocculation, binding agent not amorphous for X-ray, etc).

#### ***Specific Uses***

In certain cases, it is possible to work on the wet sample. With 2:1 clays, saturating the wet paste with Na<sup>+</sup> or Li<sup>+</sup> makes it possible to observe the phenomenon of unlimited swelling  $d(001) > 30\text{Å}$ . During air drying, clay again reaches values of  $d(001) = 18, 15, 14\text{Å}$ .

### ***Aggregates Oriented on Porous Ceramic Plate***

#### ***Objective***

To allow retention of minerals that do not adhere on glass slides and/or, to allow successive treatments on the same sample: original sample, cation treatment, polyalcohol treatment, followed by successive heat treatments. This preparation enables satisfactory orientation of clays, and is particularly useful if the spectra are to be exploited for quantitative analysis.



### *Principle*

The clay is fixed on a porous plate by suction using a vacuum pump or by centrifugation using a Poretics ceramic porous disc and a Hettich support.

### *Procedure*

Transfer the clay suspension on a 24×24 mm porous plate placed on a Büchner with a diameter of 40 mm whose bottom of sintered glass has been modified to create a 22×22 mm window, which is the only permeable part (Fig. 4.6). Tip the homogenized liquid onto the plate and apply a vacuum using a standard pallet pump. After formation of a thin continuous layer of clay, dry the sample and analyse by X-ray diffraction.

### *Observations*

This medium and procedure gives well-oriented deposits with a reduced fractal dimension of the surface which is preserved after drying and is thus of excellent quality for XRD measurement. The thickness of the deposit must be homogeneous all over the plate and sufficiently thick to avoid the effects of the support, but thin enough to preserve a certain degree of elasticity and to avoid cracking caused by the rheological properties of the medium.

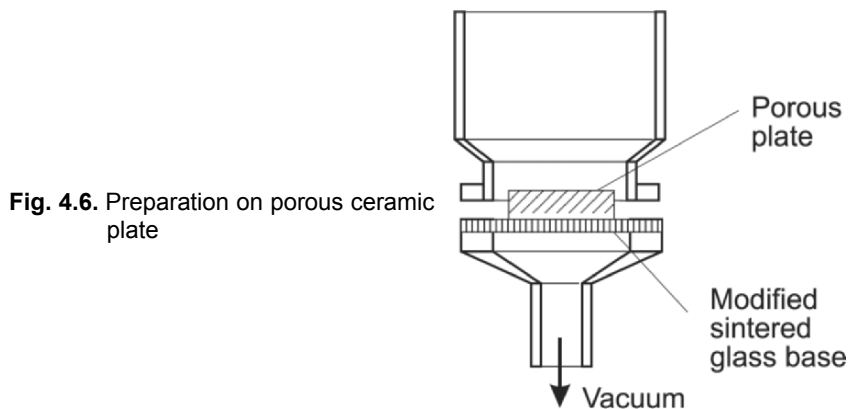

**Fig. 4.6.** Preparation on porous ceramic plate

Measurements on porous plate make it possible to avoid excess solvation liquid and also to carry out the treatments required: chemical saturation by  $Mg^{2+}$  or  $K^+$  treatment, heating, etc. 0.20  $\mu m$  millipore filters on glass plates can also be used for measurements (collection of suspended materials in water, airborne dust, etc).

The cleaning of the porous plate is delicate and should be done after washing by slight abrasion of the surface that has been in contact with the

clay. It is important to preserve the perfect flatness of the plate and to make sure contamination has not occurred.

### ***Oriented Aggregates Deposited by Ultracentrifugation On Semi-Flexible Film***

#### ***Objective***

The aim of this method is to obtain samples of the same thickness, the same mineralogical composition and the same apparent particle size.

#### ***Principle***

Particles are deposited by means of a Sharples super-centrifugal machine equipped with a cylinder with a semi-rigid internal plastic film (cf. Chap. 3). The speed is regulated to collect particles of a known average diameter (coarse to fine clay). If necessary, the film can be analyzed at eight successive levels of 24 mm, which makes it possible to monitor modifications in the nature of clays as a function of particle size and density. To ensure the film is not too thick, the proportion of coarse, medium or fine clay must be known, and only the zones that correspond to an optimal density used (test of the black line on the film, cf. section "Oriented Diagrams on Glass Slides").

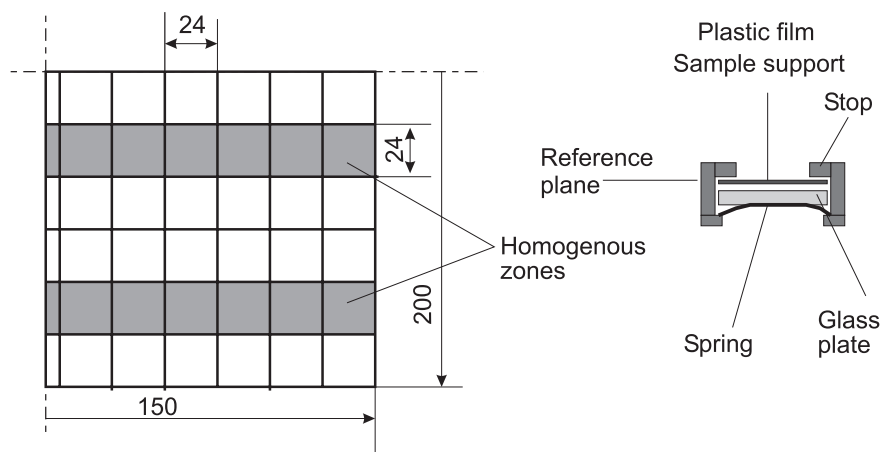

**Fig. 4.7.** Diagram showing how to cut up a plastic film after continuous flow ultracentrifuge and how to set it up for XRD.

#### ***Procedure***

Remove the plastic film from the cylindrical bowl and dry flat for approximately 1 h. When it is still slightly wet and not yet rigid, cut it

into sections following the  $24 \times 24$  mm pattern drawn on the back of the film (Fig. 4.7). Each level should be labelled. Assemble the  $24 \times 24$  mm semi-rigid film on a glass plate and place it on a support against a stop corresponding to the reference plane.

### **Observations**

XRD can be performed directly on the oriented sample or after treatments (cf. Sect. 4.2.4) with polyalcohol; heating treatment at  $110^\circ\text{C}$  is also possible depending on the nature of the plastic used. The surface of the plastic support must be unpolished naturally without additives as these could cause background noise that is incompatible with the smoothness of measurements.

## **4.2.4 Pretreatment of Clays**

### **Effect of the Pretreatments**

Different types of pretreatments can be used to facilitate the identification of clayey minerals by causing selective changes in the inter-reticular distances of the clayey layers. These treatments and their effects are summarized in Table 4.4. Table 4.5 shows the maximum inter-reticular distances observable in the clayey minerals of soils.

### **Saturation by Cations**

#### **Principle**

Saturation by a cation makes it possible to fill the existing cation vacancies and, by displacement of the exchangeable cations, to obtain homoionic samples that present uniform expansion of the layers of the expansible phyllosilicates (the quantities of interlayer water depend on the exchangeable cations). The divalent cations, e.g.  $\text{Mg}^{2+}$ ,  $\text{Ca}^{2+}$ ,  $\text{Sr}^{2+}$ , give hydrates with two layers that are relatively stable in a broad range of relative humidity and are not very sensitive to the influence of hydronium ions during washing with water.

$\text{Mg}^{2+}$  saturation gives a stable complex with two layers of inter-layer water which brings the expansible phyllosilicates to  $d_{001} \geq 14$ . Expansion of the layers allows differentiation of the non-expansible varieties of clays whose interlayer space is approximately  $10 \text{ \AA}$  (Table 4.5).

$\text{K}^+$  saturation restricts interlayer adsorption of water and allows differentiation of 2:1:1 clays of the chlorite type, and of 2:1 clays of the vermiculite type. Non-expansible chlorites are not modified by this

treatment, whereas vermiculites break down at 10 Å. The same sample can be also used for smectites after heating to 550°C.

*Li<sup>+</sup> saturation* followed by dehydration to approximately 300°C, followed by solvation with glycerol, makes it possible to differentiate montmorillonite from beidellite using the Greene–Kelly test based on the Hofmann–Klemen effect. When a smectite saturated with Li is dehydrated at 300°C, the Li interlayer migrates towards the octahedral layers which have a deficit of positive charges resulting from substitutions. The structure becomes non-expansible and there is no further inflation of the sample with glycerol treatment (9.5Å). A beidellite (or a saponite) whose charges comes from tetrahedral substitutions is not affected by such treatments and inflates with glycerol (17.7 Å).

#### *Procedure for Mg<sup>2+</sup> saturation*

- Take an aliquot of 125–250 mg of clay
- put in suspension and acidify with diluted hydrochloric acid to bring it to pH 3.5–4.0 to avoid precipitation of magnesium hydroxide (particularly if initial dispersion was carried out in an alkaline medium)
- add 5 mol L<sup>-1</sup> magnesium acetate solution to obtain a suspension of approximately 0.5 mol (Mg) L<sup>-1</sup>
- leave in contact for 30 min
- centrifuge for 5 min at approximately 3,000g and discard the supernatant
- wash the centrifugation pellet twice with 0.5 mol (Mg(OAc)<sub>2</sub>) L<sup>-1</sup> solution to eliminate H<sup>+</sup> from the acid suspension then twice with 0.5 mol (MgCl<sub>2</sub>) L<sup>-1</sup> solution (approximately 10 mL)
- centrifuge and wash with 50% methanol (approximately 10 mL) then with 98% methanol (approximately 10 mL); then with 85% acetone. The silver nitrate test for Cl<sup>-</sup> must be negative
- dry at room temperature for the powder spectrum, or prepare the plates for oriented spectrum immediately by adding a little water.

#### *Procedure for K<sup>+</sup> saturation*

- Take an aliquot of 100–250 mg of clays
- put in suspension and add 1 mol (KCl) L<sup>-1</sup> solution
- centrifuge the flocculated clay after 30 min of contact
- discard the supernatant
- wash the centrifugation pellet with KCl 1 M

**Table 4.4.** Influence of the treatments on the inter-reticular distance between layers of principal clays: air dried samples, saturated with  $Mg^{2+}$  (M = metahalloysite or halloysite,  $2H_2O$  (7 Å), H: hydrated halloysite,  $4H_2O$  (10 Å). Intergrades of chlorite-vermiculite and chlorite-smectite are also separated by these treatments

group	1:1 (Te – Oc)		2:1 (Te – Oc – Te)			2:1:1 (Te – Oc – Te – Oc)		
<i>d</i> (Å)	7	7–10	9.4	10	10–12	14–15		
Stability (inter-layer)	–	H <sub>2</sub> O	–	cation	fibrous	water cations	octahedral	
Family	kaolinite	serpentine	talca halloysite pyrophyllite	micas (illite)	sepiolite palygors- kite	smectites	vermiculites chlorites	
Charges x	0		0	1–2		0.2–0.6	0.6–0.9	
Glycerol solvation	nil 7.1 Å	nil 7.3 Å	nil M 7.2 Å H 10.8 Å	nil 10.1 Å	nil S 12.1 Å P 10.48 Å	expansion 17.7 Å	nil 14 - 15 Å	nil except swelling of chlorites
K <sup>+</sup> saturation	nil 7.1 Å	nil 7.3 Å	nil M 7.2 Å H 10 Å	nil 10.1 Å	nil S 12.1 Å P 10.48 Å	contraction 12.4 Å 12.8 Å	contraction 10 Å (avec 14 Å)	nil contraction 14 Å
Heating 550°C	collapse	nil 7.3 Å	M collapse H collapse	nil 10 Å	10.4–8.2 Å 9.2 Å 4.7 Å	contraction 10 Å	contraction 14 Å	nil 14 Å
Formamide intercalation	nil 7.1 Å < 4 h	nil 7.3 Å	expansion M 10.48 Å					
DMSO	expansion 11.18 Å	nil 7.3 Å	M expansion					
Green–Kelly test, 250°C glycerol							montmorillonite 9.5 Å beidellite 17.7 Å	

**Table 4.5.** Maximum inter-reticular distance of soil minerals saturated with Mg<sup>2+</sup> and K<sup>+</sup> or solvated by glycerol treatment.

mineral	<i>d</i> (Å)	<i>hkl</i> plane
(a) Samples saturated by Mg <sup>2+</sup>		
chlorite	13.6 – 14.7	001
vermiculite	14.0 – 15.0	002
montmorillonite	14.0 – 15.0	001
mica (Illite)	9.9 – 10.1	001
talc	9.2 – 9.4	002
halloysite	10.1	001
metahalloysite	7.2 – 7.5	001
kaolinite	7.1 – 7.2	001
lepidoscrocite	6.27	020
boehmite	6.11	020
gibbsite	4.85	002
silicates	4.4 – 4.6	110
gypsum	4.27	121
göethite	4.18	110
crystalite	4.04	101
Illmenite	3.73	102
quartz	3.34	101
feldspar	3.1 – 3.25	
calcite	3.03	100
hematite	2.69	104
magnetite	2.53	311
trioctaedric silicates	1.54	060
dioctaedric silicates	1.49	
(b) Samples saturated by Mg <sup>2+</sup> and solvated by glycerol		
montmorillonite	17.7	001
vermiculite	14.4	002
chlorite	13.6 – 14.7	001
halloysite	10.1 – 10.7	001
montmorillonite (2nd order)	9.5	001
chlorite – Vermiculite (2nd order)	7.15	002
minerals giving inter-layer spaces similar to 'a'		

(c) Samples saturated by  $K^+$  and air dried

chlorite	13.6 – 14.7	001
montmorillonite	11.0 – 13.0	001
vermiculite	10.0 – 11.0	002
metahalloysite	7.2 – 7.5	001
chlorite (2nd order)	7.15	002

Minerals giving inter-layer spaces similar to 'a'

d) Samples saturated by  $K^+$  and heated at 550°C for 2-3 h

chlorite	13.6 – 14.7	001
montmorillonite	9.9 – 10.1	001
vermiculite	9.9 – 10.1	002
mica (Illite)	9.9 – 10.1	001
chlorite (2nd order)	7.15	002

- then wash with 50% and 95% methanol and finally with 95% acetone until there are no  $Cl^-$  ions in the washing solution (no precipitate with addition of  $AgNO_3$ )
- allow to dry at room temperature or immediately prepare slides for oriented spectrum by adding distilled water.

*Procedure for  $Li^+$  saturation*

- Take an aliquot of 110 – 250 mg of clay
- put in suspension and add 3 mol (LiCl)  $L^{-1}$  solution
- leave in contact for 30 min
- centrifuge and discard the supernatant
- rapidly wash the centrifugation pellet with 1 mol (LiCl)  $L^{-1}$  solution then with a little water
- make an oriented slide and dry at 250°C overnight
- carry out the glycerol treatment (1 night) and perform the diffraction spectrum.

*Remarks*

- This test is not completely selective
- mounting on an ordinary glass slide can cause errors during heating as the  $Na^+$  in glass can exchange with the  $Li^+$  in the clay, which causes incomplete neutralization of the octahedral charges
- the glycerol treatment must be carried out hot for a period of several hours to allow complete expansion of the layers
- an irrational basal sequence indicates inter-stratification.

## **Removal of Iron**

### **Principle**

Iron often has to be removed first to mitigate its action on the process of measurement by XRD using a Cu tube (X-ray fluorescence increases background noise) and second to avoid dilution through a reduction in the intensity of diffraction.

Different methods can be used to eliminate the different forms of iron. These methods vary in vigour and should not transform the phyllo-silicates present, but make it possible to complex and reduce amorphous and crystallized iron in a slightly acid medium with the minimum possible degree of aggressiveness. These methods are similar to those used in Chaps 2 and 6, but the solubilization of iron compounds is generally not controlled (because it is the final residue of the sample will be analyzed by XRD).

It should be noted that the amorphous silicon–iron complexes present in certain sediments will be dissociated in an acid medium giving soluble iron and precipitated amorphous silica.

Hematite and goethite oxides are only slightly affected by an acid oxalate treatment at pH 3. A reducing treatment with complexation of the products of dissolution (oxalate acid + dithionite) is the best way to eliminate most iron while sparing the clay. Oxalate dissolves amorphous iron and dithionite dissolves oxide forms of iron. A slightly acid medium allows extraction of “free iron” but at the same time extracts part of the iron of the lattice of certain clays, for example vermiculites. With dithionite, the presence of sulphur precipitated after reduction does not pose a problem for XRD, except for a dilution effect on the sample. Sulphur should be eliminated from the extraction pellet after centrifugation and drying.

### **Procedure**

The main methods are based on dissolution in an acid or base sequestering medium and/or reducing medium (cf. Chap. 6):

- The DCB method (dithionite, citrate, bicarbonate) extracts iron from the majority of its amorphous and crystalline compounds by reduction and sequestration without significant modification of aluminosilicates or lithogenic hematite
- the method based on acid oxalate at pH 3.0 (in darkness, or with UV photolysis) extracts noncrystalline forms
- the sodium pyrophosphate method at pH 9–10, EDTA at pH 9–10, acetyl acetone extracts organometallic forms



– the tetraborate method at pH 8–9 extracts Fe from monomeric complexes.

The elimination of iron is accompanied by the dissolution of aluminous products, silica, etc. which can be controlled by chemical titration of the extracts.

### ***Solvation Treatments***

#### ***Principle***

Solvation by polar molecules, such as mono or polyhydric alcohols, ethers, amines, results in the formation of interlayer organic complexes. The resulting structure is more stable than the structure of dehydrated 2:1 clay. Swelling is all the easier since the charge of the layers is weaker, or is limited to the octahedral layer. The nature of the interlayer cations modifies the limits of stability of the organic complex. The basal distance of the smectites reaches 17.7 Å with a double interlayer layer of glycerol, and 17.1 Å with ethylene glycol. The rate of hydration can vary considerably. Montmorillonites inflate more easily than the majority of clays.

Impregnation can be accomplished in the liquid or vapour phase by heating to 60°C. In certain cases, the treatment has to be continued for 24 hours to take the slowness of interlayer expansion into account. Condensation of the vapour does not cause any mechanical disturbance and gives more intense lines of diffraction.

#### ***Procedure for Glycerol Treatment***

This procedure is based on that of Modre and Dixon (1970):

- Prepare a 1:10 mixture of glycerol and water
- on a previously air-dried oriented plate, apply a film of glycerol in a very fine spray, taking care not to create an excess of reagent
- allow to dry for at least 1 or 2 h and then perform XRD.

*Caution.* The complex loses its effectiveness over time, so it is advisable not to wait more than 20 h. Using ceramic plate for this treatment makes it possible to eliminate excess glycerol.

### *Procedure for Ethylene Glycol Treatment*

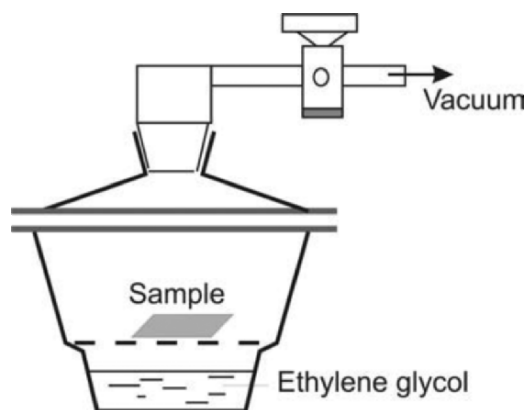

**Fig. 4.8.** Treatment of the samples with ethylene glycol

This procedure is based on that of Eltantawy and Arnold (1974) and Chassin (1974):

- place the sample (generally for spectrum-oriented aggregates) in a desiccator containing the ethylene glycol (Fig. 4.8)
- create a partial vacuum with the vacuum pump and leave the samples in contact with the vapour phase for at least one night
- remove the sample and perform XRD as soon as possible.

*Caution.* The complex loses its effectiveness over time, so it is advisable not to wait more than 10 h.

*Safety.* Ethylene glycol or 1,2 ethanediol:  $\text{HOCH}_2\text{--CH}_2\text{OH}$ , has a boiling point of  $196^\circ\text{C}$ ; it is hygroscopic, toxic by ingestion, and can affect the kidneys, lungs and the heart.

### **Intercalation Complexes**

#### *Principle*

Intercalation complexes are very useful particularly to separate 1:1 clays and to distinguish well-crystallized forms, disordered forms and halloysites. Since the forms of these species are similar, it is impossible to separate them with precision (kaolinite and halloysite can be found in flat, tubular or glomerular forms). One common procedure is first to form the intercalation complex, then after obtaining the spectrum, to move the complex with water and perform solvation with ethylene glycol or glycerol. The stability of the intercalation complexes is variable and XRD spectra should be performed without delay.

Treatment with *hydrazine hydrate* (Wada and Yamada, 1968; Range et al. 1969; Calvert, 1984) allows the inter-layers of the well-ordered kaolinite to be changed from 7.15 to 10.48 Å without modifying the chlorite. The presence of interstratified minerals can be awkward.

In the treatment using *dimethylsulfoxide* (Gonzalez Garcia and Sanchez Camazano 1968 Olejnik et al., 1968 Anton and Rouxhet, 1977; Calvert 1984): (i) kaolinite forms an intercalation complex that increases the interlayer distance from 7.15 to 11.18 Å, which remains stable after heating to 300°C, (ii) halloysite and dickite display identical behaviour, except that heating to 300°C does not result in further expansion, (iii) vermiculites and smectites increase from 18 to 19 Å and (iv) chlorite undergoes no change.

Metahalloysite forms an intercalation complex with formamide. The line rapidly reaches 10.4 Å and whereas for kaolinite there is no reaction even after 4 h of contact (Churchman et al., 1984).

#### ***Procedure for Hydrazine Hydrate Treatment***

- Place the clay sample on a glass slide or on porous ceramic in a saturator containing the hydrazine hydrate
- create a partial vacuum with the vacuum pump and leave the sample in contact with the vapour phase at 65°C for at least one night
- remove the sample and perform XRD without delay.

#### ***Remarks***

It should be noted that the complex loses effectiveness over time; so it is advisable not to wait more than 1 h before XRD.

Sequential treatment with hydrazine + water + glycerol makes it possible to increase the basal interlayer distance of halloysite to 11.1 Å, whereas that of kaolinite remains at 7.15 Å.

#### ***Safety***

- Hydrazine hydrate:  $\text{H}_2\text{NR}-\text{NH}_2, \text{H}_2\text{O}$ , boiling point 119°C
- miscible with water and ethanol
- strong base, very corrosive, attacks glass and the skin
- highly toxic, causes irritation of the eyes, may be carcinogenic.

#### ***Procedure for Dimethylsulfoxide Treatment***

- Put an aliquot of clay weighing from 100 to 250 mg in suspension in 5 mL of dimethylsulfoxide
- leave in contact for 8 h in a water bath at approximately 40°C
- agitate from time to time
- centrifuge and prepare slide, allow to dry
- rapidly perform XRD after drying.

**Table 4.6.** Effect of the thermal treatment on the diffraction of clays (TDA = characteristic temperature of change in thermal differential analysis, cf. Chap. 7).

mineral		temp. (°C)		
		4 H at	TDA	heat effect
1:1 clays	Well crystallized Kaolinite	500	575–625	absence of diffraction
	Disordered kaolinite	500	550–562	absence of diffraction
	Dickite	500	665–700	absence of diffraction
	Nacrite	500	625–680	absence of diffraction
	Halloysite, 4H <sub>2</sub> O	110	125–160	elimination of water
		500	560–605	absence of diffraction
	Metahalloysite, 2H <sub>2</sub> O	110	125–150	elimination of water
		500	560–590	absence of diffraction
Short- range order alumino- silicates	Allophane	110	140–180	elimination of water, no XRD spectrum
	Imogolite	350		difficult identification by XRD →18Å
		500	500	disappearance of 18Å peak, destruction of the mesh
Micas and 2:1 clays	Crystallized micas (muscovite)	490	700	mica spectrum up to 1,000°C
		350	125–250	loss of water
	Illite–micaceous clays	500	350–550	mica spectrum
		500	700	mica spectrum (001)
	Glauconite	500	530–650	loss of water–mica structure
	Celadonite	500	500–600	mica structure
2:1 clays	Biotite	500	700	mica spectrum until 700–1,000°C
	Vermiculite	300	300	Progressive loss of H <sub>2</sub> O the initial basal space (001) is a function of moisture: 14–13, 8–11, 6–9Å changes
	Montmorillonite	300	300	Disappearance 15 → 9Å

	Chlorite	500	680–800	no change if structure is well ordered
	Chlorite–Mg	500	650	intensification of line 14 Å – line 3.54 Å not affected (octahedral layer 820°C intercalated layer 640°C)
2:1:1				Attenuation of line 14Å which becomes broad and diffuse.
Clays	Chlorite–Fe	500	500	octahedral layer 530°C, Fe <sup>2+</sup> intercalated layer 430°C, Fe <sup>2+</sup> intercalated layer 250°C Fe <sup>3+</sup>
	Chlorite–Al Inter-stratified	500	500 < 600	(octahedral layer 750°C intercalated 900°C layer) effects vary with the mineral species present
				dehydration
Fibrous	Sepiolite	350	<200 >200 350 800	space 12 Å becomes weak and diffuse → 9.8 Å, space 7.6 Å more intense recrystallization
Clays	Palygorskite	300 500	<400 440 800	dehydration without change in structure, 10.5 Å peak becomes broad and diffuse, destruction of structure

### Safety

- Dimethylsulfoxide: C<sub>2</sub>H<sub>6</sub>OS, boiling point: 189°C
- hygroscopic, irritation of the skin (urticant), keep away from the eyes.

### Procedure for Formamide Treatment

- Place the clay sample on a glass slide or preferably on porous ceramic, allow to dry
- vaporize formamide and note the time of application; when the formamide excess has been eliminated (approximately 20 min), perform XRD (repeat with the same sample at the end of the day and compare the two spectra).

**Safety**

Formamide (H-CO-NH<sub>2</sub>) is an ionizing solvent which can release a slight odour of ammonia. It dissolves lignin. No known risk to health.

**Thermal Pretreatments****Principle**

The hydrated minerals undergo modifications due to the effect of the rise in temperature. These modifications occur at certain characteristic temperature stages. The length of time at a given temperature is also significant. The transformations take place with varying rapidity depending on the nature and the degree of crystallinity of the thermally sensitive minerals. In general, 2–4 h are required

**Table 4.7** Effect of thermal treatments on oxides and hydroxides of aluminium and iron (TDA: characteristic temperature of change in thermal differential analysis, cf. Chap. 7)

mineral	temperature (°C)		heating effect
	4 H	TDA	
	iron series		
Goethite	300	230–280	spectrum of disordered hematite
	900	900	spectrum of well-crystallized hematite
Goethite	350	240–350	spectrum of disordered hematite
alumineuse		900	spectrum of well-crystallized hematite
Lepidocrocite	300	230–280	$\gamma$ Fe <sub>2</sub> O <sub>3</sub> broad peak
		400–500	→ hematite spectrum
Maghemite	350	350–450	→ hematite spectrum
Magnetite	500	600–800	→ hematite spectrum
			At 300°, the akaganeite spectrum weakens
Akaganeite	300	200–400	gradually
		420–500	→ hematite spectrum
$\delta$ FeOOH	300	140–260	→ hematite spectrum with intermediary goethite
Feroxyhyte			unstable in air at ambient temperature →
$\delta$ FeOOH			goethite spectrum after air drying
Ferrihydrite (without Si)	350	350–400	→ hematite spectrum

Ferrihydrite (with Si)	500	550–600	→ hematite spectrum
Aluminium series			
Gibbsite	200	150–200	→ boehmite and $\gamma\text{Al}_2\text{O}_3$ spectrum/a?
Bayerite	200	150–200	→ boehmite and $\gamma\text{Al}_2\text{O}_3$ spectrum/a?
Nordstrandite	200	150–200	→ bayerite spectrum → boehmite
Boehmite	500	450–500	→ $\gamma\text{Al}_2\text{O}_3$ spectrum
Diaspore	500	470–500	→ spectrum of disordered corundum towards spectrum of crystallized corundum

### Procedure

Place the samples assembled on glass slides in a cold furnace; bring the furnace to the desired temperature (110, 350, 490, 530°C, etc.) and maintain the temperature for at least 4 h. Heating must be progressive to avoid breaking the glass slides and possible reticulation of the clay film. The furnace should then be allowed to cool gradually, opening the door to accelerate the process if necessary. If they have not undergone irreversible transformations, the slides can be stored in the desiccator until XRD. Table 4.6 shows the influence of heat treatments on the diffraction of clays. Table 4.7 shows the influence of heat on the diffraction of aluminium oxides and iron hydroxides.

### Observations

- Loss of interlayer water results in contraction of the mesh and displacement of the basic diffraction lines
- heating to high temperatures can lead to collapse of the lattice and dispersal of the characteristic X-ray spectrum.

### Example

Dissociation of kaolinite by heating (Fig. 4.9) to around 490°C can be visualised by the four following reactions:

- (1) at 500°C:  $\text{Al}_2\text{O}_3, 2\text{SiO}_2, 2\text{H}_2\text{O} \rightarrow \text{Al}_2\text{O}_3, 2\text{SiO}_2$  (metakaolinite) + 2  $\text{H}_2\text{O}$
- (2) at 925°C:  $\text{Al}_2\text{O}_3, 2\text{SiO}_2, 2\text{H}_2\text{O} \rightarrow \text{Al}_2\text{O}_3, \text{SiO}_2$  (sillimanite) +  $\text{SiO}_2$  ( $\beta$  quartz) + 2  $\text{H}_2\text{O}$
- (3) at 1 100°C:  $\text{Al}_2\text{O}_3, 2\text{SiO}_2, 2\text{H}_2\text{O} \rightarrow \alpha\text{Al}_2\text{O}_3 + 2\text{SiO}_2$  ( $\beta$  quartz) + 2 $\text{H}_2\text{O}$
- (4) at 1 400°C:  $\text{Al}_2\text{O}_3, 2\text{SiO}_2, 2\text{H}_2\text{O} \rightarrow 1/3 (3\text{Al}_2\text{O}_3, 2\text{SiO}_2) + 4/3 \text{SiO}_2$  ( $\beta$  quartz) + 2 $\text{H}_2\text{O}$

All these reactions are possible starting from 800 K (approximately 527°C). There is no obstacle to the transition of kaolinite → metakaolinite → sillimanite → mullites → oxides, the most stable system, which depends on the temperature. Thermodynamically reaction (1) occurs first (Fig. 4.9).

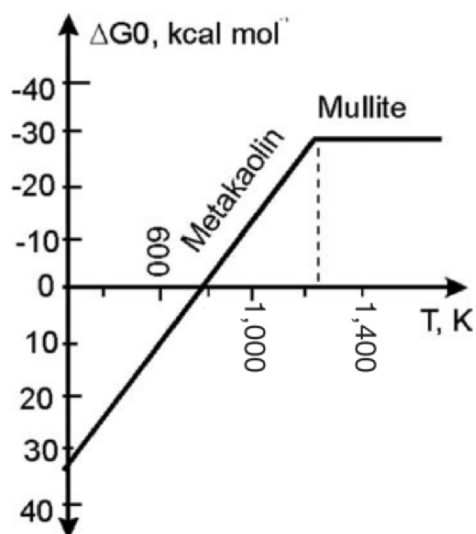

Fig. 4.9. Transformation of kaolinite by heating

### **Preparation of Iron Oxides for XRD**

#### **Principle**

The use of XRD to study iron oxides in the soil requires a sufficient concentration of the different iron phases. Consequently the products have to be concentrated and purified without modifying either their crystallinity or the level of substitution by aluminium, and without causing chemical conversions of the phases. The following methods can be used to this end:

- separation methods (concretions, separation by density gradient, magnetic separation, etc)
- in situ XRD determination on an uncovered thin slide, or extracted micro-samples with high iron content.

Chemical methods only enable the concentration of iron, which can exist in the form of coating, in amorphous forms (ferrihydrite, etc.), or involve varying degrees of crystallization (goethite, hematite,



lepidocrocite, etc.). Clay minerals are dissolved by 5 mol (NaOH) L<sup>-1</sup> solution under boiling. Kaolinites, halloysite, gibbsite, amorphous aluminosilicates, etc. are destroyed and solubilized, but 2:1 clays are more resistant and are thus only partially attacked. In addition to iron, smectites, illite, quartz, anatase, and rutile are also found in the residue. If the amount of silica present is not sufficient, during heating with 5 mol (NaOH) L<sup>-1</sup> solution, the ferrihydrites are likely to be transformed into hematite or goethite. If the sample is attacked using 5 mol (NaOH) L<sup>-1</sup> + 0.2 mol (silica) L<sup>-1</sup> solution, the rate of aluminium substitution is not significantly modified.

#### *Procedure*

- Weigh in PTFE beakers 2–5 g of soil, or granulometric clay <2 μm depending on the total iron content
- attack with 20 mL 5 mol (NaOH) L<sup>-1</sup> + 0.2 mol (silica) L<sup>-1</sup> solution, cover the beaker with a PTFE plate and boil for one hour
- allow to cool and decant
- dilute the medium with deionised water, then wash on filter with water until the pH is neutral
- perform XRD

*Note:* a powder diagram is better than an oriented diagram for these products.

#### *Remarks*

- If the soil or clay contains many 2:1 phyllosilicates, the concentration may be too low; in this case it is useful to perform two differential spectra (DXRD), one with the original product, the other with the chemically concentrated product, or with the spectrum obtained after dissolution of iron by the citrate–bicarbonate–dithionite mixture (CBD, cf. Chap. 6)
- a cobalt X-ray tube should be used to avoid fluorescence of iron which occurs with a copper tube
- the PTFE beakers can be used up to a maximum temperature of 250°C;
- in certain cases, destruction of the matrix silicates can be achieved through an HF attack in a PTFE beaker
- heating to 600°C gives anhydrous oxides → hematite.

### **4.2.5 Qualitative Diffractometry**

The sample of whole soil crushed to 0.1 mm and “clay < 2 μm” fractions (or 0.5 or 0.2 μm sub-fractions,) prepared for randomized or oriented powder spectrum are analyzed by XRD.

Each group of clay has its own layered structure which gives basal reflections whose position, intensity and shape enable either immediate identification or after specific treatments. This section describes the interpretation of standard situations that make it possible to evaluate clayey minerals at the scale of the group and the sub-group, and very occasionally at the scale of the species.

### ***Fine Adjustment of Experimental Conditions***

The experimental conditions must be precisely determined in advance, i.e. the type of tube (Cu, Co, etc.), the intensity applied to the filament, the opening of the slits, the speed of rotation of the goniometer, tension meter, amplification, adjustment of the constants of time-inertia, sensitivity, signal/background ratio, angular zone, scanning speed, etc.

A cobalt tube X-ray should be used for samples that are rich in iron because it does not generate fluorescence with this ion. Generally, with suitable geometry, an international standard Cu tube give a satisfactory performance, and JCPDS tables and software (see note 1 in Sect. 4.2.2) cited here are based on this standard.

The rotation speed of the goniometer and the selection of the angular zone of scanning determine the time needed for analysis. The choice of the scanning rate of the sample influences the relative precision of the diffractograms. Too high a speed can lead to insufficient discrimination. For the determination standards, a displacement speed of 1 to 2 °min<sup>-1</sup> ( $2\theta$  angle) may be sufficiently rapid but does not allow adequate separation of fine doublets such as those of kaolinite (002) and chlorite (004) for which a slower rate is necessary (<0.5°  $2\theta$  min<sup>-1</sup>). For rapid characterization of clay (group and sub-group) the angular zone of scanning can be limited to a  $2\theta$  zone of approximately 2 – 40 degrees, if determination of the  $d(060)$  diffraction is not required as this takes much longer. The strong reflection at  $2\theta = 60^\circ$  makes it possible to estimate parameter “ $b$ ” and thus to differentiate dioctahedral minerals (1.48–1.50 Å) from trioctahedral minerals (1.53 – 1.55 Å) and sometimes to provide more evidence for approximate values by bringing these values closer to the intensities of  $d(001)$  diffractions, for example in the identification of certain micas. Powder samples are performed by rotating the sample-support in the reference plane, which requires high precision equipment. The oriented sample method makes it possible to reinforce the reflections (001) by directing the particles according to the development plane of clay minerals. All the slides (or any other form of support) for each sample should be made simultaneously and as homogeneously as possible

(same suspension, same quantity of clay per slide, etc.). Three sub-samples are usually essential:

- a reference oriented sub-sample without treatment, dried and observed with a known quantity of relative moisture
- an oriented sub-sample solvated for hydrated 2:1 clays
- an oriented sub-sample for heat treatment (500°C for 4 h).

The samples should be analysed one after another, and the equipment should be regulated in exactly the same way for each sample to enable better comparison of the spectra. In more complex cases, it may be necessary to prepare homoionically saturated samples ( $K^+$ ,  $Mg^{2+}$ ) with suitable treatment and intercalation sequences. These should be performed under the same conditions taking into account the relative humidity of the air, relative stability of the solvations and complexes of intercalation, reaction times (in the case of formamide treatment whose action is rapid on halloysite, whereas on kaolinite this treatment can take 4 or 5 h and should thus be performed at the head of the series). If the sample is very small, it may be possible to perform treatments and measurements sequentially on the same sample. In this case porous ceramics should be used (or 0.20  $\mu m$  Millipore filters if heat treatments are not envisaged). However, as measurements must then be made over a period of several days it is more difficult to maintain constant conditions.

### ***Examination of the Diagrams***

#### ***Background Noise***

The background noise is due to non-specific signals that are inherent to the material, to the process, to minerals with short-range organization, and possibly to fluorescence phenomena resulting from the emission of secondary X-rays. The latter phenomenon can be eliminated by the back monochromator and amplitude discrimination. The background noise can be also smoothed electronically with suitable software. In the zone of the small angles ( $2\theta$  between 0 and 10° approximately), depending on the adjustment of the slits, the counter may receive part of the direct beam or of reflections from the edges of the support. The use of variable slits generally prevents these phenomena.

The presence of amorphous substances (aluminosilicates, different oxides, etc.) is indicated by broad and diffuse bands. The interpretation software makes it possible to eliminate these zones selectively and to stabilize the base line.

### *Geometry of the Peaks*

The geometry of the peaks enables determination of the degree of crystallinity, particularly for well-crystallized minerals where crystal size is suited to the X-ray wavelength and presents regular inter-reticular variations giving clear diffractions and many harmonics (Fig. 4.5a). Badly crystallized minerals that are not well ordered and whose size is not suitable to X-ray often give broad biconvex peaks whose surfaces are not usable for quantitative analysis (e.g. smectite, Goethite, see Fig. 4.5b). Too many particles such as diatoms, quartz or feldspars, can limit the orientation of clays and render interpretation of the spectra difficult. Superposition of peaks resulting from the cumulative presence of several minerals results in a widening of the signals and an abnormal rise in relative intensities, for example Chlorite (001)–Vermiculite or Kaolinite (001)–Chlorite (002). These samples require different pretreatments to reduce uncertainty and to reveal the masked peaks (cf. Sect. 4.2.4).

Peaks may display low intensity and widening even in the case of minerals that are usually well distinguished such as quartz, calcite or ordered kaolinite (001 or 002) if the sample is not thick enough. Goethites and smectites which have more diffused peaks may be masked. At certain angles, lines that come from the support are also likely to appear.

Particles of approximately 0.5  $\mu\text{m}$  are used for comparative studies on different clayey fractions and for quantitative analysis, when separation was done by ultracentrifugation. Widening at half-height of the peaks of other coarser or finer fractions must be controlled. Indeed, if the crystallites are too fine, the reflections widen; if they are too big, absorption phenomena can disturb the intensity. It should be noted that smectites are concentrated in the finest fractions; kaolinites, illites, chlorites, iron oxides in the 0.2–0.5  $\mu\text{m}$  fractions; detrital micas, chlorites, quartz, feldspars in the 0.5–2  $\mu\text{m}$  fractions. A well-crystallized but incompletely delaminated kaolinite can be found in the fine silt phase.

### *Location of the Angular Distances*

The angular location of the top of the peaks of diffraction must be transformed into interreticular distance “ $d$ ” in Å, in accordance with the Bragg equation (1) (see table or software depending on the type of anti-cathode used). Each peak should be numbered chronologically and its reticular distance given in Angströms or nanometers (international standard), along with its relative intensity. Computer equipment allows

on-screen comparisons with reference spectra and an automatic search of the JCPDS database (note 1 of Sect. 4.2.2).

The powder spectrum of *the whole soil* provides an overview of all the minerals present and of the relative intensities of the different components. The spectrum may not be easy to interpret if this is not done by comparing it with other samples of the same sequence but at least makes it possible to select appropriate samples for a more thorough examination. The *clay fractions* of the spectrum powders, which are purified and concentrated by dispersion and particle-size separation treatments, provide more precise information on the clays and on associated minerals. It is possible to determine predominant peaks with strong intensity, and assemblies of characteristic peaks at the level of the reticular distances from 7-, 10-, 12-, 14–15 Å, as well as the peaks of quartz, calcite, etc., and possibly the peaks at 4.40–4.50 Å that are identifiable in the majority of clays. The same limitations apply to complex mixtures. The peaks are often broad, and the profiles asymmetrical; smectites only display a reproducible interlayer space if their state of hydration and ionic saturation are controlled.

The presence of interstratified minerals can cause problems that are difficult to solve, especially for the di- and tri-octahedral sub-groups because of obstruction of the zone (060) around 1.50 Å. Depending on the objectives, a spectrum helps determine the strategy to be used e.g. adjustments of the experimental conditions, or of the number of oriented plates with given treatments, and possibly the need for other complementary techniques such as thermal analysis, IR spectrometry, electronic microscopy, selective dissolutions, chemical purifications, and so on.

On oriented spectra that have undergone suitable treatments basal reflections, relative intensities, regrouping of the diagnostic reflections using JCPDS-ICDD interpretation tables (note 1 in Sect. 4.2.2), can be performed rapidly on-screen using suitable software. The table designed by Brindley and Brown (1980) can also be used, it takes into account the most intense lines characteristic of clay and associated minerals in soils, classified in descending order of the values of “*d*”. The “Hanawalt Mineral Search Index” arbitrarily divides the field of the reticular distances from 999.99– to 1.00 Å into 40 groups. The first entry corresponds to the line of maximum intensity. The value “*d*” of the second line corresponds to the second strongest intensity and determines the sub-group. The entries are then classified within each sub-group by decreasing values of intensity resulting in six additional lines. Since the degree of intensity is difficult to determine, multiple entries make it

possible to integrate experimental variations: if the diffraction of a mineral includes 2 or 3 high-density peaks, there can be 2 or 3 entries (with intensities ranging from 100 to 75). The record of the location of the eight peaks should be followed by the name of the mineral and the number of complete JCPDS cards concerning this mineral. The behaviour of minerals under different chemical and thermal treatments facilitates the identification of clay minerals (see Tables 4.4 – 4.7).

### 4.3. Quantitative mineralogical analysis

#### 4.3.1 Interest

Quantitative mineralogical analysis is used to identify factors that influence or determine current or previous pedogenesis and physical and chemical properties of soils. This type of analysis is the logical continuation of qualitative analysis but many problems are involved and the precision will be influenced by the chemical and structural complexity of the substrate. For a simple substrate with two main mineralogical species, depending on the methods used, the risk of error may be around 3%, but may reach 5–10% with three species and about 30% for mixtures with  $n$  species. The presence of substances with short-range order further increases the degree of inaccuracy and can even prevent determination with certain methods, if this is the predominant mineral form. The methods use either:

- a single instrumental technique, XRD being the most widely used
- a group of techniques that make it possible to identify the centesimal composition of the sample more satisfactorily, although with increased complexity and at a higher cost.

#### 4.3.2 Quantitative Mineralogical Analysis by XRD

##### *Principle*

The advantage of these analytical methods is their relative simplicity and especially the fact that a single instrumental technique is involved. X-ray intensities obtained for each component of a mixture are directly correlated with the proportion of the component according to the equation:

$$I_p = \frac{k_p W_p}{\bar{\mu}}, \quad (4.2)$$

where  $W_p$  is the weight of compound P in the sample;  $I_p$  is the intensity of the diffraction of the pure compound P;  $k$  is the constant depending on the compound P and the experimental conditions and  $\mu$  is the attenuation coefficient of mass of the mixture.

When the substances are well crystallized and present a definite chemical composition, resulting in intense specific XRD reflections with no superposition, quantification is easy and the degree of precision is acceptable, particularly with a standard giving the same chemical characteristics. Unfortunately, the imperfection of soil minerals (structural order and disorder), the size of crystallites, chemical variability due to substitutions, and preferential orientations result in modifications in the intensity of peaks for the same mineral and even in angular displacement (which makes the selection of reference minerals for the calibration of measurements difficult). In this case the resulting measurements are very precise. When possible, the reference minerals should come from the same geological formation and have undergone the same type of pedological deterioration in order to reproduce a matrix with a similar degree of disorder and chemical composition (clays under transformation processes).

The samples for quantitative analysis have to be prepared with particular care to limit widening of the lines (over-grinding can result in an increase in structural disorder as well as in an increase in the amorphous phase), the effects of extinction and micro-absorption (crystallites and particles are too coarse), and phenomena of orientation due to the interrelationships between particles (preferential orientation). Measurements are taken on:

- powder samples that account for all the reflections; as the relative intensity of the basal reflections is low, a concentration of approximately 10% may be necessary to quantify a given compound in the mixture;
- an oriented sample which increases the basal reflections of clays, however, this involves the risk of certain components obstructing the regularity of the orientation; this technique is more sensitive and pushes back the limits of detection, but instead of preparing the sample on glass slide, the sample should be prepared on porous ceramic to eliminate the effects of sedimentation (cf. Sect. “Aggregates Oriented on Porous Ceramic Plate”).

Sample preparation can include  $Mg^{2+}$  saturation, solvation with glycerol and finally, mixing an internal standard and a matrix suppressor. The homogenization of the sample and the internal standard should be

carried out in a mixer with an agate ball. When clay samples are separated by ultracentrifugation, a check should be made to make sure there are no variations in composition (the relative proportion of each clay in the mixture may be different and cause bias). Three types of quantitative XRD methods can be used: direct analyses without standard, analyses with an external standard, analyses with an internal standard (addition of standard, matrix suppressor, etc.).

In *direct analysis with no standard* the mineral of reference is taken directly in the sample matrix. Interesting relative values will be obtained for the comparison of samples from the same sequence.

*Analysis with an external standard* does not require long preparation, but the choice of standard substances for the calculation of the intensities is difficult as is also the case with the other methods. The degree of precision is thus sometimes doubtful except for compounds that give clear reflections in a relatively pure medium with only few major components, for example well-crystallized kaolinite and quartz.

*Analysis with an internal standard:* these analyses are carried out in the presence of a standard substance presenting (i) a low attenuation coefficient, (ii) a strong XRD reflection that is narrow and is not superimposed on reflections of the minerals to be determined, and, if possible, is low in harmonics and (iii) a density that is close to the minerals in the mixture enabling better homogenization.

The  $\alpha\text{Al}_2\text{O}_3$  corundum was adopted in 1976 by JCPDS (see note 1 in Sect. 4.2.2) as the standard of reference for the quantitative study of minerals (high-purity synthetic corundum, 1  $\mu\text{m}$  particle size, Linde, by Union Carbide or similar). The basal reflection at 2.085 Å ( $I = 100$  for the 1,1,3 plane) is clear. Crystallinity can be increased by heating at 800°C for 1 h. There is no preferential orientation. The 2.106 Å line of MgO, and the 6.11 Å line of Boehmite  $\gamma\text{AlOOH}$  can also be used.

Several procedures and modes of calculation can be used, e.g. standard additions or matrix suppression. The standard additions method is time consuming and requires the construction of curves of calibration. The technique of Chung (1974 a,b) with matrix suppression is faster and if required, makes it possible to identify the presence of amorphous minerals with short-range organization in the differential balance<sup>4</sup>. However it is necessary to obtain spectra whose principal reflections do not include diffuse bands or zones of superposition as the treatment of these signals is too complex. This method enables elimination of the

---

<sup>4</sup> If the soil sample contains undestroyed organic matter or substances that are transparent to X-ray, these substances can be found in the differential balance.



matrix effects from the intensity – concentration, and all the intensities are obtained with only one scan, which reduces possible instrumental errors.

### **Procedure**

A spectrum is performed on powder samples, on the pure corundum and on the sample mixture + corundum:

- weigh a known weight of corundum (c) and a known weight of sample (A); the proportion of the mixture should be 1:1
- homogenize in a horizontal mixer with a bowl and an agate ball for 20 min
- pour the powder into a support and pack slightly; level with a razor blade to obtain a smooth but not oriented surface; the reference plane must be perfect<sup>5</sup>.
- place on a diffractometer under standard conditions using a Cu tube, a variable slit and a graphite monochromator with a time constant enabling accumulation of at least 20,000 counts per peak (minus background noise) and a  $2\theta$  scanning rate of  $0.5^\circ \text{ min}^{-1}$  (or even  $0.25^\circ 2\theta \text{ min}^{-1}$ ); only scan the zone containing significant peaks
- locate the position of the most intense diffracted peaks that are representative of each component, determine their intensity and compare with the internal standard – what does this dash imply? matrix suppressor.

### **Calculations**

Based on the nature of monochromatic X-ray radiation of a defined wavelength, the nature of the matrix effects (absorption) and the basic equation of Klug and Alexander (1959), Chung mathematically extracted the effects of attenuation of mass:

$$I_i = \frac{k_i X_i / Q_i}{\sum \mu_i X_i} = \frac{k_i X_i / Q_i}{\mu_i} \quad (4.3)$$

where

$I_i$  is the intensity of the X-ray diffracted by a selected plane of component  $i$  (unknown);

---

<sup>5</sup> Certain authors prefer to prepare the samples by pelletization although there is a risk of causing a certain orientation of the powder due to the very strong pressure applied. However, there will be fewer errors connected with surface quality or the density of sites likely to diffract.

$k_i$  is the constant which depends on the geometry of the diffractometer and the nature of component  $i$ ;

$X_i$  is the weight of the fraction of component  $i$ ;

$Q_i$  is the density of component  $i$ ;

$\mu_i$  is the coefficient of mass absorption (or attenuation coefficient of mass) of the pure component  $i$ ;

$\mu_t$  is the coefficient of absorption of the total sample including component  $i$ , the internal standard and possibly a reference material.

The last two terms characterize the effect of adsorption which is often difficult to measure with other methods. The introduction of a definite weight of a matrix suppressor (corundum resembling an internal standard) makes it possible to introduce:  $X_f$  is the weight of the matrix suppressor ( $f$ , flushing agent) and  $X_o$  is the weight of the sample, and the

equation:  $X_f + X_o = X_f + \sum_{i=1}^n X_i = 1$

$n$  being the number of components of the sample, and

$$(I_i/I_f) (I_f^0/I_i^0) = (X_i/X_f)(\mu_i/\mu_f),$$

where  $I_f^0$  and  $I_i^0$  represent the intensities of the X-ray diffracted by a selected plane of each pure component. By introducing the ratio of intensity of reference  $K_i = I_i/I_c$ , and other substitutions, one arrives at the equation:

$$X_i = X_f (k_f/k_i)(I_i/I_f), \quad (4.4)$$

which gives the relation between intensity and concentration from which the effect of matrix is eliminated and which is used for quantitative multi-component analysis. With corundum as matrix suppressor the final simple equation ( $k_f = k_c = 1$ ) is:

$$X_i = (X_c/k_i)(I_i/I_c), \quad (4.5)$$

where

$X_i$  is the weight of the sample fraction;

$X_c$  is the weight of corundum;

$I_i$  is the diffracted intensity of sample;

$I_c$  is the diffracted intensity of corundum;

$k_i = I_i/I_c =$  intensity ratio of reference (Table 4.8).

### Remarks

Using computerized equipment, it is possible to take into account the height of the reflection and the width at mid-height<sup>6</sup> or the surface of the  $d(001)$  reflections which the software calculates automatically taking stabilized background noise into account.

Complementary measurements may be necessary on oriented samples:  $Mg^{2+}$  saturated or solvated samples, and the use of multiplicative coefficients accounting for the structure of the minerals (fibrous clays with pseudo-layers that do not give very intense reflections, etc.).

It is possible to combine the results of the average of two reflections as this can provide information on crystallinity, etc. The choice will depend on the shape of the diffractogram, the nature of the components, and the degree of precision desired.

**Table 4.8.** Recommended values of  $I_i/I_c$  ratios (Eq. 5) from Bayliss (1986)

Mineral	$I/I_c$	$d$ (Å)	Mineral	$I/I_c$	$d$ (Å)
allophane	0.1	3.3	illite- montmorillonite	0.4	12
biotite	9.0	10.0	kaolinite 1Md	1.1	7.1
boehmite	1.0	6.11	kaolinite 1T	2.1	7.1
calcite	3.7	3.03	muscovite	2.2	10
corundum	1.0	2.09	quartz	4.3	3.35
dickite	2.9	7.2	smectite	3.0	15
gibbsite	1.6	4.85	talc	1.5	9.3
goethite	1.4	4.18			
gypsum	2.2	2.87			
hematite	0.9	2.70			
illite	0.7	10			

For the same mineral species, values of  $k_i$  may vary with the geological origin and the nature of pedological alteration and measurements must thus be carried out under the same conditions. The choice of minerals is made after chemical analysis and XRD.

<sup>6</sup> If it is necessary to compare samples by measuring intensity, it should be noted that the ratio of the heights of the peaks is only valid if the widths at mid - height are identical for the two samples.

The  $I_i/I_c$  ratio is affected by crystallinity, it approaches 0 if the mineral is not crystalline (allophane – materials with short-range organization) and can reach 8–9 if the size of crystallites and crystallinity is optimum. Chemical substitutions (e.g. heavy  $\text{Fe}^{2+}$  minerals replacing light  $\text{Mg}^{2+}$  minerals) cause variations in the  $I_i/I_c$  ratio.

### 4.3.3 Multi-Instrumental Quantitative Mineralogical Analysis

Quantitative methods based on XRD have limited precision particularly when dealing with complex assemblies that give diffuse reflections or reflections that are more or less masked by superposition, or when there is a significant quantity of substances amorphous to X-rays. Multi-instrumental methods combine measurements based on XRD and other chemical and physical measurements making it possible to characterize the different elements. Measurements are generally made on clay fractions, but these measurements can be supplemented by others, for example organic matter destroyed by hydrogen peroxide, carbonates, soluble salts, iron oxides, etc. eliminated during extraction of the  $<2 \mu\text{m}$  clay fraction, and finally by analysis of sands and silts separated by sieving.

These methods can only be used in specialized laboratories that have a wide range of instrumental methods such as XRD, IR, TEM, DTA-TGA, AA, ICP, etc., at their disposal. Each component of a mixture has its own chemical and physical characteristics that can be measured. First XRD spectra are qualitatively interpreted to identify clayey minerals (cf. Sect. 4.2.4 and 4.2.5).

Roberts (1974) and Robert et al. (1991) quantified the different elements using their specific properties. The organization, size, and shape of the particles make it possible the right choices and to enhance identification by methods like TEM-HR, STEM, EDX (see Chap. 8) of minerals that only present in small quantities and cannot be detected by XRD. Thermal analysis may be essential for the quantification of kaolinite, oxyhydroxides and chlorite. Losses between 110–300, 300–600, 600–950°C are used. Corrections for the oxidation of iron at high temperatures are required.

Total chemical analysis of clay by a HF–HCl attack (cf. Chap. 31) makes it possible to determine the proportions of the different elements present, which is essential for the identification of the structure of the different mineral phases. Total K enables estimation of micas on the basis of 7.5% of K for illites compared to 8.3 – 10% of K for the other micas. Analysis by “selective” dissolution (cf. Chap. 6) using suitable procedures enables certain phases to be preferentially dissolved without

the other elements in the matter undergoing a significant attack. For example, the attack of a sample (heated at 110°C for 4 h) by a 0.5 mol (NaOH) L<sup>-1</sup> solution followed by boiling for 2 min 30 makes it possible to extract allophane (42.7% SiO<sub>2</sub>–36.3% Al<sub>2</sub>O<sub>3</sub>) and noncrystalline compounds such as colloidal silica (a little montmorillonite and vermiculite is dissolved). Fusion with pyrosulphate or possibly a tri-acid attack (H<sub>2</sub>SO<sub>4</sub>–HNO<sub>3</sub>–HCl) enables isolation of quartz and feldspars in the residue from the attack. This residue is then weighed. The weight should be increased by 3% to compensate for the slight dissolution of quartz and feldspars. The residue is then analyzed by XRD to detect the presence of feldspar then can be analyzed chemically after dissolution. Dissolution with Tamm reagent (in darkness or with UV photolysis) enables isolation of noncrystalline forms of iron and the CBD method (see Chap. 6) enables isolation of crystalline iron hydroxides.

Analyses that identify the activity of clays can enable separation of certain types of 2:1 clay based on their cation exchange capacity using several different treatments: Na<sup>+</sup> saturation and displacement by Mg<sup>++</sup>, Mg<sup>2+</sup> saturation and displacement by ammonium acetate, etc. The total specific surface (external and/or internal) can be determined using the (EGME) method, by absorption of methylene blue, or by the BET method.

**Table 4.9.** Some properties of minerals used for the adjustment of the results

	CEC (cmol kg <sup>-1</sup> )	Specific surface (m <sup>2</sup> g <sup>-1</sup> )	Water loss 540–900°C (%)
mica	25	175	0.50
quartz	2	25	0
feldspars	2	25	0
allophane	100	800 – 1,000	0
kaolinite	5 – 10	45	0
colloidal SiO <sub>2</sub>	20	200	2
montmorillonite	80 – 100	800	0.88
vermiculite	175 – 200	440	1.83
chlorite	25	175	12.30

All this quantitative information is imported into the software making it possible to specify the proportion of each component in the mixture, to

assign the limits of the properties for the various compounds, and to select options for calculations.

## References

- Anton O and Rouxhet PG (1977) Note on the intercalation of kaolinite, dickite and halloysite by dimethyl-sulfoxide. *Clays Clay Minerals*, 25, 259–263
- Bayliss P (1986) Quantitative analysis of sedimentary minerals by powder X-Ray diffraction. *Powder diffraction*, 1, 37–39
- Brindley GW and Brown G (1980) Crystal structure of clay minerals and their X-Ray identification. *Mineralog. Soc.*, 415–438
- Calvert CS (1984) Simplified, complete CsCl–hydrazine–dimethylsulfoxide intercalation of kaolinite. *Clays Clay Miner.*, 32, 125–130
- Chassin P (1974) Influence de la stéréochimie des diols sur la formation des complexes interfoliaires de la montmorillonite calcique. *Clay Miner.*, 11, 23–30
- Chung FH (1974a) Quantitative interpretation of X-Ray diffraction pattern of mixtures. I- matrix flushing method for quantitative multi-component analysis. *J. Appl. Crystallog.*, 7, 519–525
- Chung FH (1974b) Quantitative interpretation of X-Ray diffraction patterns of mixtures. II – Adiabatic principle of X-Ray diffraction analysis of mixtures. *J. Appl. Crystallog.*, 7, 526–531
- Churchman GJ, Whitton JS, Claridge GGC and Theng BKG (1984) Intercalation method using formamide for differentiating halloysite from kaolinite. *Clays Clay Miner.*, 32, 241–248
- Decarreau A (1990) Les poudres : techniques expérimentales et interprétation des diagrammes – Facteurs déterminant le mode d'empilement. In *Structure, propriétés et applications. Société Française de Minéralogie et cristallographie*, Groupe Français des Argiles, 209–236
- Eltantawy IM and Arnold PM (1974) Ethylene glycol sorption by homoionic montmorillonites. *J. Soil Sci.*, 25, 99–110
- Gonzalez Garcia S. and Sanchez Camazano M. (1968) Differentiation of kaolinite from chlorite by treatment with dimethylsulfoxide. *Clay Miner. Bull.*, 7, 447–450
- Klug HP and Alexander LE (1974) *X-Ray diffraction procedures*. Wiley 2nd edition
- Modre DZ and Dixon JB (1970) Glycerol vapor adsorption on clay minerals and montmorillonite soil clays. *Soil Sci. Soc. Am. Proc.*, 34, 816–822
- Olejnik S, Aylmore LAG, Posner AM and Quirk JP (1968) Infra-red spectra of kaolin mineral-dimethyl sulfoxide complexes. *J. Phys. Chem.*, 72, 241–249
- Paterson E, Bunch JL and Duthie DML (1986) Preparation of randomly oriented samples for X-Ray diffractometry. *Clay Miner.*, 21, 101–106
- Range KJ, Range A and Weiss A (1969) Fireclay type kaolinite or fire-clay mineral? Experimental classification of kaolinite – halloysite minerals. *Proceedings of the International Clays Conference (Tokyo)*. Israel Universities Press, 3–13

- Roberts JM Jr (1974) *X-Ray diffraction and chemical techniques for quantitative soil clay mineral analysis*. Engineering Thesis, Pennsylvania State University, 78 pages
- Robert M, Hardy M and Elsass F (1991) Crystallochemistry, properties and organization of soil clays derived from major sedimentary rocks in France. *Clay Miner.*, 26: 409–420
- Thomson A, Duthie DM, Wilson MT (1972) Randomly oriented powders for quantitative determination of clay minerals. *Clay Miner.*, 9, 345–348
- Wada K and Yamada H (1968) Hydrazine intercalation, intercalation for differentiation of kaolin mineral, from chlorites. *Am. Miner.*, 53, 334–339

## Bibliography

### General

- Alekseeva TV, Alekseev AO, Sokolovska Z, Khainos M, Sokolowska Z and Hajnos M (1999) Relationship between mineralogical composition and physical properties of soils. *Pochvovedenie.*, 5, 604–613
- Brindley GW and Brown E (1980) *Crystal structure of clay minerals and their X-Ray identification.*, Mineralogical Society, 495 p
- Caillère S, Hénin S and Rautureau M (1982) *Minéralogie des argiles, 1*, Masson, 184 p
- Caillère S, Hénin S and Rautureau M (1982) *Minéralogie des argiles, 2*, Masson, 189 p
- Charley H (1989) *Clay Sedimentology.*, Springer Belin Heidelberg New York, 623 p
- Dixon JB and Weed SB (1989) *Minerals in soil environments.*, Soil Science Society of America (USA), 2e édition, 1244 pp.
- Gautheyrou J and Gautheyrou M (1979) *Etude des argiles par diffraction X. Synthèse bibliographique pour l'identification des argiles.*, Guide pratique. ORSTOM-Antilles, notes de laboratoires, ORSTOM (26 pages + 2 annexes).
- ICDD (JCPDS-ASTM) *Mineral powder diffraction File – PDF-1 DATA BASE* (powder diagrams, interlayer spaces, relative intensity, chemical name, mineralogical formula) - PDF-2 DATA BASE (powder diagram, interlayer spaces, relative intensity, chemical name, mineralogical name, Miller's indice, unit cell, physical properties, references) – Shorten ICDD ref: eliminate – version papier (SET 1 à 36, SET 1 à 8 révisés, SETS 37, 38, 39, 40, 41) – version disque compact (CD-ROM DISC SETS 1-41 inorganique – organique pour IBM PC, VAX, McIntosh) – SEARCH MANUAL Alphabetical index – inorganic phases. Hanawalt index – inorganic phases (remise à jour annuelle), ICDD Newton Square PA 19073-3273 (USA)
- Inigo AC, Tessier D, Pernes M (2000) Use of X-ray transmission diffractometry for the study of clay-particle orientation at different water contents. *Clays Clay Miner.*, 48, 682–692

- Kovda IV, Morgun EG, Tessier D, Pernes M (2000) Particle orientation in clayey soils according to transmission diffractometry data, 8, 989–1003
- Manhães RST, Auler LT, Sthel MS, Alexandre J, Massunaga MSO, Carrió JG, dos Santos DR, da Silva EC, Garcia-Quiroz A and Vargas H (2002) Soil characterisation using X-ray diffraction, photoacoustic spectroscopy and electron paramagnetic resonance. *Appl. Clay Sci.*, 21, 303–311.
- Martins E de S, de S Martins E (2000) Integrated method of mineralogical characterization of deeply weathered soils. *Comunicado Tecnico Embrapa Cerrados.*, Brazil, 37, 5 pp.
- Millot G (1964) *Géologie des argiles*. Masson, Paris, 499 pp.
- Newman AC (1987) *Chemistry of clays and clay minerals.*, Mineralogical society, monograph no 6, 480 p
- Chen PY (1977) *Table of key lines in X-Ray powder diffraction patterns of minerals in clays and associated rocks*. Dept. of Natural resources, (Indiana, USA). Geological Survey occasional paper no 21, 67 p
- Robert M (1975) Principes de détermination quantitative des minéraux argileux à l'aide des rayons X. Problèmes particuliers posés pour les minéraux argileux les plus fréquents dans les sols des régions tempérées. *Ann. Agron.*, 26, 363–399
- Stucki JW (Goodman BA and Schwertmann U (1985) *Iron in soils and clay minerals.*, D. Reidel, 893 p.
- Teissier D (1984) *Etude expérimentale de l'organisation des matériaux argileux. Hydratation, gonflement et structuration au cours de la dessiccation et de la réhumectation.*, INRA, Thèse doc. Etat, 361 pp.
- Thorez (1975) *Phyllosilicates and clay minerals. A laboratory handbook for their X-Ray diffraction analysis.*, Lelotte Ed., 579 p
- Wilson MJ (1987) *A handbook of determinative methods in clay mineralogy.*, Blackie – Chapman and Hall, 308 p.

### **Preparation of Oriented Aggregates on Porous Ceramic Plate**

- Kinter EB and Diamond S (1956) A new method for preparation and treatment of oriented-aggregat specimens of soil clays for X-Ray diffraction analysis. *Soil Sci.*, 81, 111–120
- La Manna JM and Bowers FH (1985) A suction apparatus for orienting clay minerals into porous ceramic tile. *Soil Sci. Soc. Am. J.*, 49, 1318–1319
- Rich CI (1969) Suction apparatus for mounting clay specimens on ceramic tile for X-Ray diffraction. *Soil Sci. Soc. Am. Proc.*, 33, 815–816
- Shaw HF (1972) The preparation of oriented clay mineral specimens for X-Ray diffraction analysis by a suction unto ceramic tile method. *Clay Miner.*, 9, 349–350



### Saturation of Clays by Cations

- Brindley GW and Ertem G (1971) Preparation and solvation properties of some variable charge montmorillonite. *Clays Clay Miner.*, 19, 399–404
- Bühmann C, Fey MV and De Villiers JM (1985) Aspects of the X-Ray identification of swelling clay minerals in soils and sediments. *S. Afri. J. Sci.*, 81, 505–509
- Calvet R and Prost R (1971) Cation migration into empty octahedral sites and surface properties of clays. *Clays Clay Miner.*, 19, 175–186
- Hofmann U and Klemen R (1980) Verlust der Austauschfähigkeit von Lithiumionen an Bentonit durch Erhitzung (perte d'échangeabilité des ions lithium dans les bentonites après chauffage). *Zeit. Anorganisc Chem.*, 262, 95–99
- Lim CH and Jackson ML (1986) Expandable phyllosilicate reactions with lithium on heating. *Clays Clay Miner.*, 34, 346–352

### Saturation, Solvation, Intercalation Complexes, Dissolution

- Barnhisel RI and Bertsch PM (1989) Chlorites and hydroxy-interlayered vermiculite and smectite. In *Minerals in soil environments* Dixon JB and Weed SB ed., Soil Sci. Soc. of Am., 729–740
- Barnhisel RI (1977) Chlorites and hydroxy interlayered vermiculite and smectite, 331–356. In *Minerals in soil environments*, Dixon JB and Weed SB ed., Soil Sci. Soc. Am., Monogr., 331–356
- Brindley GW (1966) Ethylene glycol and glycerol complexes of smectites and vermiculites. *Clay Miner.*, 6, 237–260
- Brindley GW and Ertem G (1971) Preparation and solvation properties of some variable charge montmorillonites. *Clays clay Miner.*, 19, 399–404
- Churchman GJ (1990) Relevance of different intercalation tests for distinguishing halloysite from kaolinite in soils. *Clays and clay Minerals*, 38, 591–599
- Follet EAC, McHardy WJ, Mitchell BD and Smith BFL (1965) Chemical dissolution techniques in the study of clays. Part 1. *Clay Miner.*, 6, 23–24
- Novich BE and Martin RT (1983) Solvation methods for expandable layers. *Clays Clay Miner.*, 31, 235–238
- Suquet H, Iiyama JT, Kodama H and Pezerat N (1977) Synthesis and swelling properties of saponites with increasing layer charge. *Clay Miner.*, 25, 231–242
- Suquet M, Calle de la C and Pezerat H (1975) Swelling and structural organization of saponite. *Clays Clay Miner.*, 23, 1–9
- Theng BKG, Churchman GJ, Whitton JS and Claridge CGC (1984) Comparison of intercalation methods for differentiating halloysite from kaolinite. *Clays Clay miner.*, 32, 249–258
- Walker GF (1958) Reactions of expanding-lattice clay minerals with glycerol and ethylene glycol. *Clay Miner. Bull.*, 302–313

White JL and Jackson ML (1947) Glycerol solvation of soil clays for X-Ray diffraction analysis. *Soil Sci. Soc. Am. Proc.*, 11, 150–154

### Preparation of Iron Oxides

- Brown G and Wood IG (1985) Estimation of iron oxides in soil clays by profile refinement combined with differential X-Ray diffraction. *Clay Minerals*, 20, 15–27
- Campbell AS and Schwertmann U (1985) Evaluation of selected dissolution extractants in soil chemistry and mineralogy by differential X-Ray diffraction. *Clay Miner.*, 20, 515–519
- Meunier A and Velde B (1982) X-Ray diffraction of oriented clays in small quantities (0,1 mg). *Clay Miner.*, 17, 259–262
- Paterson E, Bunch SL and Duthie DML (1986) Preparation of randomly oriented samples for X-Ray diffractometry. *Clay Miner.*, 21, 101–106
- Schwertmann U and Taylor RM (1989) Iron oxides. In *Minerals in Soil environments*, Dixon JB and Weed SB ed. Soil Sci. Soc. Am., 379–438
- Schwertmann U, Murad E and Schulze DG (1982) Is there Holocene reddening (hematite formation) in soils of a xeric temperate area. *Geoderma*, 27, 209–223
- Torrent J, Schwertmann U and Schulze DG (1980) Iron oxyde mineralogy of some soils of two river terrace sequences in Spain. *Geoderma*, 23, 191–208

### Quantitative XRD

- Austin GS and Leininger RK (1976) Effect of heat-treating mixed-layer illite-smectite as related to quantitative clay mineral determinations. *J. Sedim. Petrol.*, 46, 206–215.
- Brime C (1985) The accuracy of X-Ray diffraction methods for determining mineral mixtures. *Miner. Mag.*, 49, 531–538
- Carter RJ, Hatcher MT and Di Carlo L (1987) Quantitative analysis of quartz and cristobalite in bentonite clay based products by X-ray diffraction. *Anal. Chem.*, 59, 513–519
- Cody RD and Thomson GL (1976) Quantitative X-ray powder diffraction analysis of clays using an oriented internal standard and pressed discs of bulk shale. *Clays Clay Miners*, 24, 224–231
- Davis BL (1980) Standardless X-Ray diffraction quantitative analysis. *Atmosph. Environ.*, 14, 217–220
- Decler J (1985) Comparaison between mounting techniques for clay minerals as a function of quantitative estimations by X-ray diffraction. *Bull. Soc. Belge Géol.*, 94, 275–281
- Gavish E and Friedman GF (1973) Quantitative analysis of calcite and Mg-calcite by X-ray diffraction effect of grinding on peak height and peak area. *Sediment.*, 20, 437–444

- Goehner RP (1982) X-Ray diffraction quantitative analysis using intensity ratios and external-standards. *Adv. in X-Ray Analy.*, 25, 309–313
- Heath GR and Pissas NG (1979) A method for the quantitative estimation of clay minerals in North Pacific deep sea sediments. *Clays Clay Miner.*, 27, 175–184
- Hogson M. and Dudgey ANL (1984) Estimation of clay proportions in mixtures by X-Ray. Diffraction and computerized chemical mass balance. *Clays and Clay Miner.*, 32, 19–28
- Hooton DH and Giorgetta NE (1977) Quantitative X-Ray diffraction analysis by a direct calculation method. *X-Ray Spectrom.*, 6, 2–5
- Hubbard CR and Smith DK (1977) Experimental and calculated standards for quantitative analysis by powder diffraction. *Adv. X-Ray Anal.*, 20, 27–39
- Hubbard CR, Evans EH and Smith DK (1976) The reference intensity ratio  $I/I_c$  for computer simulated powder patterns. *J. Appl. Cryst.*, 9, 169–174
- Johnson LJ, Chu CH and Hussey GA (1985) Quantitative clay mineral analysis simultaneous linear equations. *Clays and Clay Miner.*, 33, 107–117.
- Kahle M, Kleber M and Reinhold J (2002) Review of XRD-based quantitative analyses of clay minerals in soils: the suitability of mineral intensity factors. *Geoderma*, 109, 191–205
- Norrish K and Taylor RM (1962) Quantitative analysis by X-Ray diffraction. *Clay Miner. Bull.*, 5: 98–109
- Ouhadi VR and Yong RN (2003) Impact of clay microstructure and mass absorption coefficient on the quantitative mineral identification by XRD analysis. *Appl. Clay Sci.*, 23, 141–148
- Parrot JF, Verdoni PA and Delaune-Mayere (1985) Analyse modale semi-quantitative d'après l'étude des Rayons X. *Analisis*, 13, 373–378
- Pawloski GA (1985) Quantitative determination of mineral content of geological samples by X-Ray diffraction. *Am. Mineral.*, 70, 663–667
- Persoz (1969) Fidélité de l'analyse quantitative des poudres de roches par diffraction X. *Bull. Centre Rech. Pau (SNPA)*, 3, 324–331
- Renault J (1987) Quantitative phase analysis by linear regression of chemistry on X-Ray diffraction intensity. *Powder Diffract.*, 2, 96–98
- Ruffell A. and Wiltshire P. (2004) Conjunctive use of quantitative and qualitative X-ray diffraction analysis of soils and rocks for forensic analysis. *Forensic Science International*, 145, 13–23
- Taylor RM and Norrish K (1972) The measurement of orientation distribution and its application to quantitative determination of clay minerals. *Clay Miner.*, 9, 345–348
- Tomita K and Takahashi H (1985) Curves for the quantification of mica/smectite and chlorite/smectite interstratifications by X-Ray powder diffraction. *Clays Clay Miner.*, 33, 379–390.

## Mineralogical Analysis by Infra-Red Spectrometry

### 5.1 Introduction

#### 5.1.1 Principle

The interaction of matter with infra-red (IR) radiation makes it possible to characterize energies of vibration of the molecules on several components (Fig. 5.1): along the axis of the chemical bonds (vibrations of valence or stretching, which, apart from diatomic molecules, are seldom pure) and deformations that are perpendicular to the bond axis (rotation, torsion, shearing, swinging, librations, bending). IR radiations correspond to these energy levels. IR absorption occurs when the frequency of the radiation is equal to that of the vibrations.

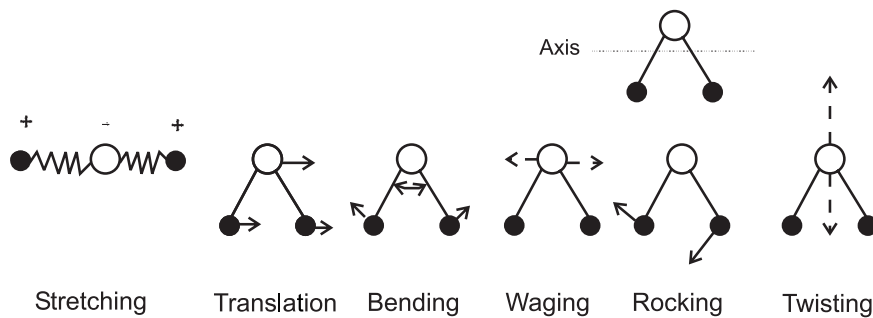

**Fig. 5.1.** Examples of vibration of a simple polyatomic molecule

IR adsorption spectroscopy uses radiations ranging between the visible waves and microwaves. This field is usually divided into three energy zones: near-IR, medium IR and far IR (Fig. 5.2). In these zones, different molecular vibrations correspond to the energy of IR radiations.

- Near infra-red (NIR), as well as visible and UV, account for the high-energy electronic spectra related to fundamental orbitals, for example the change from a link orbital to an empty orbital of higher energy; NIR spectrometry is currently being developed for the study of soil organic matter (cf. Sect. 5.3.1 and Part 2 of this book).
- Medium IR, ranging between 300 and 5,000  $\text{cm}^{-1}$  makes it possible to observe vibrations involving protons, (vibrations that correlate well with structure and whose transitions correspond to slight modifications in stretching or deformation of the bond angles in the molecule). Unit cells of clays (crystallographic units) contain polyatomic ions or molecules whose internal modes of vibrations occur between 4,000 and approximately 400  $\text{cm}^{-1}$ . These vibratory states have been the subject of detailed studies in mineralogy. Absorption bands make it possible to characterize active molecular groupings satisfactorily.
- Other modes of vibrations which come from the lattice can occur after displacement of a polyatomic group within a unit cell in far IR at very low frequencies between 200 and 10  $\text{cm}^{-1}$ . This field, which has not been extensively explored to date, is now accessible thanks to the development of IR spectrometers. Bands of rotational transitions that are not widely spaced enable quantification of the number of revolutions around an axis without stretching or notable modification of the bound angles that are characteristic of the geometry of the crystal.

IR spectrometry is thus used as a complement for X-ray diffraction and chemical and thermal analysis. XRD (cf. Chap. 4) expresses long-distance periodicity satisfactorily, but is not effective in the case of substances that are amorphous to X-ray or minerals with short-range arrangement that appear during sequences of alteration.

With IR, a spectral signature can be identified, along with the nature and the direction of the bonds, and our understanding improved of atomic structures, as well as of the degree of isomorphic substitution in the tetrahedral (Si–Al) and octahedral (Al–Mg) layers. These data are needed to identify certain minerals, to quantify molecular water and constitutive hydroxyls and to detect the presence of crystalline or non-crystalline impurities, which influence the regularity of the lattice structure.

In clays and clay minerals only some molecular groups are likely to vibrate and the spectra are often less complex than for certain organic substances.



under liquid nitrogen or helium) should all be taken into account. The detector can be:

- non-selective e.g. a thermocouple or thermopile (several couples connected in series), a bolometer with doped germanium for far IR that operates in liquid helium (2 K), MCT detectors (Mercury, Cadmium, Tellurium), DTGS detectors (Deuterium enriched Triglycine Sulphates) thermostated for medium IR, detectors of Golay with a gas chamber for far IR; these detectors are very sensitive, but very fragile;
- selective (photon–electron transformation as a function of the wavelength), e.g. lead sulphide, lead selenide, or indium antimonide detectors that function in liquid nitrogen.

The optical system can be based on *a dispersive mode* or managed by *interferometry* in a mono or double beam system.

*In dispersive mode* radiation crosses the sample from where it partially arises (transmission-absorption) to strike a dispersive lattice or a monochromator which divides the beam as a function of wavelength (Fig. 5.3a). Energy is recorded point by point by rotation of the lattice. It is first necessary to determine the zero point of the instrument, and then to determine the basic spectrum without a sample to take into account in particular the CO<sub>2</sub> and H<sub>2</sub>O in the air. Transmittance is calculated at each wavelength by the ratio of the two signal-to-noise values. The resolution is often insufficient and energy decreases with an increase in wavelength, which makes it necessary to gradually open the slit of the monochromator and modify the background noise. These operations can be automated, and the degree of precision can be increased by the use of a double beam and measurements on sample and blank taken alternately at each wavelength with the help of a modulator. In this way the energy of the beam is maintained constant. The study of far IR is not possible because of the nature of the apparatuses and insufficient energy. Radiometric apparatuses are slow and top-of-the-range models are very expensive, as several high resolution lattices are necessary for satisfactory linear dispersion.

Better performances can be obtained by using *an interferometric system* linked with data processing by Fourier transform (Fig. 5.3b). Interferometry is based on rapid movements of a mirror. Each wavelength is modulated at a characteristic frequency determined by the speed of the mirror. The recording of the complex data gives an interferogram that is treated in real time by the Fourier transform. This makes it possible to obtain a spectrum where the amplitude of the signal is recorded as a function of the frequency.

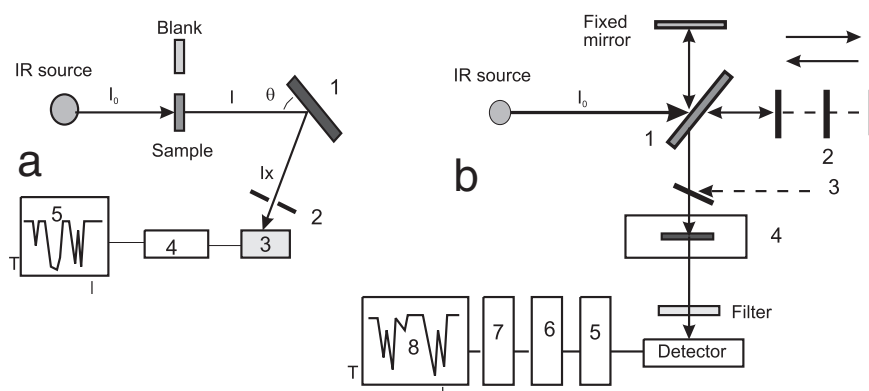

**Fig. 5.3.** Types of Infra-red spectrometers: **(a)** Dispersive 1: dispersive system: prisms, lattices, monochromator, continuous high resolution interferential wedge, 2: exit slit for precise selection of the field of frequency, 3, 4, 5: detection, amplification and acquisition,  $I_0$ ,  $I$ ,  $I_x$ : total incident and transmitted intensities at the selected wavelength  $x$ ,  $T$ : transmittance  $I/I_0$  corresponding to the absorbance  $A = -\log T$  **(b)** With interferometer and Fourier transform 1: separation made of KBr with germanium film (400–4,000  $\text{cm}^{-1}$ ) or made of MYLAR (0–700  $\text{cm}^{-1}$ ); 2: mobile mirror, spectral composition is a function of the position of the mirror, function resolution of the amplitude of displacement, 3: He–Ne laser for measuring movements of the mobile mirror and indexing mirror direction, 4: sample compartment under vacuum or controlled atmosphere, 5: intensity/position of mirror, 6: interferogram, 7, 8: real-time data acquisition system

In the Michelson interferometer, the polychromatic radiation of the source is divided into two beams by a separation made of KBr or Mylar (covered with a germanium film to filter radiations of the visible spectrum). One of the two beams is sent to a fixed mirror, the other to a mobile mirror that is moved at a known speed by a linear motor. The two beams are then recombined by the beam splitter. The resolution depends on the maximum stroke of the mobile mirror. Alignment must be maintained during the movement of the mobile mirror with no vibrations or slope likely to deform the spectra and to give erroneous transmittance values. An in–out movement of the mirror allows simultaneous analysis of all the wavelengths of IR radiation.

The changes in the signal reflect variations in modulation of the interferogram. The results are recorded at the different positions of the mirror, which requires knowing its exact position by laser radiation. Each individual signal is located by multiplexing and decoding. The whole spectrum is scanned sequentially as a function of time in less than one second.



To limit the influence of moisture and atmospheric CO<sub>2</sub>, the optical circuits function in a sealed enclosure, except for the sample compartment which can be purged with dry nitrogen.

The resolution is generally about 2–4 cm<sup>-1</sup> but can reach 0.1 cm<sup>-1</sup> at the price of additional memory which otherwise requires a powerful information processing system.

FTIR apparatuses are generally mono-beam and more rarely, in top-of-the-range models, double-beam which enables the signal-to-noise ratio to be maintained uninterrupted. Suitable software makes it possible to control the spectrometer, collect the results and process the data in real time to restore the spectrum. If necessary, a database search makes it possible to compare the spectra with IR bases for identification, calibration, subtraction of spectra, etc. Calibration is carried out with polystyrene blades that have narrow intense bands distributed between 699 and 3104 cm<sup>-1</sup>.

In practice, the choice of an apparatus is based primarily on the scientific objectives which determine the main requirements: the wavelength field to be scanned, the nature of materials to be analysed (solid, liquid, gas), the required sensitivity, resolution, data-processing capacity and quality of the software, possible extensions of the basic module (coupled with e.g. liquid or gas chromatography, EGA thermal analysis, Raman spectroscopy, IR or Raman microscopy). As far as price is concerned, instead of purchasing a very expensive top-of-the-range “universal” apparatus, two dedicated complementary apparatuses can be adapted for repetitive laboratory tasks.

For routine soil analysis, an apparatus that covers medium IR up to 220–250 cm<sup>-1</sup> with an optical system in KBr or better still in CsI and a resolution of about 2 cm<sup>-1</sup> is sufficient, but for a more specialized laboratory, access to the field of far IR is now necessary.

## 5.2 IR spectrometry in Mineralogy

### 5.2.1 Equipment and Products

- Ultra-microbalance, 10<sup>-6</sup> g sensitivity, range 2–5 g
- IR or FTIR spectrometer suitable for the required ranges of wavelengths

- IR microscope
- binocular magnifier ( $\times 100$ )
- pellet press ( $10 \text{ tons cm}^{-2}$ )
- centrifuge with centrifugation chambers (cf. Chap. 4)
- cooled moisture-proof vibrating grinder with agate ball for crushing in liquid medium
- drying oven ( $105^\circ\text{C}$ ) with precise electronic regulation
- Pyrex glass desiccator
- lab glassware
- quality IR products: KBr, CsI, polyethylene, Nujol (paraffin oil), AgCl,  $\text{CaF}_2$ , IR TRAN 4, solvents, hexachlorobutadiene (Votalef oil), Fluorolube (fluorinated hydrocarbon oil), various mineral standards.

## 5.2.2 Preparation of the Samples

### *Types of Preparation*

The preparation of the sample for analysis by IR spectrometry is of prime importance: it conditions the spectral field of analysis and its limits, and indirectly, the sensitivity and the selectivity of measurements.

Determination must be performed on elementary particles that do not exceed  $5 \mu\text{m}$  and even  $1$  or  $2 \mu\text{m}$  if the MULL technique is used or if quantitative analyses are required.

Clay fractions with a particle size  $< 2 \mu\text{m}$  in  $\text{H}^+$ ,  $\text{NH}_4^+$  or  $\text{X}^+$  form, or better fractions  $< 0.5 \mu\text{m}$  purified with a standard Sharples ultra-centrifuge (cf. Chap. 3) are usually used for analysis. Because of the size of their unit cell, clays display only one negligible distortion of the absorption bands. Crush the samples and homogenize with the agate mortar in the presence of a volatile organic liquid that is inert to IR (Ethanol, acetone, etc.); avoid modifying or destroying the crystalline structure. Too large particles could cause spectral distortion, dispersion of incidental radiation and widening of the absorption bands (Christiansen effect).

Destruction of the organic matter is often necessary first to limit organic absorbance, which is likely to overload the spectrum, and second to avoid excessive retention of adsorbed water, which can mask some absorbance of minerals. However, in some cases this treatment can lead to neogenesis of minerals.

*For measurements on solid samples*

- In transmission–absorption, clays can be analysed in three main forms:
  - a. thin films that are self-supporting or placed on suitable supports,
  - b. discs made with binding agents that are transparent to IR,
  - c. in a mixture with liquid mulls.
- In NIR or Raman diffuse reflectance, the sample is simply packed in a sample holder taking care to limit preferential orientations.
- In multiple specular reflectance or attenuated total reflectance (ATR), the problems of interface with the soils are often not reproducible and these techniques can generally only be used on thin blades.
- In IR microscopy samples can be analysed on film or as microsamples without preparation.

Pretreatments can cause changes in the properties of the samples: these can be used in comparisons with chemically untreated rough samples preserved in their original conditions (amorphous phases, etc.).

*For measurements on liquid samples* separated from the soil by chemical means, it is possible to perform the measurements either (i) in solvents that are transparent to IR and do not react with the minerals, or (ii) NIRS measurements on freeze-dried extracts.

*For measurements on gas samples* resulting from controlled pyrolysis or decomposition of mineral fractions during thermal analyses (EGA and TGA-DTA, see Chap. 7), sample “powders” are used that are identical to those used for standard thermal analyses.

To improve sensitivity, special cells are used to lengthen the path of the beam in the gaseous medium, absorption being proportional to length. Preliminary purging of the air in the sample compartment is required to eliminate any H<sub>2</sub>O and CO<sub>2</sub> present.

**Preparation of Self-Supporting Films***Technique*

This preparation is only possible with certain types of clay, e.g. montmorillonites, vermiculites and fibrous clays, that can be prepared as thin but stable films.

The method of Farmer and Palmieri (1975) has been slightly modified to allow quantification of the measurements. This technique has the advantage of not subjecting the sample to a strong pressure and of avoiding exchange reactions between the sample and the binding agent added in the pelletizing method. The main difficulties are the critical thickness of the film (maximum 4–8 μm), its capacity to transmit a sufficient intensity, its mechanical resistance and the frequent difficulty

involved in its removal, which requires great technical skill. Silicated minerals often deposit with preferential orientation, which makes it possible to identify the vibrations caused by the oscillation of the dipoles which should be perpendicular to the plan of the lattice. It is also possible to study polychroism related to the plane using a goniometer.

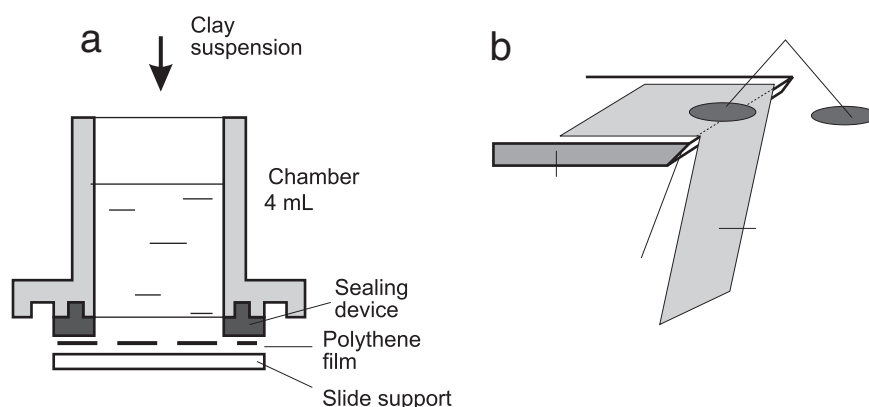

**Fig. 5.4.** Preparation of self-supporting mineral films: **(a)** centrifugation at 2,500 *g* in Cyto Hettich chamber, **(b)** removal of self-supporting film

#### *Procedure*

- Crush a clayey extract of known weight with an agate mortar with a little water to produce a fluid paste, and then put in suspension in a known volume of distilled water
- transfer the complete suspension on a slide covered with a flexible polythene film in a Cyto Hettich chamber (Fig. 5.4); centrifuge at moderate speed (approximately 2,500 *g*)  
the selected volume of the chamber is 4 mL, making it possible to obtain a film 12.4 mm in diameter, that is to say a surface area of 120 mm<sup>2</sup>; in this way it is possible to determine the quantity deposited per unit area (the density must be approximately 1–2 mg per cm<sup>2</sup>)
- remove the clear supernatant solution with a pipette and air dry the film containing the deposit
- remove the film by passing the flexible support across the edge of a bevel-edged blade and transfer it onto a support for IR measurement; the deposit can also be transferred onto a thin filter support with rigid

- polymeric mesh, which avoids migration thanks to its continuous structure
- store the deposit for 48 h in a desiccator on P<sub>2</sub>O<sub>5</sub> before analysis.

### ***Preparation of Film on a Support Transparent to IR***

#### ***Principle***

This system makes it possible to obtain thin films either for oriented deposit by simple gravity or by centrifugation as above.

The following factors have to be taken into account: the thickness of the clay deposit, the choice of a suitable solvent to avoid dissolution of the support, the spectral field useable with this type of support, the reactivity of the clay–solvent–support. In general, KBr slides are used because they are cheap and easy to use, and enable medium-IR scanning up to approximately 400 cm<sup>-1</sup>, or CsI up to 220 cm<sup>-1</sup>. Polythene is used for far IR. The sample is put in suspension in a solvent without dissolution. The surface can be impregnated by microvaporization with Nujol to limit reflectance phenomena at the air–clay interface.

#### ***Procedure***

Depending on the IR domain, select a pellet 13 mm thick obtained by pressure (10 tons cm<sup>-2</sup> AgCl, CaF<sub>2</sub> IRTRAN 2, IRTRAN 4, Ge, Si, KBr, CsI, polythene, etc.).

The sample in suspension in a suitable organic solvent is deposited in the same way as in the preceding procedure by gravity or centrifugation. After drying, carefully heat the disc covered with film in a drying oven at 100°C for 5 h to eliminate all traces of water, then store in a desiccator until analysis.

### ***Preparation of Discs (Solid Solution)***

#### ***Principle***

The solid sample is completely pulverized with an agate mortar in the presence of an organic liquid (for example ethanol) then dried under vacuum in the desiccator with phosphoric anhydride. It is then mixed with a matrix that enables to form self-sustaining discs at high pressure; these disks can be used with quite a wide range of IR radiation.

For swelling smectites, it is preferable to grind a known weight of sample with a little water to form a thick paste, then add the binding agent and grind the wet sample again. After complete drying, homogenize the diluted sample with a microball grinder.

This system is easy to use and is the most widely used, but it has certain disadvantages:

- all materials used as binding agents for the discs have limited transmission in IR so it is impossible to observe the absorbance of a clay on the whole range from near IR to far IR on only one pellet
- the reactivity of the support may result in exchange reactions with clay.

For example potassium bromide (KBr), which is transparent up to  $400\text{ cm}^{-1}$  (Fig. 5.2), produces excellent pellets that allow good spectra in a wide range of IR. But with 2:1 clays, such as smectites which contract with  $\text{K}^+$ , exchange phenomena can cause deformation of the absorption spectra (Nyquist and Kagel, 1971). These discs are thus not suitable for studies concerning adsorbed water as K reduces water retention, or for the study of surface cations.

As KBr is hygroscopic, the pellets have to be stored in a desiccator under vacuum with phosphoric anhydride to limit the phenomena of adsorption of water and resulting uncertainties in interpretation between the bands of hydroxyls and those of water adsorbed by minerals and the support. For far IR, polyethylene, polytetrafluoroethylene (Teflon), or paraffin should be used.

Pressure can cause inappropriate transformations by amplifying the effect of the chemical reactivity, but can be used for *in situ* study of the effects of very high pressures obtained with of a diamond-cell anvil making it possible to analyse by IR the induced transformations (Weir et al., 1959; Liu and Mernagh, 1992).

#### ***Procedure (Qualitative Analysis)***

- Choose the matrix and the diameter of the pellets
- dry the sample in a desiccator for 48 h to eliminate non-structural water whose  $3,440\text{ cm}^{-1}$  band can mask that of structural OH; this method of drying is not suitable for all minerals (cf. Chap. 1)
- dry the finely crushed IR-quality binding agent in the drying oven under vacuum at  $100^\circ\text{C}$  for one night if its thermal stability permits
- for a disc of approximately 1 mm thickness and a diameter of 13 mm, weigh 0.5–3 mg of clay sample at 0.01 mg precision.
- add 300 mg of KBr (can be changed)
- homogenize with a microhomogenizer with a plastic or agate ball for 2 min, or grind with the agate mortar once more for a perfect mix
- transfer in a stainless steel mould 13 mm in diameter (A in Fig. 5.5b).
- apply light pressure and degas under vacuum for 5 min

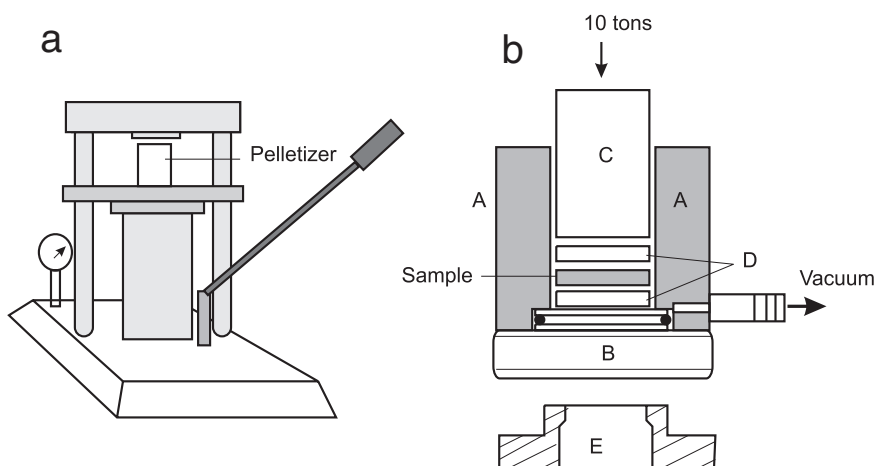

**Fig. 5.5.** Preparation of the samples in solid solution **(a)**: 12 ton manual hydraulic press, **(b)**: detail of a pelletizer: A body, B: removable base, C 13 mm  $\phi$  plunger, D: 13mm  $\phi$  polished cylinders, E: release ring from the mould, filled circle represents sealing ring.

- Press (Fig. 5.5a) at 10 tons  $\text{cm}^{-2}$  for 10 minutes (KBr becomes plastic at this pressure)
- extract the disk from the mould using the release ring (E in Fig. 5.5); it should look homogeneous, smooth and transparent; do not touch it with the hands
- desiccate at 100°C for 2 h and store in a desiccator on  $\text{P}_2\text{O}_5$  until needed.

In practice, it is advantageous to make two or even three pellets using the same binding agent at two different concentrations:

- a pellet made with 3 mg of sample for 300 mg of KBr to reach total absorption in the zones around 1,000  $\text{cm}^{-1}$  and 500  $\text{cm}^{-1}$  (silicates)
- a pellet made with 0.25–0.5 mg of clay sample to obtain details of the spectrum in the areas of intense absorption of silicates
- a third pellet made with a binding agent transparent to far IR will also be needed if spectra below 200  $\text{cm}^{-1}$  are required
- perform the spectra under the instrumental conditions selected.

The time of passage in the spectrometer will depend on the type of material (dispersive or interferometer), the scanning zone with dispersive apparatuses, or the resolution required. After measurement, the pellets can be stored in the desiccator on  $\text{P}_2\text{O}_5$ .

To avoid corrosion, the pelletizer must be cleaned immediately after use without abrasion.

### ***Preparation of the Clay Samples in the Form of Mull***

#### ***Principle***

When interactions are possible between the binding agent and the sample, when it is impossible to make self-supporting films or when pressure is not desirable, the Mull technique can be used with a non-volatile inert oil. Nujol (paraffin oil), hexachlorobutadiene (Votalef oil) or Fluorolube (fluorinated hydrocarbon oil) is mixed with the sample to form a fluid paste which is pressed between two windows. The method is rapid but only qualitative; the sample is oriented. It is not possible to desiccate the mixture in the drying oven.

#### ***Procedure***

- Place 10 mg of dried clay sample in a 50 mm agate mortar; add a known quantity of Mull to moisten the powder using a micropipette or a spatula
- crush to obtain a thick paste in which the sample is uniformly dispersed (concentration will be about 0.3–0.5%)
- spread out the mixture with a spatula on a window transparent to IR, then cover with another window to obtain a regular thickness taking care not to trap air inside
- place in the spectrometer and record the spectrum.

The spectral limits of the windows and the zones of absorption specific to the Mull matrix can be taken into account in interpretation. For example, Nujol strongly absorbs between 3,000 and 2,800  $\text{cm}^{-1}$  (CH), 1,460  $\text{cm}^{-1}$ , 1,375  $\text{cm}^{-1}$ , Fluorolube does not absorb between 4,000 and 1,400  $\text{cm}^{-1}$ . Both mulls are complementary and two mulls should be made to check that the absorption bands do not mask the bands specific to the sample. The homogeneity of the suspension is difficult to obtain and maintain: prepared samples should thus always be stored horizontally.

### ***Preparation for Specular or Diffuse Reflectance, Attenuated Total Reflectance (ATR)***

As the intensity of absorption depends on the angle of incidence, the surface should present weak granulation, and isogranulometric grinding to 0.2 mm is thus necessary. Compression should be carried out as for XRD powders (cf. Chap. 4) avoiding excessive orientation.



The thickness of the powder (approximately 1 mm) is not critical, since the radiation only penetrates a few microns. In certain cases, it is possible to use compressed pellets with or without the addition of binding agents, but in this case the orientation is rather strong. It should be noted that since the refraction index is significant in measurements by reflectance, significant differences will be observed between the spectra obtained by transmission and by reflectance at high wavelengths.

### ***Deuterization***

In specialized laboratories, deuterization is an ideal method to study water in clays. In heavy water, deuterium replaces hydrogen. When  $\text{H}_2\text{O}$  is replaced by  $\text{D}_2\text{O}$ , the OH of the interstitial water is deuterated, but not the OH of the lattice (Wada, 1966). The interatomic distances do not change, the mass is doubled and the vibration frequencies drop. It is thus possible to separate the reticular OH or adsorbed water, and eliminate the ambiguity of the measurements in studies of mineral gels (Nail et al., 1976).

### ***Remarks***

During preparation, atmospheric contamination of the rough samples must be avoided, for example:

- ammonium can produce absorption around  $3,250$  and  $1,400\text{ cm}^{-1}$  (stretching and deformation)
- in the presence of calcium, attacking organic matter with hydrogen peroxide can lead to the formation of insoluble calcium oxalate which produces absorption near  $1,400\text{ cm}^{-1}$ , the destruction of organic matter with sodium hypochlorite does not give oxalate and is consequently more suitable in this particular case
- note that oxidation of organic matter is accompanied by oxidation of mineral compounds like those of  $\text{Fe}^{2+}$
- decarbonation and deferrification in an acid medium can destroy minerals like amorphous silicates with precipitation of silica and elimination of Fe et al. (Fröhlich, 1980).

## **5.2.3 Brief guide to interpretation of the spectra**

### ***General Principles***

In IR, transitions between the different energy levels are subject to rules of selection as absorption is linked to variation in the dipole moment of

the molecules. In the case of polyatomic molecules, all predictable frequencies cannot be observed because energy levels are degenerated for example by symmetry in the molecule. It is thus, very difficult to accurately predict the frequencies of fundamental vibrations in complex structures like those of clays, though recent computer programs have enabled progress to be made.

Tetrahedrons of silica and octahedral aluminium or magnesium form the basic units of clay minerals: a tetrahedral structure can produce four modes of vibrations, and an octahedral structure six, but these are not all active and can be modified by isomorphic substitutions or by the nature of the structural cations.

The interpretation of a clay spectrum can be carried out after comparison with the spectrum of a “pure” substance of comparable nature in order to eliminate uncertainties caused by chemical variations in the composition and order–disorder state. The need for known standard spectra of reference implies each laboratory should record all results of studies on soil minerals to be used as references in addition to consulting available data bases.

Qualitatively, it is first necessary to locate the intensity of the diagnostic absorption bands of minerals and to assign them to molecular groups and possibly to types of precise vibrations. The degree of sensitivity is satisfactory in the case of certain minerals that have intense bands (e.g. kaolinite, quartz, gibbsite, calcite). Quantities of the order of 1% can be detected.

For example, pure hydroxides and oxyhydroxides have a protonic environment that results in net vibrations of specific stretching; on the other hand, in the case of 2:1 and 2:1:1 minerals where chemical variations and isomorphic substitutions are frequent, displacement of the bands can occur; in this case it is useful to simultaneously use XRD analysis (cf. Chap. 4) and chemical analysis by selective dissolution (cf. Chap. 6) for secondary compounds of the soil, making it possible to draw up  $\frac{\text{(silica of tetrahedrons)}}{\text{(alumina of octahedrons)}}$  ratios that satisfactorily reflect the environment of hydroxyls.

1:1 kaolinite has a  $\text{SiO}_2$ -to- $\text{Al}_2\text{O}_3$  ratio of 2 and presents surface hydroxyls that produce four frequencies of characteristic IR absorptions (Table 5.1).

Smectites and micas have a ratio of approximately 3. As hydroxyls in internal positions are associated with different octahedral cations, the absorption bands are not uniform in the  $3,600\text{ cm}^{-1}$  area and displacement of the frequencies of hydroxyl stretching may be observed. The level of occupation of the octahedral sites (di- and tri-octahedral) can be determined by XRD analysis at line 060, but IR analysis can provide additional information.

In the case of tri-octahedral minerals, the three sites are occupied and the axis of the OH bond of internal hydroxyl is perpendicular to the 001 reticular plane of clays, whereas in di-octahedral minerals only two sites are occupied; the proton of internal hydroxyl is pushed back towards the empty octahedral sites and the spectrum is consequently deformed.

### **Procedure**

The unknown spectra are manually broken up into fields and the bands of maximum intensity are selected along with the wavenumbers of the maxima to compare with reference data. This search can be automated with computerized data bases but in practice also requires the use of laboratory reference data and continuous consultation of the literature.

In solid minerals, interpretation is mainly based on the frequencies of the external molecular group, as the detection of vibrations of the internal crystal is only significant in far IR. IR spectrometry accounts satisfactorily for the molecular groups in which the atoms are in a specific environment. Molecular structures with characteristic bands can be isolated.

### **IR Absorption Bands in Phyllosilicates**

The apparent simplicity of soil minerals masks the complexity of absorption bands of the fundamental modes of vibration (Fig. 5.6). The bands are displaced as a function of the crystalline environment, of substitutions, etc. The frequency and assignment of the bands require very precise spectra to separate slight variations from phases that are often about  $2\text{ cm}^{-1}$ . For example, distinction of amorphous silica, opal, biogenic silica by means of the Si–O, Si–O–Si, Si–OH vibrations are of this order of magnitude.

In the 3,700–  
3,400  $\text{cm}^{-1}$  and  
950–600  $\text{cm}^{-1}$   
zones

- protons in hydroxyls groups, even if there is no long-distance molecular structure, which is useful in the case of “amorphous” substances
- the active modes of tetrahedrons and octahedrons: OH oscillation, dichroism of OH sites in di-octahedral minerals

	<ul style="list-style-type: none"> <li>– displacement of the absorption bands as a function of the nature of the octahedral cations, effect of exchange (e.g. interaction of structural OH with interlayer cations)</li> <li>– separation of the stretching vibrations of non-bound water allows better distinction of the halloysites disturbed by interfoliaceous water molecules</li> </ul>
In the 1,100–500 $\text{cm}^{-1}$ zone	<ul style="list-style-type: none"> <li>– vibrations of the silicate anion that are considered as the spectral print of clays, slightly coupled with vibrations of other structures (silica-oxygen bonds), Si–O stretching towards 1,000 <math>\text{cm}^{-1}</math>, Si–O deformation towards 500 <math>\text{cm}^{-1}</math>;</li> <li>– isomorphic substitutions of tetra and octahedral minerals can cause bands in far IR</li> </ul>
In the <400 $\text{cm}^{-1}$ zone	<ul style="list-style-type: none"> <li>– <math>\text{Al}^{3+}</math> of octahedrons and oxygen bonds of adjacent layers</li> <li>– vibrations of exchangeable cations balancing the charges in interfoliaceous spaces of clays and substitution of exchangeable cations</li> </ul>

Taking the example of the adsorption bands of a common clay, 1:1 kaolinite (Table 5.1), it is possible to observe:

- a similar configuration of the bands of proton vibration (stretching of external and internal hydroxyls) with respect to crystallinity;
- a level of disorder that is detectable by the coalescence of the 3,669-3,653  $\text{cm}^{-1}$  doublet;
- hydration water that is easily differentiated by deuteration and the appearance of a HOH band towards 1,630  $\text{cm}^{-1}$

– 1,110, 1,036 and 1,010 bands corresponding to stretching vibrations characteristic of SiO.

In the case of Halloysites, widening of the bands can be observed between 3,700 and 3,600 (OH stretching) because of the structural distortion caused by variable hydration. Bands 795 and 758  $\text{cm}^{-1}$  are of about the same intensity in kaolinite whereas in halloysites band 795  $\text{cm}^{-1}$  is very weak.

**Table 5.1.** IR absorption bands of well-crystallized kaolinite  
 $\text{Al}_2\text{O}_3 \cdot 2\text{SiO}_2 \cdot 2\text{H}_2\text{O}$ ,  $<2\mu\text{m}$  KBr pellet

band ( $\text{s cm}^{-1}$ )	Vibrations		band ( $\text{s cm}^{-1}$ )	Vibrations	
3,695		external OH	690	-	Mg/Al
3,669		external OH	538	deformation	SiO
3,653	stretching	external OH	470	+	+
3,619		internal OH	430		
3,410– 3,450 <sup>a</sup>		OH hydration	364	vibrations	Al/Mg octahedrons
1,630 <sup>a</sup>	deformation	HOH hydration	345	miscellaneous	
1,106– 1,112	stretching	out layer SiO	275		
1,036		SiO...	195		
1,010		SiO...			
938	Deformation	external OH			
912		internal OH			

<sup>a</sup> water of hydration (towards 3,450  $\text{cm}^{-1}$ ) can be distinguished from the OH of structural hydroxyls by the presence of a HOH band towards 1,630  $\text{cm}^{-1}$

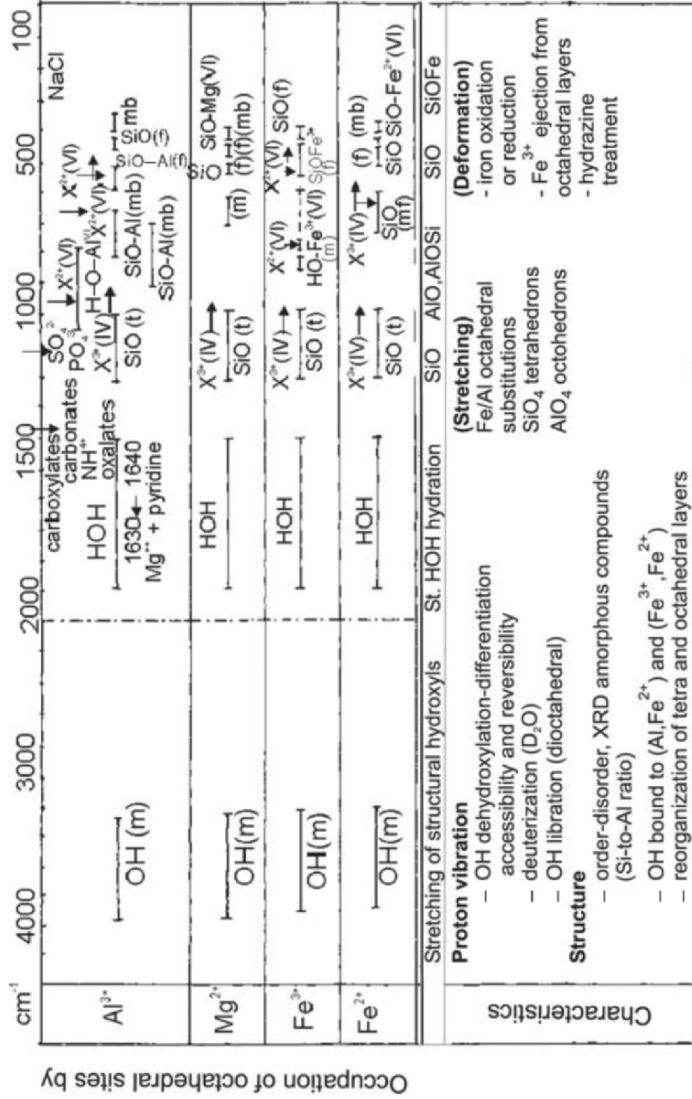

**Fig. 5.6.** Zones of assignment of the IR absorption bands in phyllosilicates (according to Stubican and Roy, 1961). Bands intensities: (t) very strong, (m) medium, (f) strong, (b) low ↓ changes in intensity → modification of frequencies by substitutions (X<sup>3+</sup> or X<sup>2+</sup>) in tetrahedral sites (IV) and octahedral sites (VI)

## 5.2.4 Quantitative Analysis

### *Definition*

In mineralogy, improvements in quantitative analysis using IR have accompanied improvements in FTIR equipment, and quantitative analysis is an important tool for the study like pedogenic chronosequences, flows and sedimentary series (e.g. paleohydrology, paleoclimatology) or watershed functioning. It is always interesting to observe a mineral in its original state without pretreatment, with the exception of grinding in a non-aggressive liquid medium to reduce granulometry to 1–2  $\mu\text{m}$ , then drying.

The relations between the intensity of absorption of IR radiations and the concentration of mineral species are controlled by the law of Beer–Lambert which is applicable to solid media (Keller and Picket, 1949, or; Duyckaerts, 1959). However, this law is not always applicable to soil minerals for which the characteristic bands are not quite separate and often insufficiently homogeneous. The order–disorder states affect the band widths, and grain sizes influence band intensity. In this case, the limitations are obvious and the photometric response is seldom linear: the absorbance of a band is then no longer proportional to the concentration, and quantification cannot be correctly carried out as it can for gas or organic liquids.

Since standard minerals (with structure, crystallinity, chemical composition and particle size similar to that of the samples) do not exist, only relative quantification can be obtained using this method, nevertheless it is possible to measure variations in the composition of minerals in a profile or toposequences with acceptable precision.

For certain minerals with a relatively characteristic spectrum and a well defined base line such as some quartz, kaolinite, carbonates, the levels of detection will be about 1–2%. Purification by sedimentation allows concentration and simplification of the spectra. The state of crystalline order can cause significant variations, for example in kaolinites when structural OH between 3,700 and 3,600  $\text{cm}^{-1}$  are used.

The preparation of the sample is particularly important for quantitative analysis. Maximum absorption (without saturation) and minimum dispersion are required. The isogranulometric size of the particles must be less than 2  $\mu\text{m}$ . The homogeneity of the discs must be perfect, the components should be dried at each stage of preparation or storage, and the thickness of the sample must be constant at less than 1 mm.

Rigorous standardization of the procedures makes it possible to optimize measurements of soil mineral components without depending completely on the degree of crystallinity of powders as in XRD (cf. Chap. 4). Some minerals with short-range organization that are “amorphous” to X-rays, for example some aluminosilicates, crypto crystalline compounds (e.g. allophane, imogolite), and some forms of silica and of iron (e.g. ferrihydrites) can be quantified in this way.

### **Procedure**

#### **Overview**

The procedures for qualitative analysis (cf. Sect. 5.2.1 and 5.2.2) are applicable here, and particular care should be taken to:

- desiccate the samples and binders at 105°C for one hour before weighing precisely ( $10^{-6}$  g); a temperature of 40°C can be used for heat-sensitive substances
- grind the clay samples to less than 1–2  $\mu\text{m}$  with an agate mortar or preferably with a tightly adjusted cooled vibratory grinder with agate balls in wet medium (in the presence of ethanol or of acetone); after drying, all the particles should pass through a 0.1 mm sieve; fractions that are quantitatively isolated by ultracentrifugation (cf. Chap. 3) can also be used
- weigh a quantity of clay allowing transmittance ranging between approximately 20% and 70% for the whole band range of the spectrum (qualitative tests make it possible to fix the exact proportions between 2 and 5 mg of sample for 1 g of binding agent); mix with the appropriate binding agent (often KBr) and homogenize with a vibratory mixer with agate balls for 5 min
- using 1 g of the above mixture, make three discs with a diameter of 13 mm each by weighing the same quantity of mixture (300–330 mg) to obtain a constant optical pathway of one mm or less; transfer to the pelletizer under vacuum (Fig. 5.5) and apply a pressure of 10 tons  $\text{cm}^{-2}$  for 2–3 min; the discs should be transparent, smooth, show no surface defects, be of constant thickness and present regular dispersion of the clay particles in the binding agent (this should be checked under the microscope); they should be handled using a forceps and stored in a desiccator with phosphoric anhydride; prepare the calibration discs in the same way
- measure the absorbance of the discs made of binding agent (for the blank assay), sample disks and pure or complex calibration discs made



according to the laboratory reference, which enable calibrations with variable proportions of minerals.

### *Sediments*

Fröhlich (1980, 1989) recommended grinding with an agate ball to less than 2  $\mu\text{m}$  in a cooled inert liquid medium. The fineness of grinding should be checked under the microscope. Optimal dilution is around 0.25%.

- Prepare 1 g of mixture: 2.5 mg of sediment (precision  $10^{-5}$  to  $10^{-5}$  g) and 997.5 mg of KBr
- homogenize carefully with a vibrating grinder with an agate ball;
- press 300 mg of the mixture for 2 min in a 13-mm diameter mould under vacuum.

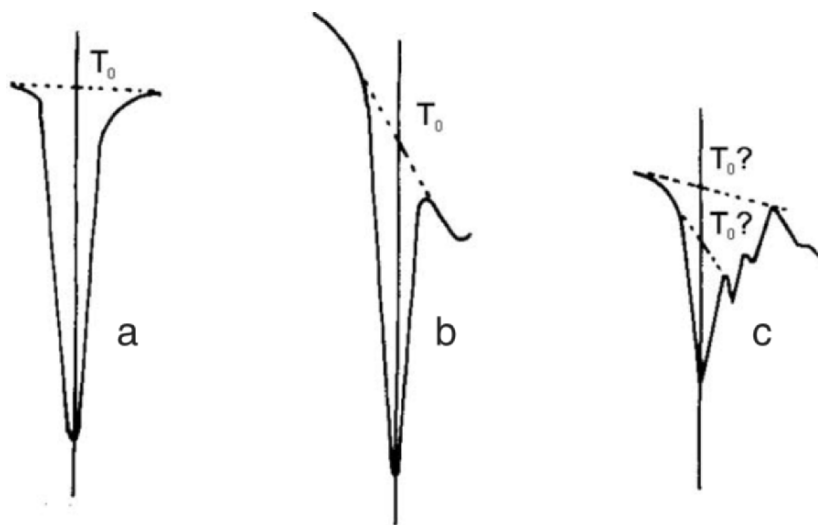

**Fig. 5.7.** Determination of  $T_0$ : good base line (a, b), approximation (c).

The thickness of the KBr<sup>1</sup> disc should be 0.83 mm and represent the constant optical pathway in all measurements. The disc should be smooth and transparent and should contain 0.75 mg of sample.

### *Calculations*

Any absorbance due to the thinner (KBr) must be subtracted from total absorbance (KBr+sample). The transmission (and by conversion absorbance  $A$ ) of the substance is measured on the spectrum starting from the base line. This line is often difficult to define for complex mixtures (Fig. 5.7) and requires approximations (effect of matrix, interference between bands, etc.). The relative error is often about 5%, and can be improved for certain minerals.<sup>2</sup> Calibration using “pure” minerals or mineral mixtures with a composition close to that of the samples makes it possible to plot curves of absorbance =  $f$ (mass of mineral).

One gram of mixture makes it possible to estimate repeatability on three discs weighing 300 mg.

### *Remarks*

Strong orientation of minerals in the disc can generate errors. In 2:1 clays, variations in intensity of the stretching bands of hydroxyls can result from tri-octahedral components. With micas oriented perpendicular to the beam, only modes of vibration parallel to plane  $b$  will appear (Phlogopite). Conversely, in kaolinite, the intensity of the  $3,619\text{ cm}^{-1}$  band is independent of the orientation (internal hydroxyl directed towards the vacant octahedral position).

If titrations are carried out with a traditional dispersive apparatus, the resolution can be improved by finer slits but the energy will be weaker. As the width of the slits is not constant throughout the spectrum, care should be taken that the slits are not too wide, because the signals could be deformed and the law of Beer–Lambert would then not apply.

---

<sup>1</sup> Density of KBr: 2.75

<sup>2</sup> In spite of the use of reference minerals, the great variability of the absorption bands as a function of the chemical structure often results in insurmountable difficulties in calibration of 2:1 and 2:1:1 minerals. In this case, it is possible to obtain only semi-quantitative measurements that allow identification of changes in a profile, the mineral tracer being used as standard of comparison at a given level.

### 5.3. Other IR techniques

#### 5.3.1 Near-infrared spectrometry (NIRS)

##### **Principle**

Vibrations of light atoms that have strong molecular bonds with protons (N, C or O) are used to analyse organo-mineral compounds or organic matter. When the bonds are weak and the atoms are heavy, it can be difficult to detect and quantify the vibration phenomena.

Wide bands are reproducible but are influenced by penetration of the radiation, and thus sensitive to the size of the particles and to moisture. Fine grinding is usually required to obtain particles of the same size and to reduce the background noise as much as possible. But acceptable results can be obtained with materials that are not finely ground (D. Brunet, IRD Montpellier, France, personal communication). Bond vibrations cause a response that depends on the number of molecules present and on their environment, this response then enables quantification

The bands in the near-infrared field are more widely spaced than in medium and far IR, which limits the phenomena of overlapping. The first derivative of the signal can be used to improve precision.

Measurements are made either by transmission-absorption, or by diffuse emission-reflectance (NIRA-DRIFT)<sup>3</sup> on powders using wavelengths ranging from 1,000 to 2,500 nm (wavenumbers from 10,000 to 4,000 cm<sup>-1</sup>) in certain cases such as soil litter (water, protein content, total nitrogen, sugars, etc.), or on liquids using immersed optical fibres.

##### **Material**

Measuring equipment with diffuse reflectance IR is somewhat different from IR spectrometry using the transmission-absorption mode (cf. diagram in Fig. 5.8). The optical elements are made of quartz. They allow the complete near-IR spectrum to be acquired in a few seconds.

---

<sup>3</sup> NIRS = near-infrared reflectance spectrometry  
NIRA = near-infrared analysis  
DRIFT = diffuse reflectance IR with fourier transform

### Method

This non-destructive method requires fine grinding, but does not require a reagent, or weighing or measurement of volume. Measurements are rapid ( $\approx 30$  s) and the unit cost of the measurement is low.

Measurements depend on the physical factors that affect reflectance, i.e. particle size (reflectance, refraction, diffraction), their distribution (heterogeneity) and the distribution of the vacuums (compaction and induced orientations).

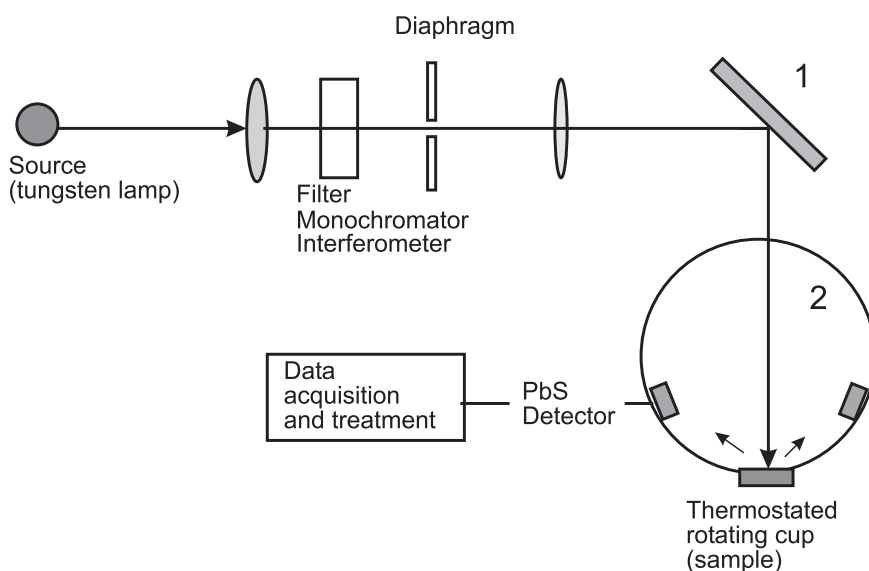

**Fig. 5.8.** Diagram of a near-infrared spectrometer (NIRS) 1: oscillating mirror allowing adjustment of the incidental beam on the sample and improving reflectance on the walls of the integration sphere. All possible angles must be represented starting from the normal. The total flow from the source that excites the sample is concentrated by quartz lenses. 2: Integration sphere allowing the effect of variations in particle size to be decreased with collection of the most intense radiation but rejection of specular components

Current NIRS systems have been greatly improved by progress in chemometric software which enables calculations that were previously impossible. Quantitative analysis is based on multivariate calibration using all the spectral information, not only absorbance at a given wavelengths but absorbance at all wavelengths of the spectrum. These calibrations use a wide range of methods of calculation, especially

principal component analysis (PCA), regression on principal components (RPC), partial least square (PLS) regression and multiple linear regression (MLR). The software includes help in choosing the best method of calibration, even if the choice is still not always easy (Dardenne et al., 2000).

This method is suitable for organic analysis but was extended to many different measurements on soils. Chang et al. (2001) used RPC calibration for FTIR determination of moisture content, total C, total N, CEC, sand content, silt content, clay content, macro-aggregation, potentially mineralisable N, C biomass, total respiration rate and basal respiration rate of soils. The only condition is the need to compile a database of soil references for calibration. For a given variable, calibration consists of (1) obtaining a measurement value by a reference method for all soil references (preferably including a wide range of concentrations of the given variable), (2) obtaining NIR spectra on the same soil references, (3) calculating and plotting the straight line of multivariate calibration with the value measured using the standard method in the *x*-coordinate and predicted value by NIRS in the *y*-coordinate. After calibration, the measurement of an unknown sample is very rapid: its real concentration in the *x*-coordinate can be deduced from its spectral data in the *y*-coordinate. But the apparently universal application of the method is not quite true. Calibration is always possible but not always significant (e.g. variability of the calibration curves obtained by Chang et al., 2001). Which soils to choose for the soil references (all soil types, or a given soil type)? What type of soil preparation? The complementary bibliography at the end of this chapter lists a few additional applications of NIRS in soil and litter studies.

### 5.3.2 Coupling Thermal Measurements and FTIR Spectrometry of Volatile Products

Measurements are taken during TGA-DTA<sup>4</sup> and enable determination of the nature of the gas products that appear during heat decomposition of the sample (EGD or EGA)<sup>5</sup>. The analyses are carried out by Fourier transform infra-red spectrometry (FTIR) by transmission or absorption in time of flight, as a function of the temperature and heating time.

This dynamic technique enables real-time monitoring of the chemical or physicochemical conversions that take place during the rapid heating

<sup>4</sup> DTA = Differential thermal Analyse, TGA = Thermo Gravimetric analyzes, cf. Chap. 7.

<sup>5</sup> EGD = Evolved Gas Detection, EGA = Evolved Gas Analysis.

of the sample (controlled thermolyses or pyrolyses of organic or inorganic material is possible). A rise in temperature at moderate speed makes it possible to detect unstable radicals and molecular fragmentations by linking them to variations in mass and temperature (fusion, exo- and endothermic reactions, decomposition of mineral-carbonates, N, C, S, H compounds, oxidation, reduction, transfers of protons etc.).

Pressure is a variable that affects sublimation and evaporation. Pressure can be modified by too rapid decomposition of an unstable product, but, depending on the temperature, can also cause molecular synthesis. Under low pressure, the most reactive gases diffuse quickly, avoiding possible recombination. Working under argon atmosphere at low pressure is generally recommended. But working under controlled atmosphere can highlight redox phenomena or, on the contrary, avoid them.

Additional information can be collected by selecting a heating rate between 20 and 400°C min<sup>-1</sup> depending on the speed of evacuation of the gas produced and on its detection or rapid titration before further gaseous reactions occur.

### 5.3.3 Infrared Microscopy

FTIR analysis is possible on microsamples measuring from 20 to 500 μm. The IR microscope (cf. Chap. 8) consists of lenses with a Cassegrain mirror coupled with a high sensitivity MCT<sup>6</sup> detector cooled with liquid nitrogen. It is possible to work with either transmission or reflectance. The resolution is approximately 8 cm<sup>-1</sup> depending on the quality of the materials and the number of accumulations of spectra.

It is also possible to use Raman spectrometry where the source of excitation is a monochromatic laser emitting in the red band to avoid the effects of fluorescence which occurs in the presence of certain organic materials. Quantities of the order of a pico and even of a femtogramme can be detected in this way.

### 5.3.4 Raman scattering spectroscopy

#### *Interest*

Raman spectroscopy has not been widely used in earth science because dispersive equipment is very expensive and the performance is often

---

<sup>6</sup> MCT = mercury, cadmium, tellurium.

insufficient due to the difficulty of obtaining a selection of wavelengths with high resolution.

Progress in electronics has made it possible to design very sensitive detectors, very selective monochromators, and powerful monochromatic lasers, and to use FTIR spectrometers thus making this technique accessible and complementary to other IR spectrometries. Data processing enables very rapid treatment of the spectra.

This technique makes it possible to supplement the information obtained in transmission-absorption IR spectrometry, as certain vibrations are only active in one of the two techniques, or their intensity differs because of the rules of selection. The symmetrical vibration bands are stronger in Raman spectroscopy and the asymmetrical vibrations are stronger in IR spectroscopy.

The study of certain molecular structures that are difficult to differentiate such as rutiles, anatases and brookites is possible on microsamples. The nature of the chemical bonds and the orientation of OH groups can be determined without obstruction by any interstitial water that may be present. The method is not destructive and does not require complex preparation. It is possible to work on powder, even wet powder, which is impossible with other IR techniques.

### ***Principle***

Raman spectroscopy is based on the inelastic scattering of IR<sup>7</sup> radiation with IR secondary emission at beat frequencies. The spectra are composed of fine lines which require a high resolution apparatus:

- phenomena of fluorescence induced by the electronic transitions can disturb the spectra and mask the Raman signal if an excitation laser that emits in the visible spectrum (488 nm) is used; excitation by Nd:YAG laser emitting at 1,064 nm, the frequency corresponding to a zone of little occupied electronic transition, generally does not generate fluorescence, and coupling with a good-quality FTIR spectrometer eliminates difficulties due to insufficient resolution;
- when a monochromatic radiation beam strikes a sample, a weak fraction of the re-emitted radiation displays modified frequencies that reflect the vibration frequencies of the sample. This fraction is measured in Raman spectrometry; the unchanged radiation fraction (Rayleigh elastic scattering) has to be removed by filtering.

---

<sup>7</sup> Raman spectroscopy in visible or UV radiation can cause photodecomposition of the sample as well as thermal damage.

### ***Apparatus***

The basic apparatus is a FTIR spectrometer equipped with an interferometer coupled with data acquisition and processing software. It should have an external window to attach a Nd-YAG laser irradiation, a chamber for sample powders allowing irradiation modes of 90° and 180°, a spectral filtration module and if necessary a specific detector. A Raman-FT microscope and accessories for Raman studies under very high pressure (diamond anvils) can be added to the FTIR spectrometer.

The laser for excitation of the atoms and molecules must be monochromatic or adjustable in wavelength (for better selectivity). It must provide strong intensity (sensitivity of measurements), coherent radiation (spatial and temporal quality), and finally, if the beam is transported by optical fibre, low divergence.

IR and Raman spectroscopy can be supplemented with other techniques for the study of structure (e.g. NMR, EXAFS). In spite of the development of these techniques, the IR and Raman methods remain competitive (ease of handling, reasonable cost of equipment) and allow a sufficiently detailed approach of the structure (including vacancies and substitutions, nature of the bonds in molecules) and of its consequences for rheology, for example, or for the study of pedogenesis phenomena that occur during weathering (e.g. coverings, interactions with the surface, adsorption of molecules). However, the quantification of the phases is often delicate if not impossible, because of the problems of orientation of clays and incomplete spectrum.

### **References**

- Chang C.-W., Laird DA, Mausbach M. et Hurburgh CRJr (2001) Near-Infrared Reflectance Spectroscopy-Principal Components regression analysis of soil properties. *Soil Sci. Soc. Am. J.*, 65, 480–490
- Dardenne P, Sinnaev G et Baeten V (2000) Multivariate calibration and chemometrics for near infrared spectroscopy: which method. *Journal of Near Infrared Spectroscopy*, 8, 229–237
- Duyckaerts G (1959) The infra red analysis of solid substances. *Analyst*, 84, 201–214
- Farmer VC et Palmieri F (1975) The characterization of soil minerals by Infrared spectroscopy. In: *Soil components – 2 – Inorganic components*, Gieseking JE ed., Springer, 573–670
- Fröhlich F (1980) Néoformation de silicates ferrifères amorphes dans la sédimentation pélagique récente. *Bull. Minéral.*, 103, 596–599
- Fröhlich F (1989) Les silicates dans l'environnement pélagique de l'océan indien du cénozoïque. Mémoire Muséum National d'Histoire Naturelle, Paris, XLVI, 206p



- Keller WD et Pickett FE (1949) Absorption of IR radiation by powdered silice minerals. *Am. Miner.*, 34, 855–868
- Liu LG et Mernagh TP (1992) Phase transitions and Raman spectra of anatase and rutile at high pressures and room temperature. *Eur. J. Mineral*, 4, 45–22
- Nail SL, White JL et Hem SL (1976) IR studies of development of order in aluminium hydroxide gels. *J. Pharm. Sci.*, 65, 231–234
- Nyquist RA et Kagel O (1971) *Infrared spectra of inorganic compounds.*, Academic Press, New York
- Stubican V et Roy R (1961) Infrared spectra of layer silicates. *J. Am. Ceram. Soc.*, 44, 625
- Wada K (1966) Deuterium exchange of hydroxyl groups in allophane. *Soil Sci. Plant Nutr.*, 12, 176–182
- Weir CE Lippincott ER Van Valkenburg A et Bunting EN (1959) Infra-red studies in the 1 and 15 microns region to 30 000 atmospheres. *J. Res. Natl. Bur. Stud.*, 63A, 55

## Chronobibliography

- Tuddenham WM et Lyon R.P (1960) Infrared techniques in the identification and measurement of minerals. *Anal. Chem.*, 32, 1630–1634
- Mitchell BD Farmer VC et Mc Hardy WJ (1964) Amorphous inorganic materials in soils. *Academic Press. Adv. Agron.*, 16, 327–383
- Hayashi H et Oinuma K (1965) Relationship between infrared absorption spectra in the region of 450–900  $\text{cm}^{-1}$  and chemical composition of chlorite. *Am. Miner.*, 50, 476–483
- Hayashi H et Oinuma K (1967) Si–O absorption band near 1000  $\text{cm}^{-1}$  OH absorption bands of chlorite. *Am. Miner.*, 52, 1206–1210
- Russell JD, McHardy WJ et Fraser A.R (1969) Imogolite: a unique aluminosilicate. *Clay Miner.*, 8, 87–99
- Wada K et Greenland DJ (1970) Selective dissolution and differential infrared spectroscopy for characterization of amorphous constituents in soil clays. *Clay Miner.*, 8, 241–254
- Conley RT (1972) *Infra-red spectroscopy*. Allyn-Bacon, 2nd. Edition
- Fieldes M, Furkert R.J et Wells N (1972) Rapid determination of constituents of whole soils using IR absorption. *N. Z. J. Sci.*, 15, 615–627
- Miller RGT et Stace BC (1972) *Laboratory methods in Infrared spectroscopy.*, Heyden and Son
- Farmer VC (1974) *The Infrared spectra of minerals*. Minerals Sci. (London).
- Stepanov IS (1974) Interpretation of the IR spectra of soils. *Pochvovedenie*, 6, 76–88
- Gadsden JA (1975) *Infrared spectra of minerals and related inorganic compounds.*, Butterworth

- Griffiths PR (1975) *Chemical infrared fourier transform spectroscopy.*, Wiley, New York Chemical Analysis, 43
- Brame EG, Grasselli JG (1976) *Infrared and Raman spectroscopy.*, Marcel Dekker, 1A
- White JL, Nail SL et Hem SL (1976) Infrared technique for distinguishing between amorphous and crystalline aluminium hydroxide phase. *Proceedings. 7th Conference. clay Mineral Petrology* (Czechoslovakia), 51–59
- Marel HW, Van der et Beutelspacher H (1976) *Atlas of infrared spectroscopy of clay minerals and their mixtures.*, Elsevier Amsterdam
- Proshina NV (1976) Use of infrared spectroscopy for identification of soil samples. *Nauch. dokl. Vsshei Shk.*, Biol. Naudi, 3, 114–118
- Brame EG, Grasselli JG (1977) *Infrared and Raman spectroscopy.*, Marcel Dekker, 1B, 1C
- Hlavay J, Jonas K, Elek S et Inczedy J (1977) Characterization of the particle size and the cristallinity of certain minerals by infrared spectrophotometry and instrumental methods. I – Investigations on clay minerals. *Clays Clay Miner.*, 25, 451–456
- Hlavay J, Jonas K, Elek S et Inczedy J (1978) Characterization of the particle size and the crystallinity of certain minerals by infrared spectrophotometry and other instrumental methods. II-Investigation on quartz and feldspar. *Clays Clay Miner.*, 26, 139–143
- Ferraro JR et Basile LJ (1978) *Fourier transform infrared spectroscopy. Applications to chemical systems.*, Academic, New York, vol. 1
- Slonimskaya MV, Besson G, Dainyak LG, Tchoubar C et Drits VA (1978) Interpretation of the IR spectra of celadonites and glaucomites in the region of OH-stretching frequencies. *Clay Miner.*, 21, 377–388
- Smith AL (1979) *Applied infrared spectroscopy: fundamentals, techniques and analytical problem-solving.*, Wiley, New York, vol. 54 (chemical analysis).
- Farmer VC (1979) The role of infrared spectroscopy in a soil research institute: characterization of inorganic materials. *Eur. Spectrosc. News*, 25, 25–27
- Ferraro JR et Basile LJ (1979) *Fourier transform infrared spectroscopy. Applications to chemical systems.*, Academic, vol. 2
- Hlavay J et Inczedy J (1979) Sources of error of quantitative determination of the solid crystalline minerals by infrared spectroscopy. *Acta Chim.*, (Budapest), 102, 11–18
- Olphen H Van et Fripiat JJ (1979) *Data handbook for clay materials and other non-metallic minerals.*, Pergamon
- Martin AE (1980) Infrared interferometric spectrometers. In *Vibrational spectra and structure*, Durig J.R. ed., Elsevier, Amsterdam, vol. 8
- Pouchert CJ (1981) *The Aldrich library of infrared spectra.*, Aldrich Chemical Co, 1850 p
- Shika A, Osipova NN et Sokolova TA (1982) Feasibility of characterizing the mineralogical composition of soils by infrared spectrophotometry. *Moscow Univer. Soil Sci. Bull.*, 37, 34–40

- Theng BKG, Russel M, Churchman GJ et Parfitt RL (1982) Surface properties of allophane, halloysite and imogolite. *Clays Clay miner.*, 30, 143–149
- Ferraro JR et Basile LJ (1983) *Fourier transform infrared spectroscopy. Applications to chemical systems.*, Academic, New York, vol. 3
- Fysh SA et Fredericks PM (1983) Fourier transform infrared studies of aluminous goethites and hematites. *Clays clay Miner.*, 31, 377–382
- Velde B (1983) Infra-red OH-stretch bands in potassic micas, talcs and saponites: influence of electronic configuration and site of charge compensation. *Am. miner.*, 68, 1169–1173
- Gillette PC et Koenig JL (1984) Objective criteria for absorbance subtraction. *Appl. Spectrosc.*, 38, 334–337
- Kosmas CS, Curi N, Bryant RB et Franzmeier DP (1984) Characterization of iron oxide minerals by second-derivative visible spectroscopy. *Soil Sci. Soc. Am. J.*, 48, 401–405
- Prost R (1984) Etude par spectroscopie infra-rouge à basse température de groupes OH de structure de la kaolinite, de la dickite et de la nacrite. *Agronomie*, 4, 403–406
- Kodama H (1985) Infrared spectra of minerals. Reference guide to identification and characterization of minerals for the study of soils. *Res. Branch, Agric. Can. Tech. Bull.*, 1E
- Mulla DJ, Low PF et Roth CB (1985) Measurement of the specific surface area of clays by internal reflectance spectroscopy. *Clays Clay Miner.*, 33, 391–396
- Keller RJ (1986) *The Sigma library of FT-IR spectra.*, Sigma chemical Co, vols. 1–2, 2894 p
- Griffiths et Haseth PR (1986) *Fourier transform infrared spectrometry.*, Chemical Analysis Series, Vol. 83, Wiley New York, 672 p
- Russel JD (1987) Infrared spectroscopy of inorganic compounds. In *Laboratory methods in infra-red spectroscopy*, Willis H.ed., Wiley, New York
- Johannsen PG, Krobok MP et Holzapfel WB (1988) *High-pressure FT-IR spectrometry.*, Bruker report, 39–43
- Pouchert CJ (1989) *The Aldrich library of FT-IR Spectra.*, Aldrich Chemical Co, vols. 1-3, 4800 p
- Mottana A et Burragato F (1990) *Absorption spectroscopy in mineralogy.*, Elsevier, Amsterdam, Oxford, New York, Tokyo, 294 p
- Delvigne JE (1998) Atlas of Micromorphology of mineral alteration and weathering. The Canadian Mineralogist, special publication 3, Ottawa et IRD (ex-Orstom), Paris
- Silverstein RM et Webster FX (1998) Spectrometric Identification of organic compounds. Wiley New York, 482 p
- McHale JL (1999) *Molecular spectroscopy.*, Prentice-Hall, London, Sydney, Toronto, 463 p
- Gillon D, Joffre R et Ibrahima A. (1999) Can litter decomposability be predicted by near infrared reflectance spectroscopy. *Ecology*, 80, 175–186
- Confalonieri M, Fornasier F, Ursino A, Boccardi F, Pintus B et Odoardi M (2001) The potential of near infrared reflectance spectroscopy as a tool

- for the chemical characterisation of agricultural soils. *J. Near Infrared Spectrosc.*, 9, 123–131
- Joffre R, Ágren GI, Gillon D et Bosatta E (2001) Organic matter quality in ecological studies: theory meets experiment. *Oikos*, 93, 451–458
- Fearn T (2001) Standardisation and calibration transfer for near infrared instruments: a review. *J. Near Infrared Spectrosc.*, 9, 229–244
- Ludwig B et Khanna PK (2001) Use of near infrared spectroscopy to determine inorganic and organic carbon fractions in soil and litter. In *Assessment methods for soil carbon*, Lal R, Kimble JM, Follet RF et Stewart BA ed., Lewis, UK
- Ozaki Y, Sasic S et Jiang JH (2001) How can we unravel complicated near infrared spectra? – Recent progress in spectral analysis methods for resolution enhancement and band assignments in the near infrared region. *J. Near Infrared Spectrosc.*, 9, 63–95
- Reeves J B et McCarty G W (2001) Quantitative analysis of agricultural soils using near infrared reflectance spectroscopy and a fibre-optic probe. *J. Near Infrared Spectrosc.*, 9, 1, 25–34
- Tso, Ritchie GE, Gehrlein L et Ciurczak EW (2001) A general test method for the development, validation and routine use of disposable near infrared spectroscopic libraries. *J. Near Infrared Spectrosc.*, 9, 165–184
- Fidencio PH, Poppi RJ et de Andrade JC (2002) Determination of organic matter in soils using radial basis function networks and near infrared spectroscopy. *Anal. Chem. Acta.*, 453, 125–134
- Coûteaux MM, Berg B and Rovira P (2003) Near infrared reflectance spectroscopy for determination of organic matter fractions including microbial biomass in coniferous forest soils. *Soil Biol. Biochem.*, 35, 1587–1600
- Brown DJ, Shepherd KD, Walsh MG, Dewayne Mays M and Reinsch TG (2005). Global soil characterization with VNIR diffuse reflectance spectroscopy. *Geoderma*, doi:10.1016/j.geoderma.2005.04.025

## **Mineralogical Separation by Selective Dissolution**

### **6.1 Introduction**

#### **6.1.1 Crystallinity of Clay Minerals**

Mineralogical characterization of cryptocrystalline minerals or minerals with short-range atomic arrangement (Fe, Al, Si, Mn, Ti, P) is essential to understand the geochemical and pedochemical phenomena that occur during the weathering of primary minerals, as well as to explain the evolution and the relative stability of the systems and the kinetics of chemical soil processes. These substances can represent the transition stage between the crystalline parent rock and secondary minerals, and are often regarded as tracers of evolution. The soil is an open system, i.e. it is able to exchange energy and matter with the outside. Most reactions occur under non-equilibrium conditions, and transitory states depend on aqueous or gas flows (chemical reactions at the solid–liquid and liquid–liquid interface), on relaxation times (particle diffusion, transfer of matter, etc.), and of course, on microbial activity.

The individual accumulation of these substances, or their deposit in a fine layer of coating, modifies the activity of the structural sites of crystalline materials, and can inhibit the movement of ions, neutralize charges, or cause substitutions in the lattices. Gels, oxides and oxyhydroxydes, and aluminosilicates can develop charges (some of which are amphoteric). The high level of reactivity induced by their state of division allows adsorption of cations and anions. They can be neutralized by organic substances. These reactions confer greater resistance to weathering and to microbial action. Thus, the ultimate purpose of analysis of non-crystalline products may be soil genesis, and also:

- 
- Soil taxonomy (through processes of podzolisation, andosolisation, laterisation, etc.)
  - Soil mineralogy, mineralogical balances, purification before using other techniques (in particular methods that require the elimination of paramagnetic elements) e.g. ESR, EXAFS, Mossbauer, XRD, FTIR, SEM, EDX, WDX, TEM-HR, STEM<sup>1</sup>
  - The study of the physical and chemical properties of the soil, studies of soil fertility (Fe deficiencies, P fixing, Al<sup>3+</sup> toxicity, transport of heavy metals, destruction of the interparticle cements, aggregation factors, etc.)

Identification of non-crystalline substances requires more than one method: XRD is not very useful with gels because if the quantity of gel is significant, or the early stages of development of a long-range crystalline structure are concerned, only broad bands will be obtained. Chemical dissolution methods are not sufficiently selective in mineralogy, as their action is based on acid, base, reducing, or complexing reagents, and consists for example in:

- Breaking electrostatic (e.g. exchange reactions, Al<sup>3+</sup> bridges) or coordination bonds (e.g. Fe<sup>3+</sup> bridges)
- Causing ionization of functional groups (organic matter)

Dissolution must not only enable extraction of the different phases that are amorphous to X-ray but also:

- Minimize chemical modifications (relative instability of the products to be extracted compared to the soil matrix, and avoid attacks of the clay lattices and primary minerals)
- Limit hydrolysis of the extracted products
- Avoid molecular rearrangements in the liquid phase (nucleation)
- Maintain the extracted products in solution
- Prevent the creation of chemical barriers (insoluble precipitate under the influence of the reagents) and the neo-formation of solid products

---

<sup>1</sup> ESR electron spin resonance; EXAFS extended X-ray adsorption fine structure; XRD X-ray diffraction; FTIR Fourier transform infra-red; SEM scanning electron microscopy; EDX energy dispersive X-ray; WDX wavelength dispersive X-ray; STEM scanning transmission electron microscopy.

All the extractions (e.g. single reagent or multiple reagents, single or sequential extractions) depend on thermodynamic constraints:

- Ion activity, pH, concentration of the reagents, soil/reagent ratio, order of application of the reagents
- Time factors, kinetics of extraction, stirring velocity, duration of contact, ageing of the gel
- Temperature
- Photolytic energy (UV catalyses of the chemical reactions)

Initially the rate of mineralogical extraction is often significant, but subsequently levels off; it is also linked to the size of crystallites and perfection of crystallinity (defects, degree of disorder), or to the nature and the concentration of the elements in the liquid phase. Agreement with other studies, reproducibility and reliability will thus depend on the extraction procedures used. Unless justified by the need to adapt to specific problems, any modification in the procedure (proportion or concentration of reagents, time of contact, etc.) can cause serious errors in evaluation. The required degree of selectivity of mineral extraction can be obtained only by comparing different extractions that have been carefully purified by ultracentrifugation, and by chemical measurement (1) on the liquid phase containing the extracted products (congruent and incongruent reactions) and (2) on the solid phase (e.g. differential XRD, SEM, and EDX). Automatic calculation and interpretation can be performed with a limited number of reliable methods and this makes it possible to quantify each phase and to establish precise and reproducible geochemical balances.

### 6.1.2 Instrumental and Chemical Methods

Measurement by X-ray diffraction works well for atomic lattices with long-range organization, but for substances with short-range arrangement without ordered superstructure, XRD gives flat, unusable spectra (Fig. 6.1). This is why substances presenting this type of flat X-ray spectrum are referred to as amorphous substances.

Progress in instrumental methods has now made it possible to specify the nature of the phases and to determine their arrangement more precisely. The crystalline state is characterized by the periodic repetition of an atomic structure along three non-coplanar directions of space (Maziere 1978). The use of “non-crystalline” or crypto-crystalline substances, rather than paracrystalline, is now allowed (amorphous, without structure; crypto, masked structure; para, almost a structure). It applies to the solids whose structure does not present a repetitive nature at long distance (molecular area at least 3 nm in diameter), but which

presents a degree of order at short distance that confers specific properties. The short-range arrangement takes into account the mutual arrangement with the closest neighbouring atoms at the scale of interatomic distance. These substances do not have a clear spectral signature in X-ray diffraction. With another medium or at the long-distance scale, different types of non-crystallinity can also be observed:

- Zones that present substitution disorders or structural dislocation: this is the case of amorphous substances in a well-arranged periodic structure (structure with defects); high-resolution phase contrast transmission microscopy and scanning transmission electron microscopy (STEM) in micro diffraction mode allow this type of arrangement to be detected and localised.
- Extended zones without periodicity composed of clusters of randomly distributed particles with a short-distance arrangement; this is the case of gels of alumina, iron, silica, and some aluminosilicates (opaline, allophane-like, proto-allophane, allophane, proto-imogolite, gel-like, glass-like, vitric silica etc.).

Some substances display the beginning of medium-distance organization (Fig. 6.1) which results in broad lines in XRD<sup>2</sup> (e.g. imogolite, ferrihydrite, ferroxihyde). Spectroscopic techniques can be used to study these minerals (see Fig. 6.2):

- EXAF<sup>2</sup> techniques provide accurate information on the interatomic distances of the closest neighbours and on the organization of the first layer of coordination, but little information on relations between the polyhedrons (medium-distance coordination).
- XANES<sup>2</sup> techniques enable analysis of the sphere surrounding an atom, but a good knowledge of the structure is a precondition for success.
- NMR<sup>2</sup> spectrometry is selective for chemical structures but not very sensitive; the study of the hyperfine magnetic field of iron oxides makes it possible to measure the degree of crystallinity; in silica gels, the <sup>29</sup>Si nucleus enables the different states of SiO<sub>4</sub> bonds to be distinguished. Different forms of <sup>31</sup>P can also be studied.
- ESR<sup>2</sup> and ENDOR<sup>2</sup> spectrometry enable analysis of the hyperfine and super-hyper-fine structures by electron spin resonance at the atomic scale.

---

<sup>2</sup> See abbreviations p. 168. ENDOR Electron nuclear double resonance.



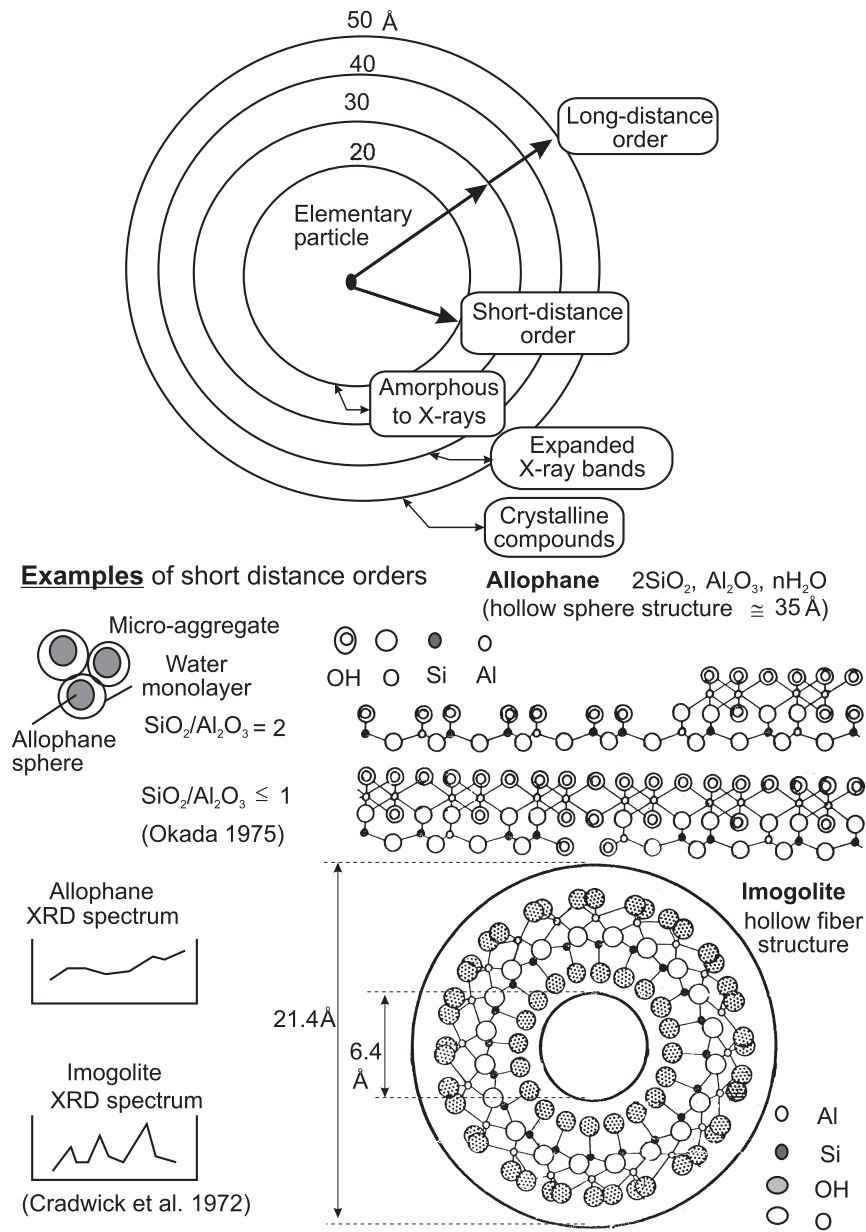

Fig. 6.1. Crystalline and amorphous to X-ray compounds

All these instrumental methods use radiations that correspond to ranges of distance suitable for the sub-micronic scales needed for the study of the structure of soil materials. The range of radiation extends from radio frequencies to X-rays and gamma radiations. Their high purchase price, the degree of specialization of the equipment and their use in very specialised analytical fields limits these types of studies to highly specialised laboratories.

Radio frequencies	micro waves	IR			V	UV	X-rays		$\gamma$ -rays			
$10^9$	$10^7$	F	M	N			10	1	$10^{-1}$	$10^{-2}$	$\lambda$ nm	
$10^9$	$10^{10}$	$10^{12}$	$10^{14}$				$10^{16}$	$10^{18}$	$10^{20}$		$\nu$ Hz	
	1	10	100	$10^3$			$10^5$	$10^7$	$10^9$		$n$ cm $^{-1}$	
Spin transitions (Nucleus)		Molecular rotations		Molecular vibrations		External electrons		Internal electrons		Nucleus		Nature of transitions
NMR		ESR		Raman		IR		XRF		Mossbauer		Techniques
Microwaves								XANES		EXAFS		
$10^{-6}$	$10^{-4}$	$10^{-2}$		1			$10^6$	$10^4$		$10^6$	Energy EV	

**Fig. 6.2.** Analyses of molecular structures using spectroscopic techniques (electromagnetic spectra and environmental probes;  $\lambda$ , wavelength;  $\nu$ , frequency;  $n$ , wavenumber; radiations: F, far IR; M, medium IR; N, near IR, V, visible; UV, ultraviolet); NMR, nuclear magnetic resonance; ESR, electron spin resonance; XRF, X-ray fluorescence; XAFS, X-ray absorption fine-structure spectroscopy; XANES, X-ray absorption near edge structure; EXAFS, extended X-ray absorption fine structure

Instrumental methods allow observations at the sub-micronic scale, but chemical analysis enables analysis of entities that represent the average activity of certain particles because of their surface and their charge. Thus the continuum produced during weathering can be split in a satisfactory way by a series of extractions that make it possible to isolate compounds of increasing crystallinity that correspond, or not, to different chemical species.

### 6.1.3 Selective Dissolution Methods

The range of “selective dissolution methods” is obviously limited because of the diversity of soil minerals (Table 6.1) and the difficulty involved in dissolving a well-defined single phase (Table 6.2).

- Dissolution depends on different factors:
- The size of the “crystal” and the level of atomic disorder
  - Defects in stoichiometry or the blocking of active sites
  - The properties of the crystallographic faces (anisotropy)
  - The porosity of the systems, the density of surface defects, etc.

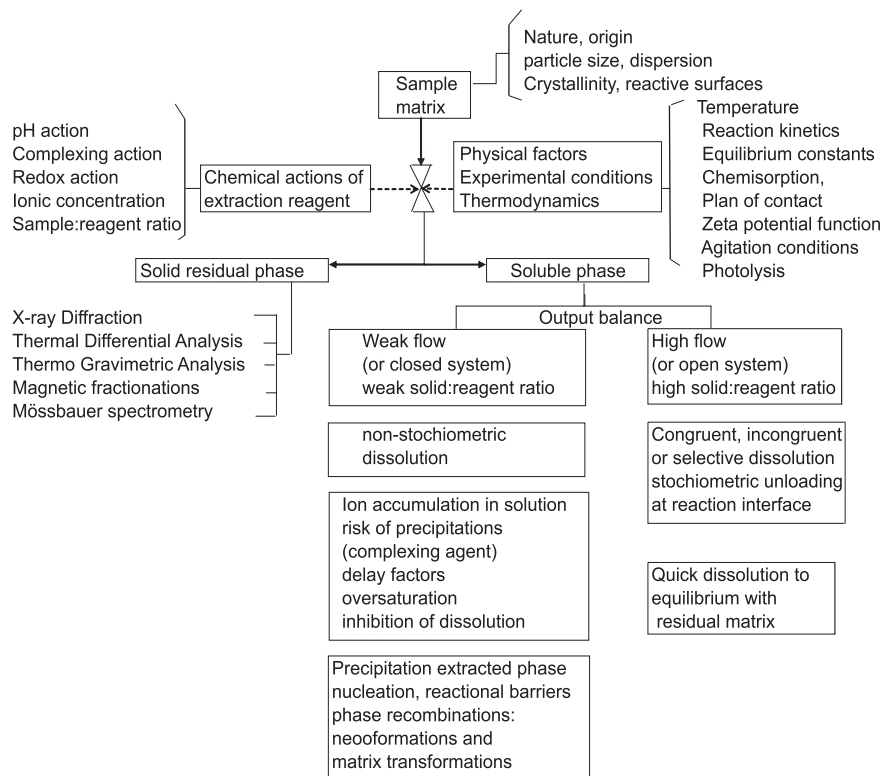
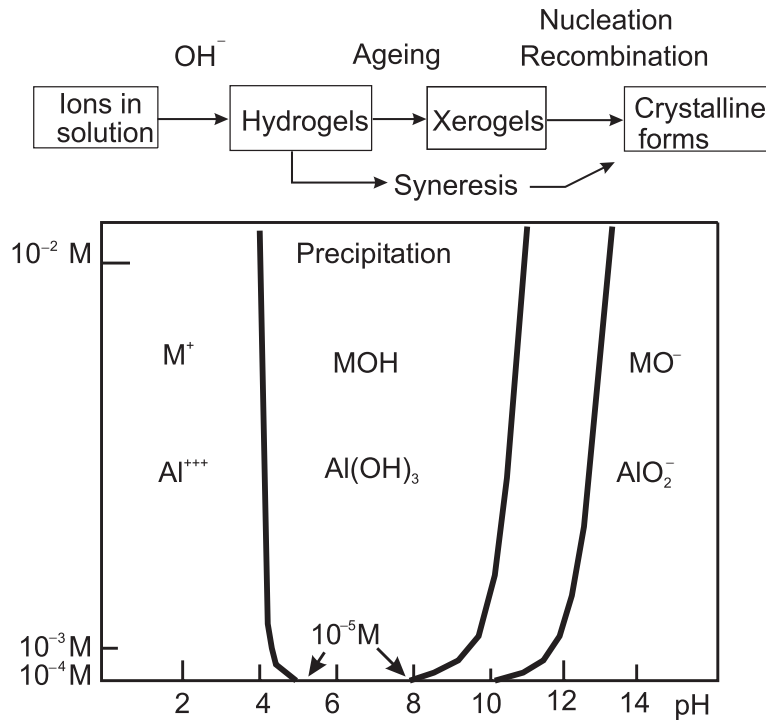

Fig. 6.3. Diagram of factors that control selective dissolution

The reagents used and possible pretreatments should not cause precipitation. They should ensure the maintenance in solution of the extracted products and if possible, limit recombinations in the liquid phase (Figs. 6.3 and 6.4).

Oxides, hydroxides, and oxyhydroxydes cause dependent charges in the soil and their structures, bonds, surfaces, and reactivities vary with their degree of crystallinity and the degree of disorder of their lattices (Table 6.1).



**Fig. 6.4.** Solubility of hydroxides as a function of pH and concentration (*lower parts*) and transformation of hydroxide gels (*upper part*)

### 6.1.4 Reagents and Synthetic Standards

The complexity of iron forms and of non-crystalline products often requires the use of pure synthetic models of minerals with a crystallinity or a short-distance atomic arrangement that closely resembles the substances found in the soil.

The precipitates should be prepared starting from products with a high degree of purity, as hydroxides tend to adsorb impurities because of their very great specific surface. Flocculation is achieved by adding  $\text{H}^+$  or  $\text{OH}^-$  ions. Boiling causes transformation by dehydration and ensures the growth of the gel (nucleation). The time factor allows ageing of the gel, i.e. progressive slow crystallization (Fig. 6.4), transformation from a short-distance organization to an organization of a higher nature. For

example, with aluminium in a ionic state, first precipitation of a monomer will be observed and then hydroxide:

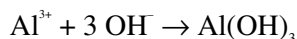

in different steps:

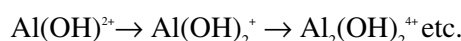

dehydration is accompanied by loss of  $\text{H}^+$  during precipitation. With amphoteric aluminium compounds, the precipitates can be redissolved in alkaline medium forming soluble aluminates. All procedures must be strictly respected in order to obtain precipitation products that correspond to reproducible stages of formation.

These procedures were defined by Henry (1958), Towe and Bradley (1967), Atkinson et al. (1968), Schwertmann and Taylor (1972; 1977), Murphy et al. (1976), Jeanroy (1983), Farmer and Fraser (1978), Pollard (1992), Lewis and Schwertmann (1979).

### **Preparation of Iron Compounds**

#### **Goethite**

- Dissolve 8.08 g of ferric nitrate ( $\text{Fe}(\text{NO}_3)_3 \cdot 9\text{H}_2\text{O}$ ) in 80 mL water in a 250 mL Erlenmeyer flask.
- Bring the pH to 7.5 by adding approximately 20 mL of 3 mol (KOH)  $\text{L}^{-1}$  solution drop by drop (while on a magnetic stirrer).
- Leave for 3 h to form a deposit, siphon the supernatant and wash the precipitate four times with water to eliminate any soluble potassium nitrate that has formed.
- Suspend in 100 mL water, then add 3 mol (KOH)  $\text{L}^{-1}$  solution to bring to a 0.3 mol ( $\text{OH}^-$ )  $\text{L}^{-1}$  solution.
- Store the solution in a polypropylene bottle at 20°C with occasional agitation for 2–5 years depending on the degree of nucleation desired.
- Wash until elimination of KOH.
- Dry in a ventilated drying oven at 50°C.

#### **Akaganeite**

- Grind a sample of pure  $\text{FeCl}_2 \cdot 4\text{H}_2\text{O}$  in an agate mortar to pass through a 0.5 mm sieve.
- Spread in a thin layer and allow hydrolysis to occur in contact with humid air for 6 months (the product will turn brown over time).
- Wash with  $\text{H}_2\text{O}$  to eliminate remaining  $\text{Fe}^{2+}$ , then dry at 50°C.

**Table 6.1.** Main crystalline and non-crystalline oxides and oxyhydroxides in soil (Si, Fe, Al, Mn, Ti, mixed)

Fe	Al	Mn	Ti	Si	mixed gels (with charge)
$\text{Fe}^{3+} + \text{e}^- \leftrightarrow \text{Fe}^{2+}$	$\text{Al}^{3+}$	$\text{Mn}^{\text{IV}+} + 2\text{e}^- \leftrightarrow \text{Mn}^{2+}$	$\text{Ti}^{4+} + 2\text{e}^- \leftrightarrow \text{Ti}^{2+}$	$\text{Si}^{\text{IV}}$	Si Al, Fe, Mn P
hematite $\alpha\text{-Fe}_2\text{O}_3$	corundum $\alpha\text{-Al}_2\text{O}_3^{(1)}$	hollandite $\alpha\text{-MnO}_2$	rutile $\text{TiO}_2$	$\alpha$ quartz (low) $\text{SiO}_2$	allophane $\text{Al}_2\text{O}_3\text{-}2\text{SiO}_2\text{,}n\text{H}_2\text{O}$
maghemite $\gamma\text{-Fe}_2\text{O}_3$	gibbsite $\gamma\text{-Al(OH)}_3$	cryptomelane $\alpha\text{-MnO}_2$	anatase $\text{TiO}_2$	$\beta$ quartz (high) $\text{SiO}_2$	Imogolite
magnetite $\text{Fe}_3\text{O}_4$ ( $\text{Fe}^{2+}\text{Fe}^{3+}\text{O}_4$ )	bayerite $\alpha\text{-Al(OH)}_3^{(1)}$	pyrolusite $\beta\text{-MnO}_2$	brookite $\text{TiO}_2$	$\alpha$ tridymite $\text{SiO}_2$	hisingerite $\text{Fe}_2\text{O}_3\text{-}2\text{SiO}_2\text{,}n\text{H}_2\text{O}$
goethite $\alpha\text{-FeOOH}$	diaspore $\alpha\text{-AlOOH}$	birnessite $\delta\text{-MnO}_2$	ilmenite $\text{FeTiO}_3$	$\alpha$ cristobalite $\text{SiO}_2$	penwithita $\text{SiO}_2\text{-Mn}$
*lepidocrocite $\gamma\text{-FeOOH}$	boehmite $\gamma\text{-AlOOH}$	manganite $\gamma\text{-MnOOH}$	(leucoxene see ilmenite)	coesite $\text{SiO}_2$	evansite $\text{Al}_3\text{PO}_4(\text{OH})_6\text{,}7\text{H}_2\text{O}$
ferrhydrite $\text{Fe}_2\text{O}_3\text{,}2\text{FeOOH}$	nordstrandite $\text{Al(OH)}_3$	groutite $\alpha\text{-MnOOH}$	stishovite $\text{SiO}_2$		azovskite $\text{Fe}_3\text{PO}_4(\text{OH})_6\text{,}7\text{H}_2\text{O}$

*feroxyhite $\delta\text{FeOOH}$	*(kriachite $\text{Al}_2\text{O}_3, n\text{H}_2\text{O}$ )	hausmanite $\text{Mn}_3\text{O}_4$ ( $\text{Mn}^{2+}, \text{Mn}^{3+}, \text{O}_4$ )	* opal $\text{SiO}_2$
akaganeite $\beta\text{FeOOH}$		todorokite	* gel silica $\text{SiO}_2(n\text{H}_2\text{O})$
*stilpnosidérite (gel) $\text{Fe}_2\text{O}_3, n\text{H}_2\text{O}$		* vernadite $\delta\text{MnO}_2, n\text{H}_2\text{O}$	*gel titanium $\text{TiO}_2, n\text{H}_2\text{O}$
(limonite $\text{Fe}_2\text{O}_3, n\text{H}_2\text{O}$ see goethite)		lithiophorite (Al, Li) $\text{Mn O}_2 (\text{OH})_2$	chalcedony (fibrous) $\text{SiO}_2$
<sup>(3)</sup> pH 7.5 $\text{Fe}^{3+}/2\text{Fe}^{2+}$	pH 4.0 + redissolve pH 9.0	pH 8.5–8.8	biogene silica ( $\text{SiO}_2$ )
		pH 1–3	

- 1 not very frequent or non pedogenic (primary minerals).
  - 2 ↔ isostructure.
  - 3 theoretical mean pH of precipitation in aqueous medium.
- \* gel, short-distance arrangement.  
( ) obsolete terminology.

***Lepidocrocite***

- Dissolve 0.6 g of  $\text{FeCl}_2 \cdot 4\text{H}_2\text{O}$  in 150 mL of a 0.2 mol (NaCl)  $\text{L}^{-1}$  solution saturated with nitrogen by bubbling using a peristaltic pump regulated at a flow rate of  $15 \text{ mL min}^{-1}$ .
- Agitate under nitrogen and adjust pH to 6.0 by adding NaOH 1 mol  $\text{L}^{-1}$  drop by drop.
- Allow the pH to stabilize, then replace nitrogen bubbling by air; maintain the pH during oxidation (2 h 30 min).
- Wash with water, then dry at  $50^\circ\text{C}$ .

***Poorly ordered Ferrihydrite***

- Dissolve 2.02 g of  $\text{Fe}(\text{NO}_3)_3 \cdot 9\text{H}_2\text{O}$  in 500 mL distilled water and bring the pH to 7.5 by adding 15 mL of 1 mol (NaOH)  $\text{L}^{-1}$  solution drop by drop.
- Store for 18 h at pH 7.5.
- Wash with water and dry at  $50^\circ\text{C}$ .

***Hematite***

- Prepare a solution M of ferric chloride ( $\text{FeCl}_3 \cdot 6\text{H}_2\text{O}$ ).
- Precipitate with  $\text{NH}_4\text{OH}$  at  $60^\circ\text{C}$ .
- Filter on rapid filter.
- Wash until the  $\text{Cl}^-$  test is negative ( $\text{AgNO}_3$  test).
- Calcinate for 1 h at  $500^\circ\text{C}$ .

***Maghemite***

- Weigh 5 g of ferrous oxalate ( $\text{FeC}_2\text{O}_4 \cdot 2\text{H}_2\text{O}$ ) and place it in a quartz crucible with a lid.
  - Heat gradually in an electric furnace at  $410\text{--}420^\circ\text{C}$  and maintain at this temperature for 1 h to eliminate water of constitution.
- The resulting product is close to maghemite.

***Organic amorphous iron***

- Extract the organic matter (OM) of a 20 g sample of podzolic soil with high humus content with 900 mL of 0.2 mol (NaOH)  $\text{L}^{-1}$  solution.
- Centrifuge the extract, then filter (calculate the OM content expressed as C content).
- Prepare a ferric nitrate solution ( $\text{Fe}(\text{NO}_3)_3 \cdot 9\text{H}_2\text{O}$ ) containing 108 g  $\text{L}^{-1}$ .
- In 225 mL of this solution (3.35 g of iron) add the desired proportion of OM extract.
- Agitate while checking the pH with a pH meter; the final pH should be 5.0; a brown–red gel will precipitate.
- Wash with distilled water until complete elimination of sodium.
- Preserve the gel in water and check the iron content ( $\text{mg mL}^{-1}$ ).





### ***Preparation of Al<sup>3+</sup> Compounds***

#### ***Boehmite***

- Prepare a 0.1 M solution of AlCl<sub>3</sub>.
- Neutralize to pH 6 with 0.4 mol (NaHCO<sub>3</sub>) L<sup>-1</sup> solution.
- Leave in contact for one hour.
- Bring to pH 8 by slowly adding 0.15 mol (NaOH) L<sup>-1</sup> solution.
- Store in a closed plastic (PTFE) bottle for 60 h at 160°C.
- Cool, wash until elimination of bicarbonate and remove surplus sodium hydroxyde by centrifugation.
- Store in suspension in closed polythene bottle.

### ***Preparation of mixed compounds***

#### ***Imogolite***

- Place 30 mmol of aluminium perchlorate in 2.5 L of deionised water.
- Add 15 mmol of tetraethyl silicate, this corresponds to approximately 3.3 mL of commercial solution.
- Homogenize, then bring the pH to 4.5 with soda.
- The mixture will become opalescent; leave to stand overnight and the liquid will become clear.
- Boil gently at reflux boiling point for 5 days.
- Leave to cool, then add ammonia to gradually reach pH 9.0; the gel will precipitate.
- Wash until elimination of sodium; store in water and measure the Al and Si concentrations.

## **6.2 Main Selective Dissolution Methods**

### **6.2.1 Acid Oxalate Method Under Darkness (AOD)**

#### ***Principle***

This dissolution reagent is also called Tamm reagent. The method allows allophane and gels, iron, and aluminium organic complexes, hydrated oxides of iron, and aluminium (ferrihydrite, feroxyhite) to be dissolved. Imogolite is not completely dissolved in only one treatment. Phyllosilicates are only very slightly attacked, except if their level of

disorder is significant. Lepidocrocite is sensitive to oxalate reagent. If several treatments (2–3) are performed; some Al and Fe crystalline compounds can be solubilized to a considerable extent.

The ammonium oxalate-oxalic acid buffer induces processes of protonation, complexation, and reduction. In this way it can cause the transfer of protons, electrons and ions (Stum 1985; Furrer 1985–1987; Cornell and Schindler 1987; Schwertmann 1991).

The oxalate ion forms three complexes with ferric iron:

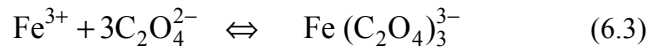
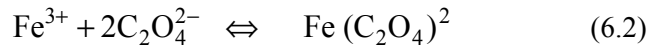

(ferrous iron also gives complexes with other constants of stability and solubility).

An excess of oxalate buffer is required to bring the equilibrium reactions to stage (6.3); if not the  $\text{C}_2\text{O}_4^{2-}$ -acceptors  $\text{H}^+$  and  $\text{Fe}^{3+}$  can induce competitive reactions, particularly if raising the pH decreases the constants of solubility.

With  $\text{Al}^{3+}$  a complexation of the following type occurs:

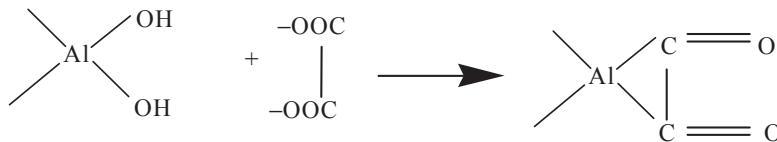

Below a pH of 3.5, the surfaces of the oxides are saturated with protons. The pH 3.0 zone is thus favourable because it controls charges below the point of zero charge (cf. Chap. 20). With respect to the reactional stages, protonation should be the first stage of dissolution of the compound, as this reaction allows better adsorption of the complexes and simultaneous synergic action.

In the case of non-crystalline compounds of iron and manganese, reduction is preponderant:

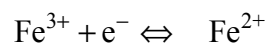

The complexing reagent has two effects:

- Ferric ions become less oxidizing as the ferrous ions are more reducing; the  $\text{Fe}^{3+}:\text{Fe}^{2+}$  ratio decreases, solubility increases; the reaction is autocatalytic
- It affects pH (and maintains it at 3.0 with the buffer system) and thus influences the dissolution and stability of complexes; it prevents variations in the oxydoreduction potential which would otherwise be caused by the variations in pH.

### ***Changes in the Method***

Tamm (1922, 1931, 1934a,b) recommended an ammonium oxalate-oxalic acid buffer reagent to dissolve the inorganic gels including iron oxides, free silica, and alumina. This author suggested a pH of 3.25.

A rapid examination of the composition of the reagents used since 1922 in the Tamm method highlights the many different procedures used (e.g. variations in the concentration of the reagents, in pH, in the soil/reagent ratio, contact time, agitation, temperature, photolysis, see Fig. 6.5).

Some changes were made to adapt the method to the nature of the sample and its components. Comparisons with old data are often difficult because of complexity of the soil matrix and interactions, and especially because the exact operating conditions are unknown.

Jung (1934) stated that the method was appropriate for light soils, but not for calcareous soils, and that it did not give repeatable results with heavy soils because of the attack of clays. Many studies have been published on different soil types using varying concentrations of reagents and a pH ranging from 3 to 6, or using other organic acids (tartric, citric, salicylic, benzoic, phtalic, malonic acid, etc.) combined or not with reduction with  $\text{H}_2\text{S}$ , nascent hydrogen, or dithionite (Duchaufour and Souchier 1966).

A significant stage in the development of the Tamm method was the discovery of photosensitivity during dissolution (Schoefield 1959) and of the effects of photosensitization (De Endredy 1963, this method being known as Tamm-UV), and especially the establishment of a reference procedure by Schwertmann (1964) also called Tamm reagent in darkness. This method is now used as an international standard.

The time factor has a random influence on the reactions, the dissolution process generally being rapid at the beginning but tending to slow down considerably after 4 or 5 h. The influence of time is generally only critical if it is less than 2 h. Schwertmann fixed the average time at 2 h on the basis of a profile of traditional dissolution indicating the preferential dissolution of certain fractions (ferrihydrite, substances with

short-distance arrangement, etc.). Mc Keague and Day (1966) showed that in their conditions, dissolution was better when the contact time was increased to 4 h (in darkness). Although a sequence of treatment of this duration can have a kinetic effect, only one extraction is the basis of this method.

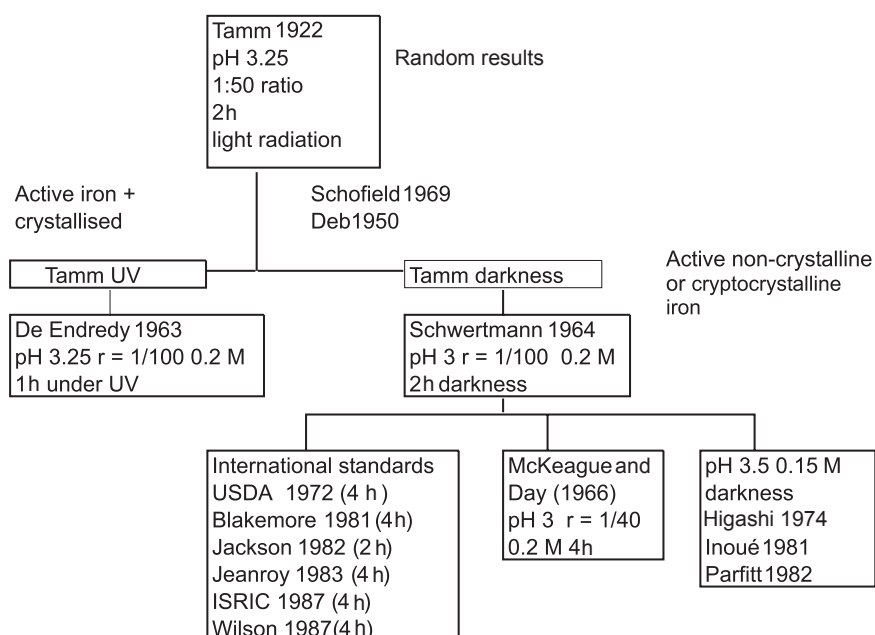

**Fig. 6.5.** Changes of the Tamm method using ammonium oxalate-oxalic acid reagent (basic procedures)

The soil/solution ratio generally has a limited influence on the results. Parfitt (1989) showed that extraction using the 0.15 M reagent at pH 3.0 with a soil/solution ratio of 1:100, agitation for 4 h at 20°C (in darkness) was satisfactory for many soils, but cannot be used if Al or extractable Fe exceeds 5%. In this case it is necessary to use a 0.20 M reagent and a ratio of 1:200.

Extraction with 0.15 M oxalate or 0.20 M reagents at pH 3.0 gives equivalent results for allophane if the concentration of allophane does not introduce a limiting factor.

The pH of extraction is critical. It controls the kinetics of dissolution of the crystalline and non-crystalline compounds. Maximum dissolution is reached at a pH of between 2.6 and 3.0, the protonation being synergistic with the reducing and chelating action of the oxalate reagent. If the pH

rises above 4.0, the effectiveness of the buffer decreases drastically, the extracted quantities of iron decrease and selectivity is modified. The pH should thus be fixed at 3.0, to prevent possible variations. Temperature accelerates the reaction and modifies selectivity. The standard temperature is around 20°C.

### **Preparation of the Reagents**

All the reagents should be prepared with reference products, bi-distilled water, or water deionised on a resin column that can fix Si.

*Acid ammonium oxalate:* 0.2 M oxalate-pH 3.0 Tamm reagent

- Dissolve 16.15 g of ammonium oxalate  $(\text{COONH}_4)_2 \cdot \text{H}_2\text{O}^3$  and 10.90 g of oxalic acid  $(\text{COOH})_2 \cdot 2\text{H}_2\text{O}^4$  in approximately 900 mL of water; complete to 1000 mL.
- Check the pH and bring it to pH 3.0 by adding ammonia or 0.2 M oxalic acid.
- Prepare each week and store in a brown bottle protected from the light.
- 0.2% superfloc (flocculation agent) in water (Cyanamid Corp.).
- Matrix corrector for dilutions before atomic spectrometry: for 10,000 ppm K  
weigh 19 g of KCl,  
dissolve in approximately 900 mL of water,  
when the temperature of the solution reaches ambient temperature,  
complete to 1,000 mL.

### **Procedure**

- Measure soil moisture on a separate sub-sample to determine the moisture correction factor (cf. Chap. 1).
- On the laboratory balance, weigh 1 g of air-dried soil sieved with a 0.2 mm mesh (avoid over-grinding).
- Put in a 100 mL bottle.
- Add 50 mL of acid oxalate reagent; for soils with high extractable-oxalate compounds (extracted Al or Fe compounds >2%) add 100 mL oxalate reagent and use a 250 mL bottle.

<sup>3</sup>  $(\text{NH}_4)_2\text{C}_2\text{O}_4 \cdot \text{H}_2\text{O}$ , *mw*: 142.12; can be awkward for certain clays (and can be replaced by sodium oxalate  $\text{Na}_2\text{C}_2\text{O}_4$ ); safety: a classified poison, do not ingest.

<sup>4</sup>  $\text{COOH-COOH} \cdot 2\text{H}_2\text{O}$ , *mw*: 126.07 decomposed by UV radiation; drying at 100°C involves losses by sublimation, decomposition at 160°C; safety: a classified poison – caustic – do not ingest).

- Agitate 4 h in darkness.
- Decant part of the supernatant in a 50 mL centrifugation tube.
- Centrifuge for 10 min at 10,000 g; if the liquid is not perfectly limpid, resuspend, add 3 drops of superfloc and centrifuge again (two reactive blanks should be integrated into each series in addition to a soil standard of reference and two replicates on a sample of the series).

After adequate dilution, analyses are carried out on this extract:

- Si: ICP or AAS spectrometry at 251.6 nm, N<sub>2</sub>O/C<sub>2</sub>H<sub>2</sub> flame
- Fe: ICP or AAS spectrometry at 248.3 nm, air/C<sub>2</sub>H<sub>2</sub> flame
- Al: ICP or AAS at 309.3 nm, N<sub>2</sub>O/C<sub>2</sub>H<sub>2</sub> flame
- Mn: ICP or AAS at 279.5 nm, air/C<sub>2</sub>H<sub>2</sub> flame

and if necessary, Ti and P.

If absorption spectrophotometry is required:

- Destroy the oxalate matrix by boiling with concentrated nitric acid
- Bring to dry and dissolve in 5 M hydrochloric acid
- Evaporate to almost dry and dissolve in water, then complete to the required volume

### Calculations

#### Data collected

- $P_1$ , weight of wet or air-dried soil sample for measurement of moisture.
- $P_2$ , weight of the soil sample dried at 105°C.
- $P$ , weight in mg of soil sample for extraction.
- $A, B$ , contents in the extract and the blank respectively (mg L<sup>-1</sup>).
- $D$ , dilution of the extract.
- $V_R$ , mL of the oxalate reagent used for extraction.

#### Moisture correction factor

This measurement is essential to bring back the results to soils dried at 105°C, especially for all soils rich in non-crystalline substances like allophanic soils:

$$H = 100 \frac{P_1 - P_2}{P_1} (\%)$$

Moisture correction factor =  $f = 100/H$

Calculation of contents of elements (Fe, Al, Si, Mn, Ti, P, etc.):

$$\% \text{ element} = 0.1 (D V_R f (A - B)) / P$$

Conversion factor of the content of an element to oxide content:

$$\% \text{ Fe}_2\text{O}_3 = \% \text{ Fe} \times 1.43$$

$$\% \text{ MnO}_2 = \% \text{ Mn} \times 1.58$$

$$\% \text{ Al}_2\text{O}_3 = \% \text{ Al} \times 1.89$$

$$\% \text{ SiO}_2 = \% \text{ Si} \times 2.14$$

**Remarks**

The extraction is reliable enough for most soils. Identification of certain phases may sometimes be difficult when clays are disordered. Even when extracts are protected from the light, they can still undergo change. They should thus be analysed rapidly to avoid precipitations due to the instability of the reagent.

The addition of superfloc is generally not necessary given the strong ionic force of the reagent and the resulting complexes. The supernatant liquid can be filtered by siphoning with a syringe equipped with a 0.45 µm filter (after decantation).

Oxalate extraction is used in a number of different fields.

- Pedology and pedogenesis, geochemistry (differential dissolutions and identification of the non-crystalline or little ordered phases, transitions between crystalline phases, chemical and methodological studies, effect on the soil structure, etc.) preferably using data from the dissolved phases.
- Mineralogy uses the solubilized phases and the residual solid phases simultaneously for:
  - The study of substitutions, order–disorder states, compounds with short-range atomic arrangement;
  - For the preparation of samples (dissolution of cements between the particles, elimination of oxides to improve the intensity of diffraction of the crystalline compounds), to carry out differential XRD analyses (DXRD) and to enable analysis after elimination of paramagnetic compounds (Mössbauer, ESR, EXAFS spectrometries), to observe spatial distribution on thin sections of the soluble oxalate phases (Arocena 1988), and finally to model deterioration processes (resulting compounds, etc.).
- Microbiology and agronomy to analyse biophysical and biochemical activity (effect on water retention, plasticity, availability for plants of active iron linked to oxalic acid contents generated in the soil (oxalic acid of biochemical origin causes the disruption of iron oxides).
- In the case of calcareous soils, ammonium oxalate precipitates  $\text{Ca}^{++}$  cations in the form of calcium oxalate with solubility lower than 0.006 g per litre of water or acetic acid; the carbonate must thus be destroyed with the minimum quantity of acetic acid necessary before extracting ammonium oxalate and complementary measurements of the elements solubilized with acetic acid.
- In reducing conditions (e.g. hydromorphic soils, histosols, andosols under permanent wet climate), the oxalate method cannot provide



information on the initial state of oxidation of iron and manganese in the soil before extraction.

- In andic soils and andosols–andisols the oxalate method can extract as much as the DCB method (cf. Sect. 6.2.2); the organic complexes of iron are dissolved; allophane, which is extracted after 2–4 h agitation with oxalate, can be estimated using the values for extracted silicon based on the hypothesis of the prevalence of Si–O–Al bonds; ferrihydrite can be estimated starting from extracted iron.

### 6.2.2 Dithionite-Citrate-Bicarbonate Method (DCB)

#### *Principle*

This method (Mehra-Jackson 1959–60) makes it possible to solubilize pedogenic oxides and hydroxides:

- crystalline iron oxides (hematite, goethite), non-crystalline iron oxides and iron and aluminium organic complexes, as well as exchangeable iron and manganese oxides, some non-crystalline compounds with a  $\text{SiO}_2:\text{Al}_2\text{O}_3$  ratio of less than 0.5;
- magnetite and ilmenite are only slightly attacked, as are gibbsite and allophane-imogolite aluminosilicates; however, magnetite can be significantly solubilized in certain cases (magnetite is strongly oxidized into maghemite in very oxygenated medium);
- clays are not affected, but any iron present in the lattice of vermiculites and non-tronite can be significantly solubilized, particularly if the extraction pH is lowered;

Reduction is the predominant process of this method, dithionite being a very active reducer (Deb 1950) below pH 9–10. Biologically reducible elements like iron or manganese are reduced and maintained in solution by complexation with the citric acid in the system buffered at pH 7.3 with sodium bicarbonate.

The optimum pH for reduction is 7–8. Below pH 6.5, colloidal sulphur can precipitate resulting in a suspension in the extracts that prevents measurement by absorption spectrometry. The use of buffered medium limits this phenomenon. As the dithionite solution rapidly loses its reduction properties, complexation avoids reoxidation as well as the precipitation of iron sulphide and allows maintenance in solution of the extracted phases as long as the extraction time does not exceed 15 min.

Initially, only one addition of dithionite was performed on the first extract. Subsequently, as a result of international influences and on the

recommendation of the initiator of the method, two additions of dithionite were recommended.

If required, two or three successive extractions can be performed to include crystallized iron compounds of relatively significant size. In this case, the extracts can either be mixed before analysis or analysed individually to measure a kinetic evolution of the solubility, summation is only carried out after each measurement.

The temperature should be set at 75°C to accelerate the reaction and to limit the appearance of colloidal sulphur and iron sulphide, but also to minimize dithionite decomposition. This temperature should not be exceeded, and localised overheating should be avoided by using a water-bath.

The iron contents should not exceed 0.5 g Fe<sub>2</sub>O<sub>3</sub> in order to obtain an excess of reducer and complexant. The reaction of iron reduction in a slightly basic medium can be written:

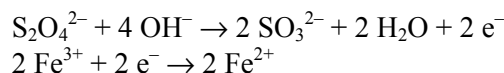

and in citric complexing solution

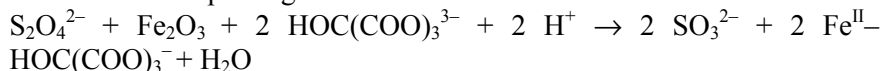

The weight of the sample must be between 1 and 5 g without modifying the composition of the reagent (if iron cannot be complexed due to insufficient citrate, precipitation of black iron sulphide may occur).

A buffered medium is used to avoid a change in pH resulting in variations in the Redox potential, each Fe<sup>3+</sup> requiring two OH<sup>-</sup> during reduction.

Certain authors tested reduction methods using dithionite in citrate with variable pH (Homgren 1967; Avery and Bascom 1982) or Tamm reagent (Duchaufour and Souchier 1966; Hétier and Jeanroy 1973; Loveland and Bullock 1976) or in other buffered and complexing mediums such as sodium tartrate-acetate (Deb 1950) or in a medium with a basic pH such as pyrophosphate (Franzmeier et al. 1965).

Complexes with citric acid (a tridentate sequestering agent) are similar to those formed with oxalic acid and give very stable iron and aluminium compounds. Aluminium citric acid complexes have a stability constant, log K<sub>1</sub> = 7.37.

In the natural environment, the presence of citrate prevents, or delays, the precipitation of aluminium, as the sites of coordination are occupied by citrate, its hydrolysis is slowed down:

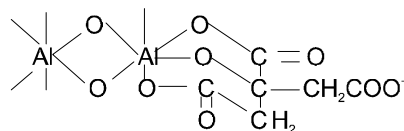

Replacement of the water molecules and blocking of the sites of coordination occurs in the DCB extraction medium, which has a high concentration of citric acid. Hydrolysis thus becomes impossible (Kwong and Huang 1979). Some minerals, for example pseudo-boehmite, present a particular affinity (Cambier and Sposito 1991).

Two other reagents (hydroxylamine hydrochloride and acidified hydrogen peroxide) were found more efficient than DCB method for selective dissolution of manganese oxides (Neaman et al. 2004a,b).

The DCB treatment can cause structural disorders which can be observed by XRD or electron micro-diffraction. The adsorption of citric groups on certain clays can considerably slow down the departure of interfolayer water. This should be taken into account in the analysis of the residue containing the forms known as “free”. It should be noted that under these conditions, proto-imogolite cannot be transformed into the better structured imogolite.

### ***Preparation of the Reagents***

All the reagents should be reference products for analysis, water should be bidistilled or possibly deionized on resins suitable for the elimination of silica.

- Sodium dithionite in powder form depending on the number of analyses, only small bottles of the product should be used in order to always have fresh product available.
- Citrate-bicarbonate buffer: dissolve in distilled water before use 79.40 g of trisodium citrate ( $C_6H_5Na_3O_7 \cdot 2H_2O$ ), 9.24 grams of sodium bicarbonate ( $NaHCO_3$ ), check the pH which should be 7.3 approximately, bring to 1 L.
- Flocculation use either 400 g saturated sodium chloride, NaCl in 1 L of water, or 375 g saturated potassium chloride, KCl in 1 L of water, if further measurements by atomic absorption or ICP spectrometry are required, potassium chloride should be used in order to avoid stronger sodium concentrations, acetone.

**Procedure**

- In a flat-bottomed 100 mL centrifugation tube made of polypropylene or PTFE, place from 1 to 5 g of soil (0.2 mm particle size ) depending on the estimated concentration of ferric oxide (carbonates, organic matter and soluble salts must be removed from the sample beforehand).
- Add a bar magnet and 45 mL of buffered citrate-bicarbonate reagent by means of a fraction distributor equipped with a PTFE syringe.
- Place on a immersed magnetic stirrer in a water bath regulated at 75°C; when the sample reaches the temperature of the bath, using a measure, add 1 g of dithionite powder and continue to agitate at moderate speed for 5 min.
- Add another gram of dithionite and agitate for 10 min.
- After 15 min digestion, centrifuge for 5 min at 2,500 g to obtain a limpid solution (if the liquid is still cloudy, suspend and add a saturated solution of sodium or potassium chloride to cause flocculation then centrifuge again at 2,500 g; this treatment will make the centrifugation pellet more compact and thus complicate resuspension for a 2nd treatment; for soils originating from volcanic ash, it is often necessary to add 10 mL acetone before centrifugation to achieve satisfactory flocculation).
- Decant the clear supernatant liquid in a 250 mL volumetric flask.
- If the residue displays intense brown, black, or red colour, add 45 mL of buffered reagent and treat as above with two additions of dithionite and heat for 15 min at 75°C, re-suspend the compact centrifugation pellet to allow a homogeneous attack.
- Centrifuge and decant in the same 250 mL flask (or analyze the second extract separately).
- Wash the residue two or three times with 10 mL of buffered reagent, flocculate, centrifuge the rinsing products and add them to the previous extract.
- Add 250 mL distilled water and homogenize.

In each series, introduce two blanks (reagents only) and a reference sample. After adequate dilution (2–10 times) the filtrate containing free oxides and hydroxides should be analysed by atomic absorption spectrometry:

- Al at 309.3 nm with an acetylene–nitrogen protoxide flame.
- Fe at 248.3 nm with an acetylene–nitrogen protoxide flame.
- Si at 251.6 nm with an acetylene–nitrogen protoxide flame.
- Mn with 279.5 nm with an acetylene–air flame.
- Ti, P, K, Mg can be also analysed if necessary.

If colorimetry is used, certain methods make it possible to operate directly on the extracts, but it is preferable to destroy the buffered, chelating and reducing matrix by boiling with nitric or sulphuric acid and perhydrol. Iron is measured using 1–10 orthophenantroline or ferron, aluminium using eryochrome cyanin, silica using molybdate taking phosphorous into account (cf. Chap. 31).

Weigh the purified residue. The residue can be analysed using XRD, an instrumental method; the intensity of the lines is improved by DCB treatment (cf. Chap. 4); IR, ESR, NMR, EXAFS spectrometry (cf. Chap. 12); thermal analysis, DTA-TGA (cf. Chap. 7); or chemical analysis (total analysis, cf. Chap. 31); CEC (cf. Chap. 26); dissolution of aluminosilicates, etc.).

### **Calculations**

#### **Data collected**

- *A*, *B*: respective contents in the sample and blank extractions in mg L<sup>-1</sup>.
- *D*: dilution factor.
- *f*: moisture correction factor (cf. “Calculations” under “Acid oxalate Method under Darkness”).
- *P*: weight of air-dried sample in mg.

#### **Calculations**

Oxide percentages should be calculated for all the elements: Fe<sub>2</sub>O<sub>3</sub>, Al<sub>2</sub>O<sub>3</sub>, SiO<sub>2</sub>, etc. The “weight of the initial sample” minus the “weight of residue” enables total free oxides and hydroxides to be calculated:

$$\text{Al, Fe, Si... \%} = 25 (A-B) D f/P$$

See “Calculations” under Sect. 6.2.1 for the conversion factors of elements into oxides.

### **Remarks**

This method gives reasonably reproducible results if the crystalline iron forms are sufficiently fine to offer enough surface area to allow a significant attack. Many different procedures have been proposed, but the current standard method is identical for the reagent concentration to that initially suggested by Mehra and Jackson (1959): 0.42 g of sodium bicarbonate and 3.52 g of sodium citrate, 2H<sub>2</sub>O in 45 mL of water. The main modifications one of the authors made of the method are: double reduction of dithionite on the same extract and the preparation of a single buffer-complexing reagent, which simplifies handling.

The colour of the residue gives a good indication of the effectiveness of the treatment, but the presence of magnetite or ilmenite, which are not attacked by the DCB treatment, can colour the residue black or gray. The DCB method can be used to facilitate dispersion of clay whose suspension may be obstructed by pedogenic oxide and hydroxide coatings.

The method of Holmgren (1967), whose reagent is composed of a rather unstable mixture of 17% sodium citrate and 1.7% sodium dithionite, is now sometimes used instead of the DCB method. It is considered to be equivalent to the Mehra–Jackson method, but simpler to implement and thus more suitable for repetitive analysis.

Grinding to 0.2 mm allows a better attack of the iron forms present in concretions for example. Grinding is consequently generally performed to enable comparisons to be made, and in particular to compare the weight of the residues after treatment.

Heating to temperatures above 80°C (or local overheatings) can cause the precipitation of black iron sulphide. In this case it is better to start the analysis again than to eliminate the precipitate with acetone and carbon tetrachloride.

Dithionite treatment modifies the  $\text{Fe}^{3+}:\text{Fe}^{2+}$  ratio.

Ryan and Gschwend (1991) suggested replacing dithionite with titanium III in the citric-bicarbonate + ethylene diamine tetraacetic acid (EDTA) solution. This reduction method, with the very complexing reagent at a temperature of 80°C, should theoretically enable more complete dissolution of the amorphous ferric oxides and goethite. But hematite is less solubilized. Extraction is more easily achieved with the Ti (III) method than with the DCB method, which gives the Ti (III) method a more selective spectrum of dissolution. The behaviour of the aluminium compounds is different. The use of the cold Ti (III) method increases the degree of selectivity, but the titanium content of the soil must be low.

### 6.2.3 EDTA method

#### *Principle*

The EDTA (salt of Na) method according to Borggaard (1976), enables extraction of iron in an amorphous or very little ordered state as a result of biological deterioration (inorganic and organic non-crystalline iron) the ferrihydrite is dissolved. Both the water-extractable iron and the exchangeable iron must be in solution.

This reagent is not suitable for the extraction of the amorphous and organic forms of aluminium because of the high pH of the extraction solution. The silicates and crystalline forms of iron and aluminium are not dissolved.

The repeatability and selectivity of iron extraction are good. The method is reliable, but has one major disadvantage: the slowness of the extraction, the balance being achieved only after approximately three months of extraction. The most widely used process is hydrolysis and complexation in basic medium at ambient temperature (20°C).

EDTA is an aminopolycarboxylic acid with six atoms suitable for the formation of chelates (from the Greek Khéle = crab grip) to which a metal cation is linked by coordination with the organic radical (e.g. two atoms of nitrogen and four carboxyl groups, see Fig. 6.6). The six positions around the metal ( $\text{Fe}^{2+}$ ) give a high complexing capacity and low selectivity, as most of the di- and trivalent elements are able to enter this type of complex. The constants of stability,  $\log K$  at 20°C, are 13.8 for  $\text{Mn}^{2+}$ , 14.3 for  $\text{Fe}^{2+}$ , 16.1 for  $\text{Al}^{3+}$ , 25.1 for  $\text{Fe}^{3+}$ .

In an alkaline solution (pH 10), 1:1 complexes are formed with pedogenic elements. An excess of complexing reagent is needed for satisfactory control of the dissolution rate.

Depending on the pH, it may be possible to obtain  $\text{H}_4\text{Y}$ ,  $\text{H}_3\text{Y}^-$ ,  $\text{H}_2\text{Y}^{2-}$ ,  $\text{HY}^{3-}$  forms ( $\text{Y}^{4-}$  being the EDTA anion, see Fig. 6.6).

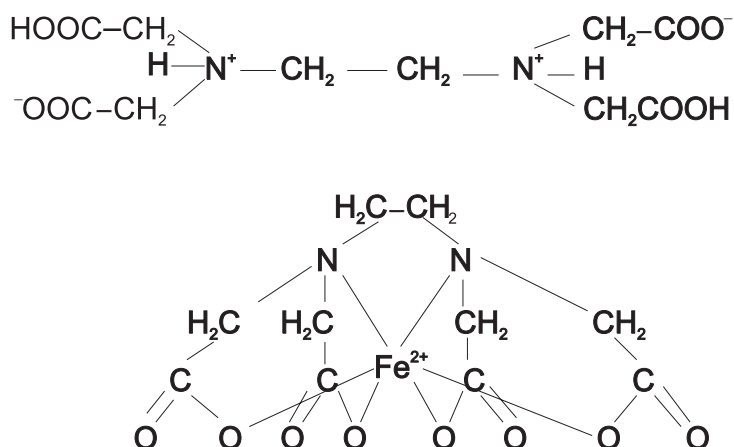

**Fig. 6.6.** Molecule of EDTA IV (*top*) and coordination complex with iron (*bottom*)

In the extraction continuum, the extractable forms of iron with EDTA appear to be linked with the most active forms in pedogenesis, i.e. with the “free” least crystalline compounds with extensive surface contact and thus great reactivity. Both exchangeable iron and organic chelated forms are solubilized because the pH of the reagent is high and the EDTA complexes are stable.

In agronomy, the availability of iron for plants (nutritional factor or possible chlorosis) is often checked using also two other complexing reagents (Lindsay-Norvell 1976): diethylene triaminopentaacetic acid (DTPA) or ethylene diamine di(o-hydroxyphenylacetic acid (EDDHA).

The correlation between EDTA- and oxalate-extractable iron is good: the ferrihydrite is dissolved by EDTA or by oxalate, but soils containing hydroxyferric complexes can react differently with these reagents (Jeanroy 1983). The time factor is significant. The extraction profile is slow and dissolution is continuous up to around 90 days, when it stabilizes.

The temperature is critical and attempts carried out to accelerate the reactions by raising the temperature to 75°C, as in the DCB method, resulted in unacceptable displacement of selectivity, some crystalline products becoming attackable and solubilizable.

The effect of pH was tested by Borggaard (1976). It cannot be below 7.5. A pH of 10, similar to that used in the pyrophosphate and tetraborate methods, makes it possible to compare the organic phases extracted using the above methods and eliminates the effect of pH. But selectivity is random for aluminium, which, at a pH of 8–9, gives soluble aluminates.

In EDTA, the concentration factor appears to have little influence on extraction, the kinetics of the reaction being controlled by hydrolysis. Intermittent agitation makes it possible to renew the reagent at the liquid–solid interfaces, thus avoiding the phenomena of local saturation. Clarification of the extracts is generally problem free.

### ***Preparation of the Reagents***

The initial procedure of Borggaard (1976) is a dynamic method. This author tested the effects of a concentration of the complexing reagent of between 0.01 and 0.1 M and a pH of between 7.5 and 10.5. This method is thus extremely long and cannot be adapted in its original form for repetitive analyses.

A concentration of 0.1 M of EDTA at a pH of 10 is used as standard. This enables comparisons with the reagents which extract organomineral complexes at the same pH, i.e. pyrophosphate at pH 9.6–10 and tetraborate at pH 9.7. Commercially available EDTA is often in the form of sodium salt and is sold under different names: Versenate, Sequestrene,



Titriplex II, Trilon B, etc. The empirical formula  $C_{10}H_{16}N_2O_8$  corresponds to a molar mass of 292.25 g.

Solution A: weigh approximately 29.225 g EDTA in 500 mL water.

Solution B: dissolve 20 g NaOH in 250 mL water.

Gradually mix B in A to bring the pH to 10.

Complete to 1 L with distilled water.

### **Procedure**

- On an analytical balance weigh precisely 2 g of soil ground to 0.2 mm in a 100 mL polypropylene or PTFE centrifuge tube.
- Add 50 mL of 0.1 M EDTA reagent.
- Stop the tube and agitate with the Vortex vibrator for 1 min.
- Place the samples on mobile plates that can be used on an oscillating agitator and store the series protected from the light for 90 days with daily agitation for 5 min.
- After 90 days of contact, centrifuge at 5,000 g for 5 min and filter.

The extracted elements (mostly Fe, Al, Si, and P) are analysed by plasma emission or atomic absorption spectrometry. When absorption spectrophotometry is used, the EDTA matrix has to be destroyed (cf. “Procedure” under “Acid Oxalate Method Under Darkness”). In each series, introduce two blanks with only reagents and a reference sample.

### **Calculations**

#### **Data collected:**

$A, B, D, f, P$  of the same type as in the preceding methods (cf. “Calculations” under section 6.2.1 and “Calculations” under “Dithionite - Citrate - Bicarbonate Method (DCB)” in this chapter).

$Contents\ Fe, Al, Mn, Si, P\ (\%) = 5\ (A-B)\ D/f/P$

These contents are expressed as per cent of oxides (cf. “Calculations” under section 6.2.1).

### **Remarks**

This method is one of the most reproducible and selective for amorphous iron and can also extract organometallic complexes if the pH exceeds nine. The extracted iron must be compared to the iron extracted by the oxalate reagent taking into account the fact that aluminous products dissolved at high pH can release iron for example resulting from isomorphic substitutions.

It is useful to compare the results with the extraction of active iron available to plants (using DTPA or EDDHA reagents) to link the results to the phenomenon of chlorosis and to proceed from pedogenic observations to the identification of agronomic properties of the soil–plant–climate relationships. From an agronomic point of view, the extraction of phosphorous by EDTA is also useful to identify the proportions of P linked to Fe or Al which form part of the pool of “available P”.

### 6.2.4 Pyrophosphate Method

#### *Principle*

This method is used to analyze the forms of iron and aluminium complexed with the soil organic matter, in particular to differentiate the spodic and podzolic horizons where displacement of these complexes can be observed.

Generally a good correlation can be obtained between extracted Al, Fe, and organic C. Well-crystallized iron oxides like goethite and hematite are not attacked and slightly ordered iron oxides are only slightly solubilized.

The original procedure recommended by Alexandrova (1960), and given permanent form by McKeague (1967), cannot be applied as it stands but has to be modified with regard to the clarification of the extracts.

The pyrophosphate anion  $P_2O_7^{4-}$  has chelating properties and can react with polyvalent cations to give insoluble compounds and soluble complexes with organic matter, for example:



But the complete mechanism of pyrophosphate action is not as clear as in the methods described earlier. The action of pyrophosphate has been questioned with regard to the organic forms of iron and aluminium: on one hand concerning the procedures and the reliability of the measurements, and on the other hand with regard to the mechanisms of extraction and the nature of the extracted products. Klamt (1985) mentioned “the denunciation of pyrophosphate extraction of Fe from soils (highly unreliable)”, indicating that an international consensus had not been reached.

---

*With regard to the procedures*

The time factor of 16 h is regarded as critical, particularly when the results of this method are compared with those obtained by EDTA extraction after a contact time of 90 days.

The pH, which was tested at different levels, is here fixed at 10.0 to enable comparison with the other extraction methods in basic solutions.

Pyrophosphate has chelating properties. Originally the choice between the use of sodium or potassium pyrophosphate was more or less random. K pyrophosphate extracts slightly more than Na pyrophosphate and makes spectrometric measurements easier by avoiding strong  $\text{Na}^+$  concentrations, which are always awkward. But with certain clays, potassium has serious disadvantages<sup>5</sup>. Na pyrophosphate is consequently considered to give the best reproducible extraction and it is now used at a concentration of 0.1 M (Loveland and Digby 1984).

At pH 10, pyrophosphate has peptizing properties which make the extracts very difficult to purify. Suspended particles are mainly responsible for the low rate of reproducibility and the lack of precision of the method, as the material in suspension is not chemically extractable by pyrophosphate. The efficiency of its centrifugation (speed and time of centrifugation) has been tested up to 100,000 g and compared to ultrafiltration. A flocculating agent must be added before centrifugation, usually sodium sulphate at concentrations ranging between 0.25 and 1 M (Schuppli et al. 1983) or superfloc cyanamid N-100 (or Floerger Kemfloc F 20 H). In this case the concentration is critical (Ballantyne et al. 1980). It is fixed at 0.2 mL superfloc for 50 mL of extract. Centrifugation at 20,000 g for 15 min results in clear extracts. Ultrafiltration with 0.02  $\mu\text{m}$  millipore filters can be used to eliminate any colloidal particles that may still be in suspension. In this case reproducibility is about 10–15%.

*With regard to the mechanisms of solubilization*

In the reaction between sodium pyrophosphate and soil, complexation cannot be the main mechanism, as iron linked to complex organic forms cannot be dissolved without solubilization of the amorphous forms of iron which are very reactive, as in the case of EDTA solubilization.

---

<sup>5</sup> For example the  $\text{K}^+$  ion is specifically adsorbed by vermiculite or deteriorated micas because its diameter is compatible with the size of the adsorption sites. The selectivity of  $\text{K}^+$  with respect to  $\text{Ca}^{2+}$  or  $\text{Mg}^{2+}$  is increased by the hydroxy aluminous polymer deposits on the interfoliaceus surfaces. In the presence of a strong concentration of P, and in certain conditions, K and aluminous oxides together can result in the formation of taranakite.

Compared to amorphous iron oxides, the iron pyrophosphate complex is not considered to be very stable at pH 10.

Bruckert (1979) considered that sodium pyrophosphate shifts the organic matter of its complexes of coordination with the metallic sites of clays (ferric bridges) and is adsorbed instead of the humic compounds which are solubilized at an alkaline pH. Metallic compounds with a high charge, such as amorphous hydroxides, can behave in a similar way. All the complexes extracted by pyrophosphate comprise the "immovable complexes".

Micro-aggregates are destroyed and clayey and colloidal cements are dispersed. Fulvic acid-amorphous iron hydroxides complexes are extracted along with the organic molecules in the coatings on clays.

Jeanroy (1981,1983) considered that dissolution induces a mechanism of peptization and solubilization. Adsorption of pyrophosphate on the soil particles increases the negative charges and increases their solubility in water. In contrast to EDTA, which has a flocculating effect, pyrophosphate puts ferruginous particles into suspension and these subsequently disperse in the extracts.

Separation on millipore filter shows that in EDTA extracts iron is linked to small molecules and thus passes through the membrane. On the other hand, the pyrophosphate extracts contain compounds of greater molecular size that do not pass through the membrane, as only a small proportion of the chelated fraction is able to do so. Similarly ultracentrifugation of the EDTA extract does not separate the phases, clearly demonstrating that iron is in soluble chelate form, whereas pyrophosphate results in a significant colloidal centrifugation pellet.

To summarize: with its peptizing action, pyrophosphate puts into suspension fine ferruginous particles, probably of ferric hydroxides, whose smoothness and small degree of atomic order are explained by the presence of organic matter which inhibits the crystallization of iron oxides. Bruckert's "immovable complexes" appear to be mainly hydroxyferric complexes that reveal the preponderance of the mineral.

From a practical point of view, pyrophosphate is effective only if the soil is under the influence of organic matter. In the opinion of Schuppli et al. (1983), the precipitation of iron in the pyrophosphate extracts could be due to the ageing of the extracts. Another dissolution mechanism could be the release by sodium pyrophosphate of small quantities of iron in the organic complexes, leaving these complexes negatively charged. They then become water soluble. The organic matter makes it possible to maintain quantities of iron in solution, but if the ratio reaches a certain level, precipitation will occur (Petersen 1976).

If this description of the solubilization mechanism is accurate, pyrophosphate extraction could be a selective dissolution technique, especially if uncertainties concerning the purification of the extracts are overcome. From a practical point of view, pyrophosphate extraction enables the behaviour of certain soils to be differentiated for the purpose of classification, though without identifying the precise origin of the extracted iron; however organic forms are considered to be the most probable.

### ***Preparation of the Reagents***

#### ***Extraction***

0.1 M sodium pyrophosphate: dissolve 44.6 g of  $\text{Na}_4\text{P}_2\text{O}_7 \cdot 10\text{H}_2\text{O}$  in distilled water and bring to 1 L; check the pH which must be 10.0.

#### ***Clarification***

Superfloc cyanamid N-100 (cyanamid Corp. Gosport, Hampshire, UK): dissolve 0.2 g of superfloc in 100 mL of water and agitate in darkness for 16 h with a PTFE magnetic bar stirrer, protect from the light in a brown bottle; a fresh solution should be made each week.

### ***Procedure***

With a laboratory precision balance, weigh one gram of soil (0.2 mm particle size) in a 250 mL polyethylene tube (with screw stopper). Add 100 mL of 0.1 M sodium pyrophosphate reagent and agitate for 16 h at ambient temperature (20°C).

Add 0.2 mL of superfloc and homogenize on a rotary shaker for 10 min, then centrifuge at 20,000 g. With a millipore filter syringe remove from the quantities of supernatant needed to analyze the required elements (mostly Fe, Al, Si, and C). Add two blanks (with only reagents) and two reference samples in each series.

Measure the concentrations of Al, Fe, Si by plasma emission or atomic absorption spectrometry (cf. Chap. 31) with standards diluted in the extraction matrix. For measurements by absorption spectrophotometry, destroy the pyrophosphate matrix before measurement (cf. "Procedure" under "Acid Oxalate Method under Darkness").

### ***Calculations***

#### ***Data collected:***

*A, B, D, P, f* as in other methods (cf. "Calculations" under Sect. 6.2.1).

$\% \text{ contents (Fe, Al, Si)} = 10 (A-B) Df/P$

The results can be expressed in oxides (cf. "Calculations" under Sect. 6.2.1).

### **Remarks**

The method is well suited for differentiation of podzolic B horizons. The conditions governing centrifugation and clarification must be as homogeneous as possible, and the speed and time of centrifugation should be rigorously respected. If the series has to be stored before measurement by spectrography, store protected from the light in the refrigerator at 6–8°C.

The percentages of extracted organic carbon are often measured on automated CHN apparatuses (cf. Chap. 10) at the same time as Fe, Al and Si are measured using spectrographic techniques (cf. Chap. 31). Series of extractions whose action is due to a gradual increase in the pH of the medium are often used. These differential extractions make it possible to characterize increasingly resistant forms:

- A preliminary extraction using 0.1 M sodium tetraborate buffered at pH 9.7<sup>6</sup> enables the electrostatic linkages to be broken by simple exchange. The adsorbed organic molecules of low molecular weight are extracted. They contain complexed iron and aluminium that comprise the recently insolubilised "mobilizable complexes". The soil aggregates are not destroyed (Bruckert 1970, 1974, 1979).
- The 0.1 M pyrophosphate method at pH 10 then makes it possible to break the coordination linkages with the hydroxides and oxides in the coating on clays.
- Lastly, the 0.1 M sodium hydroxide method at pH  $\geq 12$  (cf. Sect. 6.2.5) enables the organo-mineral linkages to be destroyed, even those of the allophane-humic acid complexes.

<sup>6</sup> Preparation of reagent: 0.1 N sodium tetraborate pH = 9.7: dissolve 21 g of Na<sub>2</sub>B<sub>4</sub>O<sub>7</sub>·10H<sub>2</sub>O in approximately 900 mL of water; add 1.8 g of sodium hydroxide pellets; homogenize; check the pH which must be 9.7; bring to 1 L with deionised water.

Extraction: 1 g of soil ground to 0.2 mm + 100 mL of 0.1 N sodium tetraborate solution; stir for 1 h; centrifuge at 20,000 g and continue as for pyrophosphate extracts (Al, Si, Fe, C, etc.).

## 6.2.5 Extraction in strongly alkaline mediums

### *Principle*

Methods using soda and sodium carbonate reagents are based on:

- Dissolution in strongly alkaline medium of some silicon, aluminium, and aluminosilicate compounds; these can form soluble silicates and aluminates according to the simplified reaction:

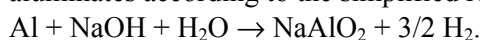

- concentration in the residue of insoluble compounds, and especially of iron and manganese.

An attack using boiling 0.5 M sodium hydroxide solution for 2 min 30 s solubilizes organic forms of aluminium and silicon, hydrated non-crystalline and crystalline (gibbsite) aluminium oxides, opaline silica and diatoms, and finally amorphous or crypto-crystalline aluminosilicates like allophane and imogolite ( $\text{SiO}_2:\text{Al}_2\text{O}_3$  ratio = 1.5–2.3). Some 1:1 silicates are attacked and partially dissolved. Iron compounds are not extracted.

An attack using 0.5 M sodium carbonate for 16 h at 20°C (Follet et al. 1965) has a more mitigated action and makes it possible to solubilize the organic and non-crystalline aluminium compounds as well as a certain proportion of gibbsite. Very finely divided siliceous compounds and opaline silica can be partially dissolved, amorphous aluminosilicates are solubilized, but allophane and imogolite are not completely solubilized. Phyllosilicates and iron compounds are not attacked.

The iron compounds untouched by these two treatments can be studied in this enriched residue. But a more vigorous method with 5 M NaOH solutions and boiling for 2 h makes it possible to dissolve the majority of 1:1 clays and clay minerals present and thus ensure a higher concentration. Despite this treatment, some minerals such as quartz, anatase, rutile, cristobalite, and some 2:1 clays may still be present in the residue.

The action of the reagents mainly depends on the dispersion of the particles, the state of division of the silicon and aluminium substances, the crystallinity and reactivity of the surfaces of ordered or X-ray amorphous compounds.

Extraction in a 0.5 M NaOH medium with a limited period of boiling enables differential solubilization of aluminium and silicon compounds as well as of organic matter with high reactive surface, whereas well-crystallized compounds are spared as their solubilization requires a much longer period of boiling.

The solubility of aluminium hydroxides is amplified by an initial hydrolysis mechanism of the monomeric forms of aluminium (at low

concentrations):  $\text{AlOH}^{2+}$ ,  $\text{Al}(\text{OH})_2^+$ ,  $\text{Al}(\text{OH})_3$ ,  $\text{Al}(\text{OH})_4^-$ , the latter existing only in an alkaline medium according to the reaction:

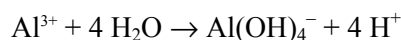

Aluminium is in tetrahedral coordination. At higher concentrations, the polymeric forms gradually take the form of  $[\text{Al}_6(\text{OH})_{12}(\text{H}_2\text{O})_{12}]^{6+}$  units.

In addition, all the acid groups of organic macromolecules (humic and fulvic acids) are dissociated, and the polar and anion sites are easily solvated. Under these operating conditions, most of the organomineral bonds are broken, even the very resistant ones between allophanic-Al and humic acid of Andosols. The poorly ordered aluminium and silicon compounds or their organic and inorganic derivatives pass in solution in aluminate or silicate form.

Dissolution in sodium hydroxide solution can result in an oxidative medium by breaking down some humic acid forms in the presence of oxygen, which modifies the  $\text{Fe}^{2+}:\text{Fe}^{3+}$  ratios in the residues. Operating in nitrogen atmosphere can mitigate this phenomenon and also minimize the carbonation of sodium hydroxide by atmospheric  $\text{CO}_2$ .

Finally, in addition to the above processes, the strongly dispersing action of sodium hydroxide on the phyllosilicates also has to be considered. The elementary components of the stable micro-aggregates maintained in place by Fe, Al, Si oxide coating are first released by the dissolution process and then dispersed thereby increasing the action of the reagent at the solid-liquid interfaces. The alkaline character of the surfaces of the oxide decreases according to the series:

	Amorphous	> $\gamma$ -	> $\alpha$ -	> $\gamma$ -	> $\gamma$ -
	hydrated Al	$\text{AlO}(\text{OH})$	$\text{Al}(\text{OH})_3$	$\text{Al}(\text{OH})_3$	$\text{Al}_2\text{O}_3$
	oxides	boehmite	bayerite	gibbsite	
pH at	9.45	9.40	9.20		8.00
isoelectric					
point					

In addition to sodium hydroxide and carbonate, and sodium or potassium pyrophosphate, other reagents that have been used to extract the organic matter and organomineral complexes are: ethylene diamine (EDA), NN-dimethylformamide, sulfolane, pyridine, dimethyl sulfoxide, etc.



**Reagents**

The three mostly widely used reagents are described here as they correlate well with other selective extraction methods and characterize the resistance to the dissolution of the aluminous or siliceous products satisfactorily. Many alternatives have been proposed whose relative effectiveness (but not the degree of selectivity) is roughly classified in Table 3. Potassium hydroxide solutions are sometimes used instead of sodium hydroxide.

**Table 6.3.** Strongly alkaline reagents classified in order of decreasing efficiency

5 mol (NaOH) L <sup>-1</sup> pH ≥ 14	> 0.5 mol (NaOH) L <sup>-1</sup> pH > 12	≥ 1.25 mol (NaOH) L <sup>-1</sup>	> 0.5 mol (Na <sub>2</sub> CO <sub>3</sub> ) L <sup>-1</sup> pH 10.7	> 0.5 mol (Na <sub>2</sub> CO <sub>3</sub> )L <sup>-1</sup> pH 10.7	> 0.1 mol (NaOH) L <sup>-1</sup>
boiling	boiling	80°C	boiling	20°C	20°C
2 h	2.5 min	20 min (or shorter)	1 h (or variable times)	16 h	
iron enrichment	selective extraction of free oxides allophane imogolite	eliminates gibbsite and free oxides	eliminates inter-particle cements, solubilizes 1:1 minerals	selective extraction of allophane imogolite	clay dispersion
Norrish and Taylor (1961)	Hashimoto and Jackson (1960)			Follet et al. (1965)	

**Preparation**

– 5 mol (NaOH) L<sup>-1</sup> solution: carefully dissolve 200 g of analytical grade sodium hydroxide pellets in 1 L of distilled water previously boiled to eliminate carbon dioxide. Leave to cool with no contact with air and store in a polythene bottle. Prepare fresh solution every week.

- 0.5 mol (NaOH) L<sup>-1</sup> solution: dissolve 20 g of sodium hydroxide pellets in 1 L of previously boiled distilled water. Store in a polythene bottle. This reagent should be freshly prepared every day.
- 0.5 mol (Na<sub>2</sub>CO<sub>3</sub>) L<sup>-1</sup> solution: dissolve 53 g of anhydrous Na<sub>2</sub>CO<sub>3</sub> in 1 L of distilled water and store in a polythene bottle.
- 0.5 mol (HCl) L<sup>-1</sup>: take 42 mL of HCl  $d = 1.19$  and bring to 1 L.

### **Procedures**

#### ***Selective dissolution with 0.5 M Na<sub>2</sub>CO<sub>3</sub> at 20°C***

(Follet et al. 1965):

- Weigh 100 mg of soil sample ground to 0.2 mm and place in a 100 mL centrifuge tube.
- Add 80 mL of 0.5 M Na<sub>2</sub>CO<sub>3</sub> solution; close the tube and shake for 16 h with a rotary shaker.
- Centrifuge at 5,000 g for 10 min.
- Transfer the supernatant in a 200 mL volumetric flask.
- Wash the centrifugation pellet with distilled water and recentrifuge.
- Add to the previous extract and bring to 200 mL with deionised water.
- Carry out spectrometric measurements on the extract without delay using atomic absorption or inductively coupled plasma emission (Si and Al).

#### ***Selective dissolution with boiling 0.5 M NaOH***

(Hashimoto and Jackson 1960):

- Weigh 100 mg of soil sample ground to 0.2 mm (or use the residue of a DCB extraction) in a 250 mL nickel or PTFE crucible.
- Add 100 mL of 0.5 M NaOH boiling solution and homogenize.
- Maintain boiling for 2 min 30 s.
- Rapidly cool and transfer in a 250 mL polythene centrifuge tube and centrifuge for 10 min at 5,000 g
- Transfer the supernatant in a 500 mL volumetric flask.
- Wash the centrifugation pellet with distilled water, recentrifuge, and add the rinsing solution in the volumetric flask.
- Adjust to volume with distilled water and measure Si and Al without delay using atomic absorption spectrometry or plasma emission spectrometry.

***Dissolution with boiling 5 M NaOH (2 h)***

(Norris and Taylor 1961):

- Weigh 100 mg of sample ground to 0.2 mm (or use the residue of other selective extractions) in a stainless steel or PTFE beaker.
- Add 100 mL of 5 mol (NaOH) L<sup>-1</sup> solution.
- Boil for 2 h.
- Cool and centrifuge at 5,000 g for 10 min.
- Decant the supernatant (which can be discarded or analysed).
- Wash the centrifugation pellets with a little water, then wash three times with 0.5 mol (HCl) L<sup>-1</sup> solution to dissolve the resulting sodalite and to eliminate sodium chloride, then wash again with water until negative reaction of chlorides.

Dry the sample ready for the analysis of manganese and iron oxides. check the absence of kaolinite and sodalite by XRD.

***Calculations***

All the results are expressed in oxides (cf. “Calculations” under Sect. 6.2.1).

***Remarks***

The NaOH:Al ratio influences the development of aluminium hydroxides (Hsu 1977). It is thus important to standardize the procedures during the Al precipitation. Studies of <sup>27</sup>Al by nuclear magnetic resonance show that, for a given concentration and pH, the nature of the gel gradually changes with ageing (Hsu 1984). These modifications, which occur in the natural environment, also occur in the synthetic mediums though at a different scale (Stol et al. 1976). NMR spectrometry is a particularly powerful tool to differentiate suspended or dissolved polynuclear species. Sometimes the modifications observed can explain such apparently induced variations by separation techniques such as centrifugation, ultrafiltration, or dialysis. Consequently it is better to carry out spectrometric measurements on products that have been recently extracted by different methods.

For the 5 mol (NaOH) L<sup>-1</sup> reagent, Kampf and Schwertmann (1982) recommend the boiling extraction method and in the presence of gibbsite to modify the reagent which must contain 0.2 mol (silica) L<sup>-1</sup> in order to minimize phase changes and a possible increase in crystallinity, and to inhibit dissolution and recrystallization of substituted aluminium in goethites. Ferrihydrite, which can be converted into hematite and/or goethite, remains almost intact. However, the increase in the silica content results in more abundant precipitation of sodium and aluminium

silicate (sodalite) which must be eliminated from the residue by several washings with 0.5 mol (HCl) L<sup>-1</sup> solution.

The method of concentration with 5 mol (NaOH) L<sup>-1</sup> makes it possible to identify manganese oxides in the residue more clearly. These oxides are generally found at low concentrations and display weak crystallinity in soils. Birnessite and lithiophorite are found with iron oxides. Birnessite can be dissolved in hydroxylamine chloride as goethite and lithiophorite are not affected by this treatment. A final attack using the DCB method makes it possible to dissolve the goethite (Shuman 1982; Tokashiki et al. 1986).

In the method based on boiling soda for 2 min 30 (cf. "Selective dissolution with boiling 0.5 M NaOH"), time is critical and must be carefully respected to avoid excessive solubilization of kaolinite and halloysite which can gradually pass in solution. The chlorites and montmorillonites, which were previously heated to 500°C, are not much affected. Spectrometric measurements should be made rapidly after extraction to avoid ageing of the extracts and precipitation of aluminosilicate.

A large volume of solution compared to the weight of soil sample should be used to avoid the saturation of the extracts by aluminium and silicium. To avoid contamination, only PTFE, stainless steel, or nickel laboratory equipment is recommended. Pyrex glass can cause pollution by Si, Al, Fe.

Dissolution of the gibbsite can be corrected if it is measured by DTA (cf. Chap. 7).

Dissolution with 0.5 mol (NaOH) L<sup>-1</sup> solution at boiling point does not enable very fine differentiation between amorphous and crystalline products because of the sensitivity of poorly ordered 1:1 clays and gibbsite. However, correlation with the oxalate method is generally good.

## 6.3 Other Methods, Improvements and Choices

### 6.3.1 Differential Sequential Methods

#### *Principle*

Many methods have been developed. When used in sequence, the methods described in Sect. 6.2 earlier can be considered as sequential multi-reagent methods.

The Ségalen (1968) method uses an alternating process of hydrolysis and protonation in cold acid medium (without complexation or reduction) to solubilize some iron and aluminium compounds, then a treatment in hot alkaline medium (80°C) to solubilize the aluminium and silica compounds (cf. Sect. 6.2.5 earlier). These treatments are alternated several times to establish cumulative curves of quantity vs time (Fig. 6.7).

Fractionation expresses the differences in the solubility of compounds in these mediums<sup>7</sup>. Solubilization kinetics and hydrolysis constants depend on (1) the type, nature and concentration of the reagents, the soil/solution ratio and temperature and (2) nature and size of the sample, its elementary particle content, the degree of crystallinity and the extent of specific surface of clay minerals, the molecular arrangements and the degree of substitutions.

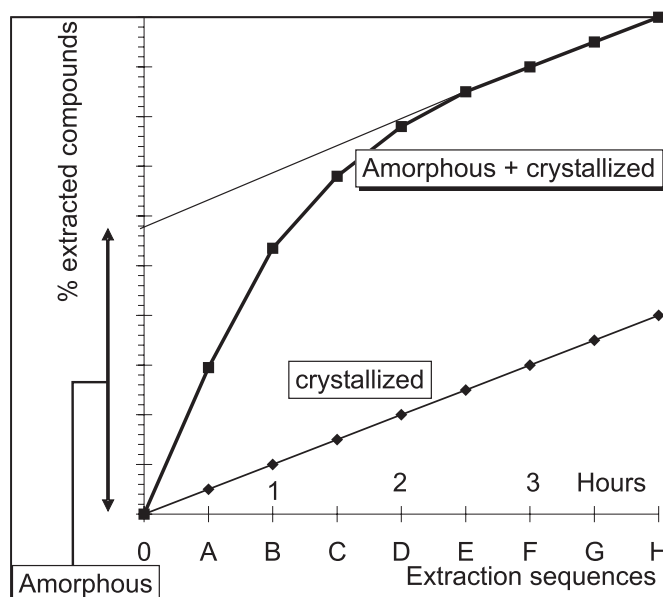

Fig. 6.7. Cumulative curve of extraction

The cumulative curve of the extracted compounds integrates these parameters (1) the lower part of the curve shows a parabolic segment that rises to a greater or lesser extent depending on the soil types which correspond mainly to the rapid dissolution of non-crystalline products

<sup>7</sup> For example the dissolution kinetics of the iron forms in 0.5 mol (HCl) L<sup>-1</sup> solution at 25°C (Shidhu et al. 1981) follows the series: (ferrihydrite, ferroxhite > lepidocrocite > magnetite > akaganeite > maghemite > hematite > goethite).

with a very high specific surface area (Fig. 6.7); the kinetics of dissolution shows that a fraction of very fine crystalline products can also pass in solution in the same time interval; (2) the rectilinear upper segment has a weak slope indicating the weak dissolution of the well-crystallized and chemically not very reactive products.

A gradual change in the slope may indicate the end of dissolution of the very fine crystalline particles, or on the contrary, the appearance of practically non-ordered zones of preferential dissolution. Extrapolation of the upper segment at the intersection with the  $y$ -coordinate provides an estimate of the percent of amorphous substances.

### **Reagents**

The reagents recommended by Ségalen (1968) for the acid attack are 2, 4, and 8 mol (HCl) L<sup>-1</sup> hydrochloric acid solutions (the last concentration was finally retained) and for the alkaline treatment, boiling for 5 min with 0.5 mol (NaOH) L<sup>-1</sup> solution. The extraction sequence comprises 8 alternating acid-alkaline treatments:

- 8 mol (HCl) L<sup>-1</sup>: in a 1 L volumetric flask, add 830 mL of reagent grade hydrochloric acid to about 100 mL distilled water, agitate, leave to cool and bring to 1 L; alternatively if 6, 4, 2, or 0.5 mol (HCl) L<sup>-1</sup> solutions are used, add respectively, 623, 415, 208, or 52 mL hydrochloric acid in the 1 L flask.
- 0.5 mol (NaOH) L<sup>-1</sup>: add 20 g of NaOH pellets in a 1 L volumetric flask, dissolve in distilled water and bring to 1 L.

The proposed modifications of this method concern the temperature (from ambient to boiling), the duration of contact and finally the use of only one reagent (2 mol (HCl) L<sup>-1</sup>) without alternating with NaOH.

### **Procedure**

(Ségalen 1968):

- Weigh 500 mg of soil (ground to 0.2 mm) in a 100 mL polyethylene centrifuge tube.
- Add 50 mL of 8 mol (HCl) L<sup>-1</sup> solution, homogenize and leave in contact for 30 min at room temperature.
- Centrifuge at 5,000 g for 10 min.
- Transfer the supernatant in a 100 mL volumetric flask.
- Add 45 mL of deionised water, resuspend the centrifugation pellet by Vortex agitation.
- Centrifuge at 5,000 g and add the washing water in the volumetric flask.

- Complete to 100 mL; this is extract A (acid) for the measurement of iron, aluminium, and silicon.
  - Add 50 mL of NaOH 0.5 mol L<sup>-1</sup> solution in the centrifuge tube and resuspend.
  - Place in the boiling water bath for 5 min.
  - Centrifuge at 5,000 g for 10 min.
  - Collect the supernatant in a 100 mL volumetric flask.
  - Wash the residue with 45 mL distilled water and add the washing water to the extract; complete to 100 mL; this is extract B (alkaline) for the measurement of alumina and silica.
- Repeat the double extraction process eight times.

### **Calculations**

All the results obtained by atomic absorption or inductively-coupled plasma emission spectrometry are expressed in per cent of oxides (cf. “Calculation” in Sect. 6.2.1).

For alumina and silica, the results obtained on extracts A and B must be added. For iron, the acid solution is used alone. Cumulative curves of iron, alumina, and silica are established (Fig. 6.7); the tangent to the right of the curve gives the percentage of amorphous compounds.

### **Remarks**

The procedure using the above concentrations (alternating 8 mol (HCl) L<sup>-1</sup> and 0.5 mol (NaOH) L<sup>-1</sup> with 5 min boiling), was found to be too energetic and insufficiently selective for many pedological situations and many minerals as the amorphous substances were often over-estimated. This method thus needs to be adapted to the type of soil being analysed. The original unmodified method dissolves amorphous iron and complexed iron, but if the use of very aggressive reagents results in the rapid dissolution of the amorphous substances, it also solubilizes crystallized products: 1:1 clays, mica, chlorite, biotite, hornblende, nontronite, gibbsite, etc. (Colmet-Daage et al. 1973; Quantin and Lamouroux 1974; Quantin et al. 1975; Yong et al. 1979; Bentley et al. 1978, 1980; Quigley et al. 1980, 1985; Torrance et al. 1986).

The degree of selectivity may be insufficient for certain soils and amorphous substances will be considerably over-estimated. On their own, the kinetics curves do not show which forms are truly solubilized.

The kinetics of dissolution is significantly correlated with the concentration of the reagents, and to time and temperature. Modifying these parameters can significantly change the dissolution kinetics and selectivity. The results always have to be linked with a precise procedure.

As is true for all the other methods, an excess of reagent is necessary to avoid the effects of saturation. This method is not really suitable for repetitive analysis without robotization because of the length of the successive extractions. Six double extractions can be carried out each day on a small series.

The study of goethite dissolution (Cornell et al. 1974, 1975, 1976; Schwertmann et al. 1985) in 0.5 mol (HCl) L<sup>-1</sup> at 20 and 60°C using transmission electron microscopy (TEM) shows that preferential zones of dissolution create new surfaces that can give sigmoid curves of dissolution vs time. This mechanism of dissolution is related to the structure of the molecular configurations. The kinetics of dissolution of goethite is slowed down by a strong Al<sup>3+</sup> substitution. These studies highlight the changes in the concepts of dissolution and of “amorphous” substances as well as the need to check the size and the state of surfaces of minerals using SEM and XPS microscopy.

### 6.3.2 Selective Methods for Amorphous Products

Many other methods are used for the description of amorphous substances, in particular the release of hydroxyls by fluorides and trimethylsilylation.

#### ***Release of Hydroxyls by Fluorides***

This method is based on the general reaction:

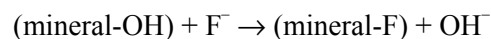

which satisfactorily accounts for the reactivity of the crypto-crystalline components, aluminosilicates like allophane or imogolite, or amorphous aluminium forms, the reactions being very rapid.

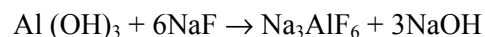

The above reaction made it possible to develop a NaF field test for andosols. The total released OH<sup>-</sup> correlates well with the amorphous forms of Al and Si, with a weak influence of Fe. Quantification is performed by titration at constant pH:

- Put 25 mg of soil ground to 0.2 mm in contact with 0.85 mol (NaF) L<sup>-1</sup> solution solution at pH 6.8 and at 25°C;



– Using a titrimeter, maintain the pH at 6.8 for 30 min by adding a titrated acid solution. The quantity of acid required for neutralization provides an estimate of the non-crystalline substances.

The reaction can be performed stoichiometrically only in the absence of organic matter and carbonates. The crystalline substances are not sufficiently reactive to react significantly in such a short period of time.

### **Trimethylsilylation**

This method is specifically used for silica compounds; it is derived from organic chemistry and is based on the reaction of the silicic acid with organo-silicic compounds which produce stable and volatile organosilyl derivatives that can be separated and identified by gas chromatography. The basic reaction can be written briefly:

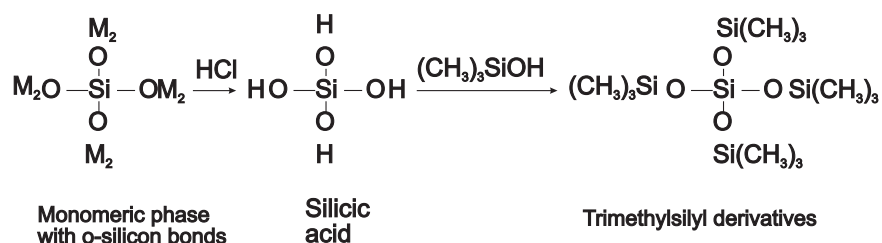

This reaction makes it possible to determine the degree of polymerization of silica and to link it to different types of deterioration. Inorganic gels that are rich in aluminium are particularly reactive. Crystalline substances are not very active.

Place 50 mg of soil sample in contact with 9 mL of hexamethyl disiloxane (HMDS)<sup>8</sup> at 4°C in 0.2 mL of water and an internal standard (n-Eicosane, CH<sub>3</sub>(CH<sub>2</sub>)<sub>18</sub>CH<sub>3</sub>). After homogenisation, add 2 mL trimethylchlorosilane (TMCS)<sup>8</sup> at 4°C. The hydrolysis releases hydrochloric acid which reacts with the soil amorphous silicates by exchange of cations and protonation. Leave in contact for 16 h at 4°C. The silicic acid forms trimethylsilyl derivatives.

<sup>8</sup> TMCS, Trimethylchlorosilane (CH<sub>3</sub>)<sub>3</sub>SiCl; HMDS, Hexamethyldisiloxane (CH<sub>3</sub>)<sub>3</sub>Si-O-Si(CH<sub>3</sub>)<sub>3</sub>.

**Table 6.4.** Approximate balance of soil mineral phases from different extractions

Fe forms	symbol	description	Al, Si, Mn, and others
total iron	Fe(T)	<p>– analysis essential for the establishment of geochemical and mineralogical balances and characteristic ratios</p> <p>– the method of attack by boiling HCl is insufficient for satisfactory quantification. An alkaline fusion should be carried out. Minerals such as pyrites, marcasite, and magnetite are difficult to mineralize.</p> <p><u>ratios</u> Fe(T)/Clays Fe(CBD)/Fe(T) are indices of weathering of the horizons. Degree of evolution of hydromorphic soils.</p>	
free iron	Fe(f) = Fe(DCB)	<p>iron extractable by DCB reagent (cf. Sect. 6.2.2): iron mobilizable in pedogenetic processes. This iron is of pedological interest since it is not linked with the structure of the silicate lattices (clays, primary minerals) that presents different hydroxylated and hydrated forms with a varying degree of crystallinity.</p> <p><u>ratios</u> Fe(f)/Clays, Fe(oxda)/Fe(DCB) indicate the degree of weathering and crystallinity of free oxides and concretions. Fe(DCB)/Fe(T) is the index of deterioration and mobility of iron in a profile. Fe(DCB)–Fe(oxda)</p>	<p>total free Al (exchange acidity, exchangeable Al<sup>3+</sup>, ECEC, etc.), marker of deterioration (acidolyse, complexolyse)</p> <p>free Mn</p>
crystalline free iron			
iron in silicates	Fe(sil)	<p>Fe(T)–Fe(DCB) the iron in silicates originating from primary minerals and the lattices of phyllic minerals; a reduction indicates progression in deterioration (cambic horizon)</p>	

not well-crystallized iron oxides	Fe(OA)	Fe(oxda)–Fe(EDTA)	
well-crystallized iron oxides	Fe(OC)	Fe(DCB)–Fe(oxda) the well-crystallized iron oxides are identifiable using instrumental techniques (XRD, DTA, etc.). These oxides are inherited or newly formed. The presence of lepidocrocite and magnetite which are sensitive to the oxalate treatment may affect the results. Magnetite is inherited and is not formed during pedogenesis.	
iron in amorphous forms and organic complexes	Fe(pyro)	immovable complex	<u>Al(tetra)/Al(Pyro)</u> decreases with ageing of the gel (soluble aluminates in alkaline medium)
complexed iron	Fe(tetra)	mobile or mobilizable complex. Method used in sequence with reagents of increasing efficiency: Tetraborate pH 9.7 < pyrophosphate pH 9.8 < NaOH pH 12 – Fe(tetra):Fe(pyro) characterizes the degree of evolution of complex Fe-organic matter, if Fe(tetra) decreases and Fe(pyro) increases there is pedogenesis with strong biological deterioration.	
	Fe(oxda)	iron extracted by oxalate in darkness (cf. Sect. 6.2.1 above), if Fe(oxob), Fe(EDTA), Fe(pyro) are weak there is weak deterioration	

Add 2 mL H<sub>2</sub>O to hydrolize the excess of TMCS. Centrifuge to separate solid and liquid phases and transfer the organic solution on 1 g cation exchange resin (Amberlite 15). After 5 h of contact and filtration,

separate the extract and quantify the trimethylsilyl derivatives by gas chromatography with nitrogen as carrier gas.

### 6.3.3 Brief overview of the use of the differential methods

There are many publications concerning each method of extraction making it possible to find examples of the use of all the methods, either alone or in comparison with other methods, e.g. Aomine and Jackson (1959), Bruckert (1979), Jeanroy (1983), Baize (1988), Krasnodebska-Ostrega et al. (2001).

The final objective may simply be the elimination of substances (e.g. cementing agents) that obstruct dispersion or instrumental observation (e.g. XRD or IR spectra). In this case, it is not essential to identify the soluble products; on the contrary, to understand the mechanisms of mineralogical and pedogenic evolution both the soluble phases and the solid phases have to be taken into account. Comparisons should be made of results expressed in per cent of oxides; this is a practical way to homogeneously quantify the mineralogical phases but does not correspond to the chemical forms actually present in the soil.

The combination of several methods makes it possible to establish an approximate balance of the different aluminium and iron forms in the soil (Table 6.4). Isolated entities are often not sufficiently specific and results are somewhat empirical, but give a precise enough view of the weathering phenomena. In general, variations in extracted contents of a given element (initially iron, then aluminium, silica, and manganese) are compared on the same sample first by total analysis and then by selective analyses (free forms, amorphous forms, etc.). Next, variations between horizons of a soil profile and finally variations between profiles can be compared. Correlations with size and behaviour of components can be highlighted. Iron is the main element used as a tracer of deterioration. It is insoluble in the ferric oxidation state and a loss generally indicates a pedogenic process of reduction, also indicated by the colour of the soil. The processes of biochemical humification result in the formation of iron-organic complexes.

In andosols, Al and Si, components of allophane and imogolite (Fig. 6.1), are measured first. In these soils, allophanic materials can sometimes be estimated indirectly, for example by the measurement of the cation exchange capacity on a sample from which the organic matter has previously been eliminated; one part of the sample is treated with a

sodium carbonate solution for 60 min, and another part with a boiling sodium acetate solution for 15 min, and the result will be a difference in cation exchange capacity that correlates well with allophane content (Aomine and Jackson 1959).

An instrumental technique, differential diffractometry, makes it possible to evaluate the action of the dissolution reagents and the behaviour of soil materials. Several diffraction spectra of a sample are made before and after treatment by selective dissolution. An appropriate computer program can be used to calculate the difference between the spectrum of the treated sample and the spectrum of the untreated sample. Quartz or  $\alpha$ -alumina is used as an internal standard to calculate the scale factor for the subtraction of the spectra. This enables the spectrum of the dissolved substances to be reconstructed during selective treatment (Campbell and Schwertmann 1985).

## References

- Alexsandrova LN (1960) The use of pyrophosphate for isolating free humic substances and their organic-mineral compounds from the soil. *Soviet Soil Sci.*, 190–197
- Aomine S and Jackson ML (1959) Allophane determination in ando soils by cation exchange delta value. *Soil Sci. Soc. Am. Proc.*, 23, 210–214
- Atkinson RR, Posner AM and Quirk J (1968) Crystal nucleation in Fe (III) solutions and hydroxyde gels. *J. Inorg. Nucl. Chem.*, 30, 2371–2381
- Avery BW and Bascomb CL (1982) *Soil Survey Laboratory Methods.*, Soil Survey of England-Wales (Harpending), 6
- Baize D (1988) *Guide Des Analyses Courantes En Pédologie: Choix - Expression - Présentation - Interprétation.*, INRA, 172 pages
- Ballantyne AKD, Anderson DW and Stonehouse HB (1980) Problems associated with extracting Fe and Al from saskatchewan soils by pyrophosphate and low speed centrifugation. *Can. J. Soil Sci.*, 60, 141–143
- Bentley SP, Clark NJ and Smalley IJ (1980) Mineralogy of a Norwegian postglacial clay and some geotechnical implications. *Can. Miner.*, 18, 535–547
- Borggaard OK (1976) Selective extraction of amorphous iron oxide by EDTA from a mixture of amorphous iron oxide, goethite and hematite. *J. Soil Sci.*, 27, 478–486

- Bruckert S (1979) Analyse des complexes organo-minéraux des sols. In *Pédologie 2, constituants et propriétés du sol*, Bonneau M. and Souchier B. ed. Mason, IX, 187–209
- Cambier P and Sposito G (1991) Adsorption of citric acid by synthetic pseudoboehmite. *Clays Clay Miner.*, 39, 369–374
- Campbell AS and Schwertmann U (1985) Evaluation of selective dissolution extractants in soil chemistry and mineralogy by differential X-Ray diffraction. *Clay Miner.*, 20, 515–519
- Colmet-Daage F, Gautheyrou J, Gautheyrou M and De Kimpe C (1973) Etude des sols à allophane dérivés de matériaux volcaniques des Antilles et d'Amérique latine à l'aide de techniques de dissolution différentielle. Ière partie. Etude des produits solubilisés. *Cah. ORSTOM série Pédol.*, XI, 97–120
- Cornell RA, Posner AM and Quirck J.P (1976) Kinetics and mechanisms of the acid dissolution of goethite ( $\alpha$ -Fe OOH). *J. Inorg. Nucl. Chem.*, 38, 563–567
- Cornell RM and Schindler PW (1987) Photochemical dissolution of goethite in acid/oxalate solution. *Clays and clay Miner.*, 35, 347–352
- Cornell RM, Posner AM and Quirck J.P (1974) Crystal morphology and the dissolution of goethite. *J. Inorg. Nucl. Chem.*, 36, 1937–1946
- Cornell R.M., Posner A.M and Quirk JP (1975) The complete dissolution of goethite. *J. Appl. Chem. Biotechnol.*, 25, 701–706
- De Endredy AS (1963) Estimation of free iron oxides in soils and clays by a photolytic method. *Clay Miner. Bull.*, 29, 209–217
- Deb BC (1950) The estimation of free iron oxides in soils and clays and their removal. *J. Soil Sci.*, 1, 212–220
- Duchaufour Ph and Souchier B (1966) Note sur une méthode d'extraction combinée de l'Aluminium et du fer libres dans les sols. *Sci. du Sol*, 1, 17–29
- Farmer VC and Fraser AR (1978) Synthetic imogolite, a tubular hydroxy-aluminium silicate. In *International Clay Conference.*, Elsevier, Amsterdam, 547–553
- Farmer VC, Fraser AR and Tait JM (1979) Characterization of the chemical structures of natural and synthetic aluminosilicate gels and soils by infrared spectroscopy. *Geochim. Cosmochim. Acta*, 43, 1417–1420
- Follett EAC, McHardy WJ, Mitchell BD and Smith BFL (1965) Chemical dissolution techniques in the study of soil clays. *Clay Miner.*, 6, 23–43
- Franzmeier DP, Hajek BF and Simonson C.H (1965) Use of amorphous material to identify spodic horizons. *Soil Sci. Soc. Am.Proc.*, 29, 737–743
- Hashimoto I and Jackson ML (1960) Rapid dissolution of allophane and kaolinite and halloysite after dehydration. *Clays clay Miner.*, 7, 102–113
- Henry S (1958) Synthèse de quelques oxydes de fer au laboratoire. *C.R. du XXXI Congrès intern. de Chimie Industrielle (Liège).*, Mercurius, 1–3
- Hetier JM and Jeanroy E (1973) Solubilisation différentielle du fer, de la silice et de l'alumine par le réactif oxalate-dithionite et la soude diluée. *Pédologie*, 23, 85–99

- Holmgren GGS (1967) A rapid citrate-dithionite extractable procedure. *Soil Sci. Soc. Am. Proc.*, 31, 210–211
- Hsu PH (1977) Aluminium hydroxydes and oxyhydroxyde. In *Minerals in Soil Environments*, Dixon JB Weed SB and ed., *Soil Sci. Soc. Am.*, 99–143
- Hsu PH (1984) Aluminium hydroxides and oxyhydroxides in soils: recent developments. *Annu. Meeting and Am. Soc. Agron*
- Jeanroy E and Guillet B (1981) The occurrence of suspended ferruginous particles in pyrophosphate extracts of some soil horizons. *Geoderma*, 26, 95–105
- Jeanroy E (1983) *Diagnostic des formes du fer dans les pédogénèses tempérées. Evaluation par les réactifs chimiques d'extraction et apports de la spectrométrie Mossbauer. (études des formes organiques du fer amorphe dans les sols)*, Thèse Doctorat, Nancy, 109–129
- Kampf N and Schwertmann U (1982) The 5M-NaOH concentration treatment for iron oxides in soils. *Clays clay Miner.*, 30, 401–408
- Klamt E (1985) Reports of meetings. Iron in soil and clay minerals. Bad Windsheim, West Germany, July 1–13 1985. *Bull. Soc. Int. Sci. du Sol*, 2, 9
- Krasnodebska-Ostrega B, Emons H and Golimowski J (2001) Selective leaching of elements associated with Mn-Fe oxides in forest soil, and comparison of two sequential extraction methods. *Fresenius J. Anal. Chem.*, 371, 385–390
- Kwong KF and Huang PM (1979) The relative influence of low-molecular-weight complexing organic acids on the hydrolysis and precipitation of Aluminium. *Soil Sci.*, 128, 337–342
- Lewis DG and Schwertmann U (1979) The influence of Al on iron oxides. Part III - Preparation of Al goethites in M KOH. *Clay Miner.*, 14, 115–126
- Lewis DG and Schwertmann U (1979) The influence of Al on the formation of iron oxides. Part IV: The influence of [Al], [OH] and temperature. *Clays clay Miner.*, 27, 195–200
- Loveland PJ and Bullock P (1976) Chemical and mineralogical properties of brown podzolic soils in comparison with soils of other groups. *J. Soil Sci.*, 27, 523–540
- Loveland PJ and Digby P (1984) The extraction of Fe and Al by 0,1 M pyrophosphate solutions: a comparison of some techniques. *J. Soil Sci.*, 35, 243–250
- Mc Keague JA and Day JH (1966) Dithionite and oxalate-extractable Fe and Ag as aids in differentiating various classes of soils. *Canad. J. Soil Sci.*, 46, 13–22
- Mc Keague JA (1967) An evaluation of 0,1 M pyrophosphate and pyrophosphate-dithionite in comparison with oxalate as extractants of the accumulation products in podzols and some other soils. *Can. J. Soil Sci.*, 47, 95–99

- Neaman A, Mouélé F, Trolard F, Bourrié G (2004a) Improved methods for selective dissolution of Mn oxides : applications for studying trace element associations. *Appl. Geochem.*, 19, 973–979
- Neaman A, Waller B, Mouélé F, Trolard F, Bourrié G (2004b) Improved methods for selective dissolution of manganese oxides from soils and rocks. *Eur. J. Soil Sci.*, 55, 47–54
- Norrish K and Taylor RM (1961) The isomorphous replacement of iron by aluminium in soil goethites. *J. Soil Sci.*, 12, 294–306
- Petersen L (1976) *Podzols and podzolization.*, Thesis Copenhagen (Danmark)
- Pollard RJ, Cardile CM, Lewis DG and Brown LJ (1992) Characterization of FeOOH polymorphs and ferrihydrite using low-temperature applied-field, Mössbauer spectroscopy. *Clay Miner.*, 27, 57–71
- Quantin P et Lamouroux M (1974) Adaptation de la méthode cinétique de Ségalen à la détermination des constituants minéraux de sols variés. *Cah. ORSTOM, sér. Pédol.*, XII, 1, 13–46
- Quigley RM, Haynes JE, Bohdanowicz A and Gwyn QHJ (1985) *Geology, geotechnique, mineralogy and geochemistry of Leda clay from deep Boreholes*, Hawkesbury Area. Ontario Geol. Surv., study 29, 128 pages
- Ryan JN and Gschwend PM (1991) Extraction of iron oxides from sediments using reductive dissolution by titanium (III). *Clays and clay Miner.*, 39, 509–518
- Schuppli PA, Ross GJ and McKeague JA (1983) The effective removal of suspended materials from pyrophosphate extracts of soil from tropical and temperate regions. *Soil Sci. Soc. Am. J.*, 47, 1026–1032
- Schwertmann U (1964) Differenzierung der Eisenoxide des Bodens durch photochemische extraktion mit saurer Ammoniumoxalate-losung. *Z. Pflanzenernähr. Dueng. Bodenk.*, 105, 194–202
- Schwertmann U (1991) Solubility and dissolution of iron oxides. *Plant and Soil*, 130, 1–25
- Ségalen P (1968) Note sur une méthode de détermination des produits amorphes dans certains sols à hydroxydes tropicaux. *Cahiers ORSTOM Série Pédol.*, 6, 106–126
- Shuman LM (1982) Separating soil iron and manganese oxide fractions for microelement analysis. *Soil Sci. Soc. Amer. J.*, 46, 1099–1102
- Stol RJ, Van Helden AD and De Bruyn PL (1976) Hydrolysis-precipitation studies of aluminium solution. II - A kinetic study and a model. *J. Colloid Interface Sci.*, 57, 115–131
- Stumm W (1985) The effects of complex-forming ligands on the dissolution of oxides and aluminosilicates. *In The chemistry of weathering.*, Reideil D Drever J ed., 55–74
- Tamm O (1922) Eine methode zur Bestimmung der anorganischen komponenten des Gelkomplexes im Boden. *Meddal. Statens sSkogförsöksanst.*, 19, 385–404
- Tamm O (1931) *Monthly letter.*, Imperial bureau of soil science, 1 October
- Tamm O (1934a) *Monthly letter.*, Imperial bureau of Soil Science, 34, August
- Tamm O (1934b) Über die oxalat-methode in der chemischen Boden analyse. *Medd. Skogförsökamsanst.*, 27, 1–20



- 
- Tokashiki Y, Dixon JB and Golden DC (1986) Manganese oxide analysis in soils by combined X-Ray diffraction and selective dissolution methods. *Soil Sci. Soc. Amer. J.*, 50, 1079–1084
- Torrance JK, Hedges SW and Bowen LH (1986) Mössbauer spectroscopic study of the iron mineralogy of post-glacial marine clays. *Clays clay Miner.*, 34, 314–322
- Yong R, Sethi AJ and La Rochelle P (1979) Significance of amorphous material relative to sensitivity in some Champlain clays. *Canad. Geotechn. J.*, 16, 511–520

## Thermal Analysis

### 7.1 Introduction

#### 7.1.1 Definition

Many different analyses of phase transformations involve the use of temperature. This is true in the case of simple gravimetric measurements after drying at a given temperature (cf. Chap. 1), or after chemical precipitation and drying to constant weight. The generic term “thermal analysis” generally only applies to methods carried out according to a dynamically controlled thermal programme making it possible to reveal and quantify different physicochemical transitions. The most common methods used in soil analysis record transformations by means of the temperature either of mass, energy, or the mechanical properties of the samples (Fig. 7.1).

#### ***Measurements of Mass Variations***

The abbreviations TGA or TG stand for thermogravimetric analysis and DTG stands for differential thermogravimetry. Losses occur in the form of gases that are simple to detect by (evolved gas detection EGD) and to analyze by (evolved gas analysis EGA).

#### ***Measurements of Variations in Energy***

These measurements mainly use DTA, differential thermal analysis and DSC, differential scanning calorimetry. They enable quantification of exothermic or endothermic energy changes at each temperature without inevitably modifying weight.

### **Measurements of Dimensional or Physical Variations**

These include TMA, thermo mechanical analysis (dilatometry) and DMA, dynamic mechanical analysis (viscoelasticity). Though these techniques are used especially in the field of ceramics and plastics, they are also suitable for the study of physical soil properties and specifically for the shrinkage and swelling linked to aggregation and water storage properties (Braudeau 1987, 1988; Braudeau et al. 1999, 2004).

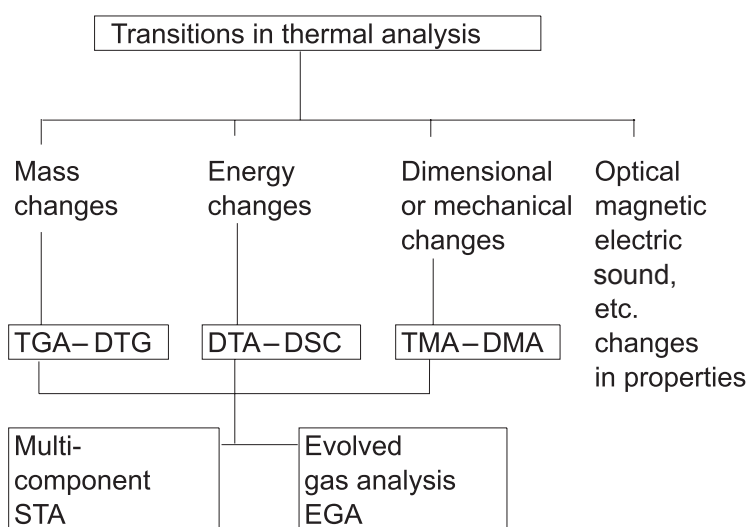

**Fig. 7.1.** Table summarizing the principal methods of thermal analysis: TGA, thermogravimetric analysis; DTG, differential thermogravimetry; DTA, differential thermal analysis; DSC, differential scanning calorimetry; TMA, thermomechanical analysis; DMA, dynamic mechanical analysis; STA, simultaneous thermal analysis; EGA, evolved gas analysis. The International Confederation for Thermal Analysis (ICTA) uses the term “derivation” for data resulting from mathematical transformations (derivative calculations on initially measured data) and “differential” for experimental measurements of changes in the delay step concerned

Variations in properties (optical, magnetic, electric, or sound) also occur and can be measured analytically (for example, thermoluminescence is widely used for dating), the loss of magnetic property is represented by the point of Curie, etc.

The equipment used for these analyses has reached a high degree of sophistication thanks to its industrial use in the fields of ceramics, glass, cement, plaster, explosives, radioisotopes, pharmaceuticals, and polymers where it is widely used for research and quality control. The simplest

equipment is not very expensive, but top-of-the-range apparatuses (multiparametric, high temperature, high pressure, etc.) with their associated peripherals and data processing software, can be very costly.

### 7.1.2 Interest

Used in combination with XRD (cf. Chap. 4), IR (cf. Chap. 5) and other chemical analyses, thermal analysis techniques are invaluable tools in mineralogy, geology, pedology, soil chemistry, and physics. They allow the qualitative identification and quantitative analysis of clays (Table 7.1) and many minerals, and also the identification of the different forms of water in soils, oxidation of all forms of organic matter and inorganic materials, phase transitions, etc.

The sensitivity of the DTA–DSC methods makes it possible to detect the presence of minerals at the limit of detection of XRD (e.g. goethite, gibbsite at concentration less than 0.25%, substances with short distance atomic arrangement) in clays and soils.

All the techniques used enable the balance of the mineral transformations to be established as a function of different geochemical processes both in a weathering profile and in a topographic sequence.

Reasonably precise quantitative analysis is possible of hydroxides and oxyhydroxides of iron and aluminium, as well as of clays and particularly of 1:1 kaolinite and halloysite. Continental sediments containing organic complexes can be studied by controlled oxidizing or non-oxidizing pyrolysis, and the evolved gases are analyzed by Fourier transform infrared spectrometry (FTIR). DSC can quantify enthalpy changes during dehydration, dehydroxylation and other forms of structural decomposition in a thermal field extending from  $-150$  to  $+725^{\circ}\text{C}$ . The analysis of evolved gases by FTIR or mass spectrometry during temperature scanning makes it possible to calculate the exact chemical transformations undergone by the sample.

Thermal analysis is particularly useful for the study of soil genesis, the study of soils rich in *para*-crystalline compounds (e.g. andosols, histosols) and characterization of the evolution of compounds with short-distance atomic arrangement that cannot be directly analyzed by XRD.

In certain cases it is possible to use the thermogravimetric method in a range of temperatures from ambient to  $200^{\circ}\text{C}$  to indirectly measure the specific surfaces of clays (internal and external surfaces) by impregnation of the sample with a monomolecular layer of an organic material (e.g. the EGME method) or of a gas (e.g. the BET method).

Table 7.1. Transformation of clays up to 1,200 °C (adsorbed water and bound water)

K	°C	mullite ↑	$\gamma$ Al <sub>2</sub> O <sub>3</sub> leucite		
1,373	1,100-	metakaolin	corundum	eustatite....	
1,273	1,000-	end of dehydroxylation	↑ cristobalite		
1,073	800-	water bound to the crystalline lattice	bound water	bound the crystalline lattice	bound water to the crystalline lattice
973	700-	≈ 16.0%	≈ 5.3%	≈ 5.1%	≈ 5.0%
				700 °C	700 °C
				≈ 4.7%	≈ 14.8%
873	600-			≈ 4.8% water in cavities	≈ 4.8% water in cavities
				≈ 3.1%	≈ 4.7%
673	400-	(350 °C)	(350 °C)	adsorbed water	adsorbed water
				370 °C	
				adsorbed water	adsorbed water
				in cavities	



Instrumental thermal dilatometric methods developed by ceramists can be used instead of manual measurements of contraction–dilation (coefficient of linear extension).

## 7.2 Classical Methods

### 7.2.1 Thermogravimetric Analysis

#### *Principle*

Variations in the mass of the sample (losses or increases) are recorded as a function of temperature or time. For soil studies, a temperature range between ambient temperature and 1,100 or 1,200°C is generally satisfactory, but it may be necessary to study reactions up to temperatures of more than 2,000°C, in particular to determine melting points.

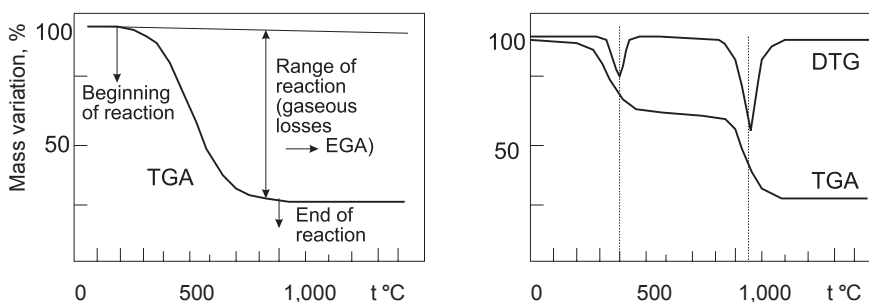

**Fig. 7.2.** Principle of thermogravimetric analysis  $m = f(t)$  (on the left) and comparison with differential thermogravimetry  $dm/dt = f(t)$  (on the right)

In dynamic analysis, the mass of the sample ( $m$ ) is heated at a constant rate according to a linear programme based on temperature or time (Fig. 7.2). The extent of the reaction interval, the shape of the curve and the nature of the gases released provide information on the nature of the soil sample and its thermal stability.

In TGA by derivation, the first derivative of the variations of mass is recorded as a function of time or of temperature. Two “static” methods can also be used in certain cases, but take a very long time to implement:

- The isothermal method where the sample is subjected to a constant temperature and the sample weight is recorded over time until their equilibrium value is reached;
- The isobar method where the sample is maintained at a constant pressure and the weight recorded as a function of temperature; the pressure can exceed 500 atm. for certain materials.

Clay minerals contain molecules of water and hydroxides bound to the crystal lattice at different energies. During the rise in temperature, this water is gradually moved and eliminated in the form of gas.

In the soil, interstitial water of hydration or adsorption that is not bound is generally released first by dehydration. Dehydration does not cause the destruction of the lattice but can cause a modification in the arrangement of the continuous poly- or monomolecular layers (internal and external surfaces of 2:1 clays and interlayer exchangeable ions) along with a contraction of the interlayer space. This phenomenon is reversible. Water in cavities at the base of the tetrahedrons will be more vigorously bound. On the other hand, the phenomenon may be irreversible in soils with allophane, and rehydration will not be able to reach more than around 10% of the initial moisture content. This is also true of hydrated halloysite,  $4\text{H}_2\text{O}$ , which gives metahalloysite,  $2\text{H}_2\text{O}$ .

The hydroxyl  $\text{OH}^-$  ions bound to oxygen atoms at the top of the tetrahedral or octahedral units, or present in the external continuous layers of 1:1 clays, or in the internal or external layers of 2:1 clays (or hydrated 1:1 halloysite) are then moved. Their elimination is irreversible and is accompanied by the destruction of the structure (dehydroxylation). The appearance of new forms at a higher temperature can then be recorded, for example kaolinite giving metakaolinite then mullite. But certain transformations that occur without weight loss are not detectable by TGA. In this case the DTA or DSC spectra have to be recorded.

It should be noted that the transition between free  $\text{H}_2\text{O}$  and  $\text{OH}^-$  of hydroxyls is not always clear as the water bound to the lattice can start to leave before the interstitial water is completely eliminated. In this case thermal analysis at controlled speed of transformation can be used (Rouquerol 1970, 1989; Rouquerol et al. 1985, 1988)<sup>1</sup>.

---

<sup>1</sup> The method of analysis at controlled speed of transformation makes it possible to measure the initial state of water with more precision. In conventional analysis, the programme of temperature increase varies in a linear way over time. With controlled speed of transformation, the pressure caused by the departure of the gas determines the programme for the increase in temperature by means of a captor. Coupling with a quadripolar mass spectrometer enables analysis of evolved gas. When the adsorbed water with weak activation energy is desorbed, the rise in temperature stops until the initial pressure is restored to the pre-determined point. Then heating continues. This makes it easier to study



## **Implementation**

### **Reagents**

- Reagents described in Chaps. 2 and 3 for destruction of organic matter or carbonates, homoionic saturation, etc.
- Clays purified for standardization (samples for the reference system of the laboratory and/or international standards).
- Saturated solution of magnesium nitrate ( $\text{Mg}(\text{NO}_3)_2 \cdot 6\text{H}_2\text{O}$ ,  $1,250 \text{ g L}^{-1}$  at  $20^\circ\text{C}$ ) (to equilibrate the moisture of clays – 56% of relative moisture at  $20^\circ\text{C}$ ).
- Drying agents of varying degrees of effectiveness:
  - (a) Magnesium perchlorate (dehydrite),  $\text{Mg}(\text{ClO}_4)_2$ , molar weight *mw*: 223.23;
  - (b) Aluminium oxide  $\text{Al}_2\text{O}_3$ , *mw*: 101.94;
  - (c) Silicon dioxide (Silicagel),  $\text{SiO}_2$ , *mw*: 60.08;
  - (d) Anhydrous calcium chloride,  $\text{CaCl}_2$ , *mw*: 110.99;
  - (e) Anhydrous calcium sulphate (anhydrite/drierite),  $\text{CaSO}_4$ , *mw*: 136.04;
  - (f) Phosphorus pentoxide (phosphoric anhydride),  $\text{P}_2\text{O}_5$ , *mw*: 141.96.

### **Equipment**

- Platinum micro-crucibles;
- Desiccator with saturated solution of magnesium nitrate;
- Desiccators with different drying agents;
- Thermal balance (Fig. 7.3).

Briefly, a thermal balance is composed of a furnace, a balance and different devices for regulation and data acquisition. Weighing is carried out continuously throughout the thermal cycle. There are two types of equipment:

  - Balances placed above the mobile furnace;
  - Balances placed below the mobile furnace.

In the first, the sample nacelle is suspended on a wire; in the second, a vertical rod equipped with a support holds the sample. Each system has certain disadvantages that must be minimized to optimize measurements.

The balance must allow all losses or increases in mass to be recorded as a function of the temperature and time under all experimental

---

the mechanisms of hydration and possibly the short- or long-distance atomic structure.

conditions. The temperature of the furnace can reach 2,400°C and radiative and magnetic phenomena may occur. The quality of measurements must be the same as with any other analytical microbalance (Pansu et al. 2001). The capacity can vary considerably depending on the use envisaged. For soils, a choice has to be made between (a) relatively big samples, i.e. 100 mg to 1 g with a sensitivity of  $10^{-5}$ – $10^{-6}$  g and (b) micro-samples, i.e. from 1 to 50 mg (e.g. piezo-electric balances with a sensitivity of  $10^{-8}$ – $10^{-12}$  g).

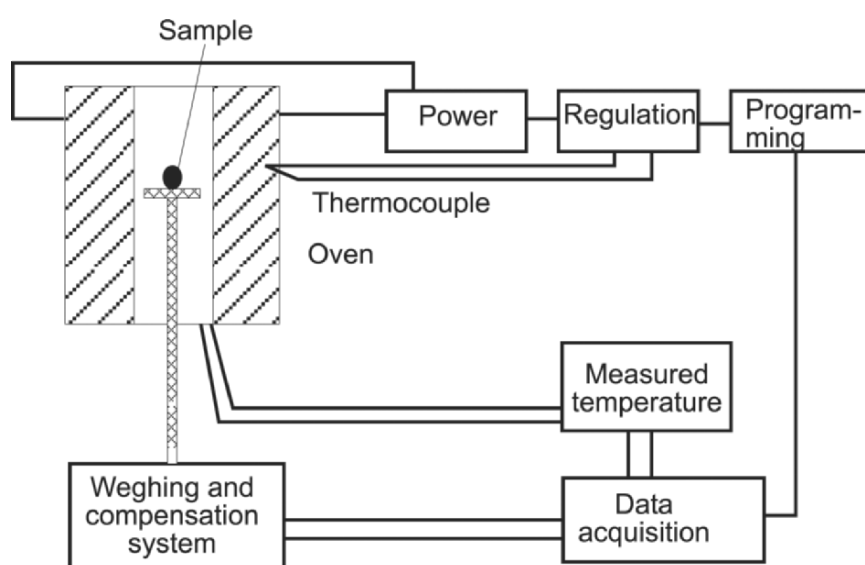

**Fig. 7.3.** Example of a system for thermogravimetric analysis

Different types of balances are available: deflection balances (e.g. with torsion, beam balance, cantilever, with a beryllium bronze spring) but electronic systems without a beam are rarely used because of the disturbances that can be caused by radiative phenomena.

The furnace is designed as a function of the temperature. It can be the high frequency induction type or more generally the resistance type (Table 7.2). Kanthal resistances enable measurements at 1,200°C, rhodium resistances at 1,800°C and tungsten resistances at 2,500°C.

The furnace is an assembly of metal and ceramic components (high density alumina) which allow resistances to be insulated to ensure

homogeneous temperatures in the test zone, and also to allow sealing in the case of controlled atmosphere. The furnace has a sophisticated regulation system. The speed of heating must result in a uniform temperature in the test zone and be monitored by thermocouples appropriate for the work temperature (Table 7.3). The programming of the heating cycle must be highly reproducible. The sample must be located in a precise spot in the furnace. The data acquisition system must enable variations in weight and temperature to be recorded simultaneously, and also to carry out a certain number of mathematical operations (e.g. first derivative, surface of the peaks), to control the temperature programme, and finally to store and print the data.

**Table 7.2.** Type of resistances – thermal ranges

material	temperature used (°C)	melting point (°C)	material	temperature used (°C)	melting point (°C)
constantan	750	1,200	rhodium (Rh)	1,800	
nichrome	1,000	1,500	molybdenum <sup>a</sup>	2,200	2,500
chromel – alumel	1,100		tantale	–	2,850
kanthal	1,350		tungsten <sup>b</sup>	2,800	3,400
platinum (Pt)	1,400	1,755	<sup>a</sup> Hydrogen atmosphere <sup>b</sup> Mechanical resistance up to 1,650°C		
Pt–Rh 10%	1,500				
Pt–Rh 13%	1,700				
super kanthal	1,600				

### *Procedure*

The methods have to be standardised if the data obtained in different series is to be compared. The technical characteristics of the thermal balance determine certain obligatory parameters. The nature of the

materials to be studied determines the selection of other diagnostic parameters. The samples must be crushed without heating as this could disturb subsequent thermal analysis.

**Table 7.3.** Types of thermocouples at different temperatures

material	temperature (°C)	material	temp. (°C)
copper–constantan <sup>a</sup>	400 (standard)	tungsten – rhenium	2,200
iron–constantan	800 (standard)	tungsten – 20% rhenium tungsten	2,400
chromel–constantan	1,000 (standard)	tantalum carbide – graphite <sup>b</sup>	3,000
chromel – alumel	1,000 (standard)	<sup>a</sup> Alloy 55% copper + 45% nickel  <sup>b</sup> Argon atmosphere  <sup>c</sup> The thermopiles allow the output signal to be increased without amplification	
nickel chromium – nickel	1,370		
platinum–platinum rhodium (10% or 13% Rh) <sup>c</sup>	1,750		

Initially rough samples (from which organic matter has been eliminated) are reduced by moderate wet crushing. The sample must have a regular particle size and, after air drying, pass through a 0.1 mm sieve. Samples of clays that have been purified and saturated using the methods described in Chap. 3 can also be used. It should be noted that too fine dry grinding can distort the results.<sup>2</sup>

Adjust the moisture of the sample by placing it in a desiccator containing saturated magnesium nitrate for 48 h (relative moisture should be 56% at 20°C at normal pressure). This treatment homogenizes the hydration layers of any interlayer cations that may be present.

Weigh a given weight of sample (5–20 mg) suitable for the range and sensitivity of the balance. Pack the sample in a platinum crucible as

<sup>2</sup>Dry grinding can modify the nature of the basal faces and consequently their physical properties. For example, the exchange capacity and some thermal properties of kaolinite can be changed (collapse of the peaks) by too fine grinding which can result in fractures perpendicular to the basal faces and subsequent breakdown of layers.

regularly as possible to limit differences in thermal diffusivity. Place the sample in the thermal balance. Adjust the position of the sample to that of the measurement thermocouple in the furnace.

Programme the instrumental variables with the management software, i.e. the linear speed of heating (e.g.  $10^{\circ}\text{C min}^{-1}$ ), atmosphere of the furnace, final temperature, etc.

### Observations

*For clay* the best quantitative measurements are obtained on homoionically saturated samples ( $\text{Na}^+$ ,  $\text{K}^+$ ,  $\text{Ca}^{2+}$  or  $\text{Mg}^{2+}$ ), after elimination of organic matter, soluble salts, ferrous iron, etc. Homoionic saturation of clay enables:

- with  $\text{Na}^+$  ions, improved differentiation between adsorbed water and water bound to the lattice;
- with  $\text{Mg}^{2+}$  ions improved separation of 2:1 clays from 1:1 clays on the basis of adsorbed water.

*The presence of organic matter* (OM) modifies weight loss of mineral origin. The loss of  $\text{H}_2\text{O} + \text{CO}_2$  of the OM must be measured. An inert atmosphere can be used to mitigate this phenomenon if it is not too serious, or losses can be estimated by analyzing emitted gas (e.g. by coupled EGA-FTIR).

*Ferrous iron* will oxidize during heating and increase in weight according to the following equations:

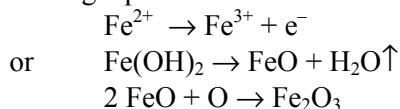

As oxidation of ferrous iron does not result in easily measurable variations in mass, it may be preferable to eliminate it. The same is true for manganese and cobalt. An inert atmosphere can also be used. The elimination of soluble salts avoids secondary recombination.

*The choice of the nature of the crucible* and its geometry can modify the results. The crucible should not react with the sample, with the selected atmosphere or the evolved gas. Certain metals have a catalytic action. Crucibles made of alumina are relatively porous, silver can be used for medium temperatures, platinum can be used for a temperature of  $1,500^{\circ}\text{C}$ . The walls of the crucibles must be as thin as possible (approximately 0.5 mm) to minimize variations in temperature. In the same way, the sample layer should be as thin as possible to ensure that the temperature in the centre is the same as at the edges. As certain minerals are expansible or likely to generate projections, deeper crucibles are sometimes necessary or semi-permeable lids have to be used which, however, can modify the gas flow of the losses.

*The speed of the increase in temperature* influences the decomposition of the sample. For a given temperature interval, slow decomposition is more realistic, than too rapid decomposition which can cause displacement of the characteristic temperatures, a steeper decomposition slope, etc. For example, Kotra et al. (1982) showed that a siderite ( $\text{FeCO}_3$ ) heated at  $1^\circ\text{C min}^{-1}$  had a range of decomposition positioned between 400 and  $500^\circ\text{C}$ . At a speed of  $20^\circ\text{C min}^{-1}$  this range moved to between 480 and  $610^\circ\text{C}$ . However, a micro sample displays fewer variations than a sample of greater mass. Low speed also enables detection of compounds that only display weak inflection at higher speeds.

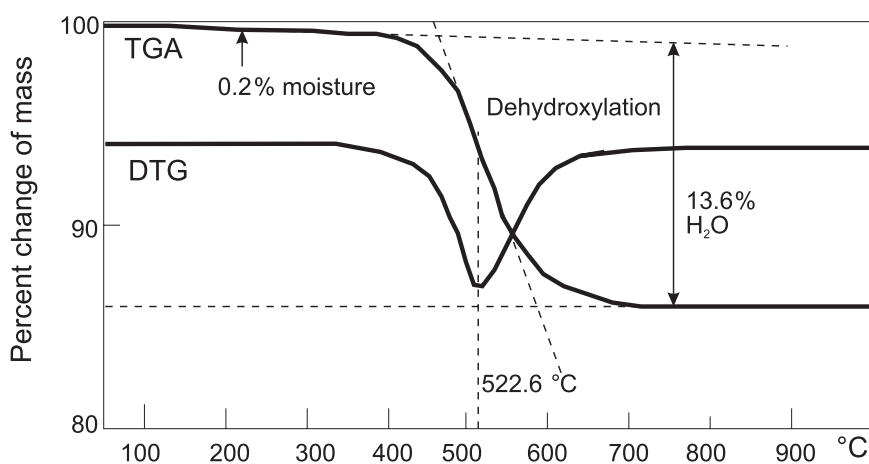

**Fig. 7.4.** Example of TGA and DTG curves for kaolinite (Mâcon, France). Mass of sample: 25 mg; speed of heating:  $10^\circ\text{C min}^{-1}$ ; atmosphere: nitrogen  $30\text{ mL min}^{-1}$ ; and platinum crucible.

*The atmosphere of the furnace* can greatly influence the results with respect to the nature of the decomposition products and types of reactions. Vacuum, inert or reactive atmosphere induce very different thermal spectra. It may be useful to analyze evolved gases.

### ***Differential thermogravimetric analysis (DTG)***

In this type of analysis, peaks are obtained whose surface is directly proportional to changes in the mass of the sample (Figs. 7.2 and 7.4), which facilitates quantitative analysis. When the variations in weight are null one obtains a return to the base line for which  $dm/dt = 0$ . The curves give an inflection point in the zone where the variation in mass reaches its maximum. The separation of overlapping phenomena is facilitated.

### ***Discussion***

The water contents of a clay can be measured on a sample in equilibrium with an atmosphere at approximately 56% relative moisture (obtained by a mixture of nitrate of magnesium saturated in water). In this way an initial point of reference can be obtained that takes into account complex assemblies of minerals and organominerals, and allows better reproducibility.

It is possible to measure water that depends on the exchangeable cations. The water content can be very high for 2:1 clays of the montmorillonite type<sup>3</sup> and weak for 1:1 clays of the kaolinite type. However, it is not possible to measure the energy of activation necessary to release water with TGA or DTG. For this purpose DTA must be used giving the quantity of calories that generates the endothermic peak, the quantity of released water being identified by TGA under the same conditions. Existing equipment allows TGA–DTG and DTA to be used simultaneously in the same treatment cycle up to temperatures of 1,750°C or more on the same micro sample.

Direct quantification is possible if only one reaction occurs at a given temperature. By insulating the components, quantification becomes possible for organic matter in an oxidizing medium, for carbonates (e.g. dolomite, aragonite, calcite, siderite), sulphides (e.g. pyrites) with very low contents. Here combining quantification with analysis of evolved gas is essential.

---

<sup>3</sup> The layers of 2:1 clays adsorb at least two layers of water molecules. They are disorientated with respect to one another with a tendency to form association of layers (turbostratic assemblies with 5 or 6 layers).

## 7.2.2 Differential Thermal Analysis and Differential Scanning Calorimetry

### *Principle of DTA*

In DTA, the difference in temperature between a soil or clay sample and an inert reference material is recorded as a function of time or temperature with the two substances controlled by the same temperature control programme, at constant linear speed:

$$\Delta T = T_{\text{sample}} - T_{\text{reference}}$$

This kind of analysis enables identification of the relations of proportionality that exist between the surface of a peak and the released or absorbed heat during the course of the heating programme. This heat is proportional to the enthalpy of reaction and thus can be used for thermodynamic quantification if the mass of the sample is taken into account. However, in DTA, the simple direct conversion of the peaks into unit of energy is not possible starting only from  $\Delta T$  as a function of time. Indeed,  $\Delta T$  depends on the variation in enthalpy, the calorific capacity and the total thermal resistance of the heat flow ( $R$ ) at a given time.  $R$  depends on the nature and the mass of the sample, its preparation (compression, etc.), and the thermal surface of contact between the crucible and the support. These variables are temperature dependent and consequently have to be controlled.

For soils, most analysis is carried out between ambient temperature and 1,200°C. When a reaction occurs during an increase in temperature, a difference in temperature is observed between the sample and the reference (Fig. 7.5):

- If the temperature is lower than that of the inert reference material, an endothermic peak appears ( $\Delta T$  is negative), this is the case in reactions of dehydration, dehydroxylation, fusion, evaporation, sublimation, etc.
- If, on the contrary, the temperature of the sample exceeds that of the reference, an exothermic peak appears ( $\Delta T$  is positive), this is the case for oxidation phenomena (combustion of OM, oxidation of sulphides, oxidation of ferrous iron, certain nucleations or decomposition with neoformation).

The recorded differences in temperature are related to the change in enthalpy, but this does not exclude the possibility of two exothermic and endothermic reactions occurring simultaneously. When this is the case, the absence or depression of the DTA peak does not imply the absence of a reaction.



Contrary to TGA, DTA can produce peaks even if there is no loss or increase in weight, e.g. in reversible second-order transformations: variation in specific heat, magnetic susceptibility, Curie point or  $\alpha/\beta$  allotropic transformation of quartz. TGA and DTA are complementary techniques.

The shape, size and temperature of the peaks are influenced by instrumental factors such as the speed of heating, the nature of the sample support and of the thermocouples.

Small samples give a better resolution of the peaks and allow faster heating. Slower speed can increase sensitivity, but to the detriment of temperature, precision, and resolution. A dynamic atmosphere is preferable to a self-generated static atmosphere. This allows continuous evacuation of evolved gas, thus reducing the risks of artefact reactions at higher temperatures. These gases can then be analyzed enabling identification of the molecular structure of the compounds that caused the gaseous emission.

**Fig. 7.5.**  
Diagrammatic  
output of  
differential thermal  
analysis.  
BD, peak width;  
EC, peak height;  
BCD, peak surface;  
AF, base line

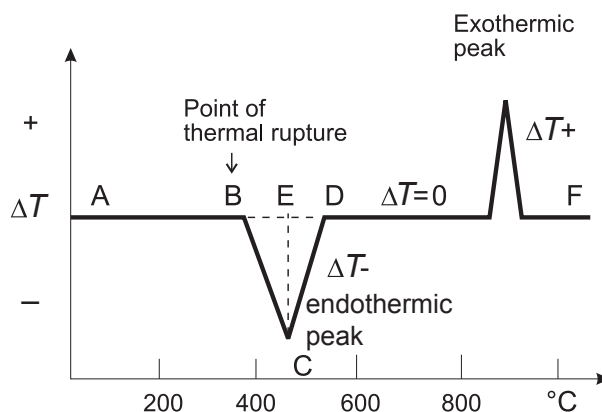

The range of different types of equipment sold by different manufacturers means complex mathematical demonstrations are not required to validate the different parameters taken into account, see for example Duval (1963), Watson et al. (1964), Garrels and Christ (1965), Allen (1966), Gray (1968), Mackenzie (1970), Brennan (1971), Miller et al. (1973), and McNaughton and Mortimer (1975).

### ***Principle of Differential Scanning Calorimetry***

Other techniques to measure energy are grouped under the name of DSC. DSC techniques are often badly defined because patents use the same term for different concepts.

The term DSC applies to apparatuses able to measure specific heat, or the heat capacity of a sample, and to quantify the energy of the reactions during the heat treatment. In DSC with power compensation, the sample and reference are continuously maintained at the same temperature by individual resistances. The parameter that is recorded is the quantity of power consumed by the compensation resistances, that is to say  $d(\Delta Q)/dt$  or  $dH/dt$  in millicalories per second as a function of the temperature (controlled linear increase).

When a reaction occurs in the sample, thermal energy is added or removed. The quantity of energy added or removed is equivalent to the quantity emitted or absorbed by a given transition. The recording of this balance of energy is a calorimetric measurement of enthalpy.

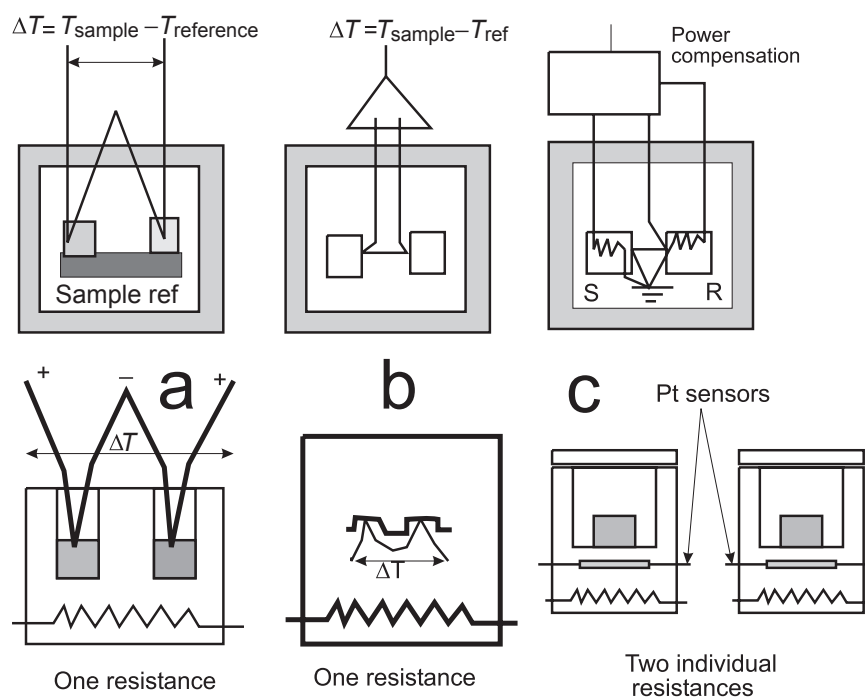

**Fig. 7.6.** Thermal systems using measurements of energy: a, classical DTA; b, Boersma DTA with heat flow or conventional indirect DSC; and c, DSC with compensation of power

In the Boersma technique, also known as DSC or DTA with heat flow,  $\Delta T = T_{\text{sample}} - T_{\text{reference}}$  are measured like in DTA. The sensors are placed below the crucibles to reduce the effects of variations in the thermal resistance of the sample. This way of assembling the components is

similar to other DSC heat flow equipment that records  $d\Delta q/dt$  type data or, with thermopiles,  $dQ_{\text{sample}}/dt - dQ_{\text{reference}}/dt = d(\Delta Q)/dt$  enabling the quantitative measurement of enthalpy.

In modulated DSC, the sample is subjected to a linear increase in heating (for example  $10^\circ\text{C min}^{-1}$ ) on which a sinusoidal modulation of temperature (of 30 s and amplitude of  $1^\circ\text{C}$ ) is superimposed resulting in a cyclic heating profile. There is thus a speed of constant subjacent heating and instantaneous measurements at sinusoidal speed. The deconvolution of the flow profile resulting from the heating profile provides the total heat flow as in conventional DSC, but also separates flow into two components: reversible specific heat and non-reversible kinetic heat. This technique enables improvement of resolution and sensitivity, because low speed favours good resolution and high heating speed favours good sensitivity.

The functioning temperature of the DSC apparatuses with power compensation is generally limited to  $750^\circ\text{C}$ , which is too low to study certain reactions in the soil. Classical DSC makes it possible to reach temperatures similar to those of DTA or TGA.

### **Materials**

These must be reference products and be ground to 0.1 mm in an agate mortar.



- Products of known melting points to calibrate temperature (Table 7.4).
- Inert reference: alumina ( $\text{Al}_2\text{O}_3$ ) calcined to  $1,200^\circ\text{C}$ , and ground to 0.1 mm in an agate mortar does not show any effect of heating except possibly a few irregularities in the base line.
- Purified clays belonging to the laboratory reference set homoionically saturated by  $\text{Mg}^{2+}$ ,  $\text{Ca}^{2+}$ , or  $\text{Na}^+$ . Clay samples from industrially exploited sedimentary deposits should be distinguished from those coming from soils.
- Pure minerals from the laboratory reference set and industrial reference products for analysis.
- 1,250 g ( $\text{Mg}(\text{NO}_3)_2 \cdot 6\text{H}_2\text{O}$ )  $\text{L}^{-1}$  of magnesium nitrate saturated aqueous solution at  $20^\circ\text{C}$ .

### **Equipment**

- DTA micro crucibles made of platinum (or possibly alumina, quartz, tungsten, zirconium oxide, nickel, or aluminium).
- Desiccator with  $\text{Mg}(\text{NO}_3)_2 \cdot 6\text{H}_2\text{O}$  saturated solution.
- Desiccator with desiccating agents.

- Analytical balance ( $10^{-6}$ – $10^{-8}$  g) with a weighing range of 1–100 mg for quantitative analysis.
- Apparatuses: industrial DTA–DSC instruments are designed and built according to different concepts, and this can make comparison of data difficult. It is advisable to use a laboratory reference set to ensure the precision and relevance of the results. The equipment generally comprises different components (Figs. 7.6 and 7.7):

**Table 7.4.** Calibration products for thermal analysis

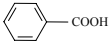
product	formula	melting point (°C)	mw (g mol <sup>-1</sup> )
naphthalene	C <sub>10</sub> H <sub>8</sub> 	80.2	128.16
phenanthrene	C <sub>14</sub> H <sub>10</sub> 	99.3	178.22
benzoic acid	C <sub>7</sub> H <sub>6</sub> O <sub>2</sub> 	122.3 (sublimation)	122.12
barium chloride	BaCl <sub>2</sub> ·2H <sub>2</sub> O	130.0 (–2 H <sub>2</sub> O)	244.31
<sup>a</sup> calcium sulphate	CaSO <sub>4</sub> ·2H <sub>2</sub> O	180.0 (–2 H <sub>2</sub> O)	172.18
tin	Sn	231.97	118.70
cadmium carbonate	CdCO <sub>3</sub>	350.00	172.42
zinc	Zn	419.4 (ignition at air contact)	65.38
lithium bromide	LiBr·H <sub>2</sub> O (deliquescent)	553	104.87
quartz	SiO <sub>2</sub>	573	60.06
aluminium	Al	660.2	26.98
<sup>a</sup> calcium carbonate (468 cal g <sup>-1</sup> )	CaCO <sub>3</sub>	850 (CO <sub>2</sub> + CaO)	100.09
silver	Ag	960.8	107.88

<sup>a</sup> Standard material used to measure heat of reaction.

- A furnace equipped with a device to programme temperature, to control atmosphere and to accelerate cooling (between 20 and 40 min before a new cycle starts);
- A support for the sample equipped with differential temperature detectors;
- A management station for analytical programmes and recording of measurements.

Temperatures exceeding 2,000°C are required for ceramics. For soils, a temperature of 1,200°C is generally sufficient but 1,600°C may be needed.

The position of the sample support and the inert reference can vary considerably (Fig. 7.7). The thermocouples can be placed in or outside the crucibles (or to even welded into a cavity in the crucible). Metal crucibles give smaller peaks than ceramics with a faster heat transfer thus limiting the risks of deformation of the peaks. For studies up to approximately 1,000°C, chromel–alumel thermocouples generate a significant electromotive force (EMF = 45.16 mV at 1,100°C) but relatively low chemical resistance. On the other hand, platinum–rhodium or platinum thermocouples generate EMF = 10.74 mV which requires amplification, but can reach temperatures of 1,500°C and are chemically much more resistant.

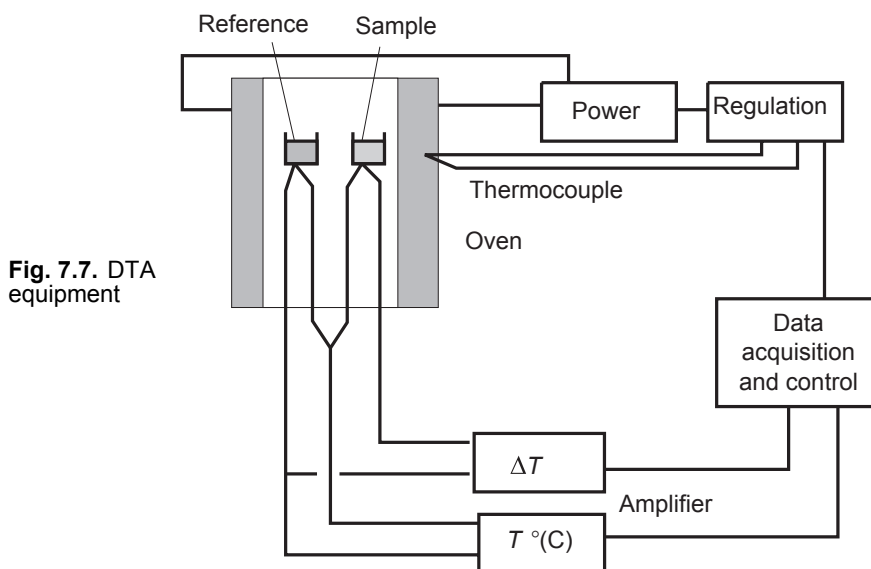

Fig. 7.7. DTA equipment

The position of the thermocouples in the sample and in the reference must be perfectly symmetrical to avoid any variation in the shape of the peaks or displacement of the base line. The measurement station should include a micro computer and associated peripherals and ensure:

- Complete piloting of the temperature cycles (speed of heating, 1–50°C min<sup>-1</sup> with stabilized voltage, temperature control by means of thermocouples, carrying out instructions, etc.;
- Control of the atmosphere (purging circuits, admission of carrier gas, admission of inert or reactive gases, EGA output, regulation of flows and pressure);

– Simultaneous acquisition of data on temperature and heat transfers with very weak inertia, thermodynamic calculations and print-outs of the results.

As is true for TGA, standardization of the procedures is essential.

### **Sample**

Use a sample of whole soil ground to 0.1 mm (should not be over-ground). Organic matter in humic soils produces a strong exothermic reaction culminating at 300°C (573 K) which obstructs the endothermic peaks of dehydration towards 250–400°C if analysis is carried out in air or in an oxidizing atmosphere. It is consequently better to destroy OM using the procedures described in Chaps. 2 and 3 (or to extract it and use DTA). On whole soil, the peaks are generally of low intensity. Quartz can obstruct, but its peak at 573°C can be used as a marker.

To improve sensitivity, it may be better to use isolated purified and enriched fractions of a given particle size, homoionically saturated in the case of clays and, after air drying, stored in a solution saturated with  $\text{Mg}(\text{NO}_3)_2 \cdot 6\text{H}_2\text{O}$  to maintain constant relative moisture (the size and crystallinity of the particles influence the temperature, size, and shape of the peaks).

*In sandy fractions* (2.0–0.05 mm) primary minerals and concretions rich in iron and manganese can be measured. The endothermic peak of quartz is generally observed at 573°C.

*Silt fractions* (0.05–0.005 mm) often represent a more complex medium: they contain both primary minerals and deteriorated forms and possibly forms of clay minerals  $> 2 \mu\text{m}$ .

*Coarse or fine clays* ( $< 2 \mu\text{m}$ ) often give much more intense and quantifiable peaks than whole soils. Substances with short-distance arrangement (e.g. allophane, ferrihydrites) are found in this fraction. Homoionic saturation by a cation ( $\text{Na}^+$ ,  $\text{K}^+$ ,  $\text{Ca}^{2+}$ ,  $\text{Mg}^{2+}$ ,  $\text{Al}^{3+}$ ) enables certain properties such as levels of hydration to be revealed. The first endothermic reaction of volatilization of the adsorbed water varies with the number of water molecules associated with the cation. The cations affect the size and the shape of the peaks, generally without significantly modifying the temperature at which they appear.

It is possible to mix the clay fraction with alumina to avoid caking, retraction, and cracking of the sample, but this has a diluting effect.

Two clay samples from the same profile can be compared under the same experimental conditions. The reference sample will be then one of the samples. If they are identical,  $\Delta T$  will be equal to 0 and there will be a base line with no peak, as the two samples will cause the same phenomenon to occur at the same time.

### **Reference Material**

The standard must be thermally inert in the temperature range to be used. It must have a thermal conductivity or a thermodiffusivity close to that of the sample. The particle size should be that of soil (ground to 0.1 mm) which allows close contact with the crucibles as well as a favourable bulk density (same proportion of pores near the ground soil).

Generally alumina is used ( $\text{Al}_2\text{O}_3$  calcined at 1,200°C for 1 h). This reference can be used for several measurements, but slight hygroscopicity of the product may be observed after 4 or 5 measurements.

A clay burnt at 1,200°C and then ground can also be used, but problems often occur with respect to the base line. For example between rough kaolinite and kaolinite calcined to mullite at 1,200°C, thermal conductivity will vary by a factor of two and certain reversible reactions may occur. Quartz, magnesia, or aluminium sheets are sometimes used as reference materials.

### **Procedure**

The procedure is similar to classical qualitative or quantitative DTA–DSC analysis, and takes into account the factors mentioned earlier.

- Weigh on the laboratory balance ( $\pm 1/100$  mg) a given mass of sample (1–100 mg), suited to the characteristics of the apparatus and an identical quantity of inert reference; for DSC with power compensation, an empty crucible similar to that used for the sample can be used as inert reference.
- Pack as homogeneously as possible in platinum crucibles.
- Find the optimal position for the crucibles (in suitable supports) with respect to the thermocouples and the most homogeneous zone of the furnace.

- Cover the crucibles with a lid if required (the displacement of evolved gas will be modified).
- Regulate the speed of linear increase in temperature; higher speed can increase some peak temperatures, but can also improve sensitivity (peak height); generally the range is between 5 and 20°C min<sup>-1</sup> but certain materials allow speeds of 0.1–200°C min<sup>-1</sup> (it is also possible to use the reverse technique with recording during cooling).
- Adjust the atmosphere of the furnace taking into account possible analysis of the gaseous phase by interfacing with EGA.

Software packages can monitor and control operating conditions including calculations and printing out the results, in this case all the parameters are optimized.

### ***Interpretation of the Results***

**Table 7.5.** Main thermal effects on the clays of soils

range of temperature (°C)	signals
50–250	endothermic peaks loss of absorbed water, interlayer water (e.g. allophanes, halloysite, smectite)
400–700	exothermic and endothermic peaks crystallisation reactions (e.g. gels of iron or aluminium oxides) diagnostic peaks of the crystalline forms reactions of dehydroxylation
900–1050	exothermic peaks reaction of nucleation or recrystallization (e.g. kaolinite-chlorites)

The same procedure is used for rough samples and extracted fractions of different degrees of purification under inert or reactive atmosphere depending on the nature of the sample studied.

“Pure” standard minerals or minerals in known mixtures (90:10, 80:20%, etc.) can be treated to trace the calibration lines with the same criteria thus enabling quantification of the samples (a reference set of laboratory minerals is necessary).

A distinction must be made between clay minerals from sedimentary deposits whose peaks are generally well defined and minerals from different soils after purification and concentration.



First, well-defined peaks are identified (e.g. the endothermic peak at 500°C and the exothermic peak towards 900°C for kaolinite). The shape of the peaks is an indicator of the thermal process: fusion results in a narrow endothermic peak, decomposition often produce a broad endothermic peak which is often asymmetrical, a second-order transition results in only a slight inflection. Certain minerals give well-defined peaks that are used as markers of characteristic transitions in the thermal programme.

The slope of the base line and the magnitude of the peaks should be taken into account. The main thermal transitions observed in clays are listed in Table 7.5. The “low temperature” zone provides information on adsorbed water and on the presence of certain clays and amorphous substances. The medium temperature zone shows peaks resulting from the predominant influence of crystallinity. Finally the high temperature zone shows phenomena such as nucleation or recrystallization of clays.

Certain standards are used in quantitative analysis like  $\text{CaSO}_4 \cdot 2\text{H}_2\text{O}$  to enable calculation in millicalories per unit of area (calibration between a peak surface and a known emitted or absorbed heat).

Each type of structure can be identified by a characteristic thermal curve (Fig. 7.8). For clays, purification is necessary to limit the artifacts caused by impurities which are likely to be superimposed in the same temperature zone.

Clays with a tetrahedral layer and an octahedral layer will display phenomena related to the decomposition of the octahedral layer. The exothermic volatilization of hygroscopic water may be accompanied by a recombination of the elements of the tetrahedral and octahedral layers.

Quantitative DTA is possible for clays presenting endothermic peaks associated with loss of water bound to the crystal. This is the case of 1:1 clays like kaolinite, but 2:1 clays like montmorillonite, vermiculite, or illite are difficult to quantify with this method.

Deferrification reinforces the exothermic peaks of kaolinite, and iron inhibits exothermic phenomena. The presence of carbonate, organic matter, and alkaline ions must be taken into account. Hydroxides initially present loss of water, and then contraction linked to decomposition of the lattice.

The heights of peaks are faster to use than the surfaces of peaks and can thus be used for approximations. Thermodynamic calculations use all the spectral information as well as the quantities of evolved water measured in TGA.

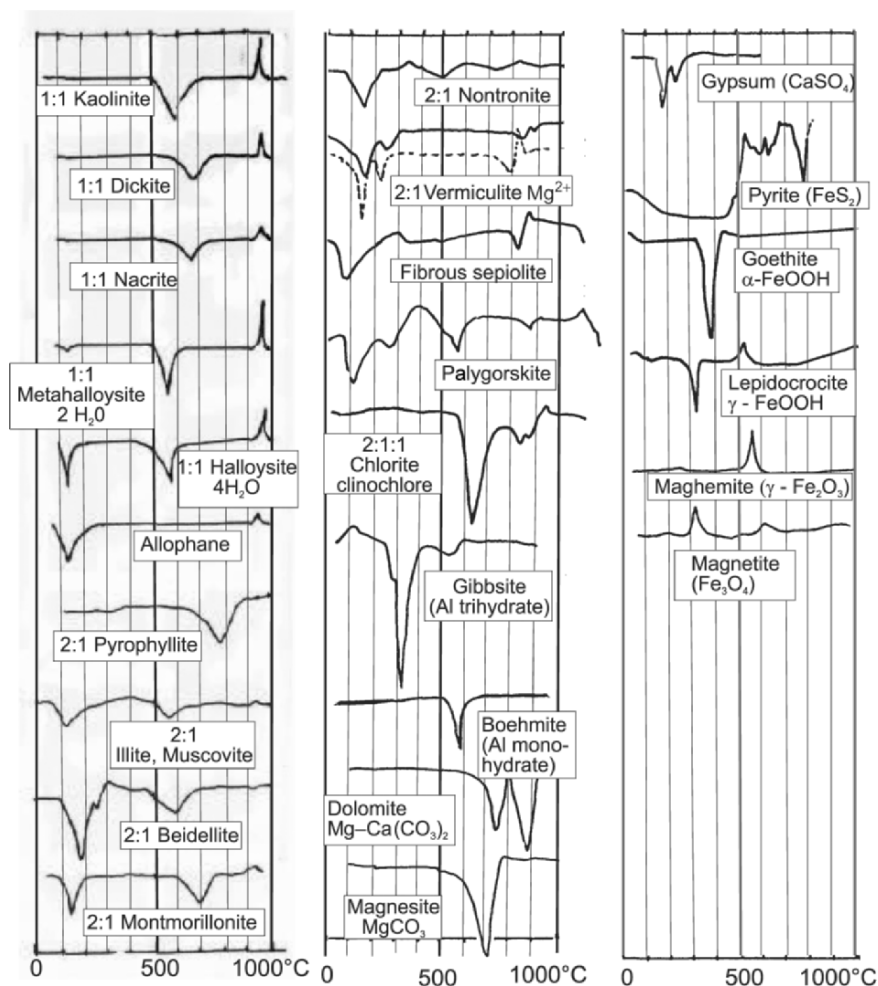

**Fig. 7.8.** Examples of DTA thermal diagrams on soil minerals (J Gautheyrou, set of reference standards from IRD Bondy, France, unpublished data)

In DSC, the curves are proportional to the enthalpy:

$$\text{peak surface} = m \Delta H/k$$

$\Delta H$ ; heat of transition;  $m$ ; reactive mass;  $k$ ; coefficient of calibration (independent of the temperature measured by DSC with power compensation).

## 7.3 Multi-component Apparatuses for Thermal Analysis

### 7.3.1 Concepts

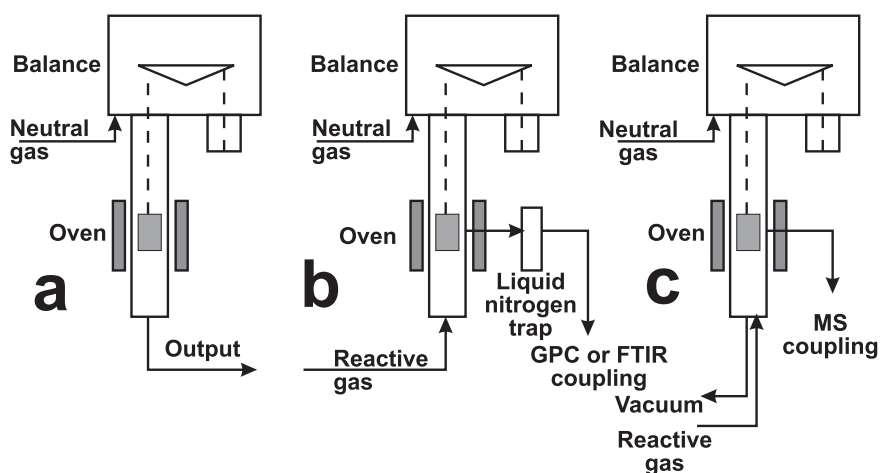

**Fig. 7.9.** Example of gas sweeping devices for TGA or TGA–DTA. (a) Simple displacement by a neutral carrier gas crossing the balance and protecting it from corrosion; (b) system with two gases – one neutral and one reactive – with horizontal sweeping of the sample; and (c) system with purging by vacuum and later sweeping by neutral gas or neutral gas + reactive gas

The development of new apparatuses was based on several different concepts. In multi-component equipment, several dedicated apparatuses are run by a management station and measurement is computerized. This type of multi-function equipment enables multiple measurements on the same sample subjected to a thermal profile with controlled atmosphere and pressure. Suitable sensors can measure TGA, DTG, DTA and DSC simultaneously thus reducing the time required for analysis, increasing precision and allowing more thorough characterization.

Automated introduction of the samples in the furnace is useful in the case of equipment with a cooling cycle of less than 30 min (return to ambient temperature after heating to 1,700°C).

Certain dedicated measurement peripherals can also detect or quantify evolved gas. This quantification is essential to complete certain DTA spectra (e.g. simultaneous exothermic and endothermic reactions).

The methods selected can be programmed and used in sequence, providing a powerful reference frame, e.g. for the identification of clays and the study of transformations in structure, recrystallization, forms of water, thermal stability or thermal oxidation.

### 7.3.2 Coupling Thermal Analysis and Evolved Gas Analysis

The analysis of emitted or emanating gas may require coupling of equipment of varying degrees of complexity. A small furnace with an open configuration should be used that is able to ensure rapid evacuation of decomposition gases (Fig. 7.9). The circulation of a carrier gas and the possible presence of reactive gases causes changes in pressure and convection phenomena linked to pressure and local temperatures (as well as thermomolecular forces able to create heterogeneous temperatures inside the furnace) that are controlled by a system of screens. Below is an overview of the most widely used systems.

*Simple detection of evolved gas (EGD):* a neutral carrier gas draws evolved gas into a catharometer detector; the output signal is proportional to the concentration of evolved gas in the carrier gas. The nature of the evolved gases is not identified. It is possible to trap the heavy products in liquid nitrogen, and then to subject these products to further analysis, for example controlled pyrolysis by thermal analysis.

*Analysis of evolved gas (EGA)* can be performed by coupling equipment of varying complexity. Gas chromatography, coupled with simultaneous TGA-DTA equipment, makes it possible to characterize evolved gas by automatic discontinuous injections (it is also possible to trap the fractions that are not analyzed in liquid nitrogen). Integration of the peaks makes it possible to quantify evolved and separated gas as a function of their retention times.

*Coupling a Fourier transform infra-red spectrometer (FTIR)* enables analysis of time of flight thanks to the speed of acquisition and the sensitivity of FTIR. A flow of nitrogen automatically transfers the evolved gases towards the spectrometer. Resolution is about  $4\text{ cm}^{-1}$ . Each temperature point is stored in a numerical file corresponding to the number of the selected wavelength at this point. Water is identified in the  $3,600$  and  $1,600\text{ cm}^{-1}$  zones, CO and CO<sub>2</sub> in the  $2,000$  to  $2,400\text{ cm}^{-1}$  zones.

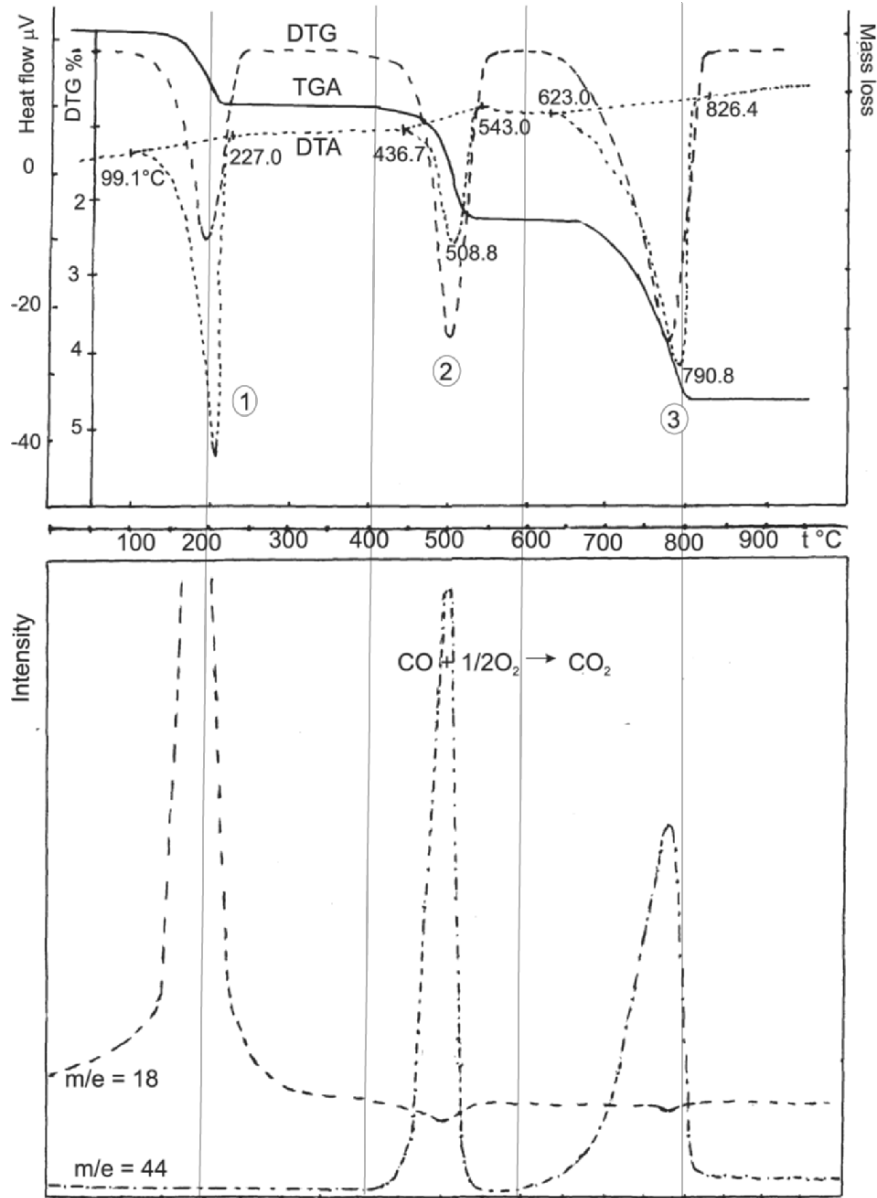

**Fig. 7.10.** Decomposition of the standard calcium oxalate ( $\text{CaC}_2\text{O}_4, \text{H}_2\text{O}$ ) studied by coupling TGA, DTG and DTA (at the top) and mass spectrometry (at the bottom) atmosphere, air; speed of heating,  $5^\circ\text{C min}^{-1}$ , sample mass, 50 mg.

1.  $\text{CaC}_2\text{O}_4, \text{H}_2\text{O} \rightarrow \text{CaC}_2\text{O}_4 + \text{H}_2\text{O}\uparrow$  (12.2%  $\text{H}_2\text{O}$ )
2.  $\text{CaC}_2\text{O}_4 \rightarrow \text{CaCO}_3 + \text{CO}\uparrow$  (19.1%  $\text{CO}$ )
3.  $\text{CaCO}_3 \rightarrow \text{CaO} + \text{CO}_2\uparrow$  (30.1%  $\text{CO}_2$ )

*Coupling with a mass spectrometer* is very powerful, but difficult to implement, as the mass spectrometer operates under a vacuum of about  $10^{-5}$ – $10^{-6}$  mbar. Interfacing with the thermal analyzer is achieved by means of double stage separators. A quadripole mass spectrometer enables rapid scanning in the mass range of evolved gas up to approximately 100, including  $^{12}\text{C}$ ,  $^{16}\text{CH}_4$ ,  $^{28}\text{CO}$ ,  $^{44}\text{CO}_2$ ,  $^{18}\text{HOH}$ ,  $^{16}\text{O}$ ,  $^{32}\text{O}_2$ ,  $^{34}\text{H}_2\text{S}$ ,  $^{64}\text{SO}_2$ ,  $^{80}\text{SO}_3$ . This range is not sufficient for the observation of organic materials resulting from controlled pyrolysis (cf. Chap. 12) as the molecular weights are distributed over a larger range, up to 500 or more.

Figure 7.10 shows analysis of the thermal decomposition of oxalate of calcium, which can be used as a standard for calibration. With a combined mass spectrometer with a relatively low speed of acquisition and air atmosphere, decomposition reaction 2, which gives calcium carbonate and carbon monoxide, gives only one peak at mass 44 ( $\text{CO}_2$ ). With nitrogen atmosphere, formation of a  $\text{CO}$ – $\text{CO}_2$  mixture is observed, showing the beginning of decomposition of the newly formed carbonate. Simultaneous detection of  $\text{CO}$  and  $\text{CO}_2$  can also be achieved by coupling the thermal analyzer with a Fourier transform infra-red spectrometer.

*The analysis of radioactive gases emanating* from rocks in their solid state at different temperatures can be performed by coupling thermal analysis with a detector of  $\alpha$ -particles.

## References

- Allen JA (1966) *Energy Changes in Chemistry.*, Allyn-Bacon Newton, MA
- Braudeau E (1987) Mesure automatique de la rétraction d'échantillons de sol non remaniés. *Science du Sol*, 25, 85–93
- Braudeau E (1988) Equation généralisée des courbes de retrait d'échantillons de sols structurés. *Comptes rendus acad. Sci. Fr.*, série 2, 307, 1731–1734
- Braudeau E, Costantini JM, Bellier G and Colleuille H (1999) New device and method for soil shrinkage curve measurement and characterization. *Soil Sci. Soc. Am. J.*, 63, 525–535
- Braudeau E, Frangi JP and Mothar RH (2004) Characterizing non-rigid dual porosity structured soil medium using its characteristic shrinkage curve. *Soil Sci. Soc. Am. J.*, 68, 359–370

- Duval C (1963) *Inorganic Thermogravimetric Analysis.*, Elsevier. Amsterdam. 2ème édition
- Garrels RM and Christ CL (1965) *Solutions, Minerals and Equilibra.*, Harper-Row New York
- Gray AP (1968) *Symposium Analytical Chlorimetry*, Porter R.S. and Johnson JF ed., Proc. Am. Chem. Soc., Plenum New York, 209
- Kotra RK, Gibson EK and Urbancic MA (1982) *Icarus.*, 51, 593
- Mackenzie RC (1970) *Differential Thermal Analysis.* Academic London. Vol. 1.
- McNaughton JL and Mortimer CT (1975) La calorimétrie différentielle à balayage. *Butterworth, Physical Chemistry.*, Série 2, 10. 43 pages
- Miller B, Giuham JM, Brennan WP, Nentzer C and Whitwell JC (1973) *Thermochim. Acta*, 5, 257
- Pansu M, Gautheyrou J and Loyer JY (2001) – *Soil analysis – sampling, Instrumentation and Quality Control*, Balkema Amsterdam, Lisse, Abington, Exton, Tokyo, 512 p
- Rouquerol J (1970) L'analyse thermique de décomposition construite. *J. Therm. Anal.*, 2, 123–140
- Rouquerol J (1989) Reciprocal thermal analysis. The hidden face of the thermal analysis. *Thermodyn. Acta*
- Rouquerol F, Rouquerol J, Thevand G and Triaca M. (1985) Desorption of chemisorbed species: its study by controlled rate thermal analysis. *Surf. Sci.*, 239–244
- Rouquerol J, Rouquerol F, Grillet Y and Ward RJ (1988) A critical assessment of quasi equilibrium as adsorption techniques in volumetry gravimetry, calorimetry. In *Characterization of Porous Solid*, Kungér KK ed., Elsevier Amsterdam, 67–75
- Watson ES, O'Neill MJ, Justin J and Brenner N (1964) DSC. *Anal. Chem.*, 36, 1233

## Bibliography

- Bang DV and Atanasov I (1984) Thermal characteristics of the clay fraction of soils overlying zeolites. *Pochvoznanie i Agrokimiya*, 19, 58–65
- Barshad I (1965) Thermal analysis techniques for mineral identification and mineralogical composition. In *Methods of Soil Analysis*, Part 1., Black C.A. ed., A.S.A., S.S.S.A., 9, 699–742
- Bishop JL, Banin A, Mancinelli R and Klovstad MR (2002) Detection of soluble and fixed  $\text{NH}_4^+$  in clay minerals by DTA and IR reflectance spectroscopy: a potential tool for planetary surface exploration. *Planetary Space Sci.*, 50, 11–19
- Brennan WP (1974) Application of differential scanning calorimetry for the study of phase transitions. In *Analytical Calorimetry*, Porter RS and Johnson JF ed., Plenum New York
- Caillere S and Henin S (1963) *Mineralogie des argiles.*, Masson Paris
- Daniels T (1973) *Thermal Analysis.*, Kogan Page

- Dunn JG (1980) L'analyse thermique, une technique de centrale de qualité dans les industries de l'argile, des céramiques et des verres. *Silicates Industriels*, 10, 203
- Duval C (1953) *Inorganic Thermogravimetric Analysis.*, Elsevier Amsterdam. 1st edition
- Earnest CM (1983) Thermal analysis of Hectorite. Part II. Differential thermal analysis. *Thermochim. Acta.*, 63, 291–306
- Emmerich WD and Kaisers Berger E (1979) Simultaneous TG-DTA mass-spectrometry to 1550°C. *J. Therm. Anal.*, 17, 197–212
- Ferenc Paulik (1995) *Special Trends in Thermal Analysis.*, Wiley New York, 478 p
- Fordham CJ and Smalley IJ (1983) High resolution derivative thermogravimetry of sensitive clays. *Clay Sci.*, 6, 73–79
- Gallagher PK (Ed.) (1998) *Handbook of Thermal Analysis and Calorimetry.*, Elsevier
- Garn PD (1965) *Thermo Analytical Methods of Investigation.*, Academic London
- Giovannini G and Lucchesi S (1984) Differential thermal analysis and infra-red investigations on soil hydrophobic substances. *Soil Sci.*, 137, 457–463
- Hatakeyama T and Zhenhai Lui (Ed.), (1998) *Handbook of Thermal Analysis.*, Wiley New York
- Keyser de WL (1953) Differential thermobalance: a new research tool. *Nature*, 172, 364
- Khanafer K and Vafai K (2002) Thermal analysis of buried land mines over a diurnal cycle. *IEEE Trans. Geosci. Remote Sensing*, 40, 461–473
- Lombardi G (1984) Thermal analysis in the investigation of zeolitized and altered volcanics of Latium, Italy. *Clay Miner.*, 19, 789–801
- Mackenzie RC (1963) SCIFAX, *Differential Thermal Analysis Data Index.*, Cleaver-Hume Press
- Mackenzie RC, Keattoh CJ, Dollimore D, Forester JA, Hodgson AA and Redfern JP (1972) Nomenclature in thermal analysis II. *Talanta*, 19, 1079–1081
- Mackenzie RC and Caillere S (1975) The thermal characteristics of soil minerals and the use of these characteristics in the qualitative and quantitative determination of clay minerals in soils. In *Inorganic components*, Giesekeing E. ed. vol. 2, Springer Berlin 529–571
- Madkensie RC and Robertson HS (1961) The quantitative determination of halloysite, goethite and gibbsite. *Acta Univ. Carol. Geol. Suppl.*, 1, 139
- Maizenberg MC, Karpachevski LO, Markovich MN and Kurakof VN (1991) The use of differential scanning calorimetry in soil studies. *Moscow Univ. Soil Sci. Bull.*, 46, 31–34
- Muller F, Drits V, Plancon A and Robert JLL (2000) Structural transformation of 2:1 dioctahedral layer silicates during dehydroxylation–rehydroxylation reactions. *Clays Clay Miner.*, 48, 572–585
- Murphy CB (1962) Differential thermal analysis. A review of fundamental developments in analysis. *Anal. Chem.*, 298–301
- Paulik F, Paulik J and Arnold M (1984) Simultaneous TG, DTG, DTA and EGA technique for the determination of carbonate, sulphate, pyrite and organic materials in minerals, soils and rocks. II – Operation of the



- thermo-gaz-titrimetric device (TGT) and examination procedure. *J. Therm. Anal.*, 29, 333–344
- Poerschmann J, Görecki T and Parsi Z (2005) Analytical non-discriminating pyrolysis in soil analysis. *LabPlus Int.*, 19, 8–14
- Sarikaya Y, Onal M, Baran B and Alemdaroglu T (2000) The effect of thermal treatment on some of the physicochemical properties of a bentonite. *Clays Clay Miner.*, 48, 557–562
- Schnitzer M and Kodama H (1972) Differential thermal analysis of metal-fulvic acid salts and complexes. *Geoderma*, 7, 93–103
- Schomburg J (1991) Thermal reactions of clay minerals: their significance as “archaeological thermometers” in ancient potteries. *Appl. Clay Sci.*, 6, 215–220
- Schultze D (1969) *Differential Thermo-Analysis.*, Verlag
- Smothers WJ and Chiang YZO (1966) *Handbook of Differential Thermal Analysis.*, Chem. Publ. Co.
- Smykatz-Kloss W and Heide K (1988) Progress of thermal analysis in earth Sciences. *J. Therm. Anal.*, (GBR) 33, 1253–1257
- Taichev T, Konishev P and Donovan D (1984) Application of thermal analysis in studies on the structural evolution of humic substances. *Pochvoznanie i Agrokimiya*, 19, 82–87
- Tan KH and Clark FE (1969) Polysaccharide constituents in fulvic and humic acids extracted from soil. *Geoderma*, 2, 245–255
- Tan KH, Hajek BF and Barshad I (1986) Thermal analysis techniques. In *Methods of soil analysis*, Klute A. ed., A. S.A., S.S.S.A., 9, 151–183
- Trofimov SA, Tolpeshta II, Sokolova TA (1999) A study of plant material and organic soil horizons using thermal analysis techniques. *Pochvovedenie*, 54, 3–9
- Van Olphen H and Fripiat JJ (1979) *Data Handbook for Clay Minerals and Other Non-Metallic Minerals.*, Pergamon New York, 350 pages
- Wendlandt WW (1974) *Thermal Methods of Analysis*, Part 1. Wiley New York

## Microscopic Analysis

### 8.1 Introduction

The study of the processes of genesis and weathering of the soils and the characterization of minerals require observations at different spatial and temporal scales. Pedon, horizon, macro- and micro-samples are used as a basis for a range of examinations in which microscopy techniques enable observation of the interfaces of the different phases and even of the ultimate stages of molecular assemblies. Complementary analytical probes enable in particular determination of the chemical nature (e.g. energy dispersive X-ray, EDX or wavelength dispersive X-ray, WDX analysis) and the structural organization (electron micro-diffraction) of these phases.

Whereas classical wet chemical analyses provide information on overall evolution, microscope analyses enable identification of hyperfine chemical heterogeneity and facilitate understanding of transformation mechanisms. Qualitative and quantitative information is obtained on the texture of individual particles, e.g. shape, the presence of cements, inclusions, pores.

Detailed morphological analysis (spatial relations of the different phases, preferential orientation, etc.) is performed by coupling a microscope to an image or texture analyser, and analysing thin sections to reveal the cartography of chemical segregation, micro-profiles, and to improve our knowledge of pedogenesis.

The crystalline structure can be identified by changing scale: i.e. by studying the elementary mesh of clays, regular sequences of silicates in layers, modifications of the basal interlayer, the appearance of aperiodisms, defects, micro-cleavages, growth steps, gels with short-distance atomic arrangements near source crystals which bring about the transformation of one mineral into another at the nano-structural scale. Electron micro-diffraction, which is available on the majority of electron

microscopes, enables identification of crystalline structures. All these options make microscopy an extremely powerful tool.

Optic and electronic microscopy and the accompanying peripherals used to determine chemical distribution within the sample are widely used in pedology, mineralogy, crystallography, petrography, metallography, and clay geology, and provide precise information on the mechanical properties, localization of surface charges and exchange properties of the soils.

However, it is extremely important to think about the validity of the observations and to adapt the scale of measurement to the exact requirements of the sample. Sampling conditions and the different stages of sample preparation should always be specified. The season should also be taken into account (samples taken in a wet or dry season present very different pore spaces in soils rich in 2:1 clay). Not only pedogenesis and geostatistics but also geomorphology must be used (the samples may require complementary sampling of the evolution of a profile, or sampling at a larger scale to account for the homogeneity of a zone). When the observations are made, it is important to be aware of the physical and chemical processes that can modify a sample and lead to erroneous results (e.g. contamination, oxidation, neoformation). It is also important to explore the full potential of the equipment, as the full capacity of apparatuses is frequently underexploited.

Electron beams can damage the surface of materials. The depth of penetration of radiation may be limited to near the surface: i.e. approximately 1–3 nm, or on the contrary, may gradually erode the surface resulting in a concentration of profiles (e.g. in plasma bombardment, secondary ion mass spectrometry).

As is true for all methods, the calibration of measurements is essential and requires a reference set of sample observations that will allow comparison with known and clearly identified situations.

## **8.2 Preparation of the Samples**

### **8.2.1 Interest**

Visual examination, followed by examination with a magnifying glass is not enough as it only enables a rough estimate of modes of assembly and physical properties. This type of examination is consequently always supplemented by tactile examinations and other sensorial and chemical tests (described in Pansu et al. 2001).

Observations can be made under an optical or electron microscope on soil samples that have undergone treatments such as:

- purification, concentration, quantitative separation into classes of particle size
- separation in heavy liquids of increasing densities, up to  $d = 4.28$  at  $20^{\circ}\text{C}$  (e.g. bromoforme, tetrabromomethane, di-iodomethane, Clerici solution)
- magnetic separation in a Frantz magnetic separator (or similar).

In this case, individual particles are measured (shape, nature, relative proportions of minerals, effects and nature of weathering). To obtain precise information on assemblies, thin sections have to be prepared on glass slides making it possible to study soil transformation and to link this information with field observations.

$28 \times 48$  mm petrographic slides are the most widely used, but  $110 \times 76$  mm or even  $200 \times 180$  mm Mammoth slides are also useful for micro-pedological and micro-morphological studies (however, these are very delicate operations).

### 8.2.2 Coating and Impregnation, Thin Sections

#### ***Principle***

The term coating is generally used in the case of massive compact samples with simple geometry, such as pieces of hard stone which can be embedded in a resin that hardens rapidly and facilitates preparation for analysis.

The purpose of impregnation with resin is to consolidate soft porous rocks, products of rock deterioration and soils (Delvigne 1998) for which cohesion is required. Wet soils must be dried in a way that avoids modifying the structure of the sample by contraction or the appearance of cracks due to shrinkage. One way to limit this phenomenon in soils rich in 2:1 clays with low porosity is to saturate the sample with sodium chloride before desiccation by freeze-drying.

For soils rich in allophanes with a water storage capacity reaching 250% of dry soil, water can gradually be replaced by acetone, or dioxane. This technique is also applicable on clay soils, but in this case, samples treated with acetone are more fragile than those treated with dioxane (Tessier 1985). Acetone and dioxane are compatible with certain resins used for impregnation.

Freeze-drying generally preserves the features of the sample better than oven or air drying. For small samples (approximately  $30 \text{ cm}^3$ ) the

use of a dehydration apparatus at CO<sub>2</sub> critical point gives excellent results. For bulky wet samples, the use of epoxy resins that are soluble in water is one possible solution (Moran et al. 1989).

Preparing the thin section slides manually is very time consuming and considerable technical skill is needed to obtain thin sections of quality with the required degree of transparency and a uniform thickness of between 20 and 30 µm. Automation of coating and impregnation, slicing, and polishing is possible, but requires a high initial investment which can only be amortized by at least 60 coatings or 40 impregnations per week, i.e. approximately 2,000 slides of format 28 × 48 mm per year. Some computer-controlled modular systems enable automated production of super-thin sections 10 µm thick, with 0.25 µm polishing if required. Standard slides are 30 µm thick with approximately 1 µm polishing. (Fig. 8.1)

It is often preferable to have the thin section slides made in specially equipped laboratories because of the need for explosion-proof electric circuits, vapour evacuation circuits with solvent traps, plus the cost of maintenance of the equipment and the instability of the resins.

### **Equipment**

- Laboratory equipped with a fume hood (with non-deflagrating electric apparatuses)
- combined system for grinding and polishing with a disc 250 mm in diameter
- cutting saw with a diamond grinding stone 350 mm in diameter
- equipment for cold impregnation and coating under vacuum: desiccator 300 mm in diameter with a vacuum stopcock and a device for admission of the mixture of resin + catalyst
- vacuum pump with pressure gauge (0–750 mm Hg)
- ultrasound tank
- drying oven with ventilation (up to 100°C)
- stylograver with a tungsten carbide point
- petrographic glass slides, size 28 × 48 mm, 1.2 mm thickness
- glass sheets 0.13 mm thick for use as slide covers
- boxes for thin section slides
- ultramicrotome with thermally regulated system of displacement
- freeze dryer
- vacuum desiccators with drying products such as silica gel
- binocular microscope
- small equipment such as glass slab, aluminium sheet, grips
- refrigerator (to store resins)

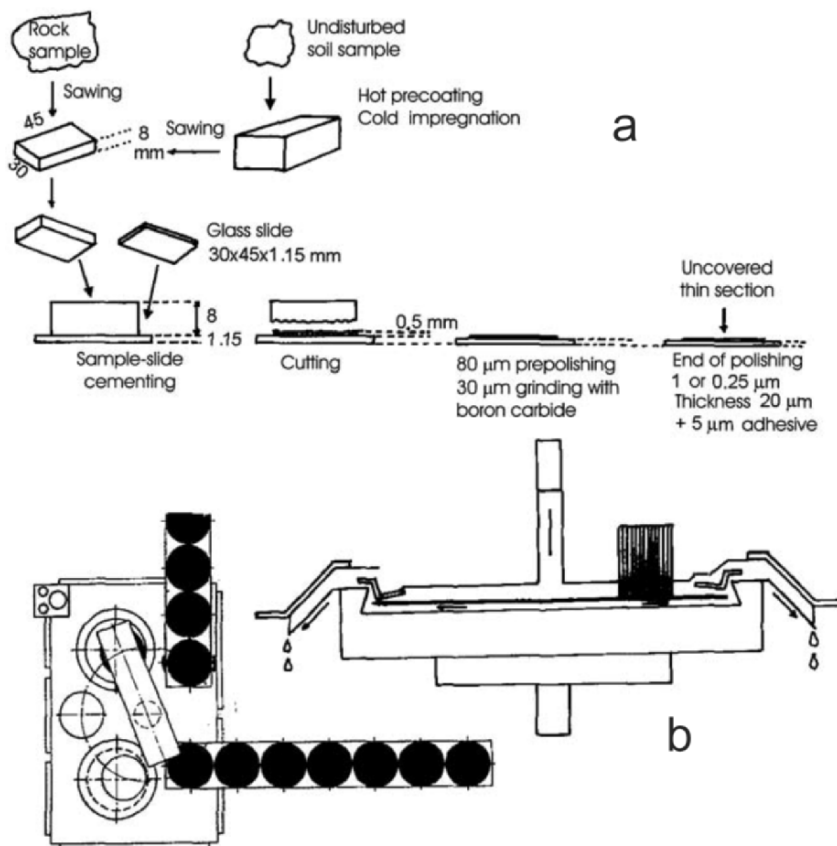

**Fig. 8.1.** (a) Preparation of thin section slides (equipment and materials required: resins, press, coating, UV polymerization apparatus, grinding stone cutting saw, grinding polishing machine) (b) Computer controlled station for automated modular preparation (Struers)

### **Materials and Reagents**

- Silicon carbide sheets (Carborundum–SiC) MOHS hardness: 9
- boron carbide sheets ( $B_4C$ ) MOHS hardness: 9
- corundum sheets (Alumina –  $Al_2O_3$ ) MOHS hardness: 9
- diamond sheets (range of particle sizes)
- polishing cloth
- diamond water–ethanol soluble pastes and sprays: 3, 1, 0.25  $\mu m$
- cold epoxy resins + hardener + catalyst + thinner
- acrylic resins with low shrinkage rate
- cold polyester resins
- dyestuff for resin

- canada balsam (+xylene)
  - lubricants and solvents: glycerol  $\text{HOCH}_2\text{--CH(OH)CH}_2\text{OH}$ , oil, ethanol, O-xylene  $\text{C}_6\text{H}_4(\text{CH}_3)_2$ , styrene  $\text{C}_6\text{H}_5\text{CH=CH}_2$ , 1-4 dioxane, acetone, 99% diethylene triamine  $\text{H}_2\text{N--CH}_2\text{CH}_2\text{NH--CH}_2\text{CH}_2\text{NH}_2$
  - silicone grease for grinding
- The choice of a resin will depend on its:
- refraction index (near 1.54)
  - solubility in an organic solvent or water
  - low level of contraction and low viscosity
  - polymerization conditions
  - hardness and strength at the required temperature particularly for observations and quantifications by electronic microscopy of the SEM and EDX type.

### **Procedure**

#### ***Compact Hard Samples (Rocks)***

Petrographic techniques are described in detail by Hartshorne and Stuart (1970).

The sample is suitably oriented and sawn on one face, then gradually polished and finally stuck on a petrographic slide of format  $28 \times 48$  mm (1 in.  $\times$  2 in.). After sawing off a section 2–3 mm thick parallel to the stuck face, thin to 30  $\mu\text{m}$ . Polish the thin section to 1  $\mu\text{m}$ . The thin section slide can be protected from abrasion and oxidation by being stuck onto a thin glass sheet with Canada balsam. The slide should not be covered if subsequent tests require specific dyes, chemistry (elimination of carbonates) or samples are required for SEM-EDX measurements.

#### ***Frangible, Porous or Fissured Samples***

Samples removed in the field with their natural moisture using cylinder or monolith methods of soil analysis (Pansu et al. 2001) are often oriented vertically in the profile or possibly oriented according to the field slope (Fig. 8.2), these should be stored in airtight boxes then used to produce the  $28 \times 48$  mm standard or Mammoth slides.

Whenever the block is being cut during preparation, the direction of the field micro-section should be taken into account (Fig. 8.2). The sample is dried by freeze-drying or by replacing the water with acetone or dioxane. Slight contraction will allow the sample to be released from the mould unless the system of sampling with two half-cylinders is used.

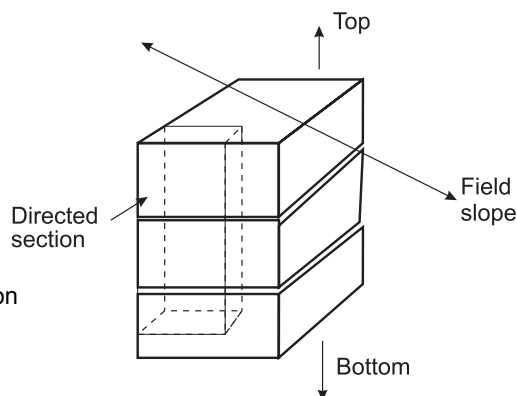

**Fig. 8.2.** Pedological micro-section

The block should be cut into a rough square with a cutter to reduce its thickness and, depending on the chosen orientation, deposited in a semi-flexible plastic mould (in practice, the bottom of the mould corresponds to the bottom of the profile).

#### *Impregnation*

Place the block of soil with its mould in a vacuum desiccator with a ground lid lubricated with silicone grease. Put the desiccator under vacuum at approximately 60 cm Hg (or more) depending on the boiling point of the solvent and the resins. The soil should be degassed for 30 min.

In a flexible plastic container, quickly mix the resin with the hardener (in the proportions recommended by the manufacturer) and the same volume of solvent to fluidify the mixture. Pour the resin mixture into the funnel at the top of the desiccator. Introduce the mixture gradually while monitoring vacuum, input flow and the rise in the level of the impregnation liquid until the sample is completely covered (plus one cm to allow for subsequent retraction of the resin). The mixture must also flow around the sample, and impregnation should take place upwards by capillarity. Depending on the porosity and size of the sample, 5–8 hours are often needed for  $48 \times 28$  mm slides.

Break the vacuum with care and transfer the sample under a fume hood. The thinner will take approximately one week to evaporate. The product becomes increasingly viscous, and then starts to harden (this will take about a month depending on the resin and dilution). Put it in a ventilated drying oven at  $45^{\circ}\text{C}$  for 2 or 3 days until the sample is no longer sticky. Unmould it respecting the orientation.

#### *Cutting*

Place the block on a bed of coloured resin (approximately 2 mm thick) that hardens rapidly in order to be able to identify the bottom of the soil



profile. Saw the hardened impregnated block according to the preferential orientation (a slight notch can be cut in the side of the block to identify the direction of the field slope).

The circular saw should be lubricated with a solvent that cannot dissolve soluble salts and should be compatible with the resin and with any chemical analyses to be performed later on. When impregnation appears to be complete, cut the block into parallel sections 5–6 mm thick. Each section should match the format of the petrographic slides. Rapidly check the quality of the surface for impregnation defects like cracks or flatness. The surface may need to be impregnated again after cleaning with alcohol and compressed air. Using a spatula, coat the section with a mixture of resin plus catalyst and place it on a flat glass block; cover it with a thin aluminium film pressing to exclude any air bubbles. After solidification, uncover the sample, trim it with a scalpel and leave it to harden in a ventilated drying oven at 45°C. The section is then ready for polishing.

Using a silicon carbide abrasive disc with a rather coarse particle size, polish until almost complete abrasion of the re-impregnation layer, then, after cleaning with a blast of compressed air, continue polishing with a sequence of diamond abrasive paste of increasing smoothness (6, 3 and 1  $\mu\text{m}$ ). The surface must be perfectly smooth with no abrasions and no residues of the re-impregnation film. The material will look dull on the polished resin.

#### *Sticking the Sample on a 48 × 28 mm Petrographic Slide*

Clean the slide with solvent and dry. Write the slide number with India ink. Mix the resin used to fix the sample with hardener (at 60°C or cold depending on the nature of the sample and of the resin). With a spatula apply the resin to one surface of the holder slide and to the polished section of sample, and then rotate the two faces slowly one against the other moving them very gently to push out any excess adhesive and eliminate air bubbles. Allow to harden and trim the edges. After 48 hours, smooth the external face of the sample by sawing it to approximately 300  $\mu\text{m}$  thickness, then by polishing it with set of diamond powders of decreasing particle size until reaching 30  $\mu\text{m}$  (the usual thickness of thin slides for optical observation gives an orange birefringence in quartz). Each time the particle size of the diamond paste is changed, carefully clean the slide to eliminate all coarse particles which could scratch it. If minerals that are rich in iron are abundant, 30  $\mu\text{m}$  is not thin enough to enable observation and it is necessary to reduce the section to approximately 20  $\mu\text{m}$  to make it sufficiently transparent.

For scanning electron microscopy or EDX probes, the final polishing should be done with a 0.25  $\mu\text{m}$  diamond paste. For high resolution

transmission electron microscope observations, the glass support should be removed and the thickness of the micro-zones (diameter 3 mm) reduced, these should be separated and cut with a scalpel. An argon gun is used for thinning. For observation of minerals oriented in the same plane as the slide, a microtome can also be used for cutting. Micro-diffraction will provide some information, but interpretation is often difficult on very thin samples.

Separation on slides of micro-particles of about 50–100  $\mu\text{m}$  is possible with an ultrasound probe equipped with a carbon needle on a micro-manipulator; the slide is observed on a reversed optical microscope. Micro-particles are placed on a silicon plate and are analysed by XRD with slow scanning. The resulting spectra are compatible with angular spaces and standard intensities.

### 8.2.3 Grids and Replicas for Transmission Electron Microscopy

#### *Principle*

The samples can only be observed in transmission electron microscopy if they are less than 1  $\mu\text{m}$  thick and if they are assembled on very thin conducting films. The object subjected to electron bombardment must be crossed by the electron beam. The acceptable thickness depends on the energy of this beam i.e. approximately 0.2  $\mu\text{m}$  penetration at 50 kV, and 3–4 times higher at 100 kV.

The beam–matter interaction heats the sample–target which can cause volatilization of the pore water; the morphology of halloysites is then seriously damaged and there will be contamination of the gun of the microscope. With elements of higher atomic number, heating can be very intense (fusion, phase shift, sublimation, destruction of supporting film).

The supporting film should be transparent to the electrons, sufficiently solid to support the sample, resistant to heat and to electrostatic charges; it should be no thicker than about 100 Å.

#### *Reagents*

- Polyvinyl formal (FORMVAR,  $n_D^{20}$ : 1.50)
- dichloroethane,  $\text{Cl}-\text{CH}_2-\text{CH}_2-\text{Cl}$
- 0.15% FORMVAR in dichloroethane solution;
- COLLODION (nitrate of cellulose or pyroxylyene  $\text{C}_{12}\text{H}_{16}\text{N}_4\text{O}_{18}$ )
- amyl acetate ( $\text{CH}_3-\text{CO}_2-\text{C}_5\text{H}_{11}$ ) or butyl acetate ( $\text{CH}_3\text{CO}_2(\text{CH}_2)_3\text{CH}_3$ )
- 1% collodion solution in amyl acetate
- 1% fluorhydric acid in water.

## Equipment

**Fig. 8.3.** Grid of transmission electron microscopy  $\phi$  3 mm (322 meshes) numbers: location of x- coordinate letters: location of y- ordinate

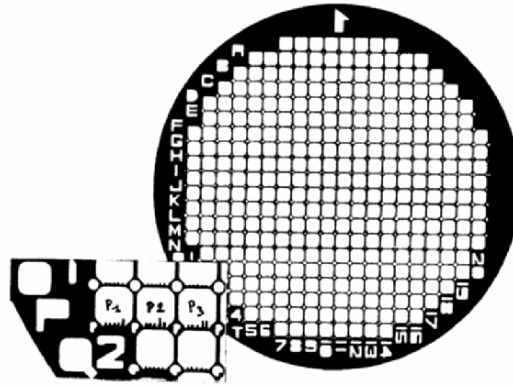

- Lab glassware
- Cu (or Ni) grids 3.05 mm in diameter (Fig. 8.3); these are also available covered with an FORMVAR–carbon film or with a perforated FORMVAR–carbon–gold film enabling direct observation of micro-particles
- 110 mm non-magnetic stainless grips with ultra-fine points
- plastic film for replicas 0.034 mm thick
- micro-drying oven to melt the replicas at 45°C
- sampling loop.

## Procedure

### Grids

- Place the required number of 3 mm grids on a glass slide previously moistened with water. Place the slide in a cupel and very gradually submerge it; the grids should not float
- add a drop of FORMVAR–dichloroethane solution to the surface of the water; the drop should form a very thin film ( $<100 \text{ \AA}$ ) without folds or holes which will solidify in the air after evaporation of the solvent (the film will be thinner if the water temperature is close to 0°C); eliminate the liquid slowly to bring the film into contact with the slide and the grids it covers; let dry then cover the grids with flash carbon which reinforces the film and makes it conducting; when the grids are grey, they are ready to use; check their quality under a binocular microscope

– dilute a drop of sample suspension in water to obtain an almost clear liquid; treat with ultrasound to separate the particles; remove one micro-drop and place it in the centre of the grid<sup>1</sup> the grid should not be turned over during the operation; let dry at air temperature and dehydrate in a critical point apparatus if necessary.

### *Replicas*

Samples which change shape during desiccation are too fragile or too dense to transmit the electrons but can be studied using a one or two-stage replica technique that results in a slight decrease in resolution.

First the sample should be rapidly subjected to directional shading with gold or platinum, then the surface covered with a vertically applied carbon film that is both conducting and resistant.

In this case, cover the sample with a special 0.034 mm thick thermo-fusible film that softens at 45°C and preserves a replica of the surface of the mineral. Dissolve the clay sample with its cover in a diluted hydrofluoric acid solution. The replica remains in the hollows of the sample and can be subjected to gold or carbon treatment (if this has not already been done). Then dissolve the polystyrene film in ethylene chloride. Assemble the carbon replica on a grid and observe using TEM. All these procedures should be carried out with extreme care.

## **8.2.4 Mounting the Samples for Scanning Electron Microscopy**

### *Principle*

The samples may be massive and rough. Depending on the characteristics of the sample vacuum chamber, discs 20 cm in diameter and 4 cm in thickness (8 in. wafers) can be used, but the degasification of large samples is only possible in the case of compact rocks with a limited number of fissures. In practice, it is preferable to use smaller samples. The surface for observation must be a clean break in the sample to enable the study e.g. the plan of cleavage, crystal orientations, defects in the crystal lattice, the presence of occluded impurities.

Surfaces are rendered conducting with flash-carbon or by metallization if micro-probe analysis is not required. Otherwise, if the SEM is

---

<sup>1</sup> The grids should be handled with forceps with ultra-fine points. 0.1 mL microsyringes of the Hamilton type. Flame-drawn hydrophobic glass tubes treated with PROSYL 28 can also be used.

equipped with an EDX or WDX micro-probe, flat, perfectly polished surfaces (0.25  $\mu\text{m}$ ) are required.

### **Equipment**

- Special SEM supports
- storage boxes
- 5  $\times$  5 mm calibration grids with 2  $\mu\text{m}$  squares
- 3 mm carbon slides to mount on SEM supports
- pencil marker for SEM (conducting ink)
- double-face self-adhesive ribbon with low content of volatile elements.

### **Products**

- Silver lacquer
- conducting carbon lacquer
- a set of reference minerals for quantification.

### **Procedure**

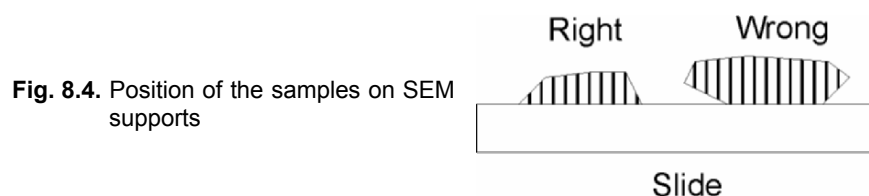

**Fig. 8.4.** Position of the samples on SEM supports

Small samples can be assembled on aluminium supports by sticking them together with silver or carbon lacquer. In certain cases, carbon supports can be used, or plates of 3 mm thickness stuck on aluminium supports. Carbon lacquer is generally preferable for EDX micro-probe analysis. It is essential to locate the samples precisely (e.g. by squaring, marking, or marking the right direction on the support); it is also important to avoid creating a vacuum under the sample (Fig. 8.4) because this causes discontinuity, and elimination of the charges can be disturbed resulting in scratches on the images which renders the photographs unusable. The lacquer should not cover the sample or fill the cracks. After prolonged drying to eliminate solvents, cover the samples with

flash carbon using a metal sprayer with ionic bombardment, or shadow with a metal deposit from an evaporator.

### 8.2.5 Surface Treatments (Shadowing, Flash-carbon, Metallization)

#### *Vacuum Evaporator*

Flash carbon is often used to reinforce the FORMVAR film which supports the samples; it also makes the film conducting. Flash carbon should be applied vertically and uniformly. The micro-samples are sometimes only slightly absorbent and are not very visible in TEM. In this case the sample can be covered with a directional deposit of carbon whose grain is not very apparent, or be metallized with platinum or gold, under a tangential entry. Each space protected by a relief will appear shadowed. Knowing the angle of incidence, it is possible to measure the length of the shadow and deduce the height of the corresponding relief (Fig. 8.5).

**Fig. 8.5.**  
Vacuum  
evaporator  
(shadowing  
with flash  
carbon or  
metal)

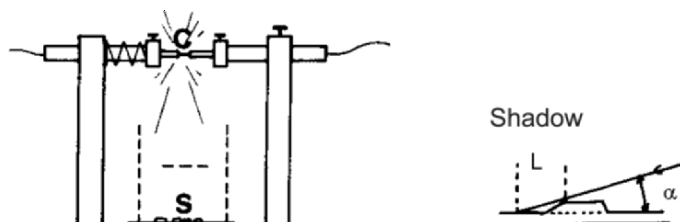

#### *Sputtering Metallization*

The apparatus consists of an anticathode made of gold shaped in a ring whose internal diameter is longer than the length of the sample support. At the centre, a cylindrical magnet is connected to a magnetic field which forms the other pole and surrounds the anticathode (Fig. 8.6). The electrons, which would otherwise overheat the sample, are deviated by the magnetic field.

**Fig. 8.6.** Sputtering metallization apparatus (Bio-Rad – olaron) for SEM samples. N magnet, 1 Au anticathode, 2 sample support, 3 cooling block, filled circle neutral atoms, *open circle* positive ions. When the sample advances in the magnetic field, all sides are bombarded

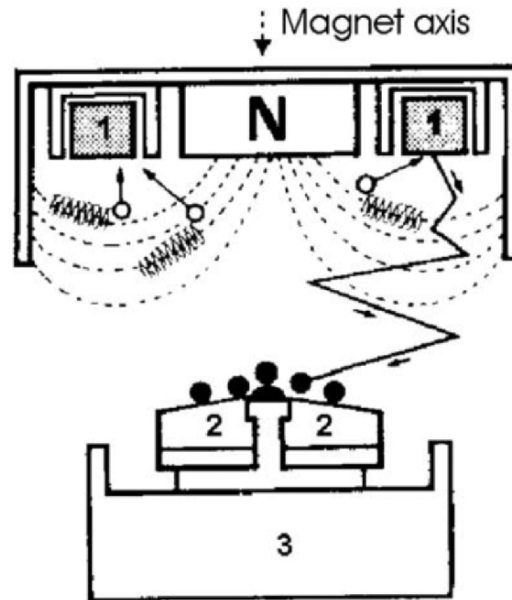

The sample support is cooled to 4°C by a Peltier thermoelectric system. Heating is thus reduced and it is consequently possible to treat organic samples.

The treatments are carried out under  $10^{-1}$  Torr vacuum for 30–180 s. The applied voltage can reach 3 kV. Sweeping with a dry neutral gas (argon) enables elimination of residual traces of water, carbon dioxide, oxygen and possible oil contamination from the vacuum pumps. It is sometimes necessary to degas porous samples for several hours. In this way contamination is limited, but it is nevertheless often preferable to dehydrate on the apparatus at critical point before continuing degasification in the metal sprayer and then metallization.

Cryo-fixing is often useful for organic matter and very frangible samples.

This treatment gives excellent surface conductivity and accentuation of the relief of the rough samples by shadowing in SEM.

## 8.3. Microscope Studies

### 8.3.1 Optical Microscopy

#### *Description*

Optical microscopes allow observation of objects that are too small to be observed with the human eye or with a magnifying glass. Direct observations are carried out under IR to UV radiation including visible radiation, and can be accompanied by photography on film (black and white or colour) or digitalized video images.

The magnifying power of a magnifying glass ranges from 2 to 60 times and of the most powerful microscopes up to 1,500 times. The object can be massive or very thin (a thin slide that is covered or not) to determine properties of soils or soil materials using absorption-transmission. Covering slides protects the surface from oxidation. Covered slides can be used for optical observation in immersion but the slides cannot subsequently be used for electronic microscopy.

Briefly, an optical microscope is composed of a stand which supports a mechanical mount ensuring vertical displacement of an objective, and an eyepiece over an object slide.

The magnifying power and the diameter of the field characterize the relations between the image and the object. Lightness refers to the luminosity of the optics used. The depth of field and the focusing range, as well as the limit of resolution determine the zones where the object can be observed under optimal conditions for a given material. A system of lighting allows observation by reflection or transmission. The lighting can be directed for massive objects (low-voltage lamps, optical fibres). For very thin objects, the lighting can be concentrated into a point by condensers with respect to different backgrounds: pale background, dark background, polarized light, phase contrasts, UV (slides covered or not).

IR microscopes use optical systems with mirrors to avoid adsorption of IR by the materials generally used in the manufacture of lenses.

#### *Polarizing Microscope*

In soil sciences, polarizing microscopes are primary tools for the observation of crystals and the characterization of their optical properties. Interference microscopes or phase contrast microscopes (invisible transparent objects against a pale background) are rarely used. Variations



in transmission factors can reveal structures that are invisible in natural light and make it possible to identify phenomena of pleochroism, isotropy and anisotropy of structure and mineral associations (as in forms, facies, cleavages, macles) using cross or slightly uncrossed polarizers. These microscopes (Fig. 8.7) enable observation of variations in transmission compared to the direction of polarization of the incidental light. A calibrated compensator placed in front of the analyser allows observations to be quantified. The choice of the objective is important (magnifying power, immersion or not) for the quality of soil observations.

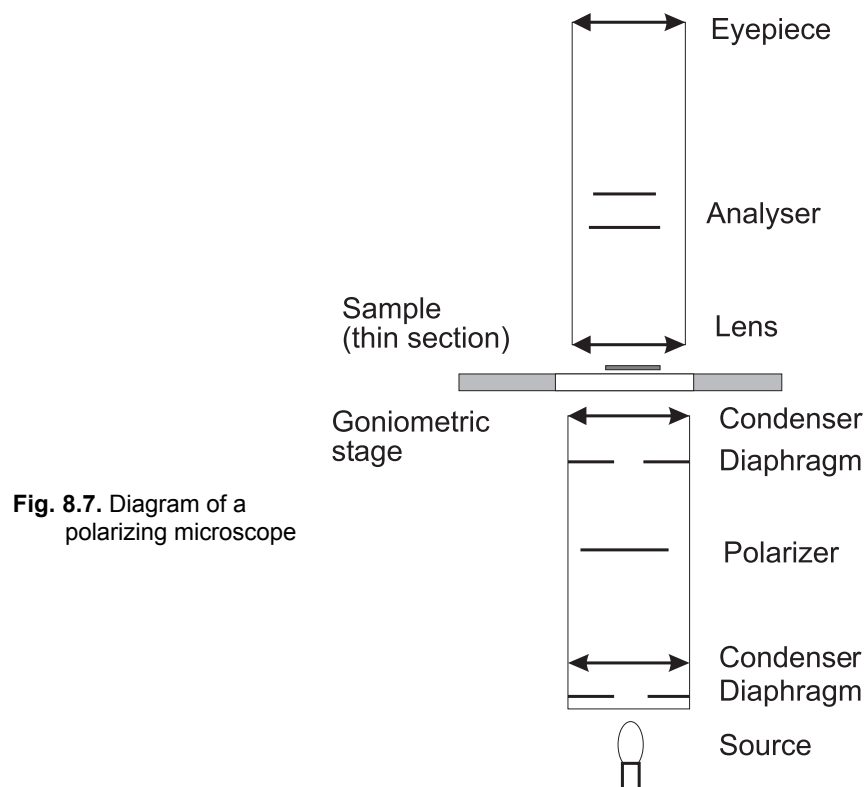

**Fig. 8.7.** Diagram of a polarizing microscope

For the study of the structure and porosity of soils, the size, shape, associations of individual grains, and distribution of the different phases are determined either on extracted phases, or on thin sections (Jongerijs et al. 1972; Bullock and Murphy, 1980).

### **Procedure**

A rotating support, graduated in degrees, makes it possible to measure the extinction angle and to identify primary minerals that are still present as

well as to specify the scale and type of weathering. Interpretation requires considerable experience meaning only specialists in petrography are usually able to do it. Orthoscopic methods are time consuming but generally more precise than conoscopic methods (Wahlstrom 1969, Hartshorne and Stuart 1970).

This type of analysis is qualitative, but can be quantified by counting the mineral particles originating from the parent rock and minerals liable to weathering in the fractions previously separated by fractionation using particle size, density, hardness, magnetic properties, etc. The shape of the particles (rounded edges, sphericization of softer minerals), surface appearance (such as flatness of the particles, cleavages, cracks, different coverings) are indicators of the form of deterioration, erosion and transport (chemical weathering, micro-corrosion, waterice- or wind-erosion).

The nature of minerals can be deduced from their colour, opacity, and especially from their refractive index and observable modifications in polarized light (e.g. pleochroism). Certain minerals have a more or less clear birefringence. The extinction angle can be reached with varying degrees of rapidity, and may be partial or complete. The shape of certain crystals is characteristic.

These observations can be supplemented by scanning electronic microscopy after rapid mounting of the materials on double face sticking supports made conducting with flash-carbon (cf. Sect. 8.2.5).

Using thin sections allows observation without disturbance of the in situ arrangement of the sample, orientations and associations of minerals, discontinuity of the mineralogical composition of a profile (decrease in or disappearance of certain minerals, ratio of minerals resistant to weathering: minerals liable to weathering giving index of deterioration).

The development of concretions, nodules, the appearance of cementing, the presence of organic matter at different stages of decomposition can be observed and quantified by subsequent measurements using SEM combined with EDX (certain artifacts of preparation, like the filling of neocracks, or holes made by polishing by alumina are easily revealed).

The units of organization (skeleton, plasma, vacuums) can be studied in detail at different scales using extracted fractions or/and thin sections: the skeletal components correspond to particles that are not reorganized, plasma corresponds to fine elements that can move and reorganize (such as clays and oxides), vacuums are related to porosity (circulation of air and solutions in soil). For the specific study of pore spaces, fluorescent colours can be mixed with the impregnation resin during the preparation of thin sections (cf. Sect. 8.2.2).

### 8.3.2 Electron Microscopy, General Information

All electron microscopes are based on the interaction of electrons with matter. The energy of an electron accelerated by a voltage  $V$  is equal to  $E = m v^2/2 = e V$  (with  $m$ ,  $v$ ,  $e$  = mass, speed and charge of the electron, respectively). High energy radiation (fast electrons) can affect the level of the deep electronic layers of the atoms. Weak energy radiation (slow electrons) only affects the external electronic layers which reflect the chemical state of the atoms. The total effect of the electron beam is related to the electronic cloud of the  $Z$  electrons ( $e^-$ ) of the electronic orbitals around the nucleus of atoms.

The following factors should be taken into account when considering how to change the way radiation affects matter:

- intensity: transmitted or reflected intensity is lower than incidental intensity, absorption occurs
- direction: there is scattering with loss of energy (inelastic scattering modifying internal structure), or without loss of energy (coherent elastic scattering allowing diffraction)
- energy: as some energy is lost, reflected, transmitted or scattered energy is lower than initial energy.

Losses in intensity and energy may be accompanied by modification of the matter due to the effect of the radiation:

- in the case of electron microscopes with very high energy (3,000 kV), the sample can gradually be destroyed
- in the case of microscopes with energy lower than 400 kV, there is transfer of energy by excitation of the electrons, thermal vibrations, particle ejection, and emission of secondary radiations usable for quantification. The heating effect produces phonons. Some chemical effects are reducing ( $e^-$  gain). Chemical bonds can be ruptured.

When the transfer of energy is higher than the threshold of displacement (between 15 and 30 eV), the effects of irradiation can cause atomic displacements. With electronic corpuscular incidental radiation of sufficiently high energy, an orbital electron in the deep atomic layers can be ejected with a kinetic energy corresponding to the difference in the energy lost by the incidental radiation and the electron's own energy (secondary electrons). As the excited state is unstable, the atom subsequently returns to a fundamental state; there is release of X-photons or Auger electrons (relaxation phenomena).

With electromagnetic radiation such as incidental or re-emitted X-rays photoelectrons are obtained (IR- to UV-photons, cathodo-luminescence). Electron microscopes can be classified at two levels depending on the geometry of the sample:

- massive samples which, as they are very thick, can be analysed only by the signals that come from their surface by reflection
- samples with a critical thickness that allows radiation to cross them (micro-crystals, thin films, etc.), in which case measurements can be made by transmission.

However, progress in instrumentation has led to changes in this dichotomy with the appearance of hybrid apparatuses allowing measurements on thin samples that use both processes. The following types of equipment are available:

- traditional transmission electron microscopes TEM (possibly with additional functions in transmission scanning mode)
- scanning transmission electron microscopes (STEM)
- microscopes with scanning by reflection (conventional scanning electronic microscopes: SEM)
- microscopes with scanning by reflection with differential vacuum where the observation chamber is under partial vacuum (environmental scanning electronic microscopes: ESEM).

Each type of apparatus allows complementary measurements. The apparatuses are suitable for either very high resolution, or, with multiple configurations, for a range of different chemical and physico-chemical approaches. The signals obtained are complementary in the energy fields.

### 8.3.3 Transmission Electron Microscopy, Micro-diffraction

#### *Principle*

Transmission electron microscopes use an incidental electron beam which, while crossing a very thin sample, provides information on the shape and structural distribution of elementary soil particles. The interaction of the electron beam with the matter results in images and micro-diffraction spectra (and enables selection of elementary chemical analyses as complements to the different electronic micro-probes in STEM).

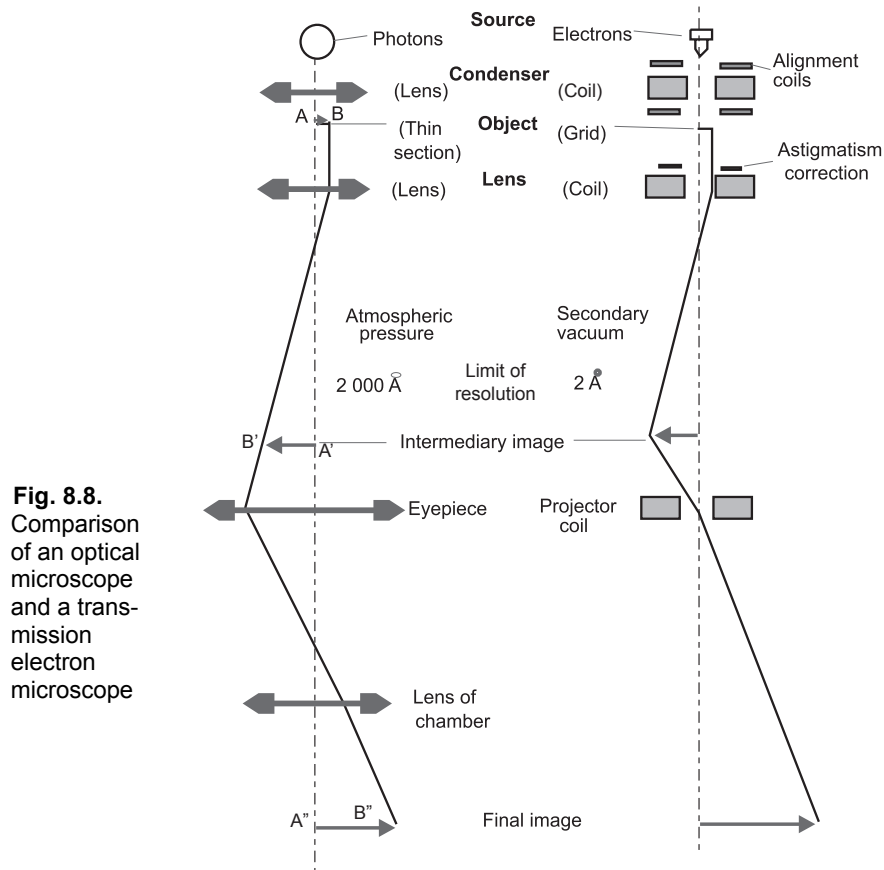

**Fig. 8.8.**  
Comparison  
of an optical  
microscope  
and a trans-  
mission  
electron  
microscope

The geometry of an electron microscope can be compared to that of an optical microscope (Fig. 8.8). A source of electrons (high voltage electron gun) replaces the source of photons. A system of illumination with electromagnetic condensers concentrates the electron beam on the object; an electronic objective forms an intermediary image which is captured by projection lenses to form the final image on a fluorescent screen or a photographic device.

Not all the radiations generated by the incidental electronic beam (Fig. 8.9) are used, since the apparatuses generally have only 1–2 sensors.<sup>2</sup> X-photonic radiation (1, Fig. 8.9) can be collected by an EDX) detector (with Si–Li detection, or diodes without windows for analysis of light elements such as nitrogen and carbon), or WDX (with crystal monochromator).

<sup>2</sup> At their maximum configuration, some top-of-the-range commercial analyzers include up to five sensors.

IR–UV–visible photonic radiation (2, Fig. 8.9) can be detected by cathodoluminescence. The scattered electrons (5) can be analysed by electron energy loss spectrometry (EELS) and enables analysis of light elements in STEM. Back-scattered electrons (6), secondary electrons (7), and Auger electrons are used for SEM images and transmitted electrons (12) for TEM and STEM.

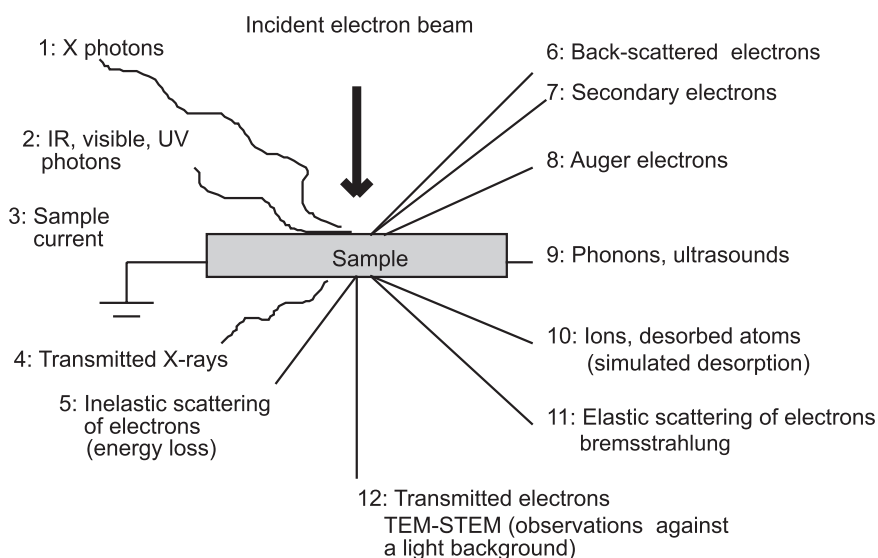

**Fig. 8.9.** Types of radiations emitted during the bombardment of a sample by an electron beam

The choice of a transmission electron microscope depends on the nature of the observations required (magnifying power, high resolution, the need for high voltage for excitation or penetration, possible chemical quantification) and the cost, but also the versatility and the possibility to up-grade the equipment, its ability to cover the whole range of magnifying power including weak magnifying power, the degree of automation and ease of use, the quality and the cleanliness of the vacuum, contrast and performance against a dark background, possible coupling with systems for chemical analyses and image analysers, etc. The annual cost of maintenance contracts and consumables should also be taken into consideration, as these can represent 3–6% of the initial purchase price.

### **Emission of electrons**

An electron gun is the source of electronic radiation. Generally, radiation is caused by the thermoelectronic emission of a filament of tungsten heated to 2,500°C (or of a tip of lanthanum hexaboride heated to 1,600°C) which forms the cathode (Fig. 8.10).

**Fig. 8.10.** Thermal-emission electron gun by: (1) tungsten (on the *left* or LaB<sub>6</sub> (on the *right*) filament, (2) focusing electrode polarized negatively with respect to the filament (Wehnelt), (3) anode, (4) cross-over (10 to 50 μm). Wehnelt is carried to a negative potential of a few volts to push the emitted electrons out of the axis and to concentrate them in a narrow beam

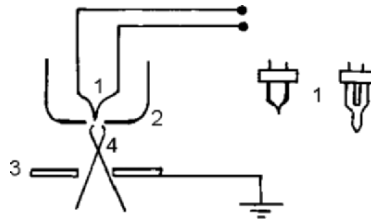

The tungsten filament has a diameter of approximately 0.1 mm, is V shaped and pointed at the end to focus the emission. The filament is heated to a high temperature under vacuum and is subjected to a work voltage of 4.5 eV. The conduction electrons can then cross the barrier of potential and an electronic cloud is formed. These electrons are accelerated by a potential  $V_0$ . An electron beam is obtained whose energy is  $E_0 = eV_0$ . The emitted electrons move into the column at constant speed thanks to the high electric potential between the filament and the anode (supply voltage of the anode).

A cathode made of lanthanum hexaboride (LaB<sub>6</sub>) with a work voltage of 2.7 eV, i.e. weaker than that of tungsten, can be used at a lower temperature (approximately 1,600°C); brightness is then considerably improved. However, the vacuum must be changed to  $10^{-7}$  Torr, and the reactivity of LaB<sub>6</sub> with certain metals can be awkward. Electron guns with field emission are also available whose brightness is much greater than that of thermoelectronic guns and whose energy dispersion is reduced.

The incidental beam of electrons emitted by the electron gun (<1 mm of the cross-over) crosses the column of the microscope following the optical axis. Electromagnetic lenses are solenoid and consequently generate a magnetic field that focuses the electrons. An external shield prevents the dispersion of this magnetic field. The usual acceleration voltage varies from 50 to 1,250 kV, but can reach 3,000 kV. In practice, microscopes are available with (1) voltage of less than 100 kV, (2) medium voltage of between 200 and 500 kV, (3) high and very high voltage electronic microscopes (HVEM), 1,250 kV and above. Those in group (3) are very expensive, very voluminous and require special safety equipment.

### **Observations**

In TEM mode, high resolution electronic microscopes (HREM–HRTEM) (200–300 kV) can be equipped with 15 Å probes which enable the study of the morphology of the samples at different scales, direct observation of the atomic structure of a crystal and of the stacking of atoms (1.5 Å at 400 kV) on micro-samples where XRD is not efficient. These microscopes are thus useful to study problems of fundamental crystallography, phenomena of deterioration (germination and crystal growths, transformation of the phase that is amorphous to X-ray into crypto-crystalline and crystalline phases in the repetitive structures of clays). For example, interstratifications of mica–chlorite and minerals of 7–14 Å were studied by Amouric (1987, 1990) and Amouric et al. (1988), mica–kaolinite associations by Ahn and Peacor (1987).<sup>3</sup>

Using these techniques, it is possible to detect the planar defects, relic layers, and pale fringes of the interlayer levels. Care should be taken with high resolution to ensure that the high electron energies do not cause irradiation damage due to powerful vibrations of electron matter.

### **Micro-diffraction**

In mineralogy, micro-diffraction of electrons is generally carried out simultaneously with the observation of images of normal incidence. The objects are prepared on micro-grids at sufficiently low density to insulate the elementary particles in the same way as for imagery.

Micro-diffraction can be performed with the majority of the TEMs simply by adjusting the diaphragm. The fast electron beam at low wavelength and high energy (20–60 keV or more) strikes the extremely thin micro-crystal (<100 Å); when the angle of incidence on the reticular levels is in agreement with Bragg's law (cf. Chap. 4) spots of diffraction are observed (Fig. 8.11). On submicro-samples, the spectra obtained are characteristic of single-crystal structures. Such a detailed view of crystal arrangements and defects cannot be obtained with traditional XRD (cf. Chap. 4).

---

<sup>3</sup> For these very fine studies, the zones of interest are selected on thin slides with SEM at magnifying powers of about 10,000–20,000. These zones are separated on sections thinned with an ultra-microtome and an argon gun to ensure they are sufficiently transparent for the electrons in HRTEM.



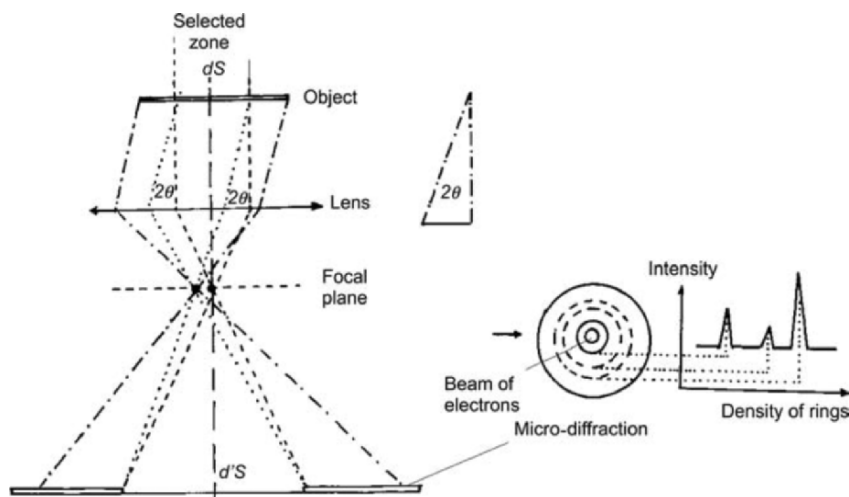

**Fig. 8.11.** Micro-diffraction by adjustment of the diaphragm

Micro-diffraction by adjustment of the diaphragm uses a diaphragm placed in the image plane which defines a reduced active surface of approximately  $1 \mu\text{m}^2$ . This method enables readable spectra of oriented micro-crystals to be obtained, but the very small wavelength of the electrons induces weak angles of diffraction and associated intensities that are different from the methods of traditional X-ray diffraction described in Chap. 4.

As the sample is very thin, the diffraction spots obtained are characteristic of single-crystal structures. This method is often used as a complement to traditional XRD. On polycrystalline materials like clays, annular spectra can be obtained in about a minute.

### **Special TEM Techniques**

#### *Visualization of Charges with Colloidal Gold*

##### **Principle**

As colloidal gold is opaque to electrons, it is used as a tracer to reveal edge charges or structural defects in crystalline structures (Photo 8.1 left).

##### **Equipment and reagents**

- TEM grids 3.05 mm in diameter covered with an FORMVAR film and carbon
- 5 nm particle size colloidal gold solution (store in the refrigerator protected from light).

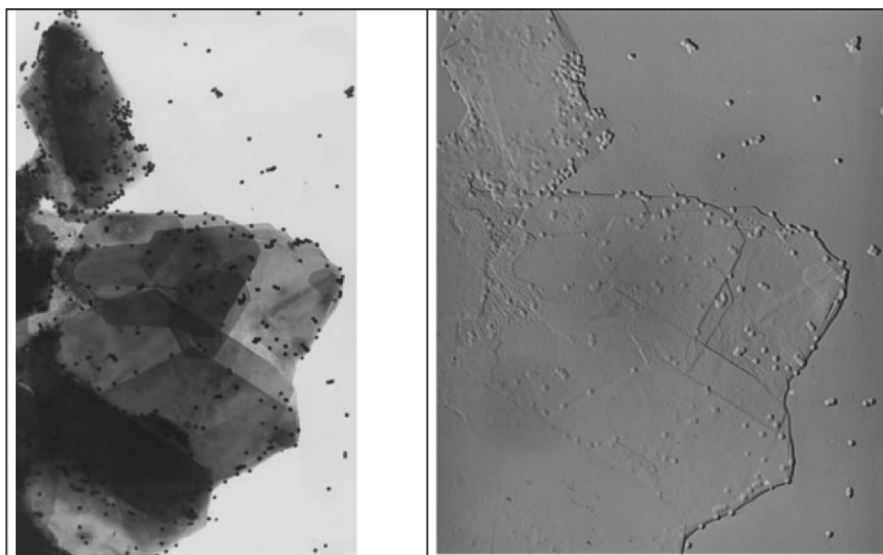

**Photo 8.1.** Special transmission electron microscopy techniques. On the left, highlighting of edge charges in kaolinite by colloidal gold (see procedure in text of this section), on the right view in paraglyph (see procedure in below), photographs (x 90,000), Gautheyrou J., IRD mineralogical reference set, Bondy, France, unpublished data

- Suspend the colloidal gold solution by agitation
- take 0.5 mL of gold suspension and mix in a glass tube with 0.5 mL of sample of low density in order to obtain well separated minerals; leave in contact for a few minutes; agitate and put a micro-drop on a 3 mm grid.,

Allow to dry in the air and view under a TEM with a magnifying power of about 60,000. Gold preferentially migrates towards the rupture or crystallization zones and reveals the modes of assembly and the active sites of certain clays.

#### *Development in Paraglyph*

##### Principle

The aim is to obtain a pseudo relief by superposition, with a tiny shift of negative and positive transparencies of the same image (Photo 8.1 right).

### Equipment and products

- Negative film with strong contrast, format at least  $6.5 \times 9$  cm
- transparent positive film
- photographic development products (developer – fixer).

### Procedure

- Choose a clear negative of the image
- by contact trace the image on a positive transparency of similar density
- superimpose the negative and positive and find the optimal shift needed to obtain an effect of relief
- draw by tracing or by enlargement. This type of image makes it possible to see coverings of particles more clearly and the effect of relief can be spectacular.

### *Opacification of Samples that are “Transparent” to Electrons*

Minerals rich in iron are very opaque to electrons and can cause problems if they are too thick as the resulting images are very strongly contrasted and no details are visible.

On the other hand, certain very fine minerals like allophanes are practically transparent to electrons if they are present in low concentrations. These preparations can be opacified with a lead salt ( $\text{PbCl}_2$  at 1% in water).

The sample is left in contact with lead solution for one hour, then washed, suspended again and diluted to prepare a TEM grid.

### **Scanning Transmission Electron Microscopy**

The electron gun and the condenser system used to produce the electron beam are based on a principle that is similar to traditional TEM, but in TEM the signal is transmitted to the image plane observable on a fluorescent screen via a system of electronic lenses, whereas in scanning transmission electron microscopes (STEM), the signal is directly collected by electron or X-ray detectors, and transmitted on-screen (Fig. 8.12).

In true STEM, an electron gun with field emission, whose cross-over is about 5 nm and whose brightness is more than 1,000 times higher than that of a traditional tungsten source, provides an electron beam which crosses a condenser giving a reduced image of the source (micro-probe).

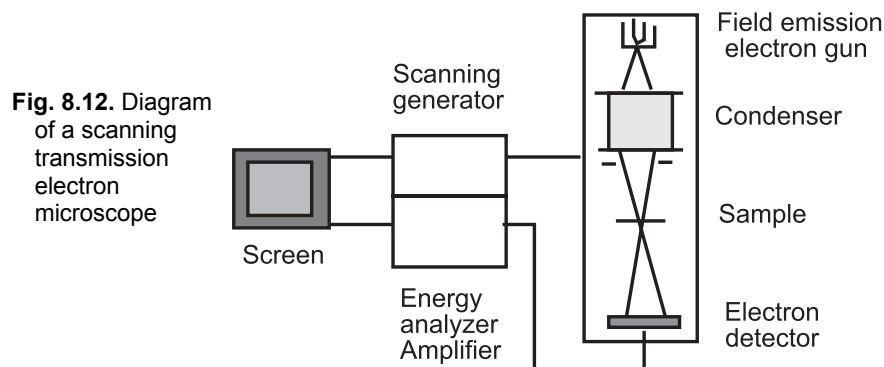

This probe scans the surface of the sample by means of a deflecting coil. The electrons transmitted or diffracted by the sample are collected on a detector with a response that is proportional to their intensity. After amplification, an image is created on the screen stage-by-stage in synchronization with the scanning generator.

Electron guns with field emission are very sensitive to contamination. They require an ultrahigh “dry” vacuum ( $10^{-10}$  Torr), which proscribes the use of oil diffusion pumps for the secondary vacuum. In spite of the use of cryoscopic traps, the gun can still break down because of traces of oil.

Very high spatial resolution can be achieved. This equipment can also be equipped with energy analysers such as electron energy loss spectrometers (EELS). They can carry out analyses on surfaces of the order of one nanometer on all the elements of the periodic table ( ${}^3\text{Li}$  to  ${}^{92}\text{U}$ ) on submicroscopic samples.

Dedicated STEM are not the most widely used, many manufacturers prefer to sell hybrid TEM equipped with complementary STEM which perform excellently for a price that is 2 at 3 times lower.

### 8.3.4 Scanning Electron Microscopy

#### *Scanning Microscopes by Reflection, Microprobes*

The concept of the scanning electron microscope (SEM) and that of electronic micro-probes (EM) are complementary, EM comprising probes of less than  $1\ \mu\text{m}$  optimized for X-ray analysis.

The thermionic electron gun is subjected to a negative voltage of 10–50 kV. The sample is placed on a goniometric precision support (a binocular magnifying glass enables visual location of the point of impact on the microprobe).

Electromagnetic condensers form the image of the probe which is projected on the sample. The probe is moved by deflection of the beam. A massive sample can be 2–4 cm thick and have a diameter of 20 cm (8 inches wafer). A large-capacity sample chamber requires a clean vacuum system with a strong flow (turbomolecular pump). The magnifying power is the ratio of the amplitude of the scanning of the image (fixed) to the amplitude of the scanning of the object (variable).

Electron–matter interactions (secondary and back-scattered electrons, X-ray, Auger electrons, photoluminescence, transmitted electrons) can be used for analytical measurements.

The image is created stage-by-stage (pixel by pixel) and allows digitalization and treatments using an associated data processing system. The creation of the images is based on two modes:

- in *secondary electrons mode* the incidental primary radiation of the electrons loses energy in contact with the matter; part of the energy is restored in the form of secondary electrons which cross the grid of the collector and are then accelerated in the field of the scintillator; an exploitable signal is obtained which is mixed with the back-scattered electrons which are able to cross the diaphragm of the detector
- in *back-scattered electrons mode* the electrons are collected by the collector of a scintillation detector; the signal is rather weak but detection is improved by using a semiconductor detector in the shape of disc that is perforated in the centre which is placed above the sample; a device installed in two or four different sectors makes it possible to create a topographic contrast.

The chemical composition of the sample sometimes varies in a random way because the rate of penetration is very low. The shade of grey is related to the atomic numbers of the elements observed.

The resolution is about 20–100 Å depending on the element observed. The intensity of the electron beam and of the scanning conditions is chosen to ensure maximum resolution and an optimal signal-to-noise ratio for a given magnifying power. Even in the best conditions strong incidental energy (approximately 30 keV) prevents very fine details from being observed, but generally reasonably good results are obtained. On the other hand, if the material is slightly conducting and cannot be sprayed with metal, it may be better to reduce the charge by using energy below 5 keV.

The diaphragm should be selected to obtain a suitable depth of field, as well as to allow adjustment of the work distance if the relief of the sample is significant.

### ***Environmental Scanning Electron Microscopy***

These microscopes enable high resolution images to be obtained by reflection on samples preserved in their natural moisture, without degassing or surface conducting treatment. Some environmental investigations can be made without deformation or transformation of the sample. Two systems are used:

- low vacuum scanning electron microscopes (LV-SEM) are relatively simple and can be used in conventional SEM; they enable a partial vacuum of about 2–4 Torr to be created in the sample chamber; they are generally equipped with a detector of back-scattered electrons
- environmental scanning electron microscopes (ESEM) are dedicated microscopes which enable a high vacuum to be created in the electron gun ( $10^{-7}$  Torr) and simultaneously a reduced vacuum of near atmospheric pressure to be created in the observation chamber. This difference in vacuum is obtained in stages with progressive reduction in pressure.

The distance between the sample and the output of the electron beam under high vacuum must be as small as possible in order to avoid a reduction in performance. In conventional SEM, more than 95% of the electrons do not undergo dispersion. In environmental SEM with the sample at a short distance from the beam output under a pressure of 1 Torr, the proportion of non-dispersed electrons can reach 90%, but decreases with the number of gas molecules in the trajectory of the beam.

A specific gaseous secondary electron detector (GSED) enables the quality of the image to be improved by discriminating the back-scattered electrons and the secondary electrons resulting from the interactions of the electrons of the beam and the atoms of the sample. There is no artefact of charge as in conventional SEM (e.g. ionization of gas, production of free electrons, or creation of positive ions compensating for the negative charges). This detector is not sensitive to light or to temperature.

The atmosphere in the sample chamber can be controlled at the same time as the pressure and the temperature and enables observations in a gaseous medium of almost constant composition. Interpretation of the images requires adaptation to phenomena such as condensation on the minerals (for example rounding of the angles), the presence of interstitial

water or pollutants and the determination of gas balances. Quantitative measurements by EDX (cf. Sect. 8.3.5) are possible. Many applications in soil science, especially in studies of organic matter, clayey materials, and micro-organisms are now possible using ESEM (Mathieu 1998, Leroux and Morin 1999), for example:

- physical problems involved with expansible minerals, allophane soils with high water retention, structure, texture, porosity, aggregates, transfers between the soil and the environment, dehydration and hydration processes, soil shrinkage, compression, adhesiveness
- effect of heat or chemical treatments, fusion, sublimation, growth of crystals, stabilization of structure, tests under constraint
- dynamics of the degradation of organic matter, micro-fauna.

### **8.3.5 Ultimate Micro-analysis by X-Ray Spectrometry**

#### ***Energy Dispersive X-Ray Spectrometry***

Micro-determinations are usually carried out by X-ray fluorescence spectrometry (cf. Sect. 31.3.2, Chap. 31) by means of an EDX spectrometer. This system (Fig. 8.13) enables plotting of charts of elementary qualitative distribution at the surface layer and on approximately 1  $\mu\text{m}$  thickness. It is better to use almost flat surfaces; for accurate quantitative analysis, surfaces have to be polished to 0.25  $\mu\text{m}$  to limit possible topographical effects.

A fixed probe can be used if less precise quantitative micro-analyses is needed than that obtained with dedicated analytical probes, but ZAF matrix-correction software (*Z*: atomic number, *A*: absorption, *F*: fluorescence) enable improvement of the results. These analyses can only be performed on elements heavier than  $^{11}\text{Na}$ . Light elements require the emission of Auger electrons; but the ultra-high vacuum of  $10^{-10}$  Torr required in Auger spectroscopy cannot be obtained with normal scanning microscopes. A SAM<sup>4</sup> microscope is required where the vacuum is obtained with an ionic pump.

#### ***Wavelength Dispersive X-Ray Spectrometry***

The source of X-rays emitted at the electron beam–matter interface is placed on a focusing circle called “Rowland circle” (Fig. 8.13). Detection

---

<sup>4</sup> SAM = Scanning Auger Microscope.

is carried out by moving the crystal analyser and the entry slit of the detector (counter with proportional action) along the circle. The detector must be at the effective focal spot ( $2\theta$  compared to the incidental beam).

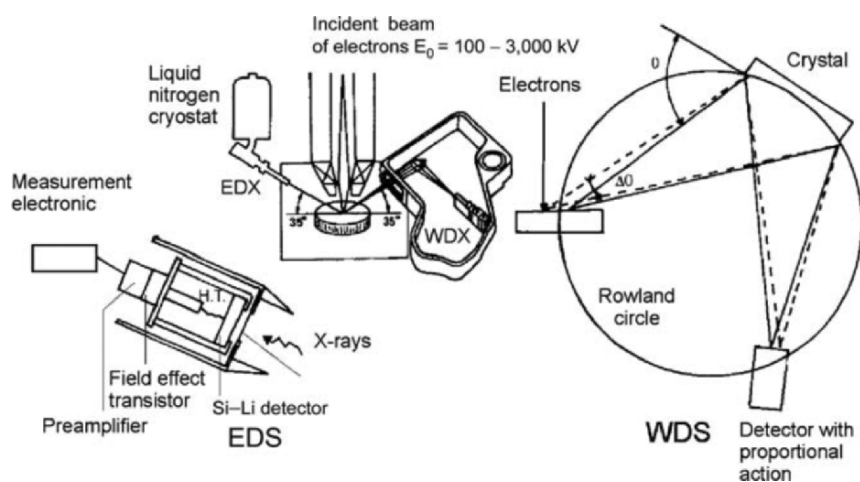

**Fig. 8.13.** Microprobes with dispersion of energy and wavelength: EDS, EDX: energy dispersive X-ray spectrometry, WDS, WDX: wavelength dispersive X-ray spectrometry (Rowland circle, effect of the defocusing of the electron beam,  $\theta$  = Bragg angle,  $\Delta\theta$  = deviation of the Bragg angle caused by defocusing)

To carry out quantitative analysis, the direction of measurement and the opening must be constant. In practice, the angle of reflection cannot exceed the  $5-70^\circ$  range. It may thus be necessary to use four crystal analysers (Microspec-USA system) at different reticular distances (Bragg's law) to cover the range of wavelengths accessible with this approach (lithium fluoride, LiF, Pentaerythritol, PET, rubidium acid phthalate, RAP, lead stearate, STE). The WDX system is tending to be replaced by the faster EDX system.

## References

- Ahn JH and Peacor DR (1987) Kaolinization of biotite: TEM data and implications for an alteration mechanism. *Am. Miner.*, 72, 353
- Amouric M (1987) Growth and deformation defects in phyllosilicates as seen by HRTEM. *Acta Cryst.*, R43, 57
- Amouric M (1990) Etude de l'interstratification mica-chlorite par microscopie électronique. In *Matériaux argileux, structure, propriétés et applications*,



- Decarreau A ed., Soc. Fr. de Minéralogie et Cristallographie, Groupe Français des Argiles, 283–287
- Amouric M, Bianetto T and Proust D (1988) 7.1 and 14 Å mixed layer phyllosilicates structurally studied by TEM in pelitic rocks. *Bull. Miner.*, 111, 29
- Bullock P and Murphy CP (1980) Towards the quantification of soil structure. *Microscopy*, 120, 317–328
- Delvigne JE (1998) *Atlas of micromorphology of mineral alteration and weathering*, The Canadian Mineralogist, special publication 3, Ottawa, IRD, Paris
- Hartshorne NM and Stuart A (1970) *Crystals and the polarizing microscope.*, Arnold, 219–251
- Jongerius A, Schoonderbeeck D, Jager A and Kowalinski S (1972) Electro-optical soil porosity by means of Quantimet B equipment. *Geoderma*, 7, 177–198
- Leroux A and Morin P (1999) Evolution de la microscopie à balayage – un progrès pour les applications géo-environnementales. *Bull. Lab. Ponts et Chaussées*, 222, 85–89
- Mathieu C (1998) Effects of electron-beam/gas interaction on X-ray microanalysis in the variable pressure SEM, *Microchim. Acta.*, 15, 295–300
- Moran C., McBratney AB and Koppi AJ (1989) A rapid analysis method for soil macropore structure. I. Specimen preparation and digital binary image production. *Soil Sci. Soc. Am. J.*, 53, 921–928
- Pansu M, Gautheyrou J and Loyer JY (2001) – *Soil analysis – sampling, instrumentation and quality control*, Balkema Publishers, Lisse, Abington, Exton, Tokyo, 512 p.
- Tessier D (1985) Validité des techniques de déshydratation pour l'étude de la micro-organisation des sols. In *Soil Micromorphology*, Fedoroff N., Bresson LM and Courty MA ed., AFES
- Wahlstrom EE (1969) *Optical crystallography.*, Wiley New York

### Chronobibliography

- Deer WA, Howie RA and Zussman J (1962, 1963, 1966) *Rock-forming minerals.*, vols. 1–6, Longmans-Green London
- Beutelspacher H and van den Marel HW (1968) *Atlas of electron microscopy of clay minerals and their admixtures.*, Elsevier Amsterdam
- Reid WP (1969) Mineral staining tests. *Mineral Ind. Bull.*, 12, 1–20
- Spry A (1969) *Metamorphic textures.*, Pergamon, Oxford
- Hartshorne NH and Stuart A (1970) *Crystals and the polarising microscope.*, Arnold
- Gard JA (1971) *Electron-optical investigation of clays.*, Mineral Society
- Hutchison CS (1974) *Laboratory handbook of petrographic techniques.*, Wiley New York
- Wells OC (1974) *Scanning electron microscopy.*, McGraw-Hill New York
- Brewer R (1976) *Fabric and mineral analysis of soils.*, Krieger USA

- Goldstein JI and Yakowitz H (1976) *Practical scanning electron microscopy.*, Plenum New York
- Zussman JB (1977) *Physical methods in determinative mineralogy.*, Academic New York
- Tessier D and Berrier J (1979) Utilisation de la microscopie électronique à balayage dans l'étude des sols. Observation des sols humides soumis à différents pH. *Sci. du Sol.*, 1, 67–82
- Jogerius A and Bisdum EBA (1981) Porosity measurements using the quantimet 720 on backscattered electron, scanning images of thin sections of soils. In *Submicroscopy oth soils and weathered rocks.*, Centre Agr. Pub. and Doc., Wageningen, Pays-Bas
- Smart T and Tovey NK (1981) *Electron microscopy of soils and sediments*, t1 et t2. Clarendon Oxford
- Fleischer M, Wilcox RE and Matzko JJ (1984) Microscopic determination of opaque minerals. *US Geol. Survey Bull.*, 1627
- Low AJ, Low EJ and Douglas LA (1984) A motorized grinder for making soil thin sections. *Geoderma*, 32, 335–337
- Bullock P, Fedoroff N, Jongerius A, Stoops G, Tursina T (1985) Handbook for Soil Thin Section Description, Waine Research. Publication. Wolverhampton, England
- Goldstein JI, Newbury DE, Echlin P, Joy DC, Fiori C and Lifshin E (1985) *Scanning electron microscopy and X-ray microanalysis.*, Plenum New York
- Maurice F, Keny L and Tixier R (1985) *Microanalyse et microscopie électronique à balayage.*, Les éditions de Physique
- Murphy CP (1985) Fasten methods of liquid-phase acetone replacement of water from soils and sediments prior to resin impregnation. *Geoderma*, 35, 39–45
- Willaime C (1987) *Initiation à la microscopie électronique par transmission en minéralogie, science des matériaux.*, Soc. Fr. de Minéralogie et de Cristallographie
- Blackburn M, Caillier M, Bourbeau GA and Richard G (1988) Utilisation d'une solution de chlorure de sodium pour le remplacement de l'eau dans les échantillons d'argile lourde avant l'imprégnation. *Geoderma*, 41, 369–373
- Takeda H (1988) A rapid method for preparing thin sections of soil organic layers. *Geoderma*, 42, 159–164
- Chartres CJ, Ringrose-Noase AJ and Raupach M (1989) A comparison between acetone and dioxane and explanation of their role in water replacement in undisturbed soil samples. *J. Soil Sci.*, 40, 849–863
- Wright D, Stanley D, Chen HC, Shultz AW and Fang JM (1990) A frame based expert system to identify minerals in thin section. *Microcomputer applications in geology II*. Pergamon Oxford, 289–299
- Zhurov AV (1990) Preparation of polished sections for the study of soil pores and their differentiation by size. *Pochvovedenize*, 8, 144–147

- Sludzian G and Galle P (1992) Cartographie de matériaux et d'échantillons biologiques par microscopie ionique à balayage. *La vie des sciences, Compte rendu série générale*, 9, 157–177
- Gribble CD and Hall AJ (1993) *Optical mineralogy : principles and practice.*, Chapman and Hall London
- Fitzpatrick EA (1993) *Soil microscopy and micromorphology.*, Wiley
- Ringrose-Voase AJ and Humphreys GS (1994) *Soil micromorphology, studies in management and genesis ; Proceedings of the IX international working on soil micromorphology.*, Elsevier Science Ltd
- Lavoie DM, Little BJ, Ray RI, Bennett RH, Lambert MW, Asper V and Baerwald (1994) Environmental scanning electron microscopy of marine aggregates. *J. Microscopy*, 178, 101–106
- Vempati RL, Hess TR and Cocke DL (1996) X-ray photoelectron spectroscopy. In *Methods of soil analysis*, Sparks DL ed., SSAA book series No 5
- Johnson RA (1996) Environmental Scanning electron microscopy – An introduction of ESEM, *Philips Electron Opt.,-FEI*, 55p
- Mathieu C (1996) Principle and application of the variable pressure SEM, *Microscopy and analysis*, 43, 13
- Pichler H, Schmitt-Riegraf C and Hoke L (1997) *Rock-forming minerals in thin section.*, Chapman, London
- Hitachi, (2000) Low temperature microscopy using a cooling stage. *Hitachi technical data*, 62
- Astley OM, Chanliaud E, Donald AM and Gidley MJ (2001) Structure of Acetobacter cellulose composites in the hydrated state. *Int. J. Biol. Macromole*, 29, 193–202
- Slowko W (2001) Secondary electron detector with a micro-porous plate for environmental SEM, *Vacuum*, 63, 457–461
- Tai SSW and Tang XM (2001) Manipulating biological samples for environmental scanning electron microscopy observation. *Scanning*, 23, 267–272

# Part 2

## Organic Analysis

## Physical Fractionation of Organic Matter

### 9.1 Principle and Limitations

#### 9.1.1 Forms of Organic Matter in Soil

Many different organic fragments can be distinguished in soils, most of which are of plant origin (living or dead roots, fragments of wood fibre, fragments of stems and dead leaves) and others of animal origin (e.g. cadavers, faecal pellets, earthworm casts) from macro-fauna such as insects, arachnida, myriapodes, crustacea, gasteropods or earthworms.

Increasing the scale of observation, smaller organic fragments e.g. filamentous roots, partially decomposed animal debris, nematodes, fungi, and algae can be identified with a magnifying glass.

The observation of other micro-organisms (e.g. bacteria, actinomyces, protozoa) and debris of animal or plant origin that are increasingly incorporated in organomineral colloids requires a higher power of magnification.

Initially soil organic matter (SOM) thus appears to be a continuum of increasingly fine fragments that can be physical fractionated.

#### 9.1.2 Principle

The methods of fractionation described in this chapter include both manual or mechanical sorting, and the use of physical techniques for density fractionation, particle-size fractionation by sieving, and analysis of sedimentation. The methods used resemble those used in fractionation of mineral particles (cf. Chap. 2).

Manual sorting is used especially for studies on live roots in the soils. Sorting is facilitated by floating using – for example – water elutriators (cf. Sect. 9.2.2).

Density fractionation is based on the difference in density between matter of plant origin (close to 1) and of mineral origin (around 2.65 for primary minerals). Theoretically, it is thus an ideal technique for the separation of fragments of plant origin that are not decomposed in the soil. This type of measurement is now widely used in studies on the dynamics of carbon in soils. Some compartment models were established with data obtained by densimetric separation (Pansu and Sidi 1987, Arrouays 1994). These techniques are described in Sect. 9.2.4. However, depending on the type of soil, the density fractionation method may be hindered by the close associations between mineral and organic particles. The technique can be improved by combining it with particle size fractionation (Sallih and Pansu, 1993) and with a range of dispersion techniques described in Sect. 9.2.3 of this chapter.

The aim of particle-size fractionation is complete separation of the organic components of the soil. Ideally, coarse fractions of more than 50  $\mu\text{m}$  would contain intact plant debris, silt fractions of 50–2  $\mu\text{m}$  (or 20–2  $\mu\text{m}$ ) would contain cells and microbial fragments, coarse clays of 2–0.2  $\mu\text{m}$  would contain organic matter of the organomineral complex, and finally fine clays of 0–0.2  $\mu\text{m}$  would contain recently formed metabolites. Some approaches, such as dating (Anderson and Paul, 1984) or isotopic  $^{14}\text{C}$  measurements (Hassink and Dalenberg 1996) or  $\delta^{13}\text{C}$  (Puget et al. 1995) appeared to partially confirm this theory. Other studies showed that micro-organisms and organic materials are closely associated with mineral colloids, and consequently “clean” fractionation of the biological components of soils is impossible (Ahmed and Oades, 1984). Certain review studies (e.g. Christensen 1992, Feller 1994) did, however, identify three main classes of organic matter:

- a plant debris compartment (>20  $\mu\text{m}$ ) that is not closely associated with mineral sands with a relatively high C:N ratio (15–25) or with a high xylose to mannose ratio, indicating that this organic matter is of plant origin
- an organic silt complex including a mixture of soil organic matter (SOM) of plant and fungal origin, mineral silts and very stable organo-mineral micro-aggregates; C:N and xylose:mannose ratios are lower than in the previous compartment; the origin of this organic matter is not as clear as that of coarser matter

- an organic-clay compartment (<2  $\mu\text{m}$ ) rich in amorphous SOM; this compartment is humified and closely associated with the mineral particles; C:N (8–11) and xylose:mannose ratios are lower, suggesting that the origin of this organic matter is probably microbial.

### 9.1.3 Difficulties

Particle-size fractionation uses sieving techniques (generally wet sieving) to separate particles until 50 or 20  $\mu\text{m}$ . The separation of the finest particles requires sedimentation techniques similar to those described in Chap. 2 for mineral fractionation. However, an additional difficulty to take into consideration is particle density with respect to the Stokes law of sedimentation (cf. Chap. 2). The average density of 2.65 used for mineral particles is not appropriate for organic fragments (Elliott and Cambardella 1991). However, at this particle-size, organic matter is often closely associated with mineral particles. As SOM content is relatively low compared to mineral particle content, one can consider that the densities of the mineral fractions are not significantly modified.

The main difficulty in physical fractionation by density or particle size separation lies in the close association between minerals and organic matter resulting in different types of aggregates (Fig. 9.1). These aggregates have to be broken down and the organic components released without destroying them. Sect. 9.2.2 of this chapter discusses various techniques of dispersion at some length, and describes their limits and comparative interest.

Preparation and especially rewetting of the sample involves a risk of modifying the organic constituents. The samples are generally dried before storage at the laboratory. Drying, together with other preparation techniques (Pansu et al. 2001), stops the organic functioning of the soil resulting in deactivation or death of micro-organisms. The treatment is brutal and it is preferable to slow down microbial activity by cold storage or even better by freezing the fresh soil.

Whatever the technique of conservation used, stopping the biological activity is necessary to preserve the soil organic state at sampling, as the kinetics of evolution of certain organic components are higher than that of the main inorganic components.

However, rewetting the soil starts biological activity again. Rapid growth of the populations of micro-organisms supplied with the plant debris which are released from their clay protection during the preparation of the samples (effect of grinding) and become available for micro-organisms, as well as by consumption of the microbial biomass

killed during these operations. Part of this carbonaceous source is then mineralized or transformed.

There is thus a risk of changing the organic contents of the soil by rewetting of the samples which is required by most of the physical fractionation techniques described later. However, this risk is limited in the presence of a great excess of water, since most active food chains are essentially aerobic. The risk can be also limited by the use of reagents that are unfavourable to the growth of micro-organisms and by performing fractionation as rapidly as possible after moistening.

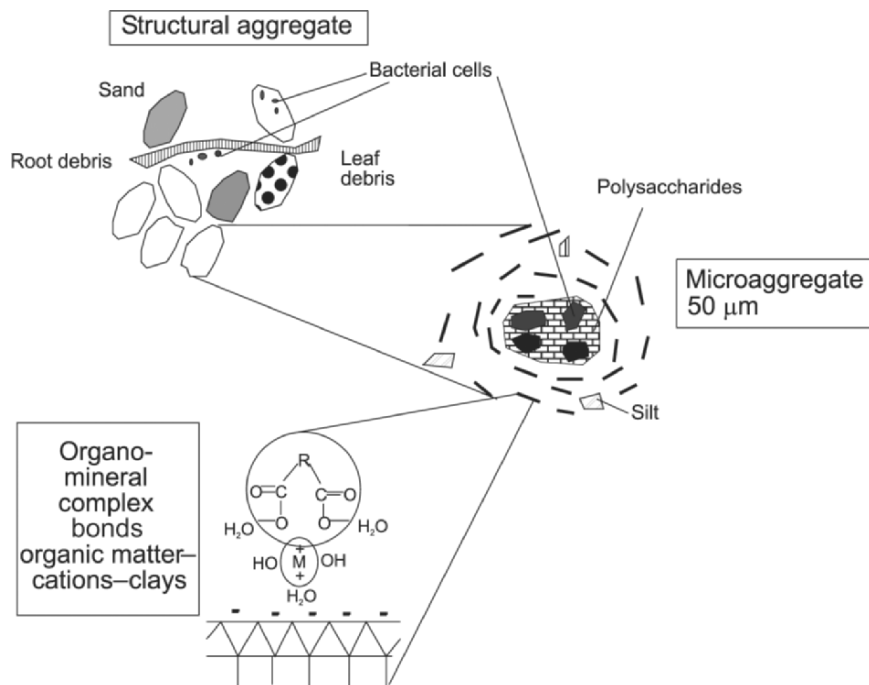

**Fig. 9.1.** Formation of organomineral complexes, micro-aggregates and structural aggregates (after Bruckert 1994)



## 9.2 Methods

### 9.2.1 Classification

Methods for physical fractionation of organic components can be classified in three main groups:

- separation of the plant roots;
- separation by density;
- fractionation in particle-size ranges.

When using these methods, the structure of the soil material should be kept in mind i.e. humified fine organic matter associated with inorganic matter forming *organomineral complexes*. These complexes involve bonds between solid particles resulting in the formation of different types of *aggregates* in the soil. Some of the components that have to be separated are imprisoned in these aggregates (Fig. 9.1). The difficulty in fractionation thus consists in splitting up these aggregates without destroying the components that have to be measured. The principal techniques for aggregate dispersion are described and commented in Sect. 9.2.3.

### 9.2.2 Extraction of Plant Roots

#### ***Objective and Principle***

This type of extraction is useful to measure root production in the soil. Indeed the production and turnover of roots is one of the most significant inputs of carbon in the soil, the other inputs being root exudation and above-ground necromass production by the plant. The study of the carbon balance in the soil and in the atmosphere has been the object of intensive research and methodological compilations e.g. Anderson and Ingram (1989) that describe methods to estimate organic inputs in the soil.

Root extractions are also useful for observations of plant physiology such as classification of roots, estimation of their weight and length, chemical analyses, biological associations with fungi and bacteria.

Separation is generally carried out manually but several types of elutriation apparatuses are available.

#### ***Procedures***

Extraction is performed on intact samples from blocks or cylinders of soil. The samples must be stored in polyethylene bags at low temperatures or even better frozen. If a freezer is not available they can be dried and rewetted before washing, but the best approach consists in

washing the roots immediately after returning to the laboratory from the field.

In addition to organic matter content, the texture of the soil, compaction, and structure affect the difficulty of the extraction to a varying extent. The simplest method consists of gently washing the wetted samples with water on a sieve whose mesh size differs with the author: 2 mm for Abo (1984), 0.5 mm for Anderson and Ingram (1989);

The material remaining on the sieve can be washed with water and separated by decantation. To remove all the fragments, the residue often has to be sorted manually under water in flat containers. This work may require a binocular magnifying glass and very fine forceps. The difficulty of the work also depends on the type of soil and roots.

Many machines have been described that wash roots; most separate roots from soil by elutriation, i.e. washing the debris accompanied by their separation by flotation on a 0.5 mm sieve located far from the heavy particles. Fig. 9.2 shows a diagram of the apparatus designed by Smucker et al. (1982) which is based on the principle of hydropneumatic elutriation.

The apparatus built by Bonzon and Picard (1969) is suitable for the separation of roots from intact soil sampled in the form of cylinders or monoliths. It is composed of a set of 4 double sieves made of wood with a brass screen with a rectangular section (50 × 60 cm) and a cylindrical bottom. The top sieve has a mesh of 1.18 mm, and the bottom sieve of 1.4 mm. The sieves are set in a wooden frame that is moved backwards and forwards at 12.5 oscillations  $\text{min}^{-1}$  by an engine with a crank-connecting rod system. Samples of a volume of around 2 L are placed on the top sieve and jet water is directed onto the sample. Slurry is evacuated over the top of the raised edge of the top sieve. Once washing is complete, the contents of the sieves are transferred to a funnel equipped with a sieve with a very fine mesh.

This funnel contains the organic fragments but also stones and gravels with a diameter of over 1.4 mm. If there is a lot of gravel, the organic fragments should be separated using a strong jet of water directed at the base of the funnel and transferred onto a sieve placed below.

After mechanical fractionation of soil and roots, it may be necessary to manually sort the roots from the other organic debris and this operation can take several hours. Consequently there is no "ideal" machine that eliminates all manual operations.

All separation methods result in losses of fine roots and washing water and residues should be checked periodically to quantify these losses.

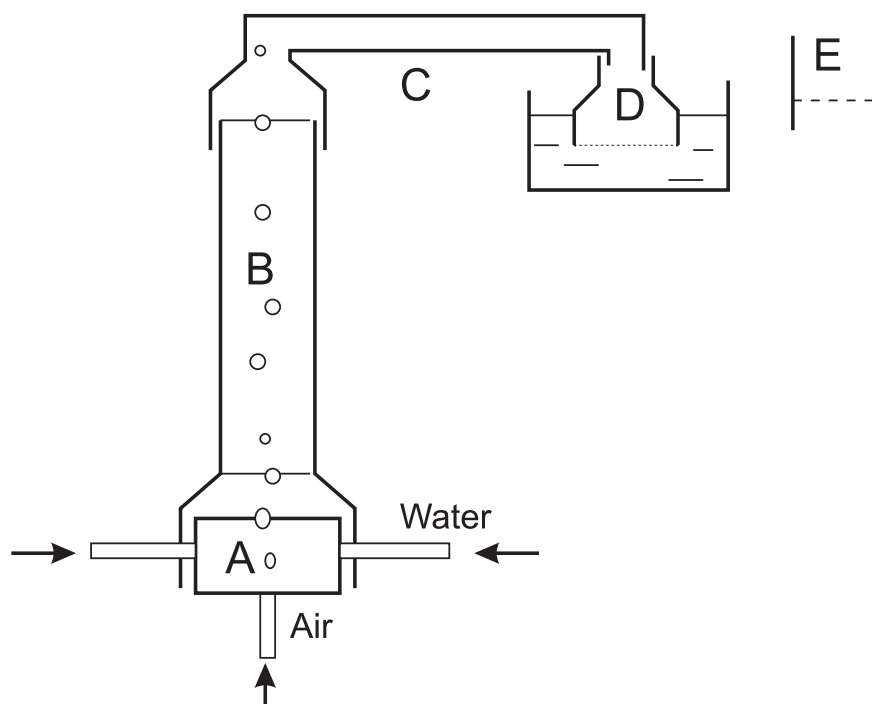

**Fig. 9.2.** Diagram of an apparatus for the separation of the plant roots from soil by hydropneumatic elutriation (after Smucker et al. 1982). **A:** high energy water washing chamber, **B:** elutriation chamber, **C:** transfer tube, **D:** first sieve with weak kinetic energy (840  $\mu\text{m}$ ), **E:** second sieve (420  $\mu\text{m}$ ). Tube **C** is separated from **B** for cleaning and to introduce a new sample. The roots are transferred from the weak energy sieve (**D**) by reversal and washing onto the fine sieve (**E**)

Soaking for one night in an aqueous sodium hexametaphosphate solution accelerates the process of washing roots in clay soils, but the chemical action may discolour the roots and break down certain plant tissues thereby rendering subsequent identification of live roots impossible. This type of pretreatment can also interfere with chemical analysis of the roots. In addition, all these treatments can damage the contents of tissues and it is consequently preferable to separate a sub-sample of roots by hand and to wash the roots carefully with a minimum of water to enable accurate chemical analysis.

The washed roots can be stored in the refrigerator in sealed polyethylene bags but freezing is preferable. A small quantity of bactericide such as thymol can also be added.

Dry matter weight and organic carbon and nitrogen content (cf. Chap. 10) can be measured after drying at 70°C for 48 h. Bonzon and Picard (1969) also measured the specific surface of the roots in addition to dry weight. Progressive calcination up to 550°C with successive temperature steps enables determination of the ash weight of the roots and quantification of the inorganic elements after dissolution of the residues in acid solution.

### 9.2.3 Dispersion of the Particles

#### ***Structure of the Soil and Organic Components***

As mentioned in the introductory section to this chapter, soil always contains varying proportions of coarse materials of inorganic (coarse sands, gravels) or organic origin (plant fragments), in addition to structural aggregates whose form and stability vary with the type of soil.

In active medium (*mull*), humification processes result in relatively large quantities of transformed organic matter: microbial metabolites with a rapid turnover (e.g. many polysaccharides), and very stable phenolic products, both of which are accounted for by SOM decomposition models (Pansu et al. 2004). Both types of materials can bond to mineral matter to form organomineral complexes such as the cements contained in soil micro-aggregates. These micro-aggregates also comprise the building materials of larger aggregates containing organic particles, organic debris and microbial species (Fig. 9.1).

In soils with a low level of activity (*moder, mor*), the formation of a strongly differentiated profile with a resistant organic matter horizon (*moder, mor*) is likely, along with a horizon in which redistributed organic matter accumulates resulting in the organomineral complexes of the structures of precipitation (Bruckert, 1994).

Fractionation thus depends on the different forces of cohesion of the soil structure. In certain cases, simple moistening is enough to break down the macro-aggregates and disperse the fine particles (slaking). In other cases, more energetic dispersion techniques are needed to release the micro-aggregates and the organic fragments embedded in the structural aggregates.

### ***Dispersion Techniques***

Dispersion consists in breaking certain organomineral binding forces without fragmenting plant debris, and if possible avoiding damaging microbial cells or the structure of the micro-aggregates. It should be kept in mind that the aim of granulometric fractionation of organic matters is very different from particle-size analysis of soil (cf. Chap. 2). In particle-size analysis, very energetic methods are used to destroy clay-humic “cements” e.g. destroying organic matter with hydrogen peroxide, destroying organomineral bonds with reagents that are highly complexing for iron and aluminium such as sodium tetraborate or sodium pyrophosphate.

Such techniques are not appropriate here since the organic components need to be recovered without them being damaged or dissolved. The most useful methods can be classified in three groups:

- dispersion with water and possibly with mechanical agitation of varying strength
- sonic and ultrasonic dispersion
- chemical dispersion with dispersing reagents that are not too aggressive for organic matter.

### ***Mechanical Dispersion with Water***

Bruckert (1994) recommended this type of dispersion technique rather than techniques using ultrasounds whose action varies considerably with the type of organomineral cement of the aggregates and is considered to be too destructive for some soil compounds as ultrasounds break fragile minerals and damage certain organic matter, but especially “cause the breakdown of the microbial cells from which the protoplasmic contents come to be adsorbed on clays (Mc Gill et al. 1975)”.

The technique of Bruckert et al. (1978) is a low-impact mechanical treatment by controlled agitation in the presence of agate balls (35 g of dry soil sample from the fine earth prepared at 2 mm, 200 mL water is placed in a rotary shaker with five agate balls and agitated at 50 rpm for 15 h). Feller (1979) developed a similar technique on tropical sandy soils with low humus content. In this case the recommended mechanical action is even more moderate: 100 g soil agitated for one hour with three glass balls in 300 mL distilled water.

Andreux et al. (1980) studied a standard steppe soil of the *chernozem* type with a very stable clay–humus complex. The dry soil was sieved to 2 mm, shaken by slow rotation (40 rpm) in water (35 g of soil for 200 mL water) for one night at 20°C with different numbers of agate balls. The rates of the fine clay–silt fraction (0–50 µm) obtained by these authors increased from 57% of the soil weight with agitation without agate balls

to 90% of the soil weight when mechanical fragmentation was used. Beyond two, the number of balls had a limited influence on the rate of the fine fraction (Fig. 9.3). On the other hand, up to 15 h of agitation the rate increased without reaching the next stage, revealing that destruction of all aggregates bigger than 50  $\mu\text{m}$  is progressive. However, beyond a certain degree of mechanical action (more than three balls for 15 h of agitation or five balls for more than 8 h of agitation), the treatments appear to solubilize part of the carbon, so very aggressive mechanical action is not recommended.

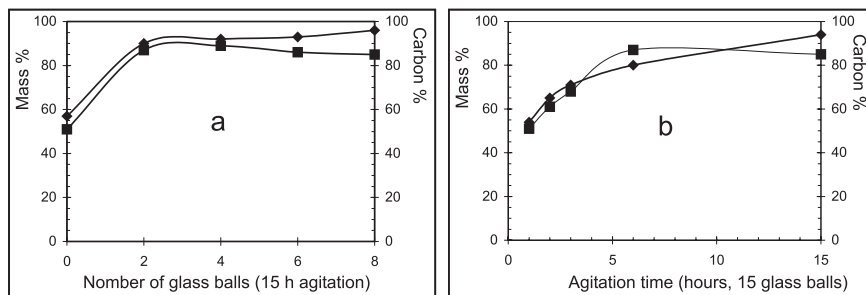
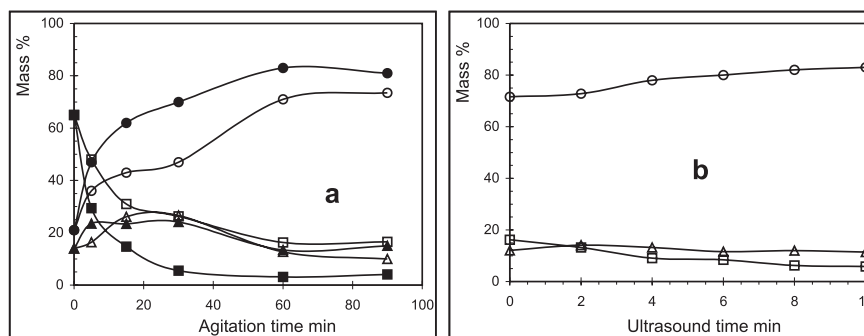

**Fig. 9.3.** Influence of the number of 10 mm agate balls (a), and length of agitation (b) on the fragmentation of the aggregates  $>50 \mu\text{m}$  (after Andreux et al. 1980) filled diamond mass percent of the 0-50  $\mu\text{m}$  fraction, filled square carbon content of the 0-50  $\mu\text{m}$  fraction as a percentage of total C

Sidi (1987) also used fragmentation by agitation with glass balls on a Tunisian carbonated soil. Fig. 9.4a shows the influence of the length of agitation on particle size distribution with or without the presence of three glass balls (15 g of soil, 100 mL water, back and forth agitation with one back and forth movement per second). The main effect of the mechanical treatment was the destruction of the biggest macro-aggregates (200–2000  $\mu\text{m}$ ) whereas the percentage of aggregates of intermediate size (50–200  $\mu\text{m}$ ) remained almost identical with or without the balls. The shape of the curves also suggested that the process of fragmentation occurs in stages (1) division of the biggest aggregates ( $>200 \mu\text{m}$ ) into intermediate aggregates (50–200  $\mu\text{m}$ ) during the first 30 min of agitation, followed by (2) division of the 50–200  $\mu\text{m}$  aggregates into micro-aggregates of the size of clays and silts (0–50  $\mu\text{m}$ ). In contrast to the situation illustrated in Fig. 9.3, one hour of agitation with three glass balls was enough to reach a dispersion plateau for this type of soil.

Monnier et al. (1962) recommended performing dispersion procedures before densimetric fractionations (cf. Sect. 9.2.4): either by dry

sieving to 500  $\mu\text{m}$ , or boiling in water followed by one rinse in alcohol and one period in the drying oven.



**Fig. 9.4.** Dispersion of a Mediterranean soil with water (according to Sidi 1987, 15 g soil/150 mL water, back and forth shaking apparatus, 1 backwards-forwards movement per second) **a:** influence of length of agitation with and without three glass balls *filled square, open square* 200–2,000  $\mu\text{m}$  with and without balls, respectively, *filled triangle, open triangle* 50–200  $\mu\text{m}$  with and without balls, *filled circle, open circle* 0–50  $\mu\text{m}$  with and without balls; **b:** influence of ultrasounds (80 W–80 kHz) on agitation for 1 h without balls

### Sonic and Ultrasonic Dispersion

Although occasionally severely criticized for being too destructive for certain organic matter (Bruckert 1994), sonic and ultrasonic dispersion techniques are generally recommended for the physical fractionation of soil organic matter.

Edwards and Bremner (1967) subjected an aqueous suspension of the soil sample (10 g soil for 25 mL water) to sonic vibration (9 kHz, 50 W) with a Raytheon S-102A vibrator (Raytheon Co., Norwood, MA USA). For 14 soils of very different texture, dispersion in fine particles of the size of clays (<2  $\mu\text{m}$  s) by sonic vibration for 30 min was evaluated by the pipette particle-size fractionation method (cf. Chap. 9). Fig. 9.5 shows that dispersion was always much higher than by simple agitation in water. Dispersion was comparable with that obtained with the two chemical dispersants tested: calgon peroxide and sodium resin.

The rate of dispersion obtained on the suspensions with an ultrasonic probe MSE Cabinet Model 60 Ultrasonic disintegrator (Measuring and Scientific Equipment Ltd, London) delivering a frequency of 18–20

kHz and a power of 60 W, is very similar to that obtained by sonic vibration (Fig. 9.6). Beyond 30 min (the period recommended by the authors) the duration of sonification had only a slight influence on the percentage of clay obtained (Fig. 9.7), Fig. 9.4b shows a comparison of the influence of the period of sonification observed by Sidi (1987) with a slightly more powerful high frequency ultrasound probe (80 kHz, 80 W); in this case a plateau was reached earlier (at 8–10 min) for the dispersion of the particles the size of silt (0–50  $\mu\text{m}$ ).

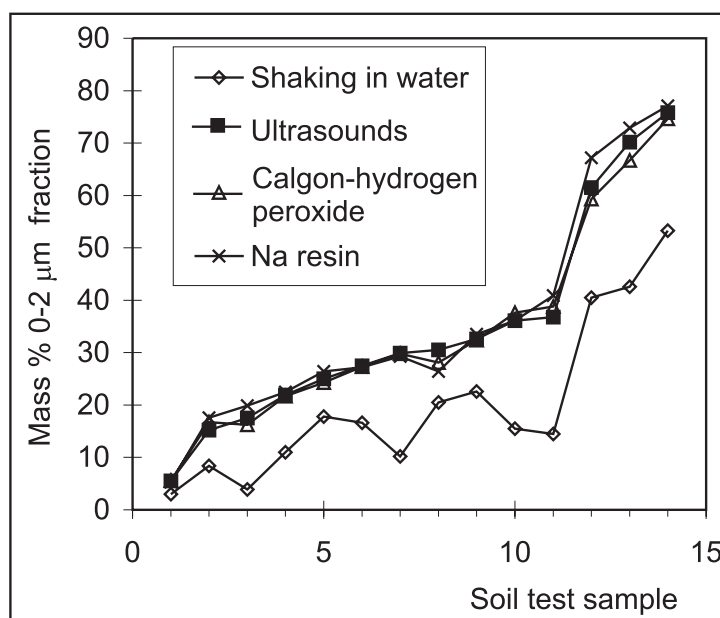

**Fig. 9.5.** Rates of clayey fractions obtained by ultrasonification and three other dispersion techniques on 14 soils (after Edwards and Bremner 1967)

After a detailed analysis by Watson (1971) of the ultrasonic vibration method applied to the dispersion of soils, Genrich and Bremner (1972) re-evaluated the technique following some criticism of its use. They used 28 soils covering a very varied field of pH (3.6–8.2), carbonate content (0–34%  $\text{CaCO}_3$ , texture (2–59% of sand, 7–72% of clay) and organic content (0.14–9.4% organic C). They tested two types of instruments (Heat Systems Ultrasonics Inc, Plainview, NY USA) (i) a standard Branson W-185C model with probe (20 kHz, 80W) and (ii) a Branson 220 ultrasonic cleaner with stainless steel tank (40 kHz, 100W). Different procedures were used with the tank model (soil:water ratios of the suspensions, sonification in an Erlenmeyer flask or directly in the



tank). With the probe model, the end of the probe (diameter 1.27 cm) was immersed to 2 cm below the surface of the suspension (10 g of soil in 25 mL water) in tubes of steel cooled on the outside to less than 20°C.

**Fig. 9.6.** Comparison of clay rates obtained on five soils by sonic (9 kHz, 50 W) and ultrasonic (18–20 kHz, 60 W) dispersion for 30 min on suspensions of 10 g of sample in 25 mL water (after Edwards and Bremner 1967).

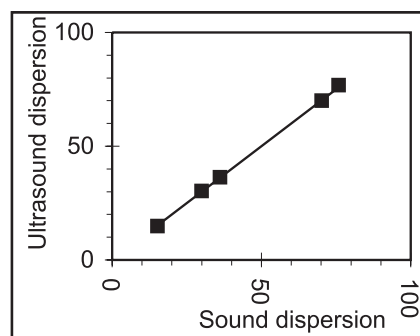

In all cases, more complete dispersion was obtained with the probe model than with the tank model. However, the dispersion provided by the probe depended to a great extent on the quality of its surface: with a pitted probe, the authors observed that the length of time needed for dispersion was two to four times longer than with a probe in good condition. It is consequently important to gently polish the end of the probe with a fine abrasive paper after each 30-min period of use. According to Genrich and Bremner, the imperfect condition of the probes could explain the failures noted by other authors before their trials.

They also showed that with a 15-min period of sonification with the probe, under the conditions described above, the clay rates obtained on their 28 soils were always equal to or higher than those obtained with the sodium peroxide and polyphosphate method of Kilmer and Alexander (1949) which at that time, was the standard method of dispersion (Soil Survey, 1960). This study clearly demonstrated the dispersion power of ultrasonic probes. However, the authors' conclusion was cautious saying that no method of dispersion can be described as universally applicable for all soils.

Anderson et al. (1981) studied the distribution of organic matter in the particle fractions of two soils of the *chernozem* type. They carried out the dispersion of these soils by ultrasonic vibrations for 8 min with more power than previously (300 W, apparatus Bransonic 1510) but applied to more diluted suspensions (soil:water ratio of 1:10). Tiessen and Stewart (1983) studied the effect of cultivation on the organic composition of the particle fractions using a procedure similar to that of Anderson et al. (1981).

On a soil of the *chernozem* type, Shaymukhametov et al. (1984), like Anderson et al. (1981), observed a stage of fragmentation of micro-aggregates (<50  $\mu\text{m}$ ) after sonification for 30 min, whereas in one minute, 96.4% of the larger aggregates were destroyed. Their experiment highlighted the very great difference in stability between micro-aggregates and structural aggregates (Fig. 9.1). It should also be noted (Fig. 9.7) that the degree of stability of the three sizes of micro-aggregates between 1 and 50  $\mu\text{m}$ , is very similar, the probable explanation being that ultrasounds cause the progressive release of fine clayey particles from the three classes of the silt-size micro-aggregates with no distinction between the classes. This is different from the behaviour of structural aggregates where there is a clear difference in stability between the 50–200  $\mu\text{m}$  and 0–50  $\mu\text{m}$  fractions (Fig. 9.4).

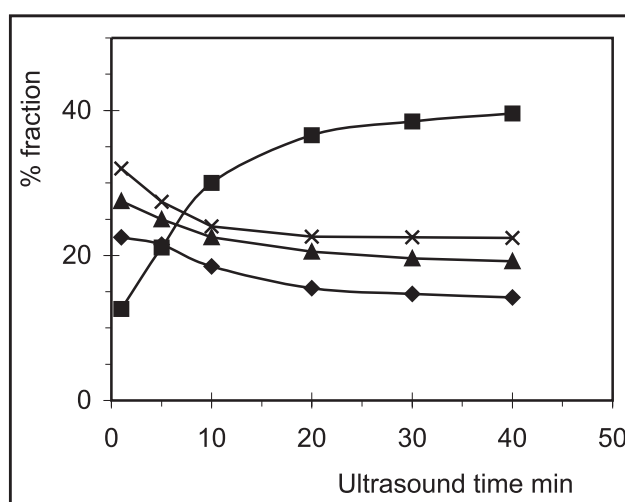

**Fig. 9.7.** Effect of the duration of ultrasound treatment on fragmentation of micro-aggregates <50  $\mu\text{m}$  (after Shaymukhametov et al. 1984): filled square <1  $\mu\text{m}$ , filled diamond 1–5  $\mu\text{m}$ , filled triangle 5–10  $\mu\text{m}$ , times 10–50  $\mu\text{m}$

In order to study the organic matter of an *aquoll*, Catroux and Schnitzer (1987) performed ultrasonic dispersion on soil in water suspensions at a ratio of 1:5 (between the ratios used by Genrich and Bremner, 1972, and by Anderson et al. 1981). 100 g of soil in 500 mL distilled water were agitated on a magnetic stirrer and treated by ultrasound with a Blackstone SS2 generator. Power was applied at 400 W for 15 min, (which is a more energetic treatment than that applied by the preceding authors) and the end of the probe was immersed to 2–3 cm below the surface of the liquid in order to decrease the swirling action.

Gregorich et al. (1988) tried to define and quantify the action of ultrasounds more precisely. Ultrasonic vibrations cause cavitation due to the formation of microscopic bubbles resulting from local reductions in pressure and the subsequent bursting of these bubbles. When the bubbles burst in the suspension, they produced waves of pressure of sufficient mechanical energy to break the aggregation bonds. These authors used a 20 kHz Branson probe whose power could be adjusted from 0 to 150 W. The probe head (diameter 12 mm) was immersed to between 5 and 10 mm below the surface of the suspensions (15 g of 1–2 mm aggregates in 75 mL water). The output power of the probe was gauged by measuring the rise in temperature of a known water mass over a given period. Gregorich et al. considered that the most significant parameter is the quantity of energy applied per mL of suspension:

$$J = P t V^{-1}$$

where  $J$  is the applied energy in  $\text{J mL}^{-1}$ ,  $P$  is the output power of the probe in W,  $t$  is the time in s,  $V$  is the volume of suspension in mL.

Figure 9.8 shows the results obtained by these authors on a melanic humus gley horizon of a cultivated brunisol. This type of material has very resistant silt particles. None of the ultrasonic treatments enabled their fractionation as thoroughly as treatment by agitation in the presence of hydrogen peroxide. The principal bond between these particles thus appears to be primarily organic. These authors also observed stronger bonds between macro-aggregates (or pseudo-sands) than in the majority of studies quoted above, energy ranging between 300 and 500  $\text{J mL}^{-1}$  being required to disperse these aggregates which are relatively rich in organic matter. As is true for silt particles, organic matter thus seems to act as cement, particularly in macro-aggregates. One possible explanation is that their organic functioning is a little different (partly anaerobic) in this type of soil from the examples above.

Balesdent et al. (1991) studied the effect of ultrasounds on the granulometric distribution of the organic matter contained in 17 soils (Ap horizons of cultivated soils), type brown soils, or not very processed alluvial soils. The procedure they used combined mechanical and ultrasonic dispersion techniques. The first mechanical dispersion used rotary shaking of the aqueous suspensions with glass balls similar to the techniques described above (Andreux et al. 1980). Sonification was then applied to the fraction below 50 or 25  $\mu\text{m}$  in order to split it into three

particle sizes: 0–0.2, 0.2–2, 2–50  $\mu\text{m}$  (or 2–25  $\mu\text{m}$ ). The ultrasound apparatus used was the same type as the one used above (Branson cell disintegrator, 20 kHz, 150 kW, probe with a flat head 13 mm in diameter).

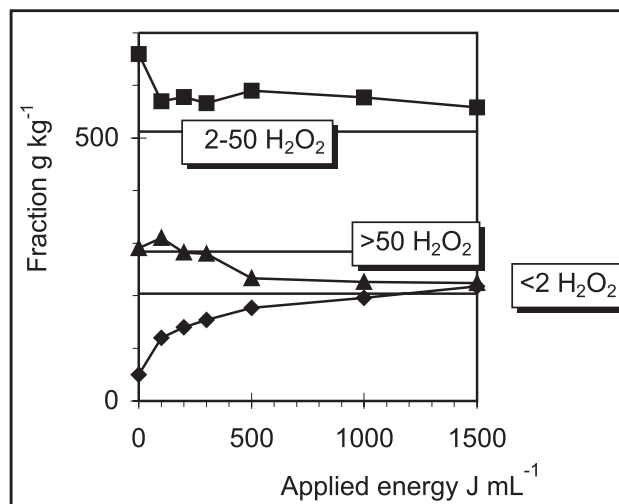
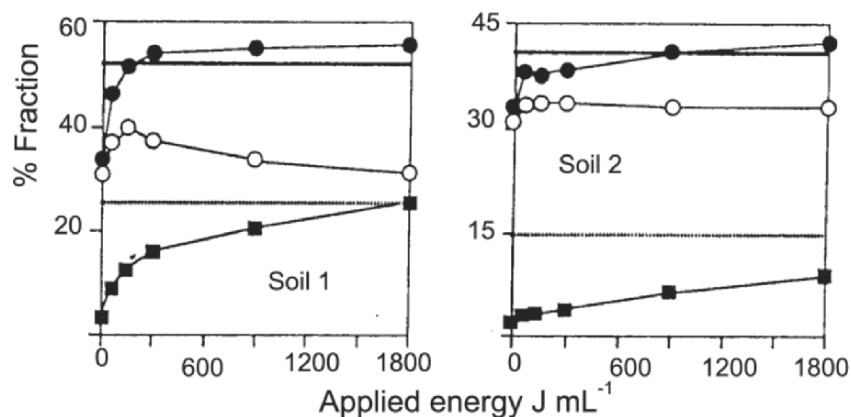

**Fig. 9.8.** Ultrasonic dispersion of a melanic humus gley horizon of a cultivated brunisol (after Gregorich et al. 1988): *filled triangle* >50  $\mu\text{m}$  fraction, *filled square* 2–50  $\mu\text{m}$  fraction, *filled diamond* <2  $\mu\text{m}$  fraction; horizontal lines represent dispersions obtained after  $\text{H}_2\text{O}_2$  treatment of destruction of organic matter

A kinetic study of the action of ultrasounds on silt-size micro-aggregates was performed by Balesdent et al. (1991). Sonification was applied to suspensions of 100 mL with a soil:water ratio of 1:3, the probe was immersed to 3 cm below the surface and the apparatus regulated at 70% of its power (corresponding to  $0.5 \text{ W mL}^{-1}$  from the manufacturer). Figure 9.9 shows changes in 0–0.2 and 0.2–2  $\mu\text{m}$  fractions and their sum (0–2  $\mu\text{m}$ ) compared to the reference method (hydrogen peroxide treatment and pyrophosphate dispersion).

Compared to the results of Gregorich et al. (Fig. 9.8), the dispersion of soils studied by Balesdent et al. appears to be easier as it has a stable production of 0–2  $\mu\text{m}$  clay fraction from 300 to 1,800  $\text{J mL}^{-1}$  (Fig. 9.9). In comparison, the clay fraction in Fig. 9.8 there is a continuous increase with an increase in the energy applied. However, Fig. 9.8 shows a clean break in the slope of the curve of the clay fraction for an energy of approximately 300  $\text{J mL}^{-1}$ , i.e. about the energy needed to reach the stage shown in Fig. 9.9. In a clay latosol, Roscoe et al. (2000) found that

energies of 260–275  $\text{J mL}^{-1}$  were sufficient to break down unstable aggregates (2,000–100  $\mu\text{m}$ ) and to leave stable aggregates (100–2  $\mu\text{m}$ ) unchanged.



**Fig. 9.9.** Effect of the energy of the ultrasonic treatment on fragmentation of micro-aggregates the size of clays in an alluvial soil (1) and a weathered brown soil (2); horizontal lines represent dispersions obtained by chemical treatment with  $\text{H}_2\text{O}_2$  then  $\text{Na}_3\text{PO}_4$  (Balesdent et al. 1991): *filled square* 0–0.2  $\mu\text{m}$  fraction, *open circle* 0.2–2  $\mu\text{m}$  fraction, *closed circle* 0–2  $\mu\text{m}$  fraction

It is difficult to compare the data of Balesdent et al. (Fig. 9.9) with that of Shaymukhametov et al. (Fig. 9.7) where the cutting threshold of the fine fractions was at 1  $\mu\text{m}$ . However, in both cases, the length of sonification needed to reach the 0–2  $\mu\text{m}$  and 0–1  $\mu\text{m}$  stages was quite similar. The more detailed study by Balesdent et al. of the fractionation of the fine 0–2  $\mu\text{m}$  fraction provided interesting additional information on two aspects:

- even with the highest energy of sonification, a stable stage is not reached for the fine fraction below 0.2  $\mu\text{m}$ , and the dispersion of this fraction is always lower than that obtained with the chemical method of reference;
- on one of the soils, the intermediate fraction (0.2–2  $\mu\text{m}$ ) reached maximum after around 5 min of sonification (150  $\text{J mL}^{-1}$ ). This suggests an initial stage in the fragmentation represented by the division of the aggregates of silt size (2–25  $\mu\text{m}$ ) into smaller units (0.2–2  $\mu\text{m}$ ) rather than the fragmentation of the 0.2–2  $\mu\text{m}$  fraction. The behaviour of associations within the clay-size fraction is apparently different from that observed within the silt-size fraction where the three particle-size ranges studied (Fig. 9.7) displayed the same stability. Instead it resembles that observed for macro-aggregates (Fig. 9.4): the

large structural aggregates ( $>200\ \mu\text{m}$ ) are less stable than the intermediate macro-aggregates ( $50\text{--}200\ \mu\text{m}$ ).

Finally, for the soils they studied, Balesdent et al. recommended a sonification period of 10 min ( $600\ \text{J mL}^{-1}$ ) in the conditions described above. Dispersion of the silt micro-aggregates (to  $2\ \mu\text{m}$ ) can then be considered complete, whereas the coarse clay fraction ( $0.2\text{--}2\ \mu\text{m}$ ) must be considered as micro-aggregated.

Balesdent et al. also studied the effect of ultrasounds on the coarse organic debris separated in water after the action of glass balls. The study was on an alluvial soil containing 27% clay, and 0.9% organic carbon with a pH of 7. Corn and maize had been grown on the soil for 17 years so the coarse fragments mainly came from these plants. The ultrasound treatment was applied at different energies to aqueous suspensions at a ratio of 1:200 of each of the three light fractions:  $200\text{--}2,000\ \mu\text{m}$ ,  $50\text{--}200\ \mu\text{m}$  and  $25\text{--}50\ \mu\text{m}$ . The suspensions were then sieved at  $25\ \mu\text{m}$  and if necessary at  $50$  and  $200\ \mu\text{m}$ . The  $0\text{--}25\ \mu\text{m}$  suspension was separated by sedimentation into fractions of  $0\text{--}5\ \mu\text{m}$  and  $5\text{--}25\ \mu\text{m}$ .

The results showed a very destructive effect of ultrasounds on the organic debris. After 10 min (the recommended time for fractionation of clayey particles), more than 60% of the carbon of the initial coarse organic fraction was split into the lower particle-size ranges, and this was the case for each of the particle-size ranges studied. These authors showed that part of this fractionation results from the separation of clay fractions associated with plant fragments; but cleaning of the plant fragments is insufficient to explain the quantities of organic matter transferred to the finer fractions.

The use of ultrasounds under the conditions required for dispersion of clays produces marked fractionation of the coarse plant fragments. This significant observation led the authors to propose a procedure for particle size fractionation that uses only ultrasounds for the suspension of particles of less than  $50\ \mu\text{m}$  (cf. Sect. 9.2.4).

### ***Chemical Dispersion***

Chemical dispersion techniques are less widely used for organic fractionation than for classical soil particle size analysis (cf. Chap. 2).

As mentioned in Sect. 9.2.2, sequestering reagents such as sodium tetraborate or hexametaphosphate can only be used to disperse clay soils when the aim is to recover roots or coarse plant fragments (Anderson and Ingram, 1989). But even in this case, there is a risk of

discolouration that subsequently makes it difficult to identify living roots, and of modification of the organic contents.

Dispersing reagents that are highly destructive for organomineral bonds are not recommended for the study of particle-size distribution of organic matter. Their too high extracting power, in particular of humic and fulvic acids (cf. Chap. 11), is likely to distort the results of such studies. Less aggressive extracting reagents should be used such as monovalent neutral salts which cause the dispersion of clays by exchange with the di- or trivalent cations of the exchange complex and the consecutive rupture of certain organomineral links.

Ladd et al. (1977), Oudinot (1985), Sallih and Pansu (1993) used a sodium bicarbonate solution as a complement to the mechanical action of agitation for the initial dispersion of the soils.

Sodic resins have also been used for the dispersion of soils (Edwards and Bremner 1967, Rouiller et al. 1972). Adapted from studies by Edwards and Bremner, Fig. 5 shows that using the resin technique, dispersion is slightly higher than using the two other methods tested for most of the 14 soils in this experiment.

Feller et al. (1991) compared different dispersion techniques, including an IRN77 amberlite resin in a sodic state. The resin was tested alone (R) or combined with ultrasonic fractionation on the fraction below 50  $\mu\text{m}$  (R/US). The resin technique was compared with five other dispersion methods which were all combined with the same ultrasonic fractionation of the fractions below 50  $\mu\text{m}$ : a B/US method similar to that of Balesdent et al. (1991) described below, an NaCl/US method replacing the water in the suspensions by M sodium chloride solution, an M sodium hydroxide method bringing the suspension to pH10 (pH10/ US) and a 3.3  $\text{g L}^{-1}$  sodium hexametaphosphate method (HMP/US).

Figure 9.10 shows the comparative effectiveness of the different methods on a ferrallitic soil from Martinique. Up to the level of fine silts, the most effective dispersion was obtained using the R/US technique (resin on the total soil then ultrasounds on the fraction below 50  $\mu\text{m}$ ). On average, solubilization of organic matter was less than 4% of total carbon in the 19 soils studied. Based on the results of this experiment, the R/US technique appears to be preferable to the technique using glass balls plus ultrasounds (B/US) described above (Balesdent et al. 1991). However, the two methods were not tested on the same types of soils. In addition, the authors mentioned practical constraints in the use of the resins: the time needed for resin regeneration and preparation is rather long and there is a risk of contamination of the soil by very fine resin (<50  $\mu\text{m}$ ).

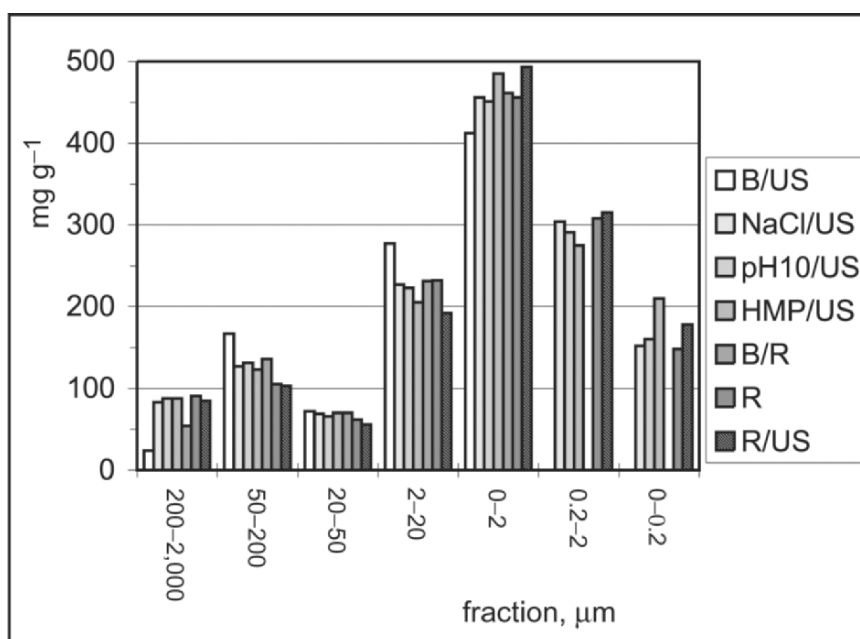
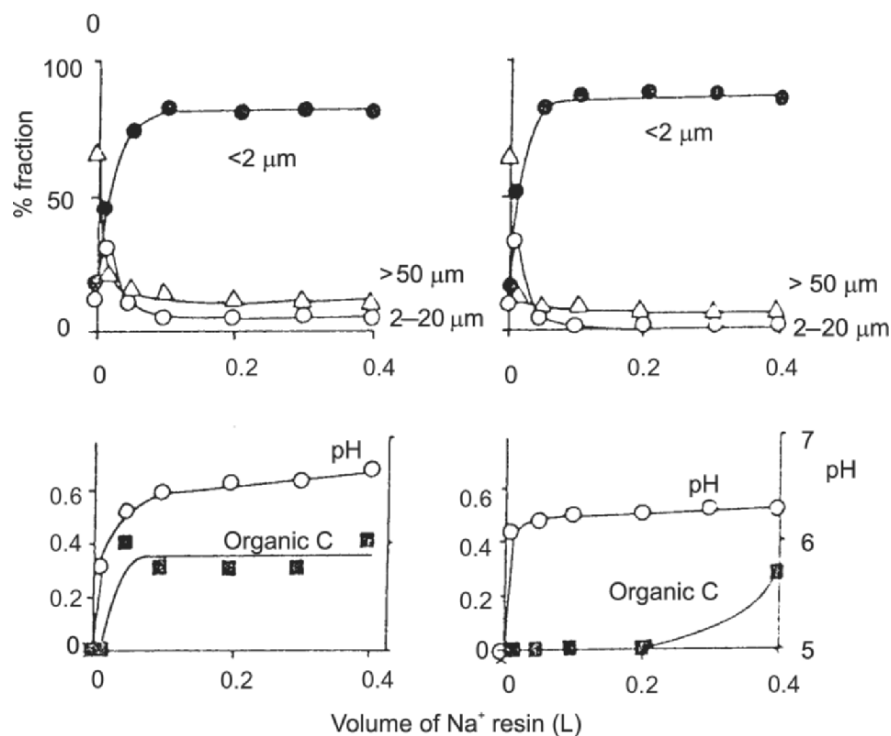

**Fig. 9.10.** Effect of different dispersion methods on particle size fractionation of a ferrallitic soil from Martinique (according to Feller et al. 1991): **US**: ultrasonification of the 0–50  $\mu\text{m}$  fraction, **B**: stirring with balls, **NaCl**: NaCl solution, **pH10**: NaOH solution, **HMP**: sodium hexametaphosphate solution, **R**: stirring with sodic resin

The sodic resin technique was also shown to be the most effective of the five dispersion techniques for stable oxisols with high gibbsite content (Bartoli et al. 1991). These authors also studied the influence of the soil:sodic resin ratio on dispersion, pH of the suspensions, and carbon solubilization. Volumes of 0, 10, 50, 100, 200, 300, 400 mL Amberlite IR-120 (500  $\mu\text{m}$ ) sodic resin in nylon bags with a 50  $\mu\text{m}$  mesh were added to samples of 2.5 g soil in 200 mL distilled water. The suspensions were agitated for 16 h on a rotary shaker at 40 rotations per minute. The results in Fig. 9.11 show a stable stage of aggregate breakdown for volumes of resin ranging between 50 and 200 mL, this corresponds to the volume (100 mL) used by Feller et al. (1991). There was a rise of between one and two units in the pH of the suspensions; in all cases the final pH remained lower than that of the main extracting reagents of the humic acids (cf. Chap. 11). In the deeper horizon, dissolution of organic carbon only became perceptible with volumes of resin above 200 mL; on the other hand, in the cultivated surface horizon, the authors noted dissolution of organic carbon at all doses of resin independently of the



added volumes; this horizon probably contains more recently formed organic matter which is not very humified, and is water soluble.



**Fig. 9.11.** Influence of the volume of sodic resin (2.5 g for 200 mL distilled water) on dispersion of the aggregates, the pH of the soil suspension, and solubilization of organic carbon in a surface horizon (on the left) and a deep horizon (on the right) of a Nigerian oxisol (Bartoli et al. 1991)

## 9.2.4 Separation by Density

### *The Techniques*

The first methods used to separate the organic fragments in the soil were usually based on an obvious physical property: the density of free organic matter, which is close to 1, is lower than that of the organomineral complex. However, the first density techniques were used for the separation of primary minerals (Pearson and Truog, 1937). Starting from the work of Lein (1940), Hénin and Turc (1949) adapted a densimetric separation technique for free organic matter in soils. Fractionation was performed in beakers containing a mixture of bromoforme and benzene.

The technique was improved by Jeanson-Luusinang (1960) by the use of special decantation funnels, and then further improved by Monnier et al. (1962) who adapted an earlier technique of Lein (1940) for density separation by centrifugation.

The centrifugation technique improved the use of differences in density, but neither of these two techniques extracts all the light organic matter. Monnier et al. (1962) carried out tests with synthetic mixtures of mineral soil and oat straw. For fragmentation of straw in particles of less than 0.2 mm, the recovery rate was 73% of the added straw with the technique of Monnier et al. and 44% of the added straw with the technique of Jeanson-Luusinang. The method of Monnier et al. was used to model the evolution of carbon stocks by Arrouays (1994).

Greenland and Ford (1964) used ultrasounds to disperse the aggregates before density separations (cf. sect. 9.2.3). The technique was improved by Ford et al. (1969) with the use of surfactant and of dibromochloropropane (DBCP density = 2.06) instead of bromoforme for density separations. At that time authors were not concerned with the possible toxicity of these products, which today is widely acknowledged.

Turchenek and Oades (1979) studied methods of density fractionation of organic matter by combining them with preliminary particle-size fractionations. They carried out from 4 to 7 density fractionations with mixtures using decalin (decahydro naphthalene  $d = 0.88$ ), dibromochloropropane (DBCP  $d = 2.06$ ) and bromoforme ( $d = 2.88$ ) on most of the seven standard particle ranges (coarse sands, fine sands, coarse silts, fine silts, coarse clays, medium clays, fine clays).

Their observations showed that more than 50% of the light fraction ( $d < 2.06$ ) with a particle size of coarse and fine sands is made up of organic matter. The fraction comprising coarser particles is mainly made up of recognizable plant fragments with high C:N ratios and low solubility. The fraction made up of finer particles (fine sands to coarse clays) contains a higher proportion of identifiable microbial cellular debris and soluble aromatic humic compounds.

The light clay fractions are also rich in organic materials. Forms of oxidized iron, aluminium and silicon are present to a significant degree in all the fractions, indicating a wide range of different interactions between inorganic and organic matter.

Nowadays none of the density methods using chlorinated heavy solvents are used because of the toxicity of this type of solvent and of the safety requirements in laboratories.

Dabin (1976) proposed a method for the fractionation of organic materials (cf. Chap. 11). The first part of this method comprised density

fractionation on phosphoric acid 2 M ( $d = 1.2$ ). In addition to its low toxicity compared to density liquors, this type of acid treatment has the advantage of destroying carbonates in calcareous soils releasing a certain proportion of sequestered plant material. Sidi (1987) used this technique to separate light fractions from mixtures of soils and wheat straw incubated in controlled laboratory conditions. The method was used to propose a descriptive model of carbon dynamics with three compartments (Pansu and Sidi 1987).

The Ladd et al. (1977) method includes a series of particle-size and density fractionations that are also suitable for calcareous soils. A modification of this method allowed, in its first stage, fractionation of the light materials from *in vitro* incubation experiments of mixtures of soils and  $^{14}\text{C}$  labelled wheat straw (Cortez 1989, Sallih and Pansu 1993). The suggested modification concerned the use of an aqueous saturated zinc sulphate solution ( $d = 1.4$ ) as heavy liquid, whereas Ladd et al. had used carbon tetrachloride ( $d = 1.59$ ). Among the different high-density saturated saline solutions possible, zinc sulphate and ferrous sulphate (density = 1.6) appeared to be particularly promising. A zinc sulphate solution was selected to avoid the sequestering of iron on the organomineral complexes. However, it is probable that the zinc element also results in the formation of certain complexes. Other mineral density liquors have also been used including zinc chloride solutions (Besnard et al. 1996), sodium metatungstate (Elliott et al. 1991), sodium polytungstate (Cambardella and Elliott 1993, Golchin et al. 1994, Six et al. 1999), Ludox, aqueous suspension of silica colloidal particles (Meijboom et al. 1995).

Anderson and Ingram (1989) recommended methods of fractionation of light materials with water that are rather similar to those described for the extraction of roots. The light fraction is defined as the fraction (1) which floats when it is dispersed in water, (2) which passes through a sieve of 2 mm but not through a sieve of 0.25 mm. However these authors pointed out that elutriation and sieving methods separate significantly less free organic matter than density methods. The methods of separation in water are nevertheless worthwhile because less organic matter is solubilized in water than in dense liquors, which are often rather corrosive (Beare et al. 1994, Puget et al. 1996).

### **Procedures**

Only procedures for the methods of Monnier et al. (1962), Dabin (1976) and density liquor  $\text{ZnSO}_4$  are described here (cf. Sect. 2.4.1 “The Techniques” for modifications).

#### ***Method Using Organic Heavy Liquid***

The density liquid should be adjusted to the density selected by mixing bromoforme with a lighter solvent, preferably alcohol (Monnier et al. 1962). The density recommended by the authors who worked on silt soils in the area of Versailles (France) is 2. These authors pointed out that more complete separation could be achieved by the successive use liquids of density 1.75, 2 and 2.25.

The soil sample should be air dried and crushed to 2 mm particle size. Weigh 5–10 g of soil depending on the free organic matter content. The weight of the sample can be also adjusted as a function of the techniques to be used for quantification after fractionation (e.g. carbon determination on the whole light fraction). Place the sample in the 100 mL tube of a centrifuge, and fill the tube with the density liquid. After stirring with a glass rod, centrifuge for 5 min with an acceleration of about 1,000g in the centre of the tube. Collect the supernatant on a flat filter and repeat the operation again by suspending the centrifugation pellet in the heavy liquid.

It is possible to destroy aggregates to release embedded light organic matters before fractionation either by boiling in water then washing with alcohol and drying in the drying oven, or by sieving the dry sample at 500  $\mu\text{m}$ .

In the case of soils with high free organic matter content, the risk of sequestration of dense particles within light organic materials is high and it is thus recommended to centrifuge the light materials again after washing in a different tube with the heavy liquid.

#### ***Density Method with Phosphoric Acid***

The method of Dabin (1976) applies to soil sieved to 0.5 mm. The weight of the sample can vary from 5 g to 40 g depending on the organic content. Agitate for 30 min on a back and forth shaker (1 backwards–forwards movement per second) with 200 mL of a 2 M phosphoric acid aqueous solution (136 mL  $\text{L}^{-1}$ ). Centrifuge for 20 min at 3,000g then transfer the supernatant on a filter. Repeat this operation twice. Dry and weigh the plant matter recovered on the filter. The total carbon of this material can be measured by combustion and determination of released carbon dioxide; nitrogen can be measured simultaneously with a CHN analyser, or separately using the Kjeldhal method (cf. Chap. 10).

*Method by Sieving and Inorganic Heavy Liquid*

Figure 9.12 summarizes the procedure for extraction of free organic matter (FOM). Sieve a 80 g soil sample on a 5 mm sieve and put in suspension in 300 mL of 0.2 mol (NaHCO<sub>3</sub>) L<sup>-1</sup> aqueous solution. After 1 h of moderate agitation on a rotary shaker, centrifuge at 12,000g for 30 min. Collect the light fraction by filtering the supernatant. The extraction can be repeated twice.

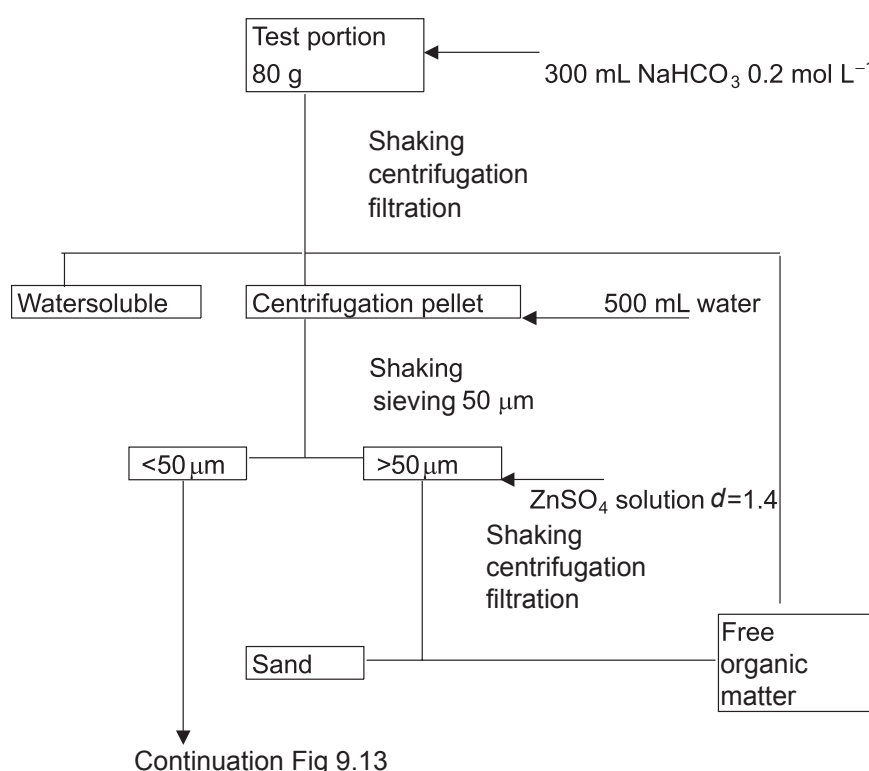

**Fig. 9.12.** Diagram of the separation of free organic matter by density and sieving

Suspend the centrifugation pellet in 500 mL water. For dispersion, place on a rotary stirrer for 2 min at maximum speed. Sieve on a 50 μm sieve in water. Suspend the coarse fraction (greater than 50 μm) in a heavy aqueous solution saturated in zinc sulphate (density 1.4). After 30 min of agitation at mean velocity, centrifuge at 3,000g, then filtrate the supernatant on a 3 μm Millipore membrane. Wash the light fraction recovered on this filter carefully four times with water, add to the previous light fraction; dry in the drying oven at 30°C.

If the sands do not have to be separated from FOM, the method can be simplified by leaving out density separation on the coarse fraction. In this case FOM is estimated by carbon determination on the fraction: “light matter separated on  $\text{NaHCO}_3$  + fraction greater than  $50\ \mu\text{m}$ ”. Certain types of soils studies with  $^{14}\text{C}$  tracers have shown that this simplified estimate is significantly more exhaustive than the preceding one (Sallih and Bottner, Cefe-CNRS Montpellier, France, unpublished data).

## 9.2.5 Particle Size Fractionations

### *Limits of Density Methods*

The use of the density method on its own for the study of organic components has sometimes been criticized, but not when density fractionation was coupled with particle-size fractionation. One of the reasons mentioned above is the toxicity of heavy organic liquids. This obstacle can be overcome by using heavy aqueous solutions saturated with mineral salts. According to Bruckert (1994), using density as the only criterion can also be challenged for several reasons:

- the ideal density to use varies with the type of soils. Thus, with a density of 1.8, 90% of the organic matter of andosols can be separated in the light fraction whereas in brown soils the percentage is only 20%
- the density of the plant debris increases during decomposition by incorporation of mineral matter which can be determined by ash quantification
- in the case of organic heavy liquids, organic compounds can fix on clays and perturb subsequent studies. As mentioned earlier, inorganic heavy liquids do not have this disadvantage, but they can modify organomineral complexes.

### *Procedures for Particle-Size Fractionation*

Given the remarks quoted in Sect. 9.2.3 about aggregate dispersion, it is difficult to describe a single procedure for particle size fractionation for all soil types. However four procedures appear to be appropriate for different soil types:

- the continuation of Section “Methods by Sieving and Inorganic Heavy Liquid” adapted from Ladd et al. (1977) on calcareous soils
- Agitation with Glass Balls and Ultrasonification (Balesdent et al. 1991) used on different cultivated soils of France

- “Resin H<sup>+</sup> and Ultrasounds” (Feller et al. 1991) used on tropical soils of various origins, with a simplified alternative for sedimentation (Gavinelli et al. 1995)
- a special procedure for use on sandy soils (Feller 1979; Feller et al. 1991).

*Continuation of the Procedure Described in “Method by Sieving and Inorganic Heavy Liquid” (cf. Sect. 9.2.4)*

In addition to separation of the “free organic matter” fraction described in “Method by Sieving and Inorganic Heavy Liquid” (Fig. 9.12), this method provides:

- a water-soluble organomineral fraction
- a fraction of more than 50  $\mu\text{m}$  (primarily inorganic, density  $>1.4$ )
- an organomineral fraction with particles of less than 50  $\mu\text{m}$ .

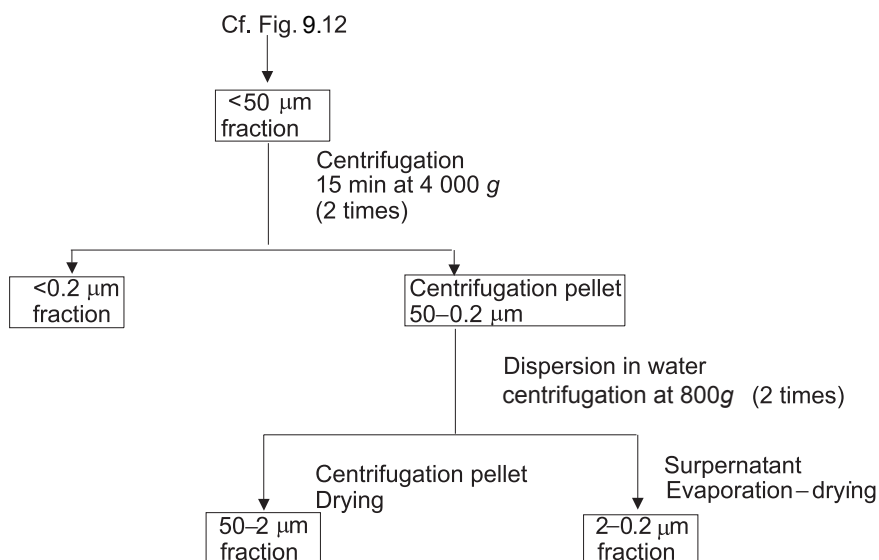

**Fig. 9.13.** Fractionation by centrifugation of the clay-silt fraction (complement of Fig. 9.12, after Ladd et al. 1977)

The complete method includes the separation of this last fraction into particles the size of silts (2–50  $\mu\text{m}$ ), coarse clays (0.2–2  $\mu\text{m}$ ) and fine clays (0–0.2  $\mu\text{m}$ ). The separation procedure described by Ladd et al. (1977) shown in schematic form in Fig. 13 should be used: (1) centrifugation for 15 min at 4,000g in a 250 mL tube makes it possible to separate the fine fraction (less than 0.2  $\mu\text{m}$ ) in the supernatant; (2) the centrifugation pellet is then suspended again with water and centrifuged

for 5 min at a low speed (800g); repeated twice, this operation makes it possible to isolate a centrifugation pellet of silt size (50–2  $\mu\text{m}$ ) and (3) a supernatant of coarse clay size (0.2–2  $\mu\text{m}$ ).

The two clay fractions and the water-soluble fraction are concentrated in a vacuum rotary evaporator at 40°C. The method (Figs. 9.12 and 9.13) thus provides six fractions: a water-soluble 0–0.2  $\mu\text{m}$  fraction, a 0.2–2  $\mu\text{m}$  fraction, a 2–50  $\mu\text{m}$  fraction, a heavy coarse fraction (size > 50  $\mu\text{m}$  and density > 1.4), and a light coarse fraction (size > 50  $\mu\text{m}$  and density < 1.4).

Dry each fraction in a Petri dish at a low temperature, depending on subsequent measurements either at room temperature (light matter) or in a drying oven or sand bath.

#### *Agitation with Glass Balls and Ultrasonification*

Figure 9.14 is synoptic diagram of fractionation after Balesdent et al. (1991). Dry the soils in air and sieve to 2 mm using a grinding–sieving machine with rollers (Pansu et al. 2001). Put a 50 g sample in a 250 mL plastic bottle with 180 mL of water and ten glass balls 5 mm in diameter. Agitate the bottle on a rotary shaker at 40 rpm for 16 h.

Filter the suspension underwater on a sieve with a 200- $\mu\text{m}$  square mesh. Put the nib in suspension in a beaker. The organic fragments are separated during their transfer to a 200- $\mu\text{m}$  sieve by decantation. Repeat this operation several times until the sands no longer contain any visible organic fragments. Perform the same operation on the fraction of less than 200  $\mu\text{m}$  with a 50- $\mu\text{m}$  sieve to obtain F200–2000, M200–2000, F50–200, M50–200 fractions (F being the organic fragments, M the organomineral part).

Centrifuge the suspension with particles <50  $\mu\text{m}$  to separate the particles of less than 0.2  $\mu\text{m}$  (cf. Continuation of the Procedure Described in); reserve the supernatant. Suspend the centrifugation pellet at a solid:water weight ratio of approximately 1:3. Subject the suspension to ultrasound treatment for 10 min under the conditions described in above i.e. at an applied energy of approximately 300 J mL<sup>-1</sup>. In samples containing limestone, it is recommended to eliminate carbonates in the suspension after ultrasound treatment by adding HCl solution to a pH of 3.5 on the pH-meter, and to wash the solid residue before subsequent separations.

The 2–50  $\mu\text{m}$ , 0.2–2  $\mu\text{m}$  and 0–0.2  $\mu\text{m}$  fractions are separated by centrifugation techniques similar to those described earlier. The conditions chosen here are only slightly different from those of the previous authors: 25 min at 2,900g to separate the fine fraction <0.2  $\mu\text{m}$  by decantation and 3 min at 800g for the 0.2–2  $\mu\text{m}$  fraction. These



conditions must be recomputed each time based on Stokes law as a function of the operating conditions (cf. Chap. 2).

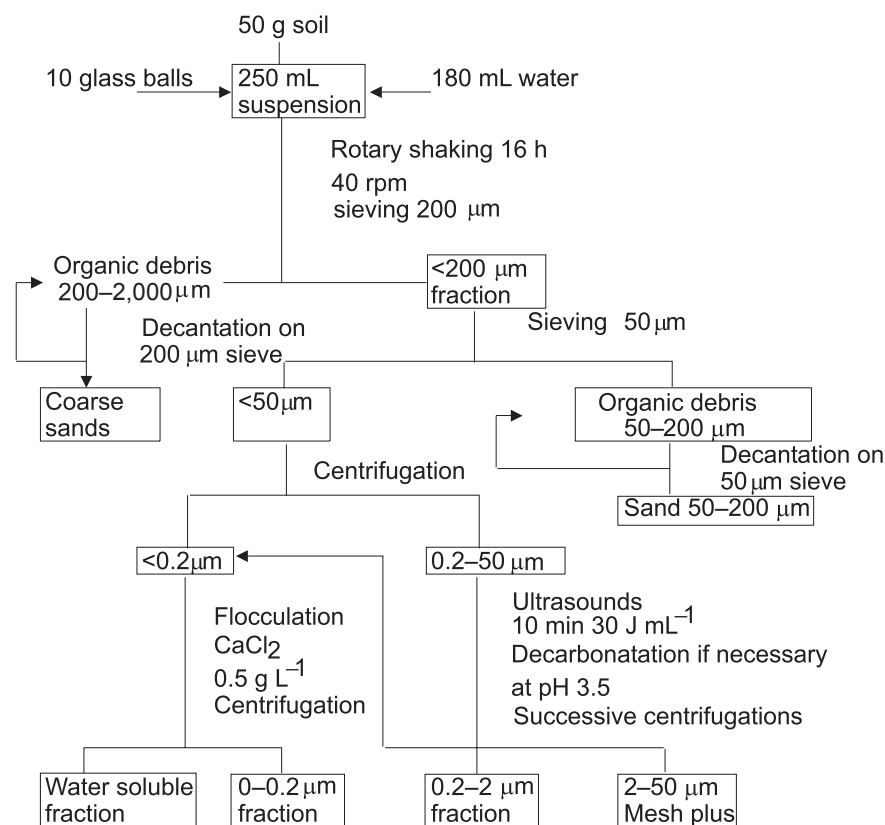

**Fig. 9.14.** Particle size and centrifuge fractionation after dispersion of the total soil by agitation with glass balls and dispersion of the fraction < 50 μm with ultrasounds (Balesdent et al. 1991)

The above conditions were calculated by Balesdent et al. (1991) for Stokes diameters of 0.2 or 2 μm, a particle density of 2.5 g cm<sup>-3</sup> and the data specific to their equipment. The density used corresponds more to mineral than to organic particles. Thus the fractions indicated do not strictly correspond to the size of organic particles, but it is difficult to separate inorganic and organic matters that are associated in the fractions of clay size. After each decantation of the 0–0.2 or 0.2–2 μm supernatant, suspend the centrifugation pellet in water, agitate for 30 min and centrifuge again. These authors advised four sedimentations at 0–0.2 μm then four at 0.2–2 μm. Centrifuge the 0.2–2 μm suspension for 25 min at 2,900g and recover the centrifugation pellet. Mix the supernatant with the

previously obtained 0–0.2  $\mu\text{m}$  fractions. Flocculate the suspension by adding a 0.5 g  $(\text{CaCl}_2)$   $\text{L}^{-1}$  solution; store overnight and centrifuge. The centrifugation pellet is the 0–0.2  $\mu\text{m}$  fraction and the supernatant is the final organic water-soluble fraction.

Fractionation of the clay size particles can be performed more easily by continuous flow ultra-centrifugation (cf. Chap. 2).

The fractions over 50  $\mu\text{m}$  should be dried at 60°C, those below 50  $\mu\text{m}$  should be homogenized, frozen and freeze-dried. They are weighed and then crushed to 50  $\mu\text{m}$  for chemical analyses, especially measurement of their C and N content (cf. Chap. 10).

#### *Fractionation using Resin $\text{H}^+$ and ultrasounds*

**Decantation method.** In this procedure described by Feller et al. (1991), the initial dispersion of the soil is carried out with a cation exchange resin (Amberlite IRN77 in  $\text{Na}^+$  form) carefully sieved to 500  $\mu\text{m}$ . The sieving operation must be renewed before each fractionation. Split the resin 100-mL portions and place them in polyamide bags (Nytrel TI45) with a mesh size of 45  $\mu\text{m}$ . Place these bags in 60- $\mu\text{m}$  mesh bags (Nytrel TI60). Close the bags with a rubber band. The double bag protects the soil against contamination in the event the bag should break.

Dispersion is then carried out by agitation of 20 g air dried soil for 16 h with 300 mL distilled water in a 1 L bottle containing one resin bag. Remove the bag from the suspension, wash abundantly with water and reserve for measurement of the small quantities of 20–50  $\mu\text{m}$  soil fraction that may be trapped in the bag (weigh the fraction remaining on a 20- $\mu\text{m}$  sieve after recovery and wash the resin on a 50- $\mu\text{m}$  sieve).

The remaining operations can be performed following the procedure described in “Agitation with Glass Balls and Ultrasonification”. However, the procedure of Feller et al. although very similar to the previous section, includes slight differences in ultrasonic energy, and in the clay fractionation method. Sieve the soil–water suspension to 200 and 50  $\mu\text{m}$ . Wash the material remaining on the mesh of the sieves and subject the 0–50  $\mu\text{m}$  suspension obtained in fractions of 1 L to ultrasounds. The apparatus (250 TH, US Annemasse) uses a frequency of 20 kHz, variable electric output (0 to 300 W), and is equipped with a probe with a flat head 9 mm diameter. This sounding head is located 2.5 cm from the bottom of the suspension, ultrasound is applied continuously for 7 min at 75% of maximum capacity, i.e. 0.23 W  $\text{mL}^{-1}$  suspension, approximately 100 J  $\text{mL}^{-1}$ .

Sieve the 0–50  $\mu\text{m}$  suspension, wash the material remaining on the mesh, then transfer the 0–20  $\mu\text{m}$  suspension in two sedimentation cylinders and bring to 1 L with distilled water. Shake the cylinders by

turning them upside down and back (30 reversals) and place them on the lab table during sedimentation of the 0–2  $\mu\text{m}$  fraction (cf. Chap. 2) for subsequent pipette sampling of this fraction. Repeat this operation until exhaustion (minimum five times). The sediment remaining at the bottom of the cylinder is the 2–20  $\mu\text{m}$  fraction. Centrifuge the sampled 0–2  $\mu\text{m}$  suspensions for 1 h at 2,500g to separate the centrifugation pellet (0.2–2  $\mu\text{m}$ ) and the 0–0.2  $\mu\text{m}$  supernatant. Repeat this operation twice. Flocculate all the collected supernatants by additions of 2 mL L<sup>-1</sup> of saturated SrCl<sub>2</sub>. Separate the clear supernatant from the centrifugation pellet (0–0.2  $\mu\text{m}$  fraction) by centrifugation.

The following fractions are obtained:

- by wet sieving, the 200–2000, 50–200 and 20–50  $\mu\text{m}$  fractions
- by sedimentation, the 2–20, 0.2–2 and 0–0.2  $\mu\text{m}$  fractions
- a water-soluble organic fraction.

Depending on the type of soil, or when too energetic dispersion is not desired, the same technique can be used on the 0–50  $\mu\text{m}$  suspension without the ultrasound treatment.

**Method with sampling of aliquots.** This method was described by Gavinelli et al. (1995) and is faster than the preceding one for measurement of the silt and clay fractions. Using a Robinson pipette, remove aliquots from sedimentation cylinders (cf. Chap. 2).

#### *Special Procedure for Sandy Soils*

The procedure of Feller (1979) was developed on sandy soils. It includes low energy mechanical dispersion by agitation of the soil–water suspensions (100 g soil–300 mL water) for 1 h with three glass balls. Sieving with water followed by separation of the fractions as in “Resin H<sup>+</sup> and Ultrasounds” enables recovery of the M2000, F2000, M200, F200, M50, F50, OM, W fractions (M: organomineral fraction, F: organic fragments, number: lower limit of particle size of the fraction, OM: organomineral fraction below 50  $\mu\text{m}$  separated by centrifugation, W: water-soluble fraction).

The procedure described in “Resin H<sup>+</sup> and Ultrasounds” also includes one modification for use with sandy to clayey–sandy soils. The length of agitation of the soil–water–resin suspensions in the bags is reduced to avoid too much deterioration of the plant debris by sands. The procedure is as follows:

Place 40 g of air-dried soil in a 1 L bottle with 300 mL distilled water and a 100 mL bag containing “Amberlite IRN77” cation exchange resin in Na<sup>+</sup> form (cf. “Resin H<sup>+</sup> and Ultrasounds”). Agitate the bottles on a back and forth shaker for 2 h at moderate speed. Separate the fractions

above 50  $\mu\text{m}$  by sieving. Agitate the 0–50  $\mu\text{m}$  suspension for 14 h with the resin. The remaining operations are identical to the procedure described in “Resin  $\text{H}^+$  and Ultrasounds” of this chapter.

### 9.2.6 Precision of the Fractionation Methods

The precision of the techniques for physical fractionation of organic matters varies considerably with the type of soil and especially with the stage of development of the organic matter. In general, the smaller the quantity of the fraction, the greater the variability. Repeatability increases with the particle size of the fraction. Relative error resulting from fractionation varies in the same way for percentages by weight or the percentage of the carbon of the fraction compared to total carbon.

Because of its weak relative weight, the error on the determination of the coarse and light organic fraction is often the most significant. This error also appears to be linked to the method since Monnier et al. (1962) found for four types of soil, variations ranging from +30 to +60% when comparing the funnel method of Jeanson–Luusinang (1960) with the centrifugation method. Oudinot (1985) found for the fraction with a density lower than 1.4, a relative standard deviation of 28% in the case of a calcareous brown soil and 62% in the case of a fersiallitic soil. Feller (1979) also found a coefficient of variation of 63% calculated on 60 replicates of measurements of a coarse organic F2000 fraction separated by sieving at 2 mm and floating in water. Monnier et al. (1962) obtained for two replicates on four types of soil a pooled relative standard deviation of about 2%.

**Table 9.1.** Error in the precision of the particle size fractionation of a sandy soil from Senegal (Feller 1979; F: organic fragments, M: organomineral fraction, number: lower particle size threshold, OM: organomineral fraction <50  $\mu\text{m}$ , W: water soluble organic fraction), *m*: carbon percent of the carbon of the sum of the fractions, RSD: relative standard deviation in percent of measurement for ten replicates

fraction	<i>m</i>	RSD(%)
F2000	3.0	63
F200	21.6	11
M200	1.2	42
F50	8.8	25
M50	5.8	28
OM	57.6	6
W	2.0	25

**Table 9.2.** Repeatability of the particle size fractionation of a ferrallitic soil and a vertic soil (Feller et al. 1991). RSD% *m* and RSD% Ct = relative standard deviation of the mass fraction and the carbon fraction (total carbon of fraction/total carbon) for four replicates

soil type	fraction ( $\mu\text{m}$ )	RSD% <i>m</i>	RSD% Ct
Ferrallitic	0–2	10	23
	2–20	25	48
	20–2000	8	48
Vertic	0–2	4	8
	2–20	4	14
	20–2000	10	30

Feller (1979) also measured the error in the percentages of carbon for each fraction (compared with total soil) obtained by wet sieving and decantation (cf. Special procedure for sandy soils). The results (Table 9.1) underline the significance of the error in precision with respect to quantitative studies of soil organic matter and how error varies with the size of the fraction.

The study of Feller et al. (1991) also included an evaluation of precision related both to the mass of the fractions and their carbon contents compared to total soil carbon (Table 9.2). The error was shown to depend on the type of soil. The error was lower in the case of a vertic soil than in a ferrallitic soil.

### 9.3. Conclusion and Outlook

Physical fractionation techniques are often used before other studies on soil organic matter. Indeed, they themselves comprise one of the methods of the study of organic matter.

No method enables perfect separation of each component of the soil (plant roots, plant fragments, animal fragments, micro-organisms and metabolites of organomineral complexes). The methods described in this chapter seem to be the most suitable for further development. They have been classified under three main functions: extraction of plant roots; extraction of “free organic matter” corresponding to organic fragments that have not completely deteriorated; fractionation of organic matter in particle-size ranges.

Apparatuses for root-soil separation are based on the principles of elutriation and underwater sieving. Their complexity and the fact that the operations of separation they perform are not exhaustive, led some authors to prefer manual techniques.

Density techniques are relatively simple to use. Coupling density with particle size fractionation of the coarse particles and the use of not very aggressive methods of dispersion of the structural aggregates increases reliability.

The techniques of particle size fractionation enable more extended classification of organic matter, in particular of the three main organic and organomineral compartments mentioned by Feller (1994).

Along with a description of the techniques of physical fractionation, this chapter describes the main types of soil on which the techniques were tested. Adaptations are probably necessary for other soils or to fulfil certain specific research objectives. These adaptations should be also helped by observations of Christensen (2001), Six et al. (2002), Rovira and Vallejo (2003) or Xu et al. (2003). The observations in this chapter should be taken into account, especially precautions related to the use of ultrasounds and dispersing agents; the aim being to obtain better separation of organic fragments and organomineral complexes with less destruction of organic entities.

## References

- Abo F (1984) *Influence du bore et du manganèse sur la nutrition, le développement et la production de blé sur sols de régions tempérée et aride.*, Thèse d'état, université Paris VII, 390 p
- Ahmed M and Oades JM (1984) Distribution of organic matter and adenosine triphosphate after fractionation of soils by physical procedures. *Soil Biol. Biochem.*, 16, 465–470
- Anderson DW and Paul EA (1984) Organo-mineral complexes and their study by radiocarbon dating. *Soil Sci. Soc. Am. J.*, 48, 298–301
- Anderson DW, Saggiar S, Bettany JR and Stewart JWB (1981) Particle size fractions and their use in studies of soil organic matter : I. The nature and distribution of forms of carbon, nitrogen and sulfur. *Soil Sci. Soc. Am. J.*, 45, 767–772
- Anderson JM and Ingram JSI (1989) *Tropical soil biology and fertility (TSBF) : a handbook of methods.*, C.A.B. International, 171 p
- Andreux F, Bruckert S, Correa A and Souchier B (1980) Sur une méthode de fractionnement physique et chimique des agrégats des sols : origines possibles de la matière organique des fractions obtenues. *C.R. Acad. Sci. Paris*, 291, 381–384

- Arrouays D (1994) Intérêt du fractionnement densimétrique des matières organiques en vue de la construction d'un modèle bi-compartimental d'évolution des stocks de carbone du sol. Exemple après défrichage et monoculture de maïs grain des sols de "touyas". *C.R. Acad. Sci. Paris*, 318, II, 787–793
- Balesdent J, Pétraud JP and Feller C (1991) Effets des ultrasons sur la distribution granulométrique des matières organiques des sols. *Sci. du Sol.*, 29, 95–106
- Bartoli F, Burtin G and Herbillon AJ (1991) Disaggregation and clay dispersion of oxisols : Na resin, a recommended methodology. *Geoderma*, 49, 301–317
- Beare MH, Hendrix PF and Coleman D.C (1994) Water-stable aggregates and organic matter fractions in conventional-and no-tillage soils. *Soil Sci. Soc. Am. J.*, 58, 777–786
- Besnard E, Chenu C, Balesdent J, Puget P and Arrouays D (1996) Fate of particulate organic matter in soil aggregates during cultivation. *European Journal of Soil Science*, 47, 495–503
- Bonzon B and Picard D (1969) Matériel et méthodes pour l'étude de la croissance et du développement en pleine terre des systèmes racinaires. *Cah. ORSTOM sér. Biol.*, 9, 3–9
- Bruckert S, Andreux F, Correa A, Ambouta KJM and Souchier B (1978) In *Proc. 11<sup>e</sup> Congrès A.I.S.S.*, Edmonton, Canada
- Bruckert S (1994) Analyse des complexes organo-minéraux des sols. In – *Pédologie 2. Constituants et propriétés du sol*, Bonneau and Souchier ed., 2nd ed., Masson, Paris, 275–295
- Cambardella CA, Elliott ET (1993) Carbon and nitrogen distribution in aggregates from cultivated and native grassland soils. *Soil Sci. Soc. Am. J.*, 57, 1071–1076
- Catroux G and Schnitzer M (1987) Chemical, Spectroscopic and Biological Characteristics of the organic matter in particle size fractions separated from an aquoll. *Soil Sci. Soc. Am. J.*, 51, 1200–1207
- Christensen BT (1992) Physical fractionation of soil and organic matter in primary particle size and density separates. In *Advances in soil science*, No. 20, Springer Berlin Heidelberg New York Inc, 1–90
- Christensen BT (2001) Physical fractionation of soil and structural and functional complexity in organic matter turnover. *Eur. J. Soil Sci.*, 52, 345–353
- Dabin B (1976) Méthode d'extraction et de fractionnement des matières humiques du sol. Application à quelques études pédologiques et agronomiques dans les sols tropicaux. *Cah. Orstom, Sér. Pédol.*, XIV, 287–297
- Edwards AP and Bremner JM (1967) Dispersion of soil particles by sonic vibration. *J. Soil Sci.*, 18, 47–63
- Elliott ET and Cambardella C.A (1991) Physical separation of soil organic matter. *Agriculture, ecosystems and environment*. Elsevier Science Amsterdam, 34, 407–419

- Elliott ET, Palm CA, Reuss DE and Monz CA (1991) Organic matter contained in soil aggregates from a tropical chronosequence : correction for sand and light fraction. *Agriculture, Ecosystems and Environment*, 34, 443–451
- Feller C (1979) Une méthode de fractionnement granulométrique de la matière organique du sol. *Cah. ORSTOM sér. Pédol.*, XVII, 339–346
- Feller C (1994) *La matière organique dans les sols tropicaux à argile 1:1. Recherche de compartiments organiques fonctionnels. Une approche granulométrique.*, IRD-Orstom, Paris, thèses et documents microfichés
- Feller C, Burtin G, Gérard B and Balesdent J (1991) Utilisation des résines sodiques et des ultrasons dans le fractionnement granulométrique de la matière organique des sols. Intérêt et limites. *Sci. du Sol.*, 29, 77–93
- Ford GW, Greenland DJ and Oades JM (1969) Separation of the light fraction from soils by ultrasonic dispersion in halogenated hydrocarbons containing a surfactant. *J. Soil Sci.*, 20, 291–296
- Gavinelli E, Feller C, Larré-Larrouy MC, Bacyé B, Djegui N and Nzila JdD (1995) A routine method to study soil organic matter by particle-size fractionation, examples for tropical soils. *Commun. Soil Sci. Plant Anal.*, 26, 1749–1760
- Genrich DA and Bremner JM (1972) A reevaluation of the ultrasonic vibration method of dispersing soils. *Soil Sci. Soc. Amer. Proc.*, 36, 944–947
- Golchin A, Oades JM, Skjemstad JO and Clarke P (1994) Study of free and occluded particulate organic matter in soils by solid state <sup>13</sup>C CP/MAS NMR spectroscopy and scanning electron microscopy. *Austral. J. Soil Res.*, 32, 285–309
- Greenland DJ and Ford GW (1964) Separation of partially humified organic materials from soils by ultrasonic dispersion. *Trans. 8th Int. Congr. Soil Sci.*, 3, 137–148
- Gregorich EG, Kachanoski RG and Voroney RP (1988) Ultrasonic dispersion of aggregates : distribution of organic matter in size fractions. *Can. J. Soil. Sci.*, 68, 395–403
- Hassink J and Dalenberg JW (1996) Decomposition and transfer of plant residue <sup>14</sup>C between size and density fractions in soil. *Plant Soil*, 179, 159–169
- Hénin S and Turc L (1949) Essai de fractionnement des matières organiques du sol. *C.R. Acad. Sci.*, Paris, 35, 41–43
- Jeanson Luusinang C (1960) Fractionnement par densité de la matière organique des sols. *Ann. Agron.*, 11, 481–496
- Kilmer VJ and Alexander LT (1949) Methods of making mechanical analyses of soils. *Soil Sci.*, 68, 15–24
- Ladd JN, Parsons JW and Amato M (1977) Studies of nitrogen immobilization and mineralization in calcareous soils – I, Distribution of immobilized nitrogen amongst soil fractions of different particle size and density. *Soil Biol. Biochem.*, 9, 309–318
- Lein ZJ (1940) Les formes de liaison de l'humus avec la partie minérale des sols. *Pochvovedeniye*



- Mc Gill W.B., Shields J.A. and Paul E.A (1975) Relation between carbon and nitrogen turnover in soil organic fraction of microbial origin. *Soil Biol. Biochem.*, 16, 465–470
- Meijboom FW, Hassink J and van Noordwijk M (1995) Density fractionation of soil macroorganic matter using silica suspensions. *Soil Biol. Biochem.*, 27, 1109–1111
- Monnier G, Turc L and Jeanson–Luusinang C (1962) Une méthode de fractionnement densimétrique par centrifugation des matières organiques du sol. *Ann. Agron*, 13, 55–63
- Oudinot S (1985) *Fractionnement physique de la matière organique. Distribution du carbone natif et marqué entre les fractions granulométriques de deux sols méditerranéens incubés avec du matériel végétal marqué au  $^{14}\text{C}$ .*, DEA, ENSAIA-INP de Lorraine, France, 30 p
- Pansu M and Sidi H (1987) Cinétique d'humification et de minéralisation des mélanges sols-résidus végétaux. *Sci. du sol*, 25, 247–265
- Pansu M, Bottner P, Sarmiento L and Metsellaar, K (2004) Comparison of five soil organic matter decomposition models using data from a  $^{14}\text{C}$  and  $^{15}\text{N}$  labeling field experiment. *Global Biogeochem. Cycles*, 18, GB4022, doi: 10.1029/2004GB002230
- Pansu M, Gautheyrou J and Loyer JY (2001) *Soil Analysis – Sampling, Instrumentation and Quality control.*, Balkema, Lisse, Abington, Exton, Tokyo, 489 pp
- Pearson RW and Truog E (1937) Procedure for the mineralogical subdivision of soil separates by means of heavy liquid specific gravity separations. *Soil Sci. Soc. Am. Proc.*, 2, 109–114
- Puget P, Besnard E and Chenu C (1996) Une méthode de fractionnement des matières organiques particulières des sols en fonction de leur localisation dans les agrégats. *Comptes Rendus de l'Académie des Sciences*, Paris, 322, 965–972
- Puget P, Chenu C and Balesdent J (1995) Total and young organic matter distributions in aggregates of silty cultivated soils. *Eur. J. Soil Sci.*, 46, 449–459
- Roscoe R, Buurman P and Velthorst EJ (2000) Disruption of soil aggregates by varied amounts of ultrasonic energy in fractionation of organic matter of a clay latosol: carbon, nitrogen and  $\delta^{13}\text{C}$  distribution in particle-size fractions. *Eur. J. Soil Sci.*, 51, 445–454
- Rouiller J, Burtin G and Souchier B (1972) La dispersion des sols dans l'analyse granulométrique. Méthode utilisant les résines échangeuses d'ions. *Bull. ENSAIA Nancy, France*, XIV, 193–205
- Rovira P and Vallejo VR (2003) Physical protection and biochemical quality of organic matter in Mediterranean calcareous forest soils: A density fractionation approach. *Soil Biol. Biochem.*, 35, 245–261
- Sallih Z and Pansu M (1993) Modelling of soil carbon forms after organic amendment under controlled conditions. *Soil Biol. Biochem.*, 25, 1755–1762

- Shaymukhametov MS, Titova NA, Travnikova LS and Labenets YM (1984) Use of physicochemical fractionation methods to characterize soil organic matter. Translated from : *Pochvovedeniye*, 8, 131–141
- Sidi H (1987) *Effet de l'apport de matière organique et de gypse sur la stabilité structurale de sols de région méditerranéenne.*, Thèse Docteur ingénieur, INA Paris Grignon
- Six J., Callewaert P, Lenders S, De Gryze S, Morris SJ, Gregorich EG, Paul EA and Paustian K (2002) Measuring and Understanding Carbon Storage in Afforested Soils by Physical Fractionation. *Soil Sci. Soc. Am. J.*, 66, 1981–1987
- Six J, Schultz PA, Jastrow JD and Merckx R (1999) Recycling of sodium polytungstate used in soil organic matter studies. *Soil Biol. Biochem.*, 31, 1193–1196
- Smucker AJM, McBurney S and Srivastava AK (1982) Separation of roots from compacted soil profiles by the hydropneumatic elutriation system. *Agron. J.*, 74, 500–503
- Soil Survey Staff (1960) *Soil classification – A comprehensive system*, 7th Approximation. USDA, SCS, 265 p
- Tiessen H and Stewart JWB (1983) Particle-size fractions and their use in studies of soil organic matter: II. Cultivation effects on organic matter composition in soil fractions. *Soil Sci. Soc. Am. J.*, 47, 509–514
- Turchenek LW and Oades JM (1979) Fractionation of organo-mineral complexes by sedimentation and density techniques. *Geoderma*, 21, 311–343
- Watson JR (1971) Ultrasonic vibration as a method of soil dispersion, *Soils and Fertilizers*, 34, 127–134
- Xu YC, Shen QR and Ran W (2003) Content and distribution of organic N in soil and particle size fractions after long-term fertilization. *Chemosphere*, 50, 739–745

## Organic and Total C, N (H, O, S) Analysis

### 10.1 Introduction

#### 10.1.1 Soil Organic Matter

Organic matter plays a determining role in pedogenesis and can drastically modify the physical, chemical, and biological properties of soil (structure, plasticity, colour, water retention, CEC, and AEC).

The fundamental processes of evolution include phenomena of mineralization and immobilization and, in particular, of carbon and nitrogen. Mineralization allows the transformation of organic residues into inorganic compounds in the soil, the atmosphere, and the hydrosphere, these are then usable by flora and by micro-organisms. Immobilization is the transformation of organic matter into more stable organic and organo-mineral compounds with high molecular weights that are fixed in the interlayer spaces of clays. These processes are summarized by the following diagram:

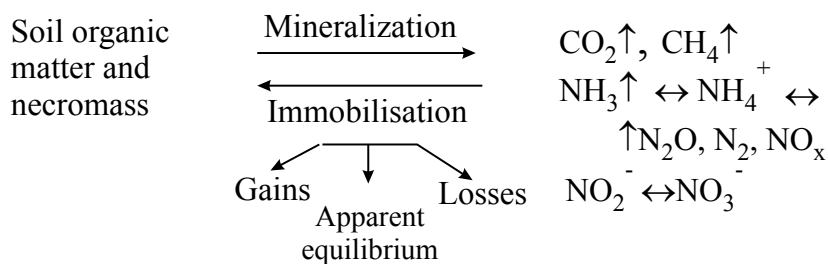

This cycle includes phases of mineralization, humification, ammonification, immobilization, nitrification, and volatilization under the action of specific micro-organisms (Pansu et al. 1998) and is influenced by a number of factors, of which the most significant are:

- climate (temperature and moisture and their effects on microbial activity, micro-fauna and micro-flora)
- topography
- types of vegetation and litters
- the nature of the parental material (mainly texture, mineralogy and pH)
- time (age of the soil and state of equilibrium)  
and, in addition, for cultivated soils
- the effects of farming practices such as ploughing, irrigation, burning, addition of manure, fertilizer, pesticides
- types of crops, exports by crops and use of crop residues.

Soil C and N contents can vary considerably, e.g. a tropical oxisol can contain less than 2% of total C while in andosols and histisols, total C can exceed 30%.

The dynamics of the transformation of C and N are very complex and difficult to model accurately. In addition to the measurement of total C and N, a simple index is needed to clarify the dynamics and allow samples from different climatic zones to be compared, as well as to identify the evolution of the organic matter in a soil profile, or the presence of a buried organic A horizon.

The first in situ observations of humified litters ( $A_{00}$ ) of the organic  $A_0$  horizon (which are of varying thickness) and of the eluvial or illuvial horizons provide very important information. The evolution of the organic matter is then analysed by studying its chemical structure and physicochemical properties. The different forms of matter can be separated into characteristic entities of varying degrees of polymerization and quantified by physical separation (cf. Chap. 9) by their resistance to hydrolysis (in acid and basic media) and their solubility in specific solvents and reagents (cf Chaps. 11 and 12). Laboratory techniques such as gel permeation chromatography allow determination of the molecular weights of the humified substances after purification. UV, visible, or IR absorption and other spectrographic methods allow identification of the molecular structures and of rates of polymerization. Both active functional groups and the formation of the clay–humus complexes can be studied (cf. Chap. 12). The elementary analysis described in this chapter enables the total chemical composition of the organic matters to be established.

The different factors that control humification, especially climate, parental material, and biomass, result in physicochemical constraints that,

in turn, result in a given type of humus e.g. Mor, Moder, forest and calcic Mulls, Anmoor or peats. Microscopic observation (cf. Chap. 8) of the morphology of the systems at different scales allows characterization of the interfaces of organic and inorganic matter and of the mechanisms of humification. Kinetic methods can also be used to analyse the biogeochemical dynamics of the organic residues:

- By measuring, for example, the CO<sub>2</sub> released per unit of time by means of portable chromatographs or IR captors installed in situ (respirometry, biological evolution).
- By using <sup>14</sup>C, <sup>13</sup>C, and <sup>15</sup>N isotopic tracers to monitor the transformation of organic substances added to the soil (turnover rate of soil organic matter).
- By studying the differentiation of stable isotopes such as <sup>13</sup>C, <sup>14</sup>C, or <sup>15</sup>N and isotopic ratios for studies of paleoclimatology and geochronology.

**Table 10.1.** Typical C:N ratios of a few main types of humus

type	C:N	pH range
calcic eutrophic Mull	≅ 10	7.0–8.4
forest Mull	12–15	5.5–6.5
moder	15–25	4.0–5.0
mor	> 20	< 4.0
hydromorphy	calcic eutrophic peats	< 30
	acid oligotrophic peats	≅ 40
	anmoor	variable

The majority of these methods require a high degree of specificity and highly sensitive sensors because of the scales of measurement needed to measure extremely weak variations. They are time consuming and expensive and are not sufficiently universal for use in serial analysis. On the other hand, total-C and -N can be measured using simple methods that are accessible to all laboratories. Improvement in equipment for dry analysis (e.g. CHN(OS)) now makes it possible to standardize analyses and combine precision, speed, and automation. Some of this equipment can handle representative samples of more than 100 mg.

The C:N ratio of the soil in the surface horizons can be determined only using information on total C and N (Table 10.1). This information can then be used as an index that provides relatively reliable information on the biological activity and equilibrium of the two elements that have been subjected to the antagonistic processes of mineralization and immobilization. In regions with a temperate climate, the C:N ratio is

about 10–12 for uncultivated soils and generally decreases with an increase in soil depth. In certain soils N can be significantly occluded in clays, especially in deep horizons. In forest soils, peat horizons, or podzols, C:N ratios can reach 20–30 or even higher because of the formation of only slightly biodegradable complexes which are low in nitrogen (e.g. Spodic horizons). At C:N ratios below a threshold near 20, positive N net mineralization is generally observed. In cultivated soils, farming residues recycled in the field have C:N ratios ranging between 15 and 60 due to the presence of lignin-cellulose compounds with a slow rate of degradation. Under forest with acidifying litter, the C:N ratios can reach 150 or even higher.

### **10.1.2 Sampling, Preparation of the Samples, Analytical Significance**

#### ***Equipment***

- strainer with 2 mm round holes, AFNOR NF34.
- cutting grinder equipped with a 125  $\mu\text{m}$  mesh sieve (AFNOR NF22) and a watertight collector (for litter).
- grinder with retractable hammer equipped with an AFNOR NF22 sieve and a watertight collector (mineral or organo-mineral horizons).
- agate mortar and pestle.
- analytical balances ( $\pm 0.1$  mg or  $\pm 0.01$  mg depending on test specimens).
- drying oven regulated at 105°C.

#### ***Procedures and Precautions***

As the heterogeneity of the soil surface horizons near the litters is very high, sampling is difficult and must be carried out with great care. The way samples are collected will subsequently affect the validity of the results. Drying should be carried out in contact with air in a well-ventilated room.

At the laboratory, samples should be crushed to 2 mm to separate non-decayed or only slightly decayed plant debris. Care should be taken to avoid breaking up the organic fragments that have retained their original texture as this could overload the sample significantly. This stage affects the significance of the analytical result as does the weight of the test specimens during analysis (Pansu et al. 2001).

Drying increases the fixing of ammonium particularly if the parental matrix contains 2:1 clays such as montmorillonite or vermiculites. The action of the micro-organisms may not have stopped during storage depending on soil respiration, lignin content, or on residual moisture in the air-dried sample (in andosols and histisols, the moisture rate of air-dried soil can still be 60% after 6 months).

Grinding a whole 2-mm particle-size sub-sample to 125  $\mu\text{m}$  particle size (AFNOR NF22 sieve) can modify the moisture and equilibrium of the reactive surfaces. Moisture content is used to correct the analytical results and must be measured at the same time as analytical sampling is performed. If drying at 105°C does not exceed 3 or 4 h, there is generally no significant loss of C and N in gaseous form; but drying can slightly increase fixing of N in the clay lattice. In the case of instrumental analysis (CHN(OS)), drying the samples at 105°C can avoid the need to correct the results and can limit clogging of the water traps.

Careful grinding into fine particles that are homogenous in size is necessary to improve the reproducibility of the results, soil powder sampling can vary between 5 and 500 mg depending on the instrument used for dry analyses (CHN(OS)). In the case of wet analyses, grinding ensures a more regular and complete attack by considerably increasing the solid–liquid interfaces.

### ***Expression of the Results***

If the analytical results are to be used for agronomic purposes, it is advisable to take the soil density into account, particularly in the case of peats, andosols, and histisols where apparent density can approach 0.30. In this case, the concentration expressed per mass unit may be far from the inorganic contents actually available for the plants per unit volume and it is thus essential to correct for density.

In the case of soils with high contents of gravels, stones, rocks, or non-decayed plant debris that display a significant rejection rate during preparation of 2 mm soil samples, it is also better to correct the rough results of analysis to obtain a value approaching the quality of the soil per unit of volume.

### ***Preliminary Tests***

A good knowledge of the formation processes and agricultural use of the soils concerned makes it possible to limit the number of tests required.

The number of tests also depends on the analytical method to be used (Table 10.2).

It should be noted that by convention, the “total organic matter of the soil” corresponds to the transformed organic forms and excludes intact plant and animal residues. In practice, since the separation of light or non-decayed fragments of organic matter (cf. Chap. 9) is difficult in repetitive analysis, particles of a size lower than 2 mm are considered to be an essential part of the sample. Living micro-organisms are integrated. A range of different types of tests can be carried out to obtain more detailed knowledge on the analytical substrate to be in a position to choose the appropriate analytical procedures.

*Examination with a magnifying glass* enables confirmation of presence of seashells, limestone amendments, coals, etc. (soils under crops, coastal soils, calcareous soils, etc.).

*HCl Tests:* below pH 7.4–7.0, indicates the presence of carbonates and bicarbonates only in the form of isolated particles.

**Table 10.2.** Analytical methods

method	type	source of interference
dry methods	combustion < 360°C	gypsum, losses of water above 150°C various forms of water (hydration) carbonate decomposition $\text{CO}_2\uparrow$
	combustion > 360°C	$\text{Na}_2\text{CO}_3$ melting (clogging) various forms of water (bound water)
wet methods	classical N Kjeldahl method	$\text{NO}_3^-$ , $\text{NO}_2^-$ random recovery (not quantified if not previously reduced) $\text{NH}_4^+$ fixed in the crystal lattice of 2:1 clays (random recovery)
	cold C oxidation	results are too low (multiplicative factor) presence of chloride, oxidative and reducing agents
	hot C oxidation	presence of chloride, oxidative and reducing agents

*$\text{NO}_3^-$ ,  $\text{NO}_2^-$  test:* a rapid test using a soil analytical kit is useful in intensively cultivated and waterlogged soils.

*Fixed  $\text{NH}_4$  test:* only used in soils containing 2:1 clays to check ammonium concentration with two different methods and possibly by destruction of the crystal lattice (cf. Sect. 28.3.5 of Chap. 28).



### ***Preliminary Destruction of Carbonates and Bicarbonates (Dry Combustion Methods)***

The samples should be treated at room temperature with a 0.1 mol (HCl) L<sup>-1</sup> solution until the end of the reaction. If the presence of dolomite, siderite, or biogenic calcite is suspected, contact time should be increased to 2 or 3 h.



Samples containing siderite can be treated using the hot H<sub>3</sub>PO<sub>4</sub> or CH<sub>3</sub>COOH 0.3 mol (H<sup>+</sup>) L<sup>-1</sup> for 5 h. Destruction is difficult and often incomplete. Dry carefully.

$$\text{Total C} - \text{inorganic C} = \text{organic C} \quad (10.1)$$

Care should be taken to not lose soluble organic C in the acids (e.g. from amino-acids or phospholipids). Formation of hygroscopic salt can disturb weighing. The presence of manganese dioxide in the soil can cause the release of Cl<sub>2</sub> starting from HCl.

In arid or semi-arid regions, soluble salts that may be present (e.g. carbonates, chlorides, or sulphur compounds) can slow down the organic oxidation of C because of their low melting points (e.g. sodium carbonate) and consequently disturb measurements by dry combustion.

## **10.2 Wet Methods**

### **10.2.1 Total Carbon: General Information**

Strictly speaking the “total carbon” of the soil comes from two principal sources (10.1):

- Organic carbon (only slightly processed organic residues of plant and animal origin, humus, charcoal, fossil organic matter, micro-organisms).
- Inorganic carbon possibly present in the form of carbonates and bicarbonates.

In the majority of methods, the gas phases present in the atmosphere of the soil (CO<sub>2</sub> linked with biological activity, CH<sub>4</sub>) are not taken into account.

Some ambiguity persists in the terminology and methods used. Measurements carried out on non-processed soil samples (without preliminary elimination of carbonates) using dry combustion methods in

CHN(OS) apparatuses give organic and inorganic forms of “total carbon”. Measurements by oxydo-reduction using wet oxidation give only “organic carbon” corresponding to humified forms and organic matter of debris that are still rich in non-transformed cellulose, but does not include charcoal or fossil organic matter. Although wet methods at room temperature do not allow complete attack of the humus (a correction index will be needed), they are nevertheless used for the determination of “total organic carbon”.

“Total inorganic carbon” can be measured using the methods described in Chap. 17 but with varying precision due to the slow chemical decomposition of magnesium carbonate ( $\text{MgCO}_3$ ) and especially of siderite ( $\text{FeCO}_3$ ).

The term “total organic matter” is often used. Empirically it expresses “total organic carbon” determined by oxidation–reduction but corrected by a coefficient based on the assumption that organic matter contains mainly humic acids at approximately 58% of carbon ( $100/58 = 1.724$  van Bemmelen factor). In fact this rate is far from constant even for the horizons near the soil surface. The coefficient is thus not very realistic, particularly for soils containing not very humified Mor or Moder, forest soils, and peats. In these cases a coefficient of up to 2 or even 2.5 will be required. The term “total organic matter” is thus an estimation and cannot be used as an index.

In practice, the term “total carbon” is incorrectly used by some authors to indicate “total organic carbon” as well as to establish balances in total analysis, C:N ratios, or to compare the total C contents of the different horizons of a soil profile and the organic distribution of C as a function of depth.

The term total organic carbon should cover all the organic substances resulting from the humification of C in the soil (microbial residues, humic substances) under the influence of biochemical and chemical reactions. Additionally it represents light organic matter still not completely decomposed that could not be separated on a sieve during the preparation of the samples (litters, coarse organic plant or animal fragments under 2 mm in size). Fossil organic matter (coal, naphthas, resins, etc.) and charcoals in regions exposed to forest fires or in regions with slash and burn agriculture are not subject to this type of dynamics, which means they do not have to be taken into account when wet redox methods are used. However they are always included when dry combustion methods are used and this can lead to difficulties when the results obtained by the two methods have to be compared.

Thus the study of the total organic carbon stock may need to be refined:

- By micro-morphologic observations at different scales to determine the relative proportions of the contents of unprocessed and humified organic matter together with selective extractions in different mediums.
- By the determination of the origin, the nature and the rates of mineralization of the different forms as a function of the pH, the nature of the clays and clay–humus complex, and of soil management practices.

Wet methods require only relatively inexpensive equipment, which means they can be used in all laboratories. These methods make it possible to work with big samples which are more representative of the natural environment. On the other hand, they are time consuming, require the handling of very corrosive products and the elimination of polluting products ( $\text{Cr}^{3+}$ ,  $\text{H}_2\text{SO}_4$ ), which can pose problems for the environment.

### 10.2.2 Organic Carbon by Wet Oxidation at the Temperature of Reaction

#### *Introduction*

The determination of total organic carbon by oxidation with potassium dichromate in a strong acid open medium, was proposed first by Schollenberger (1927) then by Walkley and Black (1934) from which it takes its name. After a stage of oxidation/mineralization at the temperature of reaction for a given length of time, the non-reduced dichromate in excess is back titrated by ferrous iron.

Many authors have studied the factors that affect C mineralization: acid concentration ( $\text{H}_2\text{SO}_4$ ,  $\text{H}_3\text{PO}_4$ ), potassium dichromate concentration, oxidation temperature (from the temperature of reaction to  $+210^\circ\text{C}$ ), the time of contact, the need to condense the vapour to avoid too high concentration of the medium, and to limit destruction of the oxidant by avoiding overheating of the walls. The choice of the temperature resulted in two different types of methods:

- At the temperature of reaction  $\cong 120^\circ\text{C}$  (Walkley and Black 1934).
- At standardized boiling  $\cong 150^\circ\text{C}$  (Anne 1945; Mebius 1960).

Different procedures were proposed for back titration of dichromate excess such as soil/solution separation by centrifugation and filtration, but direct volumetric titration in the soil suspension was the most widely adopted. Redox indicators (diphenylamine, barium diphenylamine sulphonate, N-phenyl anthranilic acid, ferrous *O*-phenanthroline) can be absorbed on clays. Additives (e.g.  $\text{NaF}$ ,  $\text{H}_3\text{PO}_4$ ) allow better reading by sequestering the coloured products that are formed or dissolved (e.g.  $\text{Fe}^{3+}$ ) and which can mask the reaction.

## Principle

### Mineralization

Organic forms of C are oxidized in the presence of excess dichromate. The reaction in a concentrated acid medium is exothermic ( $\cong 120^\circ\text{C}$ ). It develops at a fast kinetics under the following conditions:

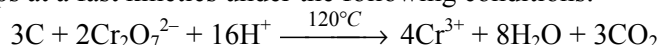

The amount of reduced dichromate is considered to be quantitatively linked to the organic C content of the sample. The likelihood of reduction is assumed to be identical for different forms of organic C and the reducing power is assumed to be constant during mineralization. In practice, at the temperature of reaction without heating, a factor of correction will be required because only the most active forms are oxidized, i.e. 60%–80% of organic matter. This factor was fixed at 1.30 (100/76) to take the variable reactivity of the organic forms into account, but can vary between 1.10 and 1.45 depending on the soils and on the types of vegetation.

The inorganic forms (carbonates, bicarbonates) are destroyed and do not play any role except in the consumption of acid and the production of foam. The precipitation of calcium sulphate can be problematic during final titration if a spectro-colorimetric method is used.

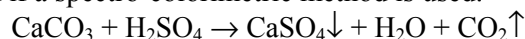

### Titration

Volumetric back titration of the  $\text{Cr}^{+VI}$  dichromate not consumed by organic C is carried out by reduction (ferrous sulphate or Mohr's salt) in the presence of an indicator.

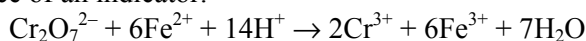

Sodium fluoride or phosphoric acid ( $\text{H}_3\text{PO}_4$ ) can be added to fix the ferric iron that is formed or dissolved, and to improve the detection of the equilibrium point of titration:

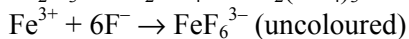
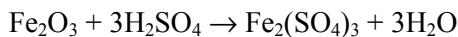

Nevertheless, the addition of fluoride can result in the formation of hydrofluoric acid which attacks glass and silicates:

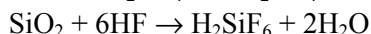
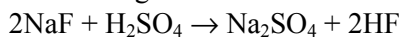

It is thus necessary to clean the lab glassware immediately after titration and to reserve this glassware for the determination of C using this redox method.

### **Interferences**

In saline soils, chlorides cause a positive error by forming chromyl chloride:

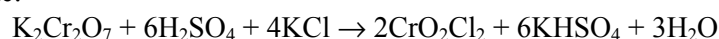

Ferrous iron that may be present is oxidized by dichromate and thus modifies the quantity of ferrous sulphate necessary for back titration. Corrections will be necessary in waterlogged soils in which  $\text{Fe}^{2+}$  is sometimes abundant.

The method cannot be used in acid sulphated soils that are rich in pyrite ( $\text{FeS}_2$ ):

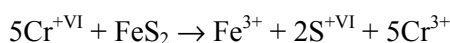

A high level of  $\text{Mn}^{2+}$  can also interfere, as can iron metal that can result from wear of the grinding equipment.

### **Equipment**

- Analytical balance ( $\pm 1/10$  mg) and a top-loading balance with a capacity of 500 g ( $\pm 1$  mg).
- 500 mL wide-neck Pyrex Erlenmeyer flasks.
- Insulating plates.
- Teflon flask dispenser.
- Burette for titration.
- Magnetic stirrer with Teflon bars.

### **Reagents**

All the reagents should be of analytical reference grade:

- Distilled or bi-distilled water (avoid water that has been deionised by ion exchange as it can contain fine particles of ion-exchange resins).
- 1 mol ( $e^-$ )  $\text{L}^{-1}$  potassium dichromate (standard): in a 1 L volumetric flask, dissolve 49.040 g of  $\text{K}_2\text{Cr}_2\text{O}_7$  (dried under vacuum or on  $\text{P}_2\text{O}_5$  in a desiccator) in 800 mL of bi-distilled water, then adjust to 1,000 mL.
- Concentrated sulphuric acid,  $\text{H}_2\text{SO}_4$   $d = 1.84$ .
- 0.5 mol ( $\text{H}^+$ )  $\text{L}^{-1}$  sulphuric acid solution: in a 1,000 mL Pyrex volumetric cylinder, add 800 mL distilled water, then slowly add 13.9 mL of concentrated sulphuric acid, homogenize. Allow to cool and bring to 1 L with distilled water.

– 0.5 mol (e<sup>-</sup>) L<sup>-1</sup> iron and ammonium sulphate (Mohr's salt): in a 1,000 mL volumetric flask, dissolve 196.05 g of Fe(NH<sub>4</sub>)<sub>2</sub>SO<sub>4</sub>·6H<sub>2</sub>O (dried on P<sub>2</sub>O<sub>5</sub> in a desiccator) in approximately 800 mL of 0.5 mol (H<sup>+</sup>) L<sup>-1</sup> H<sub>2</sub>SO<sub>4</sub> solution. Adjust to 1,000 mL with the 0.5 mol (H<sup>+</sup>) L<sup>-1</sup> H<sub>2</sub>SO<sub>4</sub> solution. The liquid should be clear and pale green in colour.

– Concentrated phosphoric acid H<sub>3</sub>PO<sub>4</sub> *d* = 1.71 (85%).

– Sodium fluoride NaF in powder form.

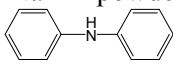
– Diphenylamine  solution: dissolve 0.5 g diphenylamine in 100 mL of concentrated H<sub>2</sub>SO<sub>4</sub>. Pour into 20 mL water and store in a brown glass bottle with a ground stopper with dropping pipette.

Other indicators can be used:

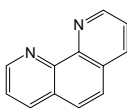
– *o*-Phenanthroline (1–10 phenanthroline)  which forms a ferroine complex with Fe<sup>2+</sup>: dissolve 14.85 g *o*-phenanthroline monohydrate and 6.95 g ferrous sulphate (FeSO<sub>4</sub>·7H<sub>2</sub>O) in 800 mL distilled water. Bring to 1,000 mL in a volumetric flask and store in a brown glass bottle.

– Barium diphenylamine sulphonate Ba(C<sub>6</sub>H<sub>5</sub>–NH–C<sub>6</sub>H<sub>4</sub>–SO<sub>3</sub>)<sub>2</sub>. Dissolve in distilled water.

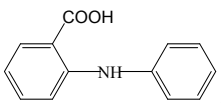
– *N* phenyl anthranilic acid .

### Procedure

If total N was analysed beforehand, determine the approximate weight of soil required to obtain a sample specimen containing between 10 and 25 mg C (Table 10.3).

Weigh this sample specimen (± 0.1 mg), transfer it in a wide-neck 500 mL Erlenmeyer flask and add exactly 10 mL of the potassium dichromate 1 mol (e<sup>-</sup>) L<sup>-1</sup> solution. Homogenize carefully to avoid making the suspension go up the walls of the flask. Quickly add 20 mL of concentrated sulphuric acid with a Teflon dispenser. Agitate by rotation for one minute to homogenize (the temperature of reaction is approximately 120°C). Place on an insulating plate and let oxidation take continue for 30 min.

Add 200 mL distilled water, then 10 mL of phosphoric acid (or approximately 5 g of sodium fluoride with a suitable spatula). Homogenize. Add three drops of diphenylamine.

Titrate the excess dichromate with the  $0.5 \text{ mol (e}^-) \text{ L}^{-1}$  ferrous iron solution (this reagent should be freshly titrated each day). The end of titration is indicated by the change in colour from purplish blue to a rather luminous greenish blue. Determination of the end point is facilitated by adding 1–2 drops of indicator as soon as the colour begins to change.

*Note:* the solution should still be orange after the attack of the organic matter indicating an excess of dichromate. If the solution is green, start again using a smaller sample of soil.

**Table 10.3.** Recommended size of test specimen ( $P$  g of soil sample) as a function of nitrogen content (on the basis of a C:N ratio of 10).

N g kg <sup>-1</sup>	sample $P$ g	mg C sample (theoretical)	N g kg <sup>-1</sup>	sample $P$ g	mg C sample (theoretical)
0.1–0.2	10	10–20	1–2	1	10–20
0.3–0.4	5	15–20	3–4	0.5	15–20
0.5–0.9	2.5	12.5–22.5	5–10	0.2	10–20

### **Expression of the Result**

It is an accepted fact that the oxygen consumed is proportional to the carbon titrated on the theoretical basis of 1 mL of  $1 \text{ mol (e}^-) \text{ L}^{-1}$  dichromate solution oxidizing 3 mg C, i.e. corrected by the attack coefficient ( $1.3 = 100/76$ ) = 3.9 mg C. This attack coefficient can be modulated as a function of the form of C and by comparison with measurements made by dry combustion:

$$\text{– Total organic C g kg}^{-1} \text{ of } 105^\circ\text{C dried soil} = 3.9(10 - 0.5 V) / P$$

where  $P$  is the sample mass in g,  $V$  is the volume (mL) of  $\text{Fe}^{2+}$  solution at a concentration of  $0.5 \text{ mol L}^{-1}$  (replace 0.5 by the exact concentration if it is not exactly 0.5) and the quantity of dichromate solution added is 10 mL.

$$\text{– Total organic matter g kg}^{-1} = \text{total organic C} \times 1.724$$

### **Control**

Each day, make two measurements with 10 mL  $1 \text{ mol (e}^-) \text{ L}^{-1}$  dichromate solution to check the exact concentration of the  $\text{Fe}^{2+}$  solution.

In each series, carry out two blank titrations with quartz pre-fired at 1,100°C, and two titration controls on samples of a reference soil of the same type as the soils being analyzed.

### 10.2.3 Organic Carbon by Wet Oxidation at Controlled Temperature

#### *Introduction and Principle*

When measurements are made using wet oxidation at the temperature of reaction, the mineralization/oxidation of active organic carbon is always incomplete. The use of a “standardized” corrective factor of 1.3 introduces a variable that is not easily controllable because in practice, this coefficient ranges from 1.10 to 1.40.

To mitigate this problem, Anne (1945) then Mebius (1960) proposed carrying out total mineralization by maintaining the sample at a constant temperature throughout the process of mineralization without causing thermal decomposition of the dichromate. Effectiveness and reproducibility were tested between 130 and 210°C with different times of oxidation and different acid/dichromate ratios. Above 150°C the dichromate tends to decompose more and more quickly, thus necessitating relatively short attack times. Strict respect of the procedure and precise control of the attack times and the temperature enable an acceptable level of accuracy. In principles this type of measurement and possible interferences are the same as for the method described in Sect. 10.2.2 earlier.

#### *Equipment*

- A mineralization block (with from 20 to 40 places regulated thermostatically at 150°C (Tecator, Skalar, Technicon, etc.); mechanization is possible in laboratories that carry out many repetitive analyses; in the Skalar system, for example, a sample holder is capped by a device with 20 reflux condensers. After introducing the samples and reagents, place the unit in the programmed heating block; after the period of mineralization, remove the unit and cool, separate the rack condensers; the sample holder advances on rails towards the dilution stage and possibly towards the titration system.
- Analytical balance ( $\pm 1/10$  mg).
- Digestion tubes with ground joint for the condenser.
- Titration burette.



- Precision volume dispenser ( $\pm 1/10$  mL) with Pyrex glass syringe and Teflon piston.
- Magnetic stirrer with 15 mm Teflon bars.

### **Reagents**

- cf. “Reagents” under Sect. 10.2.2.
- 0.2 mol ( $\text{Fe}^{2+}$ )  $\text{L}^{-1}$  solution: weigh 78.5 g of Mohr salt (dried in  $\text{P}_2\text{O}_5$  desiccator), dissolve in 800 mL of 0.5 mol ( $\text{H}^+$ )  $\text{L}^{-1}$  sulphuric acid solution. Bring to 1,000 mL with the sulphuric acid solution.

### **Procedure**

Weigh ( $\pm 0.1$  mg) between 200 mg and 2 g of soil (ground to 125  $\mu\text{m}$  particle size and dried on  $\text{P}_2\text{O}_5$ ) to have a sample containing approximately 15 mg C (Table 10.3).

In a Pyrex tube (with ground joint for the condenser), add 10 mL of 1 mol ( $\text{e}^-$ )  $\text{L}^{-1}$  potassium dichromate solution and 15 mL of concentrated sulphuric acid. Homogenize. Place the tube in a heating block regulated at 150°C and adjust the condenser. The attack should be maintained for 30 min at the same temperature.

Leave to cool in the air then transfer in a 250 mL wide-necked Erlenmeyer flask and bring to approximately 100 mL with washing water. Titrate with the 0.2 mol ( $\text{Fe}^{2+}$ )  $\text{L}^{-1}$  solution (or 0.5 mol  $\text{L}^{-1}$ ) in the presence of the indicator and a sequestering agent (cf. “Procedure” under Sect. 10.2.2). The dark purple colour will change to luminous green at the titration point.

### **Controls and Calculation**

- Titration of the  $\text{Fe}^{2+}$  solution (two replicates).
- Blank titration of prefired quartz by heating under the same conditions to correct the thermal destruction of the reagent and to establish the effective dichromate concentration (two replicates).
- Analyse a standard carbohydrate under the same conditions to check that oxidation is complete and that a correction coefficient will not be needed.

Without a correction coefficient, total organic C  $\text{g kg}^{-1}$  of 105°C dried soil =  $3(10^{-6} V)/P$

See “Expression of the Result” under Sect. 10.2.2 for explanation of symbols and numbers.

### 10.2.4 Organic Carbon by Wet Oxidation and Spectrocolorimetry

The French standard NF X31-109 (1993) was published for the determination of organic carbon by sulfochromic oxidation allowing the calculation of the organic matter by means of a multiplying coefficient for use in agronomic studies.

Oxidation is conducted at 135°C in a thermostated heating block. The oxidation of a carbon atom requires the transfer of four electrons. Glucose is used as the standard substance and the final determination is by absorption spectrometry at 585 nm on aliquots centrifuged for 10 min at 2,000 g and filtered to eliminate the suspended particles.

The method cannot be used in the presence of mineral reducing materials (e.g.  $\text{Cl}^-$ ,  $\text{Fe}^{2+}$ ) or of pollution by organic compounds. This standard NF X31-109 (1993) is referred to in the detailed procedure.

*Notes:*

- After centrifugation, titration of organic C in the medium can be carried out at 590 or 625 nm (depending on the author with a standard sucrose).
- To avoid transfers, a probe spectrometer with optical fibre can be used directly in the clarified medium (Baker 1976).

### 10.2.5 Total Nitrogen by Wet Method: Introduction

After carbon, hydrogen, and oxygen, nitrogen is the most abundant element in living tissue. It plays a major role in agriculture, nitrogen being an essential element for plant growth. In the soil, the organic forms can reach approximately 90% of total nitrogen.

Quantitatively speaking, the total nitrogen value expresses not only the N compounds of the organic matter of the soil and biomass (cf. Chap. 14), but also inorganic nitrogen compounds (cf. Chap. 28). All these compounds represent both short- and long-term reserves, i.e. nitrogen that is directly or potentially available for plants enabling an improvement in yield.

On the other hand, total nitrogen cannot quantify the values of transfer of the different forms of nitrogen between living organisms and inorganic materials. Thus total N cannot qualitatively express the diversity of the forms of nitrogen that vary considerably in soils subjected to specific climatic constraints, environmental conditions such as types of vegetation, or different farming systems, nor can it express the complex interactions between micro organizations which control the nitrogen cycle. The components of proteins, carbohydrates, hemicelluloses, cellulose,

and lignin from living organisms are degraded in the soil, lignin being the most stable fraction.

The phases of N immobilization occur in the form of organic and fixed N, and occluded or exchangeable forms of  $\text{N-NH}_4^+$ . The phases of nitrification/denitrification produce  $\text{NO}_2^-$ ,  $\text{NO}_3^-$ ,  $\text{N}_2$ , nitrogen oxides (with uptake by plant roots and losses through drainage). N processes in the soil can be modified by symbiotic associations between plants (e.g. leguminous plants) and bacteria (rhizobia, actinomycetes) which involve the formation of nodules that enable nitrogen to be fixed from the atmosphere.

The analysis of "Total N" using a wet method derives from that proposed by Kjeldahl (1883). Without time-consuming complementary treatments that method does not allow all the forms of N pools to be recovered entirely. The organic and inorganic nitrogen compounds include (in varying proportions):

- Inorganic forms, (1)  $\text{NH}_4^+\text{-N}$ , which is exchangeable or fixed in the mineral or organomineral lattices, (2)  $\text{NO}_3^-\text{N}$ , which is abundant under intensive cultivation on heavily fertilized soils, (3)  $\text{NO}_2^-\text{N}$ , which is generally negligible except in waterlogged soils or when it results from polluting wastes;  $\text{NO}_3^-\text{N}$  and  $\text{NO}_2^-\text{N}$  are very soluble and are consequently easily leached by water infiltration and run-off.
- Entities whose chemical, physical, and biochemical behaviours are well enough defined to enable them to be grouped in selective pools: plant fractions in different stages of decay, active microbial biomass, biological forms (amino acids, amino sugars, proteins of bacterial cells), N subjected to hydrolysis in an acid medium, N of doubtful composition not subjected to hydrolysis. Part of N is also included in complex humified compounds of varying degrees of stability: relatively instable fulvic acids, humic acids with varying degrees of polycondensation, humins (bound on clays and cementing Fe-Al agents) especially protein forms that are weakly attacked by proteases.

The evolution of soil organic nitrogen is linked to the molecular forms of humic compounds. The processes of condensation of humic molecules and of formation of organo-mineral compounds modify the stability of the different pools. These pools can be ranked on the basis of increasing stability as follows: fulvic acids < organo-aluminous compounds < organo-ferric compounds < humic acids < various organo-mineral compounds < humins fixed on clays. The production of ammonium is an indication of instability.

At the physical level, the organic layers adsorbed superficially on the mineral or organomineral matrices react more easily than those fixed in the lattices. At the chemical level, the short nitrogen chains are hydrolysed more rapidly than the long chains or the N compounds fixed in clays.

The addition of water before analysis releases a varying proportion of fixed N by causing swelling of the lattices of certain 2:1 clays. This fixed or occluded N can play a role in plant nutrition (Mengel and Scherer 1981; Keerthisinghe et al. 1984). Classical Kjeldahl analysis makes it possible to quantify only one part of it; so to control this variable, the mineral matrix must first be destroyed by a mixture of HF–HCl (cf. Sect. 10.3.5 in Chap.10).

The question of whether it is possible to fully describe the relative availability of N compounds in the soil by means of models of the chemical and physical compartment that distinguish all the active and passive forms has not yet been answered. But whether the answer is yes or no, the analysis of total organic and inorganic N is an essential component of mathematical models based on a dynamic simulation of the forms of N in the soil – plant – climate systems.

### 10.2.6 Total Nitrogen by Kjeldahl Method and Titrimetry

#### *Principle*

##### *Mineralization*

The aim is to transform organic N forms into ammonium-N form using a wet method in a concentrated sulphuric acid medium in the presence of catalysts.

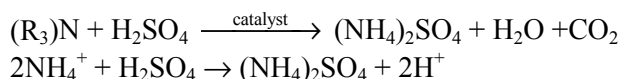

All nitrogen in amide, imide, nitro N–N, nitroso N–O, or other forms is transformed into the ammonium salt form. The thermal stability and the rise in temperature of the reaction medium are ensured by the addition of K<sub>2</sub>SO<sub>4</sub>. Nitrates and nitrites are probably not accounted for, even with a mercury catalyst:

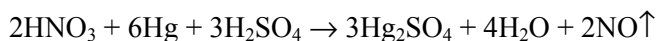

Nitrates and nitrites can be reduced by salicylic acid  and sodium hyposulfite  $\text{Na}_2\text{S}_2\text{O}_3$ .

#### ***NH<sub>4</sub><sup>+</sup> titration***

The  $\text{NH}_4^+$ -N produced is transferred to a basic medium by steam distillation, and then titrated volumetrically in the presence of an indicator.

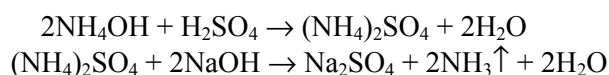

After transfer the  $\text{NH}_3$  is collected in boric acid (Winkler 1913) and titrated by acidimetry:

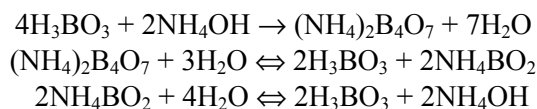

It is also possible to delay titration, and first to complete distillation, and then to perform titration.

#### **Equipment**

- Analytical balance ( $\pm 0.1$  mg).
- Rack for attacks with gas heating or thermostatic heating blocks regulated at  $360^\circ\text{C}$ .
- 350 mL Pyrex Kjeldahl flasks, or Pyrex cylinders for heating blocks.
- Dosing spatula for catalysts ( $\cong 500$  mg, 1 g, 2 g).
- Glass balls of 6 mm dia.
- Teflon flask dispenser.
- Pyrex ball jacks (Fig 10.1a).
- Fume hood with outlets for heavy vapours.
- Distillation or steam distillation apparatus.
- 250 mL Pyrex Erlenmeyer flasks.
- 50 mL burette ( $\pm 1/10$  mL).
- Magnetic stirrer with Teflon magnetic stirring bars.
- 5,000 g centrifuge and 100 mL Pyrex centrifugation tubes.
- Spectrocolorimeter.

### Reagents

- Sulphuric acid,  $H_2SO_4 d = 1.83$ .
- Sulphuric acid containing  $50 \text{ g L}^{-1}$  salicylic acid.
- Catalyst: grind and sieve (Afnor NF22) 100 g of potassium sulphate ( $K_2SO_4$ ), 20 g of copper sulphate ( $Cu(SO_4)_5H_2O$ ), 2 g of grey selenium powder (Se); homogenize and store in a wide-necked bottle.
- 2% boric acid ( $H_3BO_3$ ) solution in distilled water.
- Taschiro indicator (Ma Zuazaga 1942): mix one part of 0.1% methyl red ethanol solution with three parts of 0.1% bromocresol green ethanol solution; store in a brown bottle with dropper.
- Sodium hydroxide (NaOH) solution  $\cong 10 \text{ mol L}^{-1}$ : weigh 2.5 kg of NaOH pellets and carefully dissolve in 6 L of distilled water; let cool in a closed Pyrex bottle ( $CO_2$  is eliminated by precipitation of  $Na_2CO_3$ ); decant Pyrex bottle then discard the bottom part; store in an airtight bottle.
- 1% phenolphthaleine solution in 30% ethanol solution.
- Standard solutions of 0.1 and 0.05 mol (H+)  $L^{-1}$  sulphuric acid.
- Standard ammonium sulphate solution: weigh 4.714 g of  $(NH_4)_2SO_4$  dried on  $P_2O_5$ ; dissolve in deionised water and complete to 1 L; 1 mL solution = 1 mg N.

### Procedure (Macro-Method)

#### Mineralization

Weigh 2 g ( $\pm 0.1$  mg) of soil (ground to 125  $\mu\text{m}$  particle size) on non-gummed cigarette paper (without nitrogen). Close carefully by twisting the paper.

Transfer the sample to a 350 mL glass Pyrex flask. Wet the soil with a jet of distilled water from a wash bottle. Agitate gently until complete homogenisation of the soils. Leave in contact overnight.

Carefully (especially with calcareous soils) add 20 mL of concentrated sulphuric acid. With a dosing spatula, add 2 g of catalyst. Add 3 glass balls (diameter 6 mm), place a ball jack in the neck of the flask and place the flask on the rack (Fig. 10.1a). Adjust the gas flame to low and check for the formation of foam. The flask should be tilted at an angle of 45–60°C to limit the risk of projections and to allow better recovery of condensation on the lower walls (Fig. 10.1a). When the soil organic matter is broken up, the colour of the sample will have faded; raise the heat and boil for 2–3 h without going to dry.

**Distillation and titration by acidimetry**

Leave to cool. Rinse the jack and the flask walls with about 10 mL distilled water. Fit the flask in the distillation apparatus (Fig. 10.1b). Add 100 mL of 10 mol L<sup>-1</sup> sodium hydroxide solution. Turn off the tap to begin steam distillation.

Collect the distillate in the Pyrex Erlenmeyer flask containing 20 mL of 2% boric acid solution and 3 drops of Taschiro indicator; take care that the end of the exit tube is below the surface of the liquid in the Erlenmeyer flask. Approximately 80 mL of the distillate are needed for quantitative recovery.

Titrate by volumetry with the 0.1 or 0.05 mol (H<sup>+</sup>) L<sup>-1</sup> sulphuric acid solution depending on the estimated quantity of the contents. The end point is indicated by a change in colour from green to greyish purple.

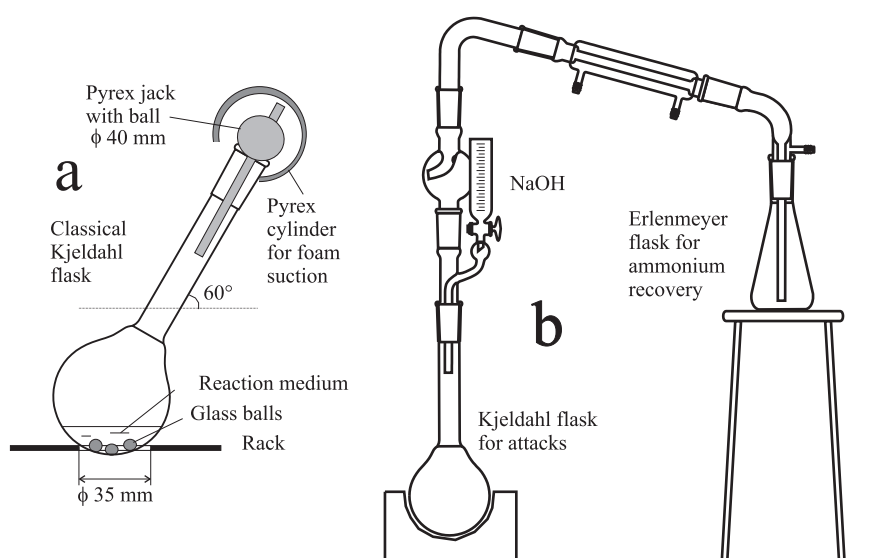

**Fig. 10.1.** Minimal equipment needed for Kjeldahl titration of total-N, (a) acid mineralization with device to limit acid loss, (b) distillation of resulting ammonia by addition of soda; for a more powerful apparatus for steam distillation, see Fig. 10.3 in Chap. 14

**Expression of the Results**

The results  $T_N$  are expressed in mg of nitrogen N per kg of soil dried at 105°C:

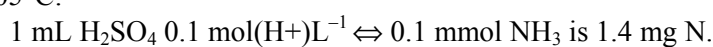

If  $V_A$  is the volume (mL) of the  $0.1 \text{ mol (H}^+) \text{ L}^{-1} \text{ H}_2\text{SO}_4$  solution and  $P$  the mass (g) of the test specimen of soil dried at  $105^\circ\text{C}$ , the N content of the soil is expressed in  $\text{mg (N) g}^{-1}$  (soil) by:  $T_N = 1.4 \frac{V_A}{P}$ .

### Controls

Controls are made by distilling an ammonium sulphate solution of known concentration (1) one distillation after attack under the same conditions as the samples in the presence of  $1,000^\circ\text{C}$  fired quartz (blank assay), (2) one direct distillation of the ammonium sulphate solution. The value of the blank assay is calculated by the difference between the two. Two reference samples and two replicates of samples chosen randomly in the series should be analysed each day.

### Notes

First the experimental standard X 31111 (1983) and then the international standard NF ISO 11261 (1995) were published for the determination of soil total nitrogen by distillation after Kjeldahl mineralization.

Discolouration is not a sign of the end of mineralization, but an indicator of the end of the oxidation of the humified coloured organic matter signalling the end of the production of foam. The conversion of the N organic products into ammonium obeys other criteria such as temperature, catalyst, time, and nature of the N compounds.

The addition of potassium sulphate enables the boiling point of the sulphuric acid to be increased and the attack time to be reduced. To avoid losses, use dose less than  $0.5 \text{ g K}_2\text{SO}_4$  per millilitre of sulphuric acid with selenium as catalyst. The boiling point of  $\text{H}_2\text{SO}_4$ , normally  $330^\circ\text{C}$ , increases to  $364^\circ\text{C}$  after addition of  $1 \text{ g}$  of  $\text{K}_2\text{SO}_4$  per mL of sulphuric acid.

*Catalysts* (1) mercuric oxide is very effective but pollute the environment; mercuric oxide can form amino complexes which are not released during distillation unless the sample is not treated with thiosulfate, (2) selenium allows quantitative recovery of N; the temperature should not be too high ( $<367^\circ\text{C}$ ) and attacks should be limited in time (maximum 3 h) to avoid the risk of losses, (3) the NF ISO 11261 standard (1995) recommends replacing Se by anatase  $\text{TiO}_2$  which is less polluting for the environment (catalytic mixture  $200 \text{ g K}_2\text{SO}_4$ ,  $6 \text{ g CuSO}_4 \cdot 5\text{H}_2\text{O}$ ,  $6 \text{ g TiO}_2$ ).



Grinding the samples to 125  $\mu\text{m}$  enables micro-methods to be used without a serious reduction in precision (Parnas and Wagner, 1921; Markham 1942), thereby reducing the cost price, pollution, and the extent of work surface required.

The use of heating blocks decreases the turbulence of the attacks as heating is more regularly distributed. Programming the stages of heating makes it possible to accomplish the mineralization cycle without monitoring.

### 10.2.7 Kjeldahl N, Titration by Spectrocolorimetry

#### Principle

After digestion in a sulphuric acid medium catalysed by selenium (without copper or titanium) the reaction (Berthelot 1859; Bolleter et al. 1961) is continued in basic medium (sodium hydroxide buffer and dibasic sodium phosphate).

The  $\text{NH}_4^+$  ion reacts with the sodium hypochlorite and the sodium phenolate (or the sodium salicylate) to give a blue-green complex. The reaction is catalysed by the sodium nitroprussiate.

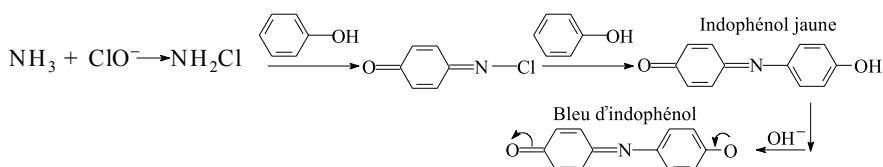

#### Equipment

- cf. “Equipment” under Sect. 10.2.6
- Centrifuge
- Automated segmented continuous-flow analysis with  $\text{NH}_4^+$  manifold

#### Reagents

All the reagents should be of reference analytical grade:

- Mineralization products: see “Reagents” under Sect. 10.2.6.
- Brij 35 detergent: polyoxyethylene lauryl ether  $\text{C}_{12}\text{H}_{25}(\text{OCH}_2\text{CH}_2)\text{OH}$  (to limit contamination of the analytical manifold).
- 20% sodium hydroxide (NaOH) stock solution.
- Sodium phosphate,  $\text{Na}_2\text{HPO}_4 \cdot 2\text{H}_2\text{O}$ .

- 20% sodium potassium tartrate,  $\text{NaKC}_4\text{H}_4\text{O}_6 \cdot 4\text{H}_2\text{O}$  (Seignette salt) stock solution.
- Stock buffer solution: dissolve 89 g  $\text{Na}_2\text{HPO}_4 \cdot 2\text{H}_2\text{O}$  in 800 mL deionised water; cool and add 50 mL of 20% NaOH solution; homogenize and complete to 1,000 mL.
- Buffer solution: mix 200 mL of buffer stock solution, 250 mL of stock solution and 20% of sodium potassium tartrate; add 60 mL of 20% NaOH stock solution and about 300 mL water; homogenize and cool; add 1 mL of Brij 35; bring to 1 L and homogenize.
- Sodium salicylate: dissolve 150 g of sodium salicylate and 300 mg of sodium nitroprussiate in 800 mL water; bring to 1 L; filter on a Büchner funnel with a blue filter without  $\text{NH}_4$  and add 1 mL of Brij 35; store in a brown bottle protected from the light.
- Sodium nitroprussiate,  $\text{Na}_2\text{Fe}(\text{CN})_5\text{NO} \cdot 2\text{H}_2\text{O}$ .
- Sodium hypochlorite, NaClO: add 5 mL NaClO in 80 mL distilled water, bring to 100 mL; add 2 drops of Brij 35; prepare a fresh solution each day.
- Ammonium sulphate,  $(\text{NH}_4)_2\text{SO}_4$ .
- Hydrochloric acid, HCl 37%.
- Standard  $\text{NH}_4$ : pour 80 mL HCl 37% in 800 mL water; cool and bring to 1,000 mL with water; prepare a stock solution of ammonium sulphate at  $100 \text{ mg NH}_4^+ \text{-N mL}^{-1}$ ; store in the refrigerator; solutions should be freshly prepared each day starting from the stock solution to provide ranges from 0 to  $50 \text{ } \mu\text{g mL}^{-1}$ .

### Procedure

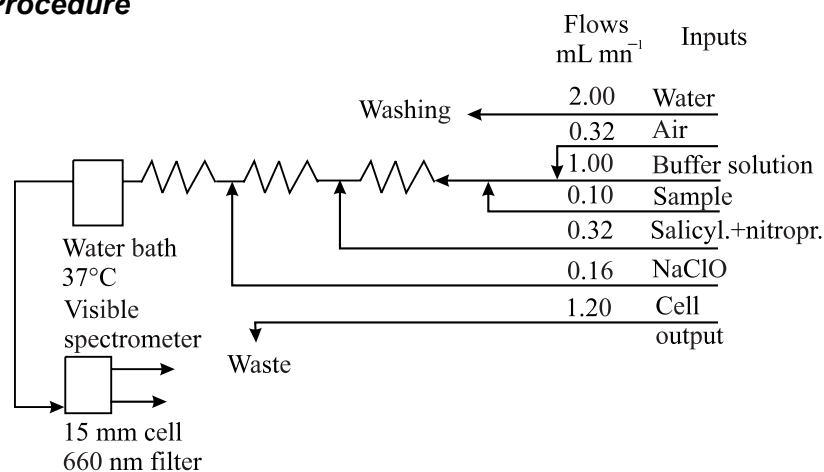

**Fig. 10.2.** Titration of total nitrogen by segmented continuous-flow analysis after mineralization (Buurmans et al. 1996)

Mineralization is carried out as in “Mineralization” in “Procedure (Macro-Method)” under Sect. 10.2.6, but with no copper sulphate in the catalyst mixture. At the end of the attack, cool the sample, and after complete cooling, dilute and pour into a 250 mL volumetric flask.

After adjusting the volume and homogenisation, centrifuge each aliquot at 3,000 g for 15 min to obtain a clear solution. Remove the test samples for analysis from the supernatant and dilute if necessary in suitable stages of dilution (for example five times) when introducing the sample in the N-NH<sub>4</sub> manifold. Titration is by absorption at 660 nm in a 15 mm colorimetric cell. The manifold proposed by Buurmans et al. (1996) is shown in Fig. 10.2 without the dilution stage. In the case of highly calcareous soils, it is sometimes necessary to add EDTA in addition to K and Na tartrate to avoid side effects due to the calcium which is precipitated in the sulphuric acid medium and can give a colloidal precipitate that is not easily visible to the naked eye (Gautheyrou and Gautheyrou 1965).

### 10.2.8 Kjeldahl N, Titration by a Selective Electrode

#### *Principle*

The principle is similar to that described in Sect. 10.3.2 of Chap. 28 for the titration of ammonium nitrogen. Only the conditions of use are a little different. Here the gas diffusion electrode enables the results to be read directly on the calibration curve. The response is linear in the 0.5–500 mg L<sup>-1</sup> zone of concentration of nitrogen with a lower degree of precision for high concentrations because of the logarithmic response. A range of concentrations of from 0.5 to 10 mg L<sup>-1</sup> is recommended.

This method has the advantage of being extremely simple and a wide range of concentrations can be analysed. Daily calibration is not necessary if the working temperature is always the same. Under normal working conditions, no interference occurs.

#### *Equipment*

- Mineralization equipment: cf. “Equipment” under Sect. 10.2.6.
- Orion model 95–100 gas electrode.
- Ionometer (pHmeter, mVmeter) with a resolution of 0.1 mV.
- Thermostated bath regulated at 25°C.
- Magnetic stirrer.

### Reagents

- Mineralization acid: cf. “Reagents” under Sect. 10.2.6.
- Ten mole (NaOH) L<sup>-1</sup> soda solution.
- Standard solution: dissolve 1.179 g of ammonium sulphate ((NH<sub>4</sub>)<sub>2</sub>SO<sub>4</sub>, mw = 132.12) in distilled water and bring to 250 mL; this solution contains 1 mg (N) mL<sup>-1</sup>; dilute 10 times to obtain the initial reference solution 0.1 mg (N) mL<sup>-1</sup>.
- Ammonium chloride solution to fill and maintain the electrode: 0.1 mol (NH<sub>4</sub>Cl) L<sup>-1</sup>.

### Procedure

Mineralization is carried out as in “Mineralization” in “Procedure (Macro-Method)” under Sect. 10.2.6. At the end of the attack, cool the sample and transfer it to a 200 mL volumetric flask. After complete cooling, bring the volume to 200 mL.

Construction of the standard curve: in 50 mL beakers add the volumes of the 0.1 mg (N) mL<sup>-1</sup> reference solution listed in Table 10.4; complete to 20 mL with additional volumes of the blank attack solution (cf. Sect. 10.2.).

Bring the temperature of the beakers and the blank to 25°C, immerse the electrode in the blank avoiding the presence of air under the membrane; add 2 mL of the 10 mol (NaOH) L<sup>-1</sup> soda solution; start gentle agitation to limit the Vortex effect; after 5 min, adjust the zero of the ionometer.

**Table 10.4.** Range of titration of total nitrogen by ionometry; the content of the soil is given for a test sample of 2 g, volume of solution after attack (cf. “Mineralization” in “Procedure (Macro-Method)” under Sect. 10.2.6): 200 mL, aliquot for titration: 20 mL

mL of standard solution 0.1 mg (N) mL <sup>-1</sup>	mL of attack solution for 20 mL	mL NaOH 10 mol L <sup>-1</sup>	solution concentration mg (N) L <sup>-1</sup>	soil concentration mg (N) g <sup>-1</sup>
1	19	2	5	0.5
2	18	2	10	1
4	16	2	20	2
6	14	2	30	3
8	12	2	40	4
10	10	2	50	5

Proceed in the same way for the different points of the calibration range. Record the signal in mV and plot the calibration curve with the logarithms of nitrogen concentrations on the *x*-coordinate and mV on the *y*-coordinate.

The measurements should be carried out on 20 mL aliquots of each attack solution using the same technique as for the calibrations. It is essential to carry out titrations immediately after the addition of soda to avoid loss of ammonia.

### **Remarks**

Before starting analysis, it is important to check the pH of the measurement solutions which must be from 11 to 13 after the addition of soda (Table 10.4). In the case of a lower pH, slightly increase the volume of the 10 mol (NaOH) L<sup>-1</sup> soda solution.

After use, the electrode should be stored carefully following the manufacturer's instructions. The filling solution should be renewed periodically.

### **10.2.9 Mechanization and Automation of the Kjeldahl Method**

The Kjeldahl method has the advantage of requiring only simple equipment and of being the reference method. However, manual methods are time consuming. They require large laboratory work surfaces and fume hoods to evacuate the heavy vapours. The technique can be improved by automation which makes it possible to avoid direct handling of dangerous reagents such as boiling sulphuric acid or concentrated soda.

The use of programmable heating blocks (e.g. Technicon, Skalar, Tecator) enables the temperatures of mineralization to be regulated and sudden starts and foaming during the attacks to be limited.

Partially automated equipment exists comprising management stations for mineralization, distillation, and titration at the macro and micro scale (e.g. Bicasa, Bucchi, Gerhart, Skalar, Foss-Tecator, Velp). Prolabo, Cem, Questron enable accelerated mineralization by microwave heating; the attack containers are processed automatically.

Complete automation was provided by manufacturers *such as* Tecator, Foss, Perstop, or Gerhart. Mineralization is automated, and final titration is carried out by titrimetry with potentiometric detection of the end point of titration, or by spectrophotometry. The job of the analyst is limited to filling up the reagents, regulating the heating programmes and recovering the results at the end of the day. Monitoring is simplified because an alarm goes off in the case of accident.

### 10.2.10 Modified Procedures for $\text{NO}_3^-$ , $\text{NO}_2^-$ , and Fixed N

These methods are seldom used in repetitive analyses because of the uncertainty of the results, the length of time required for the procedures, and the fact that the contents are often not very significant.

#### ***Nitrate and Nitrite***

The determination of total N using wet methods does not take nitrate into account, but as it is generally not present in large quantities in natural environments, there will be no effect on results obtained on dried samples. However, in the case of cultivated soils dressed with manure with a high N content, it is preferable to rapidly check for the presence of nitrate using commercial tests, because nitrate and nitrite can introduce a random error.

Nitrate and nitrite can be included in Total-N by means of redox sequences before Kjeldahl mineralization (1) by  $\text{KMnO}_4/\text{Fe}^{2+}$  where the nitrite is oxidized into nitrate by a potassium permanganate solution, the nitrate then being reduced in ammonium by ferrous iron before the mineralization sequence in the traditional method (cf. "Procedure (Macro-Method)" under Sect. 10.2.6); (2) by a system using salicylic acid/ammonium thiosulfate in which nitration by salicylic acid can occur quantitatively only in absence of water (Fuson 1962); the nitrated compounds are then reduced by ammonium thiosulfate before Kjeldahl mineralization as in "Procedure (Macro-Method)" under Sect. 10.2.6 (Nelson and Sommers 1980; Du Preez and Bate 1989). The international NF ISO 11261 standard (1995) recommends (1) action of 4 mL of a salicylic/sulphuric acid mixture (25 g salicylic acid in 1 L concentrated  $\text{H}_2\text{SO}_4$ ) for a few hours or overnight, (2) the addition of 0.5 g of sodium thiosulfate with moderate heating until the foam disappears, (3) cooling the flask and the addition of a catalyst (dioxide of titanium instead of selenium) and sulphuric acid for Kjeldahl mineralization. Nitrate and nitrite can also be titrated separately using the methods described in Chap. 28.

#### ***Fixed or Occluded N***

The determination of fixed or occluded N is very delicate. Indeed, some authors have raised questions both with respect to its nature (inorganic  $\text{NH}_4^+$ -N only, or organic and inorganic N) and to its modes of fixing N. Fixed N is not titrated quantitatively by the traditional method particularly in soils containing 2:1 clays. To titrate fixed N, a polyethylene bottle is used, and the clay lattice is destroyed by a mixture HF-KCl or concentrated KOH (cf. Sect. 28.3.5 of Chap. 28). The organic digestion of N is then

---

carried out in traditional Kjeldahl flasks (cf. Sect. 10.2.6).

### *Remarks*

As the glass of the Kjeldahl flasks is seriously affected, their quality deteriorates rapidly and they need to be regularly replaced. The fixing of N-NH<sub>4</sub> in the mineral lattices is more important in the deep horizons which are rich in clay and low in N compounds; the increase in N-fixing power as a function of the nature of clays can be expressed by: vermiculites > illites > montmorillonites > kaolinites.

In certain cases the expansion of the lattices, which is obtained by the addition of water, can lead to higher values for total-N (Bal 1925). Conversely, the rate of recovery of NO<sub>3</sub>-N may be lower (Bremner and Mulvaney 1982).

## **10.3 Dry Methods**

### **10.3.1 Total Carbon by Simple Volatilization**

These methods are based on oxidation of the soil organic matter and on destruction of carbonates by heating of the samples to relatively high temperatures for a given length of time. Measurement of the loss in mass (cf. Chap. 1) allows estimation of gaseous losses that are mainly in the form of CO<sub>2</sub> and H<sub>2</sub>O. Resistance or induction furnaces can function at temperatures of 1,000–1,500°C.

In the simplest case, an open air circuit is used, possibly with oxygen enrichment (low temperature ashing, LTA), or in closed systems with controlled temperature and time. Traps can be used to block some compounds, and catalysts can accelerate the reactions. Gas separation systems of varying degrees of sophistication are used in sequential analyses of evolved gas. To sum up, a temperature range lower than 500°C enables collection of the CO<sub>2</sub> released by the organic matter and temperatures higher than 500°C, of CO<sub>2</sub> produced from carbonates.

Although calcination methods using an open circuit for the determination of Total-C are very simple to implement, they cannot be regarded as quantitative and generally have to be supplemented by thermal analysis techniques (cf. Chap. 7). In an oxidizing atmosphere, gravimetric measurements will represent:

- Organic C transformed into CO<sub>2</sub>.
- Inorganic C starting from approximately 400°C.

- Different forms of water (hygroscopic, interstitial, water of crystallization, hydroxyl groups) which are moved throughout the thermal cycle.
- Volatile forms of N, S, certain metals, and metalloids (Cl<sup>-</sup>).

These displacements vary with the temperature used and with the times of application. Still other transformations can disturb measurements.

In an oxidizing atmosphere, some compounds of the soil that are sensitive to redox reactions will increase in weight while passing to a higher valence, for example  $\text{Fe}^{2+} \rightarrow \text{Fe}^{3+}$ . Sulphur compounds can, by recombination, show simultaneous losses and increases in mass as a function of the medium:  $\text{H}_2\text{S} \rightarrow \text{SO}_2 \rightarrow \text{SO}_3 \rightarrow \text{SO}_4^{2-}$ .

The results are thus random, and are related to the atmosphere used (oxidizing, neutral, reducing) and to effects of the matrix. The thermostable residue of the soil can be considered reached between 1,100 and 1,600°C. In most cases, total organic and inorganic C with C obtained by the simple measurement of the losses on ignition cannot be directly assimilated. Below 500°C, C losses at lower temperatures can easily characterize oxidizing C, but it is difficult to quantify this variable.

However, certain soils enable results with a reduced margin of error, in particular sandy soils with low 1:1 clay content, but not calcareous soils, or soils rich in organic matter. The decarboxylation of the organic matter starts around 180°C, and at 250°C, it is estimated that 70% of organic C is oxidized, and 90% around 500°C. Temperatures between 800 and 950°C are needed to obtain 99% of oxidation of organic C.

In the case of carbonates, decomposition starts at around 400°C: calcium and magnesium carbonates (e.g. calcite-aragonite, magnesite, dolomites) generally display the same type of thermal behaviour, but biogenic calcite (shells, skeletons, calcareous debris), iron carbonate (siderite), fossil coals, and resins can respond differently, as can sodium carbonates with a low melting point (851°C).

### 10.3.2 Simultaneous Instrumental Analysis by Dry Combustion: CHN(OS)

#### *Principle*

Thanks to improved equipment, the purchase of entirely automated CHN(OS) apparatuses (Pansu et al. 2001) is very tempting. These apparatuses are very profitable in laboratories that do many repetitive



analyses, as they can do simultaneous analysis of C, N, and H and, under adequate operating conditions, of O and S in addition. To ensure the uninterrupted performance of the apparatuses, the operators need to be specially trained. The apparatuses also have to be regularly checked and maintained, and the exact conditions of use clearly defined. In this type of set-up, each element in the chain is linked to the others (furnace, CuO, catalysts, and different traps) and the weakest link in the chain determines the final quality of the analyses. The method is the subject of the international standard NF ISO 10694 (1995) for the analysis of organic carbon and total carbon of soils.

Seal a given mass representative of the sample in a tin (or silver) micro-capsule and place it in a furnace at 1,100°C in a controlled atmosphere in the presence of oxygen and copper oxide. The different forms of organic and inorganic C and N oxidize or break down rapidly according to the principle of the Liebig reaction (1830)

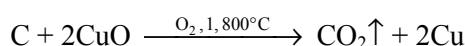

The temperature of 1,800°C is reached by flash combustion of the tin capsules. The carbonates and bicarbonates are broken up simultaneously. For titration of organic C, carbonates, and bicarbonates must be eliminated chemically before the sample is placed in the furnace

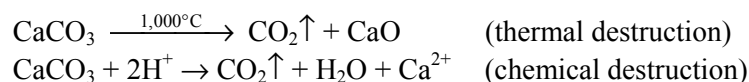

If methane is present and has to be titrated, Cr<sub>2</sub>O<sub>3</sub> should be used to ensure perfect oxidation. The organic nitrogen that is oxidized during combustion gives nitrogen oxides which must be reduced with copper to transform all nitrogen oxides into the N<sub>2</sub> form by the Dumas (1831) method. Inorganic N compounds (NH<sub>4</sub><sup>+</sup>, NO<sub>3</sub><sup>-</sup>, NO<sub>2</sub><sup>-</sup>) are subtracted to obtain total organic N. Different catalysts can be used to accelerate the reactions or to make them quantitative.

Finally, the gas products are identified in suitable detectors; the gaseous compounds can be separated on temporary specific traps or by gas chromatography, depending on the system used. In soils that do not contain carbonates or bicarbonates, or have not received calcareous amendments or lime:

- Inorganic C = 0.
- Total C = total organic C.

### **Equipment**

- Elementary Analyzer CHN(OS), preferably able to handle samples of approximately 100 mg or more to compensate for the heterogeneity of carbon in soil (Pansu et al. 2001)<sup>1</sup>.
- Micro analytical balance.
- Needle-nosed pliers to close the capsules.
- Micro pipette adjustable 0.1–0.5 mL.
- Ceramic plate for treatment of calcareous samples.
- Controlled temperature hotplate.

### **Products**

All consumables should be suitable for the procedure and type of analytical materials used (analytical grade reference products):

- Combustive gases, carrier gas purity: 99.98%
- Copper oxide, (CuO)
- Copper in the form of wire or chips (Cu)
- Magnesium perchlorate ( $\text{Mg}(\text{ClO}_4)_2$ ), ascarite (NaOH-asbestos),  $\text{MnO}_2$ , etc. for traps
- Tin or silver micro capsules, capacity 100 mg
- A range of catalysts
- Standard substances for calibration and control such as acetanilide ( $\text{C}_8\text{H}_9\text{ON}$ , 71.09% C, 6.71% H, 10.36% N, 11.84% O), atropine ( $\text{C}_{17}\text{H}_{25}\text{NO}_3$ ), sulphanilamide  $\text{H}_2\text{NC}_6\text{H}_4\text{SO}_2\text{NH}_2$ , picric acid (2,4,6 trinitrophenol  $(\text{NO}_2)_3\text{C}_6\text{H}_2\text{OH}$ ), thiourea ( $\text{H}_2\text{NCSNH}_2$ ), etc.

### **Procedure**

#### ***Non-calcareous soils***

All weighing should be done on analytical balances ( $\pm 0.1$  or  $\pm 0.01$  mg)

*Calibration:* weigh 5 sample specimens of increasing mass of a standard in the range of concentration accepted by the CHN apparatus concerned. The precision of the equipment should be tested by comparing the theoretical contents with the contents obtained.

---

<sup>1</sup> A higher mass of sample specimen increases the representativeness of the sample but produces more ashes in the combustion furnace. The current trend is to reduce the mass of sample specimen to about 10 mg and to increase the homogeneity of the sample by very fine grinding to a particle-size of less than 100 micrometers.

*Samples:* grind the samples to 125  $\mu\text{m}$  (Sieve AFNOR NF22) and dry for 48 h in a  $\text{P}_2\text{O}_5$  desiccator to limit saturation of the traps. In tin or silver capsules, carefully weigh from 50 to 100 mg of sample (depending on the estimated contents of C and N) dried on  $\text{P}_2\text{O}_5$ , and seal the capsule. Place the capsules in the sample distributor of the CHN apparatus.

At the same time, weigh 1 g of the same sample to measure residual moisture by drying at 105°C in order to be able to correct the results (cf. Chap. 1). Direct drying of the samples at 105°C before CHN analysis may increase ammonium fixation in the lattice of 2:1 clays, but in most case this is acceptable.

#### **Note**

Andosols and histisols pose two problems (1) the residual moisture of air-dried soil is very high, up to 50–60% after 6 months; (2) low bulk density can reach 0.30–0.25. In this case it is not possible to weigh 100 mg in the capsules.

#### **Carbon in calcareous soils**

In the case of calcareous samples or soils that have been limed, if there is no siderite (not easily decomposable  $\text{FeCO}_3$ ), treatment with 10% hydrochloric acid solution is sufficient to destroy the carbonates and bicarbonates in the sample:

- Weigh 100 mg of sample in a silver capsule.
- Place the open capsule on a ceramic plate.
- With a micro pipette, slowly add 0.1–0.2 mL of 10% HCl depending on the estimated quantities of carbonate and bicarbonate.
- Leave in contact for 2 h then add 0.1 mL of the 10% HCl solution. Check that gaseous emission is complete.
- Place the ceramic plate on a hotplate at 60°C and bring to dry. Leave to cool and seal the capsule. Place the capsule on the CHN sampler to measure total organic C. A second sample can be weighed without destroying carbonates to measure total C. Total inorganic C can be calculated by difference.

On certain apparatuses it is preferable to use phosphoric acid rather than hydrochloric acid to limit the effects of chloride on the catalysts and on the traps.

### **Calculations**

The results are calculated directly and printed by the CHN analyser after measurement of the surface of the C and N peaks. These calculations take the weight of the sample into account.

To determine total organic nitrogen, the results obtained for total inorganic nitrogen have to be taken into account (cf. Chap. 28).

$$\text{Total N (CHN)} = \text{inorganic Nitrogen} + \text{organic Nitrogen}$$

### **Titration of Hydrogen, Oxygen and Sulphur**

*Hydrogen is titrated* together with carbon and nitrogen using the procedure described in "Procedure" under Sect. 10.3.2 by measuring the water formed during combustion. However this measurement is difficult to interpret in most soils because hydrogen resulting from combustion of the organic molecules and hydrogen coming from the different forms of water (e.g. adsorption, hydration, and hydroxylation) is not separated in the H<sub>2</sub>O signal. In soils that are not very clayey and when using carefully dried samples, the H<sub>2</sub>O signal can represent only H coming from combustion of the organic molecules. The C:H ratios then reveal the stages of evolution of the soil organic matter.

*The titration of oxygen and sulphur* is generally carried out with standard CHN equipment by simply modifying the instrumental parameters. For sulphur, controlled oxidation is used, generally in the presence of tungstic anhydride. For oxygen, pyrolysis is used instead of combustion (the oxygen supply is cut off) on a sample specimen reserved for this measurement.

*Total organic oxygen:* the sample is subjected to pyrolysis at 1,100°C in the presence of a catalyst such as a mixture of carbon and nickel. Carbon monoxide (CO) is formed, then isolated by a separation system (generally with a trap or by chromatography) and quantified by a system of detection (e.g. a catharometer). Oxygen is determined by comparison with standards of known O content in the same way as for C and N described in "Procedure" under Sect. 10.3.2: one molecule of CO represents one O atom in the sample.

Total organic oxygen corresponds to only a small fraction of total oxygen of the soil. *Inorganic oxygen*, which is more abundant, is generally estimated starting from the total analysis of the major elements (cf. Chap. 31), by calculating the difference between the sum of the contents expressed in oxides and the sum of the contents expressed in elements.

*Total sulphur:* the sample is oxidized at 1,100°C in the presence of tungstic anhydride WO<sub>3</sub> or a mixture of tungstic and vanadic oxides.

Oxides of sulphur (e.g. sulphur trioxide  $\text{SO}_3$ , sulphur dioxide  $\text{SO}_2$ ) are formed. A stage of reduction on a copper column transforms all oxides into the  $\text{SO}_2$  form. This gas is then isolated and titrated using a system that will depend on the type of equipment used (traps, chromatography) and the type of detector (catharometer, IR detector): one molecule of  $\text{SO}_2$  corresponds to one atom of S in the sample. Depending on the type of equipment used, titration of sulphur may or may not be carried out simultaneously with that of carbon and nitrogen.

Instrumental CHNS methods give a value for the sulphur content that can generally be regarded as the total sulphur content of the soil: oxidation of organic sulphur and sulphides, decomposition of most of the sulphates (Laurent 1990). However, care should be taken given the diversity of natural forms of sulphur. For a more detailed analysis of this element, see Chap. 30.

### **Remarks**

Alkaline salts (e.g. sodium carbonate, chlorides, phosphates) melt to a varying degree and delay the oxidation of C into  $\text{CO}_2$  by coating the organic particles and disturbing the cycle of analysis.

Salts that are volatile at  $700^\circ\text{C}$  or more (e.g. some chlorides, bromides, or iodides) can contaminate (or corrode) the circuits, traps, and catalysts.

Magnesium perchlorate  $\text{Mg}(\text{ClO}_4)_2$ , sold under the name of anhydron or dehydrite, is used to trap water. It is a relatively unstable product that, after use, must be eliminated in the same way as other dangerous waste by the laboratory.

Residues of calcination in the furnace have to be removed frequently, particularly in the case of carbonated saline soils. Changing the protective nacelles makes it possible (1) to preserve the quality of the filters for elimination of the fine particles likely to be present in the gas phase and (2) to limit the retention of volatile products of combustion. Traps, compounds, catalysts, and filters must be changed regularly, respecting the change-by deadlines. Most breakdowns and doubtful results are due to inadequate maintenance.

The use of synthetic standards can result in errors, as their physical and chemical behaviour may differ from that of soil organic matter. However, the temperature of  $1,800^\circ\text{C}$  reached during the flash combustion of the capsules makes it possible to release all the organic compounds. Soil standards with certified organic-C contents are also available for calibration. Elementary CHN(OS) analysers generally give accurate results but these may be higher than wet oxidation.

### 10.3.3 CHNOS by Thermal Analysis

In detailed studies it is important not to overlook the possibilities offered by instrumental methods such as differential thermal analysis (DTA) and thermogravimetric analysis (TGA), coupled or not with measurements of evolved gas analysis (EGA) (cf. Chap. 7).

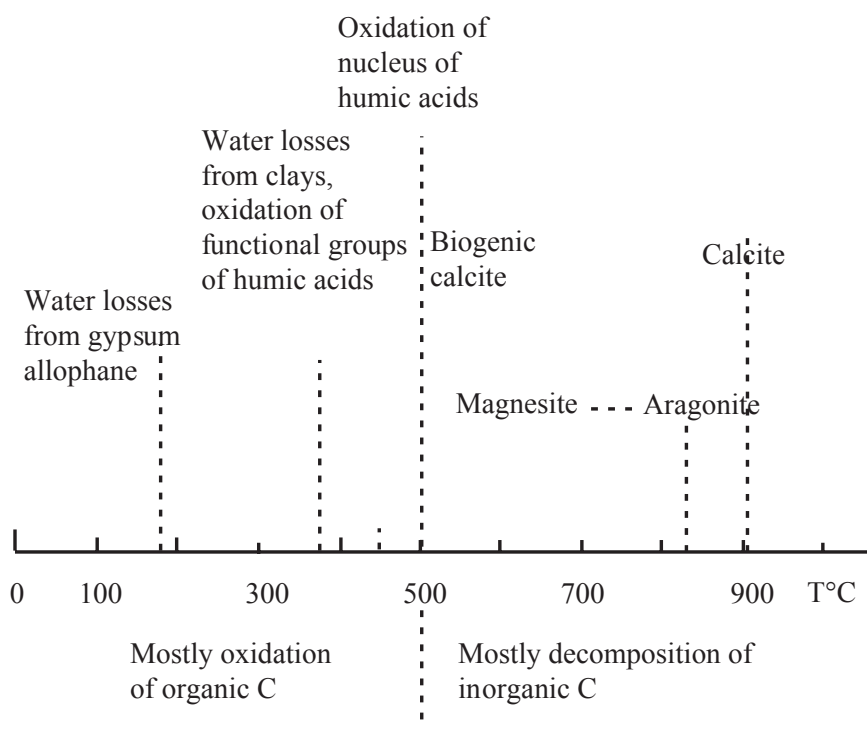

**Fig. 10.3.** Oxidation of organic C and decomposition of inorganic C as a function of temperature

Controlled pyrolysis (with suitable temperature/time programmes) enables oxidation of the organic matter and the decomposition of the inorganic compounds to be monitored. It is possible to identify and quantify the nature of the gases (e.g.  $\text{CO}_2$ ,  $\text{CO}$ ,  $\text{CH}_4$ ,  $\text{H}_2\text{O}$ ,  $\text{NH}_3$ ,  $\text{H}_2\text{S}$ ,  $\text{SO}_2$ ) that correspond to the DTA and TGA peaks as a function of temperature, to monitor the decomposition or the transformation of products containing C and N, and to separate exothermic and endothermic peaks of  $\text{H}_2\text{O}$  and  $\text{CO}_2$ , etc.

For more complete studies, trapping of certain phases at  $-180^\circ\text{C}$ , then their separation by gas chromatography, or by coupling with, for

example, infra-red or mass spectrometers detectors, enables detailed characterization of soil organic matter.

The sum of the different carbon phases gives total C; and it is possible to roughly separate total organic C and total inorganic C (Fig. 10.3). In studies of organic geochemistry, the molecular mass of the fragments of pyrolysis is measured in a mass spectrometer with discontinuous injections. The structure of complex substances with high molecular weights can be characterized.

#### **10.3.4 C and N Non-Destructive Instrumental Analysis**

Analysis by diffuse reflectance near infra-red spectrometry (NIRS, cf. Chap. 5) is carried out directly on the soil sieved on an AFNOR NF22 sieve (125  $\mu\text{m}$  mesh).

Take a sample weighing approximately 1 g after drying in the drying oven and carefully pack it in a special cup and place the cup in the measuring chamber. The surface of the sample must be perfectly flat. Each component of the organic complexes of the soil has a specific absorption point between 700 and 2,500 nm in the NIR spectrum, due to the vibrations of stretching and deformation of the inter-elements bonds (cf. Sect. 10.3.1 in Chap. 5).

For C and N measurement, information provided by the NIRS spectra must be calibrated to data from other methods of measurement. Then the calibration curve is used to quantify C and N in unknown samples. Good calibration has been obtained with the methods described in Sects. 10.3.1–10.3.3 above (Krishnan et al. 1980; Dalal and Henry 1986; Morra et al. 1991; Fidêncio et al. 2002). The method is non-destructive and the samples can be used for other measurements. As each apparatus has its own particular characteristics with regard to selection and optimization, the manufacturer's recommendations should be followed (e.g. Bran-Luebbe, Bruker, Foss, Leco, Nicolet, Perkin-Elmer, and Perstorp).

Rapid methods to estimate soil C in the field are currently the object of serious investigation in research programmes dedicated to C sequestration in soils as part of the effort to decrease emissions of greenhouse gases in the atmosphere. Though they are less precise than laboratory techniques using a wet method or dry combustion, these methods have the advantage of rapidly providing a very large number of measurements at a lower cost. NIRS methods for the processing of analytical signals have been developed thanks to spectacular progress in software. This software can provide quantitative data based on spectra that chemists previously found very difficult to interpret.

In addition to the NIRS method, the laser induced breakdown spectroscopy method (LIBS) has been proposed for soil carbon (Cremers et al. 1996). The detection limit is approximately  $300 \text{ mg kg}^{-1}$ , precision 4–5%, accuracy 3–14%, and the speed of analysis is more than one sample per minute (Cremers et al. 2001).

### 10.3.5 Simultaneous Analysis of the Different C and N Isotopes

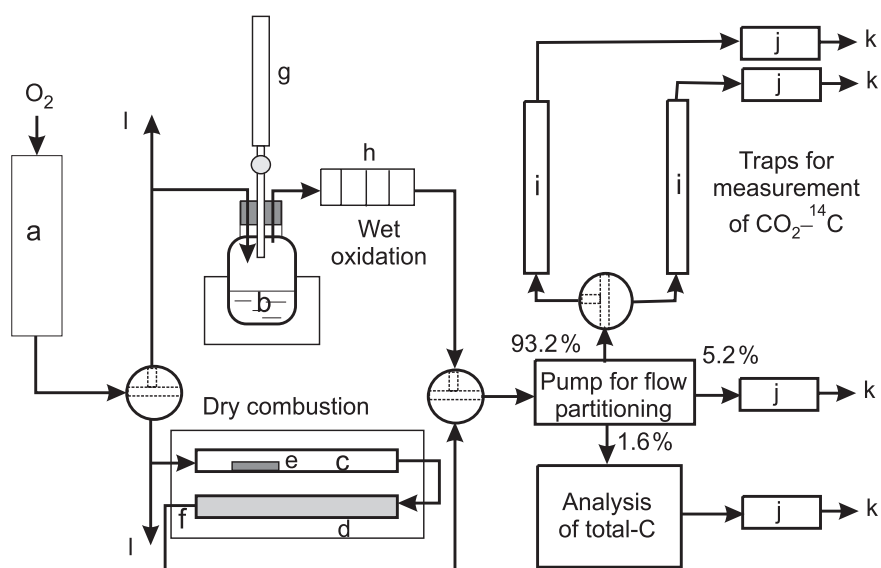

**Fig. 10.4.** Simultaneous determination of total- and  $^{14}\text{C}$ -carbon (diagram by P. Bottner, CEFE-CNRS Montpellier, France, personal communication), (a) soda lime for  $\text{O}_2$  purification, (b) boiling liquid sample +  $\text{K}_2\text{Cr}_2\text{O}_7$ , (c) combustion tube, (d) post combustion tube ( $\text{CuO}$ ), (e) solid sample, (f)  $900^\circ\text{C}$  combustion furnace, (g) automated burette containing  $\text{H}_2\text{SO}_4$  +  $\text{H}_3\text{PO}_4$ , (h) purification traps (water condensation, chromic and acid foams), (i) columns with glass balls impregnated with ethylene glycol mono-ethyl ether + mono-ethanolamine to trap  $\text{CO}_2$ , (j) soda lime traps for security, (k) ventilated external output, (l) output of excess  $\text{O}_2$

Dry combustion analysers – CHN(OS) – can be coupled with mass spectrometers enabling the study of the different isotopes of the elements, particularly  $^{14}\text{C}$ ,  $^{13}\text{C}$ ,  $^{15}\text{N}$  (Pansu et al. 2001). Often  $^{15}\text{N}$  nitrogen is also measured starting from the Kjeldahl distillates in the form of ammonium. The carbon dioxide of the effluent combustion gas can also be trapped for later determination of the isotopes. The Bottner and Warembourg



equipment (1976), shown in schematic form in Fig. 10.4, was used for more than 20 years for simultaneous titration of total-C (carmhograph 12A) and  $^{14}\text{C}$ -carbon (liquid scintillation) starting from solid (soils, plants) or liquid (water of the soil) samples and proved to be reliable.

## References

- Anne P (1945) Sur le dosage du carbone organique des sols *Ann. Agron.*, 15, 161–172.
- Baker KF (1976) The determination of organic carbon in soil using a probe colorimeter. *Lab. Practice*, 25, 82–83.
- Bal DV (1925) The determination of nitrogen in heavy clay soils. *J. Agric. Sci.*, 15, 454–459.
- Berthelot MP (1859) Violet d'amiline. *Répertoire chim. Appl.*, 1, 284.
- Bolleter WT, Bushman, CJ and Tidwell PW (1961) Spectrophotometric determination of ammonia as indophénol. *Anal. Chem.*, 33, 542–594.
- Bottner P and Warembourg F (1976) Method for simultaneous measurement of total and radioactive carbon in soils, soil extracts and plant materials, *Plant Soil*, 45, 273–277.
- Bremner JM and Mulvaney CS (1982) Nitrogen total. In *Methods of soil analysis- part 2. Chemical and microbiological properties*. ASA-SSSA, 9, 595–624.
- Buurmans P, van Lager B and Velthorst FJ (1996) *Manual for soil and water analysis.*, Backhuis Publishers, Leiden, 17–21.
- Cremers DA, Ferris MJ and Davies (1996) Transportable Induced Laser Breakdown Spectroscopy (LIBS) instrument for field-based soil analysis. *Proc. Soc. Photo Opt. Inst. Eng.*, 2835, 190–200.
- Cremers DA, Ebinger MH, Breashears DD, Uukefer PJ, Kammerdiener SA, Ferris MJ, Catlett KM and Brown JR (2001) Measuring Total Soil Carbon with Laser-Induced Breakdown Spectroscopy (LIBS). *J. Env. Qual.*, 30, 2202–2206.
- Dalal RC and Henry RJ (1986) Simultaneous determination of moisture, organic carbon and total nitrogen by near infrared reflectance spectrometry. *Soil Sci. Soc. Am. J.*, 50, 120–123.
- Du Preez DR and Bate GC (1989) A simple method for the quantitative recovery of nitrate N during Kjeldahl analysis of dry soil and plant samples. *Commun. Soil Sci. Plant Anal.*, 20, 345–357.
- Fidêncio PH, Poppi RJ and de Andrade JC (2002) Determination of Organic Matter in Soils using function networks and near infrared spectroscopy. *Anal. Chim. Acta.*, 453, 125–134.
- Fuson RC (1962) Reactions of organic compounds - A text book for the advanced student. Wiley, Bristol 1962.

- Gautheyrou J and Gautheyrou M (1965) Dosage simultané de l'azote ammoniacal et nitrique dans le sols. Contribution à l'étude de la dynamique de l'azote. *Cah. Orstom Sér.Pédol.*, III, 367–391.
- Keerthisinghe GK, Mengel K and De Datta SK (1984) The release of non-exchangeable ammonium (<sup>15</sup>N Labelled ) in wetland rice soils. *Soil Sci. Soc. Am. J.*, 48, 291–294.
- Kjeldahl J (1883) Neue methode zur bestimmung des stickstoffs in organischen körpern. *Z. Anal. Chem.*, 22, 366–382.
- Krishnan P, Alexander JD, Butler BJ and Hummel JW (1980) Reflectance techniques for predicting soil organic matter. *Soil Sci. Soc. Am. J.*, 44, 1282–1285.
- Laurent JY (1990) Analyse élémentaire d'échantillons de sol et solutions: application de la microanalyse au dosage simultané de l'azote, du carbone et du soufre. In *Actes Journées laboratoire*, Orstom, Bondy, France.
- Ma TS and Zuazaga G (1942) Micro - Kjeldahl determination of nitrogen. A new indicator and an improved rapid method. *Ind. Eng. Chem. Anal.*, 14, 280–282.
- Markham R (1942) A steam distillation apparatus suitable for micro - Kjeldahl analysis. *Biochem. J.*, 36, 790–791.
- Mebius LJ (1960) A rapid method for the determination of organic carbon in soil. *Anal. Chem. Acta.*, 22, 120–124.
- Mengel K and Scherer HW (1981) Release of non exchangeable (fixed ) soil ammonium under field condition during the growing season. *Soil Sci.*, 131, 226–232.
- Morra MJ, Hall MH and Free Born LL (1991) Carbon and nitrogen analysis of soil fraction using near infrared reflectance spectroscopy. *Soil. Sci. Soc. Am. J.*, 55, 281–291.
- NF X31-109 (1993) Détermination du carbone organique par oxydation sulfochromique. In *Qualité des sols*, 1996, AFNOR, Paris, 67–73.
- NF ISO 10694 (1995) Dosage du carbone organique et du carbone total après combustion sèche (analyse élémentaire). In *Qualité des sols*, 1996, AFNOR, Paris, 189–199.
- NF ISO 11261 (1995) Dosage de l'azote total - Méthode de Kjeldahl modifiée. In *Qualité des sols*, 1996, AFNOR, Paris, 257–260.
- X 31-111 (1983) Détermination de l'azote total - Méthode par distillation après minéralisation ( Kjeldahl ). In *Qualité des sols*, 1994, AFNOR, Paris, 69–72.
- Pansu M, Sallih Z and Bottner P (1998) A process-based model for carbon and nitrogen transfers in soil organic matter. In *Actes 16e congrès mondial de science du sol*, 20–26 april, Montpellier, France
- Pansu M, Gautheyrou J and Loyer JY (2001) Soil Analysis - Sampling, Instrumentation and Quality control. Balkema, Lisse, Abington, Exton, Tokyo, 489.
- Parnas JK and Wagner R (1921) Über dieausführung von bestmungen kleiner stickstoffmengen nach Kjeldahl. *Biochem. Z.*, 125, 253–256.

- Schollenberger CJ (1927) A rapid approximate method for determining soil organic matter. *Soil Sci.*, 24, 65–68.
- Walkley A and Black A (1934) An examination of the Degtjareff method for determining soil organic matter and a proposed modification of the chromic acid titration method. *Soil Sci.*, 37, 29–38.
- Winkler LW (1913) Beitrag zur titrimetrischen bestimmung des ammoniaks. *Z Angew. Chem.*, 26, 231–232.

## Bibliography

- Allison LE, Bollen WB and Moodie CD (1965) Total carbon. In Black C. A. et al. Method of soil analysis part 2. Agronomy Monograph n°9. *Am. Soc. Agron.*, 1346–1366.
- Alves BJR, Boddey RM and Urquiaga SS (1993) A rapid and sensitive flow injection technique for the analysis of ammonium in soil extracts. *Commun. Soil Sci. Plant Anal.*, 24, 277–284.
- Association of Official Analytical Chemists. AOAC (1975) *Official methods of analysis*, 924–925.
- Bernoux M and Cerri CEP (2005) Soil organic components. In *Encyclopedia of Analytical Science*, 2nd Edition, Vol. 4, Elsevier, Amsterdam.
- Bowman RA, Guenzin WD and Savory DJ (1991) Spectroscopic method for estimation of soil organic carbon. *Soil Sci. Soc. Am. J.*, 55, 563–566.
- Bremner JM and Tabatabai M.A (1972) Use of an ammonia electrode for determination of ammonium in Kjeldahl analysis of soils. *Commun. Soil Sci. Plant Anal.*, 3, 159–165.
- Burton DL, Gower DA, Rutherford PM and McGill WB (1989) Amino acid interference with ammonium determination in soil extracts using the automated indophenol method. *Commun. In Soil Sci. Plant Anal.*, 20, 555–565.
- Carr CE (1973) Gravimetric determination of soil carbon using the Leco induction furnace. *J. Sci. Food Agric.*, 24, 1091–1095.
- Cheng HH and Kimble J (2000) Methods of Analysis for Soil Carbon: An Overview. In *Global Climate Change and Tropical Ecosystems.*, CRC, Boca Raton, 333–339.
- Chichester FW and Chaison RF (1992) Analysis of carbon in calcareous soil using a two temperature dry combustion infra-red instrumental procedure. *Soil Sci.*, 153, 237–241.
- De Bolt DC (1974) A high sample volume procedure for the colorimetric determination of soil organic matter. *Commun. Soil Sci. Plant Anal.*, 5, 131–137.
- Decreider and Meaux R (1973) Utilisation d'une electrode ionique spécifique pour le dosage de l'azote par la méthode Kjeldahl. *Analisis*, 2, 442–445.
- Diaz-Zorita M (1999) Soil organic carbon recovery by the Walkley-Black method in a typic Hapludoll. *Commun. Soil Sci. Plant Anal.*, 30, 739–745.

- Donkin MJ (1991) Loss - on - ignition as an estimator of soil organic carbon in A horizon forestry soils. *Commun. Soil Sci. Plant Anal.*, 22, 233–241.
- Froelich PN (1980) Analysis of organic carbon in marine sediments. *Limnol. Oceanogr.*, 25, 564–572.
- Gallaher RN, Weldon CO and Howell FC (1976) A semi-automated procedure for total nitrogen in plant and soil samplers. *Soil. Sci. Soc. Am. J.*, 40, 887–889.
- Genty CE and Willis RB (1988) Improved method for automated determination of ammonium in soil extracts. *Commun. In Soil Sci. Plant Anal.*, 19, 721–737.
- Graham ER (1948) Determination of soil organic matter by means of a photoelectric colorimeter. *Soil Sci.*, 65, 181–183.
- Guillet B (1979) Etude du renouvellement des matières organiques des sols par les radio isotopes  $^{14}\text{C}$ . In *Pedologie - constituants et propriétés du sol*, Bonneau M and Souchier B ed. Masson, Paris, 210–226.
- Heanes DL (1984) Determination of total organic C in soils by an improved chromic acid digestion and spectrophotometric procedure. *Commun. Soil Sci. Plant Anal.*, 15, 1191–1213.
- Henzell EF, Wallis I and Lindquist JE (1968) Automatic colorimetric methods for the determination of nitrogen in digests and extracts of soils. *Int. Cong. Soil Sci. Trans.*, 9<sup>th</sup>(Adelaide), 3, 513–520.
- Howard PJ A and Howard DM (1990) Use of organic carbon and loss on ignition to estimate soil organic matter in different soil types and horizons. *Biol. Fert. Soils.*, 9, 306–310.
- Kalembasa SI and Jenkinson DS (1973) A comparative study of titrimetric and gravimetric methods for determination of organic carbon in soils. *J. Sci. Food Agric.*, 24, 1085–1090.
- Kalisz PJ and Sainju UM (1991) Determination of carbon in coal “ blooms ”. *Commun. Soil Sci. Plant Anal.*, 22, 393–398.
- Kempers AJ and Kok CJ (1989) Re-examination of the determination of ammonium as the indophenol blue complex using salicylate. *Anal. Chim. Acta.*, 221, 147–155.
- Lal R, Kimble JM, Follet RF and Stewart BA, (2001) *Assessment Methods for Soil Carbon*, Lewis CRC, London/Boca Raton, 676.
- Lowther JR, Smethurst PJ, Carlyle JC and Nambiar EKS (1990) Methods for determining organic carbon in podzolic sands. *Commun. Soil Sci. Plant Anal.*, 21, 457–470.
- Mc Geehan SL and Naylor DV (1988) Automated instrumental analysis of carbon and nitrogen in plant and soil samples. *Commun. Soil Sci. Plant Anal.*, 19, 493–505.
- Merry RH and Spouncer LR (1988) The measurement of carbon in soils using a micro processor - controlled resistance furnace. *Commun. Soil Sci. Plant Anal.*, 19, 707–720.
- Nelson DW and Sommers LE (1975) A rapid and accurate procedure for estimation of organic carbon in soil. *Proc. Indiana Acad. Sci.*, 84, 456–462.

- Nelson DW and Sommers LE (1982) Total carbon, organic carbon and organic matter. In *Methods of soil analysis part 2*. Page AL, Miller RH and Keeney DR ed. *Agron. Monogr.*, 9, ASA - SSSA Madison., 539–579.
- Nelson DW and Sommers LE (1996) Total carbon, organic carbon and organic matter. In *Methods of soil analysis, part 3, chemical methods*, Sparks DL ed. SSSA Book series no 5, 961–1010.
- Nelson DW (1983) Determination of ammonium in KCl extracts of soils by the salicylate method. *Commun. Soil Sci. Plant Anal.*, 14, 1051–1062.
- Nommik H (1971) A modified procedure for determination of organic carbon in soils by wet combustion. *Soil Sci.*, 111, 330–336.
- Patton JC and Crouch SR (1977) Spectrophotometric and kinetics investigation of the Berthelot reaction for the determination of ammonia. *Anal. Chem.*, 3, 464–469.
- Pella E (1990) *Elemental organic analysis*. Part 1, historical development, 116–125; part 2, state of the art, 28–32, *Ann. Lab.*
- Perrier ER and Kellog M (1960) Colorimetric determination of soil organic matter. *Soil Sci.*, 90, 104–106.
- Puttanna K and Prakasa Rao EVS (1993) Determination of nitrate in soil by second derivative ultraviolet spectrometry. *Commun. Soil Sci. Plant Anal.*, 24, 737–743.
- Qiu Xing-Chu and Zhu Ying-Quan (1987) Sensitive spectrophotometric determination of ammoniacal nitrogen analysis. *Analisis*, 15, 254–258.
- Quinn JG and Salomon M (1964) Chloride interference in the dichromate oxidation of soil hydrolyzates. *Soil Sci. Soc. Am. Proc.*, 28, 456.
- Rowland AP (1983) An automated method for the determination of ammonium-N in ecological materials. *Commun. Soil Sci. Plant Anal.*, 14, 49–63.
- Schepers JS, Francis DD and Thompson MT (1989) Simultaneous determination of total C, total N, and <sup>15</sup>N in soil and plant material. *Commun. Soil Sci. Plant Anal.*, 20, 949–959.
- Schulte EE, Kaufman C and Peter JB (1991) The influence of sample size and heating time on soil weight loss - on - ignition. *Commun. Soil Sci. Plant Anal.*, 22, 159–168.
- Schuman GE, Stanley MA and Knudsen D (1973) Automated total nitrogen analysis of soil and plant samples. *Soil Sci. Soc. Am. Proc.*, 37, 480–481.
- Sheldrick BH (1986) Test of the Leco CHN 600 determination for soil carbon and nitrogen analysis. *Canadian J. of Soil Sci.*, 66, 543–545.
- Sims JJ and Haby VA (1971) Simplified colorimetric determination of soil organic matter *Soil Sci.*, 112, 137–141.
- Skjemstad JO, Reeve R (1976) The determination of nitrogen in soils by rapid high temperature Kjeldahl digestion and auto analysis. *Commun. Soil. Sci. Plant Anal.*, 7, 229–239.
- Soon YK and Aboud S (1991) A comparison of some methods for soil organic carbon determination. *Commun. Soil Sci. Plant Anal.*, 22, 943–954.
- Stewart RA and Porter LK (1963) Inability of Kjeldahl methods to fully measure indogeneous fixed ammonium in some soil. *Soil Sci. Soc. Am. Proc.*, 27, 41–43.

- Szekely E (1991) A rapid colorimetric method for analysis of nitrate nitrogen by reduction to nitrite. *Commun. Soil Sci. Plant Anal.*, 22, 1295–1302.
- Tabatabai MA and Bremner JM (1991) Automated instruments for determination of total carbon, nitrogen and sulphur in soils by combustion techniques. In *Soil analysis - Modern instrumental techniques*, Smith KA ed. Marcel Dekker, NY, USA 261–286.
- Takesako H (1991) Double-plunger pump system flow injection spectrophotometric determination of inorganic nitrogen in soil extracts, part 1, flow injection analysis of ammonium nitrogen in soil extracts, part 2, flow injection analysis of nitrate nitrogen in soil extracts, *Jpn J Soil Sci. Plant Nut.*, 62, 128–134, 135–140
- Tel DA and Jansen J (1992) Determination of total nitrogen in soil digest using a Traacs 800 Autoanalyser. *Commun. Soil Sci. Plant Anal.*, 23, 2729–2736.
- Tisley J (1950) Determination of organic carbon in soils by dichromate mixtures in *Trans. 4<sup>th</sup> Int. Cong. Soil. Sci.*, 1, 161–169. Hoitsema Brothers, Groningen.
- Verardo DJ, Froelich PN and McIntyre A (1990) Determination of organic carbon and nitrogen in marine sediments using the Carlo Erba Na. 1500 analyser. *Deep Sea Res.*, 37, 157–165.
- Volonteri HJ (1983) Modificación de un método colorimétrico para la determinación del nitrógeno total en suelos y pastos. *Ciencia del suelo*, 1, 98–99.
- Walinga J, Kithome M, Novozamsky I, Houba VJG and Vanderlee JJ (1992) Spectrometric determination of organic carbon in soils. *Commun. Soil Sci. Plant Anal.*, 23, 1935–1944.
- Winter JP, Gregorich EG, Voroney RP and Kachanoski RG (1990) Comparison of two samples oxidation methods for quantitative measurement of <sup>12</sup>C and <sup>14</sup>C in plant and soil. *Canad. J. Soil Sci.*, 70, 525–529.
- Yeumans JC and Bremner JM (1991) Carbon and nitrogen analysis of soils by automated combustion techniques. *Commun. Soil Sci. Plant Anal.*, 22, 843–850.

## Quantification of Humic Compounds

### 11.1 Humus in Soils

#### 11.1.1 Definition

Humus plays a fundamental role in ecological processes as a source of carbon for the atmosphere, a sink of carbon for the biosphere, a sink and source of fertilizers for plants, and a factor that influences soil properties, and important reviews are regularly devoted to it (Kononova 1966; Flaig et al. 1975; Schnitzer 1978; Stevenson 1982; 1994; Aiken et al. 1985; Tate 1992; Carter and Stewart 1995; Piccolo 1996; Magdoff et al. 1996; Hessen and Tranvik 1998).

Stevenson (1982) defined the term “humus” (or humified matter) as the sum of organic compounds in the soil with the exclusion of living organisms in the biomass and non-decomposed or partially decomposed organic debris of plant or animal origin (cf. Chap. 9). The use of the term “soil organic matter” is less clear: the term is sometimes used with the same meaning as humus but in fact should refer to the sum of soil organic materials.

Humified matter represents more than half soil total organic carbon and can be classified in two main types, humic and non-humic substances (Schnitzer 1978). The physical and chemical characteristics of non-humic substances e.g. carbohydrates, proteins, peptides, amino acids, lipids, waxes and organic acids of low molecular weight are easily recognizable.

Humic substances on the other hand, do not show such marked physicochemical characteristics. They are more or less dark in colour, their molecular weight varies from a few hundred to several hundred thousand daltons, and they display a complex chemical structure, a hydrophilic character and acid properties.

However, the distinction between the two types of substances is not completely clear since humic substances always contain non-humic substances, which can be released by chemical treatments like acid hydrolysis.

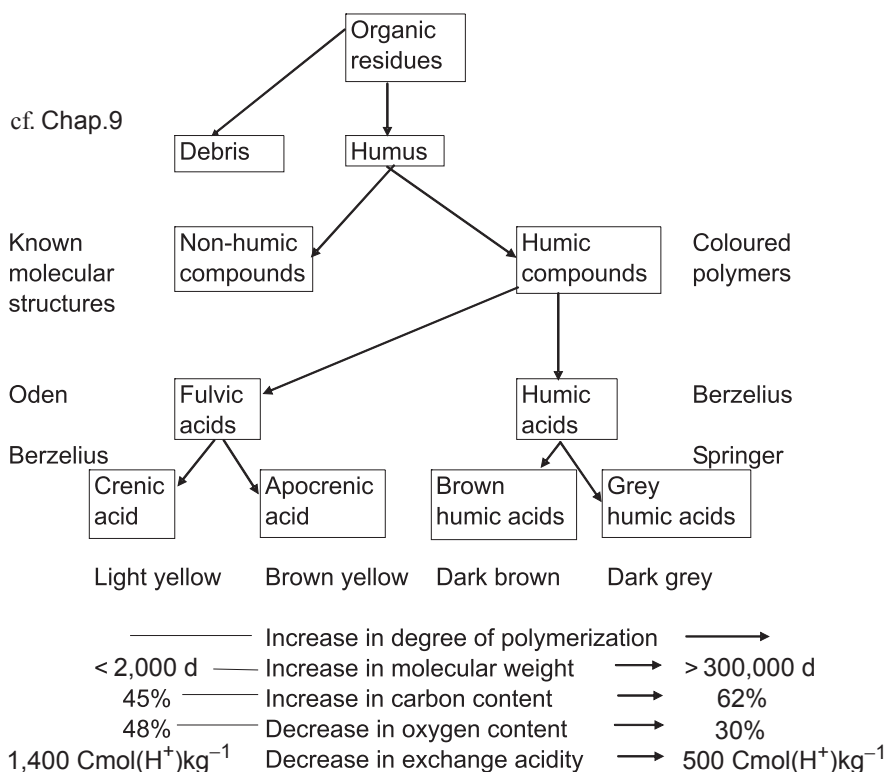

**Fig. 11.1.** Classification and chemical properties of groups of humic substances (after Stevenson and Elliott 1989)

Humic substances are generally classified into three main groups according to their solubility:

- Humic acids are soluble in diluted bases and insoluble in acid medium; they result from precipitation by acidification of the alkaline extracts of soil.
- Fulvic acids are soluble in both alkaline and acid mediums, the compounds remain in solution after precipitation of humic acids by acidification of the alkaline extracts of soil.
- Humin is the humus fraction that cannot be extracted by acids or diluted bases.



Other names have been given to certain humic substances as a function of their solubility in a range of different solvents. The best known characterize humatomelanic acids as the fraction of humic acids which are soluble in ethanol. Among fulvic acids, an obsolete distinction is sometimes used to differentiate crenic and apocrenic acids. Some authors, for example Chamayou and Legros (1989), advise against the use of either term. Brown and grey humic acids can be distinguished. These two groups were first identified by Springer (1938) based on their flocculation or dissolution properties in a medium including different degrees of salts. Figure 11.1 shows some of the properties of these compounds.

### 11.1.2 Role in the Soil and Environment

Humic compounds account for 60–70% of soil carbon, which itself represents the biggest reservoir of organic carbon on the earth's surface. Humic compounds play a significant role as an atmospheric source of CO<sub>2</sub> and as a carbon reservoir which is likely to react to the influence of different external factors (Schnitzer 1978).

Stevenson (1982) quoted nine properties of humus with respect to their effect on the soil:

- Its dark colour, which facilitates absorption of solar radiation and consequently warms the soil.
- Its water-retention capacity; organic matter can hold up to 20 times its own weight in water, thereby significantly improving the hydrous properties of some soils and particularly of sandy soils.
- Its ability to combine with clay minerals resulting in the cementing of soil particles into structural units called aggregates thereby facilitating gaseous exchange and increasing permeability.
- Chelation which forms stable complexes with many polyvalent cations and influences the availability of nutrients for plants.
- Its solubility in water which is very reduced and the bonds with clays and certain polyvalent cations which minimize organic losses by leaching.
- Its buffer effect, this effect appears at slightly acid, neutral and alkaline pH.
- Its cation exchange capacity, 20–70% of the cation exchange capacity of many soils is due to the presence of organic matter.
- Its mineralization which releases CO<sub>2</sub>, NH<sub>4</sub><sup>+</sup>, NO<sub>3</sub><sup>-</sup>, PO<sub>4</sub><sup>3-</sup>, SO<sub>4</sub><sup>2-</sup> and represents a very significant source of nutrients for plant growth.
- Its combination with other organic molecules which affects bioactivity, persistence and biodegradability of pesticides.

This chapter provides details of procedures for the main types of extraction and quantification of soil humic matter. The reference section at the end of the chapter lists a wider range of methods for use in this context.

Extraction methods are described for whole soil samples prepared using standard techniques. However, it is often better to apply these methods to selected fractions after physical fractionation of the organic matter (cf. Chap. 9), in particular for the finest fractions.

### 11.1.3 Extraction

Organic materials bond with polyvalent cations, hydroxides and clays to form organomineral complexes. The stability of these complexes varies considerably depending on the type of bond.

Organic materials can be released by extractions that break down at least some of the organomineral bonds. Bruckert (1979) distinguished three types of extraction solutions:

- Salt solutions can break electrostatic bonds by simple exchange of ions and help solubilize the organic molecules by ionizing the acid and phenolic functional groups; Bruckert proposed a sodium tetraborate solution at pH 9.7; the extracted organomineral substances of relatively weak molecular weight were referred to as mobile or easily available recently formed complexes (Duchaufour 1977); they are characterized by relatively low metal contents; tetraborate has no effect on calcium complexes.
- Complex-forming solutions able to break the coordination bonds; the best known is sodium pyrophosphate solution which is generally used at pH 9.8; it breaks the bonds of complexes with metal sites on clays; it can also solubilize complexes with high metal contents (amorphous hydroxides), and dissolve calcium humates by forming a complex with calcium, but is as ineffective as tetraborate on allophanic complexes; all the extracted complexes are known as immovable.
- Soda at pH 12 is in fact the most effective extractant as it is able to destroy most organomineral bonds and particularly those of the humic allophone–acid complexes of andosols.

The standard techniques described in Sect. 11.2.1 concern:

- Simple extraction using an alkaline solution, with or without a preceding acid attack.
- Double extraction using a pyrophosphate solution followed by a soda solution (this method is used in the IRD laboratories, France).

Section 11.2 evaluates the respective utility and precision of these methods and describes the main methods for the purification of extracted organic materials.

Some alternatives to these extraction methods, including a technique for fractionation of the humin centrifugation pellet, are presented in Sect. 11.3. Techniques for the fractionation and characterization of humic compounds are described in Chap. 12.

## 11.2. Main Techniques

### 11.2.1 Extraction

#### *Principle*

As mentioned in Sect. 11.1.3, diluted soda solutions are the most powerful extracting reagents for humified matter. However, the use of these extraction solutions has been criticized for three main reasons (Bruckert 1979):

- Neo-formation of soluble substances from non-humified plant materials.
- Breakdown of humic substances by hydrolysis, oxidation or artificial polymerization.
- *Lysis of microbial organisms*. Sodium hydroxide can destroy bacteria and empty them of their cytoplasmic contents, their cell walls then form a non-extractable residue.

However, Schnitzer (1982) did not consider that extraction using diluted bases in a nitrogen atmosphere and at room temperature significantly modified the structure and characteristics of the extracted organic matter. Lévesque and Schnitzer (1966) showed that 0.1 mol L<sup>-1</sup> soda solutions extract more organic matter than concentrated solutions. They also showed that 0.5 mol L<sup>-1</sup> soda solutions extract organic matter with lower ash content.

“Method Schnitzer (1982)” and “Method IHSS” were chosen to maximize extraction of humic compounds and to minimize their degradation. Extraction (one extraction only) is carried out (1) under nitrogen atmosphere, with a 0.1 mol (NaOH) L<sup>-1</sup> soda solution described in “Method IHSS” (2) with the same reagent or 0.5 mol (NaOH) L<sup>-1</sup> soda solution or pyrophosphate solution described in “Method Schnitzer (1982)”. “Method of Dabin (1976)” separates two types of extracted

compounds: organic materials extractable with a pyrophosphate solution at pH 9.8 and organic materials extractable later on with a 0.1 mol (NaOH) L<sup>-1</sup> soda solution. Nègre et al. (1976) observed qualitative differences between the two extracts particularly in amino acid content; Thomann (1963) observed that pyrophosphate dissolves calcic humates by forming complexes with metal cations; an increase in pH acts more particularly on aggregate dispersion, and pH 9.8 corresponds to a stable stage in the curve of humus extraction as a function of pH.

An alternative approach is acid pretreatment of the soil; this type of pretreatment facilitates the later extraction of humified matter by destroying carbonates and by solubilizing iron and aluminium hydroxides; however, the quantitative effect of the pretreatment is especially visible in calcareous soils. "Method IHSS" recommends systematic acid pretreatment with 1 mol (HCl) L<sup>-1</sup> hydrochloric acid solution. "Method Schnitzer (1982)" recommends pretreatment with 0.05 mol (H<sup>+</sup>) L<sup>-1</sup> hydrochloric or sulphuric acid solution only in the case of calcareous soils. "Method of Dabin (1976)" recommends systematic pretreatment with 2 mol L<sup>-1</sup> phosphoric acid. This acid has two advantages (1) higher density (approximately 1.2) which is more favourable for the separation of light organic fragments (cf. Chap. 9), (2) it does not disturb wet carbon titration and thus enables quantification of the organic matter extracted by the acid itself (unbound fulvic acid).

### **Equipment**

- Glass, polypropylene or polyvinyl extraction and centrifugation flasks (volume: 200 mL, and 300–500 mL) with screw caps, for use as centrifugation cylinders, capable of withstanding 10,000g.
- Centrifuge (10,000g) equipped with rotor suitable for use with the centrifugation flasks.

### **Products**

- *Degassed inorganic water.* Most commercial water is appropriate. It should first be checked for the absence of organic matter (blank assay corresponding to the type of characterization required). However, to eliminate organic matter from water, either (1) boil water for 2 h in the presence of 1% KMnO<sub>4</sub> and H<sub>2</sub>SO<sub>4</sub> then distil or (2) use deionized water purified on activated carbon (e.g. Millipore filter), then degas the water to eliminate dissolved oxygen in order to avoid oxidation of organic matter during extraction. Proceed either by boiling or by bubbling with nitrogen for 10 min.

- 0.1 mol (NaOH) L<sup>-1</sup> solution. Dissolve 8 g of soda pellets in a 2 L volumetric flask in degassed inorganic water, complete to 2 L, agitate and store in a carefully stopped bottle.
- 0.5 mol (NaOH) L<sup>-1</sup> solution. Same as above with 40 g soda for 2 L.
- 10 mol (NaOH) L<sup>-1</sup>. Same as above with 400 g soda for 1 L.
- 0.1 mol (Na<sub>4</sub>P<sub>2</sub>O<sub>7</sub>) L<sup>-1</sup> solution. Dissolve 89.2 g of Na<sub>4</sub>P<sub>2</sub>O<sub>7</sub>·10H<sub>2</sub>O in degassed inorganic water, complete to 2 L and store in a carefully stopped bottle.
- 0.1 mol (Na<sub>4</sub>P<sub>2</sub>O<sub>7</sub>·NaOH) L<sup>-1</sup> solution. Dissolve 89.2 g of Na<sub>4</sub>P<sub>2</sub>O<sub>7</sub>·10H<sub>2</sub>O and 8 g of soda pellets in degassed inorganic water, complete to 2 L and store in a carefully stopped bottle.
- 2 mol (HCl) L<sup>-1</sup> solution. Dilute 166.7 mL of concentrated HCl (*d*=1.19) in degassed inorganic water; complete to 1 L.
- 6 mol (HCl) L<sup>-1</sup> solution. Dilute 500 mL of concentrated hydrochloric acid in 1 L degassed inorganic water.
- 1 mol (HCl) L<sup>-1</sup> solution. Dilute 166.7 mL HCl in 2 L degassed inorganic water.
- 0.5 mol (HCl) L<sup>-1</sup> solution. Dilute 83.3 mL HCl in 2 L degassed inorganic water.
- 0.05 mol (1/2H<sub>2</sub>SO<sub>4</sub>) L<sup>-1</sup> solution. Dilute 27.8 mL of concentrated H<sub>2</sub>SO<sub>4</sub> (*d*=1.81) in degassed inorganic water; cool and complete to 2 L.
- 2 mol (H<sub>3</sub>PO<sub>4</sub>) L<sup>-1</sup> solution. Dilute 136 mL of concentrated phosphoric acid (*d*=1.71) in degassed inorganic water and complete to 1 L.

## Procedures

### Method Schnitzer (1982)

If the soil contains carbonates (reaction to diluted hydrochloric acid), leave it in contact with a 0.05 mol (H<sup>+</sup>) L<sup>-1</sup> hydrochloric or sulphuric acid solution at room temperature until the end of gaseous emission. Rinse the excess acid with inorganic water and leave the soil to dry on a plate at room temperature.

Weigh 10 g of air-dried soil in a 200 mL polypropylene flask. Add 100 mL of selected extraction solution (0.1 or 0.5 mol (NaOH) L<sup>-1</sup>, 0.1 mol (Na<sub>4</sub>P<sub>2</sub>O<sub>7</sub>) L<sup>-1</sup> or mix 0.1 mol (Na<sub>4</sub>P<sub>2</sub>O<sub>7</sub>·NaOH) L<sup>-1</sup>. Purge the air out of the flask with a stream of nitrogen. Close carefully and agitate for 24 h at room temperature. Separate the dark supernatant solution from the solid phase by centrifugation (preferably for 10 min at 10,000g), suspend the residue in 50 mL degassed inorganic water, separate by centrifugation again and add the flushing water to the previous solution.

Acidify the alkaline extract to pH 2 with 2 mol (HCl) L<sup>-1</sup> hydrochloric acid. Leave to stand for 24 h at room temperature then separate the soluble matter (fulvic acid) from the coagulated matter (humic acid) by centrifugation. The two fractions can be brought to dry by freeze-drying or by evaporation in a rotary evaporator at 40°C.

#### *Method IHSS<sup>1</sup>*

Mix 20 g of air-dried soil with 1 mol (HCl) L<sup>-1</sup> hydrochloric acid. Adjust to a pH of between 1 and 2 (15–20 mL soda 10 mol L<sup>-1</sup>) in such a way that the final volume of liquid is 200 mL (liquid/soil ratio = 10 mL per 1 g). Agitate for 1 h and separate the supernatant liquid by centrifugation.

Neutralize the centrifugation pellet to pH 7 with 1 mol (NaOH) L<sup>-1</sup> soda solution and add 0.1 mol (NaOH) L<sup>-1</sup> solution under nitrogen atmosphere until a solution:soil ratio of 10:1 is obtained.

Agitate for at least 4 h under nitrogen atmosphere. Leave to stand overnight and centrifuge.

Acidify the centrifugation liquid to pH 1 with 6 mol (HCl) L<sup>-1</sup> hydrochloric acid under agitation. Leave to stand for 12–16 h and centrifuge to separate the fulvic acids in solution from the coagulated humic acids.

#### *Method of Dabin (1976)*

Put 40 g of air-dried soil crushed and sieved on a 0.5 mm mesh sieve in a 300–500 mL centrifugation bottle. Add 200 mL of 2 mol (H<sub>3</sub>PO<sub>4</sub>) L<sup>-1</sup> solution, agitate for 30 min with the back and forth shaker and centrifuge for 5 min at 1,500g. Filter the supernatant liquid on a flat filter in a 1 L glass bottle. Repeat the extraction two or three times in the same centrifugation bottle, filtering on the same filter and collecting the acid extracts in the same bottle. The filter contains light organic matter (LOM) from non-humified plant and animal residues (cf. Chap. 9); the acid solution contains a small fraction of organic materials called “free fulvic acids” (FFA) by Dabin (1976). Wash the centrifugation pellet two or three times with 200 mL inorganic water in the same bottle by agitating for 15 min; centrifuge and filter the washing water on the previously used filter to collect the light material still present in the washing water, discard the filtrate.

<sup>1</sup> IHSS = International Humic Substance Society, Univ. of California, Los Angeles, CA 90024; Federal Center, mall stop 407, Box 25046, Denver, CO 80225.

Add 200 mL of 0.1 mol (Na<sub>4</sub>P<sub>2</sub>O<sub>7</sub>) L<sup>-1</sup> solution at pH 9.8. Agitate for 4 h on the back and forth shaker or leave in contact overnight agitating several times. Separate the supernatant liquid by centrifugation for 30 min at 3,000g and transfer it through a filter into a 1 L volumetric flask. Perform a second extraction in the same conditions and combine the extracts. If the second extract is dark in colour, perform a third extraction.

Repeat a similar extraction sequence on the centrifugation pellet, with 0.1 mol (NaOH) L<sup>-1</sup> soda solution instead of the pH 9.8 pyrophosphate solution.

Humic acids of the pyrophosphate and soda extracts are separated from fulvic acid by acidification at pH 1 with the 2 mol (HCl) L<sup>-1</sup> solution as described in "Method Schnitzer (1982)". Ultimately, the following fractions are obtained: LOM, FFA, pyrophosphate fulvic acids (PFA), pyrophosphate humic acids (PHA), soda fulvic acids (SFA), soda humic acids (SHA), extraction residue or humin.

#### **Note**

In certain soils, the pyrophosphate and soda extracts can contain a high percentage of fine mineralogical clays (smaller than 0.2 μm). It is possible to separate these clays by flocculation with the addition of a little potassium sulphate, but there is a risk of simultaneously flocculating certain grey humic acids (cf. Sect. 11.2.4 and Chap. 12). After centrifugation, the flocculation pellet should either be titrated individually or combined with the previous humin pellet for carbon determination.

### **11.2.2 Quantification of the Extracts**

#### **Principle**

Quantification is by carbon titration of each extract (cf. Sect. 11.2.1 above). The techniques used for carbon titration of whole soil can be used on the humin pellet (cf. Chap. 10). For LOM, it is preferable to use a combustion technique. The extracts can also be titrated by combustion on the residue after dry evaporation of an aliquot. Nitrogen can be measured in addition to carbon, hydrogen and possibly sulphur and oxygen by using an analyser of the CHN type. However, wet processes such as dichromate oxidation (described later) are often preferred for

titration of the extracts. Another technique calls for a titration apparatus with dissolved carbon. Many of these apparatus are based on titration of the carbon dioxide (generally by infra-red absorption) produced by oxidation of the solution with a powerful oxidant. The titration apparatus of dissolved carbon are rather expensive and reserved to precise environmental studies; the manufacturer's instructions should be respected.

In acid medium, dichromate oxidizes the carbon of the organic matter in  $\text{CO}_2$  according to the redox reaction:

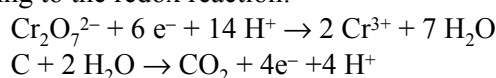

With automated apparatuses, the quantity of  $\text{CO}_2$  released can be measured directly. With a traditional manual redox technique a dichromate excess is used, which is then back titrated by a ferrous iron solution:

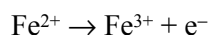

A mole of ferrous iron corresponds to  $1/6$  mol of  $\text{K}_2\text{Cr}_2\text{O}_7$  is  $1/4$  atom C or 3 g of carbon.

### Equipment

- 50 and 100 mL Pyrex Beakers.
- Precision burette (25 or 50 mL).
- If necessary, a titration apparatus using carbon and dry combustion, but preferably a wet process.

### Reagents

- 0.1 mol ( $\text{Na}_4\text{P}_2\text{O}_7$ )  $\text{L}^{-1}$  and 0.1 mol (NaOH)  $\text{L}^{-1}$  solutions: see preparation in "Products" under Sect. 11.2.1.
- Concentrated sulphuric acid ( $d=1.81$ ).
- 2 mol ( $1/2\text{H}_2\text{SO}_4$ )  $\text{L}^{-1}$  sulphuric acid: dissolve 56 mL of concentrated sulphuric acid ( $d=1.81$ ) in 1 L inorganic water.
- 0.1 mol ( $1/2\text{H}_2\text{SO}_4$ )  $\text{L}^{-1}$  sulphuric acid: 2.8 mL of concentrated sulphuric acid ( $d=1.81$ ) in 1 L inorganic water.
- 2% potassium dichromate solution: dissolve 20g of  $\text{K}_2\text{Cr}_2\text{O}_7$  in approximately 400 mL inorganic water, slowly add 500 mL of concentrated sulphuric acid, agitate, let cool and complete to 1 L with inorganic water.
- 0.5 mol ( $1/6\text{K}_2\text{Cr}_2\text{O}_7$ )  $\text{L}^{-1}$  solution: gradually dissolve 24.52 g of potassium dichromate in inorganic water then complete to 1 L (solution for the titration of the Mohr salt).



- 0.2 mol (FeSO<sub>4</sub>) L<sup>-1</sup> Mohr salt solution: dissolve 78.4 g of Mohr salt (FeSO<sub>4</sub>(NH<sub>4</sub>)<sub>2</sub>SO<sub>4</sub>·6H<sub>2</sub>O) in 500 mL water, add 20 mL of concentrated sulphuric acid, complete to 1 L.
- Sodium fluoride in powder form.
- Sulphuric diphenylamine solution: dissolve 0.5 g of diphenylamine powder in 100 mL of concentrated H<sub>2</sub>SO<sub>4</sub>, pour into 20 mL water, agitate and store in a brown bottle.

### Procedure

#### Test samples

*Total organic materials of the soda and pyrophosphate extracts.* In a 100–200 mL shallow beaker, put the exact volume of the extraction solution corresponding to 5–8 mg C. Calculate the volume of the aliquot on the basis of the total C analysis of the sample (cf. Chap. 10). The carbon of the total alkaline extracts is around 40% of total C; C extracted by pyrophosphate is about 25% of total C, and C extracted by soda (after pyrophosphate extraction) is about 15% of total C. Before titration, bring the sample to dry in a drying oven at 70°C.

*Humic acids.* Take a sample of the extraction solution of more than 50% of the titration sample for total organic materials. Precipitate the humic acids at approximately pH 1 by adding 1 mol (H<sub>2</sub>SO<sub>4</sub>) L<sup>-1</sup> (approximately 4–5 mL for 10 mL of total extract, 3 mL for 10 mL of pyrophosphate extract, 1.5 mL for 10 mL of soda extract); leave to flocculate for at least 4 h and centrifuge for at least 5 min at 3,500g; separate the supernatant liquid (fulvic acids) and wash with 0.1 mol (½H<sub>2</sub>SO<sub>4</sub>) L<sup>-1</sup> solution. Dissolve the centrifugation pellet in 0.1 mol (NaOH) L<sup>-1</sup> solution, place in a beaker and bring to dry at 70°C before analysis.

*Phosphoric acid extract.* Take an exact aliquot of 100 mL; concentrate in the drying oven until approximately 10 mL remains (H<sub>3</sub>PO<sub>4</sub> cannot go dry) and carry out titration on this concentrated solution.

*Fulvic acids.* These can be titrated as total organic material after elimination of humic acids but are generally estimated by the difference between total organic materials and humic acids.

#### Redox Titration

After drying the sample specimens in the beakers, add 10 mL of the 2% potassium dichromate solution in sulphuric acid medium. At the same time, carry out a blank measurement with 10 mL of the same dichromate

solution in a beaker. Protect each beaker with a beaker cover and bring to a very gentle boil on a hotplate regulated at 215–220°C; Boil for 5 min but control boiling to avoid overheating or too much evaporation.

Leave to cool, rinse the beaker cover and add in the beaker: 100 mL of inorganic water, 1.5 g of NaF (or 2.5 mL  $\text{H}_3\text{PO}_4$ ) and three drops of diphenylamine solution.

With a burette titrate with Mohr salt solution until the colour turns from purple to pale green.  $V$  and  $V'$  volumes in mL of ferrous solutions are necessary for the respective titration of the blank and of the sample.

If  $T$  is the concentration of the Mohr salt solution in mol ( $\text{FeSO}_4$ )  $\text{L}^{-1}$ , the quantity of  $\text{Fe}^{2+}$  equivalent to oxidant mobilized for the titration of the carbon of the sample is:  $T(V-V')$  mmol( $\text{Fe}^{2+}$ ), which according to the redox equations (cf. "Principle" under Sect. 11.2.2), corresponds to  $3T(V-V')$  mg of carbon in the beaker. With respect to the whole soil sample, the carbon content in mg (C)  $\text{g}^{-1}$  (soil) of the fraction is

$$C = 3T(V-V') V_t / (A m_t) \quad (11.1)$$

where:

$V_t$ : total volume of the humic extract in mL,

$A$ : aliquot of the humic extract used for titration in mL,

$m_t$ : soil sample mass used for the extraction in g,

$T$  has to be determined by titration.

#### *Titration of the Mohr Salt Solution*

Put in a 250 mL beaker:

– exactly 10 mL of the 0.5 mol ( $1/6 \text{K}_2\text{Cr}_2\text{O}_7$ )  $\text{L}^{-1}$  solution

– 100 mL of inorganic water

– 15 mL of concentrated  $\text{H}_2\text{SO}_4$

Let cool and add

– 3.75 g NaF;

– three drops of diphenylamine indicator

Using the burette, titrate with the Mohr salt solution; if  $V_f$  is the volume in mL of the Mohr salt solution, the  $T$  of this solution will be

$T = 5/V_f$  mol ( $\text{Fe}^{2+}$ )  $\text{L}^{-1}$ . The carbon content in (11.1) can thus be expressed in mg (C)  $\text{g}^{-1}$  (soil) by:

$$C = 15 (V-V') V_t / (A m_t V_f) \quad (11.1')$$

### **Remarks**

Ten millilitres of 2% dichromate solution corresponds to 20.4 mL of the 0.2 mol (Fe<sup>2+</sup>) L<sup>-1</sup> Mohr salt solution. The volume of Mohr salt solution used for titration of the sample should be between 7 and 15 mL; below this range, start the analysis again with a weaker sample; above this range start again with a stronger sample.

The quantity of carbon in the phosphoric acid solution is usually low. In this case, oxidize with only 5 mL of 2% dichromate solution adding five drops of concentrated H<sub>2</sub>SO<sub>4</sub> before boiling.

Pyrex beakers are attacked by alkaline solutions and NaF in acid medium. They should be rinsed immediately after titration and reserved solely for this purpose.

## **11.2.3 Precision and Correspondence of the Extraction Methods**

### **Inter-Laboratory Study**

An inter-laboratory study by GEMOS<sup>2</sup> (Dabin et al. 1983) involved the quantitative comparison of the quantities of organic materials extracted on seven samples from soils from different areas of France:

1. A silt soil from the plates of Boigneville
2. A humocalcic soil from Pontarlier
3. A A1 horizon of a podzol from the forest of Villers Cotterets
4. A Bh horizon of the same podzol 3
5. A fersiallitic soil from near Montpellier
6. A gley soil with hydromull from Bonneveaux
7. A rendzina on chalk from Chalons sur Marne

Each soil was analysed by four French laboratories:

- the CIRAD<sup>3</sup> laboratory of Montpellier
- the pedology laboratory of the university of Poitiers
- the IRD<sup>4</sup> laboratory of Bondy
- the pedology laboratory of the university of Besancon.

---

<sup>2</sup> GEMOS = *Groupe d'Etude des Matières Organiques des Sols*, sub-group of the *Association Française d'Etude des Sols* (AFES), INRA, 78850 Thiverval-Grignon, France.

<sup>3</sup> CIRAD = *Centre International de Recherche Agronomique pour le Développement*, Avenue d'Agropolis, BP 5035, 34032 Montpellier Cedex, France.

<sup>4</sup> IRD = *Institute of Research for the Development* (ex-Orstom), 32 Avenue Varagnat, 93143 Bondy, France.

The method of reference chosen for the comparisons was described in "Method IHSS". In addition, the IRD laboratory in Bondy tested the method described in "Method of Dabin (1976)" on the same samples.

### Quantities Extracted by the IHSS Method

The results of the inter-laboratory study are summarized in Fig. 11.2. Figure 11.2a shows the carbon value in g for 100 g of dry soil obtained by the sum of the three fractions: acid extract + alkaline extract + non-extracted residue, compared to total carbon measured on whole soil. The fact that the results are located close to the bisecting line shows the absence of bias between the two methods.

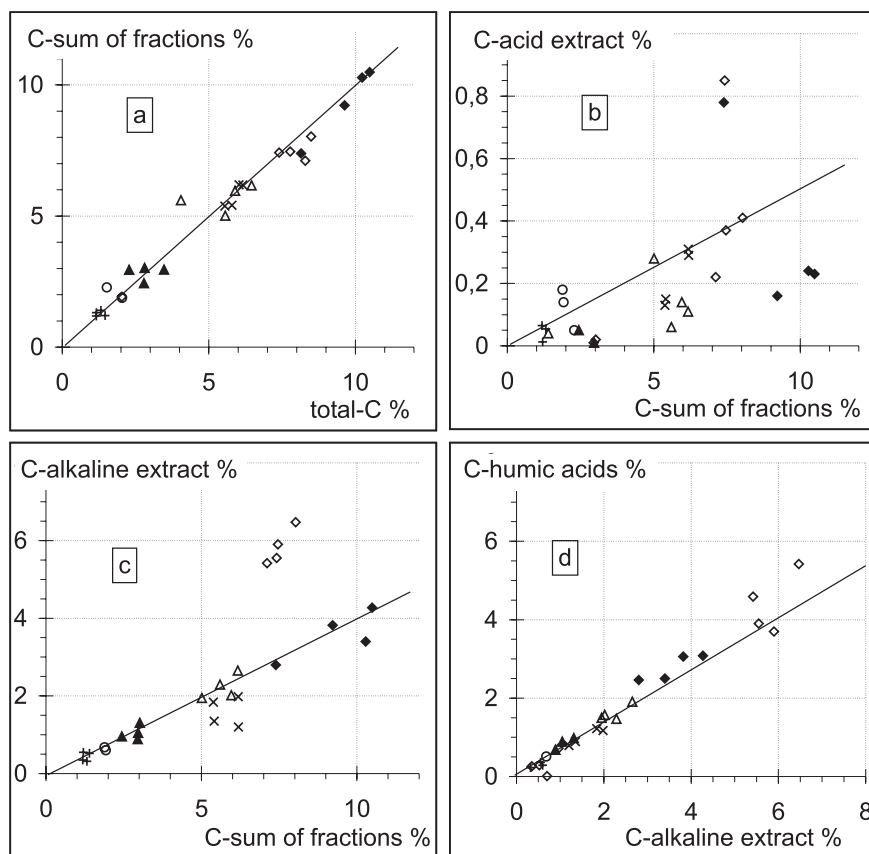

**Fig. 11.2.** Results of an inter-laboratory comparison using the extraction method described in "Method IHSS" (unpublished data). Results from four laboratories for the seven types of soils described in the text: (*plus*) soil 1, (*open triangle*) soil 2, (*open square*) soil 3, (*open diamond*) soil 4, (*cross*) soil 5, (*filled diamond*) soil 6, (*open circle*) soil 7

Figure 11.2b shows the amount of carbon extracted with the hydrochloric acid solution compared to the total quantity extracted. The quantity of acid extracted was low, below or equal to 5% of total carbon. The two exceptions where the value was 10% are probably due to the presence of additional fragments of light non-humified organic matter. The values measured were very variable and there was no correlation with total carbon.

Figure 11.2c shows the carbon of the alkaline extract compared to total carbon. Two remarks can be made:

- in six of the seven soils, the soda solution extracted 20–40% of total carbon. The values are more grouped than that of the acid extract. Their distribution revealed a maximum threshold of extraction for six samples located at approximately 40% of total carbon (line). The values located under this threshold are probably errors in measurement due to insufficient extraction.
- there was an abnormally high value for soil 4; this can be explained by the fact the soil was from the deep Bh organic horizon of a podzol; the organic matter which was leached to this depth was much more soluble in the soda solution than in the six other soils; in this case, the reagent extracted more than 3/4 of the carbon of the sample.

Figure 11.2d shows the quantity of carbon in humic acid forms compared to the carbon of the total alkaline extract. Whatever the type of soil, the carbon of humic acids accounted for approximately the 2/3 of the carbon of the alkaline extracts, and thus approximately 27% of total carbon. The deviation of the results around this value was limited.

### **Precision of the IHSS Method**

Table 11.1 shows the results of an analysis of variance carried out on the data obtained with the IHSS method: are the measured values on each soil equal or significantly different compared to experimental error.

The  $F$  test is the ratio of variance between soils (seven soils i.e. six degrees of freedom dof) to within inter-laboratory variance (27 measurements or 20 dof) represented by  $s_r^2$ . The pooled estimation of the standard error associated with a measurement from a given laboratory on an unspecified soil is indicated by “ $s$ ” in  $\text{g (C) } 100 \text{ g}^{-1}$  (dry soil) in absolute values and by RSD (relative standard deviation) in relative values. These values representing the precision of an inter-laboratory reproducibility test are upper limits of error. Repeatability would be better within one laboratory with well-trained staff.

Carbon measurement was tested in the hydrochloric acid extract, in the soda extract, in the humin residue, in the sum of these three fractions and finally in humic acids and fulvic acids.

Table 11.1 shows that:

- It is impossible to control the quantities extracted by hydrochloric acid, the errors observed in this case being more significant than the variations between the soils; this confirms the distribution in Fig. 11.2b.
- In all the other cases, the differences observed between the soils were significant compared to the residual error representing inter-laboratory variability.

**Table 11.1.** Precision of measurements in a comparative inter-laboratory test on seven soils using the IHSS method ( $F$ : test of significance of the soil values compared to the residual variance  $s_r^2$  between the four laboratories (\*\*\*, significant difference between laboratory data at risk <1%, NS, no significant difference).  $s$  and RSD: expected absolute (g (C) 100 g<sup>-1</sup>dry soil) and relative (%) standard deviations in case of a measurement (no replicate) from any laboratory)

Determination	$F(6,21)$	$s_r^2$	$s$	RSD%
C- acid extract	4.2 (NS)	0.026	0.16	83
C- alkaline extract	107 ***	0.141	0.38	17
C- humin residue	37 ***	0.317	0.56	22
C- sum of fractions	83 ***	0.410	0.64	13
C- total soil	100 ***	0.403	0.63	13
C- humic acids	67 ***	0.131	0.36	22
C- fulvic acids	16 ***	0.036	0.19	35

- In the alkaline extracts, the precision of the measurement of humic acids is better than that in the fulvic acids; this is probably due to the greater abundance of humic acids.
- The precision of the measurement of soil total carbon obtained by the sum of the first three measurements is of the same order of magnitude as that obtained by the direct measurement of carbon on the whole soil; moreover, the value obtained is in agreement with the rule of propagation of errors (Pansu et al. 2001); indeed, C-sum is obtained by:  
C-sum = C-acid extract + C-alkaline extract + C-humin residue

In the case of normal laws:

$$s_{C\text{-sum}} = (s^2_{C\text{-acid extract}} + s^2_{C\text{-alkaline extract}} + s^2_{C\text{-humic}})^{1/2}$$

then:

$$s_{C\text{-sum}} = (0.026 + 0.141 + 0.317)^{1/2}$$

$s_{C\text{-sum}} = 0.69$  is very close to the values 0.64 and 0.63 found for the synthetic variable and the measurement of total carbon, respectively.

### Comparison of the Methods Described in “Method IHSS” and “Method of Dabin (1976)”

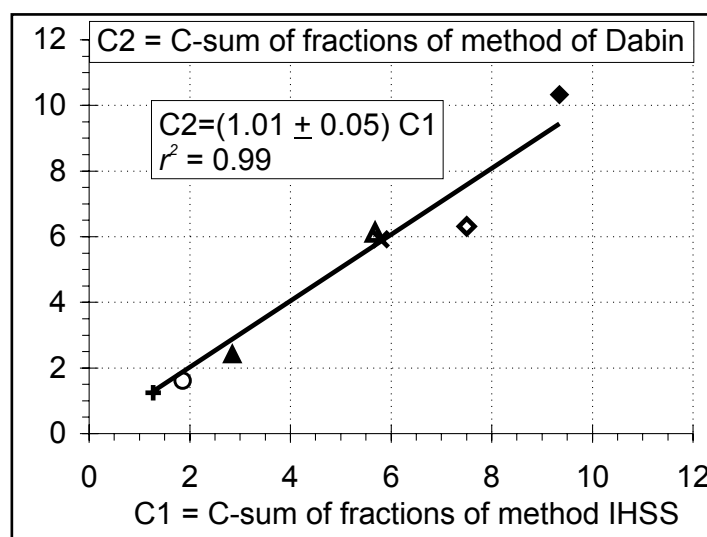
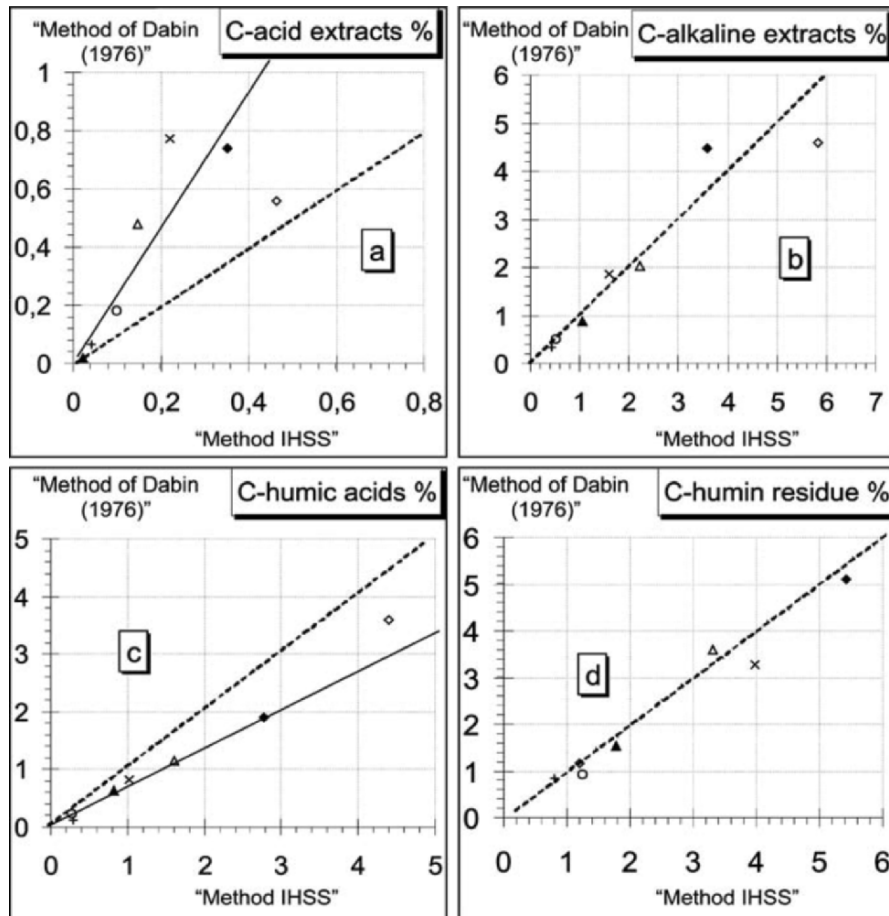

**Fig. 11.3.** Comparison of the carbon rates found with the two methods of extraction tested. Averages of the results of four laboratories for the seven types of soils described in the text: (*plus*) soil 1, (*open triangle*) soil 2, (*open square*) soil 3, (*open diamond*) soil 4, (*cross*) soil 5, (*filled diamond*) soil 6, (*open circle*) soil 7

Figure 11.3 shows that the total quantities of carbon (acid extract + alkaline extract + humin residue) found with the two methods are very close. However, more detailed comparison of the data in Fig. 11.4 reveals analogies and differences between the methods:

- Extraction of phosphoric acid described in “Method of Dabin (1976)” solubilizes between 1.2 and 4 times more (average 2 times more) organic matter than extraction with hydrochloric acid described in “Method IHSS” (Fig. 11.4a); the closest results for the two techniques were for the deep Bh horizon of the podzol.
- Alkaline extraction gave quantitatively comparable results with the two methods (Fig. 11.4b) when the sum of the extracts pyrophosphate and

soda described in “Method of Dabin (1976)” are taken into account; the results are also comparable for humin carbon, although very slightly weaker in the method described in “Method of Dabin (1976)”, (Fig. 11.4d).



**Fig. 11.4.** Comparison of the fractions extracted with the two extraction methods in the comparative study. Averages of the results of four laboratories for the seven types of soils described in the text: (*plus*) soil 1, (*open triangle*) soil 2, (*filled triangle*) soil 3, (*open diamond*) soil 4, (*cross*) soil 5, (*filled diamond*) soil 6, (*open circle*) soil 7.

– On the other hand, there was a clear difference between the two methods with respect to the quality of the extracted organic matter since “Method of Dabin (1976)” provided significantly less humic acids; in Fig. 11.4c the C- “Method of Dabin (1976)"/C- “Method IHSS” ratio is approximately 2:3 and the behaviour of sample 4 (deep Bh horizon of



the podzol) is a little different; the difference may be due to the effect of the extracting reagent on the extracted molecules i.e. polymerization in “Method IHSS”, macromolecular breakdown in “Method of Dabin (1976)” (cf. remarks in the introduction to this chapter).

#### 11.2.4 Purification of humic Materials

##### *Introduction*

It is difficult to choose a precise procedure for purification, as many alternatives are possible. According to Schnitzer (1982), the prime objective of purification is to minimize the weight of ash, while the second objective consists in separating the organic molecules of lower molecular weight from the humic materials. However, these definitions may be insufficient because the modes of the bonds between humic, non-humic and inorganic extracted materials are very complex and it is possible that many methods of purification have an influence on the structure of the final compounds isolated.

Nègre et al. (1976) recommend dialysis (Viskins dialysis bags with 24 Å pores) to purify humic materials extracted by pyrophosphate. Like other authors before them, these authors noted some transformation of the fulvic acids into humic polymers of higher molecular weight. It is as if “during the dialysis, which is accompanied by a progressive return of the medium towards neutrality, the molecules that were depolymerized during the alkaline extraction could polymerize again by simple re-establishment of the CO–NH bonds, similar to the peptide bonds leading to the formation of the nucleic acids” (Nègre et al. 1976).

Other simple purification methods enable elimination of certain minerals from the extracted solution by simple coagulation with the addition of a little sodium sulphate and centrifugation (Kumada et al. 1967) or ultracentrifugation (Jacquin et al. 1970).

Humic acids can also be purified by dissolving them in soda medium then precipitating them again in acid medium (Lowe 1980) or by a second process of extraction–fractionation on extracts that have previously been freeze-dried (Schnitzer 1982), or by prolonged freezing of humic solutions which can fractionate the different phases (Bachelier 1983).

The most effective procedure for purification – though only of humic acids – is to chemically attack the minerals with a diluted solution of the HCl–HF mixture to reduce the weight of ashes. Schnitzer (1982) noted that HCl–HF treatment can reduce the ash contents to less than 1%.

Jacquin et al. (1970) obtained less than 3% of ashes on three extracts purified with HCl-HF. Among the four purification methods tested by these authors, infra-red absorption spectra of purified humic materials showed that only the HCl-HF treatment almost completely eliminates the intense absorption bands of the phyllosilicates at 470, 520 and 1,030  $\text{cm}^{-1}$  (Fig. 11.5). However, according to these authors, the hydrofluoric treatment leads to transformation of the chemical structure of the molecules, in particular a significant reduction in carboxylic acidity.

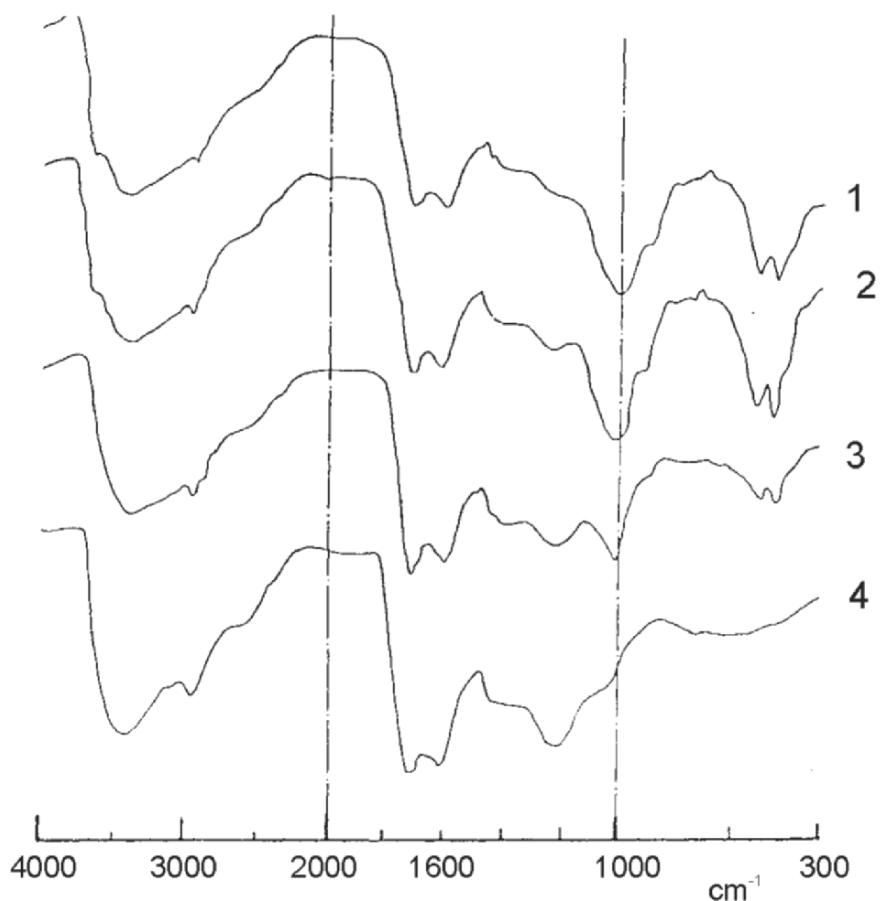

**Fig. 11.5.** Study by IR absorption spectrometry of the effect of three methods of purification on humic acids extracted from a deep Bh horizon of podzol (Jacquin et al. 1970): 1, non-purified humic acids; 2, humic acids purified by percolation on  $\text{OH}^-$  and  $\text{H}^+$  resins; 3, humic acids purified by ultra-centrifugation; 4, humic acids purified by HCl-HF treatment

Fulvic acids can be purified in acid medium by adsorption on non-ionic standard polyacrylic resins of the amberlite XAD-7 type (Aiken et al. 1979). After rinsing the resin in slightly acid medium to eliminate mineral salts, more than 98% of the fulvic acids can be recovered by elution at pH 6.5 (Gregor and Powell 1986). A simpler solution consists in eliminating the metal cations by repeated exchanges on a cation exchange resin in H<sup>+</sup> form (Schnitzer 1982).

### **Equipment**

- 150 mL Teflon or polypropylene bottles
- Glass columns for chromatography with a diameter of 1 or 2 cm and a Teflon stopcock
- *Optional.* Freeze dryer and freezer at –18°C

### **Products**

- Dialysis bags with 24 Å pores
- Non-ionic polyacrylic resin (Amberlite XAD-7 or similar)
- Cation exchange resin Amberlite IR 120, or Dowex 50, in H<sup>+</sup> form
- *HCl–HF mixture.* Dilute 5 mL of concentrated HCl and 5 mL of 52% hydrofluoric acid in 990 mL inorganic water
- *Extracting reagents.* see Sect. 11.2.1

### **Procedures**

Only the techniques for the purification of fulvic acids by cation exchange resins and techniques of purification of humic acids by HCl–HF attack are described here. However, as mentioned in “Introduction”, it is important to be very careful when choosing a purification method, which should take into account observations that need to be carried out on the purified products later on. For other methods of purification, see references in the last paragraph of “Introduction” under Sect. 11.2.4.

Agitate a mixture of 1 g of humic acids and 100 mL of HCl–HF solution in a stopped polypropylene flask for 24 h at room temperature. Filter and suspend the filtrate again with 100 mL of HCl–HF solution. Repeat this treatment three or four times, carefully rinse the residue with inorganic water, then dry or freeze-dry.

Purify the fulvic acid solution three or four times on cation exchange resin in H<sup>+</sup> form, then freeze-dry.

### 11.3. Further Alternatives and Complementary Methods

#### 11.3.1. Alternative Methods of Extraction

Though the methods described above using diluted soda and sodium pyrophosphate are the most widely used, alternative methods of extraction have been proposed. For example, Kumada et al. (1967) developed a method used at the University of Nagoya (Japan); Lowe (1980) used yet another technique at the University of British Columbia (Canada); and the two techniques were the subject of a comparative test by Lowe and Kumada (1984).

Gregor and Powell (1986) developed a method for the extraction of fulvic acids with pyrophosphate in acid medium; this technique could avoid two potential problems: oxidation of the phenolic compounds in alkaline medium, and oxidation by the  $\text{Fe}^{3+}$  ions during acidification for precipitation of humic acids.

Several comparative studies of extractions should also be mentioned. For example, Thomann (1963) compared 3% ammonium oxalate, 1% soda, 1% sodium fluoride and sodium pyrophosphate; Jacquin et al. (1970) compared soda, sodium pyrophosphate and ion exchange resins; Hayes et al. (1975) compared saline solutions, organic chelating agents, dipolar aprotic solvents, pyridine, ethylene diamine and soda in solution. They concluded that soda is the best of the reagents they tested for isolation of representative extracts of a broad range of humic substances.

#### 11.3.2 Fractionation of the Humic Residue

##### *Principle*

Given that between 40 and 80% of total carbon cannot be extracted with alkaline solvents, Perraud (1971) and Perraud et al. (1971) proposed a technique for the fractionation of the non-extractable humic residue. They performed successively:

- An alkaline extraction after two attacks with hot  $\text{H}_2\text{SO}_4$ : this extract was called “humic bound to iron” (Perraud et al. 1971); the sulphuric attack probably also releases sugars during the destruction of non-extractable polysaccharide like cellulose (cf. Chap. 13).
- An alkaline extraction after six attacks with hot  $\text{HF-HCl}$  provided organic material bound to clays.

However, these authors showed that the non-extractable fraction was still very high (37–52% of total carbon in their test) in spite of the total destruction of clays which was confirmed by X-ray. From 8 to 23% of this non-extractable fraction solubilized in  $\text{CH}_3\text{COBr}$  probably corresponded to fresh or only slightly transformed organic matter that was not previously trapped in a mineral gangue. The fraction that remained insoluble in  $\text{CH}_3\text{COBr}$  probably corresponded to either (1) organic matter very near to lignin but sufficiently transformed to be insoluble in acetyl bromide or (2) highly polymerized compounds in which the reduction of the functional groups probably resulted in their becoming insoluble in alkaline reagents.

A procedure for fractionation of the humin residue developed from the method of Perraud et al. (1971) and used in IRD laboratories (Bondy, France) is described below.

### **Procedure**

- Weigh 10 g of the extraction residue of Sect. 11.2.1 above that has been dried, crushed and sieved to 0.2 mm.
- Add 50 mL of 1 mol ( $\frac{1}{2}\text{H}_2\text{SO}_4$ )  $\text{L}^{-1}$  sulphuric acid and heat at 70°C for 3 h.
- Centrifuge at 3,000g for 15 min.
- Wash twice with hot water and recover the centrifugation pellet.
- Extract the centrifugation pellet with 50 mL 0.1 mol (NaOH)  $\text{L}^{-1}$  soda solution for 4 h with agitation and leave to stand overnight.
- Centrifuge at 3,000g for 15 min. The supernatant liquid contains *humin bound to hydroxides* (HH); reserve for titration of fulvic and humic acids as described in Sect. 11.2.2; depending on soil type, the extract can be purified by flocculation of clays with a salt like sodium sulphate; add the flocculate to the centrifugation pellet.
- Take an aliquot of the centrifugation pellet for intermediate titration of carbon and possibly of nitrogen; this titration enables identification of the fraction that is solubilized in the acid (e.g. polysaccharides) by calculating the difference.
- On the other fraction of the centrifugation pellet (the larger fraction), destroy the clay particles by:
  - (a) four successive attacks with 50 mL of the 1 mol (HCl–HF)  $\text{L}^{-1}$  mixture at 70°C for 3 h then centrifuge for 15 min at 3,000g
  - (b) Attack with 50 mL of the 1 mol (HF)  $\text{L}^{-1}$  solution for 3 h at 70°C, centrifuge at 3,000g for 15 min, wash the centrifugation pellet with hot water and centrifuge again.

- Extract the centrifugation pellet with 50 mL of 0.1 mol (NaOH) L<sup>-1</sup> solution agitate for 4 h and leave to stand overnight.
- Centrifuge at 3,000g for 15 min. Recover the humic compounds of *humic bound to the silicates* (HS) from the solution; on these compounds measure the carbon of the fulvic and humic acids (cf. Sect. 11.2.2).
- *Inherited humin(IH)*, which is made up of small organic fragments resembling charcoal, can be recovered on the centrifugation pellet:
  - (a) Add 50 mL H<sub>3</sub>PO<sub>4</sub>  $d = 1.4$ ; subject to ultrasound for 10 min, agitate mechanically for 30 min;
  - (b) Centrifuge at 1,500g for 10 min, then filter the supernatant on a small funnel stopped with a glass wool plug.

The carbon fragments recovered on this plug are the insoluble IH. As the liquids of previous acid attacks can also include suspended particles, after each centrifugation it is advised to filter the supernatants on the same glass wool plugs. After careful rinsing with inorganic water, dry the funnel at 50°C, crush the inherited humin and glass wool plug with an agate mortar and analyse carbon and nitrogen with a CHN analyser.

The last centrifugation pellet is the final residue of *nonextractable residual humin* (RH), rinse twice with inorganic water to eliminate the phosphoric acid, dry, crush and analyse carbon and nitrogen with a CHN analyser.

### Calculations

#### Data Collected

Weight of soil sample at the beginning:	<i>P0</i>
Weight of humin (centrifugation pellet cf. "Procedures" under Sect. 11.2.1):	<i>P1</i>
Weight of the <i>P1</i> sampling for sulphuric attack:	<i>P2</i>
Weight of the intermediate pellet (after HH extract):	<i>P3</i>
Weight of the <i>P3</i> sampling for HF–HCl attack:	<i>P4</i>
Possible weight of other <i>P3</i> sampling for C titration: (generally, $P4 + P4' = P3$ )	<i>P'4</i>
Weight of non-extractable RH:	<i>P5</i>

#### Concentrations of the Extracts

Humic (initial centrifugation pellet cf. "Procedures" under Sect. 11.2.1)	<i>Ch</i>
Humic bound to hydroxides (mg C on initial humic)	<i>Chh</i>
Intermediate centrifugation pellet (after HH extract) mg C g <sup>-1</sup>	<i>Ci</i>

Humin bound to silicates (mg C on the whole extracted)	<i>Chs</i>
Carbon from the mixture of the glass wool and inherited humin (mg)	<i>Cih</i>
Residual humin (mg C g <sup>-1</sup> )	<i>Crh</i>

### Calculations

Calculated on the initial soil sample, the carbon concentrations, (mg C g<sup>-1</sup> dry soil) of humin before fractionation (H), humin bound to the hydroxides (HH), intermediate residue (I), humin bound to silicates (HS), inherited humin (IH), residual humin (RH) are expressed by:

$$\begin{aligned}
 H &= Ch P1/P0 \\
 HH &= Chh P1 (P2 P0)^{-1} \\
 I &= Ci P3 P1 (P4' P0)^{-1} \\
 HS &= Chs P3 P1 (P4 P2 P0)^{-1} \\
 IH &= Cih P3 P1 (P4 P2 P0)^{-1} \\
 RH &= Crh P5 P3 P1 (P4 P2 P0)^{-1}
 \end{aligned}$$

The H-(I+HH) value provides an estimate of the carbon dissolved in the hot sulphuric acid (polysaccharides of humin). The I-(HS+IH+RH) value provides an estimate of the carbon dissolved by the HF-HCl mixture.

### References

#### Humic materials

- Aiken GR McKnight DM Wershaw RL and MacCarthy P eds (1985) Humic substances in soil, sediment and water. I. *Geochemistry, Isolation and Characterization*. Wiley, New York, NY, 692 p
- Bruckert S (1979) Analyse des complexes organo-minéraux des sols. In : *Pédologie 2. Constituants et propriétés du sol*, Bonneau M and Souchier B ed., Masson, Paris, 187-209
- Carter MR and Stewart BA eds. (1995) *Structure and Organic Matter Storage in Agricultural Soils* (Advances in Soil Science), Lewis Publishers, Inc., Boca Raton, FL

- Chamayou H and Legros JP (1989) *Les bases physiques, chimiques et minéralogiques de la science du sol*. Presses Universitaire de France (Techniques vivantes), 608 p
- Duchaufour Ph (1977) *Pédologie. I. Pédogénèse et classification*. Masson, Paris, 477 p
- Flaig W, Beutelspacher H and Rietz E (1975) Chemical composition and physical properties of humic substances. In *Soil Components, Vol. I : Organic Components*, Gieseking JE ed., 1–211
- Hessen DO and Tranvik LJ eds. (1998) *Aquatic Humic Substances : Ecology and Biogeochemistry* (Ecological Studies, Vol .133). Springer, Berlin, Heidelberg, New York
- Kononova MM (1966) *Soil Organic Matter – Its Nature, Its Role in Soil Formation and in Soil Fertility* (translated from the Russian by Nowakowski PhD and Newman ACD), Pergamon Press, New York
- Magdoff F, Tabatabai MA and Hanlon E (1996) *Soil Organic Matter: Analysis and Interpretation (Sssa Special Publication, No 46)*, American Society of Agronomy
- Piccolo A Ed. (1996) *Humic Substances in Terrestrial Ecosystems*. Elsevier, Amsterdam
- Schnitzer M and Kahn SU (1972) *Humic Substances in the Environment*. Dekker, New York, 327 p
- Schnitzer M (1978) Humic substances : chemistry and reactions. In : *Soil Organic Matter*, Schnitzer M and Kahn SU ed., Elsevier, Amsterdam, 1, 58
- Springer U (1938) Der Heutige stand der Humusuntersuchungsmethodik mit besonderer Berücksichtigung der Trennung, Bestimmung und Charakterisierung der Huminsäuretypen und ihre Anwendung auf Charakteristische Humusformen. *Zeitsc.f.Pflanzen*, 6, 312–373
- Stevenson FJ and Elliott ET (1989) Methodologies for assessing the quantity and quality of soil organic matter. In : *Dynamics of Soil Organic Matter in Tropical Ecosystems*, Coleman DC, Oades JM, Uehara G ed. University of Hawaii Press, Honolulu Hawaii 96822, 173–199
- Stevenson FJ (1982) *Humus Chemistry*, Wiley, New York, 443 p
- Stevenson FJ (1994) *Humus Chemistry : Genesis, Composition, Reactions*, 2nd edition. Wiley, New York, 496 pages
- Tate RL (1992) *Soil Organic Matter. Biological and Ecological Effects*. Krieger, Melbourne FL, 304 p

### **Extraction, titration, purification and fractionation of humic materials**

- Aiken GR, Thurman EM and Malcolm RL (1979) Comparison of XAD macroporous resins for the concentration of fulvic acid from aqueous solution. *Anal. Chem.*, 51, 1799–1803
- Bachelier, G (1983) Variations périodiques dans le degré de condensation des acides humiques: mise en évidence par spectrofluorimétrie, corrélation avec la stabilité structurale des sols. *Cahiers ORSTOM. Série Pédologie (FRA)*, 20(3): 247-254.



- Dabin B, Gavinelli E and Pelloux P (1983) Résultats de l'enquête analytique sur l'extraction et le dosage des matières humiques des sols-Réunion GEMOS Montpellier, Mai 1983. Document Orstom-Gemos, 16 p. multigr
- Dabin (1976) Méthode d'extraction et de fractionnement des matières humiques du sol, application à quelques études pédologiques et agronomiques dans les sols tropicaux. *Cah. ORSTOM ser. Pédol.*, XIV, 287–297
- Gregor JE and Powell HKJ (1986) Acid pyrophosphate extraction of soil fulvic acids. *J. Soil Sci.*, 37, 577–585
- Hayes MHB, Swift RS, Wardle RE and Brown JK (1975) Humic materials from an organic soil: A comparison of extractants and of properties of extracts. *Geoderma*, 13, 231–245
- Jacquin F, Calvez C, Dormaar JF and Metche M (1970) Contribution à l'étude des processus d'extraction et de caractérisation des composés humiques. *Bull. Ass. Fr. Etude du Sol*, 4, 27–38
- Kumada K, Sato O, Ohsumi Y and Ohta S (1967) Humus composition of mountain soils in central Japan with special reference to the distribution of P type humic acid. *Soil. Sci. Plant Nutr.*, 13, 151–158
- Lévesque and Schnitzer (1966) Effects of NaOH concentration on the extraction of organic matter and of major inorganic constituents from a soil. *Can. J. Soil Sci.*, 46, 7–12
- Lowe LE and Kumada K (1984) A comparison of two methods for routine characterization of humus in pedological studies. *Soil Sci. Plant Nutr.*, 30, 321–331
- Lowe LE (1980) Humus fraction ratios as a means of discriminating between horizon types. *Can. J. Soil Sci.*, 60, 219–229
- Nègre R, Ghiglione Cl, Pugnet T and Giraud M (1976) Influence des méthodes d'extraction et de purification sur la nature des acides humiques de la cédraie du Petit Lubéron. *Cah. ORSTOM ser. Pédol.*, XIV, 337–350
- Pansu M, Gautheyrou J and Loyer JY (2001) Soil Analysis – Sampling, Instrumentation and Quality control. Balkema, Lisse, Abington, Exton, Tokyo, 489 pp
- Perraud A (1971) *La matière organique des sols forestiers de la Côte d'Ivoire.*, Thèse Docteur ès-sciences naturelles, Univ. Nancy I, 87 p. + annexes.
- Perraud A, Nguyen Kha, Jacquin F (1971) Essai de caractérisation des formes de l'humine dans plusieurs types de sols. *C. R. Acad. Sci. Paris, série D*, 272, 1594–1596
- Schnitzer M (1982) Organic Matter Characterization. In: *Methods of Soil Analysis, Part 2 Chemical and Microbiological Properties, 2nd edition*, Page AL, Miller RH and Keeney DR ed. Agronomy monograph N°9, Am. Soc. of Agronomy, Madison, Wisconsin USA, 581–593
- Thomann Ch (1963) Quelques observations sur l'extraction de l'humus dans les sols: méthode au pyrophosphate de sodium. *Cah. ORSTOM ser. Pédol.*, 3, 43–72

## Characterization of Humic Compounds

### 12.1 Introduction

#### 12.1.1 Mechanisms of Formation

The synthesis of humic substances has been the object of speculation for many years. Andreux (1994) distinguished lytic mechanisms (lysis of the cellular walls, proteolysis, ligninolysis, transformation of polyphenols and other organic components), the mechanisms of tanning and melanisation which include incorporation of nitrogen and oxygen (Maillard's reaction: condensation of carbohydrates in the presence of amino nitrogen, condensation of polyphenol and amino acids in oxidizing medium) and the incorporation of inherited compounds.

Schnitzer (1978) reported the following four hypotheses about the formation of humic substances:

- *Deterioration of plant material.* Certain fractions of plant tissues, particularly woody materials, are only superficially decomposed in the soil to form humic substances; the nature of this “inherited humus” is thus strongly influenced by the nature of the original plant material; the first stage of humification provides the heaviest humic substances which can then be broken down into lighter substances and ultimately into CO<sub>2</sub> and H<sub>2</sub>O.
- *Chemical polymerization.* The plant materials break down into small molecules which are used as a source of energy and carbon by micro-organisms; these micro-organisms then synthesize phenols and amino acids which are polymerized into humic substances; in this case the nature of original material has no effect on the type of substance formed.

- *Cellular autolysis*. The fragments resulting from autolysis of microbial and plant cells (amino sugars, acids, phenols and others aromatic compounds) condense and polymerize via free radicals.
- *Microbial synthesis*. Microbes use plant tissue as a source of carbon and energy to synthesize intercellular organic materials of high molecular weight; at microbial death, these substances are released in the soil; they represent the first stage of humification and can then undergo extracellular microbial degradation into lighter molecules.

### 12.1.2 Molecular Structure

Based on their solubility properties, humic substances are generally classified in the three following categories: *humic acids*, *fulvic acids*, *humins* (cf. Chap. 11).

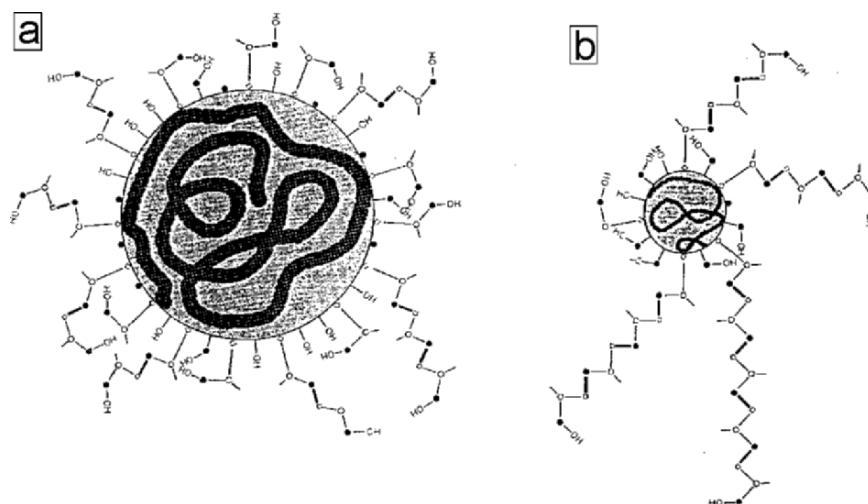

**Fig. 12.1.** Structure of two humic macromolecules; only the *nuclei* are represented at a scale of molecular weight (mw) for (a) mw >50,000, and (b) mw <5,000. *filled circle* C=O, *open circle* CH, *open square* NH, — peptide bond, ●— OH carboxyl (Andreux, 1994)

In a review of the literature, Schnitzer and Kahn (1972) showed that these three humic fractions are structurally rather similar. The structure of the humic molecule can be described schematically as a *nucleus* rich in hydroxy-quinonic units linked by C–C or C–O–C bonds (Andreux 1994). The frequency of distribution of the proteic and polypeptide chains fixed

on this nucleus varies with the type of soil and the precursors. The molecular size of these structures (Fig. 12.1) depends both on the dimension of the nucleus and on the nature of the phenolic precursors. Their affinity for aqueous solvents thus depends on the number and the length of the peripheral hydrophilic chains carrying the free  $-\text{COOH}$  groups of polypeptides, however, with significant acidity of the matrix (Andreux 1994).

The properties of the three humic fractions differ especially with respect to their molecular weight, their ultimate analysis, and the number of functional groups. Fulvic acids have the lowest molecular weight, contain more oxygen but less carbon and nitrogen than the other two. The functional groups containing oxygen ( $\text{CO}_2\text{H}$ ,  $\text{OH}$ ,  $\text{C}=\text{O}$ ) have a rate per unit of weight that is higher in fulvic acids than in humic acids and humin (Stevenson 1982).

Humic acids are also extractable from charcoal (Lawson and Stewart 1989) and research using  $^{13}\text{C}$  nuclear magnetic resonance spectroscopy (cf. Sect. 12.3.4) has shown that the stable carbon of Australian soils is mainly charcoal (Skjemstad et al. 1996). Although structural models of humic molecules have been proposed (e.g. Schulten 1995, Schulten and Schnitzer 1997, Schulten and Leinweber 2000, Schulten 2002, Lodygin and Beznosikov 2003), most of the concepts concerning molecular structure are not applicable to humic acids (McCarthy 2001). Further research is needed to obtain precise information about these molecules, their bonds with inorganic (Schulten and Leinweber 2000) and xenobiotic (Piccolo et al. 1999) molecules and their distribution in different soil types, which, in turn, will improve understanding of their role in the environment. All modern instrumental methods are needed for these researches (Hatcher et al. 2001, Piccolo and Conte 2003).

## 12.2 Classical Techniques

### 12.2.1 Fractionation of Humic Compounds

#### *Principle*

For many years humic acids were characterized according to the degree they bonded with clays (Springer 1938, Tiurin 1951, Duchaufour 1954, 1956).

*Brown or free humic acids* were considered to be only slightly bonded to clays, to have the lowest molecular weight and to be relatively insensitive to the flocculating action of electrolytes; they were said to derive from the oxidation of lignin under the action of the polyphenoloxidase and to characterize acid soils in particular, e.g. forest soils in a wet climate (Duchaufour 1956).

*Grey humic acids* are darker in colour, form closer bonds with mineral colloids, have more condensed molecules, flocculate easily in the presence of electrolytes; this type of humus is characteristic of black soils, but is also relatively abundant in all soils that are rich in calcium.

Early methods of fractionation of humic acids were thus based on the properties of the two main types of compounds: extraction in the presence of a flocculating agent in the case of brown humic acids followed by washing the residue in water in the case of grey humic acids (Duchaufour 1956), direct soda extraction of brown humic acids then extraction of two fractions of grey humic acids as a function of their bonds with calcium or iron and aluminium (Duchaufour 1957).

To simplify the procedure, Duchaufour and Jacquin (1966) proposed a method with electrophoretic fractionation of humic acids on pyrophosphate extracts (cf. "Method of Dabin (1976)" Chap. 11). This method was compared with that of Tiurin (1951) by Dabin and Thomann (1970); it was widely used in France, in particular in IRD<sup>1</sup> laboratories (Ratsimbazafy 1973, Dabin 1980). This is the first fractionation method described later. The technique of fractionation of humic acids by exclusion chromatography (Bailly and Margulis 1968, Bailly and Tittone 1972) is also described later, along with a fractionation procedure for fulvic acids. Other complex techniques for fractionation of humic compounds are described more briefly in Sect. 12.3.1.

### **Equipment**

- Plastic electrophoresis tank with three compartments (Fig. 12.2)
- stabilized supply of direct current adjustable between 0 and 600 V
- photoelectric densitometer to read the electrophoresis diagrams
- columns for liquid chromatography, diameter: 2.5 cm, length: 80 cm
- UV–visible detector equipped with a recorder or a system for data acquisition
- fraction collector (optional)
- peristaltic pump with flow of 50 mL h<sup>-1</sup> (optional).

---

<sup>1</sup> IRD = Institute of Research for Development (ex-Orstom), Bondy, France.

### Products

- Filter paper tapes (Arch 302 or Whatman no. 1 or 2), 5 cm in width and 35 cm in length, cut perpendicular to the direction the filter is filled (when a square sheet of paper is held by one side, the direction perpendicular to filling is where the paper curves most under its own weight)
- extraction solutions (see Sect. 11.2.1 in Chap. 11)
- buffer solution for electrophoresis: in a 2 L volumetric flask add 13.6 g of monobasic potassium phosphate, 2.5 g of soda pellets and approximately 1.5 L of inorganic water (cf. Sect. 11.2.1 of Chap. 11), adjust pH to 7.4 with soda if necessary, agitate well and complete to 2 L
- standard dextrane gel Sephadex G25 for molecular weights  $\leq 5,000$
- standard dextrane gel Sephadex G75 for molecular weights  $\leq 50,000$
- standard dextrane gel Sephadex G200 for molecular weights  $\leq 200,000$
- polyvinylpyrrolidone

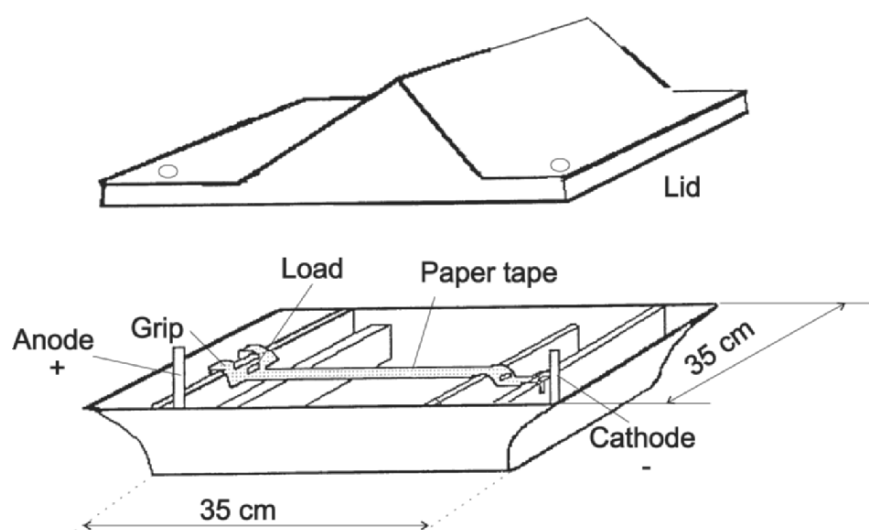

**Fig. 12.2.** U-tube tank for paper electrophoresis of humic acids

- TRIS buffer (pH 9, ionic force 0.5): mix 414 mL of M 2-amino-2-hydroxymethyl-propane-1, 3-diol, 50 mL of 1 mol (HCl)  $L^{-1}$  solution and complete to 1 L inorganic water
- Borax buffer (pH = 9.1, ionic strength = 0.075): 0.025 mol ( $Na_2B_4O_7$ )  $L^{-1}$ .

**Procedure for Electrophoresis Fractionation of Humic Acids**

- Take a quantity of humic extract solution (pyrophosphate or soda) corresponding to 25 to 50 mg carbon (cf. titration in Sect. 11.2.2 of Chap. 11).
- Precipitate the humic acids at pH 1 with sulphuric acid, centrifuge and wash the centrifugation pellet several times with a 1 mol ( $\frac{1}{2}$ H<sub>2</sub>SO<sub>4</sub>) L<sup>-1</sup> solution.
- Dissolve the humic acids in approximately 1 mL of normal soda solution so as to obtain a rather thick solution but without solids (cf. purification in Sect. 11.2.4 of Chap. 11) and with a homogenous concentration of carbon; store in a well-stopped hemolysis tube.
- Fill the two external compartments of the electrolysis tank to the same level with electrophoresis buffer solution; wet the paper strip in the buffer solution, dry it between two sheets of filter paper and place it in the electrophoresis tank, pull it tight between the two external compartments as shown in Fig. 12.2.
- With a 100 mm<sup>3</sup> micropipette deposit approximately 40 mm<sup>3</sup> of humic solution at a distance of 5 cm from the cathode following a straight line down the centre of the strip of paper and leaving 1 cm free on each side of the paper; in the case of very concentrated solutions, the deposit can be reduced to 20 mm<sup>3</sup>.
- Place the lid on the tank and start the electrical current; regulate the current at 10 V per cm of paper, or approximately 200 V; the intensity of the current depends on the number of paper strips for simultaneous electrophoresis and on the conductivity of the electrolyte (approximately 15 mA with four strips). The negatively charged humic molecules migrate towards the anode; the smaller the molecules, the faster they migrate (e.g. brown humic acids, BHA). Migration is rapid at the beginning then slows down. The time needed for standard electrophoresis is 3 h which corresponds to 10–12 cm displacement by brown humic acids.
- Shut off the current and rapidly remove the paper strips, place them on a flat surface and dry them under IR radiation or in the drying oven at 60°C. Record the radiation transmission of each strip of paper with a photoelectric densitometer.
- An electrophoresis diagram (Fig. 12.3) is obtained in which:
  - (1) *grey humic acids (GHA)* often display a distinct narrow peak up to 1 cm from the starting line; in the case of the chernozems, Duchaufour and Jacquin (1963) reported a second peak which could migrate up to 2 cm from the starting line; in tropical soils, GHA are frequently spread

out over 3 or even 4 cm with either a single peak, or two or more peaks; it is sometimes rather difficult to detect the limit of GHA and their peak limit has consequently been arbitrarily fixed at 1/3 of the overall length of the diagram, i.e. 3–4 cm for a length of 9–12 cm

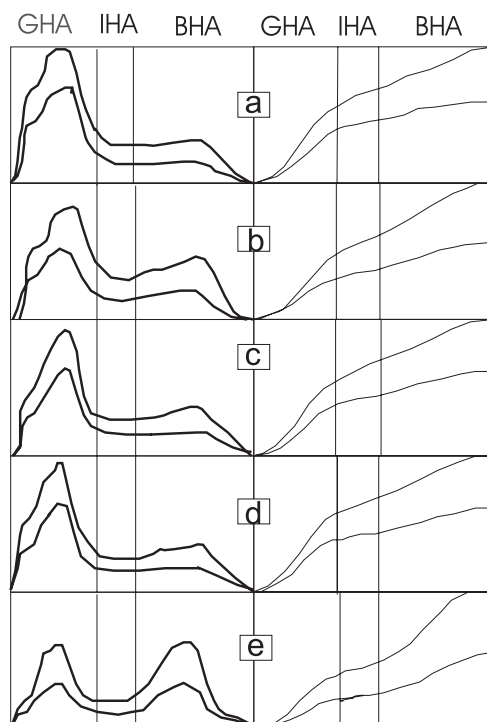

**Fig. 12.3.** Examples of electrophoresis diagrams of humic acids extracted with a pH 9.8 pyrophosphate solution in a range of tropical soils (Dabin 1980). On the *left*: direct readings with the optical densitometer at wavelengths of 512 nm (*top curve*) and 625 nm. On the *right*: corresponding *integral curves* giving in the y-coordinate surfaces corresponding to grey humic acids (GHA: from 0 to 1/3 of the graph), intermediate humic acids (IHA: between 1/3 and 1/2), brown humic acids (BHA: more than 1/2 of the graph). **a**: tropical podzol (histic tropaquod), A horizon, **b**: tropical podzol (histic tropaquod), B horizon, **c**: humiferous ferrallitic soil (umbriorthox), surface horizon, **d**: humiferous ferrallitic soil (umbriorthox), subsurface horizon, **e**: weathered tropical soil (oxictropudalf).

(2) the humic compounds located between 1/3 and 1/2 of the length of the diagram are called *intermediary humic acids (IHA)*



- (3) the *brown humic acids (BHA)* are spread out between the middle and the other end of the diagram.
- The surface area of each fraction is determined; *SG* is the surface of the *GHA*, *SI* that of the *IHA*, *SB* that of the *BHA*, *ST* is the total surface area and % *qt* is the total quantity of humic acids; the total quantity of each fraction is expressed by:

$$GHA \% = qt \ SG/ST$$

$$IHA \% = qt \ SI/ST$$

$$BHA \% = qt \ SB/ST$$

Figure 12.3 shows some examples of electrophoresis diagrams obtained with this method.

### Remarks

Any liquid circulating on the paper strips can also cause migration of humic acids. This should be avoided by making sure that the liquid is at the same level at the anode and cathode (otherwise there is a risk of siphoning by the paper), and by avoiding evaporation on the paper. Evaporation can cause the liquid to move by aspiration on both sides of the paper strip. Thus, even without electrical current, certain humic acids may migrate and be found in the centre of the strip. With electrical current, migration will stop when the speed of migration due to the electric potential is equal to the speed of the liquid circulating in the opposite direction. It is thus imperative to use a lid to limit evaporation; the lid should be shaped like a roof to prevent drops of condensation falling onto the paper strips.

The passage of the current enriches the cathodic compartment in the soda and raises its pH; in the case of several electrophoresis series this phenomenon can be compensated for by reversing the direction of the current and thus of the deposit.

### Procedure for Humic Acid Fractionation on Dextrane Gels

Fractionations can be carried out in a simple way with elution using inorganic distilled water (Bailly and Margulis 1968, Bailly and Tittone 1972):

- prepare a concentrated solution of humic acids in the same way as for electrophoresis but with a sample specimen corresponding to 2–10 mg carbon, diluted in 3–10 mL of 1 mol (NaOH) L<sup>-1</sup> solution
- fill the columns with the Sephadex gel: 50 cm for G25 and G75, 70 cm approximately for G200, these heights are likely to vary with the type of humus (Bailly and Tittone 1972)

- deposit the test specimen on the G25 column and elute with inorganic water either by gravity (descending chromatography), or with a peristaltic pump at a flow of approximately  $30 \text{ mL h}^{-1}$  (ascending chromatography)
- carry the effluent in a UV photometer detector regulated at  $253.7 \text{ nm}$ ; record the chromatogram and collect the fractions corresponding to the main peaks (Fig. 12.4);

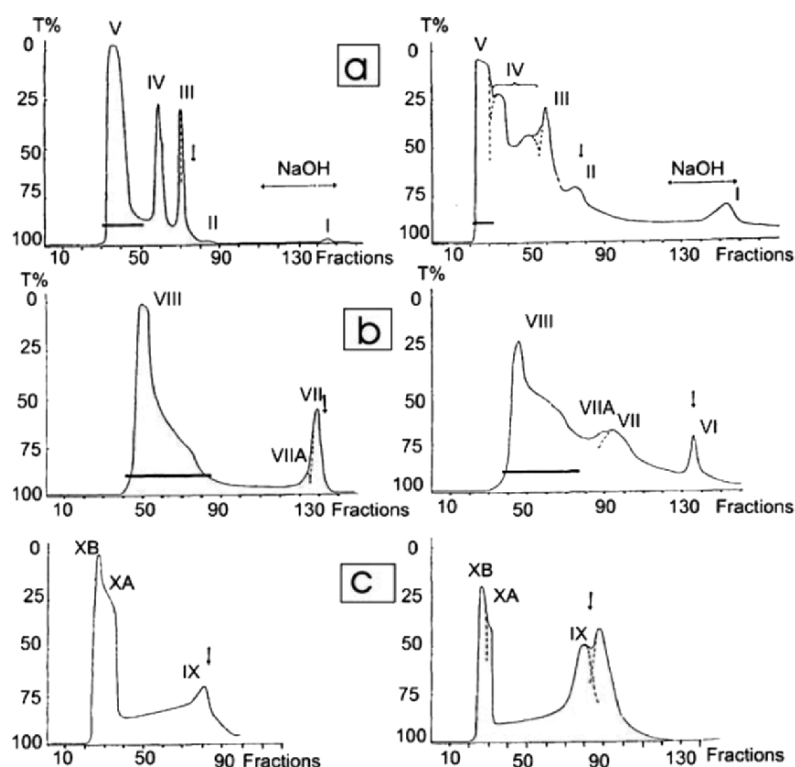

**Fig. 12.4.** Examples of separation by exclusion chromatography on dextrane gel (Bailey and Tittone 1972). On the left, grassland podzolic soil, A1 horizon, 0–6 cm depth; on the right, forest grey soil, A2 horizon, depth 16–29 cm. **a:** fractionation of the humic acid extract on Sephadex G25 F, test specimen corresponding to  $4.7 \text{ mg C}$ , **b:** fractionation on Sephadex G75 of peak V obtained in **a**, **c:** fractionation on Sephadex G200 of peak VIII obtained in **b**.

- the first eluted peak corresponds to the largest molecules that were not separated by gel exclusion; collect this fraction and subject it to exclusion chromatography in a similar way but on column G75; fractionate the new first peak eluted on this column again on column

G200; Fig. 12.8 presents two series of examples of chromatograms obtained successively on the three types of columns with two soils.

This type of fractionation by gel permeation can also be performed in buffered solutions to avoid interactions between the gel and the solution, e.g. Tris and Borax buffers prepared in the same way as in “Products” in Sect. 12.2.1 (Cameron et al. 1972a).

### **Fractionation of Fulvic Acids**

The method of Lowe (1975) is a very simple way to separate fulvic acids into two fractions: a coloured polyphenolic fraction and an almost colourless fraction with a prevalence of polysaccharide. Since  $C_h$ ,  $C_f$ ,  $C_a$  are carbons in humic acids, fulvic acids and their polyphenolic coloured fraction respectively, the  $C_h:C_f$  and  $C_a:C_f$  ratios were linked to the types of horizons used in the Canadian soil classification system which facilitate the distinction between some of these types (Lowe 1980):

- treat a fraction of the fulvic acid extract using 1 g polyvinylpyrrolidone for 100 mL of solution
- agitate intermittently for 30 min and filter
- titrate carbon on the filtrate (cf. Sect. 11.2.2 of Chap. 11) to quantify the  $C_a$  fraction; the fulvic acid sample must be sufficient in volume to allow titration with acceptable precision.

## **12.2.2 Titration of the Main Functional Groups**

### **Principle**

The procedures described here are based on the measurement of total acidity and of carboxylic acidity of Wright and Schnitzer (1959) and of Schnitzer and Gupta (1965).

For measurement of total acidity, the sample is treated with a barium hydroxide solution under  $N_2$  for 24 h. The  $Ba(OH)_2$  remaining in the solution after the reaction is then back titrated with a standard acid solution.

For the titration of carboxylic groups, the humic materials are agitated for 24 h with calcium acetate solution in excess which causes the release of acetic acid according to a reaction of the type:

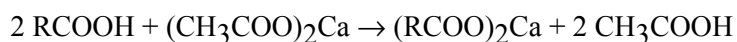

The acetic acid released is then titrated with a standard soda solution.

The proportion of phenolic groups is calculated by the difference between total acidity and the acidity of the carboxylic groups.

Other measurement techniques for functional groups (phenolic, alcoholic, ketonic, quinoid) are described briefly in Sect. 12.3.

### **Equipment**

- 125 mL Erlenmeyer flasks with screw caps
- titrimeter equipped with a combined electrode for the measurement of pH.

### **Products**

- 0.2 mol (1/2 Ba(OH)<sub>2</sub>) L<sup>-1</sup> barium hydroxide solution: weigh 31.548 g of Ba(OH)<sub>2</sub>·8H<sub>2</sub>O (quality containing the minimum of carbonate), dissolve in inorganic CO<sub>2</sub>-free water, complete to 1 L and protect from atmospheric CO<sub>2</sub> with a trap containing soda lime
- 0.5 mol (HCl) L<sup>-1</sup> hydrochloric acid solution: prepare using standard commercial dose; dilute with inorganic CO<sub>2</sub>-free water.
- 1 mol (1/2Ca(CH<sub>3</sub>COO) <sub>2</sub>) L<sup>-1</sup> calcium acetate solution: dry the pure product at 105°C and weigh 79.085 g under anhydrous atmosphere, dissolve in inorganic water and complete to 1 L.
- 0.1 mol (NaOH) L<sup>-1</sup> soda solution: prepare using standard commercial dose; dilute with inorganic water, complete to 1 L and protect with a trap containing soda lime during storage.

### **Procedure**

#### **Total Acidity**

To obtain the maximum number of exchangeable sites in acid-active form, it is advisable to work with carefully purified humic materials in order to reduce their ash rate (cf. Sect. 11.2.4 of Chap. 11).

Place an exact weight of between 50 and 100 mg of freeze-dried humic material in a 125 mL Erlenmeyer flask with a screw cap and add exactly 20 mL of 0.2 mol (Ba(OH)<sub>2</sub>) L<sup>-1</sup> solution. Perform a blank assay containing only the 0.2 mol (Ba(OH)<sub>2</sub>) L<sup>-1</sup> solution without the sample. Put the flasks under nitrogen atmosphere, stop well and agitate for 24 h at room temperature. Filter the suspension, wash the residue well with distilled CO<sub>2</sub>-free water, add the washing waters to the filtrate and carry out potentiometric titration of the resulting extraction solution with 0.5

mol (HCl) L<sup>-1</sup> solution up to pH 8.4.  $V_b$  and  $V$  are the volumes of standard acid solution for titration of the blank assay and of the sample, respectively,  $N_a$  is the acid normality and  $P$  the weight of the sample (mg); total acidity  $A_t$  in milliequivalents per gram of humic material is expressed by:

$$A_t = 1,000(V_b - V_s) N_a / P$$

### *Carboxyl Groups*

Place in a 125 mL Erlenmeyer flask with a screw cap an exact weight of between 50 and 100 mg of humic material; add 10 mL of 1 mol ½ Ca(CH<sub>3</sub>COO)<sub>2</sub> L<sup>-1</sup> solution and 40 mL of inorganic CO<sub>2</sub>-free water. At the same time, perform a blank assay containing the reagents without the humic sample. After 24 h of shaking at room temperature, filter the suspension, rinse the residue with distilled CO<sub>2</sub>-free water, combine the filtrate and washing water and perform potentiometric titration with the 0.1 mol (NaOH) L<sup>-1</sup> solution up to pH 9.8. If  $V_s$  and  $V_b$  are the volume of titrating solution for the sample and blank assay, respectively (mL),  $N_b$  is the normality of the standard soda solution (mol L<sup>-1</sup>),  $P$  the sample weight (mg); the carboxylic acidity  $A_c$  in mol (COOH) g<sup>-1</sup> humic material, is expressed by

$$A_c = 1,000(V_s - V_b) N_b / P.$$

### *Phenolic Acidity*

This  $A_p$  acidity can be expressed in mol (phenolicOH) g<sup>-1</sup> humic material by

$$A_p = A_t - A_c.$$

## **12.2.3 UV-Visible Spectrometry**

### ***Principle***

Among other molecular spectrometry techniques, UV spectrometry records electronic energy transitions in the molecules whereas lower-energy infra-red radiation records variations in molecular kinetic energy.

Although absorption in the ultraviolet and visible field of the electromagnetic spectrum does not give a band that is very characteristic of humic compounds (Schnitzer and Kahn 1972, Schnitzer 1978), the E4:E6 ratio of absorbance at 465 (E4) and 665 nm (E6) is often used to characterize humus. Ratios lower than 5 are characteristic of humic acids

while fulvic acids have higher ratios; this ratio is independent of the concentration of humic materials but is not the same for humic materials extracted from different types of soils.

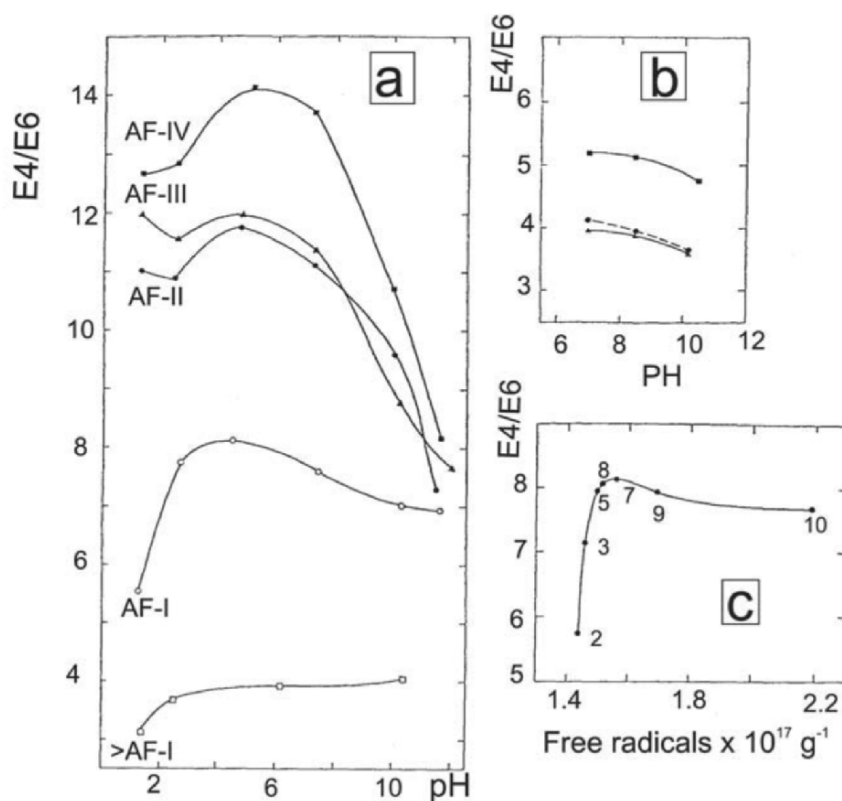

**Fig.12.5.** Effect of certain factors on the value of the E4:E6 ratio (Chen et al., 1977): **(a)** effect of the pH in different fractions of a fulvic acid (Bh horizon of a Canadian podzol) separated on Sephadex gel; the molecular weights measured by osmometry (Hansen and Schnitzer, 1969) were: 883 for AF-IV, 1181 for AF-III, 1815 for AF-II, 2110 for AF-I and >2110 for >AF-I, **(b)** effect of pH in some humic acids of Ah horizons of Canadian soils from the area round Alberta: Black Chernozem, Solod, Solonetz, **(c)** effect of the concentration of free radicals measured by electron spin resonance (cf. Sect. 12.3.6) for the fulvic acid used in **a**, (the numbers on the curve are pH values).

Kononova (1966) believed that the E4:E6 ratio was related to the degree of condensation of the aromatic carbon lattice, a weak ratio indicating a high degree of condensation of the aromatic humic

components, a strong ratio indicating the presence of a higher proportion of aliphatic structures.

Chen et al. (1977) made a thorough study of the information provided by the E4:E6 ratio. Their study showed that the E4:E6 ratio:

- is mainly governed by molecular size (or molecular or particle weight; Fig. 12.5a, b)
- is highly affected by the pH (Fig. 12.5a, b)
- is correlated with the concentration of free radicals (Fig. 12.5c), and with O, C, CO<sub>2</sub>H contents and total acidity (these measurements are also correlated with the size of the particles)
- does not present a direct correlation with the concentration of condensed aromatic nuclei, which would invalidate the assumption of Kononova (1966)
- is independent of the concentration of humic or fulvic acid, at least in the field of 100–500 ppm, which confirms the other assumption of Kononova.

In agreement with Kononova (1966), these authors finally showed that the most favorable range of pH to measure E4:E6 ratios is between 7 and 8. This can be obtained by dissolving humic material in a 0.1 mol (NaHCO<sub>3</sub>) L<sup>-1</sup> solution at a concentration of between 200 and 400 mg kg<sup>-1</sup>.

Ghosh and Schnitzer (1979) proposed a mechanism linking the macromolecular characteristics of humic substances and UV–visible absorption: optical density decrease with an increase in the concentration of neutral electrolyte, indicating a reduction in the size of the particles probably due to a rolling up of the macromolecule.

### **Equipment**

- UV–visible spectrograph with an adjustable double beam and fixed wavelength (465 and 665 nm) or preferably with variable wavelength between 200 and 700 nm
- quartz tanks for UV spectrometry.

### **Reagents**

- 0.05 mol (NaHCO<sub>3</sub>) L<sup>-1</sup> solution: in a 1 L volumetric flask dissolve 4.200 g of NaHCO<sub>3</sub> (quality suitable for spectrography) in inorganic distilled water, complete to 1 L and stop the flask well before storage.

### **Procedure**

Dissolve 2–4mg of humic material in 10 mL of the 0.05 mol (NaHCO<sub>3</sub>) L<sup>-1</sup> solution. Check the pH after dissolution, it should be close to 8 (the pH of a 0.05 mol (NaHCO<sub>3</sub>) L<sup>-1</sup> aqueous solution is 8.3). Fill the quartz measurement tank to mid-height with this solution and fill the reference tank with a pure 0.05 mol (NaHCO<sub>3</sub>) L<sup>-1</sup> solution. Measure the absorbance at 465 and 665 nm. The ratio of these two absorbencies is the E4:E6 ratio.

If more detailed studies are required, the optical density (OD) spectrum can be recorded in the 200–350 nm UV range (Ghosh and Schnitzer 1979) or in the 400–700 nm range; in the latter case, the straight lines  $\text{Log}(\text{OD}) = f(\text{Log } k)$  can be plotted and, according to Chen et al. (1977), its slope should be equal to  $-6.435 \text{ Log}(E4:E6)$

## **12.2.4 Infra-Red Spectrography**

### **Principle**

The infra-red spectrum between 1 and 100  $\mu\text{m}$  wavelength makes it possible to observe the vibrations of stretching and deformation of the molecules (as the spectrum of molecular rotation corresponds to less energetic radiations of wavelengths higher than 100  $\mu\text{m}$ ). In practice, the most useful spectral field for organic chemistry is in medium IR between the two wavelengths  $\lambda$  of 2.5 and 15  $\mu\text{m}$  corresponding to wavenumbers  $1/\lambda$  between 4,000 and 660  $\text{cm}^{-1}$  (cf. Sect. 5.1.1 of Chap. 5). The near IR zone can also be widely explored with the help of chemometrical software (cf. Sect. 5.3.1 of Chap. 5).

In humic substances, the IR spectrum mainly reflects oxygenated functional groups such as  $-\text{CO}_2\text{H}$ ,  $-\text{OH}$  and  $\text{C}-\text{O}$ . Some IR bands are particularly well defined (Schnitzer 1971) at wavenumbers 3,400  $\text{cm}^{-1}$  (H bound to OH), 2,900  $\text{cm}^{-1}$  (aliphatic CH bonds), 1,725  $\text{cm}^{-1}$  (C–O of  $\text{CO}_2\text{H}$ , C–O elongation of ketonic carbonyls), 1,630  $\text{cm}^{-1}$  (aromatic C–C, H linked to C–O of carbonyls,  $\text{COO}^-$ ), 1,450  $\text{cm}^{-1}$  (aliphatic CH), 1,400  $\text{cm}^{-1}$  ( $\text{COO}^-$ , aliphatic CH), 1,200  $\text{cm}^{-1}$  (CO stretching, OH deformations of  $\text{CO}_2\text{H}$ ), 1,050  $\text{cm}^{-1}$  (Si–O of the silicated impurities).

The IR spectrum does not provide much information on the chemical structure of the core of humic substances. However, it is very useful for preliminary characterization of humic materials of different origin (Fig. 12.6) to determine the effect of different extractions or chemical



purification agents (cf. Sect. 11.2.4 of Chap. 11), and to study the reaction of derivatisation such as silylation, methylation, and acetylation.

The IR spectrum also makes it possible to detect changes in the structure of humic materials following oxidation, pyrolysis or other treatments. Lastly, it is a practical method to characterize the formation of metal–humate and clay–humate complexes or to detect interactions between humic materials and other organic molecules such as pesticides.

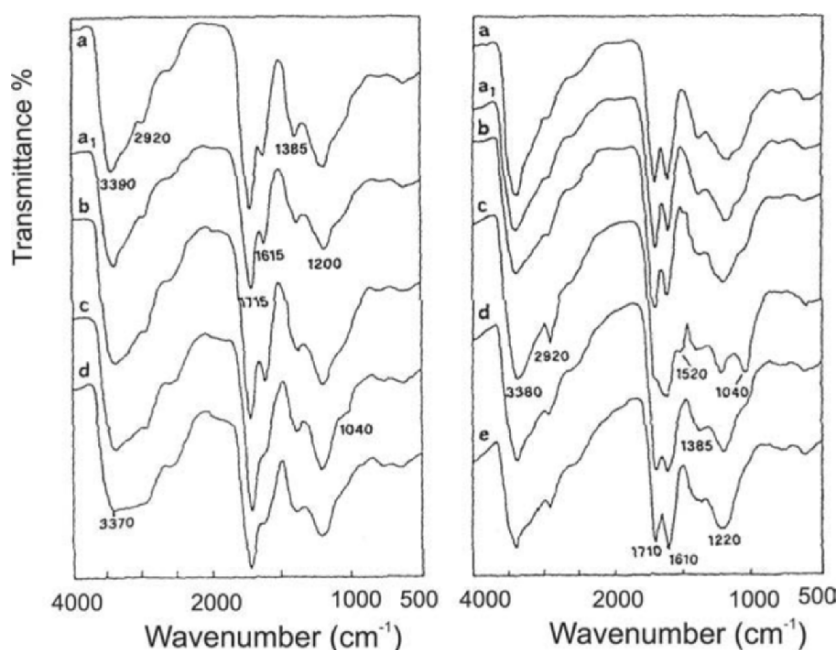

**Fig. 12.6.** Infrared spectra of some fulvic (on the *left*) and humic (on the *right*) acids of standard and reference samples of IHSS (Senesi et al. 1989): **(a)** Suwannee River Standard, code IHSS 1S101F (AF) and 1S101H (AH), **(a1)** Suwannee River Reference, code IHSS 1R101F (AF) and 1R101H (AH), **(b)** Nordic aquatic, code 1R105F and 1R105H, **(c)** Soil St, code 1S102F and 1R102H, **(d)** Peat, code 1R103F and 1R103H, **(e)** Leonardite, code 1R104 H.

Great care should be taken in interpreting the spectra and particularly to avoid confusing the organic or mineral origin of the absorption bands (Russel and Anderson 1977).

### Equipment

- Double beam IR absorption spectrograph with a field frequency between 300 and 4,000  $\text{cm}^{-1}$

- manual hydraulic press for the preparation of pellets for IR spectrography (e.g. standard 12 ton Spex-Carver)
- polished stainless steel vacuum pelletizer, diameter 13 mm.

NB: it is also possible to work without a pelletizer or a hydraulic press; spectra can be obtained in suspensions that are maintained between two IR-transparent blades; spectra can also be obtained in solutions with a solvent that is transparent to IR. The technique described below is not the cheapest but has been shown to be particularly suitable for IR spectrometry.

### **Product**

- Potassium bromide in powder form for IR spectrometry.

### **Procedure**

With the agate mortar, prepare a KBr pellet by mixing 1 mg of humic material with 400 mg of dry KBr. Place the powder in the pelletizer, put it under vacuum and press with a pressure of  $7,600 \text{ kg cm}^{-2}$  for 20 min (cf. “Preparation of Discs (Solid Solution)” in Chap. 5). Unmould the pellet, which should be vitrified, and place it in the measuring cell of the IR spectrometer, put a pellet of pure KBr in the reference cell and record the spectrum between 300 and  $4,000 \text{ cm}^{-1}$ .

## **12.3 Complementary Techniques**

### **12.3.1 Improvements in Fractionation Technologies**

The techniques described later are the result of improvements in electrophoresis and gel exclusion chromatography (cf. Sect. 12.2.1).

#### ***Electrophoresis – Electrofocusing Method***

Cacco et al. (1974) proposed an improvement of the electrophoresis of humic compounds by using the electrofocusing method described by Righetti and Drysdale (1971). In this technique, humic compounds migrate from anode to cathode in a polyacrilamide gel in the presence of ampholines which cause a pH gradient. The migration stops when each compound reaches its isoelectric point. Figure 12.7 shows the results of

isoelectrophoretic characterisation (Cacco and Maggioni 1976) of fulvic and humic acids extracted with pyrophosphate at pH 7 from an alpine podzol. Rusina et al. (1983) suggested a system of calculation of molecular parameters by electrophoretic mobility in the polyacrylamide gel. Electrophoresis techniques are generally used for the study of molecular size but also of the electrical charge of humic substances (Duxbury 1989).

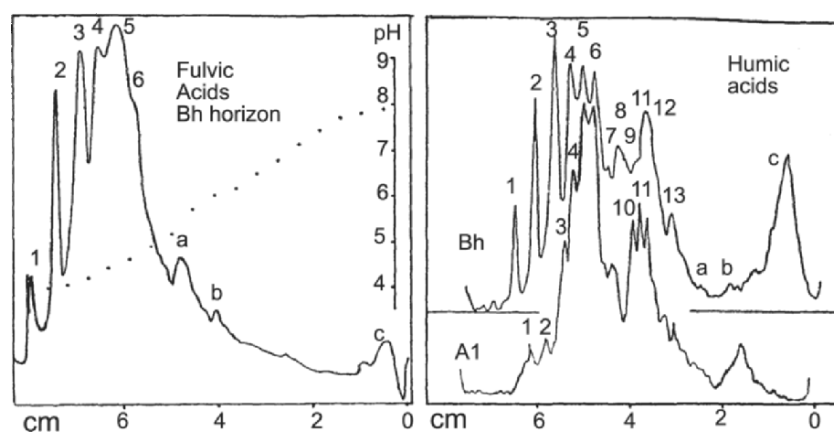

**Fig. 12.7.** Isoelectrophoretic characterization of fulvic (deep Bh horizon) and humic (surface A1 and deep Bh horizons) acids extracted from an alpine podzol (Cacco and Maggioni 1976)

### **Gel Exclusion Chromatography**

The gel can be calibrated with the molecular weights of humic acids measured jointly using other techniques. Figure 12.8 shows the calibration curves obtained by Cameron et al. (1972a) with four types of gel; the molecular weights (on the  $x$ -coordinate) were measured by a sedimentation technique using ultracentrifugation (Cameron et al. 1972b). In such studies, the gel is characterized by the  $K_{av}$  parameter suggested by Laurent and Killander (1964):

$$K_{av} = (V_R - V_0) / (V_t - V_0),$$

Where is the  $V_R$ : volume of retention,  $V_0$ : volume of pores and  $V_t$ : volume of total column.

The median values of  $K_{av}$  are adjusted to the median molecular weights  $M$  (Fig. 12.8) by means of two constants  $k_1$  and  $k_2$  according to law:

$$K_{av} = k_1 \ln M + k_2.$$

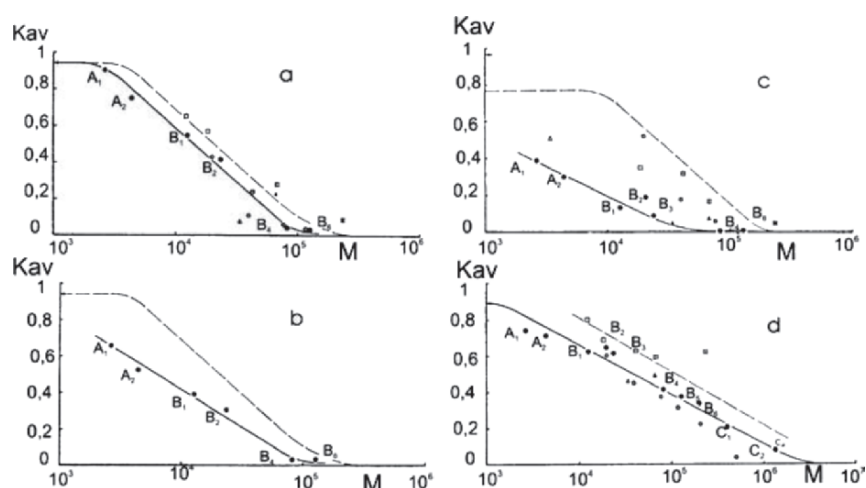

**Fig. 12.8.** Calibration of four types of gel (Cameron et al. 1972a) for the fractionation of humic acids in comparison with other macromolecular compounds (*solid lines and solid circles*: humic acids, *dotted lines and open circles*: data from the protein fractionation, sucrose is used to determine the stationary liquid volume  $V_t$ ). See text for  $K_{av}$  and  $M$ : **(a)** Sephadex G100 in tris buffer (cf. Sect. 12.2.1 for preparation), **(b)** Sephadex G100 in borax buffer (cf. Sect. 12.2.1 for preparation), **(c)** Biogel P-150 in tris buffer and **(d)** Sepharose 6B in tris buffer.

Nowadays, fractionation by gel permeation can be carried out by high pressure liquid chromatograph (HPLC) and in addition, new gels are more powerful than the older Sephadex gels. For example the “Zorbax PSM 1000” silica gel used by Morizur et al. (1984) allowed better recovery of all the organic matter with approximately 1/100 the ion exchange capacity of Sephadex gel.

Beckett et al. (1987) used a *flow field-flow fractionation (flow FFF)* technique for fulvic and humic acid fractionation, which appears to be a powerful tool to obtain information on molecular weights.

### 12.3.2 Titration of Functional Groups

Section 12.2.2 described titration techniques for the main functional groups of humic compounds, carboxylic and phenolic groups, the latter being obtained by calculating the difference between total acidity and carboxylic acidity.

Chemical titration can be used for other functional groups. The main groups that have been the subject of such investigations are:

– *Total OH groups* can be determined by acetylation of humic substances with acetic anhydride in pyridine (Schnitzer and Skinner, 1965):

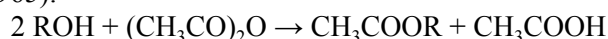

The acetylated humic substances are then carefully isolated from the reactional medium. Hydrolysis in alkaline medium releases acetates from the acetyl groups; distillation in strong acid medium enables recovery of acetic acid which is titrated by acidimetry. The number of moles of acetic acid collected corresponds to the number of total OH groups of the humic substance.

– *Alcoholic OH groups* can be estimated by “total OH groups” minus “phenolic OH groups”. However, as the phenolic OH groups are themselves calculated by difference (cf. Sect. 12.2.2), it is advisable to take the laws of propagation of errors into account.

– *Total C–O Groups* can be quantified by the reaction of humic substances with hydroxylamine chlorhydrate in 2-dimethylaminoethanol medium:

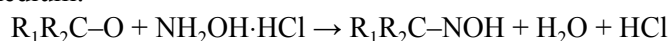

Excess hydroxylamine hydrochlorate is back titrated with a standard  $\text{HClO}_4$  solution (Fritz et al. 1959).

– *Quinonic C–O groups* can be titrated by reduction in  $\text{OH}^-$  phenolic groups by ferrous iron in triethanolamine; the excess ferrous iron is back titrated by amperometry with a dichromate solution (Glebko et al. 1970).

– *Ketonic C–O groups* can be estimated by the difference between total C–O groups and quinonic C–O groups.

In addition, Schnitzer (1978) cited several attempts to characterize acid groups by direct potentiometric titration. It was difficult to clearly distinguish the two main types of acidity (OH and  $\text{CO}_2\text{H}$  functional groups) using this method even in a non-aqueous medium. Certain authors did succeed including Rosell et al. (1972), who simultaneously measured three types of acidity by potentiometric titration in 80% *N*-methyl acetamid aqueous solution.

De Nobili et al. (1990) presented an alternative to the technique described in Sect. 12.2.2 for the determination of carboxylic groups: the precipitation of humic substances with cethyltrimethylammonium cation detergent.

### 12.3.3 Characterization by Fragmentation

One of the ways to study heavy humic macromolecules consists in splitting them up and identifying the fragments. These methods can be classified in four main groups: oxidative fragmentation, reducing fragmentation, other chemical degradation techniques and thermal fragmentation by pyrolysis.

#### ***Oxidative Fragmentation***

This group of techniques can be divided into two subgroups. (i) oxidation with permanganate and (ii) other oxidative techniques.

*Oxidation with permanganate* was widely used on humic materials from different types of soils: e.g. Ah horizons of Solonetz, Solod and Chernozem (Kahn and Schnitzer, 1971a; Kahn and Schnitzer, 1972b), forest grey soil under different farming systems (Kahn and Schnitzer, 1972b), tropical volcanic soils (Griffith and Schnitzer, 1975), mediterranean soils (Chen et al. 1978a), non-hydrolysable humic residues (Ogner, 1973) and fulvic acid fractions (Khan and Schnitzer, 1971b).

The analytical procedure varies with the author. The humic materials can first be fractionated or subjected to a derivatisation reaction (methylation) before oxidation. Kahn and Schnitzer (1971b) oxidated 1 g of humic material by boiling at reflux for 8h with 250 mL of 4%  $\text{KMnO}_4$  aqueous solution. The excess of permanganate must be destroyed by controlled addition of small volumes of methanol and the solution removed from insoluble  $\text{MnO}_2$  by filtration and rinsing. The acidified filtrate is then extracted with ethyl acetate in a liquid-liquid extractor for 48h. The extract is brought to dry in the rotary evaporator, dissolved in a small volume of methanol and methylated with a diazomethane solution in ether. The end products are then split by chromatography and identified with the usual range of spectrographic methods used for molecular characterization (UV, IR, mass and NMR spectrometry), the most widely used method being gas chromatography coupled with mass spectrometry (GC-MS).

Other oxidative reagents have been used for studies of the degradation of organic matter. Neyroud and Schnitzer (1974) then Griffith and Schnitzer (1976) studied the products of alkaline oxidation of humic and fulvic acids by cupric oxide. Oxidation is performed in an autoclave at 170°C on 1g of humic product mixed with 100 mL of NaOH 2 mol L<sup>-1</sup> solution and 5g CuO; the end of the procedure is almost the same as for permanganate oxidation (see earlier part in this section).

Other methods included nitrobenzene alkaline oxidation (Morrison 1963), nitric acid oxidation (Hansen and Schnitzer, 1967), hypohalogenite oxidation (Chakrabartty et al. 1974) and peracetic acid oxidation (Schnitzer and Skinner, 1974). Griffith and Schnitzer (1989) reviewed oxidative degradation techniques, one of the analytical tools for the study of humic substances (Hatcher et al. 2001).

### ***Reductive Fragmentation***

The most commonly used reagent was sodium amalgam (Mendez and Stevenson 1966; Stevenson and Mendez 1967; Piper and Posner 1972) but other reducers were also tested such as zinc powder (Hansen and Schnitzer 1969). Stevenson (1989) reviewed reductive fragmentation techniques.

### ***Other Degradative Chemical Methods***

Boiling humic acids in water releases polysaccharides and small quantities of phenolic acids and aldehydes, polypeptides, alkanes and fatty acids (Neyroud and Schnitzer 1975).

Acid hydrolysis at reflux boiling enables between 1/3 and 1/2 of organic matter to be dissolved in most soils (Schnitzer, 1978) but this technique was mostly widely used for the study of the organic forms of nitrogen (cf. Sect. 14.2.1 of Chap. 14); Anderson et al. (1978) studied ether-soluble products of acid hydrolysis of fulvic and humic acids.

Alkaline hydrolysis was also used as a degradation method for the study of humic molecules. Neyroud and Schnitzer (1975) subjected humic materials to four successive series of hydrolysis with a-NaOH 2N solution in an autoclave at 170°C for 3 h. The recovery and identification of the hydrolysed products was accomplished using techniques similar to those of the other degradation methods (cf. "Oxidative Fragmentation"). Parsons (1989) analysed the main fragmentation mechanisms in the acid and alkaline hydrolysis of organic materials.

A method developed for depolymerization of coals (Ouchi and Brooks 1967) was applied to degradation of humic acids (Jackson et al. 1972):

reaction with phenol in the presence of *p*-toluenesulfonic acid as catalyst. A review of degradation techniques by phenol and sodium sulphide was published by Hayes and O'Callaghan (1989). Cheshire et al. (1968) studied the effect on humic acids of alkaline fusion after acid boiling.

### **Thermal Degradation**

Thermogravimetry (TG), differential thermogravimetry (DTG), differential thermal analysis (DTA) and isothermal heating were used to explore the mechanism of thermal decomposition of humic materials (Schnitzer 1978). Schnitzer and Hoffmann (1964) studied the chemical evolution of humic and fulvic acids under the action of temperatures up to 540°C; Fig. 12.9 shows the curves of *differential thermogravimetry* these authors observed on their samples.

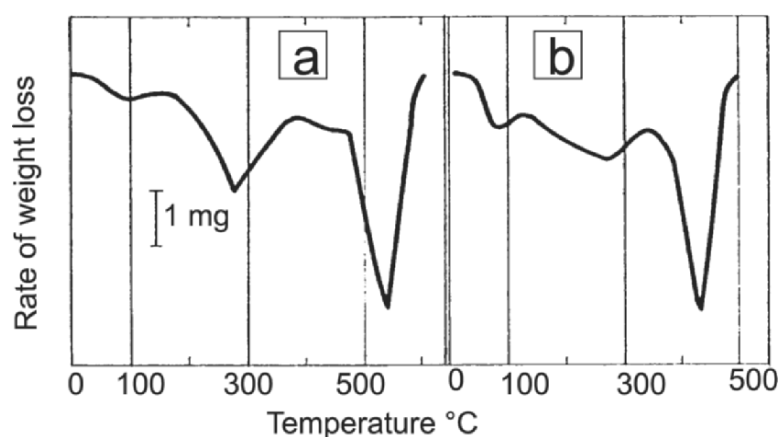

**Fig. 12.9.** Curves of differential thermogravimetry (Schnitzer and Hoffman 1964) of organic materials of a podzol: **a**: surface O<sub>2</sub> horizon, **b**: deep Bh horizon

Kodama and Schnitzer (1970) used *differential thermal analysis* in a study of the mechanism of thermal decomposition of fulvic acids. Chen et al. (1978b) also used this technique to compare the physicochemical characteristics of humic and fulvic acids of Mediterranean soils (Fig. 12.10).



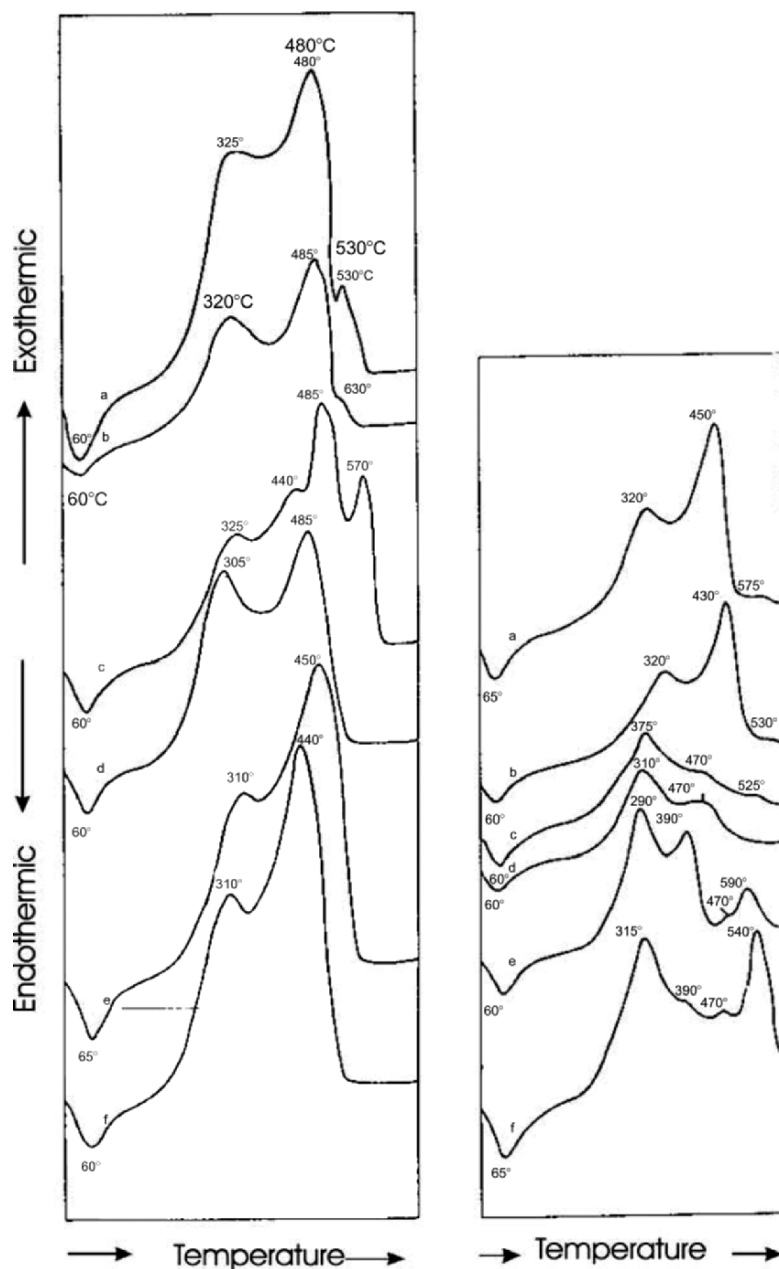

**Fig. 12.10.** Differential Thermal Analysis applied to humic (on the *left*) and fulvic (on the *right*) acids extracted from Mediterranean soils (Chen et al. 1978): **(a)** clayey brown soil, **(b)** sandy brown soil, **(c)** clayey silty sandy red soil, **(d)** sandy silty red soil, **(e)** silty sandy red soil, **(f)** sandy silty brown soil

**Fig. 12.11.** Chromatogram of pyrolysis products of a fulvic acid extracted with soda in a deep Bh horizon of a podzol (Martin, 1976)

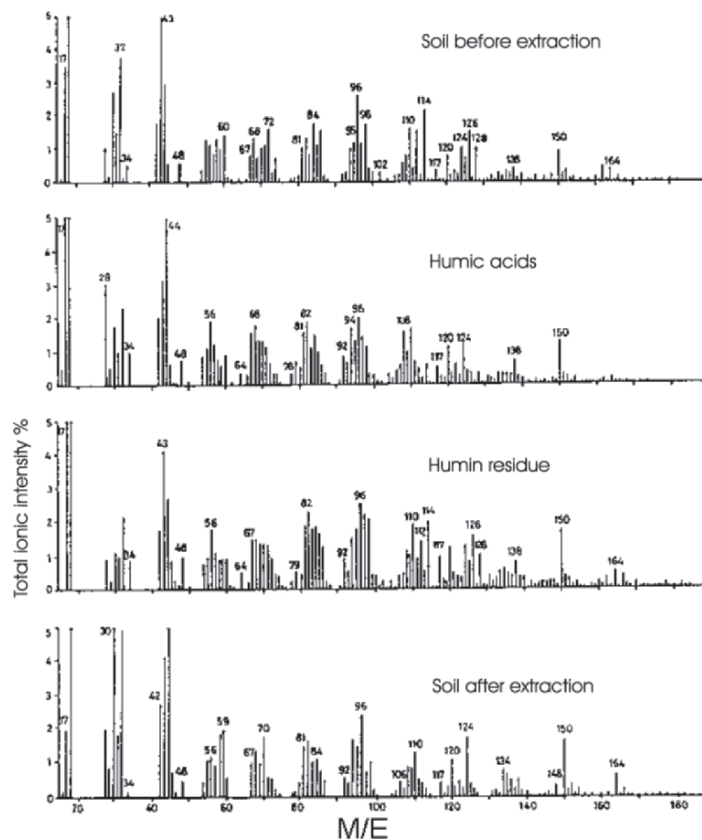
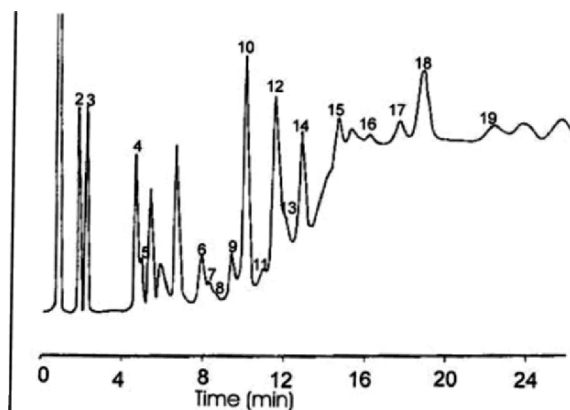

**Fig. 12.12.** Mass spectra of pyrolysis obtained by Saiz-Jimenez et al. (1979) on a sample of brown soil on granite rock (typical xerochrept); the humin residue fraction was the result of alkaline extraction of the soil following humic acid extraction and complete destruction of silicates by the HF-HCl mixture

*Pyrolysis-gas chromatography* was developed by Kimber and Searle (1970) for the study of soil organic matter. Figure 12.11 shows one of the chromatograms of pyrolysis obtained by Martin (1976) on fulvic acids of a deep Bh horizon of podzol.

The *pyrolysis mass-spectrometry* described by Meuzelaar et al. (1973) was applied to humic compounds by several authors (e.g. Meuzelaar et al. 1977 Saiz-Jimenez et al. 1979). The humic sample was dispersed in a soda solution or in methanol, covered and placed on a ferromagnetic coil and pyrolyzed at 510°C. An example of the mass spectrum of the pyrolysis products is shown in Fig. 12.12. Reviews by Bracewell et al. (1989) and Schulten (1996) give more data on the thermal degradation products of humic materials.

### 12.3.4 Nuclear Magnetic Resonance (NMR)

#### **Principle**

The majority of atomic nuclei turn around their axis and thus have an angular moment expressed by the formula  $[h/2\pi][I(I+1)]^{1/2}$  where  $h$  is the Planck constant and  $I$  the spin number. The spin number values can be 0, 1/2, 1, 3/2, 2, etc., depending on the nature of the nucleus: for  $^1\text{H}$  and  $^{13}\text{C}$ ,  $I = 1/2$ , but for  $^{12}\text{C}$ ,  $I=0$ . Because of the electric charge, the rotation of the nucleus creates a magnetic field. Conversely, if a nucleus is placed in a magnetic field  $H_0$  it can orient itself in one of the  $(2I + 1)$  directions linked to the direction of the field. Each direction corresponds to an energy state and it is possible to induce a resonance between the energy states by using electromagnetic radiation of a frequency  $\nu$  such as:

$$\nu = \gamma H_0 / 2\pi, \quad (12.1)$$

where the gyromagnetic ratio  $\gamma$  is a constant that depends on the type of nucleus.

Table 12.1 Relative detectability (RD) of a nucleus in soil organic matter by NMR (Wilson 1981)

Nucleus	RD
$^1\text{H}^a$	$10^2$
$^{27}\text{Al}$	$10^1$
$^{23}\text{Na}$	$10^0$

$^1\text{H}^{\text{b}}$	$10^0$
$^{55}\text{Mn}$	$10^{-1}$
$^{29}\text{Si}$	$10^{-1}$
$^{13}\text{C}$	$10^{-3}$
$^{14}\text{N}$	$10^{-3}$
$^{39}\text{K}$	$10^{-3}$
$^{17}\text{O}$	$10^{-3}$
$^{25}\text{Mg}$	$10^{-3}$
$^{67}\text{Zn}$	$10^{-3}$
$^{31}\text{P}$	$10^{-4}$
$^{43}\text{Ca}$	$10^{-4}$
$^{57}\text{Fe}$	$10^{-5}$
$^{15}\text{N}$	$10^{-6}$

<sup>a</sup>: very variable, depends on the water contents and the pH

<sup>b</sup>: H of soil organic matter only

The atom of hydrogen ( $I = 1/2$ ) gives  $(2I + 1) = 2$  possible orientations of the nucleus and it is possible to detect its resonance. On the other hand, most nuclei are not detectable: for  $^{12}\text{C}$ ,  $(2I + 1) = 1$  thus there is only one possible orientation of the nucleus in the magnetic field and it is not possible to induce a resonance. Only the  $^{13}\text{C}$  isotope of carbon can be studied but is much less abundant than the  $^{12}\text{C}$  isotope in the natural state.

Finally, the most important factors in measuring the detectability of an element in soil or in soil extracts are the spin number  $I$ , and the gyromagnetic ratio  $\gamma$  but also the abundance of the element ( $n$ ) and the relative abundance of the isotope under study ( $N$ ). Table 12.1 presents the detectability of atomic nuclei in soil as a function of a calculation by Wilson (1981) with the formula:  $\gamma^3NI(I+1)n$ . This table does not give the detectability of an element itself but its detectability in the soil or in a soil organic matter medium. Thus, an element that is sensitive to NMR such as  $^{31}\text{P}$  will be detected with difficulty because of its low concentration.

The traditional NMR approach consists in subjecting the sample to a radio frequency scan (continuous wave NMR), with a fixed magnetic field (or vice versa) and recording resonance when the irradiation frequency matches the frequency of nuclear transition given by (12.1). The Fourier Transform NMR often enables high quality spectra to be obtained more rapidly. In FTNMR, the nucleus is subjected to short and intense pulsation of radiation and its behaviour is observed. All the nuclei resound simultaneously and the resulting spectrum of the signal as a function of time (free induction decay, FID) is not very useful for the chemist. Signal processing by Fourier transformation should be used to obtain more easily interpretable spectra of the continuous wave NMR type. To increase sensitivity, a large number of "FID" has first to be collected on the computer and then an average used to calculate the Fourier transform.

The NMR technique would provide little useful information for structural chemistry if only the spin transition(s) of the nucleus were measured at frequencies corresponding to (12.1). In fact, the electronic environment of the nucleus protects it from the applied magnetic field ( $H_0$ ) and the real magnetic field at constant frequency (or the frequency at constant field) necessary for nuclear resonance depends on how effectively the nucleus is protected. In organic molecules, the functional groups have different electronic distributions and the frequencies of resonance of each of their nuclei shift slightly depending on the nature of the functional group. It is then possible to identify these groups. In practice, the shift in frequency is identified by comparing it to a standard, usually tetramethylsilane (TMS), in terms of chemical shift ( $\delta$ ) calculated by the ratio of the "chemical shift of frequency" compared to the "frequency of the standard". As the chemical shifts are weak,  $\delta$  are generally noted in parts per million:  $\delta(\text{ppm})$ .

Another significant parameter is *relaxation*. After the excitation of a nucleus, some time passes before it returns in its fundamental energy state. In theory, this return occurs in two ways: by interaction with the molecular lattice or by spin energy exchange with "brother" nuclei. The time constants corresponding to these two processes are named spin-lattice relaxation time and spin-spin relaxation time ( $T_1$  and  $T_2$ , respectively). This phenomenon is significant for the soil chemist. In  $^{13}\text{C}$  NMR studies, it can affect the quantitative measurement of the carbon of the functional groups.

Following the development of this technique NMR was used for the study of soil organic matter. Originally extracts were analysed in solution by studying  $^1\text{H}$  proton NMR then  $^{13}\text{C}$  NMR, first qualitatively, and then while trying to quantify the observations. The material had to be soluble in a solvent which did not give resonance to the element under study (e.g. for studies of  $^1\text{H}$ ,  $\text{D}_2\text{O}$  was used instead of  $\text{H}_2\text{O}$ ), but this is no longer indispensable (Wilson, 1981). More recent studies use NMR on the solid phase. Wilson (1981, 1987) reviewed these methods and their use for the study of soil organic matter. Steelink et al. (1989) provided complementary information in the field of  $^1\text{H}$  and  $^{13}\text{C}$  NMR of humic substances in solution. Wilson (1989) and Tate (1998) provided additional theoretical information in the field of solid state NMR and its use for humic substances. Simpson (2004) applied coupling NMR and separation techniques.  $^{15}\text{N}$  NMR was applied to the study of the nitrogen cycle (Thorn and Mikita 2000).

### ***Study of Humic Materials by $^1\text{H}$ NMR***

Schnitzer and Barton (1963) were the first to observe NMR spectra of organic extracts of soil. They used spectrometry with continuous wave scanning applied to fractions of methylated fulvic acids which provided relatively poor structural information. Subsequently, a relatively large number of authors used the same wave scanning technique  $^1\text{H}$  NMR. Lentz et al. (1977) obtained spectra of better quality with the Fourier transform technique. Wilson et al. (1978) used the techniques with Fourier transform in a high magnetic field at a very high frequency thereby further increasing the information provided by  $^1\text{H}$  NMR spectra (Fig. 12.13).

### ***Study of Humic Materials in Solution by $^{13}\text{C}$ NMR***

$^{13}\text{C}$  NMR has several advantages over  $^1\text{H}$  NMR for the structural analysis of molecules: it provides direct information on the structural skeleton, which enables observation of functional groups without protons like ketones. The carbon nucleus provides more significant chemical shifts enabling detection of finer differences in molecular structures. The signals can also include narrower peaks, and this reduces the risk of one peak concealing another. On the other hand, the disadvantage of  $^{13}\text{C}$  NMR lies in the small proportion of  $^{13}\text{C}$  isotopes (only 1.1% of carbon) leading to difficulty in detecting the signals (Wilson 1981).

For satisfactory detection, the conditions required to obtain the  $^{13}\text{C}$  spectra always have to be optimized. These spectra are almost always obtained under conditions of decoupling with protons (Proton Decoupled  $^{13}\text{C}$  NMR) which induces exaltation of  $^{13}\text{C}$  resonance (Nuclear Overhauser Enhancement NOE). The NOE and dipolar  $^{13}\text{C}$ - $^1\text{H}$  relaxation theory in the proton decoupled  $^{13}\text{C}$  NMR spectra of the macromolecules was studied by Doddrell et al. (1971).

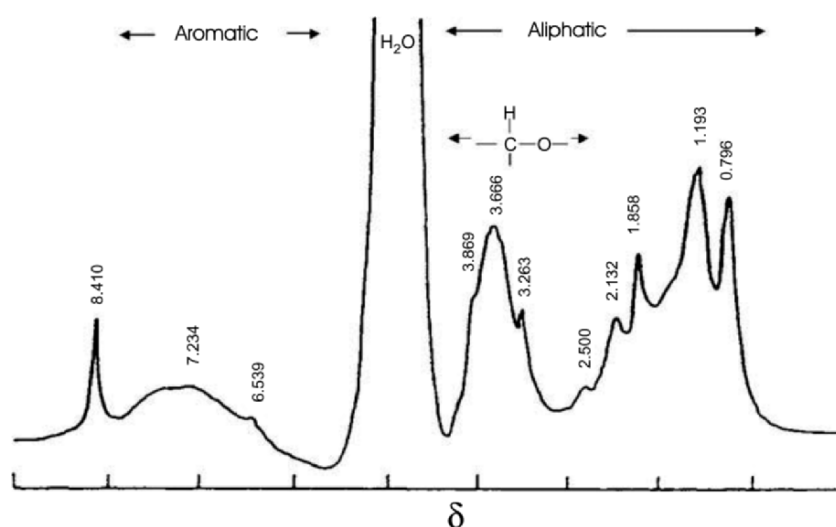

**Fig. 12.13.** Fourier transform  $^1\text{H}$  NMR spectrum obtained at 270 MHz by Wilson et al. (1978) on humic materials extracted by a  $0.1 \text{ mol (NaOH) L}^{-1}$  solution on a silty potter's clay from Wakanui. A pulsation of  $10 \mu\text{s}$  with an inclination angle of  $85^\circ$  was used to visualize a spectral window of 3.6 kHz in 8 ko of data points.

The use of these techniques for soil organic materials was initially unsuccessful (Schnitzer and Neyroud 1974). Subsequently several authors tried to improve the technique, and Newman et al. (1980) achieved noticeable improvement in the quality of the spectra (Fig. 12.14) by optimizing the operating conditions, particularly the spacing between the radiation pulsations. The optimum interval of 0.2 s also corresponded to the acquisition time of the relaxation signals coming from  $2 \cdot 10^5$   $90^\circ$  impulses of  $23 \mu\text{s}$ . The spectra were obtained on an Varian FT-80A apparatus operating at 20 MHz for  $^{13}\text{C}$  with proton decoupling at 80 MHz. Acquisition required collection of 4,000 (coal samples) to 136,000 (soil humic acid samples) free induction decay spectra then multiplication by a filter with a 20 ms time constant, before the Fourier transform. The samples were prepared for analysis by suspension of 300 mg of humic

acid in 2 cm<sup>3</sup> of 0.5 mol (NaOH) L<sup>-1</sup> solution for 1 day at 20°C followed by ultracentrifugation (84,500 g at 4°C). After dilution to 50% with D<sub>2</sub>O, RM<sup>-13</sup>C was measured in tubes with a diameter of 10 mm.

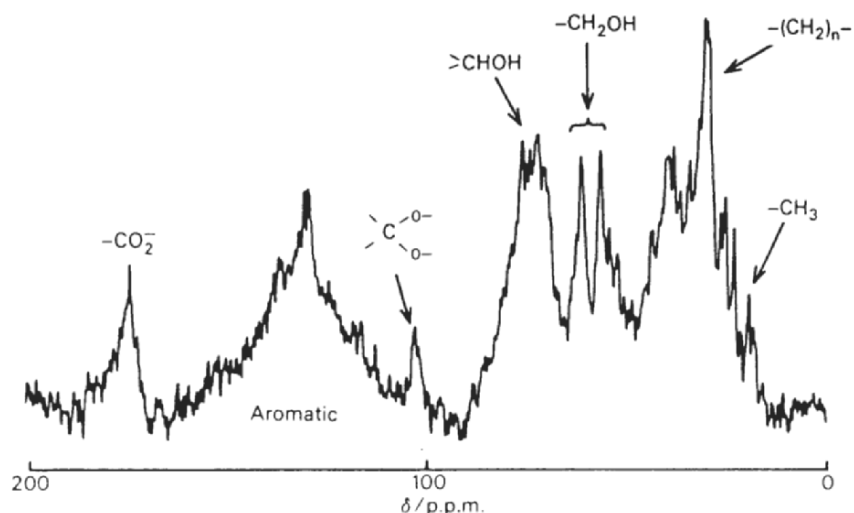

**Fig. 12.14.** Proton decoupled <sup>13</sup>C NMR spectrum of a humic acid in solution obtained by Newman et al. (1980) with optimized acquisition parameters (see conditions described in the text)

Newman and Tate (1984) used very similar conditions to those described above to characterize the humic substances of alkaline extracts of soils, the total time needed for spectral acquisition ranged from 10 to 50 h.

Preston and Schnitzer (1984) studied the effect of the type of extraction (acid or alkaline extraction) and of chemical modifications in the extracted material (methylation, hydrolysis using 6 mol (HCl) L<sup>-1</sup> followed or not by methylation) on <sup>13</sup>C NMR spectra of humic materials from four types of soils. The materials were dissolved in deuterated solvents (CDCl<sub>3</sub> for methylated materials, 0.5 mol (NaOD) L<sup>-1</sup> (D<sub>2</sub>O) solution for non-methylated materials). The chemical shifts were measured compared to the sodium 3-trimethylsilylpropionate (TSP) for the heavy water (D<sub>2</sub>O) solutions and with tetramethylsilane (TMS) for the deuterated chloroform (CDCl<sub>3</sub>) solutions. The spectra were obtained on a Bruker WM 250 spectrometer on 10 mm sample tubes with an interruption technique of <sup>1</sup>H decoupling except during the acquisition time (inverse-gated decoupling of Freeman et al. 1972). Some of spectra were comparable with those shown in Figure 12.14.



### ***Study by Solid State $^{13}\text{C}$ NMR***

The extraction of organic matter (cf. Sect. 11.2.1 and 11.3.1 of Chap. 11) can result in molecular modifications, particularly if strong bases are used as extraction reagents. Moreover, most materials remain in a non-extractable state in the humin residue. The in situ study of organic matter allows these disadvantages to be overcome.

However, conventional NMR spectroscopy applied to whole soil resulted in only broad and diffuse signals: many dipole–dipole interactions produced signals comprising information on the chemical shifts that was not clear, and moreover, the spin–lattice relaxation times ( $T_1$ ) needed too long to accumulate the free induction decay signals required to obtain quantitative information. The theoretical advance in NMR technique (Pines et al. 1973) subsequently made it possible to overcome the problem and envisage new developments. In the cross polarization or CP- $^{13}\text{C}$  NMR technique, the protons are uncoupled from the  $^{13}\text{C}$  nucleus and used to increase the relaxation kinetics of the  $^{13}\text{C}$  nucleus. The signal peak widths can be reduced to a degree where the functional groups can be partially identified.

However, the detection of the carbon forms in the whole soil using the CP- $^{13}\text{C}$  NMR method required very organic soils (6% of C according to Wilson 1981). This limit has gradually been reduced thanks to improvements in the quality of the instruments and also the preliminary use of physical fractionation methods such as those described in Chap. 9, spectral analysis being limited to the most organic fractions (Barron et al. 1980).

The magic angle spinning (MAS) NMR technique, which was originally described by Lowe (1959) and subsequently applied to polymers by Schaefer and Stejskal (1976), can also help get round problems like spectral resolution, and obtain spectra directly on the soils; in this technique, the sample is put in fast rotation at an axial slope of  $54^\circ 44'$ , which means anisotropic effects can be reduced and isotropic shifts can be selected. This technique is often used together with cross polarization, and is then known as the CPMAS- $^{13}\text{C}$  NMR method.

For soil studies, most authors preferred to apply NMR techniques to previously concentrated humic materials, usually humic or fulvic acids. A study by Newman et al. (1980) clearly showed the difference in resolution that still existed between the  $^{13}\text{C}$  NMR techniques in solution and CP  $^{13}\text{C}$  NMR on the solid phase (Fig. 12.15a).

Thanks to improvements in this technique, the spectra of CPMAS-<sup>13</sup>C NMR obtained by Gerasimowicz and Byler (1985) on humic substances showed a better resolution (Fig. 12.15b) than that of Newman et al. (1980). Fründ and Lüdemann (1989) performed instructive comparisons between the technique in solution and CPMAS-<sup>13</sup>C NMR which showed that the degree of detail provided by the second technique was similar to that of the first; in addition, the spectra obtained on a rendzina soil (4.6% of carbon) and on its humic extracts and humin residue were compared under satisfactory conditions (Fig. 12.15c). The two techniques (liquid phase NMR and solid phase CPMAS-<sup>13</sup>C NMR) were recommended by Conte et al. (1997a) for the study of organic materials of the soils. State-of-the-art CPMAS-<sup>13</sup>C NMR allows observation of organic materials in their environment (without fractionation) when the soils are not too low in carbon, as attempted by Kinchesh et al. (1995) on Rothamsted soils (UK). Other studies such as that of Conte et al. (1997b) on volcanic soils used CPMAS-<sup>13</sup>C NMR on extracted humic substances.

### 3.4.5 Quantification of Observations by NMR

Different techniques exist for the quantification of the information provided by the NMR signals of humic substances. The oldest derive from the study of coal and coal-like materials.

The method of Brown and Ladner (1960) enables estimation of the aromaticity of these carbonaceous materials using the <sup>1</sup>H NMR spectrum. Wilson (1981) proposed an adaptation of this method for use on humic materials.

The rate of aromaticity  $f_a$  was most often studied by quantification of <sup>13</sup>C NMR signals. However, techniques for the direct quantification of the different peaks of the spectra should be used with caution. The <sup>13</sup>C atoms of the different functional groups have different nuclei relaxation times, the nuclei with the shortest times making a weaker contribution to the total spectrum than those with the longest time. In addition, due to proton decoupling, NOE results in an increase in the signal that differs with the nature of the nucleus (Wilson 1981). However, these two factors were sometimes shown to have no significant influence on the direct measurement of the rate of aromaticity (Newman et al. 1980).

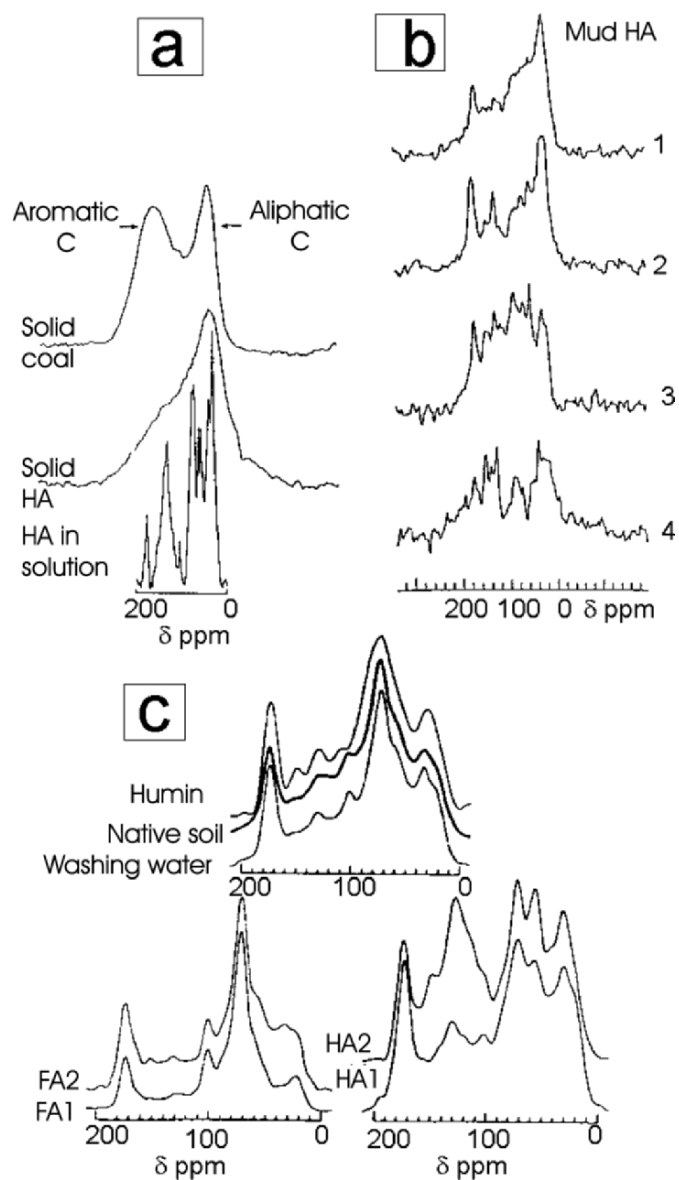

**Fig. 12.15** Improvements in solid phase  $^{13}\text{C}$  NMR techniques: **(a)** CP  $^{13}\text{C}$  NMR spectra obtained by Newman et al. (1980) on solid coal, a solid humic acid (HA), and a solution of HA, **(b)** CPMAS- $^{13}\text{C}$  NMR spectra obtained by Gerasimowicz and Byler (1985) on HA from muds at different stages of composting treatments **(c)** CPMAS- $^{13}\text{C}$  NMR spectra obtained by Früd and Lüdemann (1989) on a rendzina soil, on its fulvic (FA) and humic (HA) extracts and on the humin residue

Fründ and Lüdeman (1989) improved quantitative analysis of humic materials. Their method enabled simultaneous measurements of carboxylic-, aromatic-, carbohydrate- and aliphatic-C rates. Smernik and Oades (2000a) highlighted the effect of paramagnetic impurities and of purifications by HF treatment (Smernik and Oades, 2000b). Smernik and Oades (2003) then Moser and Lefebvre (2004) explored new ways to improve  $^{13}\text{C}$  NMR quantification on soil organic matter. Conte et al. (2004) reviewed state-of-the-art CPMAS  $^{13}\text{C}$ -NMR spectroscopy applied to natural organic matter.

### 12.3.5 Fluorescence Spectroscopy

Although less widely used than the visible UV (cf. Sect. 12.2.3) or infrared (cf. Sect. 12.2.4) absorption spectrometry, fluorescence spectrometry has been tested by several authors as a complementary technique to characterize humic substances.

Lévesque (1972) used this technique on Fe and P humic complexes. The emission spectrum of a fulvic acid has a main peak with a not very variable wavelength that moves from 500 to 520 nm when the excitation wavelength moves from 400 to 468 nm. As emission spectra generally provide little information, excitation spectra were used instead. The emission wavelength was then fixed at around 500–520 nm and excitation varied in a continuous way between 250 and 500 nm.

Ghosh and Schnitzer (1980a) observed on their humic substances two quite distinct excitation bands, at 465 and 360 nm, and a decrease in intensity of the fluorescence with an increase in the ionic force and a reduction in the pH; their data were subsequently used to calculate the constant of dissociation of humic acids (Goldberg et al. 1987).

Bachelier (1981) refined these observations with a precise description of the excitation spectra on a larger number of soils; he noted the presence of seven peaks (including two rare ones) corresponding to slope changes on the large 465 nm peak and of two peaks (including one rare one) on the large 360 nm peak.

Bachelier also studied the fluorescence of several types of humic acids split on G25 Sephadex gel (1) humic acids of high molecular weight which are eluted at the head of the column (coarse humic acid cHA) give a weak fluorescent signal; (2) the following band of less condensed brown-yellow humic acids gives bright yellow fluorescence under UV radiation (fluorescent humic acids fHA); (3) lower fluorescence compounds called higher humic acids (hHA) are sometimes found after this band and (4) intermediate humic acids (iHA) are sometimes found

between the two cHA and fHA bands. Figure 12.16 shows some excitation spectra obtained on different humic products. Bachelier's observations confirm those of Lévesque on the low fluorescence of the humic complexes with high molecular weight.

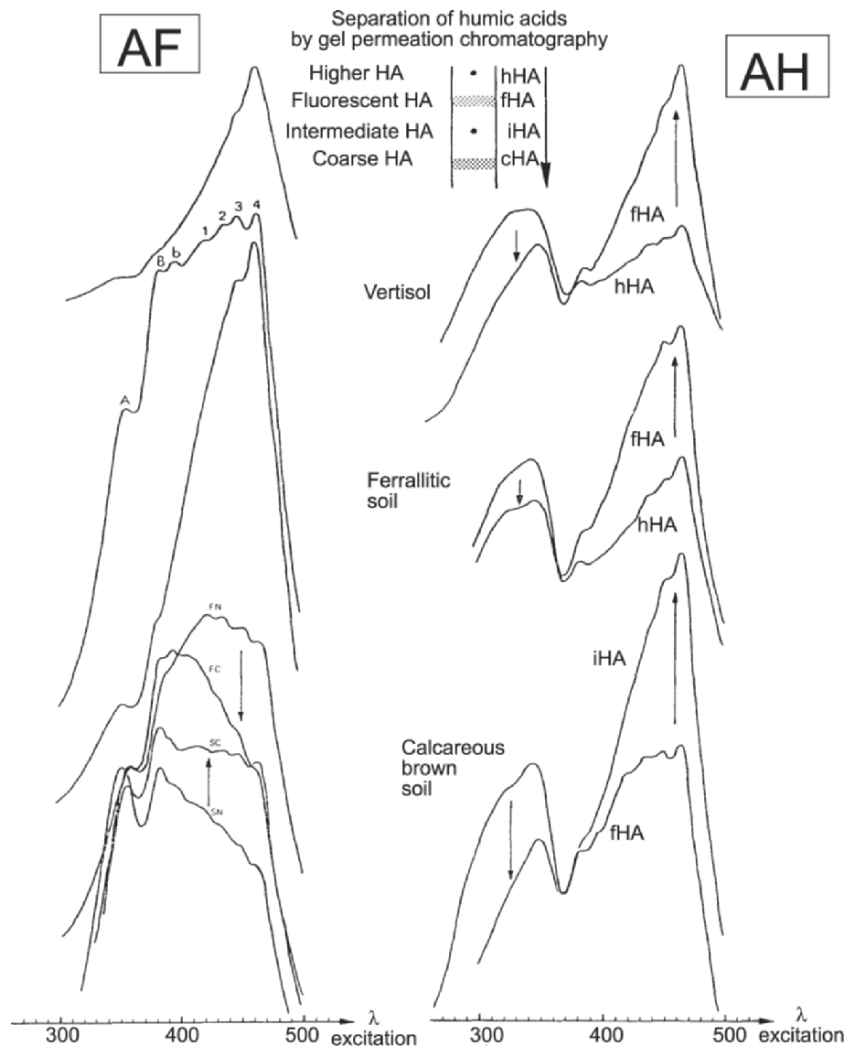

**Fig. 12.16.** Fluorescence excitation spectra of humic materials observed in the 509–515 nm emission band (Bachelier, 1981): (FA) fulvic acid of various samples of soils, (HA) different fractions of humic acids separated by gel chromatography (see fractionation diagram above the graph)

Bachelier (1984) used fluorescence spectrometry to distinguish the degrees of condensation of humic acids. Nayak et al. (1985) studied the fluorescence of humic acids in different solvents. The fluorescence polarization technique enabled further information to be obtained on the aggregation and conformation of humic molecules and was used to this end in a study of fulvic acid by Lapen and Seitz (1982).

### 12.3.6 Electron Spin Resonance (ESR) Spectroscopy

When molecules containing unpaired electrons are placed in a magnetic field, interaction occurs between the magnetic moment of these electrons and the applied field which results in decoupling into two discrete states of energy of each unpaired electron. This is electron spin resonance (ESR) sometimes still called electron paramagnetic resonance (EPR). ESR spectroscopy uses electromagnetic excitation radiation located in the spectral field of microwaves; it is used for the study of compounds containing unpaired electrons, primarily free radicals.

The energy of an unpaired electron in a magnetic field is given by

$$E = -g \beta M_z H_0,$$

where  $G$  represents the spectroscopic split factor which has a value of 2.0023 for a free electron,  $\beta$  the magneton of Bohr,  $M_z$  the component of the angular spin moment in the direction of the  $z$ -axis of the applied magnetic field which can take the discrete values  $+1/2$  and  $-1/2$ ,  $H_0$  the force of the magnetic field. For a given value of  $H_0$  the difference in energy  $\Delta E$  between two states of discrete spin of the electron is

$$\Delta E = g \beta H_0$$

the phenomenon of resonance occurs when this energy is equal to that of the applied field:

$$\Delta E = h \nu$$

and  $h$  being Planck's constant and  $\nu$  the frequency.

In his pioneer work, Rex (1960) used ESR spectroscopy to highlight the radical nature of humic molecules. MacCarthy and Rice (1985) listed several works reporting the use of ESR spectroscopy for humic substances. The spectra of humic substances are generally simple signals identified by their position and width (Fig. 12.17). The hyperfine lines that can be identified in some molecules are not usually present in humic spectra.

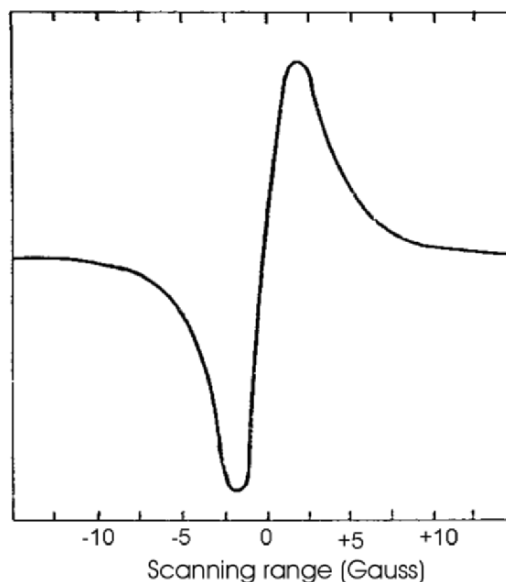

**Fig. 12.17** Electron spin resonance spectrum of a fulvic acid (Schnitzer and Skinner, 1969)

Schnitzer and Skinner (1969) showed on ten humic materials that the most variable parameter deduced from these spectra is the spin concentration. This is determined by comparison with a standard of calibration, the number of radicals being proportional to the signal surface. In humic substances, the concentration is found around  $10^{18}$  spins  $\text{g}^{-1}$ . Schnitzer and Skinner also tested the influence of several factors on the spin concentrations of humic substances (chemical modifications, heating) as well as the relation between other parameters and the spin concentration (molecular weight, E4:E6 ratio, number of molecules of a given weight per free radical). Riffaldi and Schnitzer (1972) studied the effect of the experimental conditions on the ESR spectra of humic substances to highlight mistakes due to too rapid interpretation of these spectra. MacCarty and Rice (1985) also commented on the relative poverty of the information from ESR spectrometry for the study from the humic substance. However, subsequent technological developments changed this situation. For example, Senesi et al. (1989) provided more detailed spectra than previous authors and Senesi (1990) reviewed state-of-the-art and potential development of ESR technique in its application to soil chemistry. Saab and Martin-Neto (2004) studied semiquinone free radicals of humic substances by ESR.

### 12.3.7 Measurements of molecular weight and molecular size

#### *Principles*

Measurement of molecular weight is a traditional procedure in structural chemistry. As a complement to ultimate analysis, the molecular weight provides an empirical formula for the compound concerned before the determination of the structural formula (functional groups) using spectroscopic and chemical methods. The measurement of molecular weight and size has been attempted many times on humic substances and several reviews have been devoted to the subject (e.g. Orlov et al. 1975; Stevenson 1982; Wershaw and Aiken 1985; Buurman 2001). It has also been used to measure the humic substances of water (Yu-Ping Chin et al. 1994, Yamada et al. 2000) or atmosphere (Samburova et al. 2005) However, the results differed considerably firstly depending on the technique used, and secondly because, as emphasised by the authors of these reviews, humic substances are not discrete chemical entities but complex mixtures of polydisperse organic substances with a wide range of molecular size.

The problem with measuring the molecular weight of mixtures nevertheless was studied during many years. In 1935 Lansing and Kraemer pointed out that the most commonly used methods resulted in *average molecular weights* and that, depending on the method of measurement used, these average weights could not always be compared. Three types of average molecular weights corresponding to three types of measurement are now used:

#### *Number-Average Molecular Weight $M_n$*

This is obtained using methods that measure the number of molecules (generally in a diluted solution) irrespective of their size. It is expressed by:

$$M_n = \sum n_i M_i / \sum n_i,$$

where  $n_i$  is the number of molecules of molecular weight  $M_i$   $M_n$  is determined by all measurements corresponding to a thermodynamic property connected to a number of molecules in solution (colligative



property): lowering of vapour pressure, lowering of the freezing point, rise in the boiling point (Raoult laws), osmotic pressure.

### *Weight-Average Molecular Weight $M_w$*

Weight-average molecular weight is measured by methods concerned with the masses of different materials, like light scattering and ultracentrifuge sedimentation; it is expressed by:

$$M_w = \frac{\sum w_i M_i}{\sum w_i} = \frac{\sum n_i M_i^2}{\sum n_i M_i},$$

where  $w_i$  represents the mass fraction of each species;

### *The z-Average Molecular Weight $M_z$*

This can also be calculated with the ultracentrifugation data obtained and is expressed by:

$$M_z = \frac{\sum w_i M_i^2}{\sum w_i M_i} = \frac{\sum n_i M_i^3}{\sum n_i M_i^2}.$$

In a monodisperse system  $M_n = M_w = M_z$  but this is not the case in polydisperse systems; the number-average molecular weight then tends to represent the lowest molecular weights whereas  $M_w$  tends to represent the heaviest particles of the mixture (Wershaw and Aiken, 1985). Orlov et al. (1975) expected  $M_w$  to be better correlated with the known properties of humic substances. In heterogeneous systems,  $M_z > M_w > M_n$ , the  $M_w:M_n$  ratio can generally be used to calculate the degree of polydispersity (Stevenson 1982).

In addition to methods for the measurement of the average molecular weight, another group of methods measures the size of the molecules, e.g. gel filtration, ultrafiltration and small angle X-ray scattering. In these methods, model compounds of known molecular weight and composition are used to determine the molecular weight of humic substances, but problems can occur if these compounds are too different from the humic molecules (Wershaw and Aiken 1985).

## ***Methods for the Measurement of Molecular Size***

### *Gel Exclusion Chromatography*

The methods of gel exclusion (or gel permeation) chromatography are described in Sect. 12.2.1 and 12.3.1. It should be noted that Reuter and Perdue (1981) found a very big difference between the expected molecular weights on humic fractions of Sephadex gel and the number-average molecular weights actually measured. Plechanov (1983) used the

Sephadex LH60/dimethylformamide/acetic acid system for the measurement of the molecular weight of humic substances. Nobili et al. (1989) reviewed the use of gel chromatography for the measurement of the molecular size of humic substances.

### *Ultrafiltration*

Ultrafiltration by pressure filtration through a membrane is also used for the separation of macromolecules as a function of their molecular size. This technique is similar to reverse osmosis, except with respect to the size of the particles that can be split: reverse osmosis separates the particles of molecular size near to those of the solvent whereas ultrafiltration separates particles approximately 10 times the size of the solvent i.e. up to 0.5  $\mu\text{m}$  (Wershaw and Aiken 1985). A large number of different types of membranes exist which are classified by their manufacturers according to their threshold of cut expressed in molecular weight. Nevertheless ultrafiltration is not a technique for separation by weight but by molecular size. A review by Wershaw and Aiken (1985) provided a lot of useful information about this technique.

### *Scattering of Electromagnetic Radiation*

The principle of this technique for light scattering was described by Kerker and Milton (1968) and by Guinier and Fournet (1955) for small angle X-ray scattering. The reader is advised to consult these publications for a comprehensive explanation of the phenomenon and to refer to Wershaw and Aiken (1985) and Wershaw (1989) for the use of this technique for humic substances.

## ***Methods of Measurement of Molecular Weight***

### *Determination of the Number-Average Molecular Weight by Measurement of Colligative Properties*

By definition, a colligative property is a thermodynamic property which depends on the number of particles in a solution independent of their nature. At the infinite dilution limit, each one of these properties is proportional to the number of molecules of solute present in the solution. The classical theory of each colligative property is described found in all chemistry and physics handbooks. The most widely used techniques for the measurement of molecular weight of humic substances are cryoscopy and vapour pressure osmometry. Cryoscopy records the drop in the temperature during solidification of the solvent in the presence of the solute to be studied. Vapour pressure osmometry measures the change in osmotic pressure resulting from the passage of a solvent through a

membrane from a diluted solution to more concentrated one. For a description of these methods and their use for humic substances, see Stevenson (1982), Wershaw and Aiken (1985) and Aiken and Gillam (1989).

### *Ultracentrifugation*

There are two distinct groups of ultracentrifugation techniques, those concerned with sedimentation kinetics, and those concerned with ultracentrifugation equilibrium. The first group was the most commonly used on humic substances (Wershaw and Aiken 1985) sometimes as a complement to other fractionation methods (Cameron et al. 1972b), although the centrifugation equilibrium provides a wealth of information since  $M_n$ ,  $M_w$  and  $M_z$  can be determined at the same time (Posner and Creeth 1972). The theory and implementation of the first technique is detailed in Cameron et al. (1972b), the second by Posner and Creeth (1972), and a review by Swift (1989) gives a detailed description of all ultracentrifugation techniques.

### *Viscosimetry*

Measurements of viscosity can provide significant information concerning the size and the shape of the molecules. The well-known Oswald viscometer records the times of passage of the solution and solvent between two reference points marked on the apparatus. The molecular weight can be estimated from measurements of viscosity using the Staudinger equation:  $[\eta] = kM^\alpha$ , in which intrinsic viscosity  $\eta$  is linked to molecular weight  $M$  by two adjustable parameters (Ghosh and Schnitzer, 1980b). Techniques based on measurement of viscosity were reviewed by Clapp et al. (1989).

*Flow FFF* (cf. Sect. 12.3.1) was also once considered to be promising for the measurement of molecular weight of humic substances (Beckett et al. 1987).

## **12.3.8 Microscopic Observations**

Several studies report observations of humic materials using optical microscopy, transmission electron microscopy and scanning electron microscopy. The first difficulty is linked with the different ways the sample can be modified depending on the preparation techniques (e.g. the degree of separation of inorganic materials, molecular modifications with respect to the ionic force and pH), and the second difficulty is the conditions of the observation itself (heating of the sample). Bachelier (1983) carried out observations on nine different types of soil using three

techniques: frozen humic acid solutions under a binocular magnifying glass, desiccated humic acid solutions under a transmission electron microscope, humic acid solutions freeze-dried on gilt aluminium film under a scanning electron microscope. The latter requires metallization of the non-conducting substances before observation.

Chen and Schnitzer (1976) studied the influence of pH on the appearance of humic acids by scanning electron microscopy while Stevenson and Schnitzer (1982) studied the same effect by transmission electron microscopy. Chen and Schnitzer (1976) used transmission electron microscopy for the study of metallic complexes of fulvic acids.

Scanning electron microscopy was used by Chen et al. (1978) for the comparison of humic acids from Mediterranean soils. Tan (1985) provided detailed methodological information particularly concerning the preparation of the samples.

### 12.3.9 Other Techniques

The main techniques used for structural characterization are described in this chapter. However other techniques can also be used to improve our knowledge of the structures of humic compounds and their linkage with mineral materials.

X-ray techniques are not limited to small angle X-ray scattering described in "Scattering of Electromagnetic Radiation" in Sect. 12.3.7; X-ray diffraction was also used by Schnitzer (1978), and can provide useful information in spite of the non-crystalline character of humic substances.

As far as electrochemical methods are concerned, a study of humic acid characterization by polarography was described by Shinozuka and Hayano (1987).

The use of FTIR spectroscopy makes it possible to increase the resolution and to decrease the background noise of the IR spectra. However, these advantages may not be apparent in the study of humic substances because of their molecular nature (MacCarthy and Rice, 1985).

More recent techniques like X-ray photoelectron spectroscopy (XPS) and Mössbauer spectroscopy have not been widely used for the study of humic substances. XPS, also called electron spectroscopy for chemical analysis (ESCA), can only be used with solid materials because it requires a high vacuum; it is based on the analysis of the electrons emitted by the internal electron-shells atoms when they are subjected to X-ray bombardment of sufficient energy; Defosse and Rouxhet (1980) introduced this technique in soil analysis.

Mössbauer spectroscopy is not directly useable for the study of the structure of metal compounds, but can be used for the study of organometallic bonds, and particularly for the study of complexes of iron–humic compounds (Goodman and Cheshire, 1979).

It will be interesting to see whether future progress results from new technologies or from synthetic studies on molecular models as was the case for the identification of the double helix of ADN by Watson and Creek.

## References

### Molecular Models

- Hatcher PG, Dria KJ, Sunghwan Kim, Frazier SW (2001) Modern analytical studies of humic substances. *Soil Science*, 166, 770–794
- Lawson GJ and Stewart D (1989) Coal Humic Acids. In *Humic substances II, search of structure*, Hayes HB., MacCarthy P, Malcolm RL and Swift RS ed., Wiley, 641–686
- Lodygin ED and Beznosikov VA (2003) The  $^{13}\text{C}$  NMR study of the molecular structure of humus acids from podzolic and bog-podzolic soils. *Pochvovedenie*, 9, 1085–1094
- Piccolo A and Conte P (2003) Comments on “Modern analytical studies of humic substances” by Hatcher et al. *Soil Sci.*, 168, 73–74
- Schulten HR (1995) The three-dimensional structure of humic substances and soil organic matter studied by computational analytical chemistry. *Fresenius J. Anal. Chem.*, 351, 62–73
- Schulten HR and Leinweber P (2000) New insights into organic-mineral particles: composition, properties and models of molecular structure. *Biol. Fertil. Soils*, 30, 399–432
- Schulten HR and Schnitzer M (1997) Chemical model structures for soil organic matter and soils. *Soil Sci.*, 162, 115–129
- Skjemstad JO, Clarke P, Taylor JA, Oades JM and McClure SG (1996) The chemistry and nature of protected carbon in soil. *Aust. J. Soil Res.*, 34, 251–271
- Schulten HR (2002) New approaches to the molecular structure and properties of soil organic matter: humic-, xenobiotic-, biological-, and mineral-bonds. In 3rd Symposium on Soil Mineral–Organic Matter–Microorganism Interactions and Ecosystem Health, Naples-Capri, Italy, 22–26 May 2000, Violante A, Huang PM, Bollag JM and Gianfreda L. ed. *Developments in soil science*, volume 28A, 351–381

- McCarthy P (2001) The principles of humic substances. *Soil Sci.*, 166, 738–751
- Piccolo A, Celano G, Conte P, Zena A and Spacini R (1999) Adsorption of atrazine on humic substances of different molecular structure and their hydrolysed products as modified by pH. In *Human and environmental exposure to xenobiotics* Del Re AAM, Brown CD, Capri E, Evans SP and Trevisan M, ed., *Proceedings of the XI Symposium of Pesticide Chemistry, Cremona, Italy*, September 12–15 1999, 425–431

### Fractionation, Determination of Molecular Weights and Molecular Sizes

- Aiken GR and Gillam AH (1989) Determination of molecular weights of humic substances by colligative property measurements. In : *Humic substances II.*, Hayes MHB., MacCarthy P, Malcolm RL and Swift RS ed. Wiley New York, 515–544
- Bailly JR and Margulis H (1968) Etude de quelques acides humiques sur gel de dextrane. *Plant and soil*, XXIX, 343–361
- Bailly JR and Tittone E (1972) Etude de quelques acides humiques sur gel de dextrane (II). *Plant Soil*, 37, 57–80
- Beckett R, Zhang Jue and Giddings JC (1987) Determination of molecular weight distributions of fulvic and humic acids using flow field-flow fractionation. *Environ. Sci. Technol.*, 21, 289–295
- Buurman P (2001) Understanding humic substances: advanced methods, properties and applications. *Soil Sci.*, 166, 950–951
- Cacco G and Maggioni A (1976) Isoelectrophoretic characterization of humic and fulvic acids extracted from an alpine podzol. *Agrochimica*, 20, 20–28
- Cacco G, Maggioni A and Ferrari G (1974) Electrofocusing : a new method for characterization of soil humic matter. *Soil Biol.Biochem.*, 6, 145–148
- Cameron RS, Swift RS, Thornton BK and Posner AM (1972a) Calibration of gel permeation chromatography materials for use with humic acid. *J. Soil Sci.*, 23, 343–349
- Cameron RS, Thornton BK, Swift RS and Posner AM (1972b) Molecular weight and shape of humic acid from sedimentation and diffusion measurements on fractionated extracts. *J. Soil Sci.*, 23, –342
- Clapp CE, Emerson WW and Olness AE (1989) Sizes and shapes of humic substances by viscosity measurements. In : *Humic substances II.*, Hayes MHB, MacCarthy P, Malcolm RL and Swift RS ed. Wiley New York, 497–514
- Dabin B (1980) Les matières organiques dans les sols tropicaux normalement drainés. *Cah.ORSTOM sér.Pédol.*, 18, 197–215
- Dabin B and Thomann Ch (1970) Etude comparative de deux méthodes de fractionnement des composés humiques (méthode Tiurin et méthode électrophorétique). *ORSTOM ser. Initiation-documentation technique No.16*, 66 p

- Duchaufour Ph and Jacquin F (1963) Recherches d'une méthode d'extraction et de fractionnement des composés humiques contrôlés par électrophorèse. *Ann. Agron.*, 19, 6
- Duchaufour Ph and Jacquin F (1966) Nouvelles recherches sur l'extraction et le fractionnement des composés humiques. *Bull. ENSAN*, VIII, 1, 3–24
- Duchaufour Ph (1954) Propriétés des complexes humiques dans différents types de sols. *Ecole Nationale eaux et forêts*, Nancy, 29 p
- Duchaufour Ph (1956) Pédologie: Applications forestières et agricoles. *Ecole Nationale eaux et forêts*, Nancy, 310 p
- Duchaufour Ph (1957) Pédologie: tableaux descriptifs et analytiques des sols. *Ecole Nationale eaux et forêts*, Nancy, 87 p
- Duxbury JM (1989) Studies of the molecular size and charge of humic substances by electrophoresis. In: *Humic substances II.*, Hayes MHB, MacCarthy P, Malcolm RL and Swift RS ed. Wiley New York, 593–620
- Ghosh K and Schnitzer M (1980b) Macromolecular structures of humic substances. *Soil Sci.*, 129, 266–276
- Guinier A and Fournet G (1955) *Small angle X-ray scattering.*, Wiley New York, 268 p
- Kerker and Milton (1968) Light scattering. *Ind. Eng. Chem.*, 60, 31–46
- Lansing WD and Kraemer EO (1935) Molecular weight analysis of mixtures by sedimentation equilibrium in the Svedberg ultracentrifuge. *J. Am. Chem. Soc.*, 57, 1369–1377
- Laurent TC and Killander J (1964) A theory of gel filtration and its experimental verification. *J. Chromatog.*, 14, 317–330
- Morizur JP, Monegier du Sorbier B, Silly L and Desbene PL (1984) Etude par chromatographie sur gel avec détection spectrométrique de l'évolution de la conformation des acides humiques en fonction de la force ionique et du pH. *C. R. Acad. Sc. Paris*, 299, 1269–1272
- Nobili Maria De, Gjessing E and Sequi P (1989) Sizes and shapes of humic substances by gel chromatography. In: *Humic substances II.*, Hayes MHB, MacCarthy P, Malcolm RL and Swift RS ed. Wiley New York, 561–591
- Orlov DS, Ammosova YaM, Glebova GI (1975) Molecular parameters of humic acids. *Geoderma*, 13, 211–229
- Plechanov N (1983) Studies of molecular weight distributions of fulvic and humic acids by gel permeation chromatography. Examination of the solute molecular composition using RI, UV, Fluorescence and weight measurement as detection techniques. *Org. Geochem.*, 5, 143–149
- Posner AM and Creeth JM (1972) A study of humic acids by equilibrium ultracentrifugation. *J. Soil Sci.*, 23, 333–341
- Ratsimbazafy CA (1973) Protocole de fractionnement et d'étude de la matière organique des sols hydromorphes de Madagascar. *Cah. ORSTOM sér. Pédol.*, XI, 227–236
- Reuter JH and Perdue EM (1981) Calculation of molecular weights of humic substances from colligative data: application to aquatic humus and its molecular size fractions. *Geochim. Cosmochim. Acta*, 45, 2017–2022

- Righetti PG and Drysdale JW (1971) Isoelectric focusing in polyacrilamide gels. *Biochem. Biophys. Acta.*, 236, 17–28
- Rusina TV, Kasparov SV and Zharikov AV (1983) Method of electrophoretic research of humus substances and proteins in soil solutions (texte Russe, résumé Anglais). *Pocvovedenie*, 1, 38–46
- Samburova V, Zenobi R and Kalberer M (2005) Characterization of high molecular weight compounds in urban atmospheric particles. *Atmos. Chem. Phys.*, 5, 2163–2170
- Stevenson FJ (1982) Colloidal properties of humic substances. In : *Humus chemistry*, Stevenson FJ ed. Wiley and Sons, 285–308
- Swift RS (1989) Molecular weight, shape, and size of humic substances by ultracentrifugation. In : *Humic substances II.*, Hayes MHB, MacCarthy P, Malcolm RL and Swift RS ed. Wiley New York, 467–495
- Tiurin (1951) Vers une méthode d'analyse par l'étude comparative des constituants de l'humus du sol. *Trav. Inst. des Sols Dokutchaev*, 38, 32 p
- Yamada E, Doi K, Okano K and Fuse Y (2000) Simultaneous determinations of the concentration and molecular weight of humic substances in environmental water by gel chromatography with a fluorescence detector. *Analytical Sci.*, 16, 125–132
- Yu-Ping Chin, Alken G, and O'Loughlin E (1994) Molecular weight, polydispersity, and spectroscopic properties of aquatic humic substances. *Environ. Sci. Technol.*, 28, 1853–1858
- Wershaw RL and Aiken GR (1985) Molecular size and weight measurements of humic substances. In : *Humic substances in soil, sediment and water.*, Aiken GR, McKnight DM, Wershaw RL and MacCarthy P ed. Wiley New York, 477–492
- Wershaw RL (1989) Sizes and shapes of humic substances by scattering techniques. In : *Humic substances II.*, Hayes MHB, MacCarthy P, Malcolm RL and Swift RS ed. Wiley New York, 545–559

### Functional Group of Humic Compounds

- De Nobili M, Contin M and Leita L (1990) Alternative method for carboxyl group determination in humic substances. *Can. J. Soil Sci.*, 70, 531–536
- Fritz JS, Yamamura SS and Bradford EC (1959) Determination of carbonyl compounds. *Anal. Chem.*, 31, 260–263
- Glebko LI, Ulkina JU and Maximov OB (1970) A semi-micro method for the determination of quinoid groups in humic acids. *Microchim. Acta.*, 1247–1254
- Rosell RA, Allan AL, Agullo E and Gelos B (1972) Estudio potenciometrico del humus. II. Determinacion de varios tipos de acidez (o grupo funcionales) de acidos humicos de suelos de la provincia de Buenos Aires, Argentina. *Turrialba*, 22, 327–332



- Schnitzer M and Gupta UC (1965) Determination of acidity in soil organic matter. *Soil Sci. Soc. Am. Proc.*, 29, 274–277
- Schnitzer M and Skinner SIM (1965) Organo-metallic interactions in soils : 4. Carboxyl and hydroxyl groups in organic matter and metal retention. *Soil Sci.*, 99, 278–284
- Wright JR and Schnitzer M (1959) Oxygen-containing functional groups in the organic matter of a Podzol soil. *Nature, London*, 184, 1462–1463

## Spectrometric Characterizations

### UV–Visible, IR, Fluorescence, ESR Spectrometries

- Lapen AJ and Seitz WR (1982) Fluorescence polarization studies of the conformation of soil fulvic acid. *Anal. Chim. Acta.*, 134, 31–38
- Bachelier G (1981) Etude spectrographique de la fluorescence des acides humiques et des acides fulviques de divers sols. *Cah. ORSTOM sér. Pédol.*, 18, 129–145
- Chen Y, Senesi N and Schnitzer M (1977) Information provided on humic substances by E4:E6 ratios. *Soil Sci. Soc. Am. J.*, 41, 352–358
- Ghosh K and Schnitzer M (1979) UV and visible absorption spectroscopic investigations in relation to macromolecular characteristics of humic substances. *J. Soil Sci.*, 30, 735–745
- Ghosh K and Schnitzer M (1980a) Fluorescence excitation spectra of humic substances. *Can J. Soil Sci.*, 60, 373–379
- Goldberg MC, Cunningham KM and Weiner ER (1987) The use of isosbestic points in the fluorescence excitation spectrum of humic acid to calculate the dissociation constant. *Can. J. Soil Sci.*, 67, 715–717
- Kononova MM (1966) *Soil organic matter, its nature, its role in soil formation and in soil fertility*, 2nd English ed. Pergamon Oxford, 544 p
- Lévesque M (1972) Fluorescence and gel filtration of humic compounds. *Soil Sci.*, 113, 346–353
- MacCarthy P and Rice JA (1985) Spectroscopic methods (other than NMR) for determining the functionality in humic substances. In: *Humic substances in soil, sediment and water.*, Aiken GR, McKnight DM, Wershaw RL and MacCarthy P ed. Wiley New York, 527–559
- Nayak DC, Barman AK, Varadachari C, Ghosh K (1985) Fluorescence excitation spectra of humic acids. *J. Indian Soc. Soil Sci.*, 33, 785–787
- Rex RW (1960) Electron paramagnetic resonance studies on stable free radicals in lignins and humic acids. *Nature*, 188, 1185–1186
- Riffaldi R and Schnitzer M (1972) Effects of divers experimental conditions on ESR spectra of humic substances. *Geoderma*, 8, 1–10
- Russel JD and Anderson HA (1977) Comment on “spectroscopie infra-rouge de quelques fractions d’acides humiques obtenues sur Sephadex” *Plant Soil*, 48, 547–548

- Schnitzer M and Skinner SIM (1969) Free radicals in soil humic compounds. *Soil Sci.*, 108, 383–390
- Saab SC and Martin-Neto L (2004) Studies of Semiquinone Free Radicals by ESR in the Whole Soil, HA, FA and humin substances. *J. Braz. Chem. Soc.*, 15, 34–37
- Senesi N (1990) Application of ESR spectroscopy in soil chemistry. *Adv. in Soil Sci.*, 14, 77–129

### Nuclear Magnetic Resonance

- Barron PF, Wilson MA, Stephens JF, Cornell BA and Tate KR (1980) Cross-polarization  $^{13}\text{C}$  NMR spectroscopy of whole soils. *Nature*, 286, 585–587
- Brown JK and Ladner WR (1960) A study of the hydrogen distribution in coal-like materials by high resolution NMR spectroscopy (II). *Fuel*, 39, 87–96
- Conte P, Piccolo A, van Lagen B, Buurman P and de Jager PA (1997a) Quantitative differences by liquid- and solid-state  $^{13}\text{C}$  NMR spectroscopy. *Geoderma*, 80, 339–352
- Conte P, Piccolo A, van Lagen B, Buurman P and de Jager PA (1997b) Quantitative aspects of solid-state  $^{13}\text{C}$  NMR spectra of humic substances from soils of volcanic systems. *Geoderma*, 80, 327–338
- Conte P, Spaccini R and Piccolo A (2004) State of the art of CPMAS C-13-NMR spectroscopy applied to natural organic matter. *Progress in Nuclear Magnetic Resonance Spectroscopy*, 44, 215–223
- Doddrell D, Glushko V and Allerhand A (1972) Theory of the Nuclear Overhauser Enhancement and  $^{13}\text{C}$   $^1\text{H}$  dipolar relaxation in proton-decoupled carbon-13 NMR spectra of macromolecules. *J. Chem. Physics*, 56, 3683–3689
- Freeman R, Hill HDW, Kaptein R (1972) Proton-decoupled NMR spectra of carbon-13 with the nuclear Overhauser effect suppressed. *J. Magn. Res.*, 7, 327–329
- Fründ R. and Lüdemann HD (1989) The quantitative analysis of solution and CPMAS-C13 NMR Spectra of humic material. *Sci. Total Environ.*, 81/82, 157–168
- Gerasimowicz WV and Byler DM (1985) Carbon-13 CPMAS NMR and FTIR spectroscopic studies of humic acids. *Soil Sci.*, 139, 270–278
- Kinchesh P, Powlson DS and Randall EW (1995)  $^{13}\text{C}$  NMR studies of organic matter in whole : a case study of some Rothamsted soils. *Eur. J. Soil Sci.*, 46, 139–146
- Lentz H, Ludemann HD and Ziechmann W (1977) Proton resonance spectra of humic acids from the solum of a podzol. *Geoderma*, 18, 325–328
- Lowe IJ (1959) Free induction decay of rotating solids. *Phys. Rev. Lett.*, 2, 285–287

- Moser A, Lefebvre B (2004) Identifying Residues in Natural Organic Matter through Spectral Prediction and Pattern Matching of 2-D NMR datasets. *Magn. Resonance Chem.*, 42, 14–22
- Newman RH and Tate KR (1984) Use of alkaline soil extracts for  $^{13}\text{C}$  NMR characterization of humic substances. *J. Soil Sci.*, 35, 47–54
- Newman RH, Tate KR, Barron PF and Wilson MA (1980) Towards a direct, non-destructive method of characterising soil humic substances using  $^{13}\text{C}$ -NMR. *J. Soil Sci.*, 31, 623–631
- Pines A, Gibby MG and Waugh JS (1973) Proton enhanced NMR of dilute spins in solids. *J. Chem. Phys.*, 59, 569–590
- Preston CM and Schnitzer M (1984) Effects of chemical modifications and extractants on the  $^{13}\text{C}$  NMR spectra of humic materials. *Soil Sci. Soc. Am. J.*, 48, 305–311
- Schaefer J and Stejskal EO (1976) C-13 NMR of polymers spinning at the magic angle. *J. Am. Chem. Soc.*, 98, 1031–1032
- Schnitzer M and Barton DHR (1963) A new approach to the humic acid problem. *Nature*, London 198, 217–219
- Schnitzer M and Neyroud JA (1974) The chemistry of high molecular weight fulvic acid fractions. *Can. J. Chem.*, 52, 4123–4132
- Simpson AJ, Kingery WL, Williams A, Golotvin S, Kvasha M, Kelleher BK, Simpson AJ, Tseng L, Spraul M, Brauman U, Kingery WL, Kelleher B, Simpson MJ (2004) The application of LC-NMR and LC-SPE-NMR for the separation of Natural Organic Matter. *The Analyst*, 129:1216–1222
- Smernik RJ and Oades MJ (2000) The use of spin counting for determining quantitation in solid state  $^{13}\text{C}$  NMR spectra of natural organic matter. 1. Model systems and the effects of paramagnetic impurities. *Geoderma*, 96, 101–129
- Smernik RJ and Oades MJ (2000) The use of spin counting for determining quantitation in solid state  $^{13}\text{C}$  NMR spectra of natural organic matter. 1. HF-treated soil fractions. *Geoderma*, 96, 159–171
- Smernik RJ and Oades MJ (2003) Spin accounting and RESTORE, two new methods to improve quantitation in solid-state  $^{13}\text{C}$  NMR analysis of soil organic matter, *Eur. J. Soil. Sci.*, 54, doi:10.1046/j.1365-2389.2003.00497.x
- Steelink C, Wershaw RL, Thorn KA and Wilson MA (1989) Application of liquid-state NMR spectroscopy to humic substances. In: *Humic substances II*, Hayes MHB, MacCarthy P, Malcolm RL and Swift RS ed. Wiley New York, 281–338
- Tate RL (1998) Humic substances and organic matter in soil and water environments: characterization, transformations and interactions. *Soil Sci.*, 163, 675–676
- Thorn KA and Mikita MA (2000) Nitrite fixation by humic substances: nitrogen-15 nuclear magnetic resonance. Evidence for potential intermediates in chemodenitrification. *Soil Sci. Soc. Am. J.*, 64, 568–582

- Wilson MA (1981) Applications of nuclear magnetic resonance spectroscopy to the study of the structure of soil organic matter *J. Soil Sci.*, 32, 167–186
- Wilson MA (1987) *Techniques and applications of NMR spectroscopy in geochemistry and soil science.*, Pergamon, Oxford
- Wilson MA (1989) Solid-state NMR spectroscopy of humic substances, basic concepts and techniques. *In: Humic substances II*, Hayes MHB, MacCarthy P, Malcolm RL and Swift RS ed. Wiley and Sons, 309–338
- Wilson MA, Jones AJ and Williamson B (1978) NMR spectroscopy of humic materials. *Nature, London*, 276, 487–489

### Methods of Characterization by Fragmentation

- Anderson HA, Hepburn A and Sim A (1978) Ether-soluble hydrolysis products in humic and fulvic acids. *J. Soil Sci.*, 29, 84–87
- Bracewell JM, Haider K, Larter SR and Schulten HR (1989) Thermal degradation relevant to structural studies of humic substances. *In: Humic substances II*, Hayes MHB., MacCarthy P, Malcolm RL and Swift RS ed., Wiley New York, 181–222
- Chakrabartty SK, Kretschmer HO and Cherwonka S (1974) Hypohalite oxidation of humic acids. *Soil Sci.*, 117, 6
- Chen Y, Senesi N and Schnitzer M (1978a) Chemical degradation of humic and fulvic acids extracted from mediterranean soils. *J. Soil Sci.*, 29, 350–359
- Chen Y, Senesi N and Schnitzer M (1978b) Chemical and physical characteristics of humic and fulvic acids extracted from soils of the mediterranean region. *Geoderma*, 20, 87–104
- Cheshire MV, Cranwell PA and Haworth RD (1968) Humic acid – III. *Tetrahedron*, 24, 5155–5167, Pergamon UK
- Griffith SM and Schnitzer M (1989) Oxidative degradation of soil humic substances. *In: Humic substances II*, Hayes MHB, MacCarthy P, Malcolm RL and Swift RS ed., Wiley New York, 69–98
- Griffith SM and Schnitzer M (1975) Oxidative degradation of humic and fulvic acids extracted from tropical volcanic soils. *Can. J. Soil Sci.*, 55, 251–267
- Griffith SM and Schnitzer M (1976) The alkaline cupric oxide oxidation of humic and fulvic acids extracted from tropical volcanic soils, *Soil Sci.*, 122, 191–201
- Hansen EH and Schnitzer M (1967) Nitric acid oxidation of Danish illuvial organic matter. *Soil Sci. Soc. Am. Proc.*, 31, 79–85
- Hansen EH and Schnitzer M (1969) Zn-dust distillation and fusion of a soil Humic and fulvic acid. *Soil Sci. Soc. Am. Proceed.*, 33, 29
- Hatcher PG, Dria KJ, Kim S., Frazier, SW (2001) Modern Analytical Studies of Humic substances. *Soil Sci.*, 166, 770–794
- Hayes MHB and O'Callaghan MR (1989). Degradations with sodium sulfide and with phenol. *In: Humic substances II*, Hayes MHB, MacCarthy P, Malcolm RL and Swift RS ed., Wiley New York, 143–180

- Jackson MP, Swift RS, Posner AM, Knox JR (1972) Phenolic degradation of humic acid. *Soil Sci.*, 114, 75–78
- Kahn SU and Schnitzer M (1971a) The permanganate oxidation of methylated and unmethylated humic acids extracted from Solonetz, Solod and Chernozem Ah horizons. *Israel J. Chem.*, 9, 667–677
- Kahn SU and Schnitzer M (1971b) Further investigations on the chemistry of fulvic acid, a soil humic fraction. *Can. J. Chem.*, 49, 2302–2309
- Kahn SU and Schnitzer M (1972a) Permanganate oxidation of humic acids, fulvic acids, and humins extracted from Ah horizons of a black chernozem, a black solod and a black solonetz soil. *Can. J. Soil Sci.*, 52, 43–51
- Kahn SU and Schnitzer M (1972b) Permanganate oxidation of humic acids extracted from a GrayGrey wooded soil under different cropping systems and fertilizer treatments. *Geoderma*, 7, 113–120
- Kimber RWL and Searle PL (1970) Pyrolysis gas chromatography of soil organic matter. I. Introduction and methodology, *Geoderma*, 4, 47–55
- Kodama H and Schnitzer M (1970) Kinetics and mechanism of the thermal decomposition of fulvic acid. *Soil Sci.*, 109, 265–271
- Martin F (1976) Effects of extractants on analytical characteristics and pyrolysis gas chromatography of podzol fulvic acids. *Geoderma*, 15, 253–265
- Mendez J and Stevenson FJ (1966) Reductive cleavage of humic acids with sodium amalgam. *Soil Sci.*, 102, 85
- Meuzelaar HLC, Haider K, Nagar BR and Martin JP (1977) Comparative studies of pyrolysis mass spectra from melanins of soil fungi, model phenolic polymers and humic acids from soil, peat and composted straw. *Geoderma*, 17, 239–252
- Meuzelaar HLC, Posthumus MA, Kistemaker PG and Kistemaker J (1973) Curie point pyrolysis in direct combination with low voltage electron impact ionization spectrometry. *Anal. Chem.*, 45, 1546–1549
- Morrison RI (1963) Products of the alkaline nitrobenzene oxidation of soil organic matter. *J. Soil Sci.*, 14, 2
- Neyroud JA and Schnitzer M (1974) The exhaustive alkaline cupric oxide oxidation of humic and fulvic acid, *Soil Sci. Soc. Am. Proc.*, 38, 907–913
- Neyroud JA and Schnitzer M (1975) The alkaline hydrolysis of humic substances. *Geoderma*, 13, 171–188
- Ogner G (1975) Oxidation of nonhydrolyzable humic residue and its relation to lignin, *Soil Sci.*, 116, 93–100
- Ouchi K and Brooks JD (1967) The isolation of certain compounds from depolymerized brown coal. *Fuel*, 46, 367–377
- Parsons JW (1989) Hydrolytic degradations of humic substances. In: *Humic substances II*, Hayes MHB, MacCarthy P., Malcolm R.L. and Swift RS ed., Wiley New York, 99–120
- Piper TJ and Posner AM (1972) Sodium amalgam reduction of humic acid (I and II). *Soil Biol. Biochem.*, 4, 513–531

- Saiz-Jimenez C, Haider K and Meuzelaar HLC (1979) Comparisons of soil organic matter and its fractions by pyrolysis mass-spectrometry. *Geoderma*, 22, 25–37
- Schnitzer M and Hoffmann I (1964) Pyrolysis of soil organic matter. *Soil Sci.Soc.Proced.*, 520–525
- Schnitzer M and Skinner SIM (1974) The peracetic acid oxidation of humic substances, *Soil Sci.*, 118, 322–331
- Schulten HR (1996) Direct pyrolysis–mass spectrometry of soils: a novel tool in agriculture, ecology, forestry and soil science. In *Mass spectrometry of soils*, Boutton TW and Yamasaki S-i ed., Marcel Dekker New York
- Stevenson FJ and Mendez J (1967) Reductive cleavage products of soil humic acids. *Soil Sci.*, 103, 383
- Stevenson FJ (1989) Reductive cleavage of humic substances. In: *Humic substances II, in search of structure*, Hayes MHB, MacCarthy P, Malcolm RL and Swift RS ed., Wiley New York, 122–142

#### **Other methods (microscopy, X-ray, electrochemistry, etc.)**

- Bachelier G (1983) Figures de dessiccation des acides humiques, *Rapport multig. ORSTOM*, 14 p
- Chen Y and Schnitzer M (1976) Scanning electron microscopy of a humic acid and of a fulvic acid and its metal and clay complexes. *Soil Sci. Soc. Am. J.*, 40, 682–686
- Chen Y, Senesi N and Schnitzer M (1976) Chemical and physical characteristics of humic and fulvic acids extracted from soils of the mediterranean region. *Geoderma*, 20, 87–104
- Shinozuka N and Hayano S (1987) Polarographic characterization of humic acid. *Soil Sci.*, 143, 157–161
- Stevenson FJ and Schnitzer M (1982) Transmission electron microscopy of extracted humic and fulvic acids, *Soil Sci.*, 133, 334–345
- Tan KH (1985) Scanning electron microscopy of humic matter as influenced by methods of preparation. *Soil Sci. Soc. Am. J.*, 49, 1185–1191
- Defosse C and Rouxhet PG (1980) Introduction to X-ray photoelectron spectroscopy. In: *Advanced chemical methods of soil and clay mineral research.*, J.W Stucky and W.L. Banwart ed., Reidel, Dordrecht, 165–204
- Goodman BA and Cheshire MV (1979) A Mössbauer spectroscopic study of the effect of pH on the reaction between iron and humic acid in aqueous media. *J. Soil Sci.*, 30, 85–91

## Measurement of Non-Humic Molecules

### 13.1 Introduction

#### 13.1.1 Non-Humic Molecules

Soil organic matter probably contains the majority of biochemical compounds synthesized by living organisms (Stevenson 1982). In addition to humic molecules, whose quantification (described in Chap. 11) is technically simpler than the structural characterization of molecules (cf. Chap. 12), a large number of other molecules of known structure are also present in soils. The most abundant can be classified in three main groups:

1. Nitrogenous molecules, which are often studied by their fragmentation products during acid hydrolysis.
2. Polysaccharides, mostly not nitrogenous molecules, which are also often studied by their fragmentation products.
3. The lipid fraction, which are sometimes called soil bitumens and contain a range of molecules extractable with the solvents used for fats; this fraction also contains many of the organic pollutants and xenobiotic residues that can contaminate the soil.

Titration techniques for (1) nitrogenous molecules are described in Chap. 14. This chapter describes the main titration techniques for the second and third types of molecules.

#### 13.1.2 Soil Carbohydrates

##### *Total Composition*

Sugars (also improperly called carbohydrates because of an empirical formula corresponding to  $C_n(H_2O)_n$ ) account for 5–25% of soil organic

matter. Aside from traces of free sugars which can be extracted from the soil by water, soil carbohydrates are components of polysaccharides. It is practically impossible to isolate soluble fractions of polysaccharides for identification (Cheshire 1979). Consequently it is difficult to know if sugars come from a heterogeneous mixture of polysaccharides or from a single particularly complex polysaccharide.

Eight neutral carbohydrates can be identified by hydrolysis of soils. These can be classified in three main groups: hexose, deoxyhexose and pentose sugars. Two acid sugars (uronic acids) and two basic sugars (hexosamines) can also be identified.

Ranked in descending order, hexose sugars account for from 12–4% of organic matter and include glucose, galactose and mannose. Uronic acids account for 1–5% of soil organic matter and contain roughly equal parts of galacturonic and glucuronic acids. Pentose sugars are present in smaller quantities and contain mainly arabinose and xylose as well as traces of ribose. Fucose and rhamnose deoxyhexoses are found in similar concentrations to pentose sugars.

Amino sugars (cf. Chap. 14) are present still in lower concentrations in the soil; their chief components are hexosamines in the form of galactosamine and glucosamine.

Traces of other sugars can also be found in the soil: four methyl sugars, two alcohol sugars (inositol and manitol), two hexose sugars (fructose and sorbose), a pentose sugar (deoxyribose) and a hexosamine sugar (*N*-acetyl glucosamine).

### ***Sugars and Types of Soils***

Many authors have tried to characterize soils by quantification of the sugars that result from acid hydrolysis of polysaccharides. Folsom et al. (1974) found an almost linear relationship between total carbohydrate content and soil organic carbon content; however a curvature appeared for the range of very organic horizons which contained a lower proportion of sugars. These authors reported that grassland soils contained more pentoses and less hexoses than forest soils and also that the proportion of mannose increased with soil depth, indicating greater stability of this sugar.

Singhal and Sharma (1985) reported that total carbohydrates and organic carbon contents of forest soils varied in the same way whatever the tree cover. They observed no difference in the relative proportions of these sugars. MacGrath (1973) also found a very constant value for the relative composition of sugars in 38 Irish grassland soils.



Cheshire and Anderson (1975) observed a higher quantity of total sugar in cultivated soils than in uncultivated soils but the relative proportions were the same.

### ***Distribution and Origin***

Another aspect of the problem is linked to the distribution of polysaccharides in the fractions of soil organic matter. Diluted alkaline solutions are the best reagent for polysaccharide extraction although the majority of the polysaccharides remain associated with humin residues. Acidification of alkaline extracts precipitates humic acids and the majority of the polysaccharides remain in the acid soluble fraction of fulvic acid (Cheshire 1979; Barriuso et al. 1985). Bagautdinov et al. (1984) separated one fraction from a fulvic acid solution which contained mainly polysaccharides with a molecular weight of 27,000–28,000.

Many authors have tried to determine whether soil sugars are of microbial or plant origin. This is not a simple task since none of the main sugars can be classified exclusively as being of plant or microbial origin (Cheshire 1979). There are more similarities than differences in sugars between humic acids and fungi melanins (Coelho et al. 1988).

Incubation experiments using labelled glucose led to labelling of all sugars and, to a lesser extent, of amino acids. Deoxyhexoses have been identified as the most stable synthesized sugars (Cheshire 1979). With an increase in incubation time, an increasingly large proportion of labelled carbon was found in humin (Guckert et al. 1971). Hexose sugars are the main sugars synthesized by soil micro-organisms (Oades 1974).

François (1988) and Murayama (1983, 1984, 1988) reported that they had been unable to identify a specific origin for glucose, galactose and ribose but that xylose and arabinose are primarily of plant origin, while rhamnose, mannose and fucose are very often synthesized by micro-organisms but are also present in root exudates of various plants.

François (1988) showed that total sugars are primarily concentrated in fresh roots and in the 5–25  $\mu\text{m}$  soil particle fraction. A marked relative reduction in xylose content and an increase in mannose and rhamnose contents were measured in the finer fractions. Feller (1991) used the xylose:mannose ratio as an indicator of the microbial or plant origin of the organic matter. This ratio had the lowest value (0.5–2) in the organic matter of the clay-organic compartment  $<2 \mu\text{m}$ ; its value ranged between 1 and 3 in the 2–20  $\mu\text{m}$  fraction and between 5 and 10 in the  $>20 \mu\text{m}$  fraction (cf. Chap. 9).

---

***Principle of Titration***

Free sugars can be titrated on aqueous extracts of soils. Polysaccharide titration has three main stages:

- Acid hydrolysis of polysaccharides;
- Possible purification of the hydrolysate; and
- Titration of the hydrolysate.

Titration of free or hydrolysed sugars uses two types of techniques:

- Global colorimetric methods for reducing sugars and
- Chromatographic methods allowing the measurement of each individual sugar.

**13.1.3 Soil Lipids**

Soil lipids are rather complex mixtures of compounds one of whose common characteristics is solubility in a range of organic solvents or mixtures of solvents. This fraction includes groups such as free fatty acids, hydrocarbons, polar or non-polar lipids, steroids, waxes and resins.

The majority of lipids can be classified in three main groups: fats, waxes and resins. The resins are the most polar compounds and are thus most soluble in methanol and ethanol, and this property can be used to separate them.

Lipids are present in the soil in smaller quantities than nitrogenous compounds and polysaccharides. According to Stevenson (1982) they account for 2–6% of organic matter) and according to Jambu et al. (1978) up to 20% in certain soils. Lipids are generally present in higher concentrations in acid soils. The most fertile soils are generally poor in lipids. The presence of lipids may even be related to the old concept of soil sickness (Stevenson 1966) and depend on humus content, soil aeration and texture (Jambu et al. 1978).

The extraction of soil lipids may be complicated by the fact they bond to a varying extent with other organic or inorganic compounds in the soil. Most pesticides and other organic pollutants of the soils are also extracted with the lipid fraction.

### 13.1.4 Pesticides and Pollutants

Most of the products used in food and agricultural chemistry can be found in soils.

Organic pollutants that result from the breakdown of products in the environment can be extremely varied, although the majority belong to the following main groups:

- Polychlorinated biphenyls (PCBs) are families of chlorinated pollutants including about 30 compounds; traces of PCB can be detected in a very large number of substrates;
- Polynuclear aromatic hydrocarbons (PAH) include 15–20 compounds (e.g. naphthalene, phenanthrene, anthracene or pyrene) that are resistant to degradation; and
- Dioxins are also residues of degradation but are present in more limited quantities.

Pesticides are generally not very stable molecules used in agriculture in a wide range of products like insecticides, acaricides, nematocides, repellents, fungicides, herbicides and poisons. They comprise a very large number of compounds. Although there is a general trend towards molecules that are less and less toxic for humans, and more and more degradable, there is also an increase in the total amount used as a result of gene mutations and of the development of resistance in living organisms. Calvet et al. (2005) summarized current knowledge about pesticides and their agronomic and environmental consequences for soils.

More than one thousand compounds are sold as pesticides and these are difficult to classify. Some of the main families are:

- Organochlorinated products including the first historically sold synthetic molecules such as DDT, dieldrin or lindane; these products are less used today because of their toxicity and low rate of degradability; however, they are still found in the environment since they accumulated in the lipids of living organisms; nowadays new halogenated molecules are used;
- Organophosphorous products were often used to replace the first organochlorinated products;
- Triazine herbicides;
- Acid herbicides like chlorophenoxyacetic acids, picloram or dicamba;
- Carbamates and thiocarbamates, which are often used as systemic insecticides; and
- Pyrethrinoids, which are synthetic molecules derived from natural pyrethrins and are commonly used as insecticides because they are not exchanged in the blood of human beings or warm-blooded animals.

## 13.2 Classical Techniques

### 13.2.1 Acid Hydrolysis of Polysaccharides

#### *Principle of the Technique and Main Difficulties*

Hot diluted acids are capable of completely hydrolyzing polysaccharides but in most soils they only hydrolyze about 75%.

To achieve complete hydrolysis of polysaccharides, e.g. cellulose or soil polysaccharides, a preliminary treatment with a more concentrated acid is required (Cheshire 1979). During hydrolysis with diluted acids, release of hexose sugars increases with an increase in the concentration of the acid. Alone, diluted acids are generally not appropriate for quantitative titration of hexose sugars.

Pentose sugars are more easily released than hexose sugars but they are also more easily destroyed during acid hydrolysis and, depending on the soil, they may be more efficiently titrated by hydrolysis in more diluted medium.

Ivarson and Sowden (1962) were the first to recommend cold pretreatment with 12 mol L<sup>-1</sup> sulphuric acid (72%) followed by dilution of the acid to 0.5 mol L<sup>-1</sup> and heating at reflux. In samples of litter, this attack released almost three times more hexoses than hydrolysis without pretreatment, but the release of pentoses was reduced by approximately 20% in the case of conifer litter.

Gupta and Sowden (1965) confirmed on four soils a very positive effect of pretreatments for the titration of hexoses and pentoses, except in some cases where deoxyhexoses were partly destroyed.

Cheshire and Mundie (1966) optimized the time of cold pretreatment with 12 mol L<sup>-1</sup> sulphuric acid. The sugars measured by orcinol colorimetry reached maximum towards 16 h then decreased, whereas those measured by anthrone colorimetry (hexoses) continued to increase up to 40 h. The length of pretreatment thus influenced the time of attack at reflux with the 0.5 mol L<sup>-1</sup> sulphuric acid solution necessary for the maximum release of sugar. After 16 h cold pretreatment, 5 h of hot attack were sufficient to reach maximum, whereas after 2 h pretreatment, nearly 20 h of attack were necessary. Finally, these authors concluded that there is no perfect method of hydrolysis enabling the complete release of glucose without partially destroying pentoses or deoxyhexoses. The 16 h treatment with 12 mol (H<sub>2</sub>SO<sub>4</sub>) L<sup>-1</sup> at 20°C followed by heating for 5 h at reflux with 0.5 mol (H<sub>2</sub>SO<sub>4</sub>) L<sup>-1</sup> was recommended because in several cases it resulted in the highest rate of release of glucose. This reason is not very convincing in the case of studies on the origin of sugars in the soil where glucose is not representative of a sugar of plant or microbial origin (cf. Sect. 13.1.1).

Oades et al. (1970) focussed on hydrolysis conditions for chromatographic titration of sugars. For a soil with no plant fragments, they found the best extracted sugar contents by direct attack at reflux for 1 h with a 5 mol ( $\frac{1}{2}\text{H}_2\text{SO}_4$ )  $\text{L}^{-1}$  solution. However, this attack released less glucose than another technique similar to that of Cheshire and Mundie (16 h in 13 mol ( $\text{H}_2\text{SO}_4$ )  $\text{L}^{-1}$  cold reagent followed by heating at reflux for 2 h in 0.5 mol ( $\text{H}_2\text{SO}_4$ )  $\text{L}^{-1}$ ). But Oades' technique released a higher quantity of other sugars, particularly xylose, rhamnose and fucose. However in a sandy silt soil, there is a risk in significant breakdown of sugars when the duration of hydrolysis exceeds 20 min for xylose, 40 min for arabinose and about 1 h for other sugars (not the same risk in the method with pretreatment).

In fact for total sugar contents, the results of the method with heating at reflux for 20 min in 5 mol ( $\frac{1}{2}\text{H}_2\text{SO}_4$ )  $\text{L}^{-1}$  were not very different from those obtained using cold pretreatment, except for samples rich in materials where method with pretreatment is recommended. The Oades' method provided more pentoses and deoxyhexoses but much less glucose. To release glucose, a longer attack with 5 mol ( $\frac{1}{2}\text{H}_2\text{SO}_4$ )  $\text{L}^{-1}$  was necessary but with the risk of destroying pentose and deoxyhexose sugars. To obtain maximum rates for glucose and other sugars simultaneously Oades et al. recommended heating at reflux for 20 min with 5 mol ( $\frac{1}{2}\text{H}_2\text{SO}_4$ )  $\text{L}^{-1}$  reagent then filtration followed by 16 h of cold maceration in 26 mol ( $\frac{1}{2}\text{H}_2\text{SO}_4$ )  $\text{L}^{-1}$  reagent and heating at reflux for 5 h in 1 mol ( $\frac{1}{2}\text{H}_2\text{SO}_4$ )  $\text{L}^{-1}$  reagent. Initial heating at reflux with 5 mol ( $\frac{1}{2}\text{H}_2\text{SO}_4$ )  $\text{L}^{-1}$  reagent for only 20 min may be sufficient for not very organic soils but there is a risk of underestimating glucose.

The majority of more recent studies did not continue to optimize hydrolysis conditions; Coelho et al. (1988), Murayama (1987), Cheshire and Griffiths (1989) used the method of Oades et al. (1970) with hydrolysis in two stages. They sometimes distinguished sugars released by heating at reflux for 20 min with 5 M  $\text{H}_2\text{SO}_4$ , called non-cellulose sugars, from sugars released by later hydrolysis (heating at reflux for 5 h with 1 N  $\text{H}_2\text{SO}_4$  preceded by maceration in 26 N  $\text{H}_2\text{SO}_4$ ), called cellulose sugars.

Arschad and Schnitzer (1987) and Baldock et al. (1987) used the method developed by Spiteller (1980) which is similar to that of Cheshire and Mundie (1966) with respect to the conditions of hydrolysis: maceration for 16 h with 26 N  $\text{H}_2\text{SO}_4$  followed by boiling at reflux for 5 h with  $\text{NH}_2\text{SO}_4$ . Singhal and Sharma (1985) used the method of Gupta (1967): 2 h of extraction at low temperature with 72%  $\text{H}_2\text{SO}_4$  then

heating at reflux for 16 h after dilution. Benzing-Purdie and Nikiforuk (1989) used a simpler technique for hydrolysis at 105°C for 18 h in 2 N H<sub>2</sub>SO<sub>4</sub> and compared it with the method of Cheshire and Mundie (1966). Guckert (1973) also used a similar technique with hydrolysis with 3 mol (½H<sub>2</sub>SO<sub>4</sub>) L<sup>-1</sup> acid at 80°C for 24 h after extraction.

Without cold pretreatment, with 4.5 h hydrolysis, titration of sugars by both anthrone and ferricyanide colorimetry reached maximum with a 5 N acid concentration and a temperature of 100°C (in closed flasks) and displayed a much less significant influence of the acid concentration than of temperature (Pansu 1992). Cold pretreatment increased the quantities of sugars released and the optimum temperature for the subsequent attack moved to between 70 and 90°C with a weaker acid (1 mol (½H<sub>2</sub>SO<sub>4</sub>) L<sup>-1</sup>, in agreement with the results of Cheshire and Mundie (1966).

Pansu (1992) also showed good resistance to the degradation of known quantities of monosaccharides added in the attack solutions. Commercial crystallized cellulose showed good resistance to concentrated acids at 105°C whatever the concentration of the sulphuric acid, and even to hydrochloric acid. Cellulose hydrolysis only became significant (88%) with the method including a cold pretreatment with the 26 mol (½H<sub>2</sub>SO<sub>4</sub>) L<sup>-1</sup> reagent. Hydrolysis of commercial cellulose released not only glucose (66–86% of the total), but also galactose (10–30%), mannose (1–2%), xylose (approximately 1%) and ribose (approximately 1%).

### **Equipment and Reagents**

- Inorganic purified water: demineralized water purified on activated carbon (standard Millipore) or water distilled after reflux attack in the presence of a little potassium permanganate and sulphuric acid.
- Six round bottom boiling flasks (100 mL) with ground stopper or six flasks with PTFE joint screw stopper (100 mL).
- Set of six condensers (only for the method with reflux heating).
- Büchner funnels with standard GF/A glass fibre filters  $\phi$  4 cm (Whatman No. 1820 042, or similar).
- 13 mol L<sup>-1</sup> concentrated sulphuric acid solution: add 278 mL inorganic water in a 1 L volumetric flask; carefully add while agitating and cooling in a cold water bath, 722 mL of concentrated reference grade sulphuric acid; complete to 1 L.
- 2.5 mol (H<sub>2</sub>SO<sub>4</sub>) L<sup>-1</sup> (5 N) sulphuric acid solution: proceed as given earlier but with 139 mL of acid and complete to 1 L with inorganic water.

### ***Procedure***

Section 13.2.1 earlier mentions that our current state of knowledge makes it difficult to recommend a precise standardized attack that is valid for all soils. The conditions of hydrolysis need to be adjusted to the type of study required. Based on the review of the literature in Sect. 13.2.1, the three alternative procedures listed later can all be used.

#### ***Attack Favouring the Measurement of Pentoses***

Put 5 g of soil and 40 mL of 2.5 mol L<sup>-1</sup> sulphuric acid in a 100 mL round bottom boiling flask. Connect to the condenser and heat at reflux for 20 min (alternatively heat in a flask with a screw cap at 100°C for 20 min).

Leave to cool and filter on a Büchner funnel on glass fiber filter or centrifuge.

#### ***Total Attack***

Add the residue of the previous attack (with glass fibre filter) and 2 mL of 13 mol (H<sub>2</sub>SO<sub>4</sub>) L<sup>-1</sup> solution in the same 100 mL round bottom flasks used earlier.

Stop the flasks and leave at ambient temperature for 16 h (overnight).

Carefully add 50 mL inorganic water while cooling.

Connect the flasks to the condensers and heat at reflux for 5 h (alternatively, heat at 90°C in a closed bottle).

Filter as mentioned earlier on glass wool.

For the analysis of total sugars, the filtrates described in “Attack Favouring the Measurement of Pentoses” earlier and in “Total Attack” can be mixed. The analysis of each hydrolysate releases (a) sugars that are easily hydrolysable (mainly pentoses) in the hydrolysate described in “Attack Favouring the Measurement of Pentoses”, (b) sugars like cellulose that are difficult to hydrolyse in the hydrolysates described in “Total Attack”.

#### ***Simplified Total Attack***

In a 100 mL round bottom flask place 5 g of soil sample and 2 mL of 13 mol (H<sub>2</sub>SO<sub>4</sub>) L<sup>-1</sup> solution.

Stop the flask and leave at the ambient temperature for 16 h (overnight).

Carefully add 50 mL inorganic water while cooling.

Connect the boiling flasks to the condensers and heat at reflux for 5 h (alternatively, heat at 90°C in a closed bottle).

Filter as mentioned earlier on glass wool or centrifuge.

### 13.2.2 Purification of Acid Hydrolysates

#### *Principle of the Technique and Main Difficulties*

Particularly for chromatographic titration, the hydrolysates must be purified to remove a significant amount of inorganic compounds especially sulphate ions but also inorganic dissolved solids (particularly iron and aluminium) by the acid attack of the soil. Neutralization of the extracts involves the precipitation of aluminium and iron hydroxides. If neutralization is carried out with a carbonate or hydroxide belonging to the alkaline earths (Ca, Sr or Ba) sulphates can also be precipitated. The risk of error lies in the possible adsorption of neutral sugars by the precipitates. With barium hydroxide or carbonate, neutral sugars and barium salts of uronic acids can be recovered by filtration and by washing the precipitates with water, sometimes by washing with hot water or by ethanol extraction with a Soxhlet apparatus (Cheshire and Mundie 1966). Sodium bicarbonate has also been used for neutralization of the acid extracts with methanol extraction of the sodium sulphate after desiccation (Oades 1967).

Calcium carbonate enables neutralization by eliminating sulphates together with most coloured organic matter (Brink et al. 1960). Oades et al. (1970) preferred strontium carbonate to bring the hydrolysates towards pH 7. When the solutions were left to stand, these authors observed coprecipitation of brown organic matter and iron complexes. After filtration and dry evaporation of the filtrate in a rotary evaporator, sugars were dissolved in 4–5 fractions of 2–4 mL methanol with filtration.

The extracts can be also purified by successive passage on cation and anion resin which also separates neutral sugars and uronic acids. Alternatively, columns filled with a mixture of coal and celite enable sugars to be eluted with 50% ethanol in water after the salts are rinsed in water (Cheshire 1979).

Tests were carried out at IRD<sup>1</sup> (unpublished data) to compare seven methods of purification:

- Water elution on MB1 amberlite resin,
- Methanol elution on MB1 amberlite resin,
- Neutralization with strontium carbonate,
- Neutralization with sodium bicarbonate,
- Neutralization with barium carbonate,

---

<sup>1</sup> IRD, Institute of Research for Development (ex-Orstom), BP 64501, 911 Avenue of Agropolis, 34394 Montpellier Cedex 5, France.



- Neutralization with barite and
- Neutralization with soda.

The method which provided the best recovery of sugars was neutralization with strontium carbonate; this result is in agreement with that of Oades et al. (1970).

### **Corrective Factors**

Studies using synthetic solutions enabled the effect of neutralization with strontium carbonate on the recovery of sugars to be identified (Pansu 1992). In three tests, the internal standard (myoinositol) was added before neutralization, and in three other tests, myoinositol was added before the borohydride reduction of the purified concentrated solutions. Each final solution was injected twice into the chromatograph. Calculations of the absolute contents showed:

- The error due to the method of preparation of the samples was no higher than the error in the chromatographic measurement ( $F$  test). For most sugars, this error was about 1%.
- A higher rate of adsorption of the internal standard on the precipitate than adsorption of the other sugars. Thus it is better to introduce the internal standard after purification of the extracts but before derivatization of sugars.
- An average percentage of recovery of sugars of 85%, ranging from 71% for ribose to 91% for rhamnose. Ribose was always recovered in the smallest quantities. Based on these recovery percentages, we propose the following corrective factors: multiply the results of absolute contents of each sugar by 1.21 for rhamnose, 1.08 for fucose, 1.41 for ribose, 1.10 for arabinose and xylose, 1.25 for mannose, 1.21 for galactose and 1.15 for glucose. These factors take into account the response coefficients of each sugar compared to the internal standard.

### **Equipment and Reagents**

- Six 100 mL beakers;
- Magnetic stirrers;
- Six 250 mL round bottom flasks for the rotary evaporator and
- Strontium carbonate,  $M = 147.63$  g.

#### **2.2.4 Procedure**

Transfer the filtrates or centrifugation solutions described in Sect. 13.2.1 in 100 mL beakers, agitate on a magnetic stirrer. Add the quantity of

strontium carbonate in powder form calculated according to the quantity of sulphuric acid to be neutralized plus 10%, i.e.:

– Hydrolysis A:  $1.1 \times 40 \times 2.5 \times 147.63/1000 = 16.2$  g

– Hydrolysis C:  $1.1 \times 2 \times 13 \times 147.63/1000 = 4.2$  g

– Hydrolysis B: the same as hydrolysis c + 2 mL of 2.5 mol L<sup>-1</sup> acid solution which impregnates the a residue, i.e. a total of 4.9 g.

SrCO<sub>3</sub> should be added to the solution slowly under agitation to avoid foam overflow.

Leave in contact for at least 1 h under agitation. Check the pH is neutral or slightly basic (add a soda pellet if necessary). Check for precipitation of iron hydroxides which colour the precipitate and discolour the solution.

Centrifuge and collect the supernatant in a round bottom boiling flask for later titration by gas chromatography (GPC) if required (cf. Sect. 13.2.4), and in a 100 mL volumetric flask if not. Rinse the residue with 25 mL methanol while stirring with a glass rod. Centrifuge again and add the supernatant to the previous solution. Repeat this operation once more.

### 13.2.3 Colorimetric Titration of Sugars

#### *Techniques*

Most colorimetric methods are based on one of the two following properties of sugars: their reducing power or, in strong acids, the formation of furfural-type compounds that react easily giving coloured derivatives.

The methods can be classified in different categories corresponding to the measurement of total sugars, hexoses or pentoses.

#### *Colorimetry of Total Sugars*

Two titration techniques based on the reducing power of carbohydrates were tested (a) reduction of alkaline cupric salt solutions (Fehling's liquor) resulting in Cu<sup>+</sup> copper complexes or (b) reduction of yellow ferricyanide solutions resulting in colourless ferrocyanides. The latter was considered preferable for the measurement of soil sugar and was automated by Cheshire and Mundie (1966).

Three techniques use the other property based on furfural derivatives: total sugars with anthrone, phenol or orcinol. Anthrone produces a beautiful green–blue colour when it comes in contact with the furfural derivatives in the concentrated sulphuric acid. This reagent provides the best absorbance of complexes with deoxyhexose and hexose sugars (except for mannose). However the response to pentose sugars is

weaker and becomes undetectable when the anthrone content is above 0.05%. This method is also suspected of interfering with other organic matter as well as with iron and nitrates (Cheshire 1979).

Phenol reacts with the furfural derivatives and results in a yellow colouration (Dubois et al. 1956). The similarity of this colour to that of soil hydrolysates could result in overestimation of total sugars with this reagent (McGrath 1973). Overestimated data were observed with direct phenol colorimetric analysis without purification of hydrolysates (Pansu 1992). However, Doutre et al. (1978) considered this method more satisfactory than the anthrone method.

Orcinol or 3,5-dihydroxytoluene also reacts with the furfural derivatives, in this case with the advantage of providing enough similar responses for each sugar. It was used for soil hydrolysates by Bachelier (1966).

#### *Colorimetry of Hexose Sugars*

Although originally proposed for total sugars, anthrone is more commonly used to measure hexoses and deoxyhexoses of soil hydrolysates.

Ivarson and Sowden (1962) also proposed chromotropic acid for the measurement of hexoses. This reagent is not very susceptible to interference with pentose sugars and uronic acids and responded more strongly than anthrone on four samples of soil and litters.

#### *Colorimetry of Pentose Sugars*

Cheshire and Mundie (1966) used the orcinol-FeCl<sub>3</sub> reagent described by Thomas and Lynch (1961) to measure the maximal release of pentose sugars during hydrolysis. In acetic acid, aniline also reacts with pentose sugars at ambient temperature resulting in a red colouration, with only slight interference by hexose sugars and uronic acids (Ivarson and Sowden 1962; Tracey 1950).

#### *Colorimetry of Deoxyhexose Sugars*

The yellow colour formed by heating the carbohydrate extract with cysteine in sulphuric acid medium is quoted as specific to deoxyhexose sugars; this reagent was used for soil hydrolysates by Cheshire and Mundie (1966).

See Chap. 14 for titration of uronic acids and amino sugars.

#### **Equipment and Reagents**

- Calibrated 150×25 mm glass test tubes;
- Water bath;

- Visible spectrophotometer;
- Plastic colorimetric cells, length 1 cm;
- Crushed ice;
- Concentrated sulphuric acid 18 mol (H<sub>2</sub>SO<sub>4</sub>) L<sup>-1</sup> ( $d = 1.84$ );
- 5% phenol solution in water;
- 0.2% solution of anthrone in concentrated H<sub>2</sub>SO<sub>4</sub>;
- Standard solutions for the phenol method: 0, 5, 10, 25, 50 and 100 mg (glucose) L<sup>-1</sup> and
- Standard solutions for the anthrone method: 0, 5, 10, 15, 20 and 25 mg (glucose) L<sup>-1</sup>.

#### ***Procedure for the Phenol Method***

Put in the test tubes 2 mL of soil hydrolysate (cf. Sect. 13.2.1) or purified soil hydrolysate (cf. Sect. 13.2.2) that has been previously completed to 100 mL in a volumetric flask (a preliminary test of standard additions can be used to check the need for purification).

Add 1 mL phenol solution and then rapidly add 5 mL of concentrated sulphuric acid without allowing it to run along the wall of the flask (taking care not to splash).

Leave to stand for 10 min, agitate the tubes and place them in the water bath at 25–30°C for 20 min, then cool under running water.

Read absorbance at 485 nm (490 nm for hexose sugars, 480 nm for pentose sugars and uronic acids). The colour remains stable for several hours. It is sometimes necessary to homogenize the solutions just before colorimetric reading.

Proceed in the same way for each point of the calibration range.

#### ***Procedure for the anthrone method***

Bring the hydrolyzed solution (cf. Sects. 13.2.1 or 13.2.2) to 100 mL and homogenize well.

Introduce 5 mL of this solution in a calibrated test tube placed in ice. Proceed in the same way for each calibration point.

Slowly add in each tube 10 mL of anthrone solution letting it run down the side of the tube; swirl the tube to mix.

Seal with a piece of parafilm and immediately place in a 85°C water bath for 35 min.

Cool in an ice-tray and place in a colorimetric cell and read absorbance at 625 nm. Disposable plastic colorimetric cells (1 cm in length) should be used to limit the number of transfers and washings of the concentrated sulphuric acid solutions.

### 13.2.4 Titration of Sugars by Gas Chromatography

#### *Principle*

The titration of sugars by gas chromatography is rather difficult to implement for two reasons:

- Sugars are too polar to be satisfactorily separated directly on the gas chromatographic columns; it is thus necessary to form derivatives which transform the hydroxyl functional groups into less polar forms;
- Gas chromatography is more selective than liquid chromatography; separation of the carbohydrate can result in many peaks representing the isomers of the different molecular configurations and the chromatograms may then be difficult to interpret.

Most authors used techniques similar to the one described by Oades et al. (1970). Sodium borohydride was added to the neutralized and purified acid extracts, and this transformed the isomers of sugars into their alditol form. After elimination of the boric acid formed by successive evaporations in acetic acid medium, acetylation of the alditols was performed with acetic anhydride.

Alditol acetates were dissolved in methylene chloride for injection into the chromatograph. Oades et al. (1970) used a 2 m column with an interior diameter of 3.5 mm filled with 100–120 mesh GAS Chrom Q impregnated with 5% ECNSS-M. In this way eight major soil sugars were separated in 70 min though with rather poor distinction between rhamnose and fucose.

Spiteller (1980) improved this technique. He separated alditol acetates on a non-polar OV1 25 m capillary column in 25 min by detecting traces of glucosamine and galactosamine. Cheshire et al. (1983) separated alditol acetates with a capillary column of 50 m × 0.3 mm impregnated with SILAR 10 CP with a 90 min temperature programme. Dormaar (1984) obtained separation with a duration similar to that used by Spiteller (1980) with a glass capillary tube impregnated with SP2330. Baldock et al. (1987) used the procedure of Spiteller, as did Arshad and Schnitzer (1987), the latter authors with a capillary tube and a stationary phase with trifluoropropyl-methyl which increased the total duration of the analysis. Coelho et al. (1988) used a filled column, and the length of the separation phase was similar to that of Oades et al. (1970). Like Cheshire and Griffiths (1989) and Murayama (1988) used chromatographic separation of alditol acetates but did not specify the column used.

The reduction and acetylation operations which follow the purification of the hydrolysates are rather long and this means many samples cannot

be compared. Blakeney et al. (1983) recommended a method allowing the preparation time to be reduced, but a test performed at the IRD laboratory with this aim in view was unsuccessful (unpublished data).

On the other hand, the chromatographic time (Fig. 13.1) was reduced to 12.5 min using a capillary column impregnated with a SP2330 phase similar to that of Dormaar (1984), but made of silica glass instead of borosilicate glass (Pansu 1992).

### ***Equipment and Reagents***

- 5 mL conical cylinder flasks with PTFE joint screw caps (Fig. 13.2);
- Pasteur pipettes with 3 mL squeeze bulbs;
- Thermostated aluminium heating block (Fig. 13.2);
- Nitrogen sweeping for evaporation (Fig. 13.2);
- Gas phase chromatograph equipped with a flame ionization detector;
- SP2330 silica capillary column (Supelco) 15 m in length and 0.25 mm ID;
- Standard carbohydrate solution in 85% methyl alcohol containing 1 mg mL<sup>-1</sup> of each carbohydrate: rhamnose, fucose, ribose, arabinose, xylose, mannose, galactose and glucose;
- Standard solution containing 1 mg mL<sup>-1</sup> myoinositol in 50% methyl alcohol;
- Methyl alcohol;
- Strontium carbonate;
- Sodium borohydride;
- Glacial acetic acid;
- Anhydrous solution of 10% acetic acid in methanol (dry on anhydrous Na<sub>2</sub>SO<sub>4</sub>);
- Acetic anhydride and
- Chloroform.

### ***Preparation of Alditol Acetates***

- (a) In each boiling flask containing the purified hydrolysates, add an exact volume of the myoinositol internal standard solution appropriate for the estimated quantity of sugars (0.5–2 mL).
- (b) Evaporate to just dry with a rotary evaporator; rinse the boiling flask with 3–4 small fractions of methanol using a Pasteur pipette and transfer the washing solutions to a 5 mL flask with screw cap.
- (c) Add approximately 10 mg of sodium borohydride and leave to act overnight.
- (d) Add 0.1 mL of glacial acetic acid, evaporate to dry at 70°C under a nitrogen flow (Fig. 13.2), add 1 mL of anhydrous 10% acetic acid in

the ethyl alcohol solution and evaporate in the same way, repeat this operation five times.

(e) Add 1 mL acetic anhydride, stop the flasks and heat at 135°C for 2 h.

(f) Cool to 70°C and evaporate to dry under a nitrogen flow.

(g) Cool and dissolve in an exact volume of from 0.5 to 2 mL of chloroform depending on the estimated sugar content.

The solutions can be stored or injected directly into the chromatograph.

#### *Preparation of Standards for Alditol Acetates*

Add 1 mL standard solution of sugars and 1 mL of internal standard solution in a 5 mL flask with a screw cap and continue as mentioned earlier starting at stage c.

#### **Chromatographic Conditions**

- Silica glass Supelco SP2330 capillary column (or similar) length: 15 m, interior diameter: 0.25 mm.
- Carrier gas: 0.7 bar helium.
- Splitter injector, leak-flow: 100 mL min<sup>-1</sup>.
- Injection: 1 µL.
- Flame ionization detector.
- Temperatures:
  - column programmed from 210 to 250°C at 3°C min<sup>-1</sup>,
  - injector: 300°C,
  - detector: 250°C.

Figure 13.1 shows an example of chromatograms obtained on sugars in a standard solution and in a ferrallitic soil from Congo.

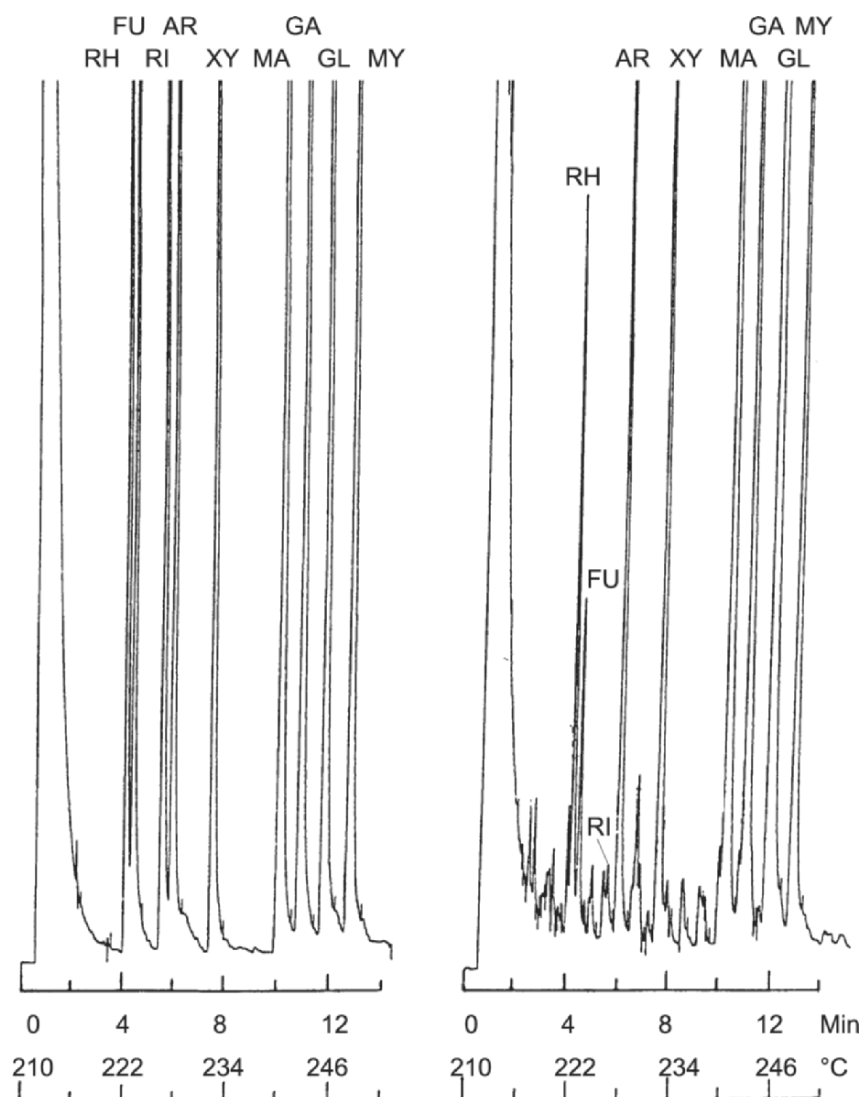

**Fig. 13.1.** Chromatograms of alditol acetates (conditions described in "Chromatographic conditions", RH, rhamnose; FU, fucose; RI, ribose; AR, arabinose; XY, xylose; MA, mannose; GA, galactose; GL, glucose; MY, myoinositol internal standard). *On the left:* standard mixture corresponding to the injection of 0.2  $\mu\text{g}$  of each sugar. *On the right:* sugars of a strongly desaturated ferrallitic soil of the Niari valley (Congo). Hydrolysis according to the procedure described in "Attack Favouring the Measurement of Pentoses" earlier.



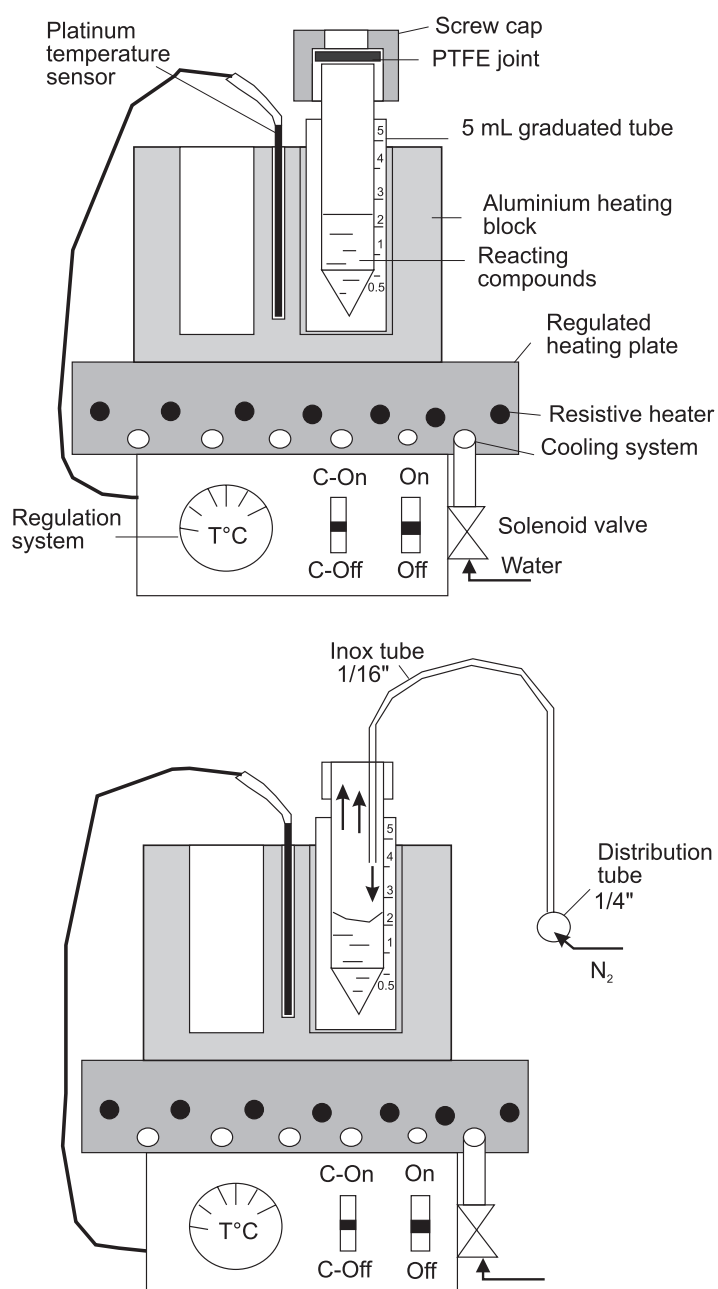

**Fig. 13.2** Recommended system for derivatization reactions for GPC. *Top*, reactions in closed micro-flasks at controlled temperature, *bottom*, evaporation of excess solvents and reagents under surface nitrogen flow

### 13.2.5 Quantification of Total Lipids

#### *Principle*

Total lipids are measured gravimetrically after extraction with organic solvents in a Soxhlet extractor. Most lipidic compounds of soils are not very polar, but some are slightly more so (Amblès et al. 1990). The choice of the polarity of the extraction solvent is thus significant, and preliminary tests should be performed. Fahd-Rachid (1993) used chloroform. A mixture of petroleum ether and ethyl acetate (3:1, v:v) is also often recommended and its toxicity is lower than chlorinated solvents. However, this mixture was considered to be less effective than chloroform for the extraction of complex lipids (Jambu et al. 1987).

Solvents do not extract all the lipids since some are associated with humic compounds, clays and various minerals. An acid treatment enables release of the bound lipids which then become accessible for a second Soxhlet extraction. Hydrochloric acid can be used for the acid pre-treatment but according to a technique recommended by Wang et al. (1969), it is better to use a mixture of hydrochloric acid and hydrofluoric acid. Hydrochloric acid enables release of lipids bound to cations, and hydrofluoric acid enables release of lipids bound to the organomineral matrix (Fahd-Rachid 1993).

#### *Equipment and Reagents*

- 200 mL Soxhlet extractor with condenser and a 500 mL borosilicate glass round bottom boiling flask with conical ground joints;
- Hemispherical electric heating mantle with temperature regulation for use with a 500 mL boiling flask;
- Soxhlet extraction cartridges 38 mm in diameter and 150 mm in height;
- Vacuum rotary evaporator;
- Pasteur pipettes;
- 25 mL half cylindrical half conical flasks of the volumetric type (graduation is not necessary) with PTFE joint screw cap;
- Glass funnels  $\phi$  3 cm;
- 250 mL plastic beakers;
- Plastic funnels  $\phi$  approx. 8 cm;
- Filter papers for plastic funnels;
- HCL–HF aqueous solution at 2.5% HF and 2.5% HCl and
- Petroleum ether:ethyl acetate extraction solution (3:1 v:v): mix 750 mL petroleum ether and 250 mL ethyl acetate.

---

**Procedure****Free Lipids**

- Put an exact weight  $P$  (100–150 g) of air-dried soil sieved to 2 mm in the extraction cartridge and put the cartridge in the Soxhlet extractor.
- Put 200 mL extraction solution and two pumice grains in the 500 mL boiling flask; connect the boiling flask to the Soxhlet extractor.
- Connect the condenser to the top of the extractor.
- Start heating the boiling flask and regulate the heat of the hemispherical mantle so as to obtain good condensation of the solvent from the condenser to the extractor.
- Continue the extraction for 48 h.
- Let cool then connect the boiling flask to the rotary evaporator and evaporate until the volume is reduced to a few mL.
- At the same time, tare a stopped 25 mL half cylindrical half conical flask (after drying in the drying oven and cooling).
- Open the flask and position it under a small funnel stopped with a glass wool plug and half filled with anhydrous sodium sulphate.
- Using a Pasteur pipette, decant the residue of evaporation into the small funnel and collect the dried extract in the 25 mL flask.
- Rinse the evaporation flask and the funnel several times with a few Pasteur pipettes of the extraction mixture to fill approximately 20 mL of the 25 mL flask.
- Evaporate the solvent from the flask under gaseous nitrogen flow (see Fig. 13.2) or under vacuum in the rotary evaporator by means of a ground/screwed connection.
- Stop the flask, let cool and weigh, by deduction of the tare one obtains the weight of free lipids  $P_1$ .
- Rate of free lipid =  $100 P_1/P$ .

**Bound Lipids**

- Place the residue of extraction of the free lipids in a 250 mL plastic beaker and add the HCL–HF solution at a rate of 150 mL for a test sample of 100 g soil.
- Leave in contact for 48 h agitating from time to time.
- Filter on filter paper in plastic funnels.
- Wash the residue with water until pH 5; decant it to a shallow cup or glass beaker cover and leave to dry on the lab table or in a desiccator.
- Extract the lipids using same procedure as for free lipids (cf. “Free Lipids” earlier).

### Total Lipids

It is possible to extract the total lipids directly by an attack of the initial sample with the HCL–HF mixture followed by extraction in the Soxhlet. Fahd-Rachid (1993) found excellent agreement between the total extracted lipids and those calculated by the sum “free lipids + bound lipids”.

### 13.2.6 Quantification of the Water-Soluble Organics

**Table 13.1.1.** Cold water soluble (CWS) and hot water soluble (HWS) compounds obtained on cultivated soils of Boigneville, France (Pansu, unpublished data, see extraction conditions in the text)

No.	weight % of CWS	C % in CWS	CWS C:N ratio	% CWS-C/total soil C	weight % of HWS	C % in HWS	HWS C:N ratio	% HWS-C/total soil C
A	0.026	28.8	2.1	0.75	0.85	8.3		7.1
B	0.033	33.8	2.5	1.12	0.48	22.3		10.7
D	0.004	75.0	2.1	0.30	0.26	21.5		5.6
E	0.021	27.1	1.4	0.57	0.24	25.1	5.5	6.0
F	0.025	30.1	1.8	0.75	0.38	22.4		8.5

For the study of the spatial and temporal dynamics of organic matter, the water-soluble organic fractions of the soil have to be taken into account. These fractions comprise organic acids, simple sugars or light polysaccharides and nitrogenous compounds. These different compounds can have a significant influence on the structural stability and fertility of the soils. Two types of compounds can be distinguished:

- Compounds that are soluble in cold water: these are obtained by agitating the soil with water using different procedures, for example, shake 10 g of soil in 200 mL water or 2 h on a rotary shaker, leave in contact overnight, sake again for 2 h and centrifuge at 14,000 g.
- Compounds that are soluble in hot water: several procedures can be used, for example, boil 4 g of soil at reflux for 16 h with 200 mL water in the presence of three glass balls, cool and centrifuge at 14,000 g. Kouakoua et al. (1997) showed that the extraction of water-soluble compounds of ferrallitic soils from Congo increased continuously with the length of extraction both in a drying oven and in an autoclave. According to Leinweber et al. (1995), this fraction is mainly made up of nitrogenous and carbohydrate compounds.

Table 13.1 lists proportions of these fractions expressed in mass, carbon and nitrogen contents for five cultivated soils in temperate zones.

In waterlogged or poorly aerated soils, the aqueous extracts contain organic acids of low molecular weight (e.g. lactic, pyruvic or acetic acid) under anaerobiosis conditions (Küsel and Drake 1999) which can be titrated in aqueous mediums by gas–solid chromatography (standard column of Porapak or Chromosorb 101, or similar) or by ionic chromatography. The aqueous extracts contains also inorganic water soluble compounds (cf. Chap. 18).

### 13.3 Complementary Techniques

#### 13.3.1 Determination of soil Carbohydrates by Gas Chromatography

If the alditol acetate technique (cf. Sect. 13.2.4) was the most widely used for the measurement of soil carbohydrates, other techniques have also been proposed: Morgenlie (1975) described separation of neutral sugars in the form of their *O*-isopropylidene derivatives. Preparation of the derivatives was performed with 1% sulphuric acid in acetone reagent, and separation required 35–40 min on columns of the XE60 or OV225 type. Traitler et al. (1984) separated trimethylsilyl derivatives of sugars on short apolar columns. Cowie and Hedges (1984) also separated trimethylsilyl derivatives from sugars from hydrolysates in plankton, sediment and wood. As a preliminary treatment, these authors brought free sugars to their mutarotation equilibrium in the presence of lithium perchlorate to get round the problem of multiple peaks. Larre-Larrouy and Feller (1997) and Larre-Larrouy et al. (2003) analyzed neutral sugars in soil at the same time as uronic acids and hexosamines in the form of their trimethylsilyl derivatives, each sugar being calculated by the sum of the surfaces of its different isomer forms.

#### 13.3.2 Carbohydrates by Liquid Chromatography

The techniques used for the titration of sugars with liquid chromatography were unsatisfactory for many years. Cheshire et al. (1969) separated eight neutral sugars by ion exchange chromatography with a pH gradient, but separation took 14 h. At the column exit, sugars were analyzed by colorimetry after reaction with the orcinol in the sulphuric acid reagent. Hydrazide of *p*-hydroxybenzoic acid is a better reagent for alkaline eluates; without acidification it gives a yellow colour with carbohydrates.

Hamada and Ono (1984) analyzed sugars on soils of volcanic ash by high performance liquid chromatography (HPLC) with an anion column and detection by fluorescence spectroscopy after reaction with ethanolamine. Separation required 70 min but arabinose, fructose and fucose were eluted under the same peak, as were rhamnose and ribose. Pluijmen (1987) analyzed sugars of different plants by HPLC on a SUGAR PAK™ column (Waters Associates) with a water (or acetonitrile–water) mobile phase, refractometric detection and an anion and cation precolumn. But this author was especially concerned with glucose and fructose and did not provide chromatograms.

Reim and Van Effen (1986) used a technique that appeared to be more promising. They proposed a new detector that was more sensitive than the refractometer and which, in addition, did not require preliminary derivatization reactions as do spectrometric methods. Using an ion exchange column, they simultaneously separated simple sugars and low molecular weight oligomers, but they did not provide a chromatogram of the eight main soil sugars.

Angers et al. (1988) separated sugars from hydrolysates of soils on an aminex HPX-87P column (BIO-RAD labs); but they titrated only five sugars and the detection limit was rather poor.

Martens and Frankenberger (1990) separated ten soil sugars by anion exchange chromatography using the HPAC-PAD system (Dionex, Sunnyvale, CA, USA) with the following chromatographic conditions (Fig.13.3):

- 200 µL injection loops;
- CarboPac PA guard column (25 × 3 mm);
- Chromatographic column (250 × 4 mm) filled with a pellicular anion exchange resin: CarboPac PA1;
- Flow of eluent: 0.8 mL min<sup>-1</sup>, ambient temperature;
  - eluent a: purified inorganic water (18 Mohm),
  - eluent b: 50 mmol (NaOH) L<sup>-1</sup> + 1.5 mmol (CH<sub>3</sub>COONa) L<sup>-1</sup> aqueous solution,
  - 93% eluent a and 7% eluent b for 15 min, gradient up to 100% b in 25 min,
  - idem the mobile phase has to be degassed to prevent absorption of CO<sub>2</sub> and the production of carbonates which can move ions and reduce the retention time;
- Detection by pulsed amperometry three times with a gold electrode:
  - E1: 0.1 V, t1: 300 ms, oxidation of CHOH groups,
  - E2: 0.6 V, t2: 120 ms, displacement of the reaction products,
  - E3: -0.8 V, t3: 300 ms, cleaning of the electrode at negative potential,response time: 1.

The study of Martens and Frankenberger (1990) showed that the HPAC-PAD system had several advantages over another classical HPLC system with detection by refractive index: it produced more precise results, was twice as sensitive (pmole) and had better resolution. The preparation of the soil samples was also simpler in the HPAC-PAD system. After acid attack (cf. Sect. 13.2.1), the samples were treated with 1 mL 0.1 mol (EDTA) L<sup>-1</sup> solution then brought to pH 4 by adding 5 mol (NaOH) L<sup>-1</sup> solution and centrifuged at 10,000 g. The coloured materials were then removed by filtration on a solid phase extraction column (SPE) (Supelco™ Bellefonte, Pa, USA) comprising 3 mL of strong cation exchange resin (three propylsulfonic acid, H<sup>+</sup> form) and 3 mL of strong anion exchange resin (quaternary propylammonium 3, Cl<sup>-</sup> form). The extracts were also filtered on 0.22 µm GS filters (Millipore, Bedford, MA, USA).

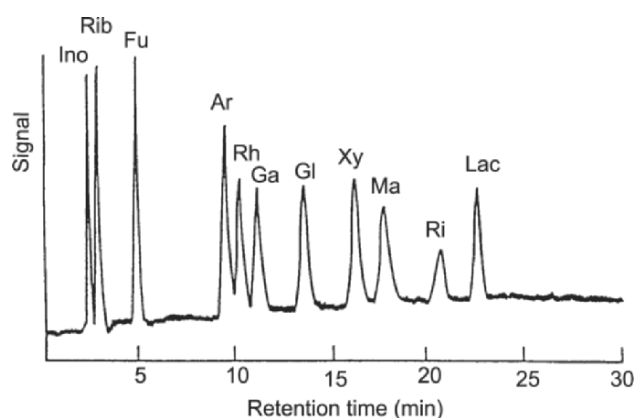

**Fig. 13.3.** Standard sugar separation by high performance anion exchange chromatography (Martens and Frankenberger 1990); Ino, inositol; Rib, ribitol; Fu, fucose; Rh, rhamnose; Ga, galactose; Gl, glucose; Xy, xylose; Ma, mannose; Ri, ribose; Lac, lactose

Bernal et al. (1996) proposed a chromatographic technique similar to that of Martens and Frankenberger (1990) for sugar titration in coffee and wine.

### 13.3.3 Fractionation and Study of the Soil Lipid Fraction

#### *Lipid Fractionation*

There are many lipid fractionation techniques and the reader is advised to consult relevant handbooks that describe biochemical lipidology techniques, e.g. Kates (1975).

Fractionation can be divided into two stages:

- Separation of the different classes of lipids and
- Measurement of the individual components of each class or of the total fraction.

The exact procedure to apply depends on the lipid concerned. Most lipids of microbial and animal origin contain from 60 to 85% of phosphatides and glycolipides, the remainder being neutral or not polar lipids (glycerides, sterols, hydrocarbons, pigments). Lipids of plant origin contain a larger proportion of neutral lipids and a smaller proportion of phosphatides.

Two main types of techniques are used to separate the classes of lipids:

- Fractionation by solvents and
- Liquid phase chromatography on column, on paper or on thin layer.

The characterization and quantification of lipid components require the chemical breakdown of complex lipids followed by separation techniques such as gas chromatography, generally with a flame ionization detector, possibly coupled with a mass spectrometer for the identification of the molecules.

#### *Fractionation by Solvents*

Precipitation by acetone is the simplest method for separating phosphatides and neutral lipids. It is based on the insolubility in cold acetone (0°C) of most phosphatides (particularly of acid phosphatides in salt forms), whereas neutral lipids are soluble. This procedure is well suited for lipids of animal and microbial origin, but is less effective in the presence of high proportions of neutral lipids like most lipids of plant origin (Kates 1975).

The techniques for separation of nonmiscible pairs of solvents (polar and non-polar) are also useful, especially for lipids rich in glycerides. As the first stage of the soil lipid fractionation, Stevenson (1982) recommended the separation of chloroform and an aqueous soda solution. The aqueous phase was then acidified and extracted with ether to recover the free fatty acids. The chloroform phase contains the other lipids which were then separated by chromatography.

#### *Fractionations by Liquid Phase Chromatography*

Many methods have been proposed. For preliminary fractionation of the total lipidic extract of the soil, Jambu et al. (1991, 1993) and Amblès et al. (1989, 1990) used the technique recommended by McCarthy and



Duthie (1962). Lipids were separated on columns of potassic silica (silicic acid treated with potash in isopropanol) in three fractions: neutral (the first elution with ethyl ether), acid (elution with 2% formic acid in ether solution) and polar. Zelles and Bai (1993) used a similar technique with SPE.

It was then possible to separate the neutral fraction of lipids on silica columns (Kieselgel 60, Merck, Jambu et al. 1993) or Florisil treated or not with acid (Kates 1975). Elution was carried out initially by hexane or petroleum ether to separate hydrocarbons then by mixtures of increasing polarity to split the other classes of lipids. Mixtures with an increasing proportion of ethyl ether in petroleum ether were used most frequently enabling successive separation of esters (sterilic, methyl esters), ketones, triglycerides, diglycerides, monoglycerides, free alcohols and sterols.

### ***Gas–Liquid Chromatography Techniques***

These techniques are often used for fractionation, characterization and quantification of lipid components. They can be applied directly to certain fractions like hydrocarbons or after breakdown of the heavy lipidic compounds into fatty acids and unsaponifiable products (cf. “Fractionation of Fatty Acids and Unsaponifiables”).

### ***Fractionation of Fatty Acids and Unsaponifiables***

#### ***Principle***

A saponification reaction enables breakdown of heavy lipidic substances to obtain fatty acids, and other saponification products (like glycerol and sterols) with unsaponifiable compounds. The fatty acids are then methylated, separated, and quantified by Gas–Liquid Chromatography (GLC), the unsaponifiables are also titrated by GLC after silylation of the hydroxyl groups. The technique can be used for total lipidic extracts or for lipid groups that have already been separated as described in “Lipid Fractionation” earlier.

#### ***Equipment and Reagents***

- F1 flasks: 25 mL half cylindrical half conical borosilicate glass flasks, (volumetric flasks without graduation, cf. “Equipment and Reagents” earlier under Sect.13.2.5 and Fig. 13.4) with PTFE screw cap.
- F2 flasks: 25 mL half cylindrical half conical flasks with PTFE screw cap.
- F3 flasks: 10 mL half cylindrical half conical borosilicate glass flasks, (volumetric flask without graduation) with PTFE screw cap.

- F4: half cylindrical half conical borosilicate glass volumetric tubes with PTFE screw caps.
- Funnels with a diameter of 3 cm.
- Pasteur pipettes.
- 0.1 mg precision balance.
- Gas phase chromatograph with splitter or “split-splitless” injector for capillary column and detection by flame ionization detector.
- Anhydrous petroleum ether.
- Anhydrous methanol (stored on anhydrous sodium sulphate).
- 0.3 mol (NaOH) L<sup>-1</sup> solution in methanol: dissolve 1.2 g of soda in 100 mL anhydrous methanol.
- 3% H<sub>2</sub>SO<sub>4</sub> methanolic solution: add 3 mL of concentrated sulphuric acid in a 100 mL volumetric flask containing 70 mL anhydrous methanol, agitate and cool, adjust to 100 mL and stop well.
- 60% methanol in water.
- Anhydrous sodium sulphate.

### *Procedure*

#### **Saponification**

- Add 4 mL of petroleum ether and 2 mL methanol in the 25 mL F1 flasks containing the free or bound lipidic extracts (cf. “Procedure” under Sect. 13.2.5), agitate for 1 h.
- Add 8 mL of 0.3 mol (NaOH) L<sup>-1</sup> solution in methanol.
- Stop the flasks hermetically and heat at 100°C for 2h30 in a thermostated aluminium heating block (Fig. 13.2).
- Cool, open the flasks and add 60% methanol in such a way that the petroleum ether phase is in the upper cylindrical part of the flask.
- Using a Pasteur pipette, take the upper phase and decant it in a tared 25 mL conical F2 flask through a small funnel stopped with a glass wool plug and filled with a spatula of anhydrous sodium sulphate (Fig. 13.4).
- Add 3 mL of petroleum ether to the first F1 flask; stop and agitate well then remove the upper phase in the same way and add it to the previous phase through the same device; repeat this procedure four times. This phase contains unsaponifiables and saponification products other than fatty acids (F2).
- Acidify the first flask with 1 mL of concentrated hydrochloric acid diluted two times, then extract again with petroleum ether as previously described. Decant and collect the upper phase in a tared 10 mL F3 flask; this phase contains the fatty acids.

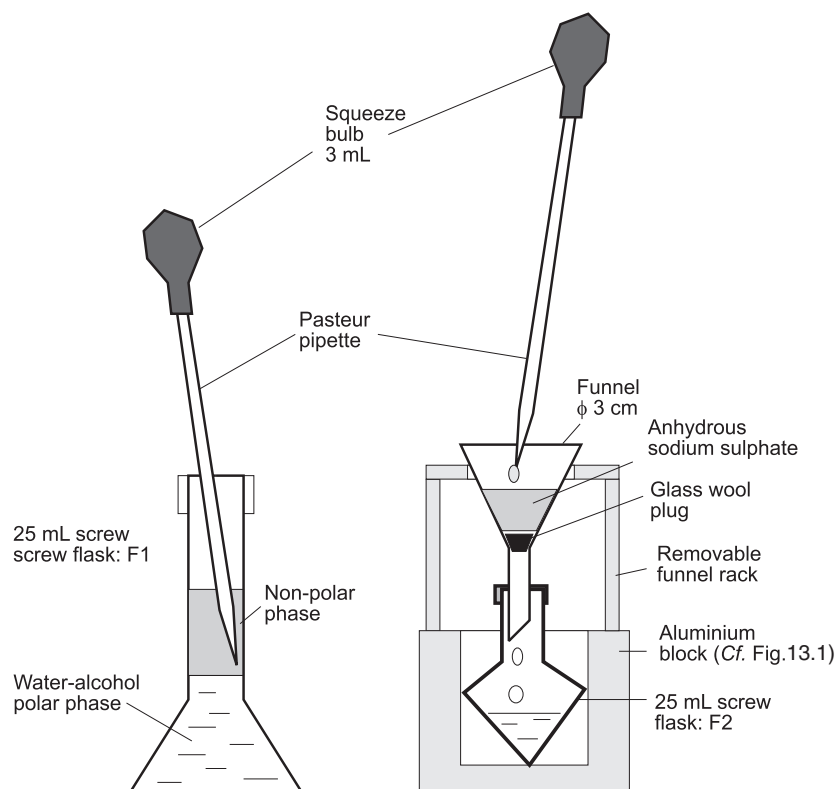

**Fig. 13.4.** Separation by decantation (*on the left*) and drying of the recovered products (*on the right*)

#### Non Fatty Acid Compounds

- Evaporate the contents of the F2 flask to dry under nitrogen flow or with a rotary evaporator.
- Stop and weigh the flask to obtain the total quantity.
- Add 100  $\mu\text{L}$  of trimethylchlorosilane (TMCS), 300  $\mu\text{L}$  of hexamethyldisilane (HMDS) and 600  $\mu\text{L}$  pyridine, stop and heat at 70°C for 5 h (Fig. 13.2).
- Inject 2  $\mu\text{L}$  in the gas phase chromatograph under the following conditions:
  - (a) CPWAX capillary column (or similar) length: 25 m, interior diameter: 0.3 mm, temperature 230°C,
  - (b) carrier gas He 0.5 B,
  - (c) split injector, leak flow 50 mL min<sup>-1</sup>.

### Fatty Acids

- Bring the contents of the 10 mL F3 flasks to dry and weigh to obtain total fatty acids.
- Add 3 mL of anhydrous 3% sulphuric acid in the methanol reagent; stop the flasks and heat at 70°C for 5 h (Fig. 13.2).
- Let cool and add 2 mL petroleum ether and approximately 3 mL water to recover the ether phase in the cylindrical part of the flask (Fig. 13.4).
- Recover the fatty acid methyl esters in 10 mL F4 tubes using the same procedure as for the non-fatty acid lipidic fraction, complete to 10 mL and inject 2  $\mu$ L in GPC under the following conditions (short acids  $\leq$  C20, Fig. 13.5):
  - (a) 25 m  $\times$  0.3 mm silica glass capillary column impregnated with CPWAX phase (or similar),
  - (b) He carrier gas, input pressure 0.6 B,
  - (c) Split injector 180°C, leak-flow 60 mL min<sup>-1</sup>,
  - (d) Temperature programme 180°C  $\xrightarrow{2^\circ\text{C min}^{-1}}$  240°C,
  - (e) Flame ionisation detector, 240°C.

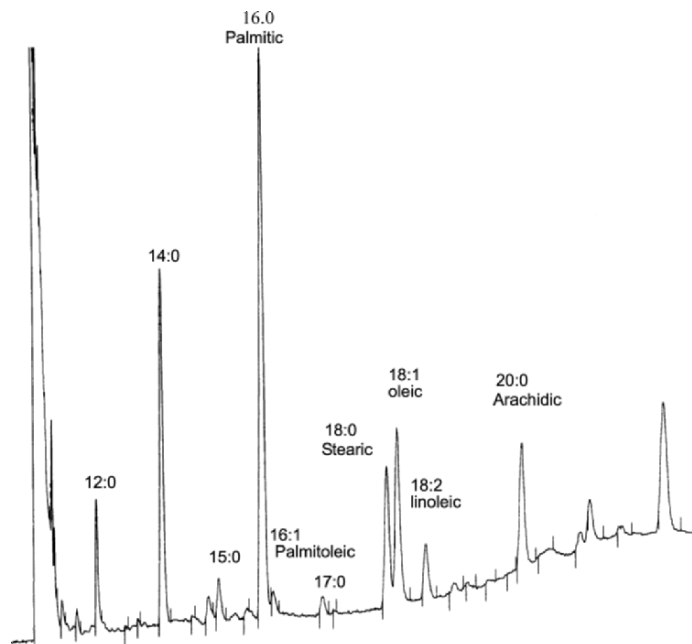

**Fig. 13.5.** Fractionation of methyl esters of short fatty acids of a tropical ferruginous soil from Burkina-Faso by gas chromatography (conditions described in the text; M Pansu, unpublished data)

### Notes

- Some reagents are much faster than MeOH–H<sub>2</sub>SO<sub>4</sub> making it possible to obtain fatty acid methyl esters instantaneously at room temperature (e.g. BF<sub>3</sub>–CH<sub>3</sub>OH or diazomethane); the reagent described in “Procedure” under Sect. 13.3.3 earlier was used because it is not expensive and the heating system is suitable for derivatization.
- For soils poor in fatty acids, the 10 mL volumetric half cylindrical half conical F4 tubes are very useful for the concentration of the mixture by solvent evaporation under nitrogen flow.
- The chromatographic column used to obtain separation of Fig. 13.5 is not suitable for the fractionation of long chain fatty acids of soil (C<sub>20</sub>–C<sub>34</sub>); for this purpose a shorter column or a different impregnation phase is required.
- The procedure described in “Equipments and Products” later can be simplified for the determination of fatty acids alone; use direct transmethylation on the lipidic fraction with the H<sub>2</sub>SO<sub>4</sub>–methanol reagent; extract the fatty acid methyl esters by decantation in petroleum ether after adding water (Fig. 13.4); however, this technique may complicate the reading of the chromatograms due to a risk of peaks of fatty acid methyl esters overlapping peaks of unsaponifiable compounds.

### 13.3.4 Measurement of Pesticide Residues and Pollutants

#### Principle

Like lipids, pesticides and pollutants are soluble in organic solvents. They can be extracted using similar techniques (cf. Sect. 13.2.5), although extraction with the Soxhlet apparatus is not recommended for pesticides. Indeed, the molecules are often degradable and prolonged boiling of the mixture of solvent and extracted products could lead to underestimation of the contents of residues.

Due to problems of degradability, the most commonly used methods use cold extraction in solvents, specially micro-methods (Steinwandter 1992) and methods using supercritical fluids (Richter 1992; Table 13.2). If the soil samples have to be stored before extraction, they should be frozen or freeze-dried.

After the extraction phase, if lipid content is high, purification may be necessary. Two techniques are available (a) separation using solvents of different polarities and (b) liquid chromatography on a Florisil or alumina column.

It is usually necessary to concentrate the soil extracts as much as possible to improve the limit of detection. It is useful to carry out the final

concentration phase using a gaseous nitrogen flow on the surface of the extract in half cylindrical half conical volumetric tubes (cf. Sect. 13.3.3).

**Table 13.2.** Some supercritical fluid techniques used for the extraction of soil pesticide residues (Richter 1992)

pesticide	extraction conditions
permethrin, atrazine, deltamethrin, dieldrin, carbofuran, diuron, 2,4 D, methylparathion	Methanol 250°C, 150 bars, 1 mL min <sup>-1</sup> , 2 h
DDT	CO <sub>2</sub> , 40 °C, 100 bars, 0.7 g s <sup>-1</sup> , 10 min
DDT	CO <sub>2</sub> + 5% methanol or toluene, 40 or 100°C, 0.7 g s <sup>-1</sup> , 5 min
lindane, aldrin, DDT	CO <sub>2</sub> , 138 bars, 15 min
linuron, diuron	CO <sub>2</sub> + methanol, ethanol or acetonitrile, 75 to 120°C, 100–400 bars, 2.5–8.5 mL min <sup>-1</sup> , 15–180 min
sulfonylurea	CO <sub>2</sub> + 2% methanol, 40°C, 223 bars, 6 mL min <sup>-1</sup> , 2–15 min
simazine, atrazine, propazine, terbutylazin, cyanazine	CO <sub>2</sub> to 48°C, 230 bars, 1.7 mL min <sup>-1</sup> , 30 min
organochlorides, organophosphorus	CO <sub>2</sub> 100% and CO <sub>2</sub> + 10% methanol, 50–70°C, 150 or 300 bars, 25–60 min
DDT, DDE, DDD, lindane, aldrin	CO <sub>2</sub> + 5% acetone, 75°C, 400 bars, 60 min

The recommended choice for the analysis of the extract is gas chromatography because of (a) its good selectivity, particularly with capillary columns and (b) the large number of selective and very sensitive detectors that are available. The recommended injector for most non-volatile pesticides is a glass-needle injector which ensures the maximum possible concentration of the solutes during injection. Alternately split-splitless injector can be used. Other techniques are based on HPLC, generally with UV detection.

The diversity of the pesticides and pollutants present in the soil (cf. Sect. 13.1.4 later) has resulted in the development of a very large number of specific analytical procedures which cannot be exhaustively described here. Based on the literature and laboratory practice, a choice of procedures for the extraction, purification and chromatographic analysis of the main families of products is provided later. In the future, these procedures will change as a result of further advances in analytical chemistry and some of the recommendations later will need to be

updated. For example, Gennaro et al. (1996) presented the simultaneous separation of phenoxyacetic acid, triazines and phenylureas herbicide residues in soils by HPLC. Celi et al. (1993) proposed a way of measuring fenoxatrop and ethyl fenoxatrop in a range of soils. Anon (1993) proposed a method for the simultaneous measurements of 27 herbicides in the soil using HPLC. Kiang and Grob (1986) proposed a method for simultaneous measurement of 49 soil pollutants by capillary gas chromatography.

### ***Equipment and Products***

- Back and forth shaker.
- Decanting funnels in borosilicate glass with ground Teflon stoppers: 50, 125, 250 mL.
- Columns for liquid chromatography, diameter: 1 cm, length: 50 cm, with a PTFE stopcock and a solvent tank.
- 10 mL half cylindrical half conical volumetric tubes.
- Rotary evaporator with 50, 125, 250 mL boiling flasks.
- Regulated aluminium heating block and system of evaporation under flow of nitrogen (Fig. 13.2). Alternatively, a centrifugal evaporator under vacuum, type: speed-vac, can be used.
- Gas phase chromatograph with several selective detectors (e.g. electron capture detector for halogenated compounds, thermoionic detector for organophosphorous compounds) and non-selective (e.g. flame ionization or mass spectrometry). The use of a glass needle injector is recommended, or failing that a split-splitless or on column injector (Pansu et al. 2001).
- HPLC with UV detector if required;
- Certified solvents, free from pesticides and pollutants. Each solvent should be tested by injection in the chromatograph after concentration by evaporation in the rotary evaporator (approximately 200 mL giving 1 mL). The most commonly used solvents are acetone, petroleum ether, hexane, ethyl ether, methanol, acetonitrile, dichloromethane, ethyl acetate.
- Different standard pesticides.
- Activated florisil (60–80 mesh particle size, 3% of water).
- Anhydrous sodium sulphate.
- Sodium chloride.

## **Extractions**

### ***Acid Herbicides***

Jensen and Glass (1990) tested several techniques before recommending cold extraction with ethyl ether in acid medium. When well agitated for a rather long period, this technique is effective even for residues that have been incorporated in the soil for a year. A sufficient volume of water and acid have to be added to reduce the viscosity of the soil sample and ensure good contact with the ether phase. The authors advised three successive extractions with ether and one hour agitation each time.

### ***Triazine Herbicides***

Several different solvents can be used. For extractions in aqueous medium, a mixture of ethyl ether and petroleum ether (v/v) may be appropriate. For soils, we prefer a 1/5 mixture of methylene chloride and ethyl acetate. We recommend three successive extractions with a back and forth shaker on 20 g of sample with respectively, 100, 50 and 50 mL of solvent mixture.

### ***Organochlorides***

Wheeler and Thompson (1990) reviewed the large number of techniques used for the extraction of this type of compound. Methods used for soils are often based on those used in food analysis. A simple way is to agitate the soil sample (50 g) with acetone (100 mL) or an acetone-petroleum ether mixture on a back and forth shaker. With a wet sample, add anhydrous sodium sulphate as desiccant.

### ***Organophosphorous***

Freeze-drying is usually advised for the conservation of soil samples. Several solvents or mixtures of solvents have been used for standard extraction of organophosphorous compounds in the soil: acetone, acetone–water, dichloromethane, ethyl acetate, acetone–hexane, acetone–dichloromethane, methanol–water (Barcelo and Lawrence, 1992). These compounds can be extracted jointly with organochlorides (acetone, acetone–hexane), pyrethrinoids (acetone–hexane), and carbamates (acetone–dichloromethane).

### ***Carbamates***

Carbamates can be titrated with a rather complex technique of multi-residue analysis (Seiber 1990). The following method was tested by Pansu et al. (1981a) with an average extraction yield of  $72 \pm 8\%$ . Prepare the soil samples by freeze-drying, sieve to 2 mm particle size and divide into sample specimens of 10 g each. Shake the sample specimen with 50 mL methanol and 50 mL water for 6 h on a back-and-forth shaker, add



100  $\mu\text{L}$  of 1 mol (HCl)  $\text{L}^{-1}$  solution and filter under vacuum. Wash the residue with the extraction solution and add the washing solutions to the filtrate. Extract the filtrate three times in a 200 mL decanting funnel with respectively, 30, 20 and 20 mL chloroform.

### *Pyrethrinoids*

In biological substrates, pyrethrinoids are extracted satisfactorily by two successive extractions with hexane in the presence of anhydrous sodium sulphate (Pansu et al. 1981b). For soils, a mixture of hexane with 3% acetone is more efficient.

## **Preparation of the Extracts for Chromatography**

### *Principle*

Most extracts have to be purified before chromatography to eliminate interference with other lipidic compounds in the soil. The use of detectors that are selective for the main families of products (such as organochlorides or organo-phosphorus) makes it possible to limit the number of purifications. However, some of these detectors (electron capture for example) are very sensitive to pollution and the extracts need to be purified so as not to perturb the sensitivity of the detector.

The extracts should be concentrated as much as possible to improve detection of ultra-trace residues. Extracts are usually concentrated in vacuum rotary evaporators during the first stage by micro-techniques such as gaseous nitrogen flow (Fig. 13.2) or a speed-vac centrifugal evaporator in the final stage. If too polar solvents are used for extraction (not easily eluted from chromatographic columns) or if they are incompatible with the detection system, the extract may have to be transferred into another solvent before injection. For example, if an electron capture detector is being used, chlorinated solvents have to be completely eliminated before injection. Except for volatile pesticides, this is accomplished by drying the extract several times, each time with dissolution in a non-halogenous solvent.

Finally, some polar compounds require derivatization reactions before injection into the chromatograph.

### *Acid Herbicides*

Purification can be achieved by separation into solvents (Jensen and Glass 1990). The ether extracts (see "Acid Herbicides" in "Extractions" under Sect.13.3.4) are agitated with a sodium bicarbonate aqueous solution. In the aqueous solution, acid herbicides are transformed into salts, while the

majority of the coloured organic compounds remain in the organic phase. This phase is eliminated, and the acid herbicides are re-extracted with ether after acidification of the aqueous phase and saturation by sodium chloride.

If gas chromatography is used for analysis, the extracts usually need to be methylated before injection, as acid herbicides are too polar. Several different reagents can be used in techniques similar to fatty acid methylation (cf. "Procedure" under Sect. 13.3.3 earlier). Diazomethane is a particularly effective methylation agent.

### *Triazines*

The main lipids can be eliminated by acetonitrile-hexane partition. Concentrate the methylene chloride-ethyl acetate extracts to 2 mL (cf. "Triazine Herbicides"). Add 20 mL acetonitrile saturated with petroleum ether (AN). Add 10 mL petroleum ether saturated with acetonitrile (PE) and agitate. Recover the AN phase. Re-extract PE with 10 mL AN. Discard PE. Add all the AN phases in the decanting funnel, add 120 mL water and 10 mL of a NaCl saturated aqueous solution. Extract triazines twice with 50 mL of the ethyl ether/petroleum-ether v/v mixture. Mix the ether phases, dry on sodium sulphate and concentrate to the exact volume desired (2 mL for example) before injection.

### *Organochlorides*

First the acetone extract must be transferred in a hexane phase. Put the acetone extract in a decanting funnel (cf. "Organochlorides" earlier in "Extractions" under Sect. 13.3.4) with four times its volume of water and 25 mL hexane. Swirl gently and decant the organic phase. Extract the aqueous phase again with 25 mL hexane, mix the hexanic extracts, dry on anhydrous sodium sulphate and concentrate to 5 or 10 mL.

Purify the extracts on a column filled with activated Florisil (3% water). Weigh 5 g of Florisil and place it in a column with a diameter of 1 cm stopped with a glass wool plug and partially filled with petroleum ether. Add 2–3 cm of anhydrous sodium sulphate, rinse with 50 mL hexane until the liquid comes to the top the sodium sulphate phase.

Deposit the hexanic extract on the column with a Pasteur pipette. Regulate the flow to approximately 15–20 drops per minute with the PTFE stopcock. When the level of the liquid comes to the top of the sodium sulphate phase, add a little hexane while rinsing with the pipette; repeat this procedure once. Elute with exactly the volume of hexane needed to obtain PCB, i.e. approximately 20–30 mL. This E1 eluate may also contain hexachlorobenzene (HCB) and dichlorodiphenylethane (DDE), one of the breakdown products of DDT. The exact quantity of solvent for the E1 eluate must first be determined under the same

conditions with standard mixtures. For PCB, these standards are made of sets of products providing typical chromatograms (e.g. dp5 and dp6 mixtures).

After collection of the E1 eluate, elution should be continued with the 10% of dichloromethane in the petroleum ether (or hexane) mixture until a sufficient volume has been obtained for collection of the other organochlorinated compounds (E2 eluate). The exact volume of E2 should first be determined with one or more standard compounds, dieldrin for example.

The E2 eluate has to be removed from the dichloromethane. Bring just to dry in a rotary evaporator. Add a little petroleum ether and bring just to dry again. Repeat this operation four or five times. Bring the E1 and E2 eluates to the exact volume of hexane chosen for chromatographic titration.

### *Organophosphorous*

First the acetone extract has to be transferred in a hexanic phase. Place the extract in a decanting funnel (cf. "Organophosphorous" earlier in "Extractions" under Sec. 13.3.4) with four times its volume of water and 25 mL methylene chloride. Swirl gently and decant the organic phase. Extract again with 25 mL methylene chloride, mix the extracts, dry them on anhydrous sodium sulphate and evaporate just to dry in a rotary evaporator. Add a little petroleum ether and bring just to dry again. Repeat this procedure three times. Rinse several times with 10 mL total volume of hexane at 10% of acetone, mix the rinsing solutions, stop and store for chromatographic determination.

### *Carbamates*

Chloroformic extracts (cf. "Carbamates" earlier in "Extractions" under Sect. 13.3.4) can be purified in the following way. Evaporate to dry, recover in 10 mL methanol + 10 mL 0.1 mol (HCl) L<sup>-1</sup> solution, cool 15 min, filter the suspended matter and wash the filter with a v/v mixture of water and 0.1 mol (HCl) L<sup>-1</sup> solution. Extract the filtrate three times with 25 mL chloroform, dry the extracts on anhydrous sodium sulphate and transfer in a 100 mL round bottom boiling flask. To eliminate the chloroform, evaporate just to dry on the rotary evaporator, add a little methanol and again evaporate just to dry, repeat this procedure three times. Finally transfer in exactly 10 mL methanol in half cylindrical half conical volumetric tubes with screw caps, washing several times the boiling flask with a few mL of methanol. If the injection in the chromatograph cannot be carried out immediately, store at -20°C. To improve the detection limit the extract can be concentrated in the tubes under nitrogen flow at 40°C (Fig. 13.2).

*Note:* Some carbamates can also be transformed into glycosides by plants. During extraction (See “Carbamates” in “Extractions” under Sect. 13.3.4) these forms are not found in the chloroformic fraction, but remain in the hydro-alcoholic fraction. To identify them, it is necessary to break the glycoside bonds by reflux boiling saponification and to re-extract with chloroform (Pansu et al. 1981a).

### ***Pyrethrinoids***

The extracts of “Pyrethrinoids” in “Extractions” under Sec. 13.3.4 should be purified before being injected in a chromatograph equipped with an electron capture detector. Purification is carried out on chromatographic columns (diameter 1 cm) filled with 5 g Florisil at 3% of water and 2 g of anhydrous sodium sulphate.

Two different procedures are used for extracts that contain fat substances and extracts that do not (Pansu et al. 1981b). In the absence of lipids, pyrethrinoids are recovered by elution with 70 mL of a mixture of 10% ethyl ether in petroleum ether. In the presence of lipids, preliminary elution with approximately 110 mL hexane enables elimination of the lipids before pyrethrinoid elution as previously described. The exact volumes of the eluting solutions must first be determined by tests with standard pyrethrinoids (deca-methrin) and by gravimetry of the eluted fat substances. Bring the eluate containing the pyrethrinoids just to dry and dissolve again in exactly 10 mL hexane in a half cylindrical half conical volumetric tube with a PTFE screw cap for chromatographic determination. To improve detection, the extracts can subsequently be concentrated in the tubes.

### ***Chromatographic Determination***

A large range of columns and chromatographic conditions are suitable for the determination of pesticides and pollutants, among which the techniques later are worth mentioning.

### ***Acid Herbicides***

The measurement of acid herbicides by GPC requires preliminary methylation of the acid functions (cf. “Fractionation of Fatty Acids and Unsaponifiable” earlier). For the separation of methylated esters of 2,4D and 2,4,5T, use a column 1.5 m in length with an interior diameter of 4 mm filled with a 5% OV225 phase on a ChromosorbW support of 100–120 mesh particle size at an isothermal temperature of 220°C, with an electron capture detector. Acid herbicides can also be measured by liquid chromatography.

### *Triazines*

Atrazine and simazine can be measured by GPC under similar conditions to those described earlier for acid herbicides but using a thermionic detector. For simultaneous measurement of all nitrogenized herbicides, it is preferable to use a capillary column such as PTE5 30 m  $\times$  0.25 mm ID (Supelco), with a temperature programme of 40°C (5 min) to 100°C (30°C min<sup>-1</sup>) then to 275°C (5°C min<sup>-1</sup>).

### *Organochlorides*

For measurement of the residues, the best sensitivity is obtained with GPC on an electron capture detector. Different types of impregnation phases can be used for the columns, e.g. SE30, OV1, or OV225.

For fractionation of the many PCB peaks, a silica glass capillary column of the SPB-octyl type (Supelco) is recommended, 60 or 30 m in length depending on the temperature programme, with an interior diameter of 0.25 mm and with a 0.25  $\mu$ m SPB-octyl film.

For chlorinated pesticides, use a capillary column of the SPB-5 type, length: 15 m, interior diameter: 0.20 mm, with a 0.20  $\mu$ m Supelco film and a temperature programme of 120–290°C.

### *Organophosphorous Pesticides*

Organophosphorous pesticides are usually measured by GPC with a thermionic detector or possibly by mass spectrometry. Different columns have been recommended for organochlorinated compounds. A capillary column of the PTE-5 type, length: 30 m, interior diameter: 0.25 mm, with a 0.25  $\mu$ m Supelco film is recommended for the fractionation of a mixture of nine organophosphorus pesticides, with a temperature programme of 50–300°C.

### *Carbamates and Urea Derived Pesticides*

Carbamates and urea derived pesticides can be fractionated by high pressure liquid chromatography with a Supelcosil LC-8 column, length: 15 cm, interior diameter: 4.6 mm, particles of 5  $\mu$ m (Supelco) with an acetonitrile water gradient of 18–65% in 9 min, flow 2 mL min<sup>-1</sup>, temperature 40°C and UV detection at 240 nm.

Another technique enables measurement of all *N*-methyl carbamates by GPC in only one peak (Pansu et al. 1981a). The injected mixture is transmethylated in situ at the top of the chromatographic column and the peak of the resulting *O*-methyl *N*-methyl carbamates is quantified at the exit of the column. The conditions are as follows: a thermionic detector, a Pyrex column, length: 1.4 m, interior diameter: 2 mm, filled with chromosorb 101 (80–100 mesh) on 1.3 m and with Volaspher A2 (80–100 Mesh, transmethylation catalyst) on the last 10 cm near the injector, carrier gas N<sub>2</sub> at 30 mL min<sup>-1</sup>. Inject 2  $\mu$ L of the mixture: 950  $\mu$ L of the methanolic

extract (see Carbamates) + 50  $\mu\text{L}$  of a 0.2 mol (NaOH)  $\text{L}^{-1}$  methanol solution prepared just before injection.

### *Pyrethrinoids*

These rather heavy and unstable products can nevertheless be measured by electron capture GLC using short columns and strong carrier gas flows to minimize decomposition (Pansu et al. 1981b). For the simultaneous titration of permethrine and decamethrine, use a column 80 cm in length with an interior diameter of 4 mm filled with 3% SE30 on a chromosorb W, 80–100 Mesh, with a column temperature of 215°C, using nitrogen as carrier gas at a flow of 85  $\text{mL min}^{-1}$ .

## References

### Soil carbohydrates

- Angers DA, Nadeau P and Mehuys GR (1988) Determination of carbohydrate composition of soil hydrolysates by high-performance liquid chromatography. *J. Chromatogr.*, 454, 444–449
- Arshad and Schnitzer (1987) Characteristics of the organic matter in a slightly and in a severely crusted soil. *Pflanzenernahr Bodenk.*, 150, 412–416
- Bachelier G (1966) Les sucres dans les sols et leur dosage global. *Cah. ORSTOM Ser. Pedol.*, 4, 9–22
- Bagautdinov FY, Khaziyev FK and Shcherbukhin VD (1984) Polysaccharide fraction of humic substances from a typical chernozem and a gray forest soil. *Soviet Soil Sci.*, 16, 37–42
- Baldock JA, Kay BD and Schnitzer M (1987) Influence of cropping treatments on the monosaccharide content of the hydrolysates of a soil and its aggregate fractions. *Can. J. Soil Sci.*, 67, 489–499
- Barriuso E, Andreux F and Portal JM (1985) Etude de la répartition des glucides associés aux constituants humiques dans un sol humifère de montagne. *C.R. Acad. Sci. Paris*, 300, II, 16, 827–830
- Benzing-Purdie LM and Nikiforuk JH (1989) Carbohydrate composition of hay and maize soils and their possible importance in soil structure. *J. Soil Sci.*, 40, 125–130
- Bernal JL, Del Nozal MJ, Toribio L and Del Alamo M (1996) HPLC analysis of carbohydrates in wines and instant coffees using anion exchange chromatography coupled to pulsed amperometric detection. *J. Agric. Food Chem.*, 44, 507–511
- Blakeney AB, Harris PJ, Henry RJ and Stone BA (1983) A simple and rapid preparation of alditol acetates monosaccharide analysis. *Carbohydrate Res.*, 113, 291–299
- Brink RH, Dubach P and Lynch DL (1960) Measurement of carbohydrates in soil hydrolysates with anthrone. *Soil Sci.*, 89, 157–166
- Cheshire MV and Anderson G (1975) Soil polysaccharides and carbohydrate phosphates. *Soil Sci.*, 119, 356–362

- Cheshire MV and Griffiths BS (1989) The influence of earthworms and crane fly larvae on the decomposition of uniformly  $^{14}\text{C}$  labelled plant material in soil. *J. Soil Sci.*, 40, 117–124
- Cheshire, M.V., C.M. Mundie, and H. Shepherd. 1969. Transformation of  $^{14}\text{C}$  glucose and starch in soil. *Soil Biol. Biochem.* 1:117–130.
- Cheshire MV and Mundie CM (1966) The hydrolytic extraction of carbohydrates from soil by sulfuric acid. *J. Soil Sci.*, 17, 372–381
- Cheshire, M.V., C.M. Mundie, J.M. Bracewell, G.W. Robertson, J.D. Russell, and A.R. Fraser. 1983. The extraction and characterization of soil polysaccharide by whole soil methylation. *J. Soil Sci.*, 34:539–554.
- Cheshire MV (1979) *Nature and origin of carbohydrates in soils.*, Academic London, 216 p
- Coelho RRR, Linhares LF and Martin JP (1988) Sugars in hydrolysates of fungal melanins and soil humic acids. *Plant Soils*, 106, 127–133
- Cowie GL and Hedges JI (1984) Determination of neutral sugars in plankton, sediments and wood by capillary gas chromatography of equilibrated isomeric mixtures. *Anal. Chem.*, 56, 497–504
- Dormaer JF (1984) Monosaccharides in hydrolysates of water-stable aggregates after 67 years of cropping to spring wheat as determined by capillary gas chromatography. *Can. J. Soil Sci.*, 64, 647–656
- Doutre DA, Hay GW, Hood A and van Loon GW (1978) Spectrophotometric methods to determine carbohydrates in soil. *Soil Biol. Biochem.*, 10, 457–462
- Dubois, M., K.A. Gilles, J.K. Hamilton, P.A. Rebers, and F. Smith. 1956. Colorimetric Method for Determination of Sugars and Related Substances. *Analytical Chemistry* 28:350–356.
- Folsom BL, Wagner GH and Scrivner CL (1974) Comparison of soil carbohydrate in several prairie and forest soils by gas-liquid chromatography. *Soil Sci. Soc. Amer. Proc.*, 38, 305–309
- Feller, C., C. François, G. Villemin, J.M. Portal, F. Toutain, and J.L. Morel. 1991. Nature des matières organiques associées aux fractions argileuses d'un sol ferrallitique. *C.R. Acad. Sci. Paris* 312:1491–1497.
- François C (1988) Les sucres neutres in “*Devenir à court terme de différentes formes de l'azote dans un ferrisol*”, Doctorat de l'université de Nancy I, 67–75
- Guckert A, Cure B and Jacquin F (1971) Comparative evolution of the polysaccharides of the humin after incubation of glucose  $^{14}\text{C}$  and straw  $^{14}\text{C}$ . *Trans. Intern. Symposium “humus et plante V”*-Prague, 155–160
- Guckert (1973) *Contribution à l'étude des polysaccharides dans les sols et de leur rôle dans les mécanismes d'agrégation.*, Thèse doct. d'état, Univ. Nancy I, 124 p.
- Gupta UC and Sowden FJ (1965) Studies on methods for the determination of sugars and uronic acids in soils. *Can. J. Soil Sci.*, 45, 237–240
- Gupta UC (1967) Carbohydrates. In *Soil Biochemistry* McLaren et Peterson ed., Marcel Dekker, New York, 91–118
- Hamada R and Ono A (1984) Determination of carbohydrates in hydrolysates of volcanic ash soil by liquid chromatography with fluorescence spectroscopy, *Soil Sci. Plant Nutr.*, 30, 145–150

- Ivarson KC and Sowden FJ (1962) Methods for the analysis of carbohydrate material in soil, *Soil Sci.*, 94, 245–250
- Larre-Larrouy MC and Feller C (1997) Determination of carbohydrates in two ferrallitic soils: analysis by capillary gas chromatography after derivatization by silylation. *Soil Biol. Biochem.*, 29, 1585–1589
- Larré-Larrouy, M.C., A. Albrecht, E. Blanchart, T. Chevallier, and C. Feller. 2003. Carbon and monosaccharides of a tropical Vertisol under pasture and market-gardening: distribution in primary organomineral separates. *Geoderma* 117, 63–79.
- Martens DA and Frankenberger WT (1990) Determination of saccharides by high performance anion exchange chromatography with pulsed amperometric detection. *Chromatographia*, 29, 7–12
- McGrath D (1973) Sugars and uronic acids in Irish soils. *Geoderma*, 10, 227–235
- Morgenlie S (1975) Analysis of mixtures of the common aldoses by gas chromatography-mass spectrometry of their O-isopropylidene derivatives. *Carbohydrate Research*, 41, 285–289
- Murayama S (1983) Changes in the monosaccharide composition during the decomposition of straws under field conditions. *Soil Sci. Plant Nutr.*, 30, 367–381
- Murayama S (1984) Decomposition kinetics of straw saccharides and synthesis of microbial saccharides under field conditions. *J. Soil Sci.*, 35, 231–242
- Murayama S (1988) Microbial synthesis of saccharides in soils incubated with <sup>13</sup>C labelled glucose. *Soil Biol. Biochem.*, 20, 193–199
- Oades JM (1967) Gas-liquid chromatography of alditol acetates and its application to the analysis of sugars in complex hydrolysates. *J. Chromatogr.*, 28, 246–252
- Oades JM (1974) Synthesis of polysaccharides in soil by microorganisms. *Trans. Intern. Congr. Soil Sci. 10th- Moscow*, 93–100
- Oades JM, Kirkman MA and Wagner GH (1970) The use of gas-liquid chromatography for the determination of sugars extracted from soils by sulfuric acid. *Soil Sci. Soc. Am. Proc.*, 34, 230–235
- Pansu, M (1992) Les sucres neutres dans les sols : opportunité et tentatives d'amélioration. de leur détermination. Document IRD (ex-Orstom) Montpellier, 24 p.
- Pluijmen MHM (1987) Sugar analysis with the Shaffer-Somogyi micro-analysis, High Performance Liquid Chromatography and enzymatic analysis in crop samples. *Commun. Soil Sci. Plant Anal.*, 18, 1049–1059
- Reim RE and van Effen RM (1986) Determination of carbohydrates by liquid chromatography with oxidation at a nickel(III) oxide electrode. *Anal. Chem.*, 58, 3203–3207
- Singhal and Sharma (1985) Status of carbohydrates in the acid hydrolysates of soils and humic acids of Dehra dun forests (Uttar Pradesh). *Proc. Indian ntn. Sci. Acad.*, B51, 3, 348–352
- Spiteller M (1980) Kapillargaschromatographische bestimmung von zuckern unterschiedlicher boden. *Z. Pflanzenernaehr. Bodenkd.*, 143, 720–729
- Stevenson FJ (1982) Soil carbohydrates. In *Humus chemistry*, Wiley New York, 147–171



- Thomas and Lynch, (1961) A method for the quantitative estimation of pentoses in soil. *Soil Sci.*, (1961), 91, 312–316
- Tracey MV (1950) A colorimetric method for the determination of pentoses in the presence of hexoses and uronic acids. *Biochem. J.*, 47, 433–436
- Traitler H, Del Vedovo S and Schweizer TF (1984) Gas chromatographic separation of sugars by on-column injection on glass capillary columns. *J. High Resol. Chromatog. Chromatogr. Commun.*, 7, 558–562

### Soil lipids

- Wang TSC, Yu-Cheng Liang and Wey-Chiang Shen (1969) Method of extraction and analysis of higher fatty acids and triglycerides in soils. *Soil Sci.*, 107, 181–187
- Fahd-Rachid A (1993) *Effet à long terme d'apports continus de déchets urbains sur les caractéristiques du sol. Conséquences sur les propriétés de la matière organique en relation avec sa teneur en lipides.*, Thèse Doctorat Sciences agronomiques, INRA-Bordeaux, 151 p
- Ambles A, Jambu P and Ntsikoussalabongui B (1989) Evolution des lipides naturels d'un podzol forestier induite par l'apport d'engrais minéraux : hydrocarbures, cétones, alcools. *Science du Sol.*, 27, 201–214
- Ambles A, Jambu P and Ntsikoussalabongui B (1990) Evolution des acides gras d'un podzol forestier induite par l'apport d'engrais minéraux. *Science du Sol.*, 28, 27–42
- Jambu P, Fustec E and Jacquesy R (1978) Les lipides des sols : nature, origine, évolution, propriétés. *Science du Sol.*, 4, 229–240
- Jambu P, Bilong P, Ambles A, Ntsikoussalabongui B and Fustec E (1987) Influence d'apports minéraux sur l'évolution des lipides naturels des sols acides. *Science du sol.*, 25, 161–172
- Jambu, P., A. Amblés, H. Dinél, and B. Secouet. 1991. Incorporation of natural hydrocarbons from plant residues into an hydromorphic humic podzol following afforestation and fertilization. *Journal of Soil Science* 42:629–636
- Jambu, P., A. Amblés, J.C. Jacquesy, B. Secouet, and E. Parlanti. 1993. Incorporation of natural alcohols from plant residues into a hydromorphic forest-podzol. *Journal of Soil Science* 44:135–146
- McCarthy RD and Duthie AH (1962) A rapid quantitative method for the separation of free fatty acids from other lipids. *J. Lipid Res.*, 3, 117–119
- Stevenson FJ (1966) Lipids in soils. *J. Am. Oil Chemists Soc.*, 43, 203–210
- Stevenson FJ (1982) Soil lipids. In *Humus Chemistry.*, Wiley, 172–194
- Kates M (1975) Techniques of lipidology. In *Laboratory Techniques in Biochemistry and Molecular Biology*, Work TS and Work E ed. Elsevier Amsterdam, 269–610
- Zelles, L., and Q.Y. Bai. 1993. Fractionation of fatty acids derived from soil lipids by solid phase extraction and their quantitative analysis by GC-MS. *Soil Biology Biochemistry* 25:495–507

### Aqueous extract

- Leinweber P, Schulten HR and Körschens M (1995) Hot water extracted organic matter : chemical composition and temporal variations in a long-term field experiment. *Biol. Fertil. Soils*, 20, 17–23

Kouakoua E, Sala GH, Barthès B, Larre-Larrouy MC, Albrecht A and Feller C (1997) La matière organique soluble à l'eau chaude et la stabilité de l'agrégation. Aspects méthodologiques et application à des sols ferrallitiques du Congo. *Eur. J. Soil Sci.*, 48, 239–247

Küsel K and Drake HL (1999) Microbial turnover of low molecular weight organic acids during leaf litter decomposition. *Soil Biol. Biochem.*, 31, 107–118

### **Pesticides and pollutants**

Anon (1993) Determination of herbicides in soils by HPLC with UV-Detection. *Agrobiological Res.*, 46, 155–174

Barcelo D and Lawrence JF (1992) Residue analysis of organophosphorus pesticides. In *Emerging strategies for pesticide analysis*, Cairns T and Sherma J ed. CRC, 127–149

Calvet R, Barriuso E, Bedos C, Benoit P, Charnay MP and Coquet Y (2005) Les pesticides dans le sol – Conséquences agronomiques et environnementales. Edition France Agricole, Paris, 637 p

Celi L, Nègre M and Gennari M (1993) HPLC determination of fenoxatrop and fenoxatrop-ethy in different soils. *Pestic. Sci.*, 38, 43–47

Gennaro MC, Giacosa D, Baglietto C, Gennari M and Negre M (1996) Simultaneous separation of phenylurea-, triazine-, and phenoxyacid herbicides by reverse phase ion-interaction HPLC. Application to soil analysis. *J. Liq. Chrom. Rel. Technol.*, 196, 911–924

Jensen DJ and Glass RD (1990) Analysis for residues of acidic herbicides. In *Analysis of Pesticide Residues*, Moye HA ed. Krieger, 223–261

Kiang PH and Grob RL (1986) Développement of a screening method for the determination of 49 priority pollutants in soil. *J. Environ. Sci. Health*, A21, 15–53

Pansu M, Gautheyrou J and Loyer JY (2001) *Soil Analysis – Sampling, Instrumentation and Quality Control.*, Balkema, Lisse, Abington, Exton, Tokyo, 489 pp

Pansu M, Al Salti MN, Aubert H and Gry J (1981a) Contribution à l'étude de l'activité systémique du carbofuran au moyen de la chromatographie en phase gazeuse. *Phytiatrie-Phytopharmacie*, 30, 203–214

Pansu M, Dhouibi MH and Pinta M (1981b) Détermination des traces de pyrèthrinoïdes (bioperméthrine et décaméthrine) dans les substrats biologiques par chromatographie en phase gazeuse. *Analisis*, 9, 55–59

Richter BE (1992) Supercritical fluid extraction methods. In *Emerging Strategies for Pesticide Analysis*, Cairns T and Sherma J ed. CRC, 51–68

Seiber JN (1990) Carbamate insecticide residue analysis by gas-liquid chromatography. In *Analysis of Pesticide Residues*, Moye HA ed. Krieger, 333–378

Steinwandter H (1992) Development of microextraction methods in residue analysis. In *Emerging Strategies for Pesticide Analysis*, Cairns T and Sherma J ed. CRC, 3–38

Wheeler WB and Thompson NP (1990) Analysis of chlorinated hydrocarbons. In *Analysis of Pesticide Residues*, Moye HA ed. Krieger, 199–222

---

## Organic Forms of Nitrogen, Mineralizable Nitrogen (and Carbon)

### 14.1 Introduction

#### 14.1.1 The Nitrogen Cycle

Following his own studies and those of Cavendish on “mephitic air” or atmospheric “mofette”, Lavoisier (1789) discovered gaseous nitrogen and gave it the French name “azote”, meaning lifeless. Based on the relative chemical stability of the  $N_2$  molecule, this name is still plausible from a geochemical point of view (Table 14.1), as the nitrogen of the biosphere represents a very small quantity compared to atmospheric nitrogen and a negligible quantity compared to the total nitrogen of the planet.

**Table 14.1.** Geochemical distribution of nitrogen according to Stevenson (1982c)

Localization	weight N (tons)
Lithosphere	$1,636 \times 10^{14}$
Atmosphere	$38.6 \times 10^{14}$
Biosphere	$0.0028 \times 10^{14}$
soil organic matter	$0.0022 \times 10^{14}$
$NH_4^+$ -N of clays	$0.0002 \times 10^{14}$

However, for the physiologist or the agronomist, nitrogen is one of the main sources of life along with carbon, hydrogen and oxygen; life appeared on earth with the synthesis of the first amino acids.

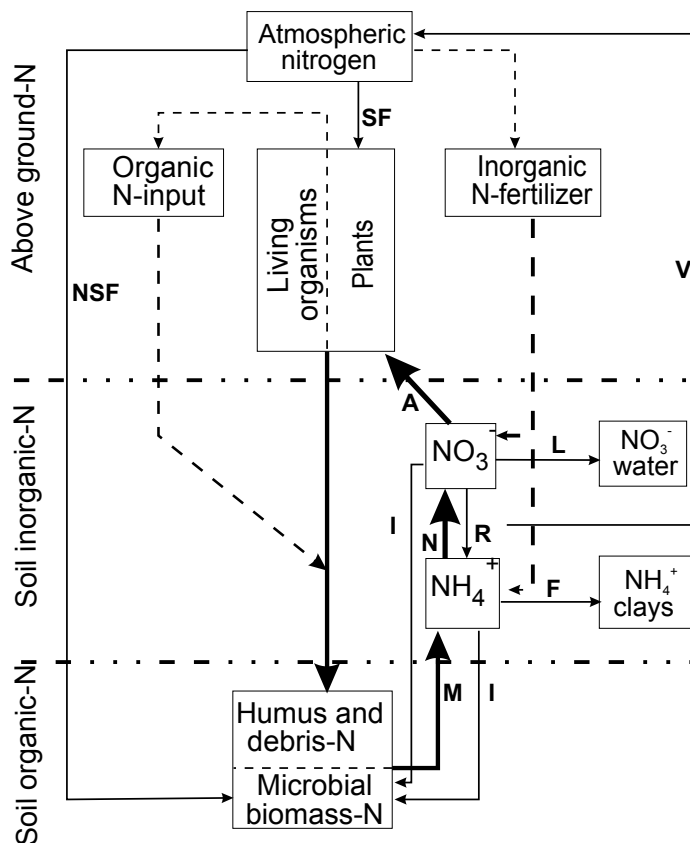

**Fig. 14.1.** Scheme of the nitrogen cycle: - - dotted lines anthropogenic incidence; solid lines = natural cycle; — bold lines main natural cycle in well-aerated media. A, assimilation by plants; M, mineralization of soil organic matter in ammonium; N, nitrification of ammonium; R, reduction of nitrates; I, microbial immobilization of inorganic nitrogen; V, volatilization during nitrification and denitrification processes; F, ammonium fixation in the clay layers; L, leaching of nitrates; SF, symbiotic plant fixation of atmospheric nitrogen; NSF, nonsymbiotic fixation by soil microbial biomass

At the beginning of the cycle, nitrogen in living organisms originates mainly from the assimilation of N-inorganic forms by plant roots (cf. Chap. 28), primarily N-NO<sub>3</sub>, in well-aerated soil. Given that nitrates represent only a very small nitrogen fraction, and that more than 90% of soil nitrogen is in organic forms (Stevenson 1982b), the interest of

studying the nitrogen cycle is obvious. Figure 14.1 shows the origin of nitrates: some contributions come from outside sources, but most is soil organic N. Irrespective of whether it is made up of (1) unbroken organic fragments (cf. Chap. 9), (2) humified molecules (cf. Chaps. 11 and 12) or (3) living soil organisms, part of this nitrogen is mineralized into ammonium. Ammonium is then immobilized by micro-organisms or transformed into nitrites under the action of other micro-organisms, oxidized to nitrates, or lost as  $N_2O$  or other gaseous forms.

A precise knowledge of the soil organic nitrogen reserves is thus very useful to study ammonium and nitrate availability and plant growth. Measurements of total organic nitrogen (cf. Chap. 10) or of the supply of inorganic nitrogen during cultivation (cf. Chap. 28) are used by agronomists to estimate the quantity of fertilizer required (Dahnke and Johnson 1990). However, these two indices are not really representative of the real nitrogen cycle but are only rough approximations:

- At a given time, the quantity of nitrate or ammonium present in a soil does not include inorganic N forms, which can be produced by mineralization or be consumed by reorganization, reduction, denitrification.
- There are very great differences in stability between the substances that comprise available organic nitrogen (Schulten and Schnitzer 1998; Schipper et al., 2004); the processes of mineralization effects only a small fraction of this supply which thus has to be determined.
- Most humification processes require the consumption of inorganic nitrogen, which thus becomes temporarily unavailable for plants.
- The economic and ecological risks resulting from unreasonable use of nitrogen amendments (and resulting in leaching of nitrates and water pollution, N volatilization and possible in an increase in greenhouse gases, and in the fixation of ammonium in clays) are convincing arguments in favour of analyses that enable a better knowledge of the nitrogen cycle and particularly of the forms of organic nitrogen that represent the biggest potential reserve in the soils for plant uptake (Matsumoto et al. 2002).

### 14.1.2 Types of Methods

The problems listed above have generated many studies on soil organic nitrogen and these can be classified in two main groups:

- Studies of the forms of organic nitrogen: e.g. Bremner (1965), Jocteur Monrozier and Andreux (1981), Jocteur Monrozier (1984), Kelley and Stevenson (1995), Stevenson (1982a, b, c, 1996).

– Studies with the more immediate agronomic objective of understanding nitrogen supplied by the soil i.e. potentially available nitrogen (e.g. Keeney and Bremner 1966; Cornforth and Walmsley 1971; Juma and Paul 1984; Gianello and Bremner 1986, Catroux et al. 1987, Giroux and Sen Tran 1987; Cabrera and Kissel 1988) and the kinetics of C and N mineralization.

The first group of studies usually analyses the forms of nitrogen in solution after hydrolysis has broken down the large organic molecules. The most recent analyses of these forms of nitrogen are presented in this chapter along with analysis of urea, a specific form of nitrogen.

The second group of studies uses two types of approach to determine soil nitrogen availability indices:

- A biological approach to estimate inorganic nitrogen produced by incubation in controlled conditions.
- Techniques for chemical extraction.

The techniques described in this chapter include extraction by electro-ultrafiltration (EUF) and techniques for the characterization of the forms of nitrogen in acid hydrolysates. Isotopic techniques using  $^{15}\text{N}$  tracer are also powerful tools for the study of nitrogen transfer between organic and inorganic compartments (Guiraud 1984; Chotte 1986; Pansu et al., 1998). The methods described later can be combined with measurement of  $^{15}\text{N}$  nitrogen.

## 14.2. Classical Methods

### 14.2.1 Forms of Organic Nitrogen Released by Acid Hydrolysis

#### *Principle*

The method of reference comes from Bremner (1965) and was further recommended by Stevenson (1982a, 1996). It results from adaptations of much older techniques for the characterization of protein by hydrolysis (Van Slyke, 1911–1912).

According to Bremner, 60–80% of total nitrogen from the soil surface is solubilized by the treatment used for acid hydrolysis of proteins. Stevenson (1982b) stated that between 25 and 35% of nitrogen is not solubilized by acid attack. According to Stevenson, this nitrogen does not result from the known artefact of condensation between amino acids and reducing sugars, but is a structural component of humic substances. An additional fraction can be extracted by diluted bases then solubilized by acid hydrolysis (Griffith et al. 1976). Pretreatments with hydrofluoric acid (cf. Sect. 14.3.1) also improve solubilization of nitrogen.

The proteinic character of soil organic nitrogen is in agreement with the fact that most hydrolyzed nitrogen is found in the form of amino acids: 20–40% according to Bremner (1965), 30–45% according to Stevenson (1982b).

This method of attack also provides 20–35% of total soil nitrogen (Stevenson, 1982b) in ammoniacal form (in a quantity similar to amino acids). This ammonia comes from different sources: degradation of amid forms of proteins, total or partial destruction of certain amino acids (such as tryptophan, serine, threonine), partial destruction of hexosamines, and release of ammonium fixed by clays.

The nitrogen in amino sugars represents between 5 and 10% of soil nitrogen. Lastly, 10–20% of soil nitrogen is in unknown form, i.e. is not included in the forms quoted above (Stevenson 1982b).

The hydrolysis conditions recommended below are those adopted by Bremner (1965) and subsequently by Stevenson (1982a). Other possible alternatives are discussed in Sect. 14.3.1.

The method developed by Bremner to estimate the different forms of nitrogen in hydrolysates includes fractionation by steam distillation of the free ammonium, hexosamines, and amino acids (Table 14.2). Although perhaps less precise and less selective than spectrometric and chromatographic methods (cf. Sect. 14.3.2), the steam distillation technique has the advantage of simplicity. The same distillation equipment (Fig. 14.3) can be used to measure all the fractions. The same equipment can also be used for the analysis of total nitrogen (cf. Chap. 10) and of the inorganic forms of nitrogen in the case of sufficiently nitrogen-rich soils (cf. Chap. 28). In addition, this technique has the advantage of providing each fraction in the form of an ammoniacal distillate, which is ideal for all studies using  $^{15}\text{N}$  labelled nitrogen since the measurement of this isotope can be performed on molecular gas nitrogen obtained by oxidation of an ammoniacal form of nitrogen.

The determination of the  $(\text{NH}_3 + \text{amino sugars})\text{-N}$  fraction in hydrolysates is based on the fact that (1) glucosamine and galactosamine are quickly broken down in alkaline medium giving ammonium and (2) hexosamines can be estimated from the ammonium released when hexosamines are steam distilled with a phosphate–borate buffer at pH 11.2 (Tracey, 1952).

**Table 14.2.** Methods of steam distillation to measure the different forms of nitrogen in soil hydrolysates and the percentage of each form as a function of total soil nitrogen (after Bremner 1965, Keeney and Bremner 1967 and Stevenson 1982a,b)

N form	Method	% soil-N
ammonia-N	steam distillation with MgO	20–35
Amino sugar-N	steam distillation with phosphate–borate buffer at pH 11.2 and deduction of ammonia-N	5–10
Amino acid-N	steam distillation with phosphate–borate buffer after treatment with NaOH at 100°C to decompose hexosamines and eliminate ammonium then with ninhydrin (pH 2.5; 100°C) to convert $\alpha$ -amino-N to NH <sub>3</sub> -N	30–45
(serine+threonine)-N	steam distillation with phosphate–borate buffer after removal of (ammonium+hexosamine)-N forms by steam distillation with the same buffer and treatments with periodate to convert (serine+threonine)-N to NH <sub>3</sub> -N and with <i>meta</i> -arsenite to Reduce the excess of periodate	
(ammonia+amino sugar+amino acid)-N	steam distillation with buffer phosphate–borate after treatment with ninhydrin (pH 2.5 ; 100°C) to convert $\alpha$ -amino-N to NH <sub>3</sub> -N	
(total hydrolyzable)-N	steam distillation with NaOH after Kjeldahl digestion with the mixture H <sub>2</sub> SO <sub>4</sub> –K <sub>2</sub> SO <sub>4</sub> -catalyst	65–80
unknown hydrolysable-N	total hydrolysable-N (NH <sub>3</sub> -N + amino-N) Sugars+ $\alpha$ amino acids-N+(serine+threonine)-N	10–20



The measurement of ammoniacal  $\text{NH}_3\text{-N}$  forms is based on the observation of Bremner (1960): the interference of hexosamines and other not very stable forms in the measurement of ammonium by distillation in alkaline medium can be eliminated if steam distillation is performed with a small quantity of  $\text{MgO}$  and a very short distillation time.

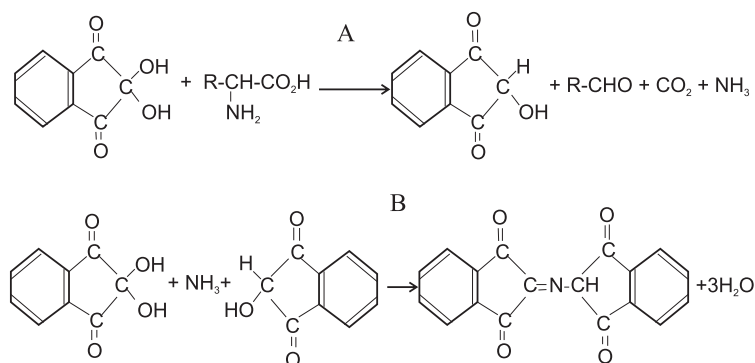

**Fig. 14.2.** Reaction of  $\alpha$ -amino acids with ninhydrin. At pH 2.5,  $\text{NH}_3$  is a stable reaction product (reaction A); when the reaction is brought to pH 5, the ammonium released by reaction A combines with the reduced and oxidized forms of ninhydrin (reaction B) to give a blue coloured compound (Bremner 1965; Stevenson 1982a)

The method for the measurement of  $\alpha$ -amino acid forms is based on that of ammonia released by oxidation with ninhydrin (Fig. 14.2). It was developed after the discovery (Bremner 1960) that the reaction of condensation B (Fig. 14.2) leading to the trapping of released ammonia (reaction A) in a coloured compound does not occur at pH 2.5. Titration of  $\alpha$ -amino acids can thus be carried out by a ninhydrin treatment at pH 2.5 followed by steam distillation of the reaction products in the presence of the phosphate–borate buffer at pH 11.2.

The specific method for nitrogen of serine and threonine is based on the property of compounds containing amino and hydroxyl groups on adjacent atoms to be oxidized by the periodate, resulting in ammonia:

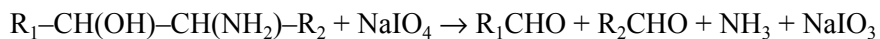

Interference with the (ammonium+hexosamine)-N forms can be eliminated by preliminary distillation with phosphate–borate buffer at pH 11.2. The ammonium released by oxidation with periodate is then

determined by steam distillation after addition of *meta*-arsenite to eliminate excess periodate (Keeney and Bremner 1967):

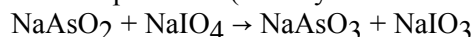

### Equipment

- Micro-Kjeldahl digestion unit.
- Steam distillation apparatus (Fig. 14.3) which can be also used for the titration of inorganic nitrogen in the case of N-rich soils (cf. Chap. 28) and for the titration of total nitrogen (cf. Chap. 10) instead of an automated distiller.
- 50 and 100 mL Pyrex Kjeldahl distillation flasks, with standard 29/32 ground glass joints and hooks to attach springs.
- 5 mL graduated microburette with 0.01 mL intervals or automated titrimeter with double electrode for pH measurement and an automated 5 mL burette.

### Reagents

1.  $6 \text{ mol L}^{-1}$  hydrochloric acid. Add 513 mL of concentrated HCl ( $d = 1.19$ ) to approximately 500 mL water, cool and complete to 1 L in a volumetric flask.
2. *n*-octylic alcohol.
3. Potassium sulphate-catalyst mixture for Kjeldahl digestion: see preparation in “Reagents” under Sect. 10.2.6 of Chap. 10.
4.  $10 \text{ mol (NaOH) L}^{-1}$  soda solution. See preparation in “Reagents” under Sect. 10.2.6 of Chap. 10.
5.  $5 \text{ mol (NaOH) L}^{-1}$  soda solution. Dilute 500 mL of  $10 \text{ mol L}^{-1}$  soda to 1 L and store in a well-stopped bottle.
6.  $0.5 \text{ mol (NaOH) L}^{-1}$  soda solution. Dilute 50 mL of  $10 \text{ mol L}^{-1}$  soda to 1 L and store in a stopped bottle.
7. *Boric acid-indicator solution*. Dissolve 100 g of boric acid in 4 L of deionized water, add 100 mL of mixed indicator (0.495 g of bromocresol green and 0.33 g of methyl red in 500 mL ethanol), adjust the pH to 4.8–5.0 (reddish purple colour) by the addition of a little diluted soda or hydrochloric acid and bring the volume to 5 L.
8.  $0.005 \text{ mol (}\frac{1}{2}\text{H}_2\text{SO}_4\text{) L}^{-1}$  sulphuric acid solution: use standard commercial solution.
9. *Anhydrous magnesium oxide*. If necessary, calcinate in the muffle furnace at 600–700°C for 2 h.
10. *Ninhydrin*.  $\text{C}_9\text{H}_4\text{O}_3\cdot\text{H}_2\text{O}$ , tested as amino-acid reagents.

11. *phosphate–borate buffer at pH 11.2*. Put 100 g of sodium phosphate ( $\text{Na}_3\text{PO}_4 \cdot 12\text{H}_2\text{O}$ ), 25 g of borax ( $\text{Na}_2\text{B}_4\text{O}_7 \cdot 10\text{H}_2\text{O}$ ) and approximately 900 mL water into a 1 L volumetric flask; agitate until dissolution, complete to 1 L and store in a well-stopped flask.
12. citric acid ( $\text{C}_6\text{H}_8\text{O}_7 \cdot \text{H}_2\text{O}$ );
13. *citrate buffer pH 2.6*. Mix 2.06 g of dihydrate sodium citrate ( $\text{Na}_3\text{C}_6\text{H}_5\text{O}_7 \cdot 2\text{H}_2\text{O}$ ) and 19.15 g of citric acid ( $\text{C}_6\text{H}_8\text{O}_7 \cdot \text{H}_2\text{O}$ ), crush well in a mortar and store in a small stopped bottle.

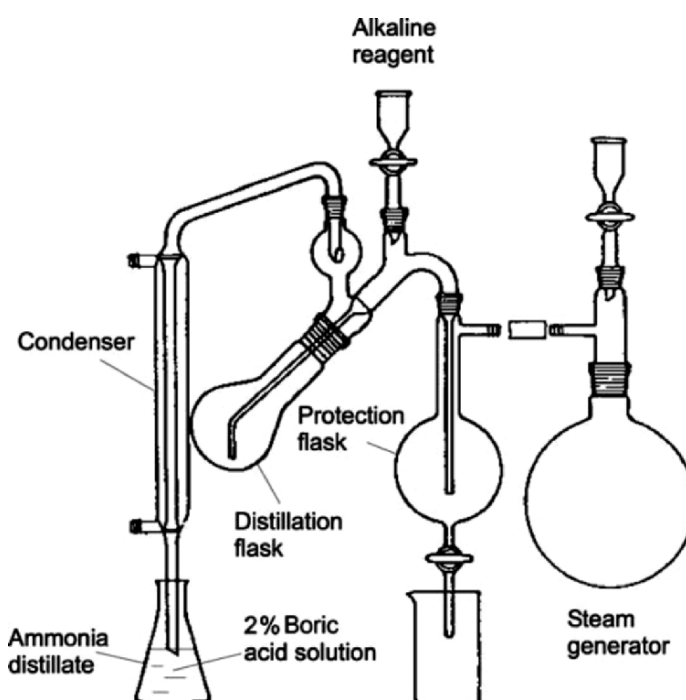

Fig. 14.3. Steam distillation apparatus

14.  $0.2 \text{ mol L}^{-1}$  *periodic acid solution*. Dissolve 4.6 g of  $\text{HIO}_4 \cdot 2\text{H}_2\text{O}$  in 100 mL water and store in a glass bottle with ground stopper.
15.  $1 \text{ mol L}^{-1}$  *sodium metaarsenite solution*. Dissolve 13 g of  $\text{NaAsO}_2$  in 100 mL water and store in well-stopped flask.
16. *Standard solution A* ( $\text{NH}_4^+$  + amino sugar + amino acid). Dissolve 0.189 g of  $(\text{NH}_4)_2\text{SO}_4$ , 0.308 g of glucosamine HCl and 0.254 g of alanine in water; dilute to 2 L in a volumetric flask while agitating vigorously; this solution contains  $20 \mu\text{g}$  of  $\text{NH}_4\text{-N}$  +  $10 \mu\text{g}$  of amino sugar-N and  $20 \mu\text{g}$  of  $\alpha$ -amino acid-N by mL; store in the refrigerator at  $4^\circ\text{C}$ ;

17. *Standard solution B (serine + threonine)-N*. Dissolve 150 mg of serine and 170 mg of threonine in water, dilute the solution to a volume of 2 L in a volumetric flask and agitate vigorously; prepared with pure dry products this solution contains 10  $\mu\text{g}$  of serine-N and 10  $\mu\text{g}$  of threonine-N by mL; store in the refrigerator at 4°C.

### **Procedure**

#### **Acid Hydrolysis**

Weigh an air-dried and finely crushed (<100 mesh) soil sample containing approximately 10 mg of total nitrogen (cf. Chap. 10) and place it in a 125 mL Pyrex round bottom boiling flask with a standard ground stopper.

Add two drops of octylic alcohol and 20 mL of 6 mol (HCl) L<sup>-1</sup> solution. Agitate well then connect the boiling flask to a Liebig condenser and boil at reflux for 12 h.

Cool and filter under vacuum on a Büchner funnel with a standard Whatman N°50 type filter paper. Rinse the residue in small fractions until 50 mL total filtrate have been collected. Cool the filtrate in crushed ice and neutralize to pH  $6.5 \pm 0.1$  by adding soda while measuring the pH with a pH-meter. Gently add the soda under agitation (the solution must not become alkaline), first using the 5 mol L<sup>-1</sup> solution until approximately pH 5 then the 0.5 mol L<sup>-1</sup> solution until neutralization. Transfer in a volumetric flask, bring back to ambient temperature and complete to 100 mL by carefully rinsing the used glass flasks and the pH electrodes with distilled water; stop carefully and agitate well.

#### **Separations by Distillation – Precautions**

In each of the following techniques for the determination of nitrogen, put 5 or 10 mL of the hydrolysate (see “Acid Hydrolysis” under Sect. 14.2.1) into a 50 or 100 mL distillation flask. After suitable treatment, connect the flask to the steam distillation apparatus. The required form of nitrogen corresponds to the quantity of ammonia distilled in 2–4 min.

The apparatus should be run before each use to eliminate all traces of ammonia. The speed of distillation should be adjusted to collect 7–8 mL of distillate per minute. The flow of the condenser should be adjusted so that the temperature of the distillate at this distillation speed does not exceed 22°C.

To obtain a representative sub-sample of the hydrolysate, it is essential to agitate the contents of the volumetric flask well before each sub-sampling. The ends of the pipettes should not be too small to enable rapid transfer of the sample into the distillation flask. Pipettes with very small openings can cause sampling errors because some of materials in suspension in the sample can be retained and, in addition, the openings are easily blocked. If titration does not have to be performed rapidly by steam distillation, it is preferable to store the hydrolysate in an acid medium and to neutralize it immediately before titration.

#### *Determination of Total Nitrogen of the Hydrolysate*

Put 5 mL of neutralized hydrolysate into a 50 mL distillation flask; add 0.5 g of  $K_2SO_4$ -catalyst mixture and 2 mL of concentrated sulphuric acid. Carefully heat on a micro-Kjeldahl attack unit until the water has been eliminated and there is no more white smoke. Increase the heat until the mixture clarifies and then completes digestion by boiling gently for 1 h.

Let cool and carefully add 10 mL of distilled water while agitating. Cool under water and in crushed ice. Add 5 mL of boric acid-indicator solution in a 50 mL Erlenmeyer flask with a volume mark at 35 mL, and place the flask under the condenser of the distillation apparatus (Fig. 14.3). Connect the attack flask to the apparatus, place 10 mL of 10 mol  $(NaOH) L^{-1}$  solution in the funnel and add slowly to the flask. When the soda is almost completely added, rinse the funnel with approximately 5 mL water, and then add approximately 3 mL water before turning off the tap. Begin distillation by turning off the steam by-pass tap and stop distillation by opening the same tap when the distillate reaches the 35 mL mark (approximately 4 min of distillation). Rinse the end of the condenser and measure the  $NH_3$ -N corresponding to total-N of the hydrolysate by titration with the 5 mmol  $(\frac{1}{2}H_2SO_4 L^{-1})$  solution. At titration point, the colour will change from green to pink.

If  $V1$  is the volume of titrating solution in mL, the quantity of nitrogen in the sub-sample is  $70 V1 \mu g$ . If  $P$  is the weight of the soil sample (grams), the quantity of hydrolyzed nitrogen will be  $70 V1 100/(5P) \mu g g^{-1}$  soil, i.e.  $1.4 V1 P^{-1} mg g^{-1}$  soil.

#### *Determination of $(NH_3 + \text{Amino sugars})-N$*

Put exactly 10 mL of hydrolysate in a 100 mL distillation flask, add 10 mL of phosphate-borate buffer and continue as above until a volume of 35 mL distillate is reached (approximately 4 min). Titrate the released ammonium as above. If  $V2$  is the volume of the 5 mmol  $(\frac{1}{2}H_2SO_4) L^{-1}$  solution, the quantity of  $(NH_3 + \text{amino sugars})-N$  is  $0.7 V2 P^{-1} mg g^{-1}$  soil.

**Determination of  $\text{NH}_4^+$ -N**

Put 10 mL of hydrolysate into a 50 or 100 mL distillation flask, add  $0.07 \pm 0.01$  g MgO and continue as above until a volume of 20 mL distillate is reached (approximately 2 min of distillation). Titrate the distillate as above. If  $V_3$  is the volume of 5 mmol ( $\frac{1}{2}\text{H}_2\text{SO}_4$ )  $\text{L}^{-1}$  solution used, the quantity of  $\text{NH}_4^+$ -N resulting from the soil hydrolysis is  $0.7 V_3 P^{-1} \text{ mg g}^{-1}$  soil. The quantity of amino sugars-N is estimated residually:  $0.7 (V_2 - V_3) P^{-1} \text{ mg g}^{-1}$  soil.

**Determination of ( $\text{NH}_4^+$  + Amino sugars +  $\alpha$ -amino acid)-N**

Put 5 mL of hydrolysate into a 50 mL distillation flask, add 100 mg of citrate buffer and 100 mg of ninhydrin, place the flask in a boiling water bath for 10 min; after 1 min, agitate. Cool the flask, add 10 mL of phosphate-borate buffer, distil until a volume of 35 mL distillate has been obtained (approximately 4 min) and titrate the distillate as above. If  $V_4$  is the volume of the 5 mmol ( $\frac{1}{2}\text{H}_2\text{SO}_4$ )  $\text{L}^{-1}$  solution at the titration point, ( $\text{NH}_4^+$  + amino sugars +  $\alpha$ -amino acid)-N is  $1.4 V_4 P^{-1} \text{ mg g}^{-1}$  soil.  $\alpha$ -amino-N can be estimated residually:  $0.7(2V_4 - V_2) P^{-1} \text{ mg g}^{-1}$  soil. It is also possible to control the  $\alpha$ -amino acid-N content by first eliminating ( $\text{NH}_4^+$  + amino sugars)-N forms as described below.

**Determination of  $\alpha$ -amino acid-N**

Put 5 mL of hydrolysate in a 50 mL distillation flask, add 1 mL of the 0.5 mol  $\text{L}^{-1}$  NaOH solution and heat the flask in a boiling water bath until the volume is reduced to about 2–3 mL (approximately 20 min). Let cool, add 500 mg of citric acid and 100 mg of ninhydrin, place the flask in a boiling water bath for 10 min; after 1 min, agitate. Cool the flask; add 10 mL of phosphate-borate buffer and 1 mL of 5 mol  $\text{L}^{-1}$  NaOH solution. Distil until a volume of 35 mL of distillate is obtained (approximately 4 min) and titrate the distillate as above. If  $V_5$  is the volume of 5 mmol ( $\frac{1}{2}\text{H}_2\text{SO}_4$ )  $\text{L}^{-1}$  solution,  $\alpha$ -amino acid-N is  $1.4 V_5 P^{-1} \text{ mg g}^{-1}$  soil.

**Determination of (Serine + Threonine)-N**

Proceed up to the determination of ( $\text{NH}_4^+$  + amino sugars)-N as described in "Determination of ( $\text{NH}_4^+$  + amino sugars)-N. Then remove the distillation flask, rinse the input vapour tube and cool under the cold tap. Add 2 mL of the periodic acid solution. After agitating the flask for approximately 30 s add 2 mL of sodium arsenite solution. Connect to the distillation apparatus and run until approximately 35 mL of distillate is collected (4 min). Titrate the distillate as above. If  $V_6$  is the volume of 5 mmol ( $\frac{1}{2}\text{H}_2\text{SO}_4$ )  $\text{L}^{-1}$  solution, (serine+threonine)-N is  $0.7 V_6 P^{-1} \text{ mg g}^{-1}$  soil.

### *Calibration of the Method*

These distillation procedures can be tested using the standard solutions A and B, the recommended aliquot volumes being 5 mL of A solution for  $\text{NH}_4^+\text{-N}$ , amino acid-N or (ammonium + hexosamines + amino acids)-N, 10 mL of A solution for N-(amino sugars) and 10 mL of B solution for N-(threonine+serine). If they are stored in the refrigerator, the two standard solutions will remain stable for several months. For details of other precautions concerning this technique, please refer to the original publication (Bremner 1965).

## **14.2.2 Organic Forms of Nitrogen: Simplified Method**

### ***Principle***

With respect to the acid attack, the technique is similar to the one described in Sect. 14.1.1. The distillation procedure is simplified, only two fractions are determined on the hydrolysate.

– dhN: fraction distillable in alkaline medium which thus primarily includes the  $\text{NH}_4\text{-N}$  + and amino sugar-N forms, but also some amid and amino phenol forms (Egouminides et al. 1987).

– ndhN: non-distillable fraction which contains mainly amino acids and unidentified nitrogen. This fraction is obtained by the difference between hN, total hydrolysable nitrogen (obtained by Kjeldahl digestion) and dhN, distillable hydrolysable nitrogen.

Non-hydrolysable nhN can be obtained as previously either by the difference between the Kjeldahl total nitrogen and the total hydrolysable nitrogen, or by Kjeldahl mineralization of the residue of hydrolysis (cf. Sect. 14.2.1). This simplified method was developed and used by Egouminides et al. (1987) to measure the potential fertility of tropical soils, which are generally much poorer in nitrogen than soils in temperate climates.

### ***Equipment and Reagents***

- The same equipment as listed in “Equipment” under Sect. 14.2.1.
- reagents N° 1, 3, 4, 7 and standard solutions 16, 17 in “Reagents” under Sect. 14.2.1.
- 0.02 mol ( $\frac{1}{2}\text{H}_2\text{SO}_4 \text{ L}^{-1}$ ) sulphuric acid solution: prepare with a standard commercial dose.

## **Procedure**

### ***Acid Hydrolysis***

The test specimen should be adjusted as described in Sect. 14.2.1 with respect to the nitrogen content of the samples. In practice, possible weights of air dried soils are 5 g for an andosol, 10–20 g for a ferrallitic soil, 20–50 g for a tropical ferruginous soil.

Put the sample in a 250 mL round bottom boiling flask with a standard ground stopper and add 100 mL of 6 mol (HCl) L<sup>-1</sup> hydrochloric acid. Connect the boiling flask to a Liebig condenser and boil at reflux for 16 h (i.e. from 5 p.m. to 9 a.m. the following day).

Stop heating, let cool, and transfer in 250 mL centrifugation flasks, rinsing the condenser and boiling flask with distilled water. Centrifuge at 4,000g for 15 min and collect the supernatant in a 200, 250 or 500 mL volumetric flask, the size depending on the number of washings. Wash the centrifugation pellet two or three times with 20–40 mL distilled water centrifuging each time in the same conditions and adding the washing water to the volumetric flask. Complete to the exact volume required while shaking well. The hydrolysate in acid medium can be stored in the volumetric flask before analysis. Recover the centrifugation pellet, dry at 40°C and weigh with precision.

### ***Determination of Distillable Hydrolysable Nitrogen dhN***

Put an aliquot of the hydrolysate in a 100 mL distillation flask. Place a 100 mL Erlenmeyer flask containing 10 mL of boric acid-indicator solution under the condenser of the steam distillation apparatus (Fig. 14.3). Connect the distillation flask to the apparatus and add via the funnel (Fig. 14.3) a volume of 10 mol L<sup>-1</sup> soda corresponding to neutralization plus a slight excess (for a hydrolysate containing 3 mol L<sup>-1</sup>, add 1/3 of the volume of aliquot in the form of 10 mol (NaOH) L<sup>-1</sup> solution). Allow the vapour to distil until a volume of 50–80 mL of distillate has been obtained. Titrate the contents of the Erlenmeyer flask with the 0.02 mol L<sup>-1</sup> sulphuric acid solution. If  $P$ ,  $V_0$ ,  $V_{01}$  and  $V_1$  are the weight of the soil test specimen (g), the total hydrolyzed volume, the sub-sampling volume of hydrolysate, and the volume of titrating solution (mL), respectively:  $dhN = 0.28 V_0 V_1 (V_{01} P^{-1})$  mg of distillable hydrolysable nitrogen per gram of soil.



### *Determination of Total Hydrolysable Nitrogen hN*

Make Kjeldahl mineralization on an aliquot of hydrolysate (cf. Sect. 14.2.1): if  $V_{02}$  is the sub-sampling volume of hydrolysate (mL) and  $V_2$  the volume of titrating solution (mL),  $hN = 0.28 V_0 V_2 (V_{02} P)^{-1}$ . The non-distillable nitrogen hydrolyzable is estimated residually:  $ndhN = hN - dhN$ .

### *Determination of Not Hydrolysable Nitrogen nhN*

This value is determined by Kjeldahl mineralization on the hydrolysis residue dried at 40°C (cf. Sect. 11.2.1). If the weight of the residue is lower than 10 g, use the whole residue, if not, weigh a precise aliquot of the residue. If  $P_0$ ,  $P_{01}$ ,  $V_3$  are the weight of the residue, the weight of aliquot, and the volume of titrating solution, respectively,  $nhN = 0.28 P_0 V_3 (P_{01} P)^{-1}$ .

## 14.2.3 Urea titration

### *Principle*

Urea is used as nitrogenized fertilizer on cultivated soils all over the world (Beaton 1978). Consequently reliable methods are needed to determine the residue of urea in the soil. Two main types of titration techniques can be distinguished:

– Colorimetric methods based on the colour reaction of urea with diacetyl monoxime (DAM) (Fearon 1939) or with *p*-dimethyl-amino-benzaldehyde (Watt and Crisp 1954) in acid medium.

– Enzymatic methods which enable the ammonium produced during urease hydrolysis of urea to be measured; after incubation, this procedure uses steam distillation with the same equipment described above (Fig. 14.3 and Sects. 14.2.1 and 14.2.2).

The reaction of urea with DAM produces a yellow compound. In the presence of thiosemicarbazide (TSC), a red compound is formed. Douglas and Bremner (1970) developed a technique using the latter reaction which allows precise measurement for the analysis of soil solutions containing less than 20 mg (urea) L<sup>-1</sup>. The soil urea is extracted by a KCl solution in the presence of a urease inhibitor. The extracts are then titrated using the spectro-colorimetric technique. The initial method of Douglas and Bremner was slightly modified by Mulvaney and Bremner (1979). The latter technique is described below. The extraction solutions can also be titrated on an automatic colorimeter (Douglas et al. 1977). For more details on methods of measuring urea, see Bremner (1982).

### Reagents

- *Phenyl-mercury acetate (PMA) solution.* Dissolve 50 mg of PMA in 1 L of purified water.
- *Potassium chloride and PMA solution (2M KCl-PMA):* dissolve 1,500g of KCl in 9 L of water and add 1 L of PMA solution.
- *DAM solution.* Dissolve 2.5 g of DAM in 100 mL water.
- *TSC solution.* Dissolve 0.25 g of TSC in 100 mL water.
- *Acid reagent.* Add 40 mL of concentrated sulphuric acid to 1 L of phosphoric acid solution (85% in weight), dilute the mixture to 2 L with water (add the acid to the water) under agitation.
- *Colouring reagent.* Mix 50 mL of DAM solution with 30 mL of TSC solution and dilute the mixture to 1 L with the acid reagent; this reagent cannot be stored and should be prepared just before use.
- *Standard urea-N solution.* Dissolve 0.4288 g of pure dry urea in the KCl-PMA solution, complete to 2 L with the same solution and agitate well. This solution contains 100 µg of urea-N by mL. Store in the refrigerator.

### Procedure

Place 5 g of soil in a 100 mL bottle and add 50 mL of 2 M KCl-PMA solution. Stop the bottle, agitate for 1 h on a mechanical agitator and filter (Whatman n°42 filter paper).

Remove a precise aliquot of the extract (1–10 mL) containing between 10 and 100 µg of urea-N and place it in a 50 mL volumetric flask. Complete to 10 mL with the 2 M KCl-PMA solution and add 30 mL of colouring reagent. Agitate the flask quickly to mix and leave it in a thermostatic bath at  $85 \pm 0.5^\circ\text{C}$  for 30 min. Cool for 10 min with cold water ( $12\text{--}15^\circ\text{C}$ ), complete to 50 mL with water and agitate well. Measure the red colour absorption with the colorimeter at 527 nm. If the colorimeter is not equipped with a monochromator, a green filter can be used instead. Calculate the concentration using a calibration curve with 0, 10, 50, 100 µg of urea-N.

To prepare the calibration curve, dilute 20 mL of standard urea-N solution in a 200 mL volumetric flask with the 2 M KCl-PMA solution and agitate well. Pipette 0, 1, 5, 10 mL aliquots of the solution in 50 mL volumetric flasks. Complete to 10 mL with the 2 M KCl-PMA solution and continue in the same way as for the soil extracts. Make a calibration curve for each series of analyses.

#### 14.2.4 Potentially Available Nitrogen – Biological Methods

##### *Principle*

These methods analyse the capacity of a soil to provide inorganic nitrogen to plants. Different names are used for the methods such as nitrogen availability indices, potentially mineralizable nitrogen, net mineralization, mineralization potential.

The biological methods tend to simulate *in vitro* the evolution of the soil in natural conditions. They measure inorganic nitrogen produced in a soil sample after a given incubation time in controlled conditions.

The implementation of these methods thus appears to be simple, but in practice, it is very difficult to choose the appropriate procedure because so many alternatives are available. Keeney (1982) listed 29 incubation procedures that were tested with respect to measurements of nitrogen consumption by various types of plants. Fahd-Rachid (1990) listed 11 methods, three of which were not mentioned by Keeney.

The most frequently quoted of these methods was originally proposed by Stanford and Smith (1972). It is based on the concept of decomposition of a pool of available nitrogen according to first-order kinetics (Fig. 14.4). During a time interval  $dt$  the variation in the organic nitrogen content  $d[No]$  can be expressed according to the kinetic constant of mineralization  $k$  by the expression:

$$d[No]/dt = -k [No] \quad (14.1)$$

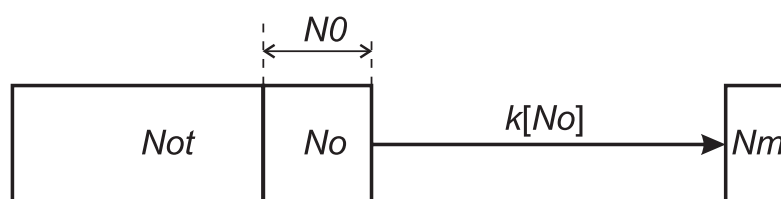

**Fig. 14.4.** Diagrammatic representation of nitrogen mineralization according to Stanford and Smith (1972): *Not*, total organic nitrogen of the soil; *No*, mineralizable soil organic nitrogen; *NO*, potentially mineralizable organic nitrogen; *Nm*, mineralized nitrogen ( $\text{NH}_4^+ + \text{NO}_3^- + \text{NO}_2^-$ );  $k$ , kinetic constant = fraction of organic nitrogen mineralized during the time interval  $dt$

By integration,  $N_0$  being the quantity of mineralizable organic nitrogen at time 0 (potentially mineralizable nitrogen), (14.1) gives

$$[No] = N_0 e^{-kt} \quad (14.2)$$

In addition, if pre-existing inorganic nitrogen in the soil is calculated, the balance of nitrogen is written

$$[No] + [Nm] = N_0 \quad (14.3)$$

According to the (14.2) and (14.3) the evolution  $Nm$  of inorganic nitrogen is thus written

$$[Nm] = N_0 (1 - e^{-kt}) \quad (14.4)$$

This technique consists in measuring inorganic nitrogen produced at a range of incubation times and plotting the cumulated values as a function of time. By adjusting the data in (14.4), an estimate of potentially mineralizable nitrogen  $N_0$  and the kinetic constant of mineralization  $k$  can be obtained simultaneously. A range of adjustments was proposed. Stanford and Smith (1972) initially observed linear adjustments of cumulated inorganic nitrogen according to the square root of the incubation time. For the calculation of potentially mineralizable nitrogen and speed of mineralization, they used a calculation of linear regression. After logarithmic transformation, (14.4) can be written:

$$\text{Log}(N_0 - Nm) = \text{Log } N_0 - kt \quad (14.5)$$

By fixing a value of  $N_0$  in the left part of the equation, a linear adjustment between the variables  $\log(N_0 - Nm)$  and  $t$ , makes it possible to estimate  $k$ . The curves obtained on semi-logarithmic paper for different values chosen for  $N_0$  are convex for estimated  $N_0$  value  $<$  true  $N_0$  value, concave for estimated  $N_0 >$  true  $N_0$  and linear for estimated  $N_0 =$  true  $N_0$ . An iterative procedure enabled estimation of the optimal  $N_0$  value. Using this technique, Stanford and Smith observed values for  $N_0$  ranging between 5 and 40% of total nitrogen on 39 very different soils. On the other hand, constant speed  $k$  did not differ significantly between the soils and the authors estimated it at  $0.054 \pm 0.009 \text{ week}^{-1}$ . This method of adjustment was then criticized, especially because the logarithmic

transformation of the data involves the concomitant transformation of the experimental error (Campbell 1978; Smith et al. 1980; Reynolds and Beauchamp 1984). The technique favoured the points far from the origin and this smoothing effect could explain the low variability observed for  $k$  by Stanford and Smith (Mary and Rémy 1979). Most authors now prefer nonlinear adjustment techniques. Benedetti and Sebastiani (1996) compared three estimation techniques: maximum likelihood, linear adjustment according to (14.5) and nonlinear adjustment. Based on their results, the last technique appears to be preferable to the two others. Figure 14.5 shows two examples of nonlinear fittings obtained by Fahd-Rachid (1990) according to the Marquardt (1963) algorithm.

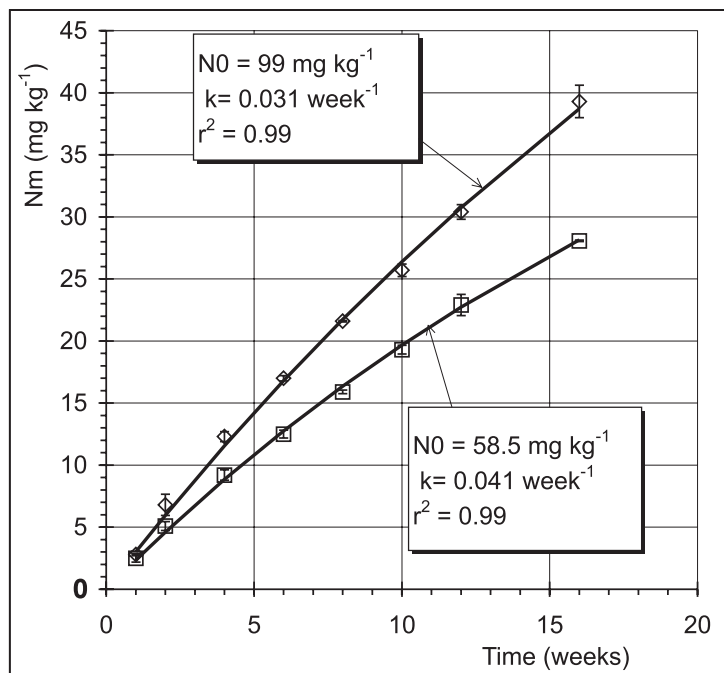

**Fig. 14.5.** Observed and adjusted values (Fahd-Rachid 1990) of accumulated inorganic nitrogen vs time of incubation, according to the technique of Stanford and Smith (1972) with nonlinear adjustment of (14.4). c, neutral colluvial soil; a, alluvial calcareous soil, cold preserved samples 50 days before incubation

### Alternatives

One disadvantage of this technique is the number of measurements it requires and the duration of the experiment, even if the authors proposed to reduce the 210 days variable (aerobic incubation of Stanford and Smith 1972) to 26 days (Stanford et al. 1974).

Although they are less precise, faster biological techniques have been proposed. Gianello and Bremner (1986) compared different biological and chemical alternatives by carrying out tests on 30 types of soils with a broad range of organic contents (0.3–9% of carbon).

The following biological procedures were compared:

- m13 method of Waring and Bremner (1964) modified by Keeney and Bremner (1966), used determination of ammonium produced by anaerobic incubation in water saturated medium of 5 g of soil at 40°C for 7 days.
- m14 method of Keeney and Bremner (1967) used determination of  $(\text{NH}_4^+ + \text{NO}_3^- + \text{NO}_2^-)\text{-N}$  produced by aerobic incubation of 10 g soil mixed with 30 g of quartz sand (30–60 mesh particle size) and 6 mL distilled water at 30°C for 14 days.
- m15 method of Stanford and Smith (cf. “Procedure” under Sect. 11.2.4) for incubation times of 2, 4, 6, 8 and 12 weeks, the result cumulated at 12 weeks.
- m16 result of m15 for 2 weeks.
- m17: calculation of  $N_0$  of Stanford and Smith (14.5) using all the m15 data.

Figure 14.6 shows the results published by these authors according to each soil number ranked in ascending order of carbon content (Fig. 14.6a, c), on one hand to compare the values of  $N_0$  with those of total nitrogen of the soil, on the other hand to compare methods m14, m15, m16 with the  $N_0$  (m17) method.

The comparison with total nitrogen shows similar variations illustrating the correlation observed by Gianello and Bremner ( $r = 0.86$ ,  $P < 0.1\%$ ). However, in some cases, the significant relation of proportionality calculated between  $N_0$  and N-total can lead to significant errors: Figure 14.6b shows differences between adjusted values and actual values which can reach  $100 \text{ mg kg}^{-1}$ ; this represents approximately  $300 \text{ kg of inorganic-N ha}^{-1}$  and is a big difference which prevents accurate estimation of N fertilization in the field. The calculated proportionality coefficient gives an average estimate of potentially mineralizable nitrogen at approximately 6.5% of total nitrogen of the soil.

The comparison of  $N_0$  and the other tests using biological techniques (Fig. 14.6c) illustrates the correlations (significant at  $P < 0.1\%$ ) between the data of Gianello and Bremner:  $r = 0.96$  between  $N_0$  and m13 or m15,  $r = 0.90$  between  $N_0$  and m16;  $r = 0.81$  between  $N_0$  and m14. The proportionality factors in Fig. 14.6d can be used to compare methods with less uncertainty than the previous comparison with total nitrogen (Fig. 14.6b). Thus, it is possible to estimate  $N_0$  with simpler experiments than those of Stanford and Smith (1972):

– anaerobic incubation of the M13 type allows estimation near

$$N0 = \text{NH}_4^+ \text{-N}/0.44.$$

– aerobic incubation of M14 and M16 types allows estimation near

$$N0 = (\text{NH}_4^+ + \text{NO}_3^- + \text{NO}_2^-)\text{-N}/0.27.$$

The two M14 and M16 techniques using 2-week aerobic incubation provide the same proportionality factor. However, the variations observed between adjusted and real values (Fig. 14.6d) are more significant than with the two other methods. The anaerobic M13 method of 1-week incubation appears to be the most reliable, at least in comparison with *N0*. The comparison with the M15 method is of little interest since *N0* is calculated from M15.

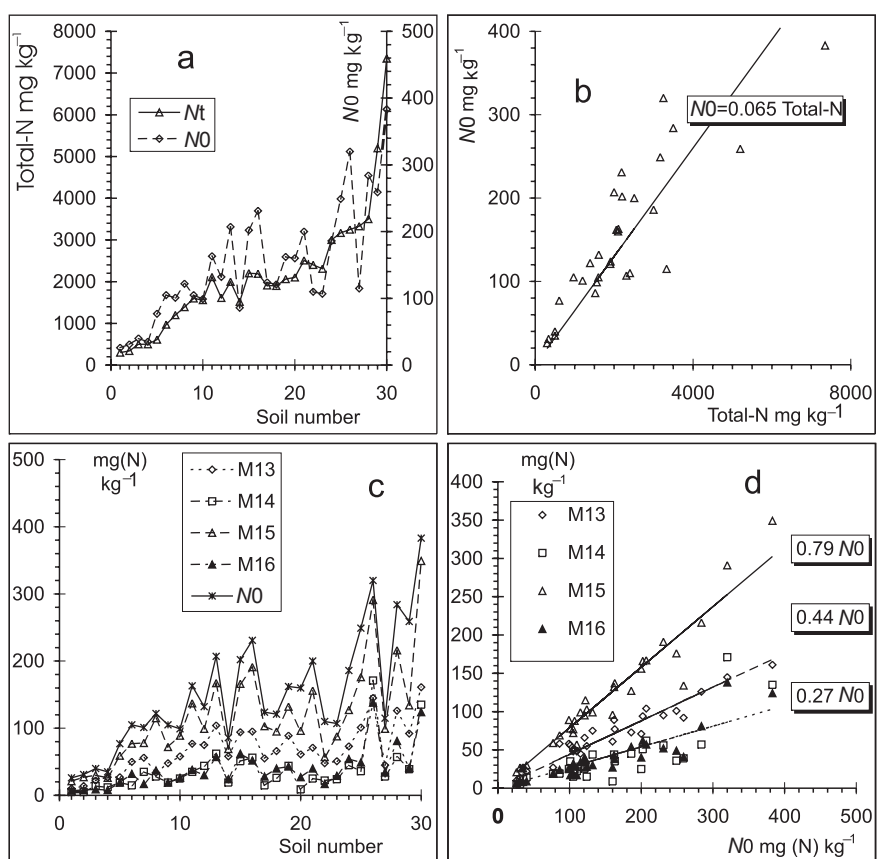

**Fig. 14.6.** Comparisons of measurements on 30 soil samples of different types (according to Gianello and Bremner, 1986). (a) and (b) potential of mineralization (*N0* of Stanford and Smith, 1972) and total nitrogen (total-N), (c) and (d) *N0* and four other biological measurements of potentially available nitrogen

Because of the large number of incubation techniques proposed, the only method described here is an adaptation of the Stanford and Smith (1972) method used at the IRD<sup>1</sup> centre of Montpellier (J.C. Talineau, personal communication; Fahd-Rachid 1990).

### **Equipment**

- 10–30 polypropylene Büchner funnels (depending on the size of the sample series) with a 5.5 or 7 cm diameter for tropical soils low in nitrogen
- Standard glass fibre filters type Whatman GF/A corresponding to the size of the Büchner funnels
- Film permeable to air and impermeable to water such as parafilm (Rhône-Poulenc, France) to cover the beakers
- Drying oven (for incubation) precisely adjustable between 20 and 50°C (proportional regulation)
- 10–30 150 mL beakers
- 10–30 250 mL filter flasks
- A pressure gauge in the 0–1 atmosphere range
- A microcomputer equipped with statistical software allowing adjustment of linear and nonlinear regression, or semi-logarithmic graph paper

### **Products**

- Pure sand, free from organic matter, sieved to between 0.5 and 2 mm.
- 0.01 mol (CaCl<sub>2</sub>) L<sup>-1</sup> solution. Dissolve 7.35 g of CaCl<sub>2</sub>·2H<sub>2</sub>O in distilled water, complete to 5 L and agitate well.
- Ion saturation solution without nitrogen 0.002 mol (CaSO<sub>4</sub>) L<sup>-1</sup>, 0.002 mol (MgSO<sub>4</sub>) L<sup>-1</sup>, 0.005 mol (CaHPO<sub>4</sub>) L<sup>-1</sup>, 0.0025 mol (K<sub>2</sub>SO<sub>4</sub>) L<sup>-1</sup>: dissolve 0.689 g of CaSO<sub>4</sub>·2H<sub>2</sub>O, 0.482 g of MgSO<sub>4</sub>, 1.720 g of CaHPO<sub>4</sub>·2H<sub>2</sub>O, 0.871 g of K<sub>2</sub>SO<sub>4</sub> in distilled water, complete to 2 L and agitate well.

---

<sup>1</sup>IRD = Institute of Research for the Development (ex-Orstom), P.O. Box 64501, 911 Avenue d'Agropolis, 34 394 Montpellier Cedex, France.



**Procedure**

- (a) For non-sandy soils, mix 30 g of air-dried soil sieved to 5 mm particle size with 10 g of sieved coarse sand, place it in a Büchner funnel (diameter 55 mm, capacity 80 mL) equipped with a fibre glass filter. For low-N sandy soils, place 50 g of soil (without the addition of sand) in funnels with a diameter of 70 mm. Some studies advise starting with fresh soil to minimize the initial flush of mineralization after water is added to a dried sample (Fahd-Rachid 1990). Stop the funnels with a plug of glass wool to protect the surface quality of the materials when moistening.

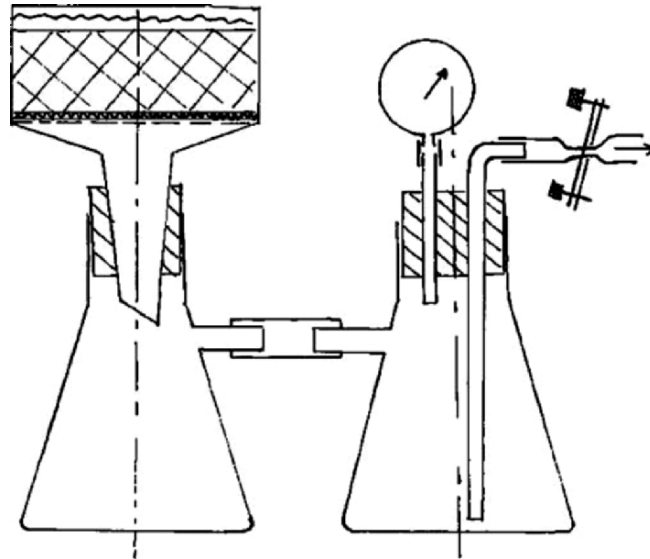

**Fig. 14.7.** Device used to adjust the moisture of the sample and ion equilibrium before incubation

- (b) Carry out percolation by simple gravity with 100 mL of 0.01 mol  $(\text{CaCl}_2) \text{L}^{-1}$  solution then with 25 mL of the ion saturation solution by collecting the whole of the leachate in the 150 mL beakers.
- (c) Regulate the moisture of the samples by causing a depression of 0.03 MPa compared to normal atmospheric pressure (corresponding absolute pressure: 0.0713 Mpa). According to several authors, this depression corresponds to the optimal mineralization moisture for many soils (Talineau JC, IRD Montpellier, personal communication). The equipment shown in Fig. 14.7 enables this operation to be carried out

- very simply using a glass filter pump and a tubing clamp. The solution collected in the filter flask is added to the previous percolation solution and can be temporarily cold stored before analysis.
- (d) Cover the funnels with parafilm and incubate in an incubator at 28°C. Place a flat water container in the incubator to maintain a moist atmosphere. It is possible to make a very simple rack to hold the Büchner funnels using an expanded polyurethane plate approximately 5 cm thick by drilling small holes to hold the funnel stems.
- (e) Remove the funnels from the incubator and start again from (b) for the periods of incubation chosen, e.g. 2, 4, 6, 8, 10, 12, 16 weeks (Fahd-Rachid 1990, Fig. 14.5).
- (f) Using the percolation solutions, identify the different forms of inorganic nitrogen: ammonium, nitrites, or nitrates, either by distillation of ammonia in the presence of a reducing agent (Dewarda alloy, Iron), using a steam distillation apparatus (Fig. 14.3) or any other method suitable for inorganic nitrogen (cf. Chap. 28). The percolation solutions at time 0 can be discarded or used to determine initial soil inorganic nitrogen. These initial results are not taken into account to determine potentially mineralizable nitrogen.
- (g) Write on a graph the cumulated values of inorganic nitrogen as a function of the incubation time (Fig. 14.5) and estimate the parameters of the adjustment (cf. "Principle" under Sect. 14.2.4).

### Discussion

The results depend to a large extent on the state of conservation and on the preparation of the soil samples. These operations always induce additional mineralization at the beginning of incubation partly by releasing organic matter sequestered in soil aggregates but especially by killing part of the microbial biomass. Dead biomass and released materials are consumed more rapidly at the beginning of incubation and this can result in overestimated results of mineralizable nitrogen. However, by comparing results obtained on an air-dried sample and on the same sample preserved fresh at cold temperature, Fahd-Rachid (1990) made two interesting observations:

- The differences between the sub-samples affected in particular the  $k$  value, which was approximately four times lower in fresh soil than in air-dried soil; the  $N_0$  values were modified by only approximately 20%.
- In the case of the dry soil, by subtracting the two first values of cumulated inorganic nitrogen (1 and 2 weeks of incubation) from the other values, one obtains a curve and parameters close to those observed in fresh soil.

The model of Stanford and Smith corresponding to (14.5) is not the only one that has been tested but is the simplest. Mary and Rémy (1979) proposed using the product  $kN_0$  to estimate the rough mineralization potential of soil nitrogen. Several authors tested models of evolution that are a little more complex:  $N_m = N_0(1 - e^{-k_1 t}) + k_2 t$  (Chaussod et al. 1986; Seyfried and Rao 1988),  $N_t = N_{01}(1 - e^{-k_1 t}) + N_{02}(1 - e^{-k_2 t})$  (Nuske and Richter 1981; Deans et al. 1986) and even a model made up of  $n$  pools of nitrogen with  $n$  mineralization kinetics (Richter et al. 1982). The use of these different models does not change the operational incubation procedure described earlier.

It is often possible to estimate mineralized nitrogen simply by the titration of nitrates,  $\text{NH}_4^+$  and  $\text{NO}_2^-$  being transition forms present in smaller quantities in a well-aerated medium.

The standard procedure of Stanford and Smith is only a rather rough simulation of the processes that occur in natural conditions. It can be criticised for two main reasons:

- It does not simulate the nitrogen cycle (Fig. 14.1) since the regular leaching of inorganic nitrogen favours mineralization and nitrification processes rather than immobilization and reduction processes. It is useful for the estimation of potentially mineralizable nitrogen (which may be overestimated) but does not enable estimation of the inorganic nitrogen that is really available for the plant at a given time.
- Leaching by the 0.01 mol  $(\text{CaCl}_2)$   $\text{L}^{-1}$  solution eliminates soluble organic nitrogen which could mineralize later (Robertson et al. 1988) resulting in underestimation of mineralizable nitrogen.

Moreover, if the simulation of the dynamic aspect of the formation of inorganic nitrogen has the undeniable advantage of reliability, the duration of the experiments may be an obstacle to their implementation. Consequently, many techniques have been proposed for faster determination of potentially available nitrogen (1) using faster biological methods (cf. “Alternatives”) and (2) using chemical extraction methods (cf. Sect. 11.2.5).

### 14.2.5 Potentially Mineralizable Nitrogen: Chemical Methods

#### *Principle*

As potentially mineralizable nitrogen represents only a fraction ranging between 5 and 10% of total nitrogen (an average of 6.5% according to the comparison in Fig. 14.6b), the energetic techniques of acid attack used in the determination of nitrogen forms (cf. Sects. 14.2.1 and 14.2.2) cannot be used here.

Many authors developed methods using less aggressive extracting reagents that were often tested with respect to plant needs in specific situations. These methods use the action of solutions such as (1) neutral salts (KCl, CaCl<sub>2</sub>) in cold solutions but more often in hot solutions and (2) more or less alkaline salts in hot or slightly oxidizing solutions. The ammonium nitrogen extracted by these solutions is then measured.

Velly et al. (1980) observed a very good correlation between plant N-needs and total nitrogen extracted using the technique of Giraud and Fardeau (1977) on cold KCl extracts. The methods using hot KCl extracts were the subject of most investigations (e.g. Φien and Selmer-Olsen 1980; Whitehead 1981; Gianello and Bremner 1986). Whitehead (1981) noted that his home-made extraction method i.e. boiling for 1 h with 1 mol (KCl) L<sup>-1</sup> solution, gave a good estimate of the quantities of nitrogen taken up by pastures. Fox and Piekielek (1978) tested extractions with NaHCO<sub>3</sub> 0.01 N solutions according to the method of Mac Lean (1964) followed by UV absorption measurements of nitrates and nitrites at 205 nm. Keeney (1982) recommended the use of a CaCl<sub>2</sub> solution in an autoclave. Gianello and Bremner (1986, 1988) recommended measuring ammonium by distillation in the presence of a solution of phosphate–borate buffer at pH 11.2. Stanford and Smith (1978) proposed titration of the ammonium released by attack with a KMnO<sub>4</sub> solution in acid medium. Stanford (1978) proposed extraction with a permanganate solution in alkaline medium.

The study by Gianello and Bremner (1986) on 30 soils with very different organic contents enables the relative effectiveness of different techniques to be compared.

Figure 14.8 groups all their results with the samples ranked according to their increasing organic contents. As in Fig. 14.6, the *N*<sub>0</sub> value of Stanford and Smith (cf. Sect. 14.2.4) is used for comparison. The methods compared were classified in four graphs representing different levels of extracted nitrogen.

- The M3, M4, M5 graph groups three alternative methods of extraction with 2 mol (KCl) L<sup>-1</sup> hot solutions in a closed bottle (M3: heating at 100°C for 4 h, M4: heating at 95°C for 16 h, M5 (Φien and Selmer-Olsen 1980): heating at 80°C for 20 h. The average extracted quantities account for 8–20% of *N*<sub>0</sub>, the M4 method giving the higher extraction. The respective correlation coefficients with *N*<sub>0</sub> are all highly significant: 0.95 for M3, 0.96 for M4, 0.93 for M5.
- The M6, M7 graph groups two other alternative extractions with hot 1 mol (KCl) L<sup>-1</sup> solutions: M6 (Whitehead 1981): boiling 1 h in a digestion tube, M7: heating 1 h at 100°C in a stopped tube. The two methods give very comparable results, but the quantities extracted are the lowest of all the methods, lower than 5% of *N*<sub>0</sub> (Fig. 14.9).

Moreover, these two methods are the least correlated with  $N_0$  ( $r = 0.81$  and  $0.83$ , respectively).

- The M8, M9 graph compares the two methods “distillation with phosphate–borate buffer” (M8, Gianello and Bremner 1986, 1988) and “ $\text{CaCl}_2$  – autoclave” (M9, Keeney 1982). The quantity of extracted nitrogen is a lot higher than in all the KCl tests with an average of 27% of  $N_0$  for M8 and 50% of  $N_0$  for M9. The M8 method with the phosphate–borate buffer thus extracts almost half less nitrogen than the M9 autoclave method. However, it provides results that are better correlated with  $N_0$  ( $r = 0.95$  for M8 and  $0.92$  for M9; Fig. 14.9c).

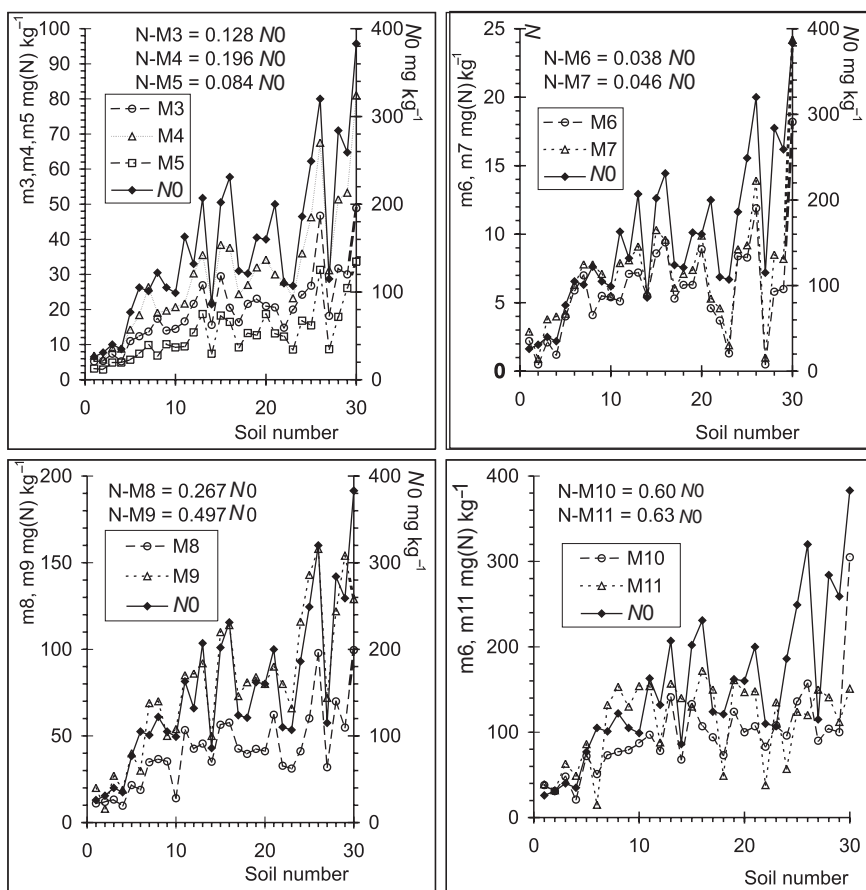

**Fig. 14.8.** Comparison of measurements of potentially mineralizable nitrogen using chemical methods with the potential of mineralization  $N_0$  of Stanford and Smith (1972); the 30 soils tested correspond to those in Fig. 14.6; they are ranked in order of increasing organic carbon content (according to Gianello and Bremner 1986); the average fractions extracted by each method compared to  $N_0$  are given for the 30 soils

- The M10, M11 graph compares the methods using controlled oxidation with permanganate in acid medium (M10, Stanford and Smith 1978) and in alkaline medium (M11, Stanford 1978). These two methods extract the most nitrogen. The average extracted values in the two methods are very close, 60–65% of  $N_0$ . However, there is very little correlation between the two types of results and their correlations with  $N_0$  are the least significant of the methods compared, particularly for alkaline oxidation ( $r = 0.85$  for M10;  $r = 0.48$  for M11).

Only the procedure M8 for the method by distillation of ammonium in the presence of phosphate–borate buffer of Gianello and Bremner (1988) is described below. This procedure has the best correlation with the  $N_0$  of Stanford and Smith (Fig. 14.8). Its implementation is relatively simple and uses the same type of steam distillation equipment as for the determination of forms of nitrogen (cf. Fig. 14.3, Sects. 14.2.1 and 14.2.2). According to Gianello and Bremner, the samples showed practically no effect of drying and storage.

Nevertheless, this procedure has seldom been tested with respect to the real nitrogen needs of plants, so the other procedures for extraction using neutral salts should not be rejected (Campbell et al. 1997). In addition, a method such as permanganate oxidation in acid medium may provide results that are closer to  $N_0$  in absolute value. For details on the other procedures, please refer to the original publications cited earlier. The coefficients in Fig. 14.8 enable estimation of the approximate correspondence between the different results.

### **Equipment and Reagents**

#### **Equipment**

- Steam distillation apparatus (cf. Fig. 14.3 and Sects. 14.2.1 and 14.2.2).
- 200 mL Kjeldahl distillation flasks with standard 29/32 ground joints with hooks to attach springs.
- titrimeter equipped for acidimetry or a 5 mL precision manual burette graduated at 0.01 mL intervals.

*Reagents*

- Phosphate–borate buffer pH 11.2 (cf. solution 11 in “Reagents” under Sect. 28.2.1): put 200 g  $\text{Na}_3\text{PO}_4 \cdot 12\text{H}_2\text{O}$ , 50 g of  $\text{Na}_2\text{B}_4\text{O}_7 \cdot 10\text{H}_2\text{O}$  and approximately 1,800 mL water in a 2 L volumetric flask. Agitate until complete dissolution. Adjust the pH solution to 11.2 by adding  $\text{H}_3\text{PO}_4$  then complete the volume to 2 L. Store in a well-stopped bottle.
- Boric acid indicator solution: cf. solution 5 in “Reagents” under Sect. 28.2.1.
- Solution 0.005 mol ( $\frac{1}{2}\text{H}_2\text{SO}_4$ )  $\text{L}^{-1}$ : cf. solution 6 in “Reagents” under Sect. 28.2.1.
- MgO powder: Cf. product 9 in “Reagents” under section 28.2.1.
- Solution 2 mol (KCl)  $\text{L}^{-1}$ : dissolve 149.1 g of KCl in distilled water. Complete to 1 L, homogenize and preserve in well-stopped bottle.

**Procedure**

- Put 5 mL of the boric acid-indicator solution in a 100 mL Erlenmeyer flask with a mark indicating 50 mL volume and place under the condenser of the steam distillation apparatus (Fig. 14.3).
- Put 4 g soil sieved to 2 mm in a 200 mL distillation flask. Add 40 mL of phosphate–borate buffer solution at pH 11.2 and connect to the distillation apparatus.
- Begin distillation immediately by opening the vapour tap and stop when the distillate reaches the 50 mL mark.
- Titrate the ammonium by manual or automatic titration with the 0.005 mol ( $\frac{1}{2}\text{H}_2\text{SO}_4$ )  $\text{L}^{-1}$  solution. If  $V_1$  mL is the volume of titrating solution, the content of total ammonium (initial + mineralized) of the sample is  $t\text{NH}_3\text{-N} = 17.5 V_1 \mu\text{g g}^{-1}$  soil.
- If the exchangeable ammonium  $\text{NH}_3\text{-N}$  of the sample was determined beforehand (cf. Chap. 28), the mineralizable nitrogen can be calculated by the difference between  $t\text{NH}_3\text{-N}$  and  $\text{NH}_3\text{-N}$ . If not, initial  $\text{NH}_3\text{-N}$  can be determined using the same steam distillation equipment and the method of Keeney and Bremner (1966): distillation for 3.3 min on a 4 g sample in the presence of 20 mL of a 2 mol (KCl)  $\text{L}^{-1}$  solution and 0.2 mg MgO. If  $V_2$  is the volume of the 0.005 mol ( $\frac{1}{2}\text{H}_2\text{SO}_4$ )  $\text{L}^{-1}$  solution necessary for the titration of distilled ammonia, the mineralized  $\text{NH}_3\text{-N}$  from organic nitrogen is:  $17.5 (V_1 - V_2) \mu\text{g g}^{-1}$  of soil.

### 14.2.6 Kinetics of Mineralization

#### *Principle*

Methods for the determination of potentially mineralizable nitrogen (Sects. 14.2.4 and 14.2.5) measure the maximum potential of nitrogen fertility, but are far from the real nitrogen cycle which is closely linked to the carbon cycle (Pansu et al. 1998). Kinetic studies consist in simultaneously measuring the mineralization and transformation of carbon and nitrogen (1) in natural conditions using labelled  $^{14}\text{C}$  or  $^{13}\text{C}$  and  $^{15}\text{N}$  (Bottner et al. 2000) or unlabelled materials or (2) in controlled laboratory conditions: measurements of  $\text{CO}_2$ ,  $\text{NH}_4^+$  and  $\text{NO}_3^-$  produced by soils and labelled or unlabelled soil-input mixtures. The laboratory method adapted and used at IRD, Montpellier (Thuriès et al. 2000) is described below. The procedure varies particularly with respect to the length of incubation. To understand the kinetics of evolution of the unstable compartments, experiments lasting only 1 month or even less are often performed. To understand the evolution of more stable compartments, the incubation period must be longer than 100 days (Blet-Charaudeau et al. 1990). A 6-month period is often used. The extra work caused by experiments of long duration is not a major handicap because sampling is programmed logarithmically vs incubation time. Thus many samples are needed in the early stages but only a few in the last stages of incubation.

#### *Equipment*

**Fig.14.9.** Incubation unit for soil respirometry and C and N mineralization kinetics

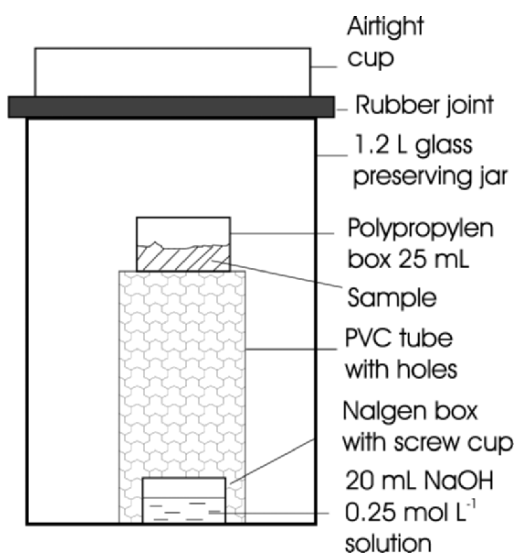



- A large bacteriological incubator adjustable to the chosen temperature  $\pm 0.3^\circ\text{C}$ , here  $28^\circ\text{C}$ .
- 1.2 L glass preserving jars with rubber seal.
- Sample holder made out of a PVC tube  $\varnothing 8$  cm, height 12 cm, with holes drilled in it and with two crossed wires at the end to hold the sample boxes (Fig. 9).
- Cylindrical 50 mL polypropylene boxes,  $\varnothing 5$  cm.
- 60 mL Nalgene boxes with screw lid.
- Desiccator filled with lime or baryta ( $\text{CO}_2$  adsorption).
- Titrimeter equipped with a titration cell under nitrogen flow.
- Precise volume distributor (for 20 mL standard soda solution) protected by a  $\text{CO}_2$  trap (NaOH pellets) at the top of the bottle.
- Products for titration of inorganic nitrogen (cf. Chap. 28).

### 2.6.3 Reagents

- Commercial standard 0.25 mol (NaOH)  $\text{L}^{-1}$  solution: quantitatively transfer the content of a plastic cartridge of commercial standard 0.5 mol (NaOH)  $\text{L}^{-1}$  solution in a 2 L volumetric flask, complete to volume and homogenize. Store in a volume distributor bottle with a trap filled with soda pellets fixed to the stopper.
- Commercial standard 0.25 mol (HCl)  $\text{L}^{-1}$  solution: dilute the required amount of commercial standard 0.5 mol (HCl)  $\text{L}^{-1}$  solution in a 2 L volumetric flask, complete to volume and homogenize.
- 20% barium chloride solution: dissolve 200 g  $\text{BaCl}_2$  in 800 mL water, agitate and complete to 1 L, if the solution is turbid, filter on fine filter paper.
- Products for extraction (molar KCl or  $\text{K}_2\text{SO}_4$  solution) and titration of inorganic forms of nitrogen (cf. Chap. 28).

### **Incubation Procedure**

Determine the maximum water holding capacity ( $\text{whc}$  in  $\text{g kg}^{-1}$ ) and the actual water content ( $\text{wc}$  in  $\text{g kg}^{-1}$ ) of the soil concerned.

Calculate the weight of the water ( $\text{ww}$ ) to be added to the test specimen of soil weight  $\text{sw}$  (in g, here 25 g):

$$\text{ww} = 0.75 (\text{whc} - \text{wc}) \text{sw} / 1000.$$

Choose the sampling design (Table 14.3) for C and N mineralization as a function of time  $t$  (days).

Weigh in the polypropylene boxes the required number of 25 g soil samples, bearing in mind that measurements on nitrogen are destructive but that measurements on carbon are not destructive for the sample. Programme 3 replicates.

In aluminium squares, weigh the test specimens of organic matter (added organic matter, AOM) that are added to the samples in case of experiment of kinetics of AOM mineralization. AOM is dried and prepared at the selected particle size, weight calculated according to the C:N ratio of AOM (Table 14.4). Fold these samples carefully in the aluminium squares, write their number with a felt pen and store in the refrigerator. For the experiments of kinetics of AOM mineralization, always include soil samples without addition (blanks). For the experiments of soil respirometry, include blanks without soil samples.

The day the test is started, moisten the soil samples on the balance with a weight of water  $<ww$ , add the AOM, homogenize carefully with a spatula and finish moistening on the balance with the exact  $ww$  weight of water. Note total weight  $tw$  of the moistened sample. Complete homogenisation.

Put the samples in the bacteriological incubator regulated at the temperature selected ( $28^{\circ}\text{C}$  at IRD Montpellier). Most of the boxes samples should be placed in plastic tanks covered with a plastic film perforated by piercing with a pin (permeable to the air but retaining the moisture in the sample). Only the samples intended for sampling  $t = 1$  (Table 14.3) should be placed in the incubation jars (Fig. 14.9). Place in each jar a Nalgene box containing exactly 20 mL of  $0.25 \text{ mol (NaOH) L}^{-1}$  aqueous solution. Stop carefully and leave in the incubator.

**Table 14.3.** Sampling design vs incubation time ( $t$  in day) for C and N mineralization kinetics ( $\times$  = sampling occasion)

T	0	1	2	3	5	7	10	14	21	28	41	61	90	100	120	130	152	180
C	x	x	x	x	x	x	x	x	x	x	x	x	x	x	x	x	x	x
N	x	x	x		x		x		x		x		x					x

**Table 14.4.** Recommended specimen test for studies of mineralization kinetics of added organic matter (AOM) in the soil

AOM	C:N ratio of AOM	weight of AOM
Organic–inorganic fertilizer, organic fertilizer	< 3	75–125 mg
organic fertilizer	3–15	250 mg
organic amendments, poor-N residue from fallow system or crop	> 15	500 mg or more

At time  $t = 1$ , open the glass jar, remove the polypropylene box containing the sample and store in the freezer for titration of inorganic nitrogen, remove the Nalgene box containing soda, close and preserve in the desiccator on lime or barite. Refill each jar with the following sample and a new Nalgene box containing 20 mL of  $0.25 \text{ mol (NaOH) L}^{-1}$

aqueous solution and repeat the same operation at each N sampling (Table 14.2). On days when only C is sampled, only change the soda solution and put back to incubate with the same sample.

Every 5 days, on the balance readjust the moisture of each sample to the weight previously noted tw.

### **Titration**

For mineralized nitrogen, extraction is performed with molar KCl or K<sub>2</sub>SO<sub>4</sub> aqueous solutions and titration following the instructions given in Chap. 28.

For mineralized carbon:

- Adjust the titrimeter by means of buffer solutions at pH 4 and 7; select the titration programme “with no initial addition, detection at a fixed final pH of 8.6, low speed of addition”.
- Quickly transfer the contents from the Nalgene box containing the soda-sample into the titration cell containing a small bar magnet while rinsing with a jet of water from the wash bottle, add 5 mL of BaCl<sub>2</sub> solution.
- Start moderate bubbling of nitrogen in the solution; introduce the pH electrode and the input tube of the acid titrating solution.
- Start titration, continue until it stops automatically and read the added volume of acid titrating solution in mL: *sV* for the sample, *cV* for the control (soil alone for AOM mineralization kinetics), and *bV* for the blank (without a sample of soil for soil respirometry).

### **Calculations**

Microbial respiration in the incubation pots causes carbonation of soda according to the reaction:

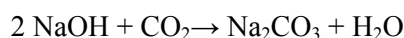

The carbonate formed is precipitated by barium chloride according to the reaction:

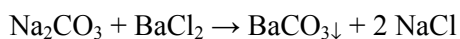

Excess soda is neutralized by hydrochloric acid:

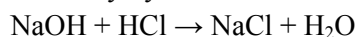

If at the beginning there are *n* moles of soda which are then carbonated by *x* moles of CO<sub>2</sub>, *n* – 2 *x* moles of soda will remain in the sample. The titration of the blank (soil respirometry) or control (AOM kinetics) relates to *n* moles of soda, consequently the respired CO<sub>2</sub> is obtained by: *n* – (*n* –

$2x = 2x$  and if aT is the acid titer ( $\text{mol L}^{-1}$ ),  $\text{CO}_2\text{-C}$  from the sample is expressed in millimoles by:

$$x = \frac{bV - cV}{2} \text{aT} \quad \text{for soil respiration,}$$

$$x = \frac{cV - sV}{2} \text{aT} \quad \text{for AOM kinetics.}$$

Please refer to Thuriès et al. (2001, 2002), Pansu and Thuriès (2003) and Pansu et al. (2003) for a more complete expression of these results and for details on modelling of the kinetics of mineralization.

### Remarks

- For AOM kinetics, the difference between inorganic nitrogen of the sample and inorganic nitrogen of the control can be positive (net mineralization) or negative (immobilization of the pre-existing inorganic nitrogen). Net mineralization occurs with relatively N-rich AOM and immobilization with low-N AOM. Recous et al. (1995) and Henriksen and Breland (1999) observed that when the nitrogen (from soil + AOM) is lower than  $0.012 \times$  (dry matter AOM), the growth of microbial biomass, and mineralization of C are all significantly reduced.
- The procedure described above remains valid for  $^{13}\text{C}$ ,  $^{14}\text{C}$  and  $^{15}\text{N}$  isotopic studies on measured inorganic forms of C and N: on soda solutions for C isotopes, and on KCl or  $\text{K}_2\text{SO}_4$  extracts for N isotopes.
- In addition to titrimetry, other techniques can be used for the titration of  $\text{CO}_2$  directly in the atmosphere of the incubation jars: by gas chromatography (gas–solid chromatography, catharometer detector) or by infra-red spectrometry.
- Calculations of the initial weight of soil test samples must take into account the risk of anoxia in the incubation jars. To avoid slowing down microbial respiration by the atmosphere, the oxygen content of the atmosphere in the jar should not drop by more than one-third of its initial value.
- The arrangement in the incubation jars (Fig. 14.9) is due to the fact that  $\text{CO}_2$  is heavier than air. It is thus more logical to place the sample box above the soda box.

### 14.3. Complementary Methods

#### 14.3.1 Alternative Procedures for Acid Hydrolysis

##### *Discontinuous Acid Hydrolysis*

Janel et al. (1979) criticized the use of hydrolysis methods for protein studies of complex mediums like soils (cf. Sects. 14.2.1 and 14.2.2 above). This technique is likely to give rise to “secondary reactions between nitrogen compounds and other breakdown products, sugars and other reducing compounds which involve insolubilizations and desaminations”.

These authors compared two hydrolysis techniques by reflux boiling with 3 mol (HCl) L<sup>-1</sup> solutions applied to beech tree litter. Hydrolysis was conducted in parallel for 40 h (1) uninterrupted hydrolysis and (2) discontinuous hydrolysis by decanting the hydrolysate at selected times and replacing it with a fresh attack solution. Changes in total-, amino- and ammonia-nitrogen were monitored in each solution series.

There were similarities between the results of the two hydrolysis techniques, but the changes in the different forms were much more regular in the case of discontinuous hydrolysis: the growth of amino nitrogen followed the growth of hydrolysable total nitrogen, the NH<sub>3</sub>-N rate was weaker and almost constant and the rate of non-hydrolyzable nitrogen was under 10%, i.e. much lower than that reported by Bremner (1965) and Stevenson (1982a,b) (Table 14.4). On the other hand, the fraction called combined-N representing unknown hydrolyzed nitrogen remained almost constant at approximately 35% of nitrogen at each hydrolysis time in both methods. This probably represents unstable products that are easily transformed right from the beginning of hydrolysis.

The discontinuous technique thus appeared to be more reliable and was recommended to replace the methods listed earlier in Sects. 14.2.1 and 14.2.2. However, it does not use the same concentration of acid, and has not been tested on a large number of samples. In addition it is considerably more complex to implement. The debate is still open on the type of hydrolysis to use. For example, Egoumenides et al. (1987) used the continuous classical technique, whereas Barriuso et al. (1990) chose to adapt the technique of Janel et al. (1979).

##### *Acid Hydrolysis with Hydrofluoric Pre-Attack*

Some observations showed a weak recovery of the amino acids in clay sediments poor in nitrogen. For this reason, a hydrofluoric acid pre-

treatment was sometimes recommended in hydrolysis procedures (e.g. Cheng et al. 1975; Stevenson and Cheng 1970). The pre-treatment was also recommended by Stevenson (1982a) in the case of further colorimetric titration of amino acids (cf. Sect. 14.3.2):

- Place 50–125 mg of finely crushed soil in a 50 mL polypropylene centrifuge tube, add 2.5 mL of a 5 mol (HF)–0.1 mol (HCl) L<sup>-1</sup> solution and agitate for 24 h on a back and forth shaker (for calcareous samples, acidify with HCl 6 mol L<sup>-1</sup> before adding the HCl–HF solution).
- Add 5 mL of distilled water and freeze-dry to eliminate the hydrofluoric acid.
- Add 10 mL of 6 mol (HCl) L<sup>-1</sup> solution and heat in an oil bath at 110°C with a cooling finger inside the tube to avoid evaporation.
- Let cool and filter on Whatman n°42 filter paper; wash the residue with 10–15 mL of distilled water.

### 14.3.2 Determination of Amino Acids

#### *Principle*

The distillation method in the presence of ninhydrin described in Section 14.2.1 above is well suited for the analysis of soils and sediments containing relatively large quantities of amino acids. For N-poor substrates, it is essential to use more sensitive techniques e.g. colorimetric or chromatographic methods.

For a complete and relatively rapid measurement, the most widely used colorimetric method (e.g. Moore and Stein 1948; Stevenson 1965, 1982a,b,c) measures absorbance of the blue complex produced with ninhydrin at pH 5 (Fig. 14.2). Interference with the metal cations of the hydrolysates can be avoided by conducting the reaction in the presence of a chelating agent. Ammonium and the other nitrogen compounds that are unstable in basic medium (amino sugars) are eliminated by an alkaline pretreatment before the ninhydrin reaction.

Chromatographic methods are more difficult to implement. However, they are more reliable and less subject to interference than colorimetric methods. They also deliver approximately 20 times more information with the individual titration of each amino acid. Nevertheless, the information is difficult to interpret in complex mediums like soils and there are not many studies on this subject.

The free amino acids of the soil solutions can be separated using thin layer chromatography (TLC) with two dimensions (Monreal and McGill 1985). However, the most reliable techniques use liquid ion exchange chromatography and specific apparatuses are available

for the measurement of amino acids which function by double ionic exchange. Reverse phase high performance liquid chromatography (HPLC) with precolumn derivatisation with *o*-phthalaldehyde has also been successfully used in soil chemistry (e.g. Warman and Bishop 1985, 1987). Gas chromatography has also been used (e.g. Jocteur Monrozier 1984; Barriuso et al. 1990; Pansu, unpublished data). These techniques have the disadvantage of requiring double derivatization to block the acid and amine functions before injection into the chromatograph, but they have the advantage of good resolution and high sensitivity.

### **Colorimetry with Ninhydrin**

This procedure was proposed by Stevenson (1965, 1982a,b,c).

- Perform the 6 mol (HCl) L<sup>-1</sup> hydrolysis with a hydrofluoric acid pre-attack (cf. Sect. 14.3.1).
- Collect the filtrate and washing water of the hydrolysis in a second 50 mL polypropylene centrifugation tube and freeze-dry to eliminate HCl.
- To eliminate ammonium and amino sugars: dissolve the residue in 5 mL of distilled water, add two or three drops of phenolphthalein (0.1% ethanolic solution) and titrate with the 5 mol (NaOH) L<sup>-1</sup> solution until it turns pink (at approximately pH 11). Put the tube in an oil bath at 100°C; after 10 min, evaporate by sweeping the surface with a small air flow to reduce the volume to approximately 2 mL.
- Add the 6 mol (HCl) L<sup>-1</sup> solution drop by drop until dissolution of the metal hydroxides (solution turns pale yellow) and complete the volume with ammonium-free water.
- *Colorimetry*. Put 0.5 mL of solution in a test tube and add 0.5 mL of a 0.2 mol L<sup>-1</sup> sodium citrate solution (177.6 mg of dehydrated sodium citrate in 1 L of water). Shake well then add 2 mL of solution prepared as follows: 25 mL of pH 5 sodium acetate buffer solution (500 g CH<sub>3</sub>COONa,3H<sub>2</sub>O + 100 mL CH<sub>3</sub>COOH in 1 L aqueous solution), 50 mL of ninhydrin reagent (4% solution in methyl cellosolve, Kodak) stored in the dark under nitrogen in the presence of Dowex-50 resin in H form, 25 mL water and 80 mg of SnCl<sub>2</sub>,2H<sub>2</sub>O. Cover with an aluminium capsule and place the tube in a boiling water bath at 100°C for 30 min. Cool with cold water, add 5 mL of 50% ethanol solution and measure colour absorbance at 570 nm. Dilute the over-concentrated samples with more 50% ethanol. Compare with a standard range prepared starting from a standard leucine solution containing 28 mg (amino-N) L<sup>-1</sup>: 0.262 g of leucine + 100 mL 0.1 mol (HCl) L<sup>-1</sup> solution in 1 L water.

## Gas–liquid Chromatography

### Principle

A procedure developed for the analysis of the amino acids of proteins by Zanetta and Vincendon (1973) was adapted for soil analysis. Gas–liquid chromatography is performed on the N(O)-heptafluoro-butyrate derivatives of the isoamyl esters of amino acids. The technique is thus rather similar to a previously described technique for the separation of N-trifluoroacetates of butylic esters of amino acids (Gehrke et al. 1971), and used in soil analysis (Jocteur Monrozier 1984; Barriuso et al. 1990). According to Zanetta and Vincendon, the N(O)-heptafluorobutyrate technique may have two advantages over the N-trifluoroacetate technique (1) all the amino acids are more easily separated on commonly used columns and (2) the derivatives are less volatile and the acylation products can be eliminated before injection without risk of loss. The separation obtained by Zanetta and Vincendon was improved at IRD laboratories by the use of a capillary column (Fig. 14.10).

### Preparation of samples

- Place 5 mL of soil extract or soil hydrolysate and 100  $\mu\text{L}$  of a 10  $\mu\text{mol mL}^{-1}$  pipecolic acid solution (internal standard) in a cylindrical conical Pyrex flask with a PTFE screw cap.
- Bring to dry by freeze-drying, add 400  $\mu\text{L}$  of anhydrous 1.25 mol (HCl)  $\text{L}^{-1}$  methanolic solution (prepared by dissolution in anhydrous methanol) of HCl vapour produced by action of  $\text{H}_2\text{SO}_4$  on NaCl and dried by bubbling in pure  $\text{H}_2\text{SO}_4$ . Let cool for 30 min to 1 h then bring to dry by sweeping the surface with a nitrogen flow at 50°C.
- Add 400  $\mu\text{L}$  of the 1.25 mol (HCl)  $\text{L}^{-1}$  isoamyl alcohol solution (prepared in the same way as the methanol–HCl solution) and heat the hermetically stopped reaction flasks at 110°C for 2 h 30 min. Cool and bring to dry under a nitrogen flow at 80°C as previously described.
- Dissolve the isoamyl esters in 400  $\mu\text{L}$  of acetonitrile and add 60  $\mu\text{L}$  of heptafluorobutyric anhydride. Heat the hermetically stopped reaction flasks at 150°C for 10 min. Cool and bring just to dry under a nitrogen flow as previously described.
- Dissolve the N(O)-heptafluorobutyrate derivatives of the isoamyl esters of amino acids in 0.5 mL ethyl acetate and inject into the chromatograph or store in the refrigerator until injection.
- At the same time and in the same way, prepare a standard mixture with (1) 1 mL of a solution containing 1  $\mu\text{mol mL}^{-1}$  of each amino acid (commercial standard) and (2) 100  $\mu\text{L}$  of a 10  $\mu\text{mol mL}^{-1}$  (pipecolic acid) solution (internal standard). This solution is used to determine the



response coefficients of each amino acid compared to the pipecolic acid.

#### **Note**

If the solutions are rich in inorganic matter, it is advisable to separate these materials before amino acid titration. The simplest way consists in filtering the mixture either immediately before injection, or at the first stage (methanol-HCl) using a syringe filter. Preliminary fractionation by ion exchange is also possible (Gehrke et al. 1971).

#### **Chromatographic Conditions**

- Capillary column with no-polar phase e.g. SE30, interior diameter 0.3 mm and length 50 m
- Carrier gas helium, input pressure 1.1 bar
- Programming of furnace: 70–270°C at 4°C min<sup>-1</sup>
- Flame ionization detector, 250°C
- Splitter-injector, leak flow 50 mL min<sup>-1</sup>

Figure 14.10 shows a chromatogram obtained under these conditions.

#### **Note**

Although the detection limit is often satisfactory for soils, it can still be considerably improved (1) by using an injector with elimination of solvents (glass needle or split-splitless injector) and (2) by using an electron capture detector (sensitive to the fluorinated derivatives), the latter enables detection of ultratraces of amino acids.

### **14.3.3 Determination of Amino Sugars**

#### **Colorimetric Determination**

The colorimetric procedures used for determination of amino sugar in the soil are based on the method described by Elson and Morgan (1933). In alkaline medium, amino sugars react with acetylacetone to give a pyrrole derivative. In acid medium, this derivative produces red condensation with the Ehrlich reagent (*p*-dimethylamino-benzaldehyde in an ethanol-HCl mixture).

The problem with this technique is its relative lack of selectivity; many substances like iron, amino sugar-acid mixtures, and brown humified products are able to interfere with colouration. In addition, this method suggested by Stevenson (1982a) is rather complex. Before colorimetry, double purification of the extracts has to be performed, first on anion resin, then on cation resin.

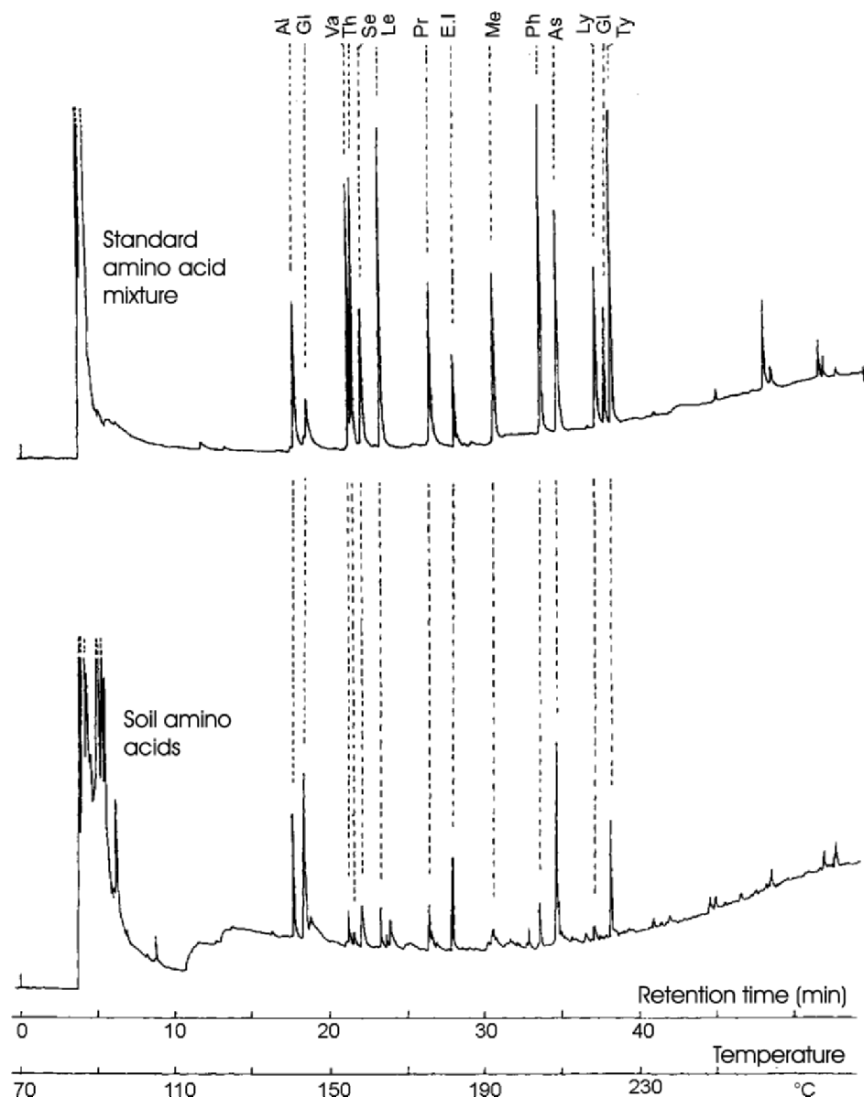

**Fig.14.10.** Separation by gas chromatography on a standard mixture of amino acids and on a soil extract (Pansu, unpublished data) in the chromatographic conditions described in text. *Al* Alanine, *Gl* Glycine, *Va* Valine, *Th* Threonine, *Se* Serine, *Le* Leucine, *E.I.* pipecolic acid internal standard, *Me* Methionine, *Ph* Phenylalanine, *As* Asparagine, *Ly* Lysine, *Gl* Glutamic acid, *Ty* Tyrosine

More recently, Scheidt and Zech (1990) developed a simplified method for soils inspired by the work of Butseva et al. (1985). This technique, which is still based on that of Elson and Morgan (1933), does not require preliminary purification. After colorimetry, the typical amino sugar chromophore is separated by alkalization and extracted in ethyl ether for colorimetric measurement. This technique appeared to be promising but was not often tested.

### **Chromatography**

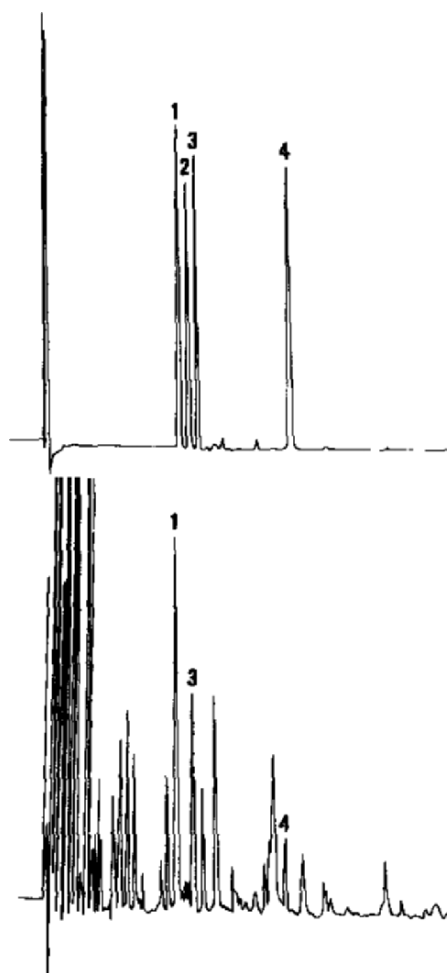

**Fig. 14.11.** Separation by gas chromatography of amino sugars from a standard solution and a soil hydrolysate (Kögel and Bochter 1985); 1 glucosamine, 2 mannosamine, 3 galactosamine, 4 *p*-amino-phenol-HCl (internal standard)

Although like for amino acids, the most widely used techniques are based on ion exchange liquid chromatography, a gas chromatography method was specially developed for the determination of amino sugars in soils (Benzing-Purdie 1981; 1984; Kögel and Bochter 1985). After elimination of the hydrochloric acid of hydrolysis, amino sugar forms are reduced with a solution of sodium borohydride ( $\text{NaBH}_4$ ) then the trifluoroacetate derivatives are synthesized by the action of trifluoroacetic anhydride. These derivatives are separated on a capillary column, then identified and quantified by a detector that selects nitrogen compounds, using *p*-amino-phenol as internal standard (Fig. 14.11).

#### 14.3.4 Proteins and Glycoproteins (glomalin)

The proteins and glycoproteins in soils originate from decomposition products or are synthesized in situ by micro-organisms. The latter is true of glomalin, a glycoprotein identified by immunofluorescence on hyphae of arbuscular mycorrhizal fungi during active colonization of roots (Wright et al. 1996). Wright and Upadhyaya (1996) observed abundant concentrations of glomalin, ranging from 4 to 15 mg (protein)  $\text{g}^{-1}$  (soil) on 12 American soils they tested. Glomalin was studied for its role in the structural stability of soils (Wright et al. 1999; Franzluebbers et al. 2000). It is difficult to solubilize, Wright and Upadhyaya (1998) distinguished:

- An “easily” extractable glomalin fraction: 0.25 g soil + 2 mL 20 mM sodium citrate extracting reagent at pH 7 and at 121°C for 30 min.
- *Total glomalin*. The same as above with 50 mM citrate at pH 8 and at 121°C for 90 min or more (sequential extractions).

After centrifuging for 5 min at 5,000g, the protein of the supernatant is measured on a perforated micro titration plate by means of a colouring test for the analysis of proteins using steer serum albumin as standard of calibration.

#### 14.3.5 Potentially Mineralizable Nitrogen by EUF

The technique of EUF was sometimes used to try to separate cations and anions in soluble or more or less exchangeable forms from the organomineral complex in the soil. Figure 14.12 illustrates the principle of this method. A continuous electric field is applied to the water–soil suspension between two filtration membranes. The cations and anions which cross the membranes are collected in the cathodic and anodic compartments, respectively. This method appears to be appropriate but has two disadvantages (1) the accumulation of clays on the anodic filter membrane which slows down the anion exchange processes (nitrates) and

(2) a rise in the pH of the cation cell which is likely to result in loss of ammonium by volatilization (Németh et al. 1988). The second problem can be avoided by adding a hydrochloric acid solution in the cathode compartment.

This method was also proposed for the study of the different forms of nitrogen (Németh et al. 1979; Németh 1985) using two extractions:

- 0–35 min at 20°C and 200 V; this corresponds to the extraction of the actual inorganic nitrogen (ammonium and nitrate).
- 35–40 min at 80°C and 400 V; this characterizes mineralizable organic nitrogen available for plants during their periods of growth.

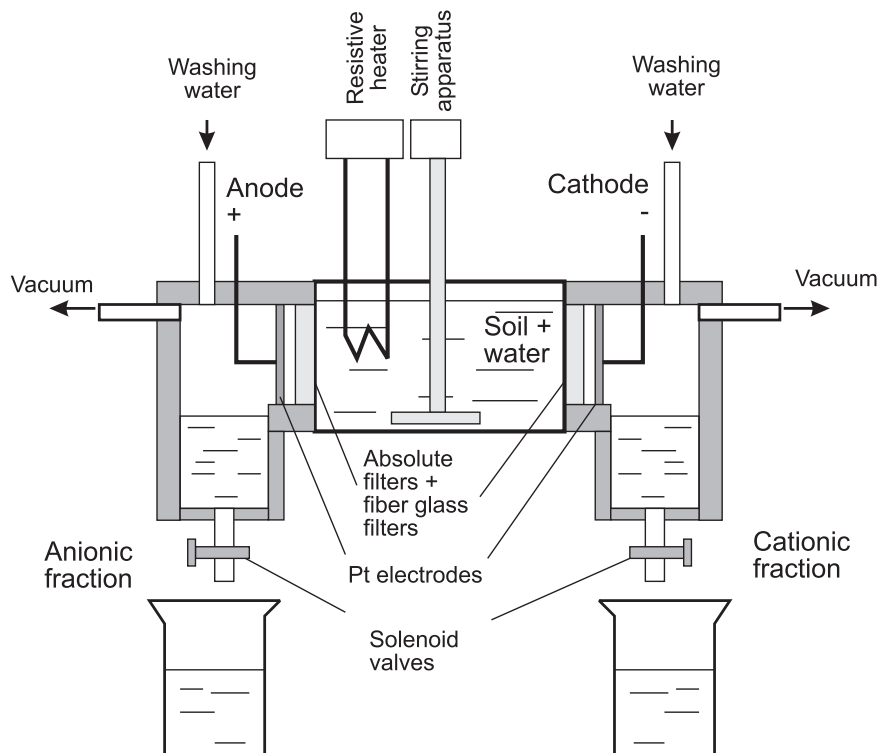

**Fig. 14.12.** Schematic diagram of an electro-ultrafiltration (EUF) apparatus

EUF techniques have been the object of sometimes contradictory criticism: reproducibility was considered acceptable (Sheehan 1985) but sometimes less so than the reproducibility of more common extraction techniques that are also easier to implement (Houba et al. 1986). Fahd-Rachid (1990) found reproducibility to be generally acceptable for extractable nitric nitrogen but generally unacceptable for EUF mineralizable

organic nitrogen. Mengel (1996) used EUF to study the turnover of soil organic nitrogen and its availability for crops, Diez and Vallejo (2004) compared EUF and other methods to determine potentially available organic-N.

## References<sup>2</sup>

### Organic Nitrogen Forms: General Articles

- Chotte JL (1986) Evolution d'une biomasse racinaire doublement marquée (<sup>14</sup>C, <sup>15</sup>N) dans un système sol-plante : étude sur un cycle annuel d'une culture de maïs. Thèse Doctor. Univ. Nancy I, 116 p.+annexes
- Guiraud G (1984) *Contribution du marquage isotopique à l'évaluation des transferts d'azote entre les compartiments organiques et minéraux dans les systèmes sol-plante.*, Thèse Doct. es Sciences, Paris 6, 335 p
- Jocteur Monrozier L and Andreux F (1981) L'azote organique des sols, exemples de quantification des formes protéiques et des combinaisons complexes. *Science du sol.*, 3, 219–242
- Jocteur Monrozier L (1984) *Nature et évolution de l'azote organique dans les sols et les sédiments marins récents.*, Thèse Doct. Etat, Univ. Nancy1, 176 p
- Kelley KR and Stevenson FJ (1995) Forms and nature of organic N in soil. *Fert. Res.*, 42, 1–11
- Lavoisier AL (1789) *Traité élémentaire de chimie*, Paris
- Matsumoto S, Yamagata M, Koga N and Ae N (2001) Identification of organic forms of nitrogen in soils and possible direct uptake by plants. *Dev. Plant Soil Sci.*, 92, 208–209
- Schipper LA, Percival HJ and Sparling G.P. (2004) An approach for estimating when soils will reach maximum nitrogen storage. *Soil Use Manage.*, 20, 281–286
- Schulten HR and Schnitzer M (1998) The chemistry of soil organic nitrogen : a review. *Biol. Fertil. Soils*, 26, 1–15
- Stevenson FJ (1982a) Nitrogen-organic forms. In *Methods of Soil Analysis*, Page AL, Miller RH and Keeney DR ed. ASA-SSSA N°9 part 2, 2nd edition, 625–641
- Stevenson FJ (1982b) Organic forms of soil nitrogen. In *Humus Chemistry*, Wiley, New York, 55–119
- Stevenson FJ (1982c) Origin and distribution of nitrogen in soil. In *Nitrogen in Agricultural Soils*, Stevenson FJ ed. American Society of Agronomy, 1–42
- Stevenson FJ (1996) Nitrogen-organic forms. In *Methods of Soil Analysis*, Bigham JM and Bartels JM ed. ASA-SSSA N°5 part 3, 3rd edition, 1185–1200

<sup>2</sup> The authors quoted several times in the text are indicated in only heading where their contribution was considered to be the most significant.

### Nitrogen Forms by Acid Hydrolysis and Distillation

- Bremner (1960) Forms of nitrogen in soils and plants. *Rothamsted Exp. Stat. Rep.*, for 1959, p 59
- Bremner (1965) Organic forms of soil nitrogen. In *Methods of Soil Analysis*, Black CA et al. ed. American Society of Agronomy, USA 9, part 2, 1238–1255
- Egoumenides C, Risterucci A and Melebou KE (1987) Appréciation de la fertilité azotée des sols tropicaux : étude des fractions organiques de l'azote. *L'agronomie tropicale*, 42, 85–93
- Keeney DR and Bemner JM (1967) A simple steam distillation method of estimating  $\beta$ -hydroxy- $\alpha$ -amino acids. *Anal. Biochem.*, 18, 274–285
- Tracey MV (1952) The determination of glucosamine by alkaline decomposition. *Biochem. J.*, 52, 265–267
- Van Slyke (1911–1912) The analysis of proteins by determination of the chemical groups characteristic of the different amino-acids. *J. Biol. Chem.*, 10, 15–55

### Improvement of Acid Hydrolysis

- Barriuso E, Andreux F and Portal JM (1990) Caractérisation par hydrolyse acide de l'azote des fractions organiques et organo-minérales d'un sol humifère. *Science du sol.*, 1990, 28, 223–236
- Cheng CN, Shufeldt RC and Stevenson FJ (1975) Amino acid analysis of soils and sediments : extraction and desalting. *Soil Biol. Biochem.*, 7, 143–151
- Griffith SM, Sowden FJ and Schnitzer M (1976) The alkaline hydrolysis of acid-resistant soil and humic acid residues. *Soil Biol. Biochem.*, 8, 529
- Janel Ph, Jocteur Monrozier L and Toutain F (1979) Caractérisation de l'azote des litières et des sols par hydrolyse acide, *Soil Biol. Biochem.*, 11, 141–146

### Determination of Amino Acids

- Gehrke CW, Zumwalt RW and Kuo K (1971) Quantitative amino acid analysis by gas-liquid chromatography. *J. Agric. Food Chem.*, 19, 605–618
- Monreal CM and McGill WB (1985) Centrifugal extraction and determination of free amino acids in soil solutions by TLC using tritiated 1-fluoro-2,4-dinitrobenzène. *Soil Biol. Biochem.*, 17, 533–539
- Moore S and Stein WH (1948) Photometric ninhydrin method for use in the chromatography of amino acids. *J. Biol. Chem.*, 176, 367–388
- Stevenson FJ and Cheng CN (1970) Amino acids in sediments : recovery by acid hydrolysis and quantitative estimation by a colorimetric procedure. *Geochim. Cosmochim. Acta.*, 34, 77–88
- Stevenson (1965) Amino acids. In *Methods of Soil Analysis*, Black C.A. et al. ed. American Society of Agronomy 9, part 2, 1437–1451
- Warman PR and Bishop C (1985) The use of reverse-phase HPLC for soil amino-N analysis, *J. Liquid Chromat.*, 8, 2595–2606

- Warman PR and Bishop C (1987) Free and HF-HCl-extractable amino acids determined by high performance liquid chromatography in a loamy sand soil. *Biol Fertil. Soils*, 5, 215–218
- Zanetta JP and Vincendon G (1973) Gas-liquid chromatography of the N(O)-heptafluorobutyrate of the isoamyl esters of amino acids. I. Separation and quantitative determination of the constituent amino acids of proteins. *J. Chromat.*, 76, 91–99

### Determination of Amino Sugars

- Benzing-Purdie L (1981) Glucosamine and galactosamine distribution in a soil as determined by gas-liquid chromatography on soil hydrolysates: effect of acid strength and cations. *Soil Sci. Soc. Am. J.*, 45, 66–70
- Benzing-Purdie L (1984) Amino sugar distribution in four soils as determined by high resolution gas chromatography. *Soil Sci. Soc. Am. J.*, 48, 219–222
- Burtseva TI, Cherkasova SA and Ovodov YuS (1985) Quantitative determination of amino sugars in bacterial lipopolysaccharides. *Khimiya Prirodnikh Soedinenii*, 6, 739–743
- Elson LA and Morgan WTJ (1933) A colorimetric method for the determination of glucosamine and chondrosamine. *Biochem. J.*, 27, 1824–1828
- Kögel I and Bochter R (1985) Amino sugar determination in organic soils by capillary gas chromatography using a nitrogen-selective detector. *Z. Pflanzenernaehr. Bodenk.*, 148, 260–267
- Scheidt M and Zech W (1990) A simplified procedure for the photometric determination of amino sugars in soil. *Z. Pflanzenernähr. Bodenk.*, 153, 207–208

### Glomalin

- Franzluebbers AJ, Wright SF and Stuedemann JA (2000) Soil aggregation and glomalin under pastures in the southern piedmont USA. *Soil Sci. Soc. Am. J.*, 64, 1018–1026
- Wright SF, Franke-Snyder M, Morton JB and Upadhyaya A (1996) Time-course study and partial characterization of a protein on hyphae of arbuscular mycorrhizal fungi during active colonization of roots. *Plant Soil*, 181, 193–203
- Wright SF and Upadhyaya A (1996) Extraction of an abundant and unusual protein from soil and comparison with hyphal protein of arbuscular mycorrhizal fungi. *Soil Sci.*, 161, 575–586
- Wright SF and Upadhyaya A (1998) A survey of soils for aggregate stability and glomalin, a glycoprotein produced by hyphae of arbuscular mycorrhizal fungi. *Plant Soil*, 198, 97–107
- Wright SF, Starr JL and Paltineanu IC (1999) Changes in aggregate stability and concentration of Glomalin during tillage management transition. *Soil Sci. Soc. Am. J.*, 63, 1825–1829



### Urea Titration

- Beaton JD (1978) Urea– its popularity grows as a dry source of nitrogen. *Crops Soils*, 30, 11–14
- Bremner JM (1982) Nitrogen-Urea. In *Methods of Soil Analysis, Part 2*, Page AL et al. ed. ASA-SSSA N°9 part 2, 2nd edition, 699–709
- Douglas LA and Bremner JM (1970) Extraction and colorimetric determination of urea in soils. *Soil Sci. Soc. Am. Proc.*, 34, 859–862
- Douglas LA, Sochtig H, and Flaig W (1977) Colorimetric determination of urea in soil extracts using an automated system. *Soil Sci. Soc. Am. J.*, 42, 291–292
- Fearon WR (1939) The carbamido diacetyl reaction : a test for citrullin. *Biochem. J.*, 33, 902–907
- Mulvaney RL and Bremner JM (1979) A modified diacetyl monoxime method for colorimetric determination of urea in soil extracts. *Commun. Soil Sci. Plant Anal.*, 10, 1163–1170
- Watt GW and Chrisp JD (1954) Spectrophotometric method for determination of urea. *Anal. Chem.*, 26, 452–453

### Potentially Mineralizable Nitrogen : General Papers

- Catroux G, Chaussod R and Nicolardot B (1987) Appréciation de la fourniture d'azote par le sol. *C. R. Acad. Agric. Fr.*, 73, 71–79
- Cornforth IS and Walmsley D (1971) Methods of measuring available nutrients in west indian soils. I. Nitrogen. *Plant Soil*, 35, 389–399
- Dahnke WC and Johnson GV (1990) Testing soils for available nitrogen. In *soil Testing and Plant Analysis*, 3rd. ed. SSSA book series, n°3, 127–139
- Fahd-Rachid (1990) *Mise au point méthodologique sur l'estimation de l'azote organique potentiellement minéralisable dans le sol.*, DEA INP-ENSAT Toulouse, Document ORSTOM-Montpellier N°1, 60 p. multig.
- Gianello C and Bremner JM (1986) Comparison of chemical methods of assessing potentially available organic nitrogen in soil, *Commun. Soil Sci. Plant Anal.*, 17, 215–236
- Giroux M and Sen Tran T (1987) Comparaison de différentes méthodes d'analyse de l'azote du sol en relation avec sa disponibilité pour les plantes. *Can. J. Soil Sci.*, 67, 521–531
- Juma NG and Paul EA (1984) Mineralizable soil nitrogen : Amounts and extractability ratios, *Soil Sci. Soc. Am. J.*, 48, 76–80
- Keeney DR and Bremner JM (1966) Comparison and evaluation of laboratory methods of obtaining an index of soil nitrogen availability. *Agron. J.*, 58, 498–503
- Keeney DR (1982) Nitrogen-Availability indices. In *Methods of Soil Analysis, Part 2*, Page AL et al. ed. ASA-SSSA N°9 part 2, 2nd edition, 711–733

**Potentially Mineralizable Nitrogen : Biological Methods**

- Benedetti, A., Sebastiani, G. 1996. Determination of potentially mineralizable nitrogen in agricultural soils. *Biology and Fertility of Soils* 21, 114–120
- Cabrera ML and Kissel DE (1988) Evaluation of a method to predict nitrogen mineralized from soil organic matter under field conditions. *Soil Sci. Soc. Am. J.*, 52, 1027–1031
- Campbell CA (1978) Soil organic carbon, Nitrogen and fertility. In *Soil Organic Matter*, Schnitzer and Khan ed. Elsevier, Amsterdam, 224–225 and 254
- Chaussod R, Nicolardot B, Soulas G and Joannes H (1986) Mesure de la biomasse microbienne dans les sols cultivés. II-Cinétique de minéralisation de matière organique microbienne marquée au C<sup>14</sup>. *Rev. Ecol. Biol. Sol.*, 23, 183–196
- Deans JR, Molina JAE and Clapp CE (1986) Models for predicting potentially mineralizable nitrogen and decomposition rate constants. *Soil Sci. Soc. Am. J.*, 50, 323–326
- Keeney DR and Bremner JM (1967) Determination and isotope ratio analysis of different forms of nitrogen in soil : 6. mineralizable nitrogen. *Soil Sci. Soc. Am. Proc.*, 31, 34
- Marquardt DW (1963) An algorithm for least-squares estimations of nonlinear parameters. *J. Soc. Ind. Appl. Math.*, 11, 431–441
- Mary B and Rémy JC (1979) Essai d'appréciation de la capacité de minéralisation de l'azote des sols de grande culture. I. Signification des cinétiques de minéralisation de la matière organique humifiée. *Ann. Agron.*, 30, 513–527
- Nuske A and Richter J (1981) N-mineralization in löss-parabrownearthes : incubation experiments. *Plant Soil*, 59, 237–247
- Reynolds WD and Beauchamp EG (1984) Comments on “ Potential errors in the first-order model for estimating soil nitrogen mineralization potentials ”, *Soil Sci. Soc. Am. J.*, 48, 698
- Richter J, Nuske A, Habenicht and W Bauer J (1982) Optimized N-mineralization parameters of loess soils from incubation experiment. *Plant Soil*, 68, 379–388
- Robertson K, Schnürer J, Clarholm M, Bonde TA and Rosswall T (1988) Microbial biomass in relation to C and N mineralization during laboratory incubations. *Soil Biol. Biochem.*, 20, 281–286
- Seyfried MS and Rao PSC (1988) Kinetic of nitrogen mineralization in Costa Rican soils: model evaluation and pretreatment effects. *Plant Soil*, 106, 159–169
- Smith JL, Schnabel RR, McNeal BL and Campbell GS (1980) Potential errors in the first-order model for estimating soil nitrogen mineralization potentials. *Soil Sci. Soc. Am. J.*, 44, 996–1000
- Stanford G and Smith SJ (1972) Nitrogen mineralization potentials of soils. *Soil Sci. Soc. Am. Proc.*, 36, 465–472

- Stanford G, Carter JN, and Smith SJ (1974) Estimates of potentially mineralizable soil nitrogen based on short-term incubations. *Soil Sci. Soc. Am. Proc.*, 38, 99–102
- Waring SA and Bremner JM (1964) Ammonium production in soil under waterlogged conditions as an index of nitrogen availability. *Nature (London)*, 201, 951

### Potentially Mineralizable Nitrogen: Chemical Methods

- Campbell CA, Jame YW, Jalil A and Schoenau J (1997) Use of hot KCl-NH<sub>4</sub>-N to estimate fertilizer N requirements. *Can. J. Soil Sci.*, 77, 161–166
- Fox RH and Piekielek WP (1978) A rapid method for estimating the nitrogen-supplying capability of a soil. *Soil Sci. Soc. Am. J.*, 42, 751–753
- Gianello C and Bremner JM, (1988) A rapid steam distillation method of assessing potentially available organic nitrogen in soil, *Commun. Soil Sci. Plant Anal.*, 19, 1551-1568
- Guiraud G and Fardeau JC (1977) Dosage par la méthode Kjeldahl des nitrates contenus dans les sols et les végétaux. *Ann. Agron.*, 28, 329–333
- Mac Lean OA (1964) Measurement of nitrogen supplying power of soils by extraction with sodium bicarbonate. *Nature*, 203, 1307–1308
- Φien A and Selmer-Olsen AR (1980) A laboratory method for evaluation of available nitrogen in soil. *Acta Agric. Scand.*, 30, 149
- Stanford G and Smith SJ (1978) Oxidative release of potentially mineralizable soil nitrogen by acid permanganate extraction, *Soil Sci.*, 126, 210
- Stanford G (1978) Evaluation of ammonium release by alkaline permanganate extraction as an index of soil nitrogen availability. *Soil Sci.*, 126, 244
- Velly J, Egoumenides C, Pichot J and Marger JL (1980) L'azote extractible par une solution de KCl et la fourniture d'azote à la plante dans 40 sols tropicaux. *Agronomie tropicale*, 35, 374–380
- Whitehead DC (1981) An improved chemical extraction method for predicting the supply of available soil nitrogen. *J. Sci. Food Agric.*, 32, 359–365

### Potentially Mineralizable Nitrogen by EUF

- Diez JA and Vallejo A (2004) Comparison of two methods for nitrogen extraction of irrigated Spanish soils and related nitrogen balance calibrations. *Commun. in Soil Sci. Plant Anal.*, 35, 2227–2242
- Houba VJG, Novozamsky I, Huybregts AWM and Van der Lee JJ (1986) Comparison of soil extractions by 0.01M CaCl<sub>2</sub>, by EUF and by some conventional extraction procedures. *Plant Soil*, 96, 433–437
- Mengel K (1996) Turnover of organic nitrogen in soils and its availability to crops. *Plant soil*, 181, 83–93

- Nemeth K (1985) Recent advances in EUF research (1980-1983). *Plant and Soil*, 83, 1–19
- Nemeth K, Bartels H, Vogel H and Mengel K (1988) Organic nitrogen compounds extracted from arable and forest soils by EUF and recovery rats of amino acids. *Biol. Fertil. Soils*, 5, 271–275
- Nemeth K, Makhdum IQ, Koch K and Beringer H (1979) Determination of categories of soil nitrogen by electro-ultrafiltration (EUF). *Plant Soil*, 53, 445–453
- Sheehan MP (1985) Experiments on the reproducibility of results from EUF soil extracts with possible improvements resulting from these experiments. *Plant Soil*, 83, 85–92

### Mineralization Kinetics

- Blet-Charaudeau, C, Muller, J and Laudelout, H (1990) Kinetics of carbon dioxide evolution in relation to microbial biomass and temperature. *Soil Sci. Soc. of Am. J.*, 54, 1324–1328
- Bottner P, Coûteaux MM, Anderson JM, Berg B, Billès G, Bolger T, Casabianca H, Romanya J and Rovira P (2000) Decomposition of <sup>13</sup>C labelled plant material in a European 65-40° latitudinal transect of coniferous forest soils: simulation of climate change by translocation of soils. *Soil Biol. & Biochem.*, 32, 527–543
- Henriksen, TM and Breland, TA (1999) Nitrogen availability effects on carbon mineralization, fungal and bacterial growth, and enzyme activities during decomposition of wheat straw in soil. *Soil Biol. & Biochem.*, 31, 1121–1134
- Pansu M, Sallih Z and Bottner P (1998) Modelling of soil nitrogen forms after organic amendments under controlled conditions. *Soil Biol. & Biochem.*, 30, 19–29
- Pansu M and Thuriès L (2003). Kinetics of C and N mineralization, N immobilization and N volatilization of organic inputs in soil. *Soil Biol. & Biochem.*, 35, 37–48
- Pansu M, Thuriès L, Larré-Larrouy MC and Bottner P (2003) Predicting N transformations from organic inputs in soil in relation to incubation time and biochemical composition. *Soil Biol. & Biochem.*, 35, 353–363
- Recous, S, Robin, D, Darwis, D and Mary, B (1995) Soil inorganic N availability: effect on maize residue decomposition. *Soil Biol. & Biochem.*, 27, 1529–1538
- Thuriès L, Larré-Larrouy MC and Pansu M (2000) Evaluation of three incubation designs for mineralization kinetics of organic materials in soil. *Commun. Soil Sci. Plant Anal.*, 31, 289–304

- Thuriès L, Pansu M, Feller C, Hermann P, and Rémy JC (2001) Kinetics of added organic matter decomposition in a mediterranean sandy soil. *Soil Biol. & Biochem.*, 33, 997–1010
- Thuriès L, Pansu M, Larre-Larrouy MC and Feller C (2002) Biochemical composition and mineralization kinetics of organic inputs in a sandy soil. *Soil Biol. & Biochem.*, 34, 239–250

## Part 3

### Inorganic Analysis

Exchangable and  
Total Elements

## pH Measurement

### 15.1 Introduction

#### 15.1.1 Soil pH

In the range of measurements available to characterize a soil at a given time, the measurement of pH (potential of the  $H^+$  ion) is undoubtedly one of the most widely used. Its simplicity and speed of implementation make measuring soil pH a routine laboratory operation.

In soil science, for practical purposes, the pH range is reduced from 0–14 to 1–12. Soils with an extreme pH are strongly influenced by salts, resulting in very acid sulphated soils to highly alkaline carbonated soils. The aim of pH measurement depends on the user as described later.

*In the laboratory*, preliminary measurement of pH enables suitable methods of extraction and measurement to be chosen that are appropriate for acid, neutral or basic soils as a function of the pH of the soil concerned (e.g. measurement of exchangeable cation or available elements like phosphorus). However, it should be kept in mind that “soil pH” represents only the pH of a solution in equilibrium with the soil.

*From a soil scientist's point of view*, measurement of the pH of a soil sample is a global assessment. The French pedological reference base (INRA, 1995) gives the following classification for the pH spectrum:

pH lower than 3.5	hyper-acid
between 3.5 and 5.0	very acid
between 5.0 and 6.5	acid
between 6.5 and 7.5	neutral
between 7.5 and 8.7	basic
greater than 8.7	very basic.

The pH characterizes the physicochemical environment of a soil at a given site, this being the result of instantaneous equilibriums controlled by different components of the medium, for example:

- Mixed sulphated salts with hyper-acid reaction resulting from sulphide oxidation of the mangrove (acid sulphated soils).
- A range of organic or inorganic acids and elements such as aluminium or iron which are likely to acidify the soil solution after acid hydrolysis starting from minerals or from the exchange complex.
- Neutral salts of strong acids and strong bases, or soils with a saturated exchange complex but with low calcium carbonate which have a pH close to neutral.
- In the presence of calcium carbonate in an open system at partial pressure of atmospheric CO<sub>2</sub>, equilibrium is established around pH 8.4 in soil suspensions; CO<sub>2</sub> pressure can reach higher values, especially in deep soil horizons, and can significantly affect the equilibrium pH.
- In certain soils, magnesium carbonate results in high pH values i.e. around pH 9. Sodic carbonated salts result in the highest values which can exceed pH 10.

This review of the pH spectrum of soils emphasizes *from a static point of view* the influence of two types of factors on this complex equilibrium:

- At the extremes of the range, the influence of large quantities of very soluble acid or basic salts; and, to a lesser extent, the influence of organic or inorganic acids and of all compounds that can cause acid hydrolysis.
- In soils, the system is generally more dependent on CO<sub>2</sub> pressure and on elements involved in the exchange complex (H<sup>+</sup> ions, metal ions) which buffer possible variations in pH through permanent exchanges between the soil and the soil solution.

However, it is essential to consider pH measurement *from a dynamic point of view* because of the many different types of equilibrium likely to be established at different times which oscillate under the influence of different internal and external factors. Waterlogging of the soil undoubtedly has the most influence on the physicochemical environment. Seasonal variations in moisture and especially the rhythm of these variations can significantly modify the concentration of the soil solution by hydrolysis and by the release of protons or cations, dissolution and leaching, or on the contrary, by concentration and precipitation. These general remarks about environmental aspects emphasize several different concepts concerning the pH of the soil:

- Actual acidity or alkalinity expressed by the concentration of dissociated protons in the soil solution.
- Exchange acidity resulting from protons fixed on the exchangeable complex and likely to move after exchange with neutral salts (KCl).



- Potential acidity expressed by the acidity (measured in saturation conditions) of sulphides (acid sulphated soils) or more generally after displacement of all the acid functions of the soil by hydrolysis.
- Buffering capacity which limits variations in pH by continuous exchange between the soil and soil solution, the most important determining factors being the degree of dilution and the quality of the exchange complex (clay type and saturation rate).

From an agronomic point of view the pH is initially an indicator of the state of soil fertility. It provides information about possible chemical degradation of the soil due to desaturation, the possible presence of certain toxic salts, and about microbial activity, as well as the degree of assimilability of elements by plants, the best range of solubility being between pH 5.5 and pH 6.5. Below pH 5.5, certain elements can be toxic (e.g. free aluminium, manganese), other elements may not be in available forms (e.g. phosphorus) or may sometimes be fixed in the solid phase. Above 6.5, other elements cannot be available (e.g. trace elements).

Knowledge of soil pH also makes it possible to choose to grow crops e.g. acidophilic plants like tea or coffee, or plants with neutrophilic cells. Finally it provides useful information enabling the right choice of corrective action (1) fertilizer with an acidifying (e.g. ammonia salts), neutralizing or alkalizing (e.g. saltpetre, ammonia) action and (2) fertilizer or amendment to increase or decrease the pH and to improve the fertility of cultivated soils (e.g. liming). However, knowledge of the pH alone is not sufficient to evaluate, for example, the precise lime requirements (cf. Chap. 24) or exchange acidity and aluminium toxicity (cf. Chap. 23).

### 15.1.2 Difficulties

Measuring pH is simple, but this simplicity can be misleading as the pH measurement can be wrong if careful attention is not paid to details (such as the state of junction of the electrodes and electric stability). A precise measurement procedure should be used and the technical choices should be appropriate. Several other aspects should also be considered when interpreting results:

- pH measurements are most often carried out in standardized conditions, on disturbed samples and soil suspensions, and this means they do not reflect the real conditions.
- The problem of the spatial variability of measurement linked to the heterogeneous condition of the soil horizons, of aggregates and of organized microsites.
- Natural or induced temporal variations due to the influence of external factors like moisture or the cultivation system.

All these points argue in favour of in situ pH measurement. If *carried* out continuously under perfect technical conditions, the results of in situ pH measurement (cf. Sect. 15.3) will be the closest possible to the real conditions in the field and thus the most likely to provide information on the complex equilibria between the soil and its solution, as well as on the many external factors that influence them. Despite these facts, standardized laboratory measurements remain the most widely used because they are simple to implement.

### 15.1.3 Theoretical Aspects

According to Brönsted, acids release protons by dissociation during the reaction:



This reaction takes place in the presence of an acceptor of protons. A strong acid is an acid which can release protons more easily. Two solutions of equal molecular concentration, one of hydrochloric acid, the other of acetic acid, both require the same quantity of soda to be neutralized. But a rise in temperature during neutralization has a stronger effect on hydrochloric acid: it can thus be said that hydrochloric acid is “stronger” than acetic acid. It is this concept of “strength” – which for a long time remained unclear – which is quantified by the measurement of pH. In the case of a strong acid, the equilibrium of reaction (15.1) is strongly moved to the right. It is possible to quantify the strength of an acid by determining the quantity of  $\text{H}^+$  ions the acid can dissociate.

The dissociation of an acid (HA) in a solvent (S) can be written:

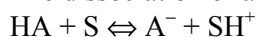

Most often the acid is in aqueous solution. The water solvent can play the role of either an acid:

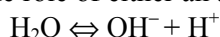

or a base :

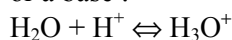

Applying the mass action law:

$$|\text{OH}^-| |\text{H}_3\text{O}^+| / (\text{H}_2\text{O})^2 = K$$

$K$  is a dissociation constant determined at a given temperature. As the dissociated part remains extremely weak compared to the total number of water molecules, the denominator can be regarded as constant, thus:

$$|\text{H}_3\text{O}^+| |\text{OH}^-| = K_{\text{H}_2\text{O}} \quad (15.2)$$

with  $K_{\text{H}_2\text{O}} = 10^{-14}$  at  $25^\circ\text{C}$ . As in pure water, ionized  $\text{H}_3\text{O}^+$  and  $\text{OH}^-$  forms are equal:  $|\text{H}_3\text{O}^+| = |\text{OH}^-| = 10^{-7}$ . Thus in aqueous solution, the addition of an acid will increase the quantity of  $\text{H}_3\text{O}^+$  hydronium ions giving  $|\text{H}_3\text{O}^+| > 10^{-7}$ . In neutral medium  $|\text{H}_3\text{O}^+| = 10^{-7}$  and in alkaline

medium  $\text{H}_3\text{O}^+ < 10^{-7}$ . The Sorensen representation (1909), called pH, was adopted because of its convenience:

$$\text{pH} = -\log |\text{H}_3\text{O}^+| \quad (15.3)$$

pH expresses the activity of the hydronium ion. In the case of an aqueous solution of strong acid, this activity is comparable with the concentration of the acid. In the case of a strong base, it can be calculated with formula (15.2). pH ranges between pH 0 (very acid) and pH 14 (very basic). Ten-fold dilution modifies the pH by one unit (in the case of strong acids or bases). In practice, if the concentration of the  $\text{H}^+$  ions is multiplied by two, the pH decreases by approximately 0.3. According to (15.1) and the law of mass action:

$$|\text{Base}| |\text{H}_3\text{O}^+| / |\text{acid}| = K_A. \quad (15.4)$$

$K_A$  defines the acidity constant of the acid/base couple (in activities). It is more convenient to use:

$$\text{p}K_A = -\log K_A. \quad (15.5)$$

An acid is stronger since its  $\text{p}K_A$  is low. Equations (15.3–15.5) enable the creation of a general formula of pH of an acid solution in equilibrium with its combined base:

$$\text{pH} = \text{p}K_A + \log (|\text{Base}| / |\text{Acid}|). \quad (15.6)$$

Equation (15.6) shows that the fluctuations in the pH of a solution decrease with variations in concentration when the acid form is in balance with a similar quantity of the corresponding basic form. The pH then approaches  $\text{p}K_A$ . Such a solution has a stable pH, and is not very sensitive to the addition of an acid or base. This stabilizing effect is called *buffer effect*. It is obtained by mixing an acid and corresponding base or an acid and one of its ionized salts. Buffer solutions are used as reference pH or to maintain a fixed pH in certain reactions. The exchange complex of soils has also a buffering effect on the soil solution in equilibrium while fixing or releasing protons.

Equation (15.6) is not valid in the case of acids or bases alone in solution (pH would then tend to  $-\infty$  or  $+\infty$ , respectively). However it is always easy to calculate the pH using formulas (15.2–15.5) with the following approximations:

*In the case of an aqueous solution of weak acid* the equilibrium reaction of dissolution  $\text{AH} + \text{H}_2\text{O} \rightleftharpoons \text{H}_3\text{O}^+ + \text{A}^-$  shows that the concentration of the  $\text{A}^-$  basic form is similar to the concentration of the  $\text{H}_3\text{O}^+$  ions induced by dissolution. In addition, if  $C_A$  is the total concentration of the acid, the concentration of the AH acid form becomes  $C_A - [\text{H}_3\text{O}^+]$ . In the case of a weak acid, the concentration of the hydronium ions can be considered as weak compared to  $C_A$ . Equation

(15.4) thus becomes  $K_A = |\text{H}_3\text{O}^+|^2 / C_A$  which, applying equations (15.3) and (15.5) with  $C_A$  expressed in normality, gives:

$$\text{pH} = (\text{p}K_A - \log C_A)/2. \quad (15.7)$$

*In the case of a weak basic aqueous solution* the equilibrium reaction is written:  $\text{B} + \text{H}_2\text{O} \rightleftharpoons \text{BH} + \text{OH}^-$ . The concentration of the acid form BH is similar to that of  $\text{OH}^-$  ions induced by dissolution. If  $C_B$  is the total concentration of the base, the concentration of the basic form B is written:  $C_B - |\text{OH}^-|$ . In the case of a weak base, the concentration of  $\text{OH}^-$  ions remains weak compared to  $C_B$  and (15.4) relating to the equilibrium of BH acid can be written:  $K_A = C_B |\text{H}_3\text{O}^+| / |\text{OH}^-|$

which, applying (15.2), (15.3) and (15.5), gives:

$$\text{pH} = 7 + 1/2 (\text{p}K_A + \log C_B). \quad (15.8)$$

*Lewis applied the acid–base concept of Bronsted* to non-protonic systems suitable for all solvents, an acid being a substance that can accept electrons and a base being a substance that can produce electrons. The pooling of an electronic doublet of the base with the free orbital of the acid results in neutralization. Clay minerals with sites that can produce electrons can be regarded as Lewis bases, whereas hydroxyl and carboxyl groups of soil organic matter that can accept electrons correspond to Lewis acids.

## 15.2 Classical Measurements

### 15.2.1 Methods

As described in Sect. 15.1.3, pH defines the activity of the hydronium ion. This ion activity is only comparable with the ion concentration in the case of sufficiently diluted solutions. The concentration of an acid is its titration acidity (total acidity). The activity defines the quantity of “free” (i.e. dissociated)  $\text{H}^+$  ions taken into account in the pH measurement. Two methods are used (1) the colorimetric method, which is inexpensive and fast but not very precise especially in turbid or coloured mediums and (2) the electrometric method which is more commonly used.

**Table 15.1.** Main coloured indicators available in the range of pH of soils

common name	chemical name	acid form	pH transition	basic form
thymol blue	thymol sulphone phthalein	red	1.9 orange	yellow
dinitrophenol	2,6 ou 2,4 dinitrophenol	colourless	3.1	yellow
methyl orange	dimethyl amino azo benzene sodium sulphonate	red	3.7 yellow	orange
bromo phenol blue	tetra bromo phenol sulphone phthalein	yellow	4.0 purple	violet
bromo cresol green	tetra bromo <i>m</i> -cresol sulphone phthalein	yellow	4.6 green	blue
chloro phenol red	dichloro phenol sulphone phthalein	yellow	5.6 pink orange	purple
<i>p</i> -nitrophenol	<i>p</i> nitro phenol	colourless	5.2	yellow
methyl red	dimethyl amino azo benzene <i>o</i> -carboxylic acid	red	5.7 orange	yellow
bromo cresol purple	dibromo <i>o</i> -cresol sulphone phthalein	yellow	6.2 purple	violet
bromo thymol blue	dibromo thymol sulphone phthalein	yellow	6.9 green	blue
phenol red	phenol sulphone phthalein	yellow	7.3 red orange	violet
<i>m</i> -cresol purple	<i>m</i> -cresol sulphone phthalein	yellow	8.3 orange	red
phenolphthalein	phenolphthalein	colourless	8.3 pink	pink
thymol blue	thymol sulphone phthalein	yellow	8.9 purple	blue violet
alizarine yellow	nitrobenzene azo salicylic acid	yellow	10.3 orange	red

## 15.2.2 Colorimetric Method

### **Principle**

This is a cheap fast method which can be used for a rapid investigation of the soil. The main difficulty is making a visual comparison with

a coloured standard, and comparison can be particularly difficult in the case of coloured or turbid solutions. An apparatus for photoelectric comparison can be used to avoid errors resulting from observations made with the naked eye.

It was known for many years that coloured substances were likely to change colour as a function of the acid or basic nature of a solution (Table 15.1). How the colour indicators functioned finally became clear in the light of the theory of electrolytic dissociation. Coloured indicators can be regarded as weak electrolytes in which one of the ions is coloured, whereas the condensed form is colourless or of another colour, according to a dissociation equilibrium of type:

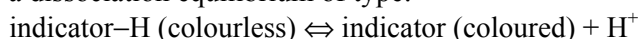

pH indicators also frequently use impregnation of paper strips that can be put in direct contact with most soils. This method is very rapid but not very precise (disturbance by the ionic micellar mediums, salts, time of equilibrium, etc.). It is used for preliminary tests in the field or laboratory (Pansu et al. 2001).

### **Measurements**

Variation in colour is only perceptible within the transition zone, which for the majority of indicators represents a change of one pH unit. The existing indicators cover a range from pH 1 to pH 12 (Tables 15.1 and 15.2). Measurement consists in comparing the colour of an indicator in a buffer solution of given pH (Table 15.3) with the colour obtained by adding the indicator to the unknown solution. Using chrysoidine, Qiu and Zhu (1986) simultaneously determined the pH, the buffer power and the lime requirement of soils.

The unknown solution is put in a tube of the same shape as the tube containing the standard buffers; and a predetermined number of drops of indicator are added to the solution. As mentioned earlier, visual comparison is often difficult because the unknown solutions may themselves be slightly coloured or turbid. Comparison can be improved by using a standard comparator (Fig. 15.1).

**Table 15.2.** Preparation of indicators for soils with a pH range from 2.8 to 11

indicator	pH transition	colour transition	concentration of solutions	pK at 18°C
$\alpha$ dinitrophenol	2.4–4.4	colourless to yellow	0.1 g in 200 mL water	4.06
$\gamma$ dinitrophenol	4–5.4	colourless to yellow	0.1 g in 440 mL water	5.15
<i>p</i> -nitrophenol	5.2–7.6	colourless to yellow	0.1 g in 100 mL water	7.18
<i>m</i> -nitrophenol	6.6–8.8	colourless to yellow	0.3 g in 100 mL water	8.33
phenolphthalein	8.5–10.5	colourless to red	0.04 g in 100 mL alcohol at 30%	9.73
alizarine yellow	10–12	colourless to yellow	0.05 g in 100 mL alcohol at 50%	11.16

**Table 15.3.** Preparation of pH reference solutions with Britton and Robinson's universal buffer

V: volume in mL of solution 2 to add to 100 mL of solution 1 to obtain the corresponding pH

<b>Solution 1</b>	Phosphoric acid	$\text{H}_3\text{PO}_4$ mw = 98, $d = 1.70$ (85%)	2.71 mL
	Acetic acid	$\text{CH}_3\text{COOH}$ , mw = 60, $d = 1.05$ (100%)	2.28 mL
	Boric acid	$\text{H}_3\text{BO}_3$ , mw = 61.8, 99%	2.5 g
	Dissolve and bring to 1,000 mL		

**Solution 2** Aqueous solution NaOH M/5 (carbonate free)

$\alpha$ dinitrophenol		$\gamma$ dinitrophenol		<i>p</i> -nitrophenol		<i>m</i> -nitrophenol		phenolphthalein	
V	pH	V	pH	V	pH	V	pH	V	pH
17.5	2.87	25	4.10	37.5	5.3	50	6.8	65	8.69
20	3.29	27.5	4.35	40	5.72	52.5	7	67.5	8.95
22.5	3.78	30	4.56	42.5	6.09	55	7.24	70	9.15
25	4.10	32.5	4.78	45	6.37	57.5	7.54	72.5	9.37
27.5	4.35	35	5.02	47.5	6.59	60	7.96	75	9.62
		37.5	5.33	50	6.80	62.5	8.36	77.5	9.91
				52.5	7	65	8.69	80	10.38

### Procedure

To make scales of comparison, add 6 mL of buffer solution (Table 15.3) in a graduated test tube suitable for use with the Walpole standard comparator (Fig. 15.1). Add 1 mL of the indicator solution that is appropriate for the pH concerned (Table 15.2). Treat the soil solution in the same way.

The aim is to obtain the same colours in (1) the tube containing the unknown solution (position 2 in Fig 15.1) as in (2) the standard tubes

representing gradual variations in pH (and thus in colour) in positions 1 and 3. Places 6 and 4 are occupied by the unknown solution with no indicator to eliminate the effect of the original colour of this solution. These measurements are rapid and have an accuracy of only 0.2 pH units. If the solution is turbid, preliminary standard filtration on a Millipore filter is recommended.

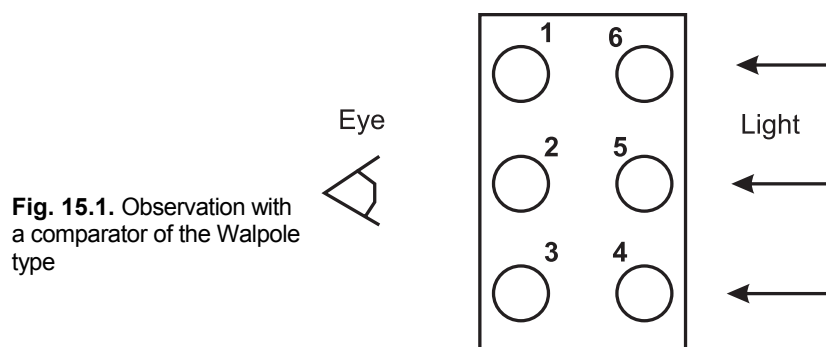

**Fig. 15.1.** Observation with a comparator of the Walpole type

### 15.2.3 Electrometric Method

#### **Principle**

The electrometric method is the most frequently used method for soil analysis as it is more precise than the colorimetric method. It enables both turbid and coloured mediums to be analysed and continuous measurements to be made.

To measure true pH values a thin layer of hydrogen can be obtained by saturating of nascent hydrogen a platinum electrode covered with platinum black. Plunging this electrode into a solution measures the potential difference  $E$  (volts) as a function of the concentration in  $H^+$  ions which can be estimated by the relation of Nernst (in standard conditions for partial pressure of hydrogen):

$$E = (RT \text{Ln } |H^+|) / nF = 0.0001983 T \log (H^+) \\ = 0.058 \log (H^+) \quad (\text{at } 20^\circ\text{C}), \quad (15.9)$$

where  $R$  is the gas constant,  $T$  is the absolute temperature,  $n$  is the ion charge and  $F$  is the Faraday (96,500°C).

The hydrogen electrode is not easy to use. Other reference electrodes of known potential compared to hydrogen electrode are used instead. The pH value is deduced from the electromotive force (EMF) measured between the reference electrode and a measurement electrode.



### **pH Meters**

Electronic equipment used for pH measurement can be classified in two groups (1) potentiometric systems and (2) systems with direct, analogical or numerical readings. The potentiometric method with measurements at null current is the most accurate but has the disadvantage of being time consuming and is consequently no longer used for routine tasks. Direct reading models are the most commonly used particularly numerical models. The choice of a pH meter will depend on the quality of measurement required:

- for routine tasks, the apparatus should have an input impedance of approximately  $10^{10} \Omega$  to allow measurement at a precision of 0.1 pH unit, manual correction of temperature, a potentiometer for scale fitting and a potentiometer for slope fitting.
- for more precise work, the input impedance should be at least  $10^{12} \Omega$ , the resolution  $\pm 0.002$  pH corresponding to 0.1 mV, with auto-correction of scale, slope and temperature. Output in millivolts means the apparatus can be used with an impedance adapter and also be connected to a recorder or a computerized acquisition system.

For use with several specific types of electrodes, a model whose adjustments and calibrations are programmed by microprocessor is advisable (cf. Sect. 15.3 below).

### **Measurement Electrode**

The measurement electrode is sensitive to the  $H^+$  ions and for measurements to be valid it must be combined with a reference electrode.

*The glass electrode* is the most widespread pH electrode. Nernst appears to be the first to have explained its principle, but the idea of using a glass electrode originated with Haber and Klemsiewicz in 1909. If two solutions of different acidity are separated by a very thin glass membrane (a few microns thick), a difference in potential will be established between them that depends on the difference in  $H^+$  concentration.

In practical terms, the electrode consists of a bulb of blown glass at the end of a tube. Not all types of glass can be used for the manufacture of electrodes. A “soft” glass, rich in sodium (type Corning 015) is generally used. The electrode is then filled with an HCl solution or a buffer solution containing an Ag/AgCl electrode. Two values are used for the internal solution, one giving at pH 7 an EMF equal to zero compared to the calomel/saturated KCl reference electrode, the other giving for pH = 0 EMF = 0. The former system is the most commonly used.

The response time of a glass electrode to a change in pH is very short. It is insensitive to oxidizing or reducing media. The potential developed is stable at around 58 mV per unit of pH at 25°C, the scale of differences

in the potential measured extending to  $\pm 500$  mV. The range of internal resistance is very big (100–1,000 M $\Omega$ ) requiring a measuring apparatus with a very *high input resistance* i.e. at least  $10^{10}$   $\Omega$ .

There may be slight differences in response from one electrode to another. This shift is due to an asymmetry potential created by slight differences in manufacture. The glass electrode is especially sensitive to dehydration. It should be always stored in distilled water. Before using the electrode for the first time, it should be steeped in distilled water for 24 h.

Glass electrodes are often sold in a combined form including a measurement and a reference electrode. This model is not recommended for measurements on soil suspensions as the porous sintered glass of the reference contact easily becomes blocked in the presence of clayey minerals and this can result in a very unstable signal over time. However, combined electrodes have in the meantime been somewhat improved and are safer than models made of porous sintered glass (Hach-one type).<sup>1</sup>

Electrodes made of glass membrane on a plane surface have also been recommended for the measurement of soil pH, particularly in the case of low water contents (cf. Sect. 15.3, in situ measurements). With these electrodes, Breltembeck and Bremner (1984) found pH values that were stable, reproducible and correlated with other classical measurements on 15 soils with a water potential of from  $-15$  to  $-0.3$  bars.

Because it is robust and easy to use in mediums that are difficult to access, the antimony electrode has also been used for the measurement of the pH of soils, muds or slurries even though it is less precise than glass electrodes. A stick of antimony acquires a potential that varies linearly with pH in the range of pH 1–pH 10. Conkling and Blanchar (1988) presented data on soil pH measured with a glass electrode that correlated well with data from an antimony electrode, although some values were a little higher with the latter.

From the historical point of view the platinum/quinhydrone electrode should also be mentioned. It was initially used to simulate the hydrogen electrode, as quinhydrone dissociates in solution by producing nascent hydrogen. It was recommended at the Second International Congress of Soil Science in 1927 but has not been used in soil chemistry for many years now.

### **Reference Electrodes**

Reference electrodes comprise half the element of known electrical potential (which should be as stable as possible) required for comparison with the measurement electrode. The most often used and the best studied is the calomel electrode, but other models are available which may be

---

<sup>1</sup> Hach Europe SA, LP 51, Namur, Belgium.

suitable in certain cases, in particular the silver/silver chloride electrode, or the thallium amalgam electrode that enables measurements at temperatures up to 135°C.

### *Calomel Electrode*

The calomel electrode consists of a mercury base covered with a layer of calomel (mercurous chloride) in a potassium chloride solution. Its assembly is described in Appendix 1 at the end of this chapter. Though current pH meters take measurements at null current, in fact a low negative or positive electric flow does not affect the potential of the electrode. The potential depends on the KCl concentration of the filling solution. Three types of KCl concentrations are used: 0.1 mol L<sup>-1</sup>, 1 mol L<sup>-1</sup> and saturated. The 0.1 mol L<sup>-1</sup> solution is recommended for precise measurements; it is not very sensitive to temperature but difficult to preserve. Usually a saturated electrode is used which is easy to maintain, but its temperature coefficient is high (see Appendix 1). At 25°C its potential is +245.8 mV with respect to that of the hydrogen reference electrode. One potential problem involved in the use of a reference electrode is electrical contact between the KCl filling solution and the measured solution. A porous sintered glass tube with a leak-flow of around 0.2 mL h<sup>-1</sup> is generally used. For precise measurements, a device with ground joints can be used; the degree of leak equals the desired sealing defect. Gel electrolyte can also be used to solve the problem of contact without risk of diffusion, but it can only be stored for a limited time.

It is important to emphasize the problems that can arise from the use of porous junctions in the case of measurements on soil suspensions. Junctions are easily blocked which implies that measurements are not reproducible. They must always be cleaned well by brushing and aspiration. Most of the difficulties involved in measurements come from the reference electrode particularly in turbid mediums like soil extracts. Devices for contact with the potassium chloride solution rapidly become clogged and measurements are then incorrect. A solid reference electrode (TBI – Recomat SA) has been recommended. It is made of wooden rings that are well-impregnated with the potassium chloride saturated solution and behaves remarkably well in very polluting mediums like those found at water purification stations.

If the presence of chloride or potassium ions is undesirable for measurement, an intermediate bridge with a double junction should be used. In this case calibration should be performed with “TRIS” buffer solutions (cf. Appendix 3).

### *Silver/silver chloride electrode*

This electrode is more rarely used but its robustness may make it worth using. Its simplicity also makes it useful for miniaturized assemblies. It is most often used in combination with a glass electrode or with ion selective electrodes.

This electrode makes it possible to work at temperatures ranging from  $-30$  to  $+135^{\circ}\text{C}$ . At  $25^{\circ}\text{C}$ , when filled with saturated potassium chloride, its potential is  $+200$  mV compared to a standard hydrogen electrode (see appendix 1). Its potential is  $-45$  mV compared to the calomel electrode at  $25^{\circ}\text{C}$ . It is advisable to monitor the stability of this electrode, as measurement currents can cause the transformation of silver by micro-electrolysis; it can be improved by a thin coating of Teflon film.

## **15.2.4 Electrometric Checking and Calibration**

The pH meter has to be calibrated before measurements are made. The apparatus chosen must be able to correct slope and temperature. In most cases, a precision of  $\pm 0.1$  pH unit is sufficient as other causes of errors are greater (e.g. heterogeneity of the sample). For measurements on suspensions, it is preferable to choose a device with a separate reference electrode as the risk of errors caused by clogging of the porous junction is reduced and it is easier to access when problems occur.

The apparatus should be switched on some time before beginning the measurements (there is often a waiting position which maintains the circuits in equilibrium), and then the electrodes are immersed in the appropriate buffer. It is advisable to begin with buffer T4AC (cf. Appendix 3, at the end of this chapter), which is particularly stable with respect to temperature. Adjust the pH meter to the appropriate value, then move on to the second buffer, which should be very close to the values to be measured. The apparatus should then display the value for the new buffer (corrected for temperature, see Appendix 3). Compensate for any slight variation while correcting slope. If correction is not possible, the coupling of the electrodes may not be satisfactory, particularly due to the glass electrode which does not display a strictly linear response between the two pH values selected. If this is the case, choose a narrower range of pH: for example, instead of pH 4 and 9, choose 7 and 9 or 6 and 8. The closer the value of the standard buffer to the value to be measured, the better the measurement. Agitation is not advised during measurement. In the case of problems of linearity, carefully clean the porous junction of the electrode by brushing it with a hard brush. It can also be cleaned by suction using a filter pump.

Measurements of soil pH can be classified in four main types:

1. On aqueous suspensions of soils
2. On saturated pastes
3. On extracts of saturation
4. "In situ" measurements

### 15.2.5 Measurement on Aqueous Soil Suspensions

Specifications vary with the soil:solution ratio due to the diversity of soil materials. In France, the experimental AFNOR standard NF X-31-103 (1998) recommends a 1:2.5 soil:water ratio. The International standard NF ISO 10390 (1994) recommends a ratio of 1:5.

#### Procedure

**Fig. 15.2.** Recommended position of the electrodes

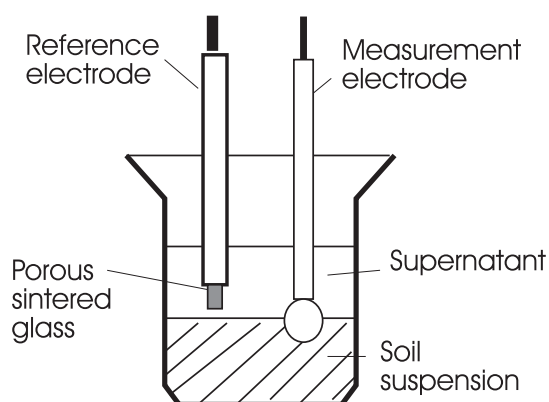

- Weigh 10 g of soil dried at room temperature and sieved to 2 mm (a test specimen of at least 5 mL being the ISO standard), add 25 mL (or five times the volume of the test specimen, ISO standard) of boiled distilled water ( $\text{CO}_2$  removed); shake for 1 h on an oscillating table (energetic agitation for 5 min, ISO standard).
- let decant for 30 min (at least 2 h but not more than 24 h, ISO standard), immerse the electrodes taking care that the porous part of the reference electrode is submerged in the clear part of the suspension (Fig. 15.2). Read the pH value after stabilization of the measurement. Note the temperature, and check correction for temperature on the pH meter.

#### Remarks

As the value of the pH drops with a rise in temperature, it is usual to bring back all the values to 25°C. For precise measurements, a thermostatic bath should be used; as soil suspensions often have a buffering effect that it is impossible to correct by calculation.

Measurements should be made without agitation. For certain soils, the indications provided by the pH meter may not be stable, giving a permanent drift. In such cases, it is advisable to read the pH after a specific time interval, for example, 3 min, and to use the same time interval for the other measurements, not forgetting to mention the fact when noting the results.

Measurements on soil suspensions and more importantly on saturated pastes induce a phenomenon called “paste effect” or “suspension effect” which can modify the results by  $\pm 1$  pH unit (Fig. 15.3). This effect is especially significant when the electrodes – and particularly the reference electrode – are in contact with the sediment. This effect could be due to the difference in mobility of the  $K^+$  and  $Cl^-$  ions of the diffusion solution of the reference electrode when colloids (charged particles, strong cation exchange capacity) are present. Grewling and Peech (1960) reported that this phenomenon could be minimized by taking measurements with a 0.01 molar solution of  $CaCl_2$  ( $pH_{Ca}$ ).

Although the soil:solution ratio influences the results of measurement of pH in water, it has very little effect in saline solutions such as  $CaCl_2$  0.01 mol  $L^{-1}$  (Conyers and Davey 1988). Nilsson et al. (1995) recommended water: soil ratios higher than 10 (v:w or 2 in v:v) to obtain reliable measurements of  $pH_{water}$  on organic soils.

The time of contact between water and soil also influences the pH. According to Conyers and Davey (1988) agitation times of more than a few hours are not advisable because they generate variations and make it impossible to obtain a stable value. Qiu and Zhu (1986) reported stabilization of their measurements after 30 min (and up to 1 h) of agitation.

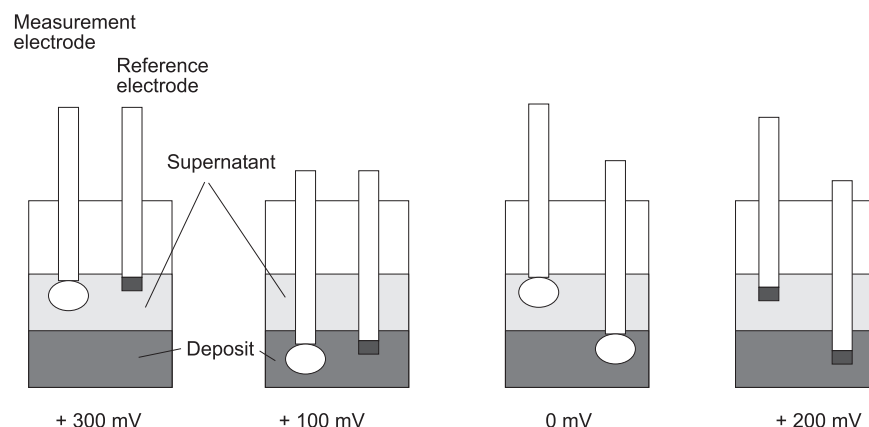

**Fig. 15.3.** Possible errors due to the effect of suspension for a soil in distilled water (Bates 1973)

### 15.2.6 Determination of the pH-K and pH-Ca

When measured in water, the pH value does not take total acidity into account, particularly the protons and the aluminium forms fixed on the exchange complex which represent potential acidity. In addition to the first measurement in water, it is consequently necessary to carry out a measurement in 1 mol (KCl) L<sup>-1</sup> aqueous solution with the same soil: solution ratio (1:2.5 for the procedure described in “Procedure” under Sect. 15.2.5) and using the same technique. This gives pH<sub>K</sub>.

pH<sub>K</sub> measurements usually give lower pH values<sup>2</sup> than pH<sub>H<sub>2</sub>O</sub> measurements. The difference (ΔpH) can be as much as one pH unit. A value of ΔpH > 0 indicates that the cation exchange capacity is higher than the anion exchange capacity. There is a significant correlation between a positive ΔpH and exchange acidity. However, although this is true in the case of one family of soils, it is not true of a general comparison.

This measurement was the subject of an experimental AFNOR standard NF-X31-104 (1988) and became part of the international NF ISO 10390 standard (1994).

Measurements in 0.01 mol (CaCl<sub>2</sub>) L<sup>-1</sup> aqueous solution are also used because Ca ions cause flocculation of the solution and minimize the paste and dilution effect. pH expression is thus less random and comparison is easier between different soils and particularly saline soils. pH<sub>Ca</sub> measurements induce lower ΔpH than pH<sub>K</sub> measurement. The study of Conyers and Davey (1988) showed that pH<sub>water</sub>, pH<sub>K</sub>, and pH<sub>Ca</sub> are closely correlated on soils with a broad range of pH. For non-saline soils with a negative net charge, they found the relation:

$$\text{pH}_{\text{Ca}} = 1.05 \text{pH}_{\text{eau}} - 0.9$$

The procedure described in “Procedure” under Sect. 15.2.5 is valid in all cases, whether in water or saline solution.

### 15.2.7 Measurement on “Saturated Pastes”

pH measurement on saturated paste aims to reproduce the conditions of the natural environment as closely as possible. This technique is very delicate to implement. It is necessary to start by preparing a “saturated paste”:

---

<sup>2</sup> In some Andosols rich in allophane, pH<sub>KCl</sub> can be higher than pH<sub>H<sub>2</sub>O</sub> (amphoteric medium).

- Weigh 200 g of air-dried soil sieved to 2 mm, put it in a cylindrical container of approximately 500 mL with a wide neck and a tightly fitting lid.
- Add 50–70 mL of boiled distilled water depending on the texture of the soil, i.e. whether it is more or less clayey; enough water should be added to just moisten the soil.
- Note the volume of water added in mL.
- cover and let stand for 30 min.
- Using a laboratory burette, while stirring add distilled water in small fractions to obtain a homogeneous paste. The main problem is to know when to stop adding water, i.e. when the paste is water saturated. Note the total volume of water added, cover and let stand for 30 min.

At saturation the paste should be glossy and sufficiently fluid to slip off the spatula. If a hole is made in the middle of the paste, water should not collect at the bottom of the hole unless there is excess water. If water does appear, a little more soil should be added and the total weight of the soil taken into account in the final calculation. In spite of the subjective judgement, in practice replicates on the same sample produce very similar results. For the least clayey soils, only a very small quantity of water should be added. The soil paste is characterized by its percentage of saturation:

$$\text{Saturation\%} = \text{weight of added water} \times 100 / \text{soil weight.}$$

The electrode should be inserted with extreme care. The reference electrode can have a double junction to avoid obstruction of the porous junction. It is preferable to use an electrode filled with saturated KCl or a gel solution with agar-agar to reduce the diffusion of liquid. As far as the measurement electrode is concerned, some models are designed for penetration and are less fragile than models with a bulb, though also less sensitive.

The pH meter should be read after stabilization of the measurement, which can take a few minutes. More than for the other techniques, these measurements are influenced by a phenomenon called paste effect which can modify real measurements of pH by 1 unit. The measurements obtained will be higher than for 1:2.5 soil:water suspension (cf. "Procedure under Sect. 15.2.5), but comparable with those on the saturation extract described below.

### 15.2.8 Measurement on the Saturation Extract

Faced with the difficulty of rendering an aqueous extract as representative as possible of the real in situ soil solution at water holding capacity of the soil, Richards (1954) proposed the saturation extract as an intermediate method between field and laboratory measurement.



To characterize the degree of salinization of a soil, the most common procedure uses a saturation extract on which the pH can be measured, respecting the precautions and techniques described in Sect. 15.2.5.

First make a saturated paste (cf. Sect. 15.2.7). Store it for 24 h, while protecting it from desiccation. Then transfer it on a filter paper on a Büchner funnel under vacuum. Collect the filtrate during filtration which can take quite a long time, sometimes more than 2 h. If the extract is still turbid, filter it again. Measure the pH. If the measurement cannot be made immediately after extraction, store the solution in a well-stopped bottle in the refrigerator. The solution can also be used for other measurements such as conductivity and titration of cations and anions (cf. Chap. 18).

### 15.2.9 Measurement of the pH-NaF

#### *Principle*

This measurement complements the in situ NaF test on a filter (Pansu et al. 2001). It is used to identify the presence of substances with short-range organization in the soils, particularly aluminium in active  $\text{Al}(\text{OH})_3$  form. The principle of this measurement is a consequence of the reaction:

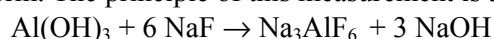

The release of  $\text{OH}^-$  ions causes an increase in the pH which indicates quite large quantities of substances with short-range organization. The disadvantage of this technique is that the presence of fluoride soon damages the glass electrode, so it is advisable to reserve one electrode for this particular use.

#### *Procedure*

- Prepare 1 L of a sodium-fluoride-saturated solution by weighing 45 g of NaF. Mix well in a polyethylene bottle and complete to 1,000 mL with distilled water. Let stand for 2 days shaking the bottle from time to time. If partial crystallization of NaF occurs, only use the clear part of the supernatant.
- Weigh 1 g of fine soil sieved to 2 mm, air-dried or preferably with its initial moisture content. Measure the moisture content on another test specimen in order to later bring back calculations to values for soil dried at 110°C. Put the sample in a 100 mL polyethylene beaker. Add 50 mL NaF solution, agitate and introduce the electrodes. Note the initial value at time  $t = 0$  then at  $t = 2$  min, 10 min and finally 30 min. Note the results on a graph  $\text{pH} = f(t)$ .

### 15.3 In situ Measurements

Field measurements in natural conditions provide the most accurate information for the study of soil processes. This is particularly true for pH measurements considering how many physicochemical reactions can affect the pH.

In addition to the measurement of pH, other electrochemical sensors (Pansu et al. 2001) are used to measure conductance, redox potential and ionometry using electrodes that are sensitive to ions other than  $H^+$ , like  $Na^+$ ,  $K^+$ ,  $Ca^{2+}$  and  $NH_4^+$  ions (cf. Chaps. 16 and 18). Moreover, use of a measurement station means data time series can be acquired which characterize changes in processes over time these being more instructive than a one-off characterization at a given time. Electrometric measurements can also provide information about activities of the ionic forms which are more useful for thermodynamic calculations than concentrations alone (Le Brusq et al. 1987). This kind of data is invaluable for the study of transfer mechanisms in the soil.

#### 15.3.1 Equipment

The pH meter must have an input impedance of at least  $10^9 \Omega$  or better  $10^{11} \Omega$ , and the ability to correct origin, slope and temperature. Correction must be automatic if measurements have to be made over a long period of time. It must be possible to regularly check calibration by programming these operations on a microprocessor, which also ensures good reproducibility.

Sensitivity of 0.1 pH unit is sufficient given the heterogeneity of the medium. The apparatus should be able to function independently (battery). The output should be in mV, and preferably a magnetic system of data acquisition for later reprocessing.

The pH-meter should enable shield assembly with connections to a triaxial cable thereby eliminating disturbances caused by the length of the connecting cables to the sensors. A simpler solution consists in using electrodes with their own built-in amplifier. This enables problems to be avoided both due to the length of the cable (up to 200 m) and to moisture through faulty insulation. A model with separate measurement electrodes and reference electrodes is preferable (Fig. 15.4). To monitor several electrodes, the switching box should generally include five stations, with potentiometric adjustment possible for each station enabling correction of the slight differences between the points of origin of the electrodes.

### 15.3.2 Installation in the Field

#### *Manual Measurements*

After the site has been chosen, initial characterization of the soil has to be performed. Sampling should be carried out at the depth at which the electrodes will be placed. The minimum measurements required are moisture, conductivity, ionic balance and exchangeable cations. A meteorological station should be installed with at least a rain gauge and a temperature gauge. A temperature probe should be placed in the soil near the other electrodes. The measurement electrode should be inserted with great care in a hole previously dug with a soil core sampler. The hole around the electrode should be filled with some of the soil that was removed. Care should be taken to ensure the quality of the contact with the bulb of the electrode. Flat glass membrane electrodes can also be used (Breltenbeck and Bremner 1984). The electric cord of approximately a metre with a coaxial plug at the end should end in a plastic box with a lid to protect the connection between measurement periods (Fig. 15.4). The junction for the reference electrode is made of a glass tube 3–4 mm in diameter and 30 cm in length, with a 50 mL tank with a lid at one end. The bottom section of the buried part is made of porous sintered glass (Fig. 15.4). Fill the tube to 3 or 4 cm above the porous section with a 3.5 mol (KCl) L<sup>-1</sup> aqueous solution gelled by 4% agar containing one thymol crystal to protect it against mould. Continue filling with the 3.5 mol (KCl) L<sup>-1</sup> solution until the tank is half full. The gel above the porous section prevents over-diffusion of the KCl solution. The junctions are placed at intervals of 10-50-100 cm from the measurement electrode (Fig. 15.4a); this makes it possible to detect electrode malfunction caused by insufficient soil water content (Kolsi and Susini 1984).

In the case of sufficient moisture (this varies with the soil, but is generally 10% or higher), measurements compared using reference 1–2–3 (Fig. 15.4) should give almost the same values. If measurements 1 and 2 diverge, insufficient moisture is probably the cause. If 3 is different, this is a warning signal and a sample should be taken to check the moisture content. If the differences between reference electrodes are big, these measurements should not be used. Generally, measurements are taken using reference 1 after an initial check of the other positions.

All the measuring equipment including a switching box with four entries connected to a pH meter with an autonomous power supply should be conveniently packed in a case to allow easy transport in the field.

The switching box should be regulated in a buffer for each electrode, in order to be able to bring all the shift potentials back to the same value (mark the values on the potentiometers).

### **Measurements**

Open the lids protecting the sensors and place a calomel-saturated KCl electrode in junction tube 1. Connect the measurement electrode and the reference electrode to the switching box. Read the pH value, place the mobile reference in junction tube 2 and read the new value. Proceed in the same way in junction tube 3, repeating the procedure if there are several measurement electrodes, using the switching box. For correction, the temperature gauge must of course be connected to the pH meter (Fig. 15.4b).

#### **15.3.3 Measurements on Soil Monoliths**

As they closely resemble in situ measurements, soil monoliths provide a wealth of useful information. Even if the measurements are not identical to those made in the field, they are easier to record and give data from controlled climatic conditions.

The monolith used by Susini and Loyer (1967) comprised a soil core enclosed in an PVC parallelepiped three sides of which were opaque, and the fourth transparent, with a square cross-sectional shape of 30 cm and a height of 1 m. The soil monolith was cut in the field with the same dimensions as the box except for a few centimetres left at the bottom for a gravel bed to allow drainage. The whole object was sealed with Rubson cement.  $3 \times 3$  holes were cut in the transparent side at three different levels for the pH, the reference, and when necessary, for a platinum electrode for the measurement of Eh (cf. Chap. 16). Three holes 40 mm in diameter were cut in the left side to enable sampling, and closed with rubber stoppers. On the other side, one hole was cut at each level to allow insertion of Bouyoucos moisture sensors. Only one reference electrode was used for all three levels with flexible tubes to transport the potassium chloride solution.

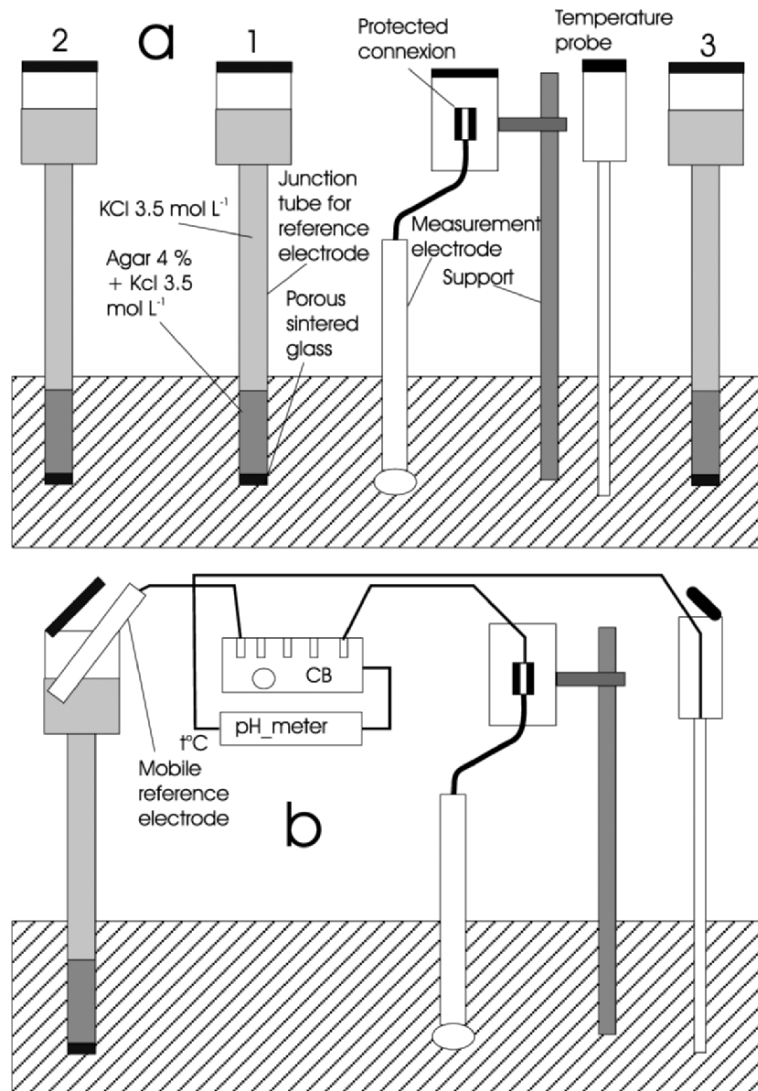

**Fig. 15.4.** (a) Diagram of installation of sensors with junction tubes 1, 2 and 3 for the electrode of reference;  
(b) = phase of acquisition (CB = connecting box for several electrodes)

## References

- Bates R (1973) *Détermination du pH*, Wiley, New York
- Breltenbeck CA and Bremner JM (1984) Use of a flat-surface combination pH electrode for measurement of soil pH. *Commun. Soil Sci. Plant Anal.*, 15, 87–98
- Conkling BL and Blanchar RW (1988) A comparison of pH measurements using the antimony microelectrode and glass electrode. *Agron. J.*, 80, 275–278
- Conyers MK and Davey BG (1988) Observation on some routine methods for soil pH determination. *Soil Sci.*, 145, 29–36
- Grewling, T and Peech (1960) Chemical soil tests. *Cornell Univ. Agric. Exp. Sta. Bull.*, 960 p
- INRA (1995) Référentiel pédologique. Association Française d'étude des sols, INRA, 332 p
- Kolsi and Susini J (1984) Publications ES 209 – Direction des Sols, ORSTOM, Tunis
- Le Brusq JY, Zante P and Peraudeau M (1987) La mesure *in situ* des paramètres physico-chimiques (pH et Eh) dans un sol sulfaté acide de Casamance (Sénégal). *Cah. Orstom Ser. Pédol.*, XXIII, 55–66
- NF ISO-10390 (1994) Détermination du pH. In *Qualité des sols*, AFNOR, 1996
- NF X31-103 (1988) Détermination du pH dans l'eau - Méthode électrométrique. In *Qualité des sols*, AFNOR, 1994
- NF X31-104 (1988) Détermination du pH dans une solution de KCl – Méthode électrométrique. In *Qualité des sols*, AFNOR, 1994
- Nilsson T, Kranz-Eliasson B and Bjurman M (1995) Measurement of pH in soil samples from a cutover peatland in Sweden: the effect of electrolyte and solution/soil ratio. *Commun. Soil Sci. Plant Anal.*, 26, 371–374
- Pansu M, Gautheyrou J and Loyer JY (2001) *Soil Analysis – Sampling, Instrumentation and Quality Control.*, Balkema, Lisse, Abington, Exton, Tokyo, 489 p
- Qiu Xing-Chu and Zhu Ying-Quan (1986) Spectrophotometric determinations of pH value, Buffer capacity and rate of lime need in acidic soil, using chrysoïdine as a chromogenic agent. *Soil Sci.*, 142, 275–278
- Richards LA (1954) Saline and alkali soil – United States Agriculture – Handbook no. 60: 84
- Susini J and Loyer JY (1967) *Utilisation d'un ensemble automatique pour la mesure en continu du pH.*, DRES-ORSTOM-Tunis

## Bibliography

- Beaumann EW (1973) Détermination du pH dans les solutions salines concentrées. *Anal. Chim. Acta.*, 64, 284–288
- Billmann E (1927) L'électrode à quinhydrone et ses applications. *Bull. Soc. Chem. Fr.*, 213, 41–42
- Bower (1961) Studies on the suspension effect with a sodium electrode. *Soil Sci. Amer. Proc.*, 25, 18–21
- Cheng KI (1989) pH glass electrode and its mechanisms. In *Am. Chem. Soc. Symp. Ser.*, Stock JT and Orna MV ed., 390, 286–302
- Clark JS (1964) An examination of the pH of calcareous soils. *Soil Sci.*, 9, 145–151
- Clark J.S (1996) The pH values of soils suspended in dilute salt solutions. *Soil. Sci. Soc. Am. Proc.*, 30, 11–14
- Colin C, Collings K, Drummond P, and Lund E. (2004) *A Mobile Sensor Platform for Measurement of Soil pH and Buffering.*, American Society of Agricultural and Biological Engineers, St. Joseph, Michigan, USA
- Peech M, Olsen RA and Bolt GH (1953) The significance of potentiometric measurements involving liquid junction in clay and soil suspensions. *Soil Sci. Soc. Proc.*, 214–218
- Perley, GA (1939) Sur l'électrode antimoine. *Ind. Eng. Chem. Anal.*, 11, 316–319
- Peeverill KI, Sparrow LA and Reuter DJ (2001) *Soil Analysis – An interpretation manual*, CSIRO Publishing, Australia
- Raupach (1954) The error involved in pH determinations in soils. *J. Agric. Res.*, 5, 716–729
- Schofield RK and Taylor AN (1955) The measurement of soil pH. *Soil Sci. Soc. Am. Proc.*, 19, 164–167
- Sisterson DL and Wurfelt BE (1984) Methods for reliable pH measurements of precipitation samples. *Inter. J. Environ. Anal. Chem.*, 18, 143–160
- Soil and Plant Analysis Council Inc (1999) *Soil Analysis – Handbook of reference methods*, CRC, Boca Raton
- Stevens G, Dunn D and Phipps B (2001) How to diagnose soil acidity and alkalinity problems in crops: A comparison of soil pH test kits. *J. Extension*, 39, 4
- Thomas GW (1996) Soil pH and soil acidity. In *Methods of Soil Analysis*, Part 3, Chemical Methods, Bigham JM and Bartels JM ed., ASA-SSSA, Madison, Etats-Unis, 475–490
- Thunjai T., Boyd C.E., Dube K (2001) Pond soil pH measurement. *J. World Aquacult. Soc.*, 32, 141–152
- Yang SX, Cheng KL, Kurtz LT and Peck TR (1989) Suspension effects in potentiometry. *Part. Sci. Technol.*, 7, 131–152

## Appendices

- 15.1. Table of electrode potentials
- 15.2. Constants of dissociation of certain equilibriums
- 15.3. Buffer solutions
- 15.4. Indicators

### Appendix 15.1: Table of Electrode Potentials

**Table 15.4.** Potential of three types of calomel electrode from 15 to 30°C in mV compared to the hydrogen electrode

temperature (°C)	electrode solution		
	KCl 0.1 mol L <sup>-1</sup>	KCl 1 mol L <sup>-1</sup>	saturated KCl
15	338.1	285.2	252.5
16	337.9	284.9	251.7
17	337.8	284.5	250.9
18	337.7	284.2	250.3
19	337.6	283.8	249.5
20	337.5	283.5	248.8
21	337.4	283.2	248.2
22	337.3	282.9	247.5
23	337.2	282.6	246.8
24	337.0	282.2	246.3
25	336.9	281.9	245.8
26	336.8	281.6	245.3
27	336.7	281.2	244.8
28	336.6	281.9	244.3
29	336.5	280.5	243.8
30	336.4	280.2	243.4

**Table 15.5.** Potential of silver/silver chloride electrode from 0 to 95°C in millivolts compared to the hydrogen electrode

<i>T</i> (°C)	mV	<i>t</i> (°C)	mV
0	236.5	40	212.0
5	234.1	45	208.3
10	231.4	50	204.4
15	228.5	55	200.5
20	225.5	60	196.4
25	222.3	70	187.8
30	219.0	80	178.7
35	215.6	90	169.5
		95	165.1



**Appendix 2: Constants of Dissociation of Certain Equilibriums**

compound		formula	$K$ at 18°C in water	$pK$ at 18°C
acetic acid		$\text{CH}_3\text{COOH}$	$1.8 \times 10^{-5}$	4.75
ammonium		$\text{NH}_4^+$	$3.2 \times 10^{-10}$	9.5
boric acid		$\text{H}_3\text{BO}_3$	$5.25 \times 10^{-10}$	9.26
orthophosphoric acid	1	$\text{H}_3\text{PO}_4$	$7.6 \times 10^{-3}$	2.12
orthophosphoric acid	2	$\text{H}_2\text{PO}_4^-$	$7.5 \times 10^{-8}$	7.12
orthophosphoric acid	3	$\text{HPO}_4^{2-}$	$3.5 \times 10^{-13}$	12.45
citric acid	1	$\text{CH}_2\text{C}(\text{OH})-(\text{CO}_2\text{H})_3$	$8.4 \times 10^{-4}$	3.08
citric acid	2	$\text{CH}_2-\text{C}(\text{OH})-(\text{CO}_2\text{H})_2\text{CO}_2^-$	$1.77 \times 10^{-5}$	4.75
citric acid	3	$\text{CH}_2-\text{C}(\text{OH})-\text{CO}_2\text{H}(\text{CO}_2)_2^{2-}$	$3.9 \times 10^{-6}$	5.41
acid sulphate ion		$\text{HSO}_4^-$	$1.27 \times 10^{-3}$	2.89

**Appendix 3: Buffer Solutions**

A buffer solution is a chemical system which tends to maintain the concentration in  $\text{H}^+$  ions constant and consequently also the pH in spite of dilution or the addition of limited quantities of certain acids or bases. Generally the buffer solutions are mixtures of an acid and one of its ionized salts. The buffer value  $\beta$  is defined starting from the equation  $\beta = \Delta b/\Delta\text{pH}$  or  $\Delta a/\Delta\text{pH}$  which expresses the pH variation induced by addition of an acid ( $\Delta a$ ) or a base ( $\Delta b$ ). The pH of a buffer solution (Table 15.6) is given by:

$$\text{pH buffer} = pK + \log (\text{salt C} / \text{acid C})$$

**Table 15.6.** pH values and characteristics of few commercial buffer solutions  
*I*, ionic strength;  $\Delta\text{pH}1/2$ , variation in pH when the buffer solution is diluted with an equal volume of distilled water;  $\beta$ , buffering power  $\Delta b/\Delta\text{pH}$ ,  $\Delta b$  increase in strong base or acid concentration of the buffer solution giving a pH change  $\Delta\text{pH}$

Ref. <i>T</i> (°C)	T1	T2	T3	T4	HPT	T4AC	T6	T7	T8	T9a	T9b	T10	T12
0	1.10	1.666		4.003			6.984	7.534		8.464	9.46	10.317	13.423
5	1.10	1.666		3.999			6.951	7.500		8.395	9.39	10.245	13.207
10	1.10	1.670		3.999	4.65		6.923	7.472	8.40	8.332	9.33	10.179	13.003
15	1.10	1.672		3.999			6.900	7.448	8.28	8.276	9.27	10.118	12.810
20	1.10	1.675	3.560	4.002	4.65		6.881	7.429	8.14	8.225	9.22	10.082	12.627
25	1.10	1.679	3.557	4.008	4.65		6.865	7.413	8.00	8.180	9.18	10.012	12.454
30	1.10	1.683	3.552	4.015			6.853	7.400	7.87	8.139	9.14	9.966	12.289
35	1.10	1.688	3.549	4.024			6.844	7.839	7.75	8.102	9.10	9.325	12.133
40	1.10	1.694	3.547	4.035	4.65		6.838	7.380	7.62	8.058	9.07	9.889	11.984
45	1.10	1.700	3.547	4.047			6.834	7.373	7.50	8.038	9.04	9.856	11.841
50	1.10	1.707	3.549	4.060			6.833	7.367	7.38	8.011	9.01	9.828	11.705
55	1.11	1.715	3.554	4.075			6.834			8.985	8.98		11.574
60	1.11	1.723	3.560	4.091			6.836			8.962	8.95		11.449
70	1.11	1.743	3.580	4.126			6.845			8.921	8.92		
80	1.11	1.766	3.609	4.164			6.859			8.885	8.89		
90	1.12	1.792	3.650	4.205			6.877			8.850	8.87		
95	1.12	1.806	3.674	4.227			6.886			8.833	8.87		
<i>I</i>							0.1	0.1	0.1	0.03			
$\Delta\text{pH}1/2$	+0.2	+0.186	+0.04	0.052	+0.01	+0.08	+0.07	-0.02	+0.01	-0.0	+0.079	-0.26	
	2	8	9	6						1			
$\beta$	0.12	0.07	0.027	0.016	0.1	0.029	0.016	0.029	0.02	0.05	0.029	0.09	

*T1* = HCl 0.1 mol L<sup>-1</sup>,  
*T2* = potassium tetraoxalate KH<sub>3</sub>C<sub>4</sub>O<sub>8</sub> 0.05 mol L<sup>-1</sup>,  
*T3* = saturated potassium hydrogentartrate KH<sub>3</sub>C<sub>4</sub>O<sub>8</sub>,  
*T4HP* = potassium hydrogenphthalate 0.05 mol (KH<sub>3</sub>C<sub>4</sub>O<sub>8</sub>) L<sup>-1</sup>,  
*T4AC* = 0.1 mol (CH<sub>3</sub>COOH) L<sup>-1</sup> + 0.1 mol (CH<sub>3</sub>COONa) L<sup>-1</sup> (particularly recommended for its pH stability with temperature),  
*T6* = 0.025 mol (KH<sub>2</sub>PO<sub>4</sub>) L<sup>-1</sup> + 0.025 mol (Na<sub>2</sub>HPO<sub>4</sub>) L<sup>-1</sup>,  
*T7* = 0.087 mol (KH<sub>2</sub>PO<sub>4</sub>) L<sup>-1</sup> + 0.0304 mol (Na<sub>2</sub>HPO<sub>4</sub>) L<sup>-1</sup>,  
*T8* = Tris(hydroxymethyl) aminomethane 0.05 mol L<sup>-1</sup> + 0.0292 mol (HCl) L<sup>-1</sup> (particularly recommended in biology and ionometry),  
*T9a* = 0.01 mol (Na<sub>2</sub>B<sub>4</sub>O<sub>7</sub>·10H<sub>2</sub>O) L<sup>-1</sup>,  
*T9b* = (0.05 mol Na<sub>2</sub>B<sub>4</sub>O<sub>7</sub>·10H<sub>2</sub>O) L<sup>-1</sup>,  
*T10* = 0.025 mol (NaHCO<sub>3</sub>) L<sup>-1</sup> + 0.025 mol (Na<sub>2</sub>CO<sub>3</sub>) L<sup>-1</sup>,  
*T12* = Ca(OH)<sub>2</sub> sat

**Appendix 4: Coloured Indicators**

composition of A and B solutions	A:B ratio v:v	colour		transition pH	remark
		acid form	basic form		
A: methyl orange (0.1% in water) B: indigo carmine (0.25% in water)	1:1	violet	green	4.1	very useful for titrating under artificial light
A: bromocresol blue (0.2% in alcohol) B: methyl red (0.2% in alcohol)	3:1	red	green	5.1	quick change of colour at transition point
A: neutral red (0.1% in water) B: methylene blue (0.1% in water)	1:1	blue- violet	green	7.0	store in dark flask
A: phenolphthalein (0.1% in 50% alcohol) B: naphtholphtaleine (0.1% in 50% alcohol)	3:1	light pink	violet	8.9	light green at pH 8.6
A: thymol blue (0.1% in 30% alcohol) B: phenolphtaleine (0.1% in 50% alcohol)	1:3	yellow	violet	9.0	green at pH 9.0

## Redox Potential

### 16.1 Definitions and Principle

The measurements described in this chapter enable characterization of variables especially linked with the diffusion of air in the soil:

Eh = oxydoreduction potential

ODR = oxygen diffusion rate.

First a reminder of certain definitions: oxidation is characterized by a loss of electrons, reduction is characterized by a gain of electrons. Thus, in a redox reaction, the oxidant is reduced and the reducing agent oxidized with an exchange of  $n$  electrons ( $e^-$ ):

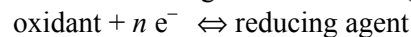

Measurement of the redox potential Eh allows quantitative appraisal of the force and tendency of the system. It can be measured by the difference between the potential of the hydrogen electrode (or more easily, of the calomel electrode) and the potential of a platinum electrode immersed in the medium (Fig. 16.1). It is expressed by:

$$Eh = E_0 + \frac{0.058}{n} \log \frac{[\text{Ox}]^a}{[\text{Red}]^b}.$$

[Ox] and [Red] are the activities of, respectively, the oxidative and reducing agents.  $a$  and  $b$  are the numbers of respective equivalents in the reaction and  $n$  the number of electrons exchanged.  $E_0$  is the standard potential that characterizes the redox couple and is a characteristic of this couple (for example, for  $\text{Fe}^{3+} + e^- \Leftrightarrow \text{Fe}^{2+}$ ,  $E_0 = 770$  mV).

In soils, Eh varies between 900 and  $-300$  mV. The potential can change under the influence of pH or in the presence of complexing ions. The apparently normal potential must thus be defined. It is useful to

monitor variations in Eh with pH ( $E_0 = f(\text{pH})$ ). It should be noted that when Eh decreases by approximately 100 mV, pH increases by one unit.

Other factors like moisture, and organic or inorganic matter also have an effect so it is only possible to define a qualitative value representative of a soil state. For this reason, it is often more instructive to consider *variations in Eh* that indicate the direction of an evolving process. Table 16.1 summarizes the main biochemical processes for different water-logged soils in temperate zones.

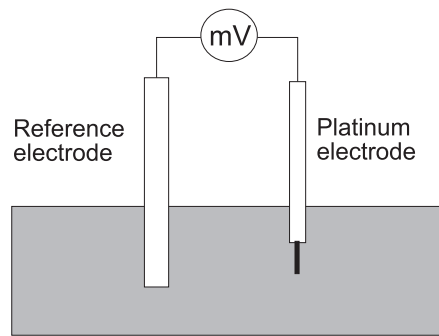

**Fig. 16.1.** Measurement of Eh potential

**Table 16.1.** Some of the main biogeochemical processes at different Eh values

phase	process	Eh in mV	microbial metabolism	soluble organic matter
phase I	disappearance of O <sub>2</sub>	600 to 300	aerobiosis	biological breakdown
	disappearance of NO <sub>3</sub> <sup>-</sup>	500 to 300		
phase II	Mn <sup>4+</sup> reduction	400 to 200	facultative anaerobiosis	temporary accumulation
	Fe <sup>3+</sup> reduction	300 to 100		
phase III	SO <sub>4</sub> <sup>2-</sup> reduction	0 to -150	strict anaerobiosis	strong accumulation biological breakdown by anaerobiosis
	H <sub>2</sub> and CH <sub>4</sub> production	-150 to -220		

In addition to redox potential, it is useful to measure the oxygen diffusion rate (ODR). This represents the potential oxygen supply and combines diffusion in the gas phase, and dissolution and transfer in the liquid phase. Plant growth depends on oxygen in this dissolved form. Growth is satisfactory at an ODR value of more than 20 and is optimum

towards 40. The ODR can decrease to 5 in waterlogged soil, and to 0 in reducing groundwater.

The notation  $rH = -\log p_{H_2}$  is also used ( $p_{H_2}$  being pressure of molecular hydrogen). This value, which is less often quoted than Eh, links measurements of Eh with those of pH:

$$rH = \frac{Eh + 0.06 \text{ pH}}{0.03}$$

On the rH scale, oxydoreduction is neutral at value  $rH = 27.7$  at  $20^\circ\text{C}$  and pH 7. Lower values correspond to reducing solutions. Higher values (from 27 to 40) correspond to oxidizing solutions.

## 16.2 Equipment and Reagents

### 16.2.1 Electrodes

**Fig. 16.2.** Platinum electrode. (1) platinum wire in the shape of a corkscrew; (2) resin, e.g. araldite; (3) connection immersed in mercury ensuring the contact; (4) glass or PVC tube; (5) electric wire

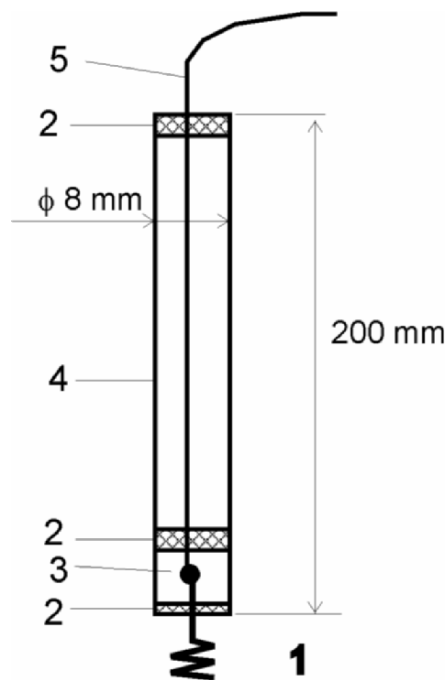

The platinum electrode is made of a 1 mm diameter platinum wire the bottom 2 cm of which is, shaped like a corkscrew. This shape means it can be screwed into the soil thereby ensuring good contact (Fig. 16.2).

The body of the electrode comprises a glass or PVC tube 8 mm in diameter and 20 cm in length.

The reference electrode should be of the calomel-saturated KCl type (cf. Chap. 15).

### 16.2.2 Salt Bridge for Connection

**Fig. 16.3.** Salt bridge for connection (1) stoppers; (2) PVC electrode holder; (3) resin connection made of Araldite; (4) conducting gel; (5) PVC tube 15 mm in diameter and of varying length; (6) filter paper window

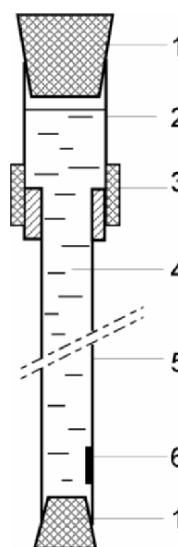

The salt bridge is made of an opaque PVC tube 15 mm in diameter whose length depends on the depth chosen. It provides permanent contact with the soil. A window (Fig. 16.3) of a few mm near the bottom of the tube ensures the electric connection with the soil. It is sealed with a piece of filter paper. The top end sticks out of the soil and is slightly bigger to hold the reference electrode during measurement. This assembly is filled with a heated (to fluidify) mixture of 350 g (KCl) + 3% gelose L<sup>-1</sup> and few grains of phenol for conservation, then stopped until the gel solidifies. The salt bridge described here resembles that proposed by Veneman and Pickering (1983).

### 16.2.3 System of Measurement

Either a pH meter (cf. Chap. 15) with a mV scale with the zero value at the centre (enabling negative measurements) or more simply, a millivoltmeter can be used. But one characteristic is crucial: the input resistance must be high in order to maintain a very weak measurement current to avoid the phenomenon of polarization of the platinum electrode

which can result in erroneous measurements. An impedance adapter mounted on an operational amplifier in potential mode can be also linked to the controller input.

### 16.2.4 Calibration Solutions

- Zobell's solution, mix:
 

potassium ferrocyanide	1.26 g,
potassium ferricyanide	0.99 g,
potassium chloride	7.50 g;

 dissolve and bring to 1,000 mL;  
 At a temperature of 25°C, the Eh of this solution =  $429 \pm 2.4$  mV compared to the hydrogen electrode
- Solution of Light (1972), mix:
 

ammonium ferrous sulphate (6H <sub>2</sub> O)	39.21 g,
ammonium ferric sulphate (12H <sub>2</sub> O)	48.22 g,
sulphuric acid ( $d = 1.84$ )	56 mL;

 bring to 1,000 mL;  
 At 25°C, the Eh of this solution is 675 mV compared to the hydrogen electrode.

For measurements taken with a reference electrode other than the hydrogen electrode, the following relation is used:

$$Eh(H_2) = \text{measured EM} + E_r \text{ of the reference,}$$

with  $E_r$  values at 25°C:

calomel/saturated KCl reference	244.4 mV
mercury/mercury sulphate reference	636.0 mV
Ag/AgCl reference	198.7 mV

## 16.3 Procedure

### 16.3.1 Pretreatment of the Electrode

Before being used for measurements, the surface of the platinum electrode has to be treated to erase all traces of previous memory:

- Soak in perhydrol for 15 min.
- Rinse in distilled water.
- Soak in pure nitric acid ( $d = 1.37$ ) for 15 min.
- Rinse in pure hydrochloric acid ( $d = 1.19$ ) 15 min.
- Wash under running water for 2 h



### 16.3.2 Measurement on Soil Sample

This type of measurement is used relatively rarely. The information it provides is influenced by the concentration of reduced or oxidized substances, but does not give the degree of soil aeration, which depends on moisture and porosity. However, if care is taken, measurements can be made on saturated paste. The pastes are prepared using the same technique as for the extraction of soluble salts (cf. Sect. 16.2.2), with certain precautions: the distilled water must be completely degassed by vacuum boiling; the assembly, (Fig. 16.4) should allow measurements to be made in a vacuum. The measurement should only be recorded if the difference between two readings does not exceed 2 mV.

**Fig. 16.4.** Device for measurement of Eh on soil suspension or saturated paste

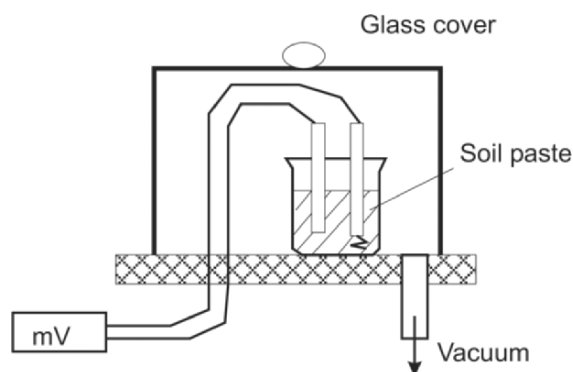

Liu and Yu (1984) proposed an improvement of this measurement by preliminary polarization of the platinum electrode followed by plotting depolarization curves as a function of time. The intersection of the two curves obtained after anodic and cathodic polarization provides a value of Eh.

### 16.3.3 Measurement on Soil Monolith

Measurement in controlled laboratory conditions provides an alternative to in situ measurement. A soil column is placed in a opaque PVC tube with a diameter ranging from 30 to 40 cm for a length of 1 m (0.12–0.15 m<sup>3</sup>). The salt bridge is identical to that described in Sect. 16.2.2, with a window for electrical contact at the level of each platinum electrode located at a different height.

When sampling soil in the field requires extreme care should be taken to exactly reproduce the field soil profile in the monolith. Access

windows for measurements should have stoppers and enable small samples to be taken when necessary, to monitor soil moisture for example.

### 16.3.4 In situ Measurements

This type of measurement provides the most relevant data. Once the site is chosen, start by drilling a hole with approximately the same diameter as the electrode (8 mm) using an auger so as to disturb the structure of the walls as little as possible. Insert the electrode and screw the platinum wire into the soil. This ensures good electrical contact between the soil and the platinum.

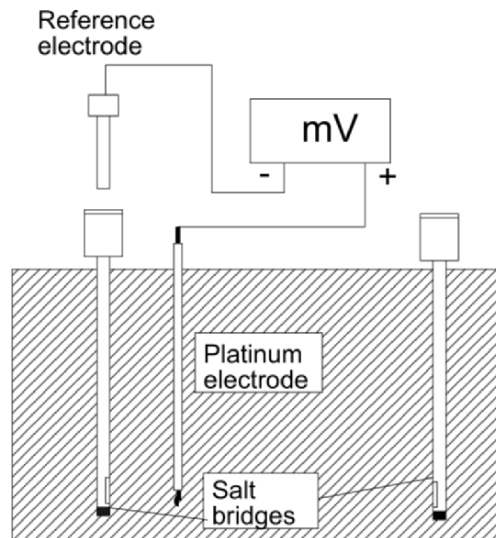
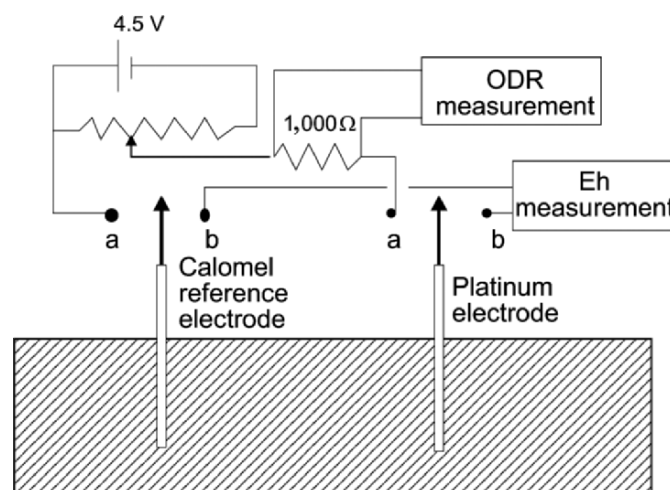

Fig. 16.5. In situ Measurement

Firm the soil around the electrode to avoid infiltration as the electrode remains in place between measurements and the electrical contacts need to be protected. Place the salt bridge approximately 6 cm from the electrode (Fig. 16.5). The opening at the top should be stopped between measurements. It is advisable to place a second bridge 20 cm from the first which can be used to check the measurements are correct. To do this, a measurement should be taken immediately after connecting the first bridge. The two values will be identical if soil conditions have not changed (in particular moisture). Bad measurements are often due to faulty electrical contacts. It is thus preferable to maintain permanent contacts using a box with multiple connections controlled by a rotary switch.

### 16.3.5 Measurement of the Oxygen Diffusion Rate

This measurement is based on the principle of polarographic measurement. In oxygenated medium, when the potential of the polarizable electrode reaches  $-200$  mV, oxygen reduction begins and an electrical current is set up. Oxygen reduction increases with the potential. In the zone where the current intensity is independent of the voltage, the concentration of dissolved oxygen and its rate of diffusion towards the cathode are the only limiting factors. This technique was proposed by Lemon and Erickson (1955) to measure the diffusion of oxygen towards plant roots. The root resembles a cylinder surrounded by a mostly liquid contact zone which varies with the degree of saturation of the medium. Atmospheric oxygen dissolves and diffuses from the liquid phase towards the root. The device for Eh and ODR measurement should be assembled as shown in Fig. 16.6.



**Fig. 16.6.** Combined measurement device (a) oxygen diffusion rate (ODR) and (b) Eh (after Vilain and Ruelle 1974)

A salt bridge (Fig. 16.3) is inserted in the soil to a depth of approximately 15 cm to connect the calomel-saturated KCl reference electrode. The measurement electrode (platinum wire 1 mm in diameter and 6.5 mm in length, cf. Sect. 16.2.1) is checked using the calibration solutions (cf. Sect. 16.2.4) and then positioned at the same depth (15 cm).

Measurement of Eh precedes measurement of ODR. The measurement of ODR requires polarization of the platinum electrode using the recommended potential of  $-650$  mV compared to the reference. Read the equilibrium current 3 min after switching on the polarization circuit.

Integration of the equation of diffusion shows that the ODR is roughly proportional to the equilibrium current according to the expression:

$$\text{ODR} = (0.5 / A) I.$$

ODR: oxygen diffusion rate ( $10^{-8} \text{ g cm}^{-2} \text{ min}^{-1}$ ),

*A*: surface of the platinum electrode ( $\text{cm}^2$ ),

*I*: current intensity ( $\mu\text{A}$ ).

Though the influence of temperature is negligible in the measurement of Eh, the same is not true for the measurement of ODR. Vilain and Ruelle Druelle (1974) recommended an average corrective factor of 2% per°C. The repeatability of measurements may be about 10% after 2–3 months of installation in the field.

### 16.3.6 Colorimetric Test of Eh

**Table 16.2.** Coloured indicators of oxyreduction, colourless in reducing medium, values at pH 7 and 20°C (according to Voiret and Froquet 1950)

Coloured indicator	Eh mV	rH
neutral red	– 340	10
safranine T	– 290	
indigo potassium disulphonate	– 125	
methylene blue	+ 11	23
quinhydrone	+ 50	24.4
pure water	+ 145	27.7
indophenol	+ 248	31.2
potassium ferricyanide	+ 430	37.5

Redox potential can be determined using coloured indicators.

The method consists in observing the transition from the coloured to the colourless form which occurs at the Eh value characteristic of the reagent concerned (Table 16.2). This technique entails many difficulties in soil analysis, but is nevertheless useful as a preliminary test.

### References

- Lemon ER and Erickson AE (1955) Principle of the platinum micro electrode as a method of characterizing soil aeration. *Soil Sci.*, 79, 383–392

- Liu ZG and Yu TR (1984) Depolarisation of platinum electrode in soil its utilisation for the measurement of redox potential. *J. Soil Sci.*, 35, 469–479
- Veneman PLM and Pickering W (1983) Salt bridge for field redox potential measurements. *Commun. Soil Sci. Plant Anal.*, 14, 669–677
- Vilain M and Ruelle JP (1974) Appréciation d'un état d'aération par l'utilisation de techniques électrochimiques, principes et observations. *Ann. Agron.*, 25, 1–23
- Voiret EG and Froquet L (1950) Le rH : la pratique de sa mesure. *Applications. Chimie et industrie*, 64, 439

## Bibliography

- Bohn HL (1968) Electromotive force of inert electrodes in soil suspensions. *Soil Science Society American Proceedings*, 32, 211–215
- Eshel G and Banin A (2002) Feasibility study of long-term continuous field measurement of soil redox potential. *Communications in Soil Science and Plant Analysis*, 33, 695–709
- Fisterer UP and Gribbohm S (1989) Constructing platinum electrodes for redox measuring. *Zeitschrift für Pflanzenernährung und Bodenkund*, 152, 455–456
- Gao S, Tanji KK, Scardaci SC and Chow AT (2002) Comparison of redox indicators in a paddy soil during rice-growing season. *Soil Science Society of America Journal*, 66, 805–817
- Grundl TJ and Macalady DL (1989) Electrode measurement of redox potential in anaerobic ferric/ferrous chloride systems. *Journal of Contaminant Hydrology*, 5, 97–117
- Holm TR and Curtiss CD (1989) A comparison of oxidation–reduction potentials calculated from the As(V)/As(III) and Fe(III)/Fe(II) couples with measured platinum-electrode potentials in groundwater. *Journal of Contaminant Hydrology*, 5, 67–81
- Hunter JD, Scoggins DK, Hawk RM and Sims RA (1986) Development of a microcomputer controlled multi-probe instrument for automated time-dependent measurement of redox potential and oxygen diffusion rate. *Analytical Instrumentation*, 15, 51–62
- ISO 11271 (2002) A field method for the determination of soil redox potential (Eh). International Organization for Standardization
- Komada M (1990) Redox potential measurements in a flooded paddy field using a compact computer system. In *Transactions 14th International Congress of Soil Science*, Kyoto, Japan, 44–49
- Kukec A, Berovic M, Celan S and Wondra M (2002) The role of on-line redox potential measurement in Sauvignon blanc fermentation. *Food Technology and Biotechnology*, 40, 49–55

- Le Brusq JY, Zante P and Péraudeau M (1987) La mesure in situ de paramètres physico-chimiques (pH-Eh) dans les sols sulfatés de Casamance. *Cah. ORSTOM Sér. Pédol.*, XXIII, 55–66
- Mueller SC, Stolzy LH and Fick GW (1985) Constructing and screening platinum microelectrodes for measuring soil redox potential. *Soil Science*, 139, 558–560
- Patrick WH, Gambrell RP and Faulkner SP (1996) Redox measurements of soils. In *Methods of Soil Analysis, Part 3 Chemical Methods*, Bigham JM and Bartels JM ed. SSSA-ASA, Madison, Wisconsin, Etats-Unis
- Susini J and Loyer JY (1977) *Réalisation d'un ensemble automatique pour la mesure en continu et in situ du pH, du Eh, du pNa du sol.*, ORSTOM-DRES, Tunis, 17 p
- van Bochove E, Beauchemin S and Thériault G (2002) Continuous multiple measurement of soil redox potential using platinum microelectrodes. *Soil Science Society of America Journal*, 66, 1813–1820
- Vizier JF (1971) Etude de l'état d'oxydo-réduction du sol et ses conséquences sur la dynamique du fer dans les sols hydromorphes. *Cah. ORSTOM Sér. Pédol.*, IX, 376–380
- Vizier JF (1989) Etude du fonctionnement des milieux saturés d'eau. *Cah. ORSTOM sér. Pédol.*, XXV, 431–442

## Carbonates

### 17.1 Introduction

Carbonates are abundant in the terrestrial biosphere and comprise a group of minerals with more than 130 species, mainly forms of:

- $\text{Ca}^{2+}$  ( $\text{CaCO}_3$ , calcite and some rarer polymorphic forms, aragonite, vaterite, ikaite)
- $\text{Mg}^{2+}$  ( $\text{MgCO}_3$ , magnesite, lansfordite and substituted  $\text{CaMg}(\text{CO}_3)_2$  forms, dolomite, huntite)
- $\text{Na}^+$  ( $\text{Na}_2\text{CO}_3$ , e.g. natron, thermonatrite)
- $\text{Fe}^{2+}$  ( $\text{FeCO}_3$ , e.g. siderite and substituted forms as ankerite (Fe–Ca–Mg–Mn))

Many groups have intermediate species with two or three metallic elements and different substitutions. Carbonates were formed during geological times under the action of physical, chemical and biochemical factors (Chamayou and Legros 1990) particularly during the transgression of the Jurassic and of the Cretaceous according to reactions giving the simplified balance:

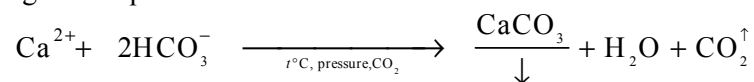

Carbonates were deposited by sedimentation in marine or lake environments and may originate from precipitation products that differ in their relative solubility (Garrels and Christ 1967): approximately  $0.014 \text{ g L}^{-1}$  for calcite,  $0.106 \text{ g L}^{-1}$  for magnesite,  $71 \text{ g L}^{-1}$  for natron  $0.067 \text{ g L}^{-1}$  for siderite (a reducing medium is necessary to obtain bivalent iron of siderite).

Carbonates can also originate within organic materials resulting from living organisms (biogenic limestones from polypiers, algae, various foraminifera, shells, etc.) or detrital products resulting from the degradation of limestone rocks through erosion.

Pedogenic and biogeochemical processes are responsible for another type of differentiation: calcium and magnesium carbonates that are not very soluble give rise to different calcimagnesian soils which vary with climatic conditions, topography, origin of the parent rock, pH, type of vegetation and level of biochemical activity. Magnesium is more soluble and is generally more easily moved.

In arid and semi-arid climates, illuvial hardened horizons can be observed with high calcium contents (petrocalcic horizon) and possibly precipitation of gypsum.

The very soluble sodium carbonate is generally very quickly eliminated but in arid climates it can accumulate and result in sodic alkaline soils. Its geochemical formation gives rise to three fundamental reactions:

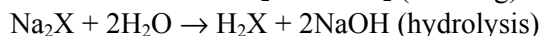
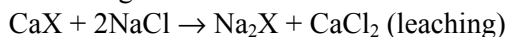

This carbonate is measured with soluble salts (cf. Chap. 18). The disaggregation of the carbonated parent rock leads to the progressive elimination of  $\text{Ca}^{2+}$  but also results in highly differentiated particles that vary with the process of formation of carbonates in soils: forms of sands, silts, nodules, oolites, crusts, pellicular coverings or interparticle cements.

Calcareous chalks and marls, which are highly porous and have pores about one micron in size, result in enrichment in fine sands and silts in contact with  $\text{CO}_2$  charged water. Less porous, more compact limestones give mostly coarser particles such as gravels and sands.

Disaggregation by plants and micro-organisms can also cause simultaneous mechanical and biochemical processes under the combined action of roots and organic acids. Concentrations and precipitations of calcite can be observed in the vicinity of the roots and even within the roots in not very wet climates (Jaillard 1984). When calcium carbonate is abundant, especially in the form of very fine particles, its reactive surface is extensive inducing particularly high reactivity. Calcium carbonate can combine with the organic phase and modify deterioration processes. Soils resulting from calcareous chalks or marls in particular, can cause the saturation of the soil solution in  $\text{Ca}^{2+}$  ions according to the reaction:

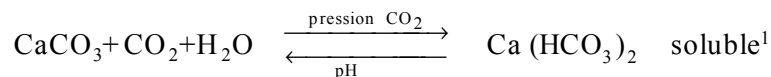

<sup>1</sup> Detailed equations in Garrel and Christ (1967), Chamayou and Legros (1990).



In this case, analysis of total carbonates is of no use to agronomists. Two soils with the same concentration of total carbonates can have a different capacity to induce plant chlorosis.

Studies based on the analysis of active calcium carbonate were undertaken to identify the thresholds that induce calcic and ferric chlorosis.

The analysis of “total carbonates” enables the creation of gradients of the distribution of carbonates in a profile, the contribution of the parent rock (inherited carbonates), of amendments, of colluvial deposition etc. But this analysis cannot distinguish pedogenic Ca from inherited Ca. The total carbonate contents can vary from 2 to 50%, or even more.

The analysis of “active carbonates”, the significance of which was underlined by Callot and Dupuis (1980), is linked with the content of calcareous silts and the rate of extractable iron (Juste and Pouget 1972). It may be possible to establish a correlation between active carbonates and total carbonates using fractions below 20  $\mu\text{m}$ .

## 17.2 Measurement of Total Carbonates

### 17.2.1 Introduction

In situ pH measurements between approximately 7.5 and 8.5 indicate the presence of carbonates. A higher pH (towards 10) can indicate the presence of sodium carbonate.

A rapid test with a 10% hydrochloric acid solution produces effervescence. The degree of effervescence observed provides information about the carbonate content but does not explain the origin of the carbonate (Ca, Mg, Na, Fe, etc.).  $\text{Ca}^{2+}$  and  $\text{Na}^{+}$  carbonates react instantaneously with hydrochloric acid, while  $\text{Mg}^{2+}$  and  $\text{Fe}^{2+}$  carbonates release  $\text{CO}_2$  slowly. The distribution of carbonates can vary greatly with the soil particles and one way of distinguishing the differences is in the location of the effervescence around the small insulated particles such as nodules or oolites.

It is important to identify the nature of mineral components in order to choose the best procedure to use i.e. XRD (Chap. 4), observation by SEM + EDX or FTIR microscope (Chap. 8), or thermal analysis (Chap. 7).

Methods for the measurement of total carbonates are generally based on the release of carbon dioxide by acid attack. Alternative methods measure:

1. The volume of CO<sub>2</sub> produced under well-controlled analytical conditions particularly temperature and pressure
2. Released CO<sub>2</sub> by infrared absorption spectrometry
3. Released CO<sub>2</sub> by gas chromatography after separation from other gases
4. Thermogravimetric evolution coupled with evolved gas analysis (EGA, cf. Chap. 7)
5. Breakdown of carbonates by an acid solution and back-titration of the remaining acid in the solution

None of these methods is perfect. Method (1) allows representative sampling by modulating the weight of the samples and by isogranulometric crushing into fine particles which regulates the time of attack. This method is simple and fast and has proved satisfactory for repetitive analysis if pressure and temperature conditions are respected. It is used for soils with carbonate contents higher than 2–5%. Methods (2), (3), (4) can only be used for microsamples, the results are not really representative, and they require relatively sophisticated equipment that is not accessible for all laboratories. Because of the heterogeneity of the soil, these methods are used for detailed mineralogical studies, for example to differentiate calcite and magnesite, or siderite. Method (5) is simple to implement but is often not precise enough in the case of low contents.

### 17.2.2 Volumetric Measurements by Calcimetry

#### *Principle*

The carbonates are destroyed by hydrochloric acid and the volume of released carbon dioxide is measured at controlled temperature and pressure.

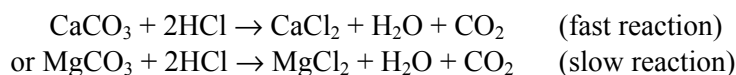

This method is part of the international standard (NF ISO 10693 1995). Balázs Horváth et al. (2005) propose an improvement of this method using the pressure calcimeter. The pressure change caused by the reaction

between HCl and the soil sample is measured with a digital plunge-in manometer through a silicone–rubber septum placed on a screw-capped tube.

### **Equipment**

- Analytical balance ( $\pm 0.1$  mg)
- Bernard calcimeter with two-way stopcock and 250 mL Erlenmeyer flask fitted with finger (Fig. 17.1)
- Large wooden grip
- Barometer

### **Products**

- Deionized boiled water
- Calcium carbonate ( $\text{CaCO}_3$ ) in powder form, dried in a desiccator
- 18 mol (HCl)  $\text{L}^{-1}$  hydrochloric acid: mix one volume of deionized boiled water with one volume of concentrated hydrochloric acid ( $d = 1.19$ )
- Filling solution for the calcimeter: saturated sodium chloride containing a colour reagent

### **Procedure**

- Work in an air-conditioned room at  $20^\circ\text{C}$  on a soil sample crushed to 0.1 mm particle size and dried in the desiccator.
- Weigh from 1 to 10 g of soil to obtain a volume of  $\text{CO}_2$  of about 60–80 mL.
- Pour the soil onto a non-gummed cigarette paper and wrap carefully without losing any of the sample.
- Use a 10 mL pipette to introduce the hydrochloric acid into the finger of the Erlenmeyer flask without allowing any of the acid solution to reach the bottom of the flask (Fig. 17.1).
- Add the soil sample.
- Moisten with 2 mL of deionized water to release the soil from the cigarette paper.
- Avoid heating the elements of the calcimeter with your hands, open tap *a* and stop the Erlenmeyer flask.
- Use the mobile tank *c* to adjust to level 0 in the graduated cylinder, then turn off the tap *a*.
- Using the wooden grip, rock the flask to bring the acid and the soil into contact.

- Agitate and gradually lower the tank (c in Fig. 17.1) monitoring the decrease in the level of the liquid in the graduated cylinder.
- When the level has stabilized, bring the level of the liquid in the tank to the level of the liquid in the graduated column and make the reading, V mL CO<sub>2</sub>.
- Note the temperature and the atmospheric pressure.

#### Calibration of the apparatus

Weigh 0.3 g of calcium carbonate dried in the desiccator and place it in a non-gummed cigarette paper. Continue as above and note the volume obtained. Repeat this procedure with 0.2 g and 0.1 g of calcium carbonate.

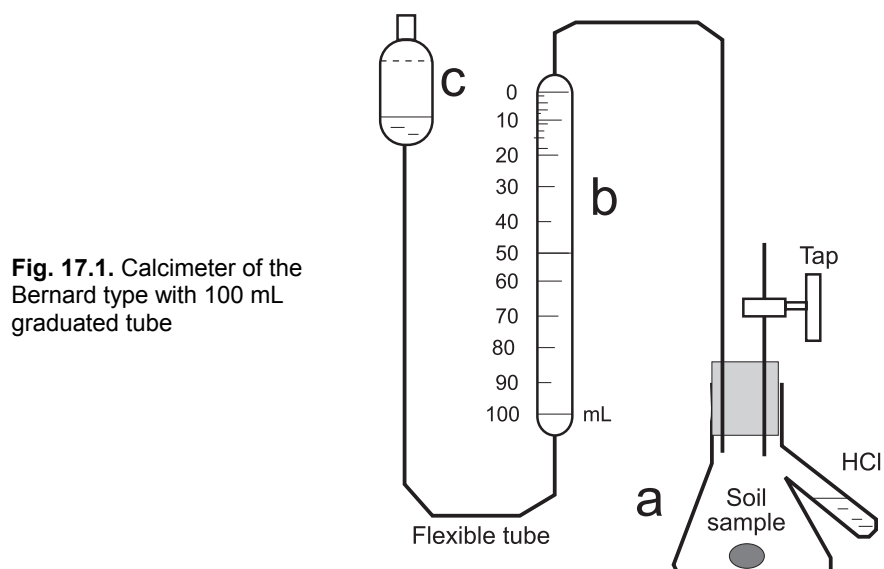

**Fig. 17.1.** Calcimeter of the Bernard type with 100 mL graduated tube

#### Calculation

The result is generally expressed as a percentage of limestone:

$$\text{CaCO}_3\% = \frac{V \times M \times 2.28 \times 100}{1,000 \times P}$$

V: volume of evolved CO<sub>2</sub> per sample (mL), M: mass in g of 1 L of CO<sub>2</sub> in titration pressure and temperature conditions (Table 17.1), P:

$$\text{weight of sample (g), } 2.28 = \frac{\text{CaCO}_3}{\text{CO}_2} = \frac{100.09}{44.01}$$

**Table 17.1.** Mass in grams of 1 L of dry CO<sub>2</sub> at different temperatures and pressures

	millibars	986.66	1,000.00	1,013.33	1,026.6
t°C	mm Hg	740	750	760	770
20°		1.7423	1.7665	1.7906	1.8147
21°		1.7338	1.7530	1.7818	1.8059
22°		1.7251	1.7443	1.7730	1.7970
23°		1.7164	1.7355	1.7641	1.7880
24°		1.7075	1.7265	1.7551	1.7789

**Remarks**

- The column is filled with a coloured saturated sodium chloride solution to limit dissolution of carbon dioxide and to facilitate reading.
- The temperature measured is ambient temperature; as the HCl + CaCO<sub>3</sub> reaction is exothermic, the real temperature may be slightly higher; wait one minute for the temperature to stabilize before reading.
- The calcimeter can be calibrated by preparing corresponding ranges from 5 to 50% of CaCO<sub>3</sub>.
- The measurement may be distorted by excess if sulphides are present; at the end of analysis, check the odour of hydrogen sulphide in the evolved carbon dioxide.
- Siderite is not completely attacked which results in underestimation of carbonate content.
- In the presence of dolomite [CaMg(CO<sub>3</sub>)<sub>2</sub>], two readings should be made, the first after 1 min, the second after 3 min, as dolomite reacts more slowly than limestone.

**17.2.3 Acidimetry****Principle**

This rapid method is based on neutralization of the sample by a titrated acid. Back-titration by a base makes it possible to determine equivalent calcium carbonate. As the dissolution of calcite is not selective, magnesite, dolomite and part of the siderite will also be dissolved.

### **Equipment**

- Laboratory glassware
- Centrifuge with 250 mL centrifugation tubes with screw caps
- Agitator

### **Reagents**

- Boiled deionized water.
- Hydrochloric acid,  $d = 1.19$ .
- 1 mol L<sup>-1</sup> hydrochloric acid solution: add 42.5 mL of concentrated hydrochloric acid in approximately 400 mL deionized water while homogenizing by agitation; let cool and complete to 500 mL.
- Standard commercial dose 0.5 mol L<sup>-1</sup> hydrochloric acid.
- 0.5 mol L<sup>-1</sup> sodium hydroxide solution: dissolve 20 g of soda pellets in a 1 L boiling flask containing 1,000 mL deionized boiled water; let cool protected from the air; homogenize and immediately titrate with the 0.5 mol (HCl) L<sup>-1</sup> solution. This solution does not keep and should be prepared every two days and titrated before each use.
- 0.1% phenolphthalein indicator in ethanol solution.

### **Procedure**

- Weigh 5 g of soil crushed to 0.1 mm (or 2.5 g for soils with high limestone content).
- Add 100 mL of 1 mol (HCl) L<sup>-1</sup> solution and agitate in a 250 mL centrifugation tube.
- Leave in contact overnight.
- Close the tube and agitate for 2 h.
- Centrifuge at 2,000 g and pipette 10 mL of the supernatant liquid into a 100 mL Erlenmeyer flask.
- Add 25 mL water, two drops of phenolphthalein and titrate using 0.5 mol (NaOH) L<sup>-1</sup> solution.
- Under the same conditions, treat two blanks and a control specimen of 500 mg of calcium carbonate.

### **Calculations**

The result is generally expressed as a percentage of limestone ( $M_{1/2CaCO_3} = 50$  g):

$$CaCO_3\% = 50 N \frac{a - b}{S}$$

(correct by moisture measured after drying at 105°C on a separated sample)

- a: mL NaOH used for blank titrations;
- b: mL NaOH used for titration of the soil sample;
- S: weight of sample dried in the desiccator (g);
- N: concentration of the soda solution (mol L<sup>-1</sup>).

### Remarks

- Equivalent CaCO<sub>3</sub> may be overestimated if HCl reacts with non-carbonated substances in the soil.
- Dolomite and magnesite are completely dissolved, but only part of siderite.
- Analysing Ca and Mg in the solution makes it possible to distinguish CaCO<sub>3</sub> and MgCO<sub>3</sub>.

## 17.3 Titration of Active Carbonate

Also called the Drouineau and Galet method, titration of active carbonate is standardized in the international NF X31-106 standard (1982) and was proposed by Loeppert and Suarez (1996).

### 17.3.1 Principle

The soil sample is put in contact with ammonium oxalate under standard time conditions for attack and agitation. Ammonium oxalate having not reacted with carbonates, is then back titrated by manganimetry:

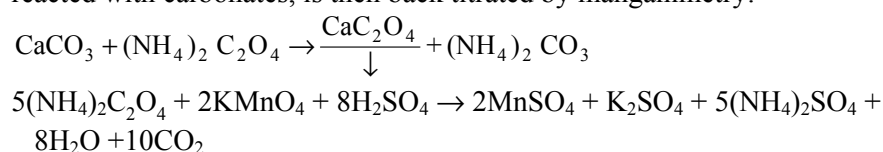

The method should not be used for very organic or gypseous soils. The presence of reducing substances should be avoided.

### 17.3.2 Implementation

#### Equipment

- Analytical balance.
- Reverse agitator.
- A range of lab glassware.

### Reagents

- Deionized boiled water.
- Distilled water for the oxidizing solutions.
- Ammonium oxalate ( $(\text{NH}_4)_2\text{C}_2\text{O}_4$ ,  $\text{H}_2\text{O}$  mw = 142.11 g.
- 0.2 mol ( $\frac{1}{2}\text{NH}_4)_2\text{C}_2\text{O}_4$ )  $\text{L}^{-1}$  extraction solution:
  - (a) Weigh 14.2110 g of ammonium oxalate (dried in the desiccator for 48 h)
  - (b) Dissolve in deionized water at  $80^\circ\text{C}$  and complete to 1 L after cooling
  - (c) Titrate with a 0.1 mol ( $\frac{1}{5}\text{KMnO}_4$ )  $\text{L}^{-1}$  standard potassium permanganate solution.
- Sulphuric acid,  $d = 1.84$ .
- Diluted solution of sulphuric acid: slowly pour 50 mL  $\text{H}_2\text{SO}_4$  into 200 mL deionized water; let cool.
- Potassium permanganate,  $\text{KMnO}_4$ , mw = 158.03 g.
- 0.1 mol ( $\frac{1}{5}\text{KMnO}_4$ )  $\text{L}^{-1}$  standard solution: use commercial standard dose or weigh 3.1606 g of potassium permanganate, dissolve in 800 mL distilled water in a 1 L volumetric flask; agitate until potassium permanganate is completely dissolved, complete to 1,000 mL (check purity with oxalic acid 0.1 mol ( $\frac{1}{2}\text{H}_2\text{C}_2\text{O}_4$ )  $\text{L}^{-1}$  standard solution.

### Procedure

- Samples: crush a specimen of 2 mm air-dried soil to 1 mm. Measure the residual moisture of the 1 mm crushed soil to correct the results which will be expressed on the basis of the soil dried at  $105^\circ\text{C}$ .
- Weigh 2.5 g of soil and place in a 500 mL Erlenmeyer flask.
  - Add 250 mL ammonium oxalate 0.2 mol ( $\frac{1}{2}\text{NH}_4)_2\text{C}_2\text{O}_4$ )  $\text{L}^{-1}$  and agitate for 2 h in a rotary agitator.
  - Filter on blue analytical filter; discard the first fractions if they are turbid.
  - Take 10 mL of clear filtrate and pour into a 250 mL Erlenmeyer flask.
  - Add approximately 75 mL of distilled water.
  - Add 25 mL of diluted sulphuric acid.
  - Heat at  $60^\circ\text{C}$  on the heating turntable of a magnetic stirrer and titrate with the potassium permanganate 0.1 mol ( $\frac{1}{5}\text{KMnO}_4$ )  $\text{L}^{-1}$  solution until a stable pale pink colour is obtained:  $X$  mL. Titrate 10 mL of the oxalate solution in the same way:  $Y$  mL. The difference between the two titrations corresponds to the quantity of calcium carbonate that has reacted with ammonium oxalate.



**Calculation**

The percentage of active limestone of the sample is expressed by: Active

$$\text{CaCO}_3\% = 50 \times 0.1 (Y - X) \frac{250}{10} \frac{100}{2500} \frac{c}{0.1} = 50 c (Y-X),$$

where  $Y$  and  $X$  are volumes (mL) of manganic solution for respective titrations of the blank and of the sample, and  $c$  is the real content of this solution in equivalents per litre.

**Remarks**

The organic matter can be slightly solubilized and consume a little permanganate. It should be noted that many other methods have been developed in reducing medium at pH 4.8 (for extractable Fe, Al, Si), or complexants with the EDTA, DTPA, CDTA or EDDHA<sup>2</sup> (cf. Chap. 31).

**17.3.3 Index of Chlorosis Potential**

In the presence of an excessive concentration of active calcium carbonate, the development of calcifuge plants can be inhibited and the plants will display pathological symptoms. Active calcium carbonate is also antagonistic to iron and can cause ferric chlorosis. Iron, which is essential to chlorophyllian plants, is immobilized and results in deficient plant growth. Thorne and Wallace (1944) recommended the determination of “free” iron extractable with 0.5% oxalic acid solution to determine the levels of iron deficiency. Juste and Pouget (1972) defined an “index of chlorosis potential” (CP) which binds active calcium carbonate and extractable iron titrated in the same ammonium oxalate medium (Fe can be determined by atomic absorption spectrometry at 243.3 nm with air-acetylene flame).

$$\text{CP} = \frac{\text{active calcium carbonate } \%}{\text{extractable iron (ppm)}} 10^4$$

The method was proposed as FD X31-146 standard (1996), but the reproducibility of an inter-laboratory test was not very satisfactory.

<sup>2</sup> EDTA, ethylene diamine tetra-acetic acid; DTPA, diethylene triamine penta-acetic Acid; CDTA *trans*-1,2 diamino cyclohexane N, N, N', N' Tetra-acetic Acid; EDDHA, ethylene diamine di (O-Hydroxyphenyl acetic Acid).

## References

- Balázs H, Opara-Nadib O and Beesea F (2005) A simple method for measuring the carbonate content of soil. *Soil Sci. Soc. Am. J.*, 69, 1066–1068, DOI: 10.2136/sssaj2004.0010
- Callot G and Dupuis M (1980) Le calcaire actif des sols et sa signification. *Sci. du Sol.*, 1, 17–26
- Chamayou H and Legros JP (1990) Les bases physiques, chimiques et minéralogiques de la science du sol. *Presses Univ. France*, 593 pages
- FD X31-146 (1996) Détermination de l'indice de pouvoir chlorosant (IPC) selon Juste et Pouget. In *Qualité des sols*, AFNOR, 117–125
- Garrels MA and Christ GL (1967) Equilibre des minéraux et de leurs solutions aqueuses. Gauthier-Villard, Paris, France
- ISO 10693 (1995) Soil quality - Determination of carbonate content - Volumetric method. International Organisation for Standardization
- Jaillard B (1984) Mise en évidence de la néogenèse des sables calcaires sous l'influence des racines: incidence de la granulométrie du sol. *Agronomie.*, 4, 91–100
- Juste C and Pouget R (1972) Appréciation du pouvoir chlorosant des sols par un nouvel indice faisant intervenir le calcaire actif et le fer facilement extractible. *C.R. Acad. Agric. de Fr.*, 58, 352–357
- Loeppert RH and Suarez DL (1996) Carbonate and gypsum. In *Methods of Soil Analysis*, Part 3, Chemical Methods, Bigham JM and Bartels JM ed. SSSA, ASA, Madison, Wisconsin, Etats-Unis, 437–474
- NF ISO 10693 (1995) Détermination de la teneur en carbonate - Méthode volumétrique. In *Qualité des sols*, AFNOR, 177–186
- NF X31-106 (1982) Détermination du calcaire actif. In *Qualité des sols*, AFNOR, 55–58
- Thorne DW and Wallace A (1944) Some factors affecting chlorosis on high-line soils. I - Ferrous and Ferric iron. *Soil Sci.*, 57, 299–312

## Soluble Salts

### 18.1 Introduction

The term “soluble salts” covers a range of anions and cations present in the soil in either crystallized solid form (e.g. efflorescence, crusts, microcrystalline clusters), or in dissolved form in the soil solution – other than soluble organic matter (cf. Chap. 13). Soluble salts are different from the cations of the soil exchange complex (cf. Chap. 19) adsorbed on the surface of clays (cf. Chap. 22) with which they are in equilibrium.

Soil soluble salts are often compared to a combination of major elements including the  $\text{Na}^+$ ,  $\text{K}^+$ ,  $\text{Ca}^{2+}$  and  $\text{Mg}^{2+}$  cations and the  $\text{Cl}^-$ ,  $\text{HCO}_3^-$ ,  $\text{CO}_3^{2-}$ ,  $\text{SO}_4^{2-}$  anions. When present in sufficient quantities in the soil, these salt systems belong to the group of saline soils named *Halomorphes*, *Solontchaks*, *Salisols* or *Salic* soils depending on the system of classification used (INRA 1995; FAO 1998). These soils are common in all dry regions in the world and near the sea (primary salinity). Land under irrigation also frequently displays saline characteristics (secondary or anthropic salinity) induced by the poor quality of the water used, by fertilization or by bad agricultural practices, particularly the absence of drainage (Bouteyre and Loyer 1995; Qadir et al. 2001).

These salts can originate from very diverse marine, petrographic or eruptive sources. In sedimentary mediums, they are mainly in the form of chlorides and sulphates, whereas carbonates and bicarbonates dominate in crystalline mediums. As well as these major anions, nitrates, borates or even arsenic salts are also found in certain systems, sometimes in quite high proportions.

The most soluble and most frequently recognized salts in soils are halite or sodium chloride ( $\text{NaCl}$ ), sylvinite or potassium chloride ( $\text{KCl}$ ), sodium sulphates (thenardite and mirabilite), potassium and magnesium

sulphates (epsomite, and hexahydrate), sodium and magnesium sulphates (bloedite), many mixed aluminium sulphates (of the alum type), sodium carbonate (natron). High solubility in water, higher than the gypsum ( $2.6 \text{ g L}^{-1}$ ), is the major characteristic that allows differentiation of saline soils from, for example, purely gypseous soils (Loyer 1991). Solubility generally increases with temperature; the solubility of gypsum increases up to  $2.653 \text{ g L}^{-1}$  at  $40^\circ\text{C}$  then decreases up to  $2.049 \text{ g L}^{-1}$  at  $100^\circ\text{C}$ . Table 18.1 lists the solubility of a few soluble salts at  $20^\circ\text{C}$ .

**Table 18.1.** Solubility of a few salts frequently present in soils ( $K$  = solubility product)

salt	mineral	$\text{g L}^{-1}$ at $20^\circ\text{C}$	$\log K$
NaCl	halite	360	+ 1.55
$\text{Na}_2\text{SO}_4$	thenardite	209	- 0.86
$\text{Na}_2\text{CO}_3 \cdot \text{H}_2\text{O}$	thermonatrite	215	+ 0.1
$\text{NaNO}_3$	nitratite	880	
KCl	sylvinite	350	+ 0.80
$\text{K}_2\text{SO}_4$	arcanite	109	
$\text{MgCl}_2$	chloromagnesite	543	+ 22
$\text{CaCl}_2$	hydrophilite	427	+ 11.5

Among the factors which influence the solubility of each salt, the presence of other salts should not be neglected. For example, gypsum solubility increases considerably in the presence of sodium chloride, but decreases in the presence of sodium sulphate due to the effect of common ions (Pouget 1968; Harvie and Weare 1980; Harvie et al. 1984).

Laboratory measurement of the soluble salts in the soil involves three stages:

- Extraction by water at different soil/solution ratios (saturation extracts, aqueous extracts 1:1, 1:5, 1:10).
- Measurement of the total salt concentration of the extract (electric conductivity, dissolved solid matter).
- Titration of the different anions and cations contained in the extract

## 18.2 Extraction

### 18.2.1 Soil/Solution Ratio

The choice of the soil/solution ratio used for the extraction of soluble salts depends on several different criteria and in particular on the purpose

and the execution speed. The time-consuming method of extraction of saturated paste is used with the aim of reproducing as closely as possible the real in situ soil solution from which the plants take up nutrients. Methods using diluted extracts are faster and allow monitoring of vertical and spatial variations in salinity and of changes over time due to the external or internal factors that influence salinity. The relations that bind the different extracts are not the same everywhere (cf. Sect. 18.23) but depend on the type of salts in the geographical area concerned (Le Brusq and Loyer 1982).

### **18.2.2 Extraction of Saturated Paste**

#### ***Principle***

This is the international reference method recommended by Riverside Salinity Laboratory, USA (Richards 1954). Given the difficulty in obtaining an extract that is representative of the soil solution which lies between water content at field capacity and water content at wilting point at a given time, this standardized method consists in bringing the sample to saturation, i.e. close to its liquidity limit (Servant 1975; Baize 1988).

#### ***Procedure***

- In a capsule with a lid, weigh between 250 and 500 g of soil sieved to 2 mm, air dried and of known moisture content.
- Prepare the paste by adding a known quantity of distilled water while mixing with a spatula until saturation. From time to time consolidate the mixture by striking the container on the laboratory table.
- With the exception of very clayey soils, when saturated, the soil paste will shine in the light, run slightly when the capsule is tilted, and slide easily along the spatula.
- Cover the capsule and let stand for 1 h or more before checking saturation. Correct if necessary by adding either water or soil in known quantities.
- Weigh the capsule and calculate the percentage of water at saturation (cf. “Water Content of Saturated Paste” under Sect. 18.2.2) with respect to the quantity of water added and to the initial moisture of the soil (or after drying part of the saturated paste at 105°C).
- Filter on a Büchner funnel and collect the solution in a filter-flask, avoid using Pyrex glass if boron titration is required.

– If the filtrate is turbid, filter again on membrane or centrifuge. If analysis of carbonates and bicarbonates is required, adding a drop of 0.1% sodium hexametaphosphate solution (0.1 g of sodium hexametaphosphate diluted in 100 mL of deionized water) for 25 mL of extract, prevents the precipitation of  $\text{CaCO}_3$ . Preserve the extract in a closed bottle for later measurements and titrations.

### **Remark**

For rapid measurement of soil salinity, filtration can be performed a few minutes after preparation of the paste. In other cases it is preferable to wait a few hours. If the soil is gypseous, let the paste stand for several hours (4–16 h) before extracting the solution.

### **Water Content of Saturated Paste**

If  $W_s$  is the weight of the test specimen of soil dried at  $105^\circ\text{C}$ , and  $W_w$  is the weight of added water (including water initially present in the soil sample), the percentage of water at saturation SW is obtained by:

$$\text{SW} = 100 \frac{W_w}{W_s} \quad (18.1)$$

### **18.2.3 Diluted Extracts**

#### **Comparative Interest**

In this more rapid technique, a given weight of soil  $W_s$  must be put in contact with a variable weight of water  $W_w$  so that a ratio  $W_w:W_s = n$  is obtained (instead of SW:100 in (1)). One of the consequences of dilution is that the total ionic concentration of the more or less diluted aqueous extracts ( $C_n$ ) is theoretically lower than that measured on the saturated extract ( $C_{se}$ ) from the sole effect of dilution:

$$C_n = \frac{C_{se} \text{ SW}}{100 n} \quad (18.2)$$

If the electrical conductivity EC and the corresponding concentration of the aqueous extract are proportional, one can write:

$$\text{EC}_n = \frac{\text{EC}_{se} \text{ SW}}{100 n} \quad (18.3)$$

Initially it could be expected that the multiplicative factor necessary to pass from one to another measurement is inversely proportional to dilution. However, the conductivity measured on the diluted extracts is often higher than the conductivity calculated starting from (3) (Le Brusq and Loyer 1982). In fact, certain extracts, especially the 1:10 extract, result in significant supplementary dissolution of salts compared to the saturated extract. This proves that the relation between the conductivities of the different extracts is not only directly proportional to the water volume but in practice varies with different factors such as soil texture, salinity and the ionic composition of the dissolved compounds.

Diluted extracts are especially useful in the case of low saline concentrations with a relatively low proportion of gypsum. From a practical point of view in the case of serial analyses of numerous samples, the conductivity of the 1:2 extracts should be measured first. Those which give by calculation values for  $C_{se} > 10 \text{ dS m}^{-1}$  can then be started again using (1) a saturated paste, and (2) a very diluted extract for total gypsum. For the samples where  $C_{se} < 10 \text{ dS m}^{-1}$ , the 1:2 extract is sufficient. In the 1:2 extracts the anion: cation balance is only slightly modified or not modified at all. In the 1:5 and 1:10 extracts, the phenomena of hydrolysis of sodium and exchange with calcium in the extraction solution have to be taken into consideration as they can lead to modifications in the balance between salts.

### **Procedure**

- Weigh a sample of air-dried soil sieved to 2 mm and place it in a bottle suitable for the volume of the extract required; add the quantity of distilled water necessary to obtain the desired ratio of soil to solution (1:1, 1:2, 1:5, 1:10).
- Correct for the initial moisture of the soil especially when using low soil/solution ratios (for example for the 1:1 extract, with 2% of initial moisture, add 98 mL of water to 102 g of soil), or if a high degree of accuracy is required.
- Agitate mechanically for 1 h (or shake vigorously by hand 4 times at 30 min intervals) and filter.
- Add one drop of 0.1% sodium hexametaphosphate solution for 25 mL of extract and close the container tightly before titration.

### **18.2.4 In Situ Sampling of Soil Water**

When soil water is measured in situ a more accurate account is obtained of thermodynamic equilibriums of ions in contact with the plant roots. Different types of soil water can be distinguished (e.g. interstitial water,

bound water, see Chap. 1) corresponding to different techniques of water sampling (Pansu et al. 2001), particularly that of the porous plugs analyzed by Cheverry (1983) and described by Rhoades and Oster (1986) for the study of saline soils.

### 18.2.5 Extracts with Hot Water

Hot water enables a much larger quantity of materials to be solubilized than cold water (from 10 to more than 50 times on *Luvisol* soils cf. Chap. 13). Extraction with hot water can thus be an indicator of potentially extractable elements and compounds and is recommended for boron quantification (NF X31-122 1993). The procedures are rather difficult to standardize because on certain soils dissolution does not seem to be complete for a given length of attack (Kouakoua et al. 1997). The attack necessary to the selective extraction of boron (cf. Sect. 31.2.7 of Chap. 31) is not very aggressive. The attack used to quantify water-soluble organic origin (reflux 16 h, cf. Sect. 13.2.6 of Chap. 13) is more aggressive. This attack extracts a considerable quantity of anions in addition to those extracted by cold water (see Fig. 18.2).

## 18.3 Measurement and Titration

### 18.3.1 Electrical Conductivity of the Extracts

#### **Benefits**

In contrast to perfectly pure water, saline solutions have the conduction property of electric current. The electric conductivity (EC) measured is proportional to the quantity and nature of salts dissolved in the solutions. Thus a good general relationship of proportionality exists between electrical conductivity (in deciSiemens per metre) and total concentration (tC) of anions or cations (in meq L<sup>-1</sup> or mg L<sup>-1</sup>):

$$\text{– in meq L}^{-1}, \text{ tC} = (10 \text{ to } 12) \times \text{EC} \quad (18.4)$$

$$\text{– in mg L}^{-1}, \text{ tC} = (600 \text{ to } 650) \times \text{EC}. \quad (18.4')$$

However, the variability of the proportionality factor shows that this relation is not universal. It depends on the ionic composition of the soil solutions (Job 1985), and is thus not necessarily transferable from one geographical region to another. It is advisable to establish the relation



$EC = f(tC)$  applicable to the specific saline context concerned rather than use the average line obtained by Richards (1954) on soils in the west of the United States.

Measurement of electrical conductivity is the most widely used soil salinity test (Rhoades and Miyamoto 1990; Shirokova et al. 2000). It is usually carried out on the saturated or diluted extract, but sometimes directly on the saturated paste itself. This measurement is highly dependent on the temperature (increase of almost 2% per degree), and must consequently be adjusted to a reference temperature of 25°C after measurement of the temperature of the solution. When measured at the same time as pH, measurement of conductivity is a good indicator of soil quality (Smith and Doran 1996). Measurement of the specific conductivity of the 1:5 extract is the subject of the international standard NF ISO 11265 standard (1995).

### **Principle**

Measurement of EC is based on the measurement of electrical resistance between two parallel electrodes immersed in the aqueous extract obtained as in Sect. 18.2.

The traditional conductivitymeter is based on the principle of the Wheatstone bridge. It includes a cell made of two platinum electrodes of defined surface area and spacing, usually covered with platinum black to decrease the resistance of the interface electrode-solution. Alternating frequency high voltage is applied between the electrodes to measure resistance. Specific resistance  $sR$  of a solution is defined by the resistance of a cube with sides measuring 1 cm (surface of electrode 1 cm<sup>2</sup>, distance between electrodes 1 cm). In practice, the inter-electrode volume is not exactly 1 cm<sup>3</sup> and consequently resistance  $R$  (measured in Ohms) is not exactly the same as specific resistance. A cell constant should thus be defined:

$$K = R/sR.$$

The reverse of  $R$  expresses the conductance in mhos or Siemens, which, with this type of electrode, gives a specific electric conductivity EC:

$$EC = 1/sR = K/R. \quad (18.5)$$

Expressed in the international system (SI units) in Siemens per m, or sub-units according to the calibration selected (1 S m<sup>-1</sup> = 10 dS m<sup>-1</sup> = 10 mS cm<sup>-1</sup> = 10 mmhos cm<sup>-1</sup> = 1,000 mS m<sup>-1</sup> = 10,000 μS cm<sup>-1</sup>).

The cell constant, generally provided by the manufacturer, should be checked against standard solutions of potassium chloride whose conductivity (Table 18.2) is in the expected range of measurements to be made.

Most conductivimeters have a logarithmic reading scale and are equipped with a switch of extended range allowing the use of scale multiplicative factors using powers of 10.

**Table 18.2.** EC of a few aqueous KCl solutions at 25°C

<i>mol</i> (KCl) L <sup>-1</sup>	0.001	0.01	0.02	0.05	0.1	0.2	0.5	1
<i>EC</i> dS m <sup>-1</sup>	0.147	1.413	2.767	6.668	12.900	24.820	58.640	111.900

### Reagents

- 0.05 mol (KCl) L<sup>-1</sup> stock solution: dissolve 3.728 g of dry KCl in 1 L of deionised water at 25°C.
- 0.01 mol (KCl) L<sup>-1</sup>: 50 mL of stock solution in 250 mL of deionized water.
- 0.005 mol (KCl) L<sup>-1</sup>: 25 mL of stock solution in 250 mL of deionized water.
- Cleaning solution for the electrode: mix equal volumes of isopropanol, ethyl ether and hydrochloric acid.
- Solution for platinum coating: dissolve 1 g of chloroplatinic acid (H<sub>2</sub>PtCl<sub>6</sub>·6H<sub>2</sub>O) and 12 mg of lead acetate in 100 mL of pure water.

### Preparation of the Platinum Electrodes

In the event of measurements that are not very stable or are too far from the theoretical values of the standard solutions, (cf. “Checking the Cell Constant” by below), the electrodes can be prepared or regenerated as described later.

Clean the electrodes with the sulphochromic mixture, immerse in the platinum solution and connect the two electrode plugs to the negative pole of a 1.5 V electric cell. Connect the positive pole to a platinum wire placed in the solution and electrolyse at a weak current (to avoid gaseous emissions) until the electrodes are coated with black platinum. Rinse the electrode carefully and store in distilled water.

### **Checking the Cell Constant**

Rinse the cell 3 or 4 times with the appropriate standard solution of KCl (in general  $0.01 \text{ mol L}^{-1}$ ) before measuring conductivity and temperature (or only conductivity if you are working in a thermostated medium at  $25^\circ\text{C}$ ). Check the stability of measurement on a new aliquot of standard solution.  $EC_t$  is the theoretical conductivity of the standard solution at  $25^\circ\text{C}$  (Table 18.2),  $EC_m$  is the measured conductance,  $\vartheta$  the temperature ( $^\circ\text{C}$ ) and  $f$  a possible multiplicative factor of the conductance scale. The cell constant  $K$  is obtained by:

$$K = \frac{EC_t}{f \cdot EC_m (1 + 0.019 (25 - \vartheta))} \quad (18.6)$$

### **Conductivity of the Sample**

Take the measurement as in “Checking the Cell Constant” under Sect. 18.3.1 but replace the standard solution by the sample solution. With reference to the symbols defined above in “Checking the Cell Constant” under Sect. 18.3.1, conductivity at  $25^\circ\text{C}$  ( $EC_{25}$  in  $\text{dS m}^{-1}$ ) is obtained by:

$$EC_{25} = K \cdot EC_m (1 + 0.019 (25 - \vartheta)) \quad (18.7)$$

### **18.3.2 In situ Conductivity**

Although less precise than the methods described in Sect. 18.3.1, direct measurement of soil conductivity is useful for rapid mapping of the field distribution of salts or checking salinity dynamics (Simon and Garcia 1999). Several techniques can be used. Porous matrix sensors containing platinum electrodes are inserted in the soil to measure the conductivity of the soil solution (with additional measurement of temperature). Other more sophisticated instrumental techniques can also be used e.g. quadrupole probes, electromagnetic conductivity (Boivin et al. 1989; Job et al. 1997) or time-domain reflectometry sensors. Descriptions of the use of these techniques can be found in Rhoades and Oster (1986) or Corwin and Lesch (2004), to cite two examples.

An alternative solution to in situ measurements consists in measuring the electric conductivity of the soil solution after sampling in the field (cf. Sect. 18.2.4).

Another technique consists in measuring the electric conductivity of the saturated paste obtained directly in the field in appropriate cups (Rhoades 1996).

### 18.3.3 Total Dissolved Solid Material

#### **Principle**

The quantity of total dissolved solids (TDS) in the aqueous extracts (dry residue of the extract) is determined by weighing the evaporation residue of the extract previously filtered on a 0.45  $\mu\text{m}$  membrane. This measurement is normally closely linked with that of electric conductivity (4) and the summation of measurements of extractable cations and anions (cf. Sects. 18.3.4 and 18.3.5), and possibly of the extractable organic matter (cf. Chap. 13). It is thus not necessary to carry out TDS measurements systematically if reliable measurements of electric conductivity are available. Measurement of TDS is useful for precise calibration of (4) enabling a site to be surveyed by measurement of conductivity.

#### **Equipment**

- System of filtration on 0.45  $\mu\text{m}$  membrane (Pansu et al. 2001).
- Pyrex glass Petri dishes for evaporation, approximate capacity 200 mL.
- Ventilated drying oven that can run at 180°C.

#### **Procedure**

- Dry the Petri dishes in the drying oven at 180°C for 2 h, let cool in the desiccator and tare to 1/10 mg:  $P_0$ .
- Choose a sufficient volume  $V$  of aqueous extract (cf. Sect. 18.2) to obtain a 50–100 mg residue, filter at 0.45  $\mu\text{m}$  and place the filtrate (all or part) in the Petri dishes for evaporation.
- Evaporate in the ventilated drying oven at 105°C, if necessary adding the remainder of the filtrate after the volume is reduced.
- Heat the dry residue at 180°C for 1 h to eliminate the water retained in the micropores, let cool in the desiccator and weigh:  $P_1$

The TDS content is expressed in  $\text{mg L}^{-1}$  by:

$$\text{TDS} = 1,000 (P_1 - P_0) / V \quad (18.8)$$

### 18.3.4 Soluble Cations

#### **Methods**

The preferred methods in the laboratory are flame emission or atomic absorption spectrometry. Inductively coupled plasma emission can also be used. These methods generally provide a good estimate of the total contents of the elements in solution by destroying some forms linked to organic matter as well as some mineral forms that are able to precipitate in the extraction water (e.g. carbonates). The implementation of these techniques is described in Chap. 31. The only adaptation to be envisaged is in the range of calibration. Matrix interferences are generally reduced compared to that of the total analyses (cf. Chap. 31) because the extraction solutions are less concentrated.

The ionic forms of the elements can also be estimated using electrochemical methods, particularly ionometry with selective electrodes. This method is also recommended for monitoring in situ changes in elements in the soil solution, as a complement to monitoring changes in total salinity electrochemically or by conductimetry, or other measurements (Pansu et al. 2001). For example, the sodium electrode developed for the study of saline soils by Susini et al. (1972) was integrated in a set of in situ data acquisition of pH, pNa and Eh (Loyer and Susini 1978).

Ionic chromatography is also a useful alternative to cation titration but less justified than for anion titrations given the satisfactory performance of spectrometric methods for cation titrations.

#### **Sodic Character of the Aqueous Extracts**

This parameter is widely used and is based on the analysis of the major cations Ca, Mg and Na (in mmol L<sup>-1</sup>) of the aqueous extracts and defined by the sodium adsorption ratio (SAR, Richards et al. 1954):

$$\text{SAR} = \frac{\text{Na}}{\sqrt{(\text{Ca} + \text{Mg})/2}} \quad (18.9)$$

This parameter must be suitable for the specific type of aqueous extract used. It varies with the quantity of water used for extraction particularly due to possible dissolution of minerals containing calcium, such as calcite and gypsum.

### 18.3.5 Extractable Carbonate and Bicarbonate (Alkalinity)

#### **Principle**

Carbonate anions define the alkalinity of the extracts, although other ions such as hydroxides, borates, phosphates and silicates may also play a minor role. Bicarbonates are an expected component of the aqueous extracts of saline soils whereas carbonates, which are less frequent, are often present in continental alkaline soils (Cheverry 1974). These anions cannot be measured by ionic chromatography using the technique described in Sect. 18.3.6, because they are involved in the composition of the eluent. The recommended methods described below are based on titration by diluted acids, either by automatic titrimetry (Rhoades 1982) or alternatively using the two-indicator technique (Bower and Wilcox 1965). Other automated techniques are also available (Sá et al. 2002).

#### **Apparatus and Reagents**

- Automatic Titrimeter with a glass electrode for pH measurement and a reference electrode (or combined electrode) or failing this, a 10 mL titration burette.
- 0.01 or 0.02 mol (H<sup>+</sup>) L<sup>-1</sup> sulphuric or hydrochloric acid solution (precisely titrated).
- Standard buffer solutions at pH 4 and pH 7.
- Phenolphthalein indicator: dissolve 0.25 g in 100 mL 50% alcohol in water.
- Methyl orange indicator: dissolve 0.1 g in 100 mL water.

#### **Procedure**

##### *Automatic Titrimetry*

- Calibrate the titrimeter with the buffer solutions at pH 4 and 7; carefully rinse the pH electrodes and place them in the aliquot of solution to be titrated (1–20 mL). Agitate on the magnetic stirrer. Note the initial pH value which characterizes the soil sample (cf. Chap. 15).
- Start titration by recording the curve. Note the volume of acid  $V_1$  needed to reach the first titration point of CO<sub>3</sub><sup>2-</sup> at pH 8.3. Note the total volume of acid  $V_t$  needed to reach the second titration point which

is accompanied by the release of CO<sub>2</sub> due to destruction of bicarbonates at pH 4.5.

### *Two Coloured Indicators*

- Pipette the aliquot of solution to be titrated into the titration beaker.
- Add two drops of phenolphthalein indicator. If the solution remains colourless, it does not contain carbonate. If this is not the case, titrate carbonates until discolouration ( $V_1$  volume).
- Add two drops of methyl orange indicator. Titrate bicarbonates until the colour changes. Note the volume:  $V_t$ .

### **Calculations**

If  $V_0$  (mL) represents the volume of aliquot and  $T$  the acid concentration in mol (H<sup>+</sup>) L<sup>-1</sup>:

- The carbonates are expressed in mmol (CO<sub>3</sub>)<sup>2-</sup> L<sup>-1</sup> by  $\frac{1,000}{V_0} \times V_1 \times T$ .
- The bicarbonates are expressed in mmol (HCO<sub>3</sub>)<sup>-</sup> L<sup>-1</sup> by  $\frac{1,000}{V_0} \times (V_t - V_1) \times T$ .

### **Remarks**

Certain aqueous extracts of alkaline soils can be very dark in colour which makes the method described in “Two Coloured Indicators” in “Procedure” under Sect. 18.3.5 difficult. In this case the titrimetric method described in “Automatic Titrimetry” in “Procedure” under Sect. 18.3.5 should be used.

If possible alkalinity (CO<sub>3</sub><sup>2-</sup> and HCO<sub>3</sub><sup>-</sup>) should be measured immediately after extraction to avoid possible modifications (precipitations, exchange with atmospheric carbon dioxide), although these changes can be slowed down by the addition of hexametaphosphate. When several measurements have to be made, alkalinity should be the first measurement to be made on the extracts.

### 18.3.6 Extractable Chloride

#### **Aim**

Chloride is often the major anion of saline soils and Mg, Ca, Na and K chlorides are all very soluble (Table 18.1). Chloride is a very conservative ion which is used as tracer to monitor changes in the concentration of the aqueous solutions. Measuring chloride content is also important because of the toxicity of this anion for certain plants.

#### **Methods**

Because of its specific chemical properties, the chloride anion can be titrated relatively easily and precisely using many different methods. Several volumetric, titrimetric and colorimetric methods use the property of the chloride anion to quantitatively precipitate the silver cation. These methods can be used directly on the initial extract or after the titration of carbonates and bicarbonates (cf. Sect. 18.3.5) on the same aliquot after increasing the pH to between 4.2 and 8.3 by adding a small quantity of sodium bicarbonate.

*Volumetry*: titration with a standard solution of  $0.025 \text{ mol L}^{-1}$  silver nitrate with detection of the end of the reaction with  $\text{K}_2\text{CrO}_4$  (red brown precipitate of silver chromate).

*Titrimetry*: automatic titration (cf. "Automatic Titrimetry" in "Procedure" under Sect. 18.3.5) according to the same principle as volumetry with detection of the end of the reaction with a silver electrode (abrupt change of potential at the end of precipitation of the ions  $\text{Ag}^+$ ).

*Coulometry*: production of  $\text{Ag}^+$  ions by electrolysis from a silver electrode, precipitation of silver chloride before the appearance of free  $\text{Ag}^+$  ions is used to detect the end of the reaction by amperometry using two other indicating electrodes. The chloride rate is calculated directly from the quantity of electricity used for the production of  $\text{Ag}^+$  ions. This coulometric technique is very practical because it does not require any reagent and the apparatus is easy to transport.

*Selective electrodes* are also a low-cost method allowing in situ monitoring of the activity of the chloride ion in the soil solution at the same time as other electrochemical measurements if required (Susini and Nedhir 1980).

The *colorimetric method* with mercuric thiocyanate (cf. "Titration of Chloride by Colorimetry" under Sect. 18.3.6) was very often used because of its great sensitivity and good precision.



### ***Titration of Chloride by Colorimetry***

#### ***Principle***

Chloride ions react with mercuric thiocyanate giving mercuric chloride and thiocyanate ions. In the presence of iron alum, the thiocyanate ions form an orange red complex: ferric thiocyanate. The intensity of colour can be measured at 480 nm.

**Fig. 18.1.4.** Titration of chlorides by automatic colorimetry with segmented continuous flow analysis. For low contents (range 0–0.5 mg L<sup>-1</sup>) inverse sample and water tubes

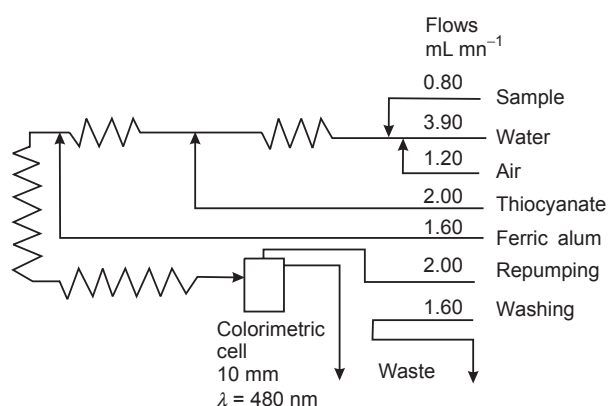

#### ***Equipment and Reagents***

- Colorimeter with quartz or plastic cells or automatic colorimetry by segmented continuous flow analysis.
- Ferric alum  $\text{FeNH}_4(\text{SO}_4)_2 \cdot 12\text{H}_2\text{O}$ : 60 g in 1 L of 6 mol (HNO<sub>3</sub>) L<sup>-1</sup> nitric acid solution.
- Mercuric thiocyanate: 3.5 g in 1 L of water.
- 50 mmol (Cl<sup>-</sup>) L<sup>-1</sup> stock solution: weigh 3.728 g of dry KCl, bring to 1L with ultrapure water.
- Calibration standard: 0–5 mg L<sup>-1</sup> by dilution of the stock solution, 0–0.5 mg L<sup>-1</sup> for low contents.

#### ***Procedure***

Figure 18.1 shows a manifold for chloride titration by automatic coulourimetry adapted by Paycheng (1980). For manual coulourimetry, use proportions of reagents similar to the flows indicated.

### 18.3.7 Extractable Sulphate, Nitrate and Phosphate

#### Uses

Besides carbonate, bicarbonate and chloride, sulphate is a major anion of saline soils. Nitrates are a serious contaminant because of their great solubility. Nitrate content should be checked particularly in irrigated or polluted zones (Cheverry 1998). Sulphate content can be roughly estimated in milli-equivalents by the difference between the sum of cations (Na, K, Ca, Mg) and the sum of anions  $\text{CO}_3^{2-}$ ,  $\text{HCO}_3^-$ ,  $\text{Cl}^-$ ,  $\text{NO}_3^-$ . Phosphates are not characteristic of saline soils but are often present in aqueous extracts of cultivated soils.

#### Titration

The methods described in Chap. 28 can be used for *titration of nitrate*. The most recommended method to use for surveys of saline soils is the nitrate selective electrode in the response range 0–0.01–0.1–1–10–100 mmol ( $\text{NO}_3^-$ )  $\text{L}^{-1}$  either on water extracts, or in situ measurements on soil solutions.

*Titration of sulphate* is described in Chap. 30. Two methods are generally used for aqueous extracts of saline soils. In concentrated samples, turbidity caused by precipitation of barium sulphate can be measured. In more diluted samples ( $< 5$  mmol ( $\frac{1}{2}\text{SO}_4$ ) $^{2-}$   $\text{L}^{-1}$ ) sulphate should be titrated by automatic titrimetry with a 0.002 mmol  $\text{L}^{-1}$  lead perchlorate solution and potentiometric detection with a  $\text{Pb}^{2+}$  specific electrode (Rhoades 1982).

*Titration of phosphates* is described in Chap. 29.

### 18.3.7 Extractable Boron

#### Aim

Although boron is present in much smaller quantities than the main elements of the aqueous extracts (cf. Sects. 18.3.4–18.3.6), in saline soils it tends to accumulate with other salts. Its study is sometimes necessary, especially because of the influence this element has on plant growth. Its threshold of deficiency is very close to its threshold of toxicity.

### **Methods**

Boron can be measured in aqueous extracts by inductively coupled plasma emission spectrometry (cf. Chap. 31) at the wavelength of 249.773 nm, with a limit of detection of about  $10 \mu\text{g L}^{-1}$ . Iron can interfere at the 249.782 nm line and its concentration in the extracts should not be too high, i.e. less than 1,000 times that of boron (Pansu et al. 2001).

The boron in the extracts can also be measured by a selective electrode for  $\text{BF}_4^-$  ions. This method requires a rather long conversion into tetrafluoroborate ions (Keren 1996) and the electrodes cannot be used in situ.

A number of colorimetric methods have also been proposed to titrate boron using carmine, curcumin and azomethine-H. The latter was chosen by Rhoades (1982) for saline soils and for the standard NF X31-122 (1993).

### **Colorimetry with Azomethine-H**

#### **Reagents**

- Buffer solution to mask interferences: 400 mL deionized water, 250 g ammonium acetate, 125 mL glacial acetic acid, 15 g ethylene diamine tetraacetic acid (EDTA).
- Azomethine-H colour reagent: 0.5 g azomethine-H, 1g L-ascorbic acid in 100 mL deionized water (prepare before each analysis).
- Standard stock solution  $100 \text{ mg (B) L}^{-1}$ : 0.572 g of boric acid in 1,000 mL water.
- Standard range of calibration between 0 and  $4 \text{ mg (B) L}^{-1}$ : by dilution of the stock solution.

#### **Procedure**

- In a plastic test tube add:
  - 1 mL of aqueous extract or standard solution or water (blank assay)
  - 2 mL of buffer solution (for masking); mix well
  - 2 mL of azomethine reagent
- Agitate well, let stand for 1h in the refrigerator and measure absorbance at 420 nm.

**Note**

Because of the risk of contamination, glass should not be used for the titration of boron. Polypropylene is recommended instead.

**18.3.8 Titration of Extractable Anions by Ionic Chromatography****Principle**

Ionic chromatography is the most efficient method for titration of aqueous extracts. Depending on the column and operating conditions, it can be used either for the simultaneous analysis of cations, or for that of anions. It is useful for cations when atomic spectrometry is not available. In aqueous extracts, the simultaneous analysis of anions is less time-consuming than sequential methods of titration of each anion (cf. Sects. 18.3.5–18.3.7). However, the most widely used techniques do not allow simultaneous titration of carbonates and bicarbonates with other anions because carbonate and bicarbonate are involved in the composition of the eluent. It is possible to adapt the method, but instead we recommend the acidimetric technique for titration of alkalinity described in Sect. 18.3.5. Another problem can appear due to masking of certain peaks by too high concentrations of one element, e.g. chlorides in certain saline soils. One possible solution is to use the operating conditions described below which give a chloride peak that is clearly separated from the others (Fig. 18.2).

**Minimum Equipment**

- Ionic chromatograph with constant flow, without gradient programming, work pressure 150 bars, equipped with:
  - (a) Injection loop of 10, 25 or 50  $\mu\text{L}$
  - (b) Guard column, OmniPac PAX-100 (Dionex, Sunnyvale CA, USA), or similar
  - (c) Analytical column, OmniPac PAX-100 (Dionex), or similar
  - (d) Anion membrane suppressor
  - (e) Conductimetric detector
- 0.2  $\mu\text{m}$  filtration system suitable for large volumes (eluent) and a 1 mL syringe equipped within-line microfiltration with a filtration membrane of 0.2  $\mu\text{m}$  (Pansu et al. 2001)
- Microbubble input of ultrapure helium

### Reagents

- Ultrapure Water (resistivity >18 Mohms) filtered at 0.2  $\mu\text{m}$  and degassed under helium.
- Eluent: 3.9 mmol ( $\text{NaHCO}_3$ )  $\text{L}^{-1}$ , 3.1 mmol ( $\text{Na}_2\text{CO}_3$ )  $\text{L}^{-1}$ , 5%  $\text{CH}_3\text{OH}$ : in a 5 L volumetric flask, mix 1.638 g of pure dry  $\text{NaHCO}_3$  and 1.643 g of pure dry  $\text{Na}_2\text{CO}_3$ , add 250 mL pure methanol, dissolve and complete to 5 L with ultrapure water.
- Regenerating 12.5 mmol  $\text{L}^{-1}$  sulphuric acid solution: in a 5 L volumetric flask add 1 L of ultrapure water, 3.472 mL of ultrapure 18 mol ( $\text{H}_2\text{SO}_4$ )  $\text{L}^{-1}$  sulphuric acid, agitate and complete to 5 L with ultrapure water.
- Standards for multi-anion calibrations of type:

$\text{Cl}^-$	0.1–15 $\text{mg L}^{-1}$ ,
$\text{NO}_3^-$	0.02–1 $\text{mg L}^{-1}$ ,
$\text{SO}_4^{2-}$	0.05–10 $\text{mg L}^{-1}$ ,
$\text{PO}_4^{3-}$	0.1–5 $\text{mg L}^{-1}$ ,
$\text{F}^-$	0.1–5 $\text{mg L}^{-1}$ .

### Procedure

- Connect or check the connections of the chromatography circuit: injection loop, guard column, column, suppressor, conductimetric detector.
- Check the connection of the regenerating circuit on the suppressor.
- Degas eluent by bubbling with helium.
- Start the pump at high pressure, regulate the eluent flow at 1  $\text{mL min}^{-1}$  (input pressure 100–130 bars).
- Regulate the flow of regenerating solution at 7  $\text{mL min}^{-1}$  under pressure of nitrogen.
- Start the detector and let the system stabilize. The base line of the chromatogram must be stable with a conductivity of background noise of approximately 20  $\mu\text{S}$ .
- Inject a standard mixture using a 1 mL syringe with in-line microfiltration. Wait approximately 10 min until the output of the chromatogram is complete before injecting the following solution for calibration or measurement.

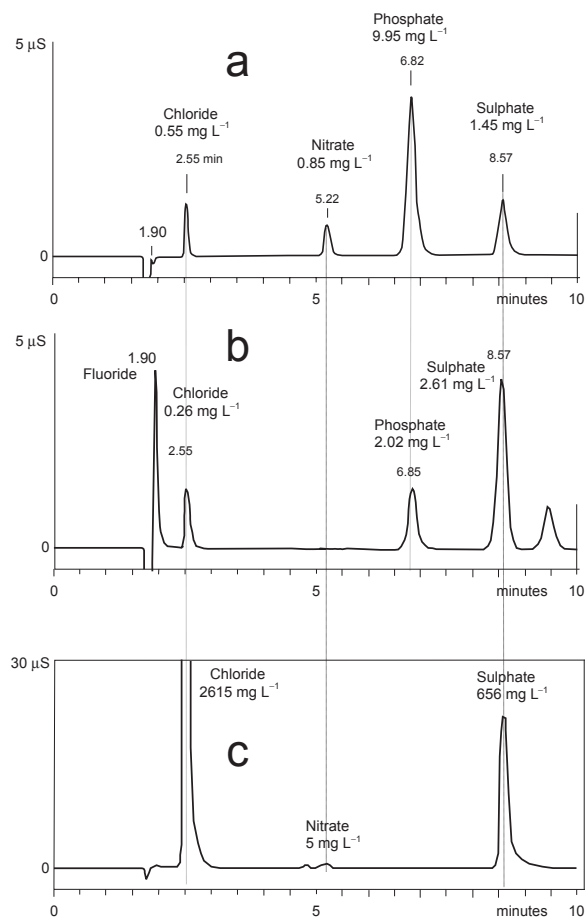

**Fig. 18.2.** Analysis of soluble anions of soils by ionic chromatography (Doubeau and Rochette, IRD Montpellier, France, unpublished data). (a) cold water extract ( $10 \text{ g } 200 \text{ mL}^{-1}$ , agitate for 4 h) of a *Luvisol* (*Hapludalf*) developed on loess, cultivated at Boigneville (France), injection without dilution (b) hot water extract of the *a-Luvisol* previously extracted with cold water (reflux boiling for 16 h), injection without dilution (c) 1:5 extract at  $20^\circ\text{C}$  of a surface horizon of a chloruro-sulphated *Salisol* (*Maison de la Nature*, Latte, France), 1:50 dilution of the extract before injection. The contents are those of the undiluted extract.

Using a syringe with in-line filtration, filter the sample solutions and if necessary dilute them before injection. In case of doubt about the concentrations, start with diluted solutions (1/200, 1/50, etc.).

Figure 18.2 shows an example of chromatograms obtained under these conditions on extracts with cold water “a” and hot water “b” of *L. uvisol* (*Hapludalf*) developed on loess cultivated in an experimental station (ITCF, Boigneville, Essonne, France) as well as a cold water extract “c”

of a chloruro-sulphated *Salisol* from a Mediterranean sedimentary lagoon. Extract “c” had to be diluted 50 times and the sensitivity reduced by a factor of 6 compared to the “a” and “b” extracts injected without dilution. These conditions did not prevent titration of nitrates of extract “c” in spite of the fact the nitrate content was 8 times lower (dilution 1:50) than that of extract “a” and in the presence of a chloride content that was 5,000 times higher. This method can be used in a very broad range of concentrations for different types of soils and studies.

### 18.3.9 Expression of the Results

**Table 18.3.** Example of ion balance (Fig. 18.2c), 1:5 extract of a Mediterranean chloruro-sulphated *Salisol* (Szwarc, CIRAD, Montpellier, France, unpublished data)

pH	EC dS m <sup>-1</sup>	cations mmol (+) L <sup>-1</sup> (extract)					anions mmol (-) L <sup>-1</sup> (extract)			
		Ca	Mg	K	Na	NH <sub>4</sub>	Cl	SO <sub>4</sub>	NO <sub>3</sub>	HCO <sub>3</sub>
7.63	8.18	9.80	19.18	1.04	60.30	0.06	73.66	13.66	0.08	1.48
(4)		Σ+ = 90.38 = 11.05 EC					Σ- = 88.88 = 10.89 EC			
		cations mg L <sup>-1</sup> (extract)					anions mg L <sup>-1</sup> (extract)			
		196	233	41	1,387	1	2,615	656	5	90
(4')		total dissolved materials = 5,224 mg L <sup>-1</sup> = 639 EC								
		cations mmol (+) kg <sup>-1</sup> (soil)					anions mmol (-) kg <sup>-1</sup> (soil)			
		49.0	95.9	5.2	301.5	0.3	368.3	68.3	0.4	7.4
		cations mg kg <sup>-1</sup> (soil)					anions mg kg <sup>-1</sup> (soil)			
		980	1,165	205	6,935	5	13,075	3,280	25	450

The expression of the data in milli-equivalents per litre of extract enables immediate verification of the coherence of the results, especially when different methods of measurement are used (Ludwig et al. 1999). The sum of the cations (Σ+) must be equal to the sum of the anions (Σ-) and (18.4) must be checked, that is to say the double equality:

$$(\Sigma+) = (\Sigma-) = (10-12) \text{ EC} \quad (18.10)$$

The results can also be expressed based on the soil. *n* is the ratio of the volume of water of the extract (mL) to the weight of the soil test specimen in grams (cf. “Comparative Interest” under Sect. 18.2.3). The soil contents (*T*s in mmol (+) kg<sup>-1</sup> or mmol (-) kg<sup>-1</sup>) are expressed

compared to those of the extract ( $Te$  in mmol (+)  $L^{-1}$  or mmol (-)  $L^{-1}$  by the simple relation:

$$Ts = n Te \quad (18.11)$$

$M$  being the equivalent molar mass of each ion, the results can also be expressed in  $mg L^{-1}$  (extract) by the relation  $Te$  ( $mg L^{-1}$ ) =  $M Te$  (mmol (+ or -)  $L^{-1}$ ). Thus the balance with the TDS and (18.4') must be checked if TDS are measured (cf. Sect. 18.3.3). Equation 18.11 remains valid to calculate the extractable masses of the soil, with  $Ts$  in  $mg kg^{-1}$  and  $Te$  in  $mg L^{-1}$ .

The results corresponding to the example (Fig. 18.2c) of an ion balance on 1:5 extracts of a chloruro-sulphated soil from Latte (France), are shown in Table 18.3.

## References

- Baize D (1988) Guide des analyses courantes en Pédologie. INRA, Paris, 172 p.
- Boivin P, Hachicha M, Job JO and Loyer JY (1989) Une méthode de cartographie de la salinité des sols : conductivité électromagnétique et interpolation par krigeage. *Sci. du sol.*, 27, 69–72
- Bouteyre G and Loyer JY (1995) Sodisols et Salsodisols. In *Encyclopaedia Universalis*, 235–236
- Bower CA and Wilcox LV (1965) Soluble salts. In *Methods of Soil Analysis, Part 2, Chemical and Microbiological Properties*, Black CA ed. ASA, SSSA, Madison, USA
- Cheverry C (1974) *Contribution à l'étude pédologique des polders du lac Tchad. Dynamique des sels en milieu continental sub-aride dans des sédiments argileux et organiques.*, These University Strasbourg, France, 275 p
- Cheverry C (1983) L'extraction de la solution du sol par le biais de bougies poreuses : synthèse bibliographique des problèmes méthodologiques posés par ces dispositifs. *Bull. Groupe Français d'Humidité Neutronique*, 14, 47–71
- Cheverry C (1998) Agriculture intensive et qualité des eaux. *INRA, Paris*, 297p
- Corwin DL and Lesch SM (2004) Characterizing soil spatial variability with apparent electrical conductivity. *Computers and Electronics in Agriculture*, doi:10.1016/j.compag.2004.11.002
- FAO, ISSS, ISRIC (1998) World Reference Base for Soil Resources. *World Soil Resources Reports*, FAO, Rome no 84, 88 p
- Harvie CE and Weare JH (1980) The prediction of mineral solubilities in natural waters : the Na-K-Mg-Ca-Cl-SO<sub>4</sub>-H<sub>2</sub>O system from zero to high concentration at 25°C. *Geochim. Cosmochim. Acta.*, 44, 981–997



- Harvie CE, Moller NE and Weare JH (1984) The prediction in mineral solubilities in natural waters : the Na-K-Mg-Ca-H-Cl-SO<sub>4</sub>-OH-HCO<sub>3</sub>-CO<sub>3</sub>-CO<sub>2</sub>-H<sub>2</sub>O system to high ionic strengths at 25°C, *Geochim. Cosmochim. Acta.*, 48, 723–751
- INRA-AFES, (1995) *Référentiel Pédologique.*, INRA, Paris, 332 p
- Job JO (1985) *Essais de corrélation entre la conductivité électrique et la composition ionique des solutions du sol.*, ENSAM-USTL, Montpellier, France, 86 p.
- Job JO Gonzalez Barrios JL and Rivera Gonzalez M (1997) Détermination précise de la salinité des sols par conductivimétrie électromagnétique. In *Géophysique des sols et des formations superficielles.*, Orstom, Paris, 143–145
- Keren R (1996) Boron. In *Methods of Soil Analysis, Part 3, Chemical Methods.*, SSSA book series 5, 603–626
- Kouakoua E , Sala GH , Barthès B , Larre-Larrouy MC , Albrecht A and Feller C (1997) La matière organique soluble à l'eau chaude et la stabilité de l'agrégation. Aspects méthodologiques et application à des sols ferrallitiques du Congo, *Eur. J. Soil Sci.*, 48, 239–247
- Le Brusq JY and Loyer JY (1982) Relations entre les mesures de conductivités sur des extraits de sols de rapports *sol/solution* variables, dans la vallée du fleuve Sénégal. *Cah. Orstom, sér. Pédol.*, 3, 293–301
- Loyer JY and Susini J (1978) Réalisation et utilisation d'un ensemble automatique pour la mesure en continu et in situ du pH, du Eh et du pNa du sol. *Cah. ORSTOM.Sér. Pédologie*, 16, 425–437
- Loyer JY (1991) Classification des sols salés : les sols *Salic.* *Cah. Orstom Ser. Pédol.*, XXVI, 51–61
- Ludwig B, Meiwes KJ, Gehlen R, Fortmann H, Hildebrand EE and Khanna P (1999) Comparison of different laboratory methods with lysimetry for soil solution composition - experimental and model results. *Zeitschrift für Pflanzenernährung und Bodenkunde*, 162, 343–351
- NF X 31-122, (1993) Extraction du bore soluble à l'eau bouillante. In *Qualité des sols, 3<sup>e</sup> ed.*, AFNOR, Paris, 91–95
- NF ISO 11265, (1995) Détermination de la conductivité électrique spécifique. In *Qualité des sols, 3<sup>e</sup> ed.*, AFNOR, Paris, 279–282
- Pansu M, Gautheyrou J and Loyer JY (2001) Soil Analysis - Sampling, Instrumentation and Quality control. Balkema, Lisse, Abington, Exton, Tokyo, 489 p
- Paycheng C (1980) *Méthodes d'analyses utilisées au laboratoire commun de Dakar*, IRD-Orstom, Dakar, Paris, 104 p
- Pouget M (1968) Contribution à l'étude des croûtes et encroûtements gypseux de nappe dans le Sud Tunisien. *Cah. Orstom, sér. pédol.*, 3–4, 309–366
- Qadir M, Schubert S and Ghafoor Aet Murtaza G (2001) Amelioration strategies for sodic soils: A review. *Land degradation and development*, 12, 357–386
- Rhoades JD and Miyamoto S (1990) Testing soils for salinity and sodicity. In *Soil Testing and Plant Analysis, 3rd ed.*, SSSA book series 3, 299–336

- Rhoades JD and Oster JD (1986) Solute content. In *Methods of soil analysis, part 1, Physical and Mineralogical Methods, 3rd ed.*, ASA-SSSA, Agronomy monograph 9, 985–1005
- Rhoades JD (1982) Soluble salts. In *Methods of soil analysis, Part 2, Chemical and Microbiological Properties, 2nd ed.*, ASA-SSSA, Agronomy monograph 9, 167–179
- Rhoades JD (1996) Salinity : electrical conductivity and total dissolved solids. In *Methods of Soil Analysis, Part 3, Chemical Methods.*, SSSA book series 5, 417–433
- Richards LA ed (1954) *Diagnosis and Improvement of Saline and Alkali Soils*, US Salinity Laboratory Staff. Agricultural Department, Handbook no 60
- Sá SMO, Sartini RP, Oliveira CC and Zagatto EAG (2002) A flow-injection system with a quartz crystal microbalance for the determination of dissolved inorganic carbon in mineral waters. *J. Flow Injection Anal.*, 19, 25–28
- Servant J (1975) *Contribution à l'Etude des Terrains Halomorphes.*, Inra, Ensa Montpellier, 194 p. et annexes
- Shirokova Y, Forkutsa I and Sharafutdinova N (2000) Use of electrical conductivity instead of soluble salts for soil salinity monitoring in Central Asia. *Irrigation-and-Drainage-Systems*, 14, 199–205
- Simon M and Garcia I (1999) Physico-chemical properties of the soil-saturation extracts: estimation from electrical conductivity *Geoderma*, 90. 99–109
- Smith JL and Doran JW (1996) Measurement and use of pH and electrical conductivity for soil quality analysis. In *Methods for Assessing Soil Quality*, SSSA special publication. 49, 169–185
- Susini J and Nedhir M (1980) *Utilisation d'électrodes sensibles aux ions pour la mesure en continu, avec enregistrement du pH, pNa, pCl, pCa + Mg dans l'étude des eaux d'irrigation et de drainage et essais dans les sols : 1ère partie. Réalisation et description de l'ensemble de mesure.*, DRES, Orstom, Tunis (TN), 17 p
- Susini J, Rouault, M and Kerkeb A (1972) Essais d'utilisation en analyse des sols salés d'une électrode sensible aux ions sodium, *Cah. ORSTOM. Sér. Pédologie*, 10, 309–318

## Exchange Complex

### 19.1 Introduction

Soil is a dynamic complex of solid, liquid and gas phases. During its evolution under the influence of geological, biological, climatic and hydrological constraints, the soil acquires electric and electromagnetic charges which confer specific physicochemical and thermodynamic properties. These charges are of different origin and different scales i.e. colloidal, molecular and atomic. Some occur during the deterioration and formation of secondary substances like clays, aluminosilicates, oxides and humified organic matter (pedogenesis).

The soil thus appears in the form of a *continuum* that is heterogeneous at a given scale. It is an open medium in a state of precarious and evolutionary equilibrium subject to cycles of immobilization and release of ionic species that vary with the climatic constraints. Its properties can be more or less arbitrarily gathered in analytical pools because of the similarity of the *mutatis–mutandis* phenomena in the biosphere. Among these phenomena, the entity represented by the exchange complex (or adsorbing complex) is of primary importance because of its direct influence on intrinsic soil fertility and soil chemical processes. In a wet tropical medium, the intense biochemical activity, which is sometimes coupled with intensive agriculture, considerably accelerates the weathering processes.

For the chemist, the vast analytical field represented by interactions between charges includes measurements of cation and anion exchange capacities, exchangeable cations, exchange isotherms, exchange acidity and its agronomic correction, (lime amendments), exchangeable sodium and sodium adsorption ratio (SAR), exchange of anions like phosphates, the measurement of isoelectric point or zero point charge (ZPC), permanent and variable charges, entropies and free enthalpies, dispersion, flocculation, electrophoretic mobility, Zeta potential, Brownian movement, as well as interrelationships with pH and Eh.

## 19.2 Origin of Charges

### 19.2.1 Ionic Exchange

The discovery of ion exchange dates back to 1848–1850. Thomson (1850) observed that leaching a soil column with an ammonium sulphate solution led to the appearance of calcium sulphate in the filtrate. Way (1850–1852), a chemist who belonged to the Royal Company of English Agriculture, published the first work on cation exchange:

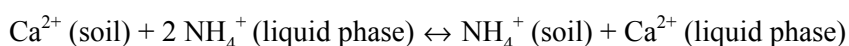

Theoretical studies continued to appear, those particularly worth mentioning are: Bolt (1982), Gabis and Lagache (1982), Sparks (1986), Sposito (1981–1984–1989), Chamayou and Legros (1989), Fenton and Helyar (2000).

During weathering processes some primary or secondary components pass into the soil solution resulting in the creation of site vacancies and/or the creation of new surfaces resulting in the disruption of local equilibriums. Reactions between components of the liquid phase and liquid phase–solid phase are not always instantaneous but depend on the nature of chemical functions, free surface energy, critical surface tension, etc.

Various phenomena can be observed in this ionic reservoir such as adsorption–desorption, chelation with organic and inorganic ligands, dissolution or precipitation at the solid–liquid interfaces.

The combination of atoms and plans of atoms results in the creation of atomic lattices and structural units such as those of the phyllosilicates whose charge is well defined (Table 19.1). However, as the reactions are not rigorously stoichiometric, defects appear and substitutions occur in the internal structure of minerals, modifying the distribution of charges and the nature of the components. In addition, the surfaces of minerals and organic functional groups can ionize and generate new charges. For example, unhydrated micas, whose cation exchange capacity (CEC) is theoretically null, can open during the weathering process (Fig. 19.1) to give first hydrated forms of increasing CEC and second vermiculites with a high exchange capacity according to the models presented by Dawson et al. (1974) and Jackson and Juo (1986).

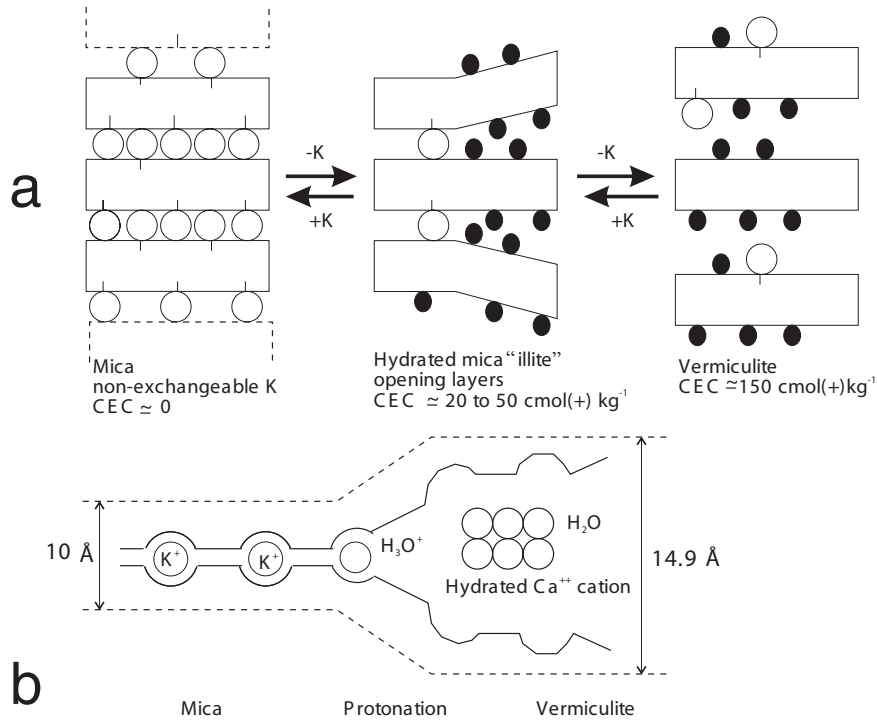

**Fig. 19.1.** Models of deterioration of micas: **a:** Dawson et al. (1984), **b:** Jackson and Juo (1986)

### 19.2.2 Exchange Complex

All solid, liquid or gas material is made of atoms comprising elementary particles which, for the chemist, can be limited to protons, neutrons and electrons. The unit is electrically neutral but if an electron leaves an atom (transfer of electron of the external layer), it causes an electric imbalance, the nucleus then taking the charge  $+e$  and becoming a positively charged ion (cation). Conversely, an electron fixed on the atom (complement of the external layer) brings an additional negative charge that characterizes the charge of the unit (anion).

As atoms are bound by electrostatic forces, they join together to form ionic assemblies, which are easily identifiable thanks to their crystal properties or to their short-range organization, and are the result of atomic bonds corresponding to equilibrium between attracting and repelling forces (Fig. 19.2). The interpenetration of the electron shells, with pooling of electrons, gives covalent atomic bonds that are limited to the number of available electrons in the external layer.

**Table 19.1.** Classification of clays linked to their theoretical negative charges by layer (*Agence internationale pour l'étude des argiles AIPEA*)

clay	octahedral layer	negative charges
1 :1	kaolinite	0
	serpentine	0
2 :1	pyrophyllite	0
	talc	0
	hydrated micas	2
		2
	smectites	0.5–1.2
		0.5–1.2
	vermiculites	1.2–1.9
		1.2–1.9
2 :1 :1	chlorites	variable
		variable
		variable
	fibrous clays	variable
	allophane–Imogolite	variable

Weathering processes in the soil induce changes from ionic states to colloidal mesomorphic states (which have not all been clearly defined to date), then into states that are invisible to X-ray where the compounds acquire a short-range organization and then again start to acquire a long-organization and finally a crystalline state. The scale of time of each one of these states depends on climatic, geological and biological variables and can vary from a few days to a few millennia.

Electrically charged surfaces of materials present either an excess or a deficit of electrons. Whatever the origin of the surface charges, their neutralization necessitates the introduction of an equal quantity of positive and negative charges in the liquid phase, i.e. the soil solution.

Exchange theory cannot cover every possible case. Several different equations are needed because of the complexity and diversity of the exchange phenomena. For modelling purposes, the most influential parameters are retained after successive approximations. The thermodynamic approach can be used to integrate mass action laws, selectivity of equilibrium constants or to choose to retain some mechanisms of adsorption at the solid–liquid interfaces, quantification of ion transfers, anion interactions, etc.

It is important to take into account the reference works that first established current theories. These theories are concerned with the solid exchange matrix, the soil solution or the mobile phase (extracting reagents: surface charges, colloidal stability, rheological properties, ionic properties, selectivity, concentration, valence, pH and their interrelation-ships).

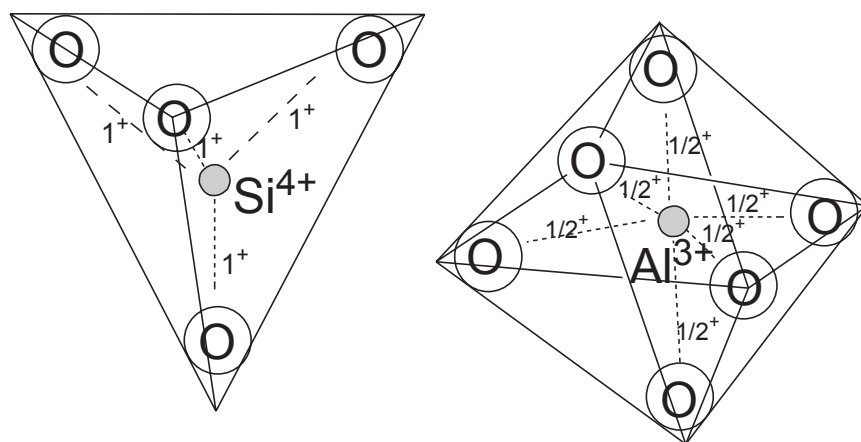

**Fig. 19.2.** Fundamental units of clays

Pioneer scientists like Helmholtz (1835), de Quincke (1861), Gibbs (1906), Gouy (1910), Chapman (1913), Freundlich (1916), Stern (1924), Mattson (1926), Jenny (1926), Pauling (1927), Kerr (1928), Vageler (1932), Vanselow (1932), Gapon (1933), Langmuir (1938) gave their name to the reference equations cited in the following chapters.

Exchange phenomenon represents a transfer of ions between a solid exchanger and an index ion in liquid phase or a chemical phenomenon related to the application of the law of mass action.

### 19.2.3 Theory

Despite certain imperfections, the theory of the double layer (Fig. 19.3) of Gouy (1910), Chapman (1913) and Stern (1924), seems to correspond more satisfactorily to the reality of soil charges than the Donnan equilibrium.

The theory of the double layer applies to ion exchanges and links the soil cationic charge, the electrolyte concentration and the electric potential. The applied forces are exerted within a lattice of short-range organization, without a very clear definition of the atomic distances in spite of conceptual advances which have modified the original theory published by Gouy (1910). In the Gouy and Chapman model, the charges  $\sigma$  are considered to be uniformly distributed on the exchanger surface

which constitutes an infinite plan. In clay, this plan is charged negatively and the law of electric neutrality implies the attraction of the same quantity of positively charged cations.

The cluster of ions brought by the liquid mobile phase cancels the electric force field. However, the diffusion forces tend to redistribute the ions: the cationic contents decrease exponentially starting at the surface, and consequently there is a deficit of anions near this surface. The charged surface and the redistribution phenomenon make up the double layer theory. Its quantitative application is of doubtful validity in the case of soils with variable charge, the ions being regarded as concentrated charges, without taking the counter ions into account. The theory gives too high predictions.

The theory of Stern (1924) corrects these excesses by supposing that, given their volume, the ions likely to come into contact with a surface can do so only at the distance of a few angstroms (Fig. 19.3).

The ions adsorbed on the surface form a compact layer of the same thickness as the ionic diameter, and the diffuse layer of Gouy and Chapman comes after the compact layer. This model enables differentiation of high affinities of specific adsorption which refer to a chemisorption phenomenon (coordination) and low affinities of adsorption which refer to the Stern layer. The approach is generally sufficient for soils with permanent charges.

In the case of soils with a variable charge, the model of triple layers with four plans (Bowden et al. 1977, 1980, Sposito 1984) enables calculations to be refined and extended to reactions of surface complexation (Fig. 19.3):

- protons and hydroxyls form inner-sphere surface complexes; these complexes are bound by ionic or/and covalent bonds; there are no solvent molecules between the surface of the functional group and the adjacent molecule
- the other organic and inorganic cations and anions form less stable outer-sphere complexes, bonded by electrostatic bonds, with a solvent molecule between the functional group and the bonded molecule.

The knowledge of sorption phenomena is essential in pedology and agronomy in order to understand short and medium term evolution of soil under given climatic conditions and possibly to correct some forms of degradation.



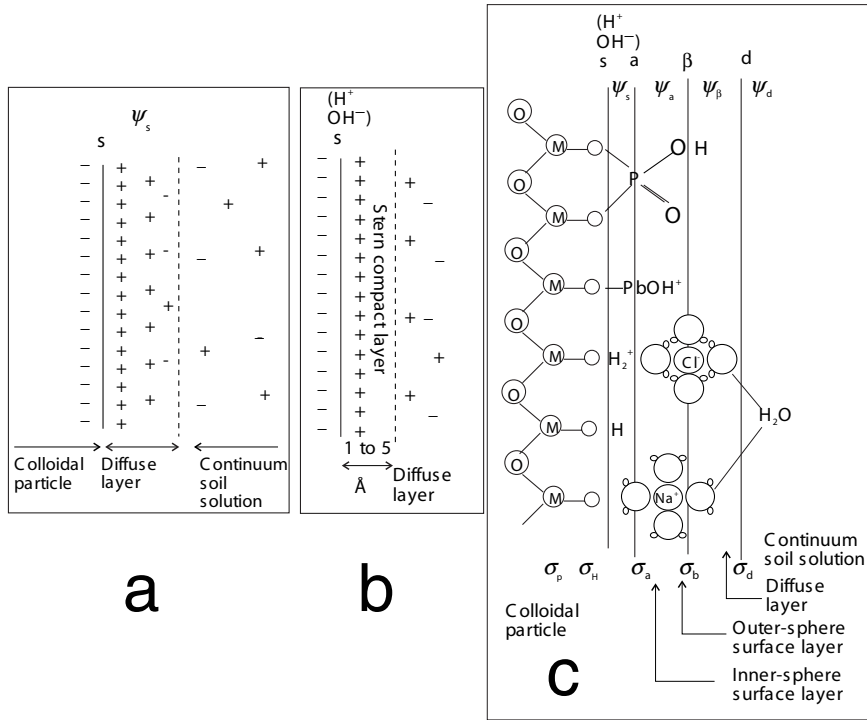

Fig. 19.3. Theoretical models of exchange sites

- a: the model of Gouy and Chapman (1910–1913) defines the sites as a simple plan with a decrease in the electric potential linked the distance of the colloid surface:  

$$\psi = \sigma \frac{F}{C}$$
 where  $\sigma$  is the surface charge in mole  $cm^{-2}$ ,  $C$  is the capacitance in Farad  $m^{-2}$  and  $F$  is the Faraday constant. The size of the counter ion is not taken into account.
- b: the model of Stern (1924) is defined as a simple plan taking into account the complexes of surface formed with the hydrated ions (specific and nonspecific adsorptions), total charge  $\sigma_t = \sigma_i + \sigma_n$
- c: model with three layers and four plans according to Sposito (1984), Bowden et al. (1977–1980). This model satisfactorily describes the selective adsorption of anions (phosphate, seleniate, citrate, sulphate, fluoride, silicate) or of cations (e.g. Cu, Pb, Zn) as well as effects like electrolyte concentration or electrophoretic mobility.

## References

- Bolt GH and Bruggenwert MGM (1982) *Soil chemistry A – Basic elements.*, Elsevier developments in soil science, 5A
- Bowden JW, Posner AM and Quirk JP (1977) Ionic adsorption on variable charge mineral surfaces theoretical charge development and titration curves. *Austr. J. Soil Res.*, 15, 121–136
- Bowden JW, Nagarajah S, Barow NJ, Posner AM and Quirk JP (1980) Describing the adsorption of phosphate, citrate and selenite on a variable-charge mineral surface. *Austr. J. Soil Res.*, 18, 49–60
- Chamayou M and Legros JR (1989) *Les bases physiques, chimiques et minéralogiques de la science du sol.*, Presses Universitaires de France.
- Chapman DL (1913) A contribution to the theory of electrocapillarity. *Philos. Mag.*, 6, 475–481
- Dawson M, Foth MD, Page AL and McLean EO (1974) *Cation exchange properties of soils. A slide show.* Div. S-2. *Soil Chemistry.*, Soil Science Society of America, 8 p + 45 diapositives couleur
- Fenton G and Helyar KR (2000) Soil acidification, in PEV Charman and BW Murphy (eds), *Soils: Their Properties and Management*, Oxford University Press, Melbourne
- Freundlich H (1926) *Colloid and capillary chemistry.*, Metwuen London.
- Gabis V. and Lagache M (1982) Les surfaces des solides minéraux ; adsorption: 109-179 ; l'échange d'ions. 297–353. *Soc. Fr. de Minéralogie et cristallographie*, 1–2
- Gouy G (1910) Sur la constitution de la charge électrique à la surface d'un électrolyte. *J. Ann. Phys.*, 457, 457–468
- Jackson M.L. and Juo J.X (1986) Potassium-release mechanism on drying soils: iron exchangeable to exchangeable potassium by protonation of micas. *Soil Sci.*, 141, 225–229
- Sparks D.L (1986) *Soil physical chemistry.* CRC Boca Raton, FL 308 p
- Sposito G (1981) *The thermodynamics of soils solutions.*, Clarendon Oxford, 223 pages
- Sposito G (1984) *The surface chemistry of soils.*, Clarendon Oxford, 234 p
- Sposito G (1989) *The chemistry of soils.* Oxford University Press, Oxford 277 p
- Stern O (1924) Zur theorie der elektrischen doppelschicht. *Z. Elektrochem*, 30, 508–516
- Thomson HS (1850) On the absorbent power of soils. *J. Royal Agric. Soc. Engl.*, 11, 68–74
- Way JT (1850) On the power of soils to absorb manure. *J. Royal Agric. Soc. Eng.*, 11, 311–379
- Way JT (1852) On the power of soils to absorb manure. *J. Royal Agric. Soc. Eng.*, 13, 123–143

## Chronobibliography

- Johnson SW (1859) On some points of agricultural science. *Am. J. Sci. Arts*, 2, 71–85
- Freundlich H (1926) *Colloid and capillary chemistry*, Methuen, London.
- Page JB and Bauer LB (1940) Ionic size in relation to fixation of cations by colloidal clay. *Soil Sci. Soc. Am. Proc.*, 4, 150–155
- Hendricks SB., Nelson RA and Alexander LI (1940) Hydration mechanism of the clay mineral montmorillonite saturated with various cations. *J. Am. Chem. Soc.*, 62, 1457–1464
- Barshad I (1948) Vermiculite and its relation to biotite as revealed by base exchange reaction, X-Ray analysis, differential thermal curves and water content. *Am. Miner.*, 33, 655–678
- Mehrlich A (1948) Determination of cation and anion-exchange properties of soils. *Soil Sci.*, 66, 429–445
- Standford G (1948) Fixation of potassium in soils under moist conditions and on claying in relation to type of clay mineral. *Soil Sci. Soc. Am. Proc.*, 12, 167–171
- Schofield RK (1949) Effect of pH on electric charges carried by clay particles. *J. Soil Sci.*, 1, 1–8
- Wear JL and White JL (1951) Potassium fixation in clay minerals as related to crystal structure. *Soil Sci.*, 71, 1–14
- Bolt GH (1952) *The significance of the measurement of the zeta potential and the membrane potential in soil and clay suspensions.*, Master thesis Cornell University
- Overbeek J Th (1952) Electrochemistry of the double-layer. *Colloid Sci.*, 1, 115
- Pratt PF and Holowaychuck NA (1954) A comparison of ammonium acetate, barium acetate and buffered barium chloride methods of determining cation-exchange capacity. *Soil Sci. Soc. Am. Proc.*, 18, 365–368
- Schofield RK and Samson HR (1954) Flocculation of kaolinite due to the attraction of oppositely-charged crystal faces. *Disc. Faraday Soc.*, 18, 138–145
- Bolt GH (1955) Analysis of the validity of the Gouy–Chapman theory of the electric double layer. *J. Colloid Sci.*, 10, 206–218
- Schuffellen AC and Van der Marel HW (1955) Potassium fixation in soils. *Potass. Symp.*, 2, 157 (180 references)
- Diamond S and Kinter EB (1956) Surface areas of clay minerals as derived from measurements of glycerol retention. *Clays Clay Miner.*, 5, 334
- De Mumbrum LE and Jackson ML (1957) Formation of basic cations of copper, zinc, iron and aluminium. *Soil Sci. Soc. Am. Proc.*, 21, 662
- White ML (1957) The occurrence of zinc in soil. *Econ. Geol.*, 52, 645
- Garrett WG and Walker GF (1959) The cation exchange capacity of hydrated halloysite and the formation of halloysite-salt complexes. *Clay Miner. Bull.*, 4, 75–80

- Johansen RT and Dunning HN (1959) Water-vapor adsorption on clay. *Clays Clay Miner.*, 6, 249
- Van der Marel HW (1959) Potassium fixation, a beneficial soil characteristic for crop production. *Z. Pflanzenernahrung dungung, Bodenkunde*, 84, 51–62
- Giles CH, Maewan TH, Nakhwa SN and Smith D (1960) Studies in adsorption XI. A study of classification of solution adsorption isotherms and its use in diagnosis of adsorption mechanisms and in measurement of specific surface area of solids. *J. Chem. Soc.*, 3973
- Hsu PH and Rich CI (1960) Aluminium fixation in a synthetic cation exchanger. *Soil Sci. Soc. Am. Proc.*, 24, 21–25
- Rich CI (1960) Aluminium in interlayers of vermiculite. *Soil Sci. Soc. Am. Proc.*, 24, 26–32
- Toujan S (1960) Essai de distribution analytique entre sels solubles et cations changeables en sols alcalins sals. *Cah. ORSTOM Sr. Pdol.*, X, 25
- Pratt PF (1961) Effect on pH on the cation exchange capacity of surface soils. *Soil Sci. Soc. Am. Proc.*, 21, 96
- Dixon JR and Jackson ML (1962) Properties of intergradient chlorite-expandable layer silicates of soils. *Soil Sci. Soc. Am. Proc.*, 26, 358–362
- Shen MJ and Rich CI (1962) Aluminium fixation in montmorillonite. *Soil Sci. Soc. Am. Proc.*, 86, 33–36
- Babcock KL (1963) Theory of the chemical properties of soil colloidal systems at equilibrium. *Hilgardia*, V, 11
- Bower CA (1963) Adsorption of o. phenanthroline by clay minerals and soils. *Soil Sci.*, 95, 192
- Coleman NT, Craig D and Lewis RJ (1963) Ion exchange reactions of cesium. *Soil Sci. Soc. Am. Proc.*, 27, 287–289
- Coleman NT, Lewis RJ and Craig D (1963) Sorption of cesium by soils and its displacement by salt solution. *Soil Sci. Soc. Am. Proc.*, 27, 290–294
- Bear FE (1984) *Chemistry of the soil*, Reinhold
- Bingham FT, Page AL and Sims JK (1964) Retention of Cu and Zn by H-Montmorillonite. *Soil Sci. Soc. Am. Proc.*, 28, 351–354
- Coleman NT and Thomas GW (1964) Buffer curves of acid clays as affected by the presence of ferric iron and aluminum. *Soil Sci. Soc. Am. Proc.*, 28, 187–190
- Greenland DJ and Quirk JP (1964) Determination of total specific surface areas of soils by absorption of cetyl pyridinium bromide. *J. Soil Sci.*, 15, 178
- Helling CJ, Chesters G and Corey RB (1964) Contribution of organic matter and clay to soil cation exchange capacity as affected by the pH of the saturating solution. *Soil Sci. Soc. Am. Proc.*, 28, 517
- Marshall CE (1964) *The physical chemistry and mineralogy of soils.*, Wiley New York
- McLean EO, Hourigan WR, Shoemaker HE and Bhumbra DR (1964) Aluminum in soils: V Form of aluminum as a cause of soil acidity and a complication in its measurements. *Soil Sci.*, 97, 119–126
- Sawhney BL (1964) Sorption and fixation of micro-quantities of Cs by clay minerals. Effect of saturating cations. *Soil Sci. Soc. Am. Proc.*, 28, 183–186

- Schnitzer M and Gupta VC (1964) Chemical characteristics of the organic matters extracted from the O and B<sub>2</sub> horizons of a gray wooded soil. *Soil Sci. Soc. Am. Proc.*, 28, 374
- Bhumbla DR and McLean EQ (1965) Aluminium in soils. VI – Changes in pH dependent acidity, cation ion exchange capacity and extractable aluminium with addition of lime to surface soils. *Soil Sci. Soc. Am. Proc.*, 29, 370
- Bolt GH and Page AL (1965) Ion-exchange equations based on double layer theory. *Soil Science*, 99, 357–361
- Carter DL, Heilman MD and Gonzalez CL (1965) Ethylene glycol monoethyl ether for determining surface area of silicate minerals. *Soil Sci.*, 100, 356
- Follet EAC (1965) The retention of amorphous colloidal “ferric hydroxide” by kaolinites. *J. Soil Sci.*, 16, 334–341
- Fripiat J.J., Cloos P and Poncelet A (1965) Comparaison entre les propriétés d’échange de la montmorillonite et d’une résine vis-à-vis des cations alcalins et alcalino-terreux. I – Reversibilité des processus. *Bull. Soc. Chim. de France*, 208–214
- Marshall CE and McDowell LL (1965) The surface reactivity of micas. *Soil Sci.*, 99, 115–131
- Parks GA (1965) The isoelectric points of solids oxides, solid hydroxides and aqueous hydroxo complex systems. *Chem. Rev.*, 65, 177–193
- Kittrick JA (1966) Forces involved in ion fixation by vermiculite. *Soil Sci. Soc. Am. Proc.*, 30, 801–803
- Shainberg I and Kemper WD (1966) Hydration status of adsorbed cations. *Soil Sci. Soc. Am. Proc.*, 30, 707–713
- Stanton DA and Burger R de T (1966) Zinc in orange free state soils. I – An assessment of the zinc status of surface soils. *S. Afr. J. Agr. Sci.*, 601
- Stanton DA and Burger R de T (1966) Zinc in orange free state soils. II - Distribution of zinc in selected soils profiles and in particle size fractions. *S. Afr. J. Agr. Sci.*, 809
- De Villiers JM and Jackson ML (1967) Cation exchange capacity variations with pH in soil clay. *Soil Sci. Soc. Am. Proc.*, 31, 473
- Parks GA (1967) Aqueous surface chemistry of oxides and couplage oxide minerals in Stumm, W. : Equilibrium concepts in natural water systems. *Adv. Chem. Series*, 67, 121–160
- Parks GM (1967) Isoelectric point and zero point charge. *Adv. in Chem.*, 67, 121–160
- Ruellan A and Deletang J (1967) *Les phénomènes d’échange de cations et d’anions dans les sols*. IRD (ex-Orstom), Doc. Techno., no. 5, Paris
- Grim RE (1968) *Clay Mineralogy*. McGraw-Hill, New York 185–233
- Murray DJ, Healy TW and Fuersteneau DW (1968) The adsorption of aqueous metal and colloidal hydrous manganese oxide. *Adv. Chem. Ser.*, 79, 74–81

- Rich CI (1968) Mineralogy of soil potassium. In Kilmer VJ, Younts S.E., Brady NC. *The role of potassium in agriculture*. Am. Soc. Agron., US, 79–108
- Flegman AW, Goodwin JW and Ottewill RA (1969) Rheological studies on kaolinite suspensions. *Proc. Brit. Ceram. Soc.*, 13, 31–45
- Gautheyrou J and Gautheyrou M (1969) Index bibliographique “Echange” 1960–1967. ORSTOM-Antilles, Notes de laboratoire, no. 10, 56 p
- Kalb GW and Curry RB (1969) Determination of surface area by surfactant adsorption in aqueous suspension. I – Dodecylamine hydrochloride. *Clays Clay Miner.*, 17, 47
- Hingston FJ (1970) *Specific adsorption of anions on goethite and gibbsite.*, Ph. D diss., University Western Australia Perth
- Sawhney BL, Frinck CR and Hill DE (1970) Components of pH dependent cation exchange capacity. *Soil Sci.*, 109, 272
- Sawhney BL (1972) Selective sorption and fixation of cations by clay minerals: a review. *Clays clay Miner.*, 20, 93–100
- Van Raj B and Peech M (1972) Electro chemical properties of some oxisols and alfisols of the tropics. *Soil Sci. Soc. Am. Proc.*, 36, 587–593
- Brace R and Matijevic E (1973) Aluminum hydrous oxide sols. I – Spherical particles of narrow size distribution. *J. Inorg. Nucl. Chem.*, 35, 3691–3705
- McLaren RG and Crawford DV (1973) Soil copper. I – fractionation of copper in soils. *J. Soil Sci.*, 24, 172
- McBride MB and Mortland MM (1974) Copper (II) interactions with montmorillonite: evidence from physical methods. *Soil Sci. Soc. Am. Proc.*, 38, 408–415
- Espinoza W, Gast RG and Adams RS Jr (1975) Charge characteristics and nitrate by two andepts from south-central Chile. *Soil Sci. Soc. Am. Proc.*, 39, 842–846
- Ferris AP and Jepson WB (1975) The exchange capacities of kaolinite and the proportion of homo-ionic clays. *J. Colloid Interface Sci.*, 51, 245–259
- Gupta SK and Chen KY (1975) Partitioning of trace metals in selective chemical fractions of nearshore sediments. *Environ. Lett.*, 10, 129
- Baes CF and Mesmer RE (1976) *The hydrolysis of cations*. Wiley, New York
- Bolland MDA, Posner AM and Quirk JP (1976) Surface charge on kaolinites in aqueous suspensions. *Aust. J. Soil Res.*, 14, 197–216
- Bolt GHM, Bruggenwert GM and Kamphorst A (1976) Adsorption of cations by soil. In *Soil chemistry A - Basic elements.*, Elsevier Amsterdam, 54–95
- Gallez A, Juo ASR and Herbillon AJ (1976) Surface and charge characteristics of selected soils in the tropics. *Soil Sci. Soc. Am. Proc.*, 40, 601–608
- Gillman GP and Bell LC (1976) Surface charge characteristics of six weathered soils from tropical N. Queensland. *Austr. J. Soil Res.*, 14, 351–360
- Herbillon AJ, Mestadgh MM, Vielvoye L and Derouane EG (1976) Iron in kaolinite with special reference to kaolinite from tropical soils. *Clay Miner.*, 11, 201–220
- Gast RC (1977) Surface and colloid chemistry. In Dixon JB, Weed SB, Kittrick JA, Milford MM, White JL. *Minerals in soils environment.*, Soil Science Society of America: 27–73

- Laverdière MM and Weaver RM (1977) Charge characteristics of spodic horizons. *Soil Sci. Soc. Am. J.*, 41, 505–510
- Sposito G and Mattigod SV (1977) On the chemical foundation of the sodium adsorption ratio. *Soil Sci. Soc. Am. J.*, 41, 323–329
- Thomas GW (1977) Historical developments in soil chemistry: ion exchange. *Soil Sci. Soc. Am. J.*, 41, 230–238
- Carr RM, Chaikum N and Paterson N (1978) Intercalation of salts in halloysite. *Clays Clay Miner.*, 26, 144–152
- Gessa C, Melis P, Bellu G and Testin C (1978) Inactivation of clay pH-dependent charge in organo-mineral complexes. *J. Soil Sci.*, 28, 58
- Gillman GP and Bell LC (1978) Soil solution studies on weathered soils from tropical North Queensland. *Austr. J. Soil Res.*, 16, 66–77
- Hendershot WH (1978) Measurement technique effects of the value of zero point of charge and its displacement from zero point of titration. *Can. J. Soil Sci.*, 58, 439
- McBride MB (1978) Copper (II) interactions with kaolinite factors controlling adsorption. *Clays Clay Miner.*, 26, 101–106
- Parfitt RL (1978) Anion adsorption by soils and soil materials. *Adv. Agronomy*, 30, 1–80
- Wann SS and Uehara G (1978) Surface charge manipulation in constant surface potential soil colloids. I – Relation to adsorbed phosphorus. *Soil Sci. Soc. Am. J.*, 42, 565–570
- Wann SS and Uehara G (1978) II – Effect on solute transport. *Soil Sci. Soc. Am. J.*, 42, 886–888
- Keng JCW (1979) *Surface chemistry of some constant potential soil colloids.*, Thesis University Hawaii
- Lindsay WL (1979) *Chemical equilibrium in soils.*, Wiley New York
- Shuman LM (1979) Zinc, manganese and copper in soil fractions. *Soil Sci.*, 127, 10
- Yoon RH, Salman T and Donnay G (1979) Predicting points of zero charge of oxides and hydroxides. *J. Colloid Interface Sci.*, 70, 483
- Bowden JW, Posner AM, Quirk JP (1980) Adsorption and charging phenomena in variable charge soils. In Theng BKG soils with variable charge. *NZ Soc. Soil Sci.*, 147
- Bowden JW, Nagarajah S, Barrow NJ, Posner AM and Quirk JP (1980) Describing the adsorption of phosphate, citrate and selenite on a variable-charge mineral surface. *Austr. J. Soil Research*, 18, 49–60
- Gillman GP and Uehara G (1980) Charge characteristics of soils with variable and permanent charge minerals. II - experimental. *Soil Sci. Soc. Am. J.*, 44, 252–255
- Lim CH, Jackson ML, Koons RD and Helmke PA (1980) kaolins: sources of differences in cation exchange capacities and cesium retention. *Clays Clay Miner.*, 28, 223–229
- Ninham BW (1980) Long-range vs short-range forces. The present state of play. *J. Phys. Chem.*, 84, 1423–1430
- Sposito G (1980) Cation exchange in soils: an historical and theoretical perspective. In: Baker DE *Chemistry in the soil environment.*, ASA, 40, 13

- Stoops W (1980) Ion adsorption mechanisms in oxidic soils: implications for ZPC determinations. *Geod.*, 23, 303–314
- Uehara G and Gillman GP (1980) Charge characteristics of soils with variable and permanent charge minerals. I – Theory. *Soil Sci. Soc. Am. J.*, 44, 250–252
- Westhall J and Hohl H (1980) A comparison of electrostatic models for the oxide/solution interface. *Adv. in colloid and interface science*, 12, 265–290
- Maksimovic Z, White JL and Logar M (1981) Chromium-bearing dickite and chromium-bearing kaolinite from Teslic (Yugoslavia). *Clays clay mineral*, 29, 213–218
- Morel FMM, Westall JC and Yeasted JG (1981) Adsorption models: a mathematical analysis in the frame work of general equilibrium calculations. In: Anderson MA, Rubin AJ.: *Adsorption of inorganics at solid-liquid interfaces.*, Ann. Arbor. Sci. Pub.
- Tazaki K (1981) Analytical electron microscopic studies of halloysite formation processus-morphology and composition of halloysite. *Proc. Int. Clay Conf.* Elsevier, Amsterdam 573–584
- El-Swaify SA (1982) *Soil physical chemistry.*, Hawai Univ., booklet n° 640
- Wada SI and Mizota C (1982) Ironrich halloysite (10 Å) with crumpled lamellar morphology from Hokkaido – Japan. *Clays Clay Miner.*, 30, 315–317
- Gillman GP, Bruce RC, Davey BG, Kimble JM, Searle PL and Skjemstad JO (1983) A comparison of methods used for determination of cation exchange capacity. *Commun. Soil Sci. Plant Anal.*, 14, 1005–1014
- Hodges SC and Zelazny (1983) Interactions of dilute hydrolysed aluminum solutions with clays, peat and resin. *Soil Sci. Soc. Am. J.*, 47, 206–212
- Kleijn WB and Oster JD (1983) Effects of permanent charge on the electrical double-layer properties of clays and oxides. *Soil Sci. Soc. Am. J.*, 47, 821–827
- Bleam W and McBride MB (1984) Cluster formation versus isolated-site adsorption. A study of Mn(II) and Mg(II) adsorption on boehmite and goethite. *J. Colloid Interface Sci.*, 103: 124–132
- Barrow NJ (1985) Reactions of anions and cations with variable-charge soils. *Adr. Agron.*, 38, 183–230
- Fallavier P (1985) Densité de charge variable et point de charge nulle dans les sols tropicaux. Définition, mesure et utilisation. *Agronomie tropicale*, 40, 239–245
- Gillman GP (1987) Modification of the compulsive exchange method for cation exchange capacity determination. *Soil Sci. Soc. Am. J.*, 51, 840–841
- Lambert K (1987) *Cation exchange in Indonesian peat soils.*, Thesis Gent Univ., 68 p
- Matjue N and Wada K (1987) Comments on “modification of the compulsive exchange method for cation exchange capacity determination”. *Soil Sci. Soc. Am. J.*, 51, 841
- Marcano-Martinez E and McBride MB (1989) Comparaison of titration and ion adsorption methods for surface charge measurement in oxisol. *Soil Sci. Soc. Am. J.*, 53, 1040–1045



- Bolt GH, De Boodt MF, Hayes MHB and McBride MB (1991) *Interactions at the soil colloid-soil solution interface*. Kluwer Academic Publishers – Nato Asi Series. Series E: Applied Sciences, vol. 190, 603 p
- Song KC and Ishiguro M (1992) Effects of solution pH on ion transport in allophanic andisol. *Soil Sci. Plant Nutr.*, 38, 477–484
- Sposito G (1994) *Chemical Equilibria and Kinetics in Soils.*, Oxford University Press, Oxford
- Sposito G (ed) (1996) *The environmental chemistry of aluminum.*, Lewis UK 464 p
- Comans RNJ, Hilton J, Voitsekhovitch O, Laptev G, Popov V, Madruga MJ, Bulgakov A, Smith JT, Movchan Net Konoplev A (1998) A comparative study of radiocesium mobility measurements in soils and sediments from the catchment of a small upland oligotrophic lake (Devoke Water, U.K.). *Water Res. Oxford*, 32, 2846–2855
- Vogeler I (2001) Copper and calcium transport through an unsaturated soil column. *Journal of environmental quality*, 30, 927–933
- Cervini-Silva Jet Sposito G (2002) Steady-state dissolution kinetics of aluminium–goethite in the presence of deferrioxamine-B and oxalate ligands. *Environ. Sci. Technol.*, 36, 337–342

---

## Isoelectric and Zero Charge Points

### 20.1 Introduction

#### 20.1.1 Charges of Colloids

**Table 20.1.** Explanation of abbreviations

abbreviation	Explanation
PZC or ZPC	point of zero charge or zero point charge
PZNC or ZPNC	point of zero net charge or zero point of net charge
PZNPC	point of zero net proton charge
PZSE	point of zero salt effect
ZPT	zero point titration
PPZC	pristine point of zero charge (case where PZC = IEP)
IEP	isoelectric point
pH <sub>0</sub>	determines the sign of the net charge of surface

In the last 50 years, the points of zero charge (Parks and de Bruyn 1962) have enabled a conceptual approach to soil charge phenomena in particular in tropical soils whose physicochemical characteristics are closely linked to the presence of variable charges. The terminology used, which is still changing (Table 20.1), sometimes leads to confusion and the significance of measurements of parameters may be erroneous.

Zero point charge (ZPC) defines pH values associated with specific conditions applied to one or more densities of surface charge, or more precisely, values of pH for which one or more of the surface charges

cancel each other (Sposito 1984). The ZPC can vary depending on the layers taken into account in defining the solid surface (cf. Chap. 19).

Studies by Uehara and Gillman (1981), Sposito (1981, 1984, 1989), Sparks (1986), Barrow (1987), Gangaiya and Morrison (1987), Cruz-Huerta and Kientz (2000), Gustafsson (2001) showed that in practice it is possible to use simpler operational definitions obtained from analytical results (like pH<sub>0</sub> or PZNC, cf. Sect. 20.1.2). The possible discrepancy between characteristic pH values highlights the heterogeneity of the molecular environment of the interfaces, the complexity of the soil system and associated concepts. Since the soil simultaneously contains components that have permanent and variable charges, all the charges  $\sigma_T$  of a system are broken down as follows:

$\sigma_p$ : permanent structural charges originating from the silicate lattices and isomorphic substitutions by ions of different valence. In most cases,  $\sigma_p$  is negative. These charges are significant in 2:1 clays, but generally weak in 1:1 clays and hydrated oxides.

$\sigma_v$  (or  $\sigma_H$ ): variable charges or net proton charges originating from iron and aluminium oxides, aluminosilicates, organic matter, edge charges and charges of surface functional groups. They are dominant in strongly weathered soils, rich in hydroxyl groups. These charges can be null, positive or negative. The protons of the diffuse layer are not accounted for:  $\sigma_v = qH - qOH$ .

$\sigma_A$  (or  $\sigma_{is}$ ): charges due to complexes able to form very stable covalent or ionic bonds (other than  $H^+$  and  $OH^-$ ), whose origin is not electrostatic, with no water molecule between the surface of the functional groups and the ion complexes (inner-sphere surface complex, Sposito, 1981). The charges can be null, positive or negative and can be regarded as specific adsorptions.

$\sigma_\beta$  (or  $\sigma_{os}$ ): charges of electrostatic origin coming from outer-sphere complex ions (other than  $H^+$  and  $OH^-$ ) which are regarded as nonspecific. There is a water molecule between the functional group and the bound ion. These ions are slightly adsorbed.

$\sigma_d$ : ion charges of the diffuse layer which enable a balance between total vacant charges and ensure neutrality. The ions of this layer are maintained by weak electrostatic forces, but can diffuse in the soil solution.

These charges, or density of charge, can be expressed in moles  $m^{-2}$  or Coulomb  $m^{-2}$  and in moles (charge)  $kg^{-1}$ . Electric neutrality implies use of the following equation:

$$\sigma_T = \sigma_p + \sigma_v + \sigma_a + \sigma_\beta + \sigma_d = 0$$

The term of surface charge  $\sigma_S$  of a particle must be defined (double layer model) as well as the different layers which are involved in this phenomenon. For example if:

$$\sigma_S = \sigma_p + \sigma_v + \sigma_a + \sigma_\beta$$

ZPC in this case, is the point where  $\sigma_S = 0$

or 
$$\sigma_S = -(\sigma_d).$$

If surface charge is considered as:  $\sigma_S = \sigma_p + \sigma_v + \sigma_a,$

ZPC is the point where 
$$\sigma_S = 0,$$

$$\sigma_S = -(\sigma_\beta + \sigma_d).$$

By potentiometric titration, the surface charge can be titrated as a function of pH and of the concentration of electrolytes, and the pH0 value deduced. The intersection of the titration curves occurs at the point where the surface charge is not influenced by the concentration of indifferent electrolytes.

If the pH = pH0, pH does not change with a change in the electrolyte concentration, only in this case:

$$\sigma_v = 0$$

and

$$\sigma_S = \sigma_p + \sigma_a,$$

however, ZPC requires  $\sigma_S = \sigma_p + \sigma_v + \sigma_a = 0.$

With this type of analysis, if there is no significant permanent charge, ZPC and pH0 will be confused. However, it is necessary to take into account the fact that pH0 can vary slightly if there is adsorption presenting a specific affinity and resulting in the creation of a more negative or more positive surface.

## 20.1.2 Definitions

### **Zero Point Charge (ZPC)**

This is the value of pH for which the total net charge  $\sigma_T$  is cancelled ( $\sigma_T = 0$ ). Since the inter-particle forces are inactivated, the particles flocculate and do not move when an electric field is applied (electrophoretic mobility is null). This property is significant for the formation of soil aggregates and the retention of ions. By raising the soil pH above the ZPC value, the charge  $\sigma$  becomes negative and the cation exchange capacity is increased. Conversely, by decreasing the pH below ZPC a positive charge appears creating an anion exchange capacity.

Estimation of ZPC enables prediction of the soil response to modifications in environmental conditions (e.g. cultivation, use of

fertilizers). For a soil in balance in an electrolyte solution with cations and anions forming only external sphere complexes (cf. Chap. 19):  $ZPC = PZNC = PZSE$ .

### **Point of Zero Net Proton Charge (PZNPC)**

This is the pH value for which the variable charge  $\sigma_v$  is cancelled ( $\sigma_v = 0$ ). In general, this point drops with a rise in pH. If there is no permanent charge in the lattice and no other ions determining the potential ( $H^+$  and  $OH^-$ ):  $PZNPC = ZPC = PIE$  (isoelectric point, cf. Sect. 20.1.1).

### **Point of Zero Net Charge (PZNC)**

This is the pH value for which the net charge of adsorbed ion, other than  $\sigma_v$  i.e.  $\sigma_a + \sigma_\beta + \sigma_d$ , is cancelled (Parker et al. 1979; Sposito 1984). This value depends on the concentration of electrolytes and can also vary slightly with the ion index used though in a not very significant way with indifferent electrolytes ( $Na^+$ ,  $Li^+$ ,  $Cl^-$ ,  $NO_3^-$ ). Measurements are made in a saturated solution, NaCl for example, as a function of the pH at a constant ionic force.

This value is useful to understand the phenomena of ion retention in the soil. At this point, equal quantities of cations and anions are adsorbed with an indifferent electrolyte and the cation exchange capacity (CEC) is equal to the anion exchange capacity (AEC), that is to say  $CEC - AEC = 0$ .

If the system contains notable quantities of permanent and variable charges,  $pH_0$  (cf. below) and PZNC do not result in the same pH value.

If  $pH(PZNC) < pH_0 \rightarrow$  indication of negative permanent charge.

If  $pH(PZNC) > pH_0 \rightarrow$  indication of positive permanent charges.

$PZNC = ZPC$  if the surface net charge of the complexes is cancelled.

### **Point of Zero Salt Effect (PZSE)**

$\sigma_v$  is often measured by titration in an indifferent electrolyte at different ionic forces. The pH at which the curves intersect is the point of zero salt effect (PZSE), this being a particular case in which  $\sigma_v$  is invariable. At this point, the salt concentration no longer has any effect on the pH, but it is not necessarily equal to ZPC (Parker et al. 1979), except if the densities of charges of  $\sigma_a$  and  $\sigma_\beta$  do not vary with the ionic force of the electrolyte. If there is no permanent charge and if specific adsorption does not vary with the ionic force of the solution (indifferent electrolytes):  $PZSE = PZNC$ .

**Zero Point Titration (ZPT)**

This is the point used during analysis that corresponds to the pH equilibrium before addition of any acid ( $H^+$ ) or base ( $OH^-$ ). It does not characterize the charges themselves, but the starting pH point of titration in a given medium of definite ionic force.

**Isoelectric Point (IEP)**

The isoelectric point is the pH at which the zeta potential is null or, when referring to the diffuse double layer theory, the pH at which the charge of the plan separating the Stern layer and the Gouy diffuse layer is null (Breeuwsma, 1973, Sparks 1986):  $\sigma_v = 0$  and  $\sigma_p = \sigma_a = \sigma_\beta = 0$ . With an indifferent electrolyte that does not cause any specific adsorption in the Stern layer, IEP is nearly equal to pH0 in a system dominated by variable charges. The term IEP is used for measurements of electrophoretic mobility.

**pH0 Point**

This is the point at which the net variable charge  $\sigma_v$  is equal to zero (Uehara-Gillman, 1981). At pH0,  $H^+$  and  $OH^-$  adsorptions are equal. The point can refer to ZPC and IEP, but can be different from ZPC and may be somewhat inaccurate as the ion exchange between protons added by titration and cations adsorbed on the sites of permanent charges is able to consume protons without affecting the variable charge. Sparks (1986) provided the following definition: pH0 is the pH value of a hydroxylated surface which presents a net surface charge equal to zero. It is a significant parameter in soils with variable charges because it determines whether the net charge of the surface is positive or negative.

For tropical soils with variable charges where the permanent charges are weak, the values of ZPC, PZNPC, PZSE, PZNC are close, which avoids the need to use very precise time-consuming methods that require considerable quantities of soil.

**20.1.3 Conditions for the Measurement of Charge**

Whole soils or clay fractions can be used, possibly after pretreatments which modify the variable charge distributions as a function of the pH and of the ionic force of the solutions. The elimination of organic matter masks total-C-to-ZPC correlations, KCl treatment enables extraction of exchangeable  $Al^{3+}$ , acid oxalate and DCB methods (cf. Chap. 6) enable elimination of oxide and hydroxide layer and reveal negative permanent charges. These measurements are also influenced by other factors such as:

- The  $Z$  valence of the counter-ion
- the dielectric constant  $\epsilon$  (the use of nonaqueous solvents like ethanol to eliminate excess reagents can deteriorate the surface charges and introduce serious errors)
- the absolute temperature  $T$
- the concentration of electrolytes.

The addition of an electrolyte to a soil with variable charge decreases the surface potential, but increases the surface charge. The lowering of the surface potential is indicated by a change in the pH of the solution. For a negative surface charge, the pH decreases with the concentration of electrolyte, and inversely, the pH increases with a positive surface charge. If there is no change in pH, the net surface charge is considered to be null.

As soil pH determines the magnitude of the net charge, the variable charges can be roughly estimated during measurement of  $\text{pH}_{\text{H}_2\text{O}}$  and  $\text{pH}_{\text{KCl}}$  by calculating  $\Delta\text{pH} = \text{pH}_{\text{H}_2\text{O}} - \text{pH}_{\text{KCl}}$  (cf. Chap. 15). If  $\Delta\text{pH}$  is between  $-0.5$  and  $+0.5$ , the soils are dominated by components with variable charges and  $\text{pH}_0$  can be estimated (Uehara and Gillman, 1981) by the sum  $\text{pH}_{\text{KCl}} + \Delta\text{pH}$  or

$$\text{pH}_0 = 2(\text{pH}_{\text{KCl}}) - (\text{pH}_{\text{H}_2\text{O}}).$$

These measurements should be regarded as a preliminary test before analysis. As  $\text{pH}_{\text{H}_2\text{O}}$  is affected by the concentration of electrolytes in the soil solution, it is difficult to decide whether observed differences are due to the concentration of electrolytes or to the nature of the surface charges. Measuring  $\text{pH}_{\text{KCl}}$  is more reliable as the effects of the presence of electrolyte in the solution are masked and the relationship with  $\text{Al}^{3+}$  extraction is improved. Schematically, the analytical operations required for the measurement of charge are simple, but their implementation can be long and delicate and must be carried out under rigorous operating conditions including:

- Contact between the soil and solutions of fixed composition and concentration, with controlled pressure and temperature and for a defined time to establish the reaction equilibria; this contact can be made in a suspension or on a column under controlled atmosphere if the phases are unstable in air (redox phenomena,  $\text{CO}_2$  equilibrium)
- possible separation of phases by gravity, filtration, or centrifugation
- chemical and physicochemical measurements on the residual soil or on the liquid phase after extraction
- calculations and graphical interpretation.

Computer programs make it possible to describe and model the reactions of the ions with the soil (e.g. Barrow 1987) considerably

simplifying the processing of data. Repetitive analyses can be carried out to monitor the changes in clay charges in order to reach the equilibrium state.

## 20.2. Main Methods

### 20.2.1 Measurement of pH<sub>0</sub> (PZSE), long equilibrium time

Simplified method of Uehara and Gillman (1981).

#### Reagents

- |                     |                   |  |                           |
|---------------------|-------------------|--|---------------------------|
| – sodium chloride   | NaCl              | mw =58.44  | 0.1 mol L <sup>-1</sup>   |
| – calcium chloride  | CaCl <sub>2</sub> | mw =110.99 (dried on P <sub>2</sub> O <sub>5</sub> ) | 0.1 mol L <sup>-1</sup>   |
| – sodium chloride   |                   |  | 2 mol L <sup>-1</sup>     |
| – calcium chloride  |                   |  | 2 mol L <sup>-1</sup>     |
| – hydrochloric acid | HCl               |  | 0.1 mol L <sup>-1</sup>   |
| – sodium hydroxide  | NaOH              |  | 0.1 mol L <sup>-1</sup> . |

The residual moisture of the samples has to be measured beforehand in order to bring back weights of wet soil to standard weights of soil dried at 105°C. In this way all the results are all expressed on the basis of the soil dried at 105°C and have the same relative surface during analysis whatever the moisture content.

#### Procedure

- Weigh 4 g of soil sieved at 0.5 mm (or equivalent weight dried at 105°C) in 15 replicates and place in 50 mL beakers numbered from 1 to 15 (Table 20.2).
- add 0.5 mL of indifferent electrolyte 0.1 mol (+) L<sup>-1</sup> solution (NaCl for soils with mostly monovalent elements in exchangeable cations or CaCl<sub>2</sub> for soils with mostly bivalent elements (Ca<sup>2+</sup>, Mg<sup>2+</sup>))
- to beakers 1 – 7 add increasing quantities of 0.1 mol (HCl) L<sup>-1</sup> solution and to beakers 9 – 15 add increasing quantities of 0.1 mol (NaOH) L<sup>-1</sup> solution.
- bring the volume to 20 mL with distilled water
- let it stand for 4 days agitating occasionally
- measure the pH → pH 0.002 M
- add 0.5 mL of electrolyte solution 2 mol L<sup>-1</sup> and agitate for 3 h.
- measure the pH → pH 0.05 M



- for each beaker, calculate  $\Delta\text{pH} = [\text{pH } 0.05 \text{ M} - \text{pH } 0.002 \text{ M}]$  and on a graph, note the values  $\Delta\text{pH}$  versus  $\text{pH } 0.002 \text{ M}$  to determine the point where  $\Delta\text{pH} = 0$  which corresponds to  $\text{pH}_0$ , i.e. the value of the pH that is independent of the salt concentration.

### 20.2.2 Point of Zero Salt Effect (PZSE), Short Equilibrium Time

#### **Principle**

The method (Block and de Bruyn 1970, Hendershot and Laukulich 1979, 1983) is based on the indirect measurement of PZSE by potentiometric titration of the net adsorption of  $\text{H}^+$  and  $\text{OH}^-$  at different pH and different ionic forces.

Because of the amphoteric character of certain colloids, the curves intersect at a given pH where the adsorption of protons is independent of the ionic force. This is the point of zero salt effect (Parker et al. 1979).

#### **Reagents**

- Indifferent electrolyte:
  - NaCl 0.001; 0.01; 0.05; 0.2 mol L<sup>-1</sup>
  - Preparation starting from commercial standard doses
- HCl 0.1 mol L<sup>-1</sup>
- NaOH 0.1 mol L<sup>-1</sup>.

#### **Procedure**

Reduce the sample that has been air dried for more than two months (for Andosols) to 2 mm (fine earth), then crush it to 0.5 mm (sieve AFNOR NF X11-501, module 28) in order to allow regular exchange and to minimize dispersion of the results.

Eight sample specimens (of 2 – 4 g) are needed for titration using four concentrations of the HCl and NaOH mediums (three concentrations are often sufficient if the intersection of the curves is correct):

- Weigh 2 g of soil
- add 40 mL of 0.001 mol L<sup>-1</sup> indifferent electrolyte
- agitate with a bar magnet for 5 min without stopping, then measure the initial pH which corresponds to ZPT



- using an automatic titrimer connected to a combined electrode, begin titration with 0.1 mol (HCl) L<sup>-1</sup> solution by regulating the additions to one drop every 2 min (Fig. 20.1)
- continue titration until pH 3.0. This will take approximately 2 h.

On another test specimen of 2 g soil:

- add 40 mL of 0.001 mol L<sup>-1</sup> indifferent electrolyte
- agitate with a bar magnet for 5 min and measure the pH which corresponds to ZPT
- carry out titration with 0.1 mol (NaOH) L<sup>-1</sup> solution and titrate at a speed of one drop every 2 min until pH 9.5 – 10.0 (because of the risk of carbonation, it is preferable to work in a controlled nitrogen atmosphere which enables all contact with atmospheric CO<sub>2</sub> to be avoided).

Complete the remaining titrations with additions of indifferent electrolyte 0.01, 0.05 and 0.2 mol L<sup>-1</sup> idem under the same conditions, plus a blank (reagents without soil) to correct the results if necessary.

### **Calculations**

The results are calculated in mmol kg<sup>-1</sup> of adsorbed acid or base; the value of the ZPC-PZSE and charges  $\sigma_i$  are given on the recording tape at constant run (Fig. 1).

### **Remarks**

The pH<sub>0</sub> value corresponds to a point of maximum chemical stability. This measurement can be made on rough untreated soil as well as on samples that have been subjected to pretreatment. For example:

- saturation by 1 mol (NaCl) L<sup>-1</sup> solution (Hendershot, Lavkulich, 1979; Gautheyrou et al. 1981)
- destruction of organic matter by sodium hypochlorite;
- elimination of oxides and hydroxides (methods DCB, acid ammonium oxalate, pyrophosphate, Segalen et al. 1983)

On untreated soil:

- if the pH measured in water is higher than that measured in KCl ( $\text{pH}_{\text{H}_2\text{O}} > \text{pH}_{\text{CaCl}_2} > \text{pH}_{\text{KCl}}$ ), the ZPC is located below ZPT and  $\sigma_i$  is negative;
- if the pH measured in water is lower than the  $\text{pH}_{\text{KCl}}$  ( $\text{pH}_{\text{H}_2\text{O}} < \text{pH}_{\text{CaCl}_2} < \text{pH}_{\text{KCl}}$ ) the ZPC is above ZPT and  $\sigma_i$  is positive.

The higher the rate of oxide–hydroxides, the higher the ZPC.

On soil saturated by NaCl, the variations in ZPC and in values of  $\sigma_i$  reflect the balance between the quantities of cations (Al<sup>3+</sup>) and anions (PO<sub>4</sub><sup>3-</sup>) exchanged by Na<sup>+</sup> and Cl<sup>-</sup>. If the clay content is relatively low, variations will be weak.

Comparison of the samples saturated in  $\text{Na}^+$  and those which have undergone more or less complete elimination of organic matter by hypochlorite shows the depressor effect of organic matter on the ZPC.

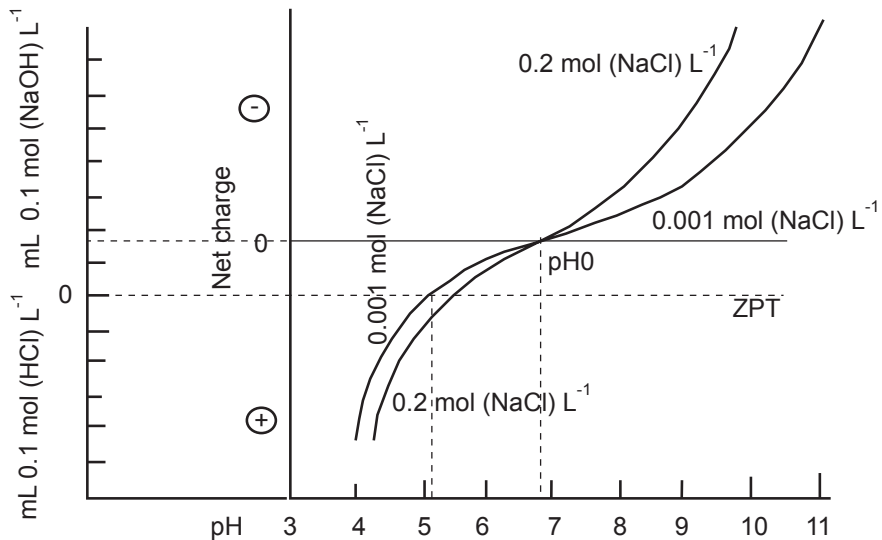

**Fig. 20.1** Determination of point of zero salt effect by titration

Iron and aluminium oxides have relatively high values of between pH 7 and pH 9 depending on their nature and their crystallinity.

The presence of silica and organic matter results in relatively low pH<sub>0</sub> values which increase the CEC of the andosols and allow the retention of cations.

## References

- Barrow NJ (1987) Reactions with variable-charge soils. In Martinus Nijhoff – Developments in plant and soil science, eiden 31, 191 p
- Blok L and de Bruyn PL (1970) The ionic double layer et ZnO/solution surface. I – The experimental point of zero charge. *J. Colloid Interface Sci.*, 32, 518–525
- Breeuwsma A (1973) *Adsorption of ion on hematite (αFe<sub>2</sub>O<sub>3</sub>)*. Ph.D. diss. Wageningen (Hollande)
- Cruz-Huerta L and Kientz DG (2000) Electric charge of andosols of 'Cofre de Perote', Veracruz, Mexico. *Terra*, 18, 115–124

- Gangaiya P and Morrison RJ (1987) A review of the problems associated with applying the terms surface and zero point of charge to soils. *Commun. in Soil Science Plant Analysis*, 18, 1431–1451
- Gautheyrou J and Gautheyrou M (1981) Comparison of electric charges in soils formed in a tropical climate. *Fourth Intern. Soil classification workshop Rwanda*, 7 p
- Gautheyrou J and Gautheyrou M (1981) *Point de charge zéro des sols à allophane, à imogolite, vertisols et oxisols de Guadeloupe et Martinique (Antilles françaises)*. ORSTOM-Antilles, notes laboratoire, 29 p
- Gustafsson JP (2001) The surface chemistry of imogolite. *Clays and Clay Minerals*, 49, 73–80
- Hendershot WH and Lavkulich LM (1979) The effect of sodium chloride saturation and organic matter removal on the value of zero point of charge. *Soil Sci.*, 128, 136–141
- Hendershot WH and Lavkulich LM (1983) Effect of sesquioxide coatings on surface charge of standard mineral and soil samples. *Soil Sci. Soc. Am. J.*, 47, 1252–1260
- Parker JG, Zelazny LW, Sampath S and Harris WG (1979) A critical evaluation of the extension of zero point of charge (ZPC) theory to soil systems. *Soil Sci. Soc. Am. J.*, 43: 668–673
- Parks GA and De Bruyn PL (1962) The zero point of charge of oxides. *J. Phys. Chem.*, 66, 967–973
- Segalen P, Gautheyrou M, Guenin H, Caracho E, Bosch D and Cardenas A (1983) Etude d'un sol dérivé de péridotite dans l'ouest de Cuba. Aspects physiques et chimiques (1). *Cahiers ORSTOM, série Pédologie*, XX, 239–245
- Sparks DL (1986) *Soil physical chemistry.*, CRC, Boca Raton, 308 p
- Sposito G (1981) The operational definition of the zero point charge in soils. *Soil Sci. Soc. Am. J.*, 45, 292–297
- Sposito G (1984) *The surface chemistry of soils.*, Clarendon Oxford, 234 p
- Sposito G (1989) *The chemistry of soils.*, Oxford University Press, 277 p
- Uehara G and Gillman G (1981) *The mineralogy, chemistry and physics of tropical soils with variable charge clays.*, Westview Tropical Agriculture Series, 4, 170 p

## Permanent and Variable Charges

### 21.1 Introduction

This terminology was introduced by Coleman et al. (1959) to characterize the charges linked to three main groups of soil components: clays, oxyhydroxides, and organic matter. Since then, advances in research no longer allow such a strict definition of the nature and origin of these charges. For example, clays are able to display both types of charges simultaneously. In certain types of tropical soil such as andisols varying charges are predominant whereas in soils in temperate regions permanent charges are predominant.

*Well crystallized clays* display a null or negative theoretical charge which occurs in the lattice structure and a variable charge which comes from the groups along the edge. The negative charge depends on the nature of the clay and the level of substitution of cations in the tetrahedral and octahedral layers. For example,  $\text{Al}^{3+}$  can replace  $\text{Si}^{4+}$  in the tetrahedral layer (e.g. Beidellite, Nontronite, Saponite), or  $\text{Mg}^{2+}$  can replace  $\text{Al}^{3+}$  in the octahedral layer (e.g. Montmorillonite, Illite). These isomorphic substitutions give rise to a deficit of positive charges and thus to an excess of negative charges which will be compensated for by external or interlayer cations. These charges are directly related to the permanent charges and do not depend on the pH or the ionic force.

*In 1:1 clays* of the Kaolinite type, which have a tetrahedral layer and a slightly deformed octahedral layer, the structure is electrically neutral. Isomorphic substitutions of  $\text{Al}^{3+}$  by  $\text{Fe}^{3+}$  in the octahedral layer are rare. Kaolinites thus present a weak permanent charge which means that if there are no structural disorders, measurements of cation exchange capacity (CEC) will not be much disturbed by variations in pH.

The rupture of the atom lattice reveals discontinuities that are not compensated for in hydroxylated surfaces, and are likely to ionize (Fig. 21.1). These edge charges depend on pH and the specific surface area.

$\text{Al}_3^+$  atoms in VI coordination and Si–OH groups can dissociate at around pH 7.0.

**Fig. 21.1.** Aluminol and silanol groups in kaolinite (Sposito 1984)

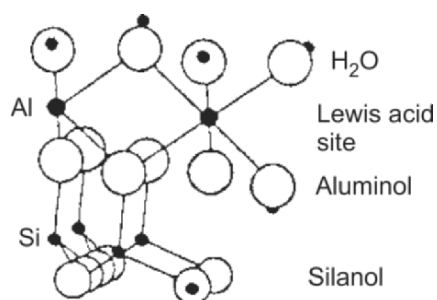

In halloysite- $4\text{H}_2\text{O}$ , which has layers of interfoliaceus water, the CEC is higher and can be modified by cations with low hydration energy.

In 2:1 clays some phyllosilicates like pyrophyllite or talc are formed by an octahedral layer ( $\text{Al}^{3+}$  or  $\text{Mg}^{2+}$ ) enclosed between two tetrahedral layers  $\text{Si}_4^+$  which form an electrically neutral unit. Smectites on the other hand, which derive from this type of formation after substitution of ion  $\text{Mg}^{2+}$  with ions  $\text{Al}^{3+}$  in the octahedral layer, present a deficit of positive charges (or excess negative charges) which must be compensated for by interlayer cations. The plan of the atoms of oxygen on the surface of 2:1 clays, called “siloxane”, is characterized by deformed hexagonal symmetry. This cavity of approximately 2.6 Å is bordered by the six orbitals of the hexagonal ring and its reactivity is linked to the charges distributed in the structure of the layers. If there are no isomorphic substitutions, and thus no deficit of positive charges, the siloxane cavity is a donor of electrons which can form unstable complexes. If, on the contrary, there is isomorphic substitution of  $\text{Al}^{3+}$  by  $\text{Mg}^{2+}$  or  $\text{Fe}^{2+}$  in the octahedral layer, the excess charge is close to surface oxygen atoms and the complexes are stable.

Vermiculites derived from trioctahedral Mg talc are replaced by  $\text{Al}^{3+}$  in the  $\text{Si}_4^+$  tetrahedral layer, creating negative structural charges which are compensated for by interfoliaceus cations, etc.

All these faults appear within the structural unit and no balance of charges can be considered to be a natural law. The concentration of electrolytes, the valence of the counter-ion and the potential of the double layer do not modify the surface charge. In practice, this permanent charge can be linked to the exchange capacity measured at soil pH in soils in temperate regions, as the variable charges are generally weak.

Permanent charges  $\rho_p$  and variable charges  $\rho_v$  make up the inherent surface charge which is a reflection of the degree of soil weathering and of the presence of organic matter and oxide.

$$\sigma_p + \sigma_v = \text{inherent surface charge of the soil.}$$

The oxides, hydroxides and oxyhydroxides that are free or cover the crystal lattices, as well as aluminosilicates with short-range organization, have a hydroxylated surface which is able to adsorb  $H^+$  protons or  $OH^-$  hydroxides. An acid medium causes excess adsorption of  $H^+$  ions and an alkaline medium excess  $OH^-$  (Fig. 21.2). These ions are also referred to as “ion determining potential (IDP)”.

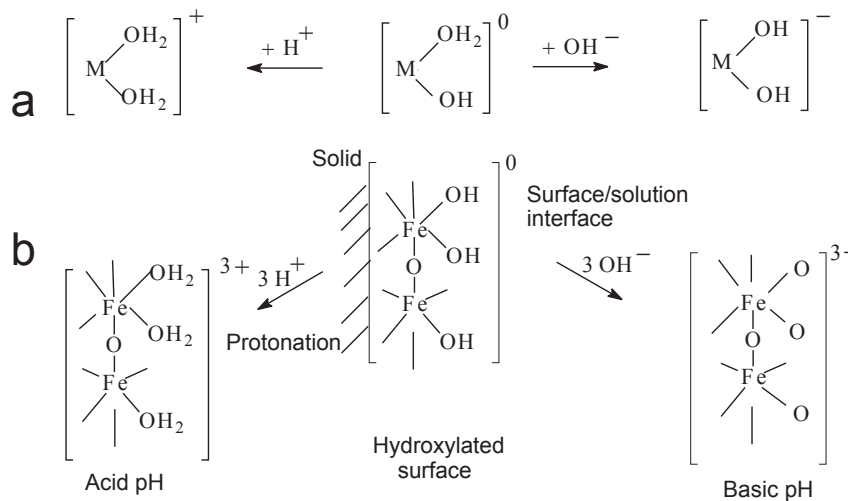

**Fig. 21.2.** Surface charge of hydroxylated materials  
**(a)** diagram of Parks and de Bruyn (1962); **(b)** hematite, iron oxide (Uehara and Gillman 1981)

For a given pH, the surface potential is fixed, but the surface charge depends on many factors such as (1) the pH of the solution, (2) the nature of the electrolyte, its valence and concentration, (3) the permittivity of the medium, (4) the temperature and the conditions of measurement compared to natural conditions. The point of null net charge is at the pH where the density of the positive charges is equal to the density of the negative charges.

The variable charge generally develops strongly at a pH equal to or higher than 7.0, but this pH value is empirical. Variable charges are a surface phenomenon and are thus related to the surface of colloids rather than to their absolute concentration. During weathering, variable charges can develop during the noncongruent dissolution of a crystal or on the



contrary, at the time of transition from an amorphous state to a crystalline state.

In aluminosilicates of the allophane type, cation exchange capacities that are able to reach very high values can develop in basic medium. The permanent charge is linked to Al(IV), while the variable charge originates from the hexacoordinate Al (Fieldes 1962; Fripia 1964).

The positive charges decrease with an increase in pH and can be measured using the results of CBD analysis (cf. Sect. 6.2.2 in Chap. 6) and possibly differentiated using the Fe:Ti and Fe:Mn ratios, if the positive charges originate from isomorphic substitutions of  $Ti_4^+$  or  $Mn_4^+$  in the  $Fe_3^+$  oxide structures.

*In organic matters* the presence of ionisable functional groups can confer strong negative net charges on these groups. The HOOC–carboxylic and HO– phenolic groups, which are the most active, give variable negative charges and the cation exchange capacity can reach 4 mol (+)  $kg^{-1}$ . Organic matter thus plays a major role in the surface horizons, and is involved in the soil buffering effect (regulation of the pH and of the concentration of exchangeable cations of the soil solution).

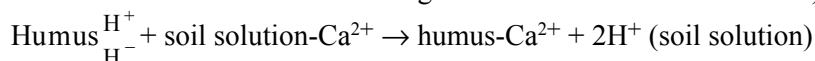

The nonionic organic structures can also react by the means of Van der Waals forces of attraction which induce only weak bonds, for example through molecules present at very short distances (about one Angström).

However, the very large humic, nonpolar polymer molecules cannot attract water molecules which explains the phenomenon of hydrophobicity of organic matter. Thus, in certain soils, it is necessary to use samples preserved in their natural moisture. The humified organic matter reacts with the soil minerals and forms aggregates.

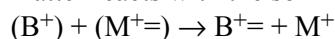

( $B^+$ ) organic molecular unit in aqueous solution.

( $M^{\pm}$ ) exchangeable monovalent cation bound to soil colloids.

( $B^{\pm}$ ) organic molecular unit bound to clay.

( $M^+$ ) monovalent cation in aqueous solution.

The organic molecular units that are involved in the exchange of cations and protons contain functional groups like carboxylate, carbonyls, and amino, aromatic, or N-heterocyclic groups. Exchange of anions is also possible with the carboxylate groups, as is formation of stronger bonds of the ligand type.

## 21.2 Main Methods

### 21.2.1 Measurement of Variable Charges

#### *Principle*

At  $pH_0$ , i.e. the intersection point of the titration curves in an electrolyte with variable concentration, the cation exchange capacity equivalent to the variable charges is measured on a graph enabling the increase in the density of negative charges between the soil pH and  $pH_0$  (Uehara and Gillman 1981) to be displayed (Fig. 21.3).

#### *Reagents*

Hydrochloric acid HCl	0.1 mol L <sup>-1</sup>
Sodium hydroxide NaOH	0.1 mol L <sup>-1</sup>
Potassium chloride (mw = 74.56 g)	2 mol L <sup>-1</sup>

#### *Procedure*

- Add 4 g of soil (equivalent to soil dried at 105°C) sieved at 0.5 mm in each of 11 centrifugation tubes of 50 mL (Table 21.1).
- Add 10 mL of distilled water and homogenize.
- Add increasing quantities of 0.1 mol (HCl) L<sup>-1</sup> solution in tubes 1–5, (Table 21.1) and same quantities of 0.1 mol (NaOH) L<sup>-1</sup> solution in tubes 7–11.
- Tube 6 is the control.
- Complete to 20 mL with water.
- Close the tubes and let stand for 4 days agitating periodically.
- Measure the pH in each tube:  $pH_1$  (water).
- Add 1 mL of 2 mol (KCl) L<sup>-1</sup> in each tube.
- Agitate for 3 h and measure the pH in each tube:  $pH_2$  (KCl).
- Plot the titration curves of  $pH_1$  and  $pH_2$  correcting with the blank values if necessary.

The intersection of the two curves gives  $pH_0$ . The variable exchange capacity is given by the density of charges between  $pH_0$  and the  $pH_{\text{water}}$  of the soil (Fig. 21.3).

**Table 21.1.** Experimental procedure for determination of variable charge

blanks		tube number										
B1	B2	1	2	3	4	5	6	7	8	9	10	11
mL water		10	10	10	10	10	10	10	10	10	10	10
		0.1 mol (HCl) L <sup>-1</sup>						0.1 mol (NaOH) L <sup>-1</sup>				
mL HCl or NaOH		0.5	1.0	2.0	3.0	4.0		0.5	1.0	2.0	3.0	4.0
mL water		9.5	9.0	8.0	7.0	6.0	10	9.5	9.0	8.0	7.0	6.0
Final volume 20 mL												

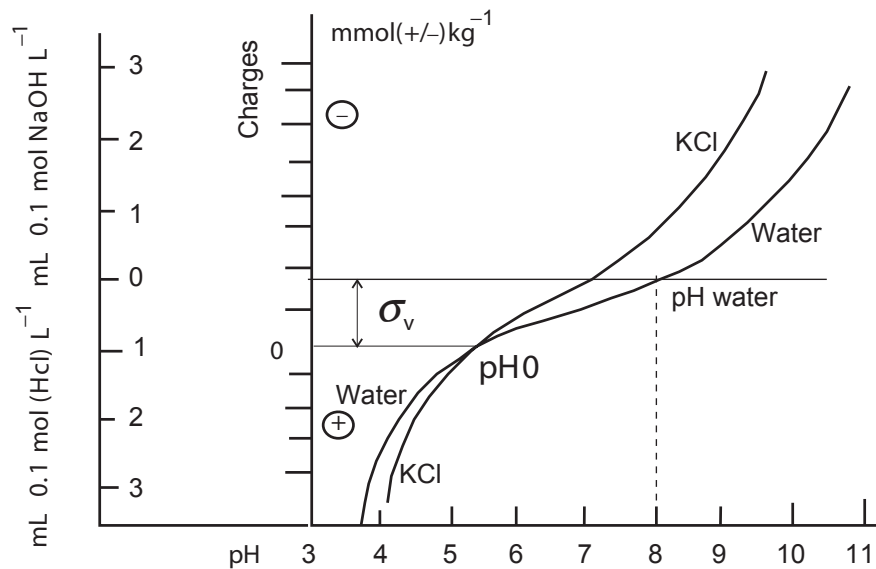
**Fig. 21.3.** Determination of variable charges  $\sigma_v$ 

### 21.2.2 Determination of Permanent Charges

#### *Principle*

The measurement of the permanent charge  $\sigma_p$  in a soil with permanent and variable charges is based on the adsorption of ions at pH0. At this point, there is equal adsorption of cations and anions on surfaces with variable charges, the density of the charge being null (Uehara and Gillman 1981).

Any excess adsorption of cations or anions at pH0 constitutes a measure of the permanent negative charge and permanent positive charge, respectively. A pretreatment is carried out to eliminate the specifically adsorbed ions and render the medium homoionic.

### **Reagents**

- 1 mol (KCl) L<sup>-1</sup> potassium chloride solution (KCl, mw = 74.56)
- 0.2 mol L<sup>-1</sup> potassium chloride solution
- 0.01 mol L<sup>-1</sup> potassium chloride solution
- 0.002 mol L<sup>-1</sup> potassium chloride solution
- 0.1 mol (HCl) L<sup>-1</sup> hydrochloric acid solution from
- 0.1 mol (KOH) L<sup>-1</sup> potassium hydroxide solution
- 0.1 mol (NaOH) L<sup>-1</sup> sodium hydroxide solution
- 0.5 mol (NH<sub>4</sub>NO<sub>3</sub>) L<sup>-1</sup> ammonium nitrate solution (NH<sub>4</sub>NO<sub>3</sub>, mw = 80.04)

### **Procedure**

#### ***Preliminary Treatment of Soil***

This treatment enables elimination of specifically adsorbed ions such as SO<sub>4</sub><sup>2-</sup>.

- Weigh 100 g of air-dried soil (equivalent to soil dried at 105°C) sieved to 0.5 mm.
- Put in contact with 500 mL of 1 mol (KCl) L<sup>-1</sup> solution and adjust the pH to 7.5 with 0.1 mol (KOH) L<sup>-1</sup> solution. Let stand for 1 h and discard the supernatant.
- Again put in contact with 500 mL of 1 mol (KCl) L<sup>-1</sup> and repeat the previous treatment twice.
- Wash with distilled water until the conductivity of the liquid phase is equal to that of a 0.002 mol (KCl) L<sup>-1</sup> standard solution.
- Dry in the air and sieve on a 0.5 mm mesh sieve.

#### ***Measurement of $\sigma_p$***

- Weigh 4 g fractions of previously treated soil (equivalent to soil dried at 105°C) and place in 50 mL beakers.
- Measure the pH0 in the same way as for variable charges (cf. Sect. 21.2.1), saturation of K<sup>+</sup> and elimination of the specifically adsorbed ions can modify the pH0 value.
- Recover the soil residue. Use the tube with the pH closest to pH0 for the determination of the permanent charges.

- Wash the residue with 20 mL of 0.2 mol (KCl) L<sup>-1</sup> solution and transfer in a 50 mL centrifugation tube.
- Agitate for 1 h, centrifuge and discard the supernatant.
- Add 20 mL of 0.01 mol (KCl) L<sup>-1</sup> solution and using HCl or NaOH 0.1 mol L<sup>-1</sup>, adjust the pH to the value found for pH0.
- Leave in contact for 1 h.
- Centrifuge and recover the supernatant, titrate K<sup>+</sup> and Cl<sup>-</sup>, is K<sup>+</sup> and Cl<sup>-</sup> mmol mL<sup>-1</sup>.
- Weigh the tube containing the centrifugation pellet to determine the volume of 0.01 mol (KCl) L<sup>-1</sup> solution retained (VmL).
- Move the K<sup>+</sup> and Cl<sup>-</sup> adsorbed ions on the centrifugation pellet by washing it five times with 20 mL of 0.5 mol (NH<sub>4</sub>NO<sub>3</sub>) L<sup>-1</sup> solution.
- Mix the five filtrates and titrate the moved K<sup>+</sup> and Cl<sup>-</sup> (K<sup>+</sup><sub>2</sub> and Cl<sup>-</sup><sub>2</sub> mmol mL<sup>-1</sup>).

#### Calculation

$$\begin{aligned} \text{Adsorbed K}^+ (\text{mmol}(+)\text{kg}^{-1}) &= 25 (100 \text{ K}^+_{2} - \text{K}^+_{1} V) \\ \text{Adsorbed Cl}^- (\text{mmol}(-)\text{kg}^{-1}) &= 25 (100 \text{ Cl}^-_{2} - \text{Cl}^-_{1} V) \\ \text{Permanent charge} &= \text{adsorbed K}^+ - \text{adsorbed Cl}^- \end{aligned}$$

#### Remarks

- K<sup>+</sup> and Cl<sup>-</sup> are generally titrated by, respectively, flame emission spectrometry and adsorption colorimetry (Pansu et al. 2001).
- The sum of the permanent and variable charges roughly corresponds to the cation exchange capacity measured by ammonium acetate buffered at pH 7.0 (cf. Chap. 22).

#### References

- Coleman NT, Weed SB and McCracken RJ (1959) Cation exchange capacity and exchangeable cations in Piedmont soils of North Carolina. *Soil Sci. Soc. Am. Proc.*, 23, 146–149
- Fripia JJ (1964) Surface properties of Alumino-silicates. *Clays Clay Miner.*, 12, 327
- Pansu M Gautheyrou J and Loyer JY (2001) *Soil Analysis - Sampling, Instrumentation and Quality control*. Balkema, Lisse, Abington, Exton, Tokyo, 489 pp
- Parks GA and De Bruyn PL (1962) The zero point of charge of oxides. *J. Phys. Chem.*, 66, 967–973
- Sposito G (1984) *The surface chemistry of soils.*, Oxford-Clarendon Press, Oxford, 274 p

Uehara G and Gillman G (1981) The mineralogy, chemistry and physics of tropical soils with variable charges clays. *West view trop. Agric. Ser.*, 4, 170 p

## Bibliography

- Bortoluzzi EC, Tessier D, Rheinheimer DS and Julien JL (2005) The cation exchange capacity of a sandy soil in southern Brazil: an estimation of permanent and pH-dependent charges. *Eur. J. Soil Sci.*, doi:10.1111/j.1365-2389.00746.x
- Coleman NT, Weed SB and McCracken RJ (1959) Cation exchange capacity and exchangeable cations in Piedmont soils of North Carolina. *Soil Sci. Soc. Am. Proc.*, 23, 146–149
- Conyers MK, Helyar KR and Poile GJ (2000) pH buffering: the chemical response of acidic soils to added alkali. *Soil Sci.*, 165, 560–566
- Zelazny LW, Liming He and An Vanwormhoudt (1996) – Charge analysis of soils and anion exchange. In *Methods of soil analysis, part 3, Chemical methods*, Bigham JM and Bartels JM ed. SSSA-ASA, Madison, WI Etats-Unis, 1231–1253
- Julien JL and Turpin A (1999) Reactive surfaces and the reasoning of a few chemical characteristics of acid soils. *Comptes-Rendus-de-l'Academie-d'Agriculture-de-France*, 85, 25–35
- Van-Ranst E, Utami SR and Shamshuddin J (2002) Andisols on volcanic ash from Java Island, Indonesia: Physico-chemical properties and classification. *Soil Sci.*, 167, 68–79

## Exchangeable Cations

### 22.1 Introduction

#### 22.1.1 Exchangeable Cations of Soil

This measurement is also widely known by its former name “exchangeable bases” which was the after-effect of analytical formulae expressed in oxide form (basic oxides such as  $K_2O$ ,  $Na_2O$ ; in 1929, Bray and Willhite performed soil lixiviation with neutral ammonium acetate followed by calcination to volatilize the acetate and to transform the elements into carbonate and oxides), and possibly to contrast it with exchangeable acidity. The older name may now seem obsolete, but it is still widely used.

Adsorption of exchangeable cations during deterioration processes represents the net accumulation of materials at the interface of the solid phase and the soil solution, but does not imply the development of a three-dimensional molecular structure as is in the case with precipitation. These ions can be moved by an electrolyte solution of known composition at a given pH.

In agronomy, the adsorption of exchangeable cations and the CEC<sup>1</sup> are very important for the determination of intrinsic soil fertility, fertilizer retention capacity, plant nutrition and so on. The adsorbed cations are available for plants which generate  $H^+$  ions at the level of their small roots in contact with the soil solution.

Fertilizers but also environmental pollutants (like pesticides and toxic cations) are retained by the charges of the colloidal surfaces which prevent lixiviation. The adsorbing complex thus acts as an element of storage and of regulation for ions (inorganic and organic cations or anions). The measurement of exchangeable cations naturally present in

---

<sup>1</sup>CEC = Cation Exchange Capacity.

the soil gives their sum  $S$  ( $\leq$ CEC). Combined with the CEC ( $T$ ), the  $S:T$  ratio of saturation of the soil in fertilizing elements can be estimated at a given time, generally at the end of the farming cycle in cultivated zones.  $S$  measurement is affected by many factors:  $\text{Ca}^{2+}$ ,  $\text{Mg}^{2+}$ ,  $\text{K}^+$ ,  $\text{Na}^+$  contents can vary rapidly under the influence of fertilizers, amendments and plant cover, irrigation can cause transformations such as sodification.

Other ions that are removable by more active reagents (e.g.  $\text{H}^+$ ,  $\text{Al}^{3+}$ ) and exchangeable trace elements (e.g. Mn, Zn, Cu, Ni, Co, Ti, U, Cs, Sr, Pb, V) are not taken into account in the majority of studies, with the exception of studies on fertilization, toxicity or environmental pollution (for example the elimination of toxic or radioactive residues, ethro-phication of groundwater and rivers).

Measurement of exchangeable calcium serves no purpose in limestone or gypseous soils because of saturation of the exchange complex and errors introduced by the solubility of calcium carbonate and gypsum. However, the Ca:Mg and Ca:Na ratios and the measurement of “active” calcium are useful (cf. Chap. 17).

In saline soils, the exchange complex is saturated by sodium ions and the presence of soluble salts makes measurement of exchangeable cations impossible, meaning other criteria have to be used (such as SAR, PAR, cf. Chap. 18). In soils characterized by ion supersaturation, the sum of the extracted cations ( $S$ ) tends to exceed CEC ( $T$ ).

The analysis of exchangeable cations retained by the negative charges of clays is important in evaluating the transfer rate of the ionic compounds through soil profiles (leaching) and enables the kinetics of exchange vs. time and space to be identified. For routine analysis, the exchange times are short (a few minutes), but to allow rehydration of inflating clays (like in montmorillonite) and also to take into account slower interfoliaceous exchanges (like in vermiculite), the sample is often left in contact with the reagent overnight before percolation.

In the case of illites,  $\text{K}^+$  is easily trapped in the hexagonal cavities of the tetrahedral layers and is then difficult to extract. The exchange is no longer quantitative.

### 22.1.2 Extracting Reagents

The displacement of the exchangeable cations depends on the nature of the cations used to move them. Multivalent ions are theoretically more effective than monovalent ions. The reagent should move the exchangeable cations as selectively as possible without being too aggressive and without dissolving products that are not involved in adsorption-desorption.



In practice, the sum of the main exchangeable cations ( $\text{Ca}^{2+}$ ,  $\text{Mg}^{2+}$ ,  $\text{K}^+$ ,  $\text{Na}^+$ ) extracted by normal ammonium acetate at pH 7.0 is still used in most laboratories as a reference for classification systems and for cartography. The interest of  $\text{NH}_4^+$  is that it is not usually present to a significant degree in the exchange complex. This method is part of the standard NF X31-108 (1992). The extraction of exchangeable cations can also be combined with other techniques available for CEC (cf. Chap. 26) as in the international standard NF X31-130 (1993).

In oxidic soils in which divalent cations are predominant, the use of a cation like  $\text{Ba}^{2+}$  makes extraction more complete. Extraction is difficult due to adsorption in the Stern layer and it is necessary to know if when this charge of exchangeable cations is used, there will be a correlation with their availability for plants. For measurement of the effective CEC (NF ISO 11260, 1994) titration of exchangeable cations can be carried out on the 0.1 mol ( $\text{BaCl}_2$ )  $\text{L}^{-1}$  extraction solutions at the soil pH or, for the measurement of the potential CEC (NF ISO 13536, 1995), on the 1 mol ( $\text{BaCl}_2$ )  $\text{L}^{-1}$  solutions buffered at pH 8.1.

Many authors, including Okazaki et al. (1962) and Gillman et al. (1982) have compared different extraction methods for exchangeable cations. In most soils, even those with variable charges, the values are basically independent of the method used provided the extraction pH does not exceed 7.0. However, it should be noted that exchangeable  $\text{K}^+$  may appear to be slightly lower if the  $\text{Ba}^{2+}$  counter-ion is used instead of  $\text{NH}_4^+$  (this is not the case for CEC, cf. Chap. 26).

### 22.1.3 Equipment

Manual or semi-automatic laboratory systems can be used for the extraction of exchangeable cations (Fig. 22.1):

- simple agitation with all the extraction reagents followed by separation (decantation, centrifugation, filtration) and titration of the cations in the liquid phase
- a system of contact with iterative additions and separation of the reagents, which allows the reagent to be continually renewed
- by percolation on a column with inert filtration additives

- by simple gravity with a constant level reagent delivery system, of the “Mariotte flask” type
- a bottom up system (*per ascensum*) enabling elimination of the air bubbles likely to disturb the solid–liquid contact
- a partial vacuum system using apparatuses equipped with multiple syringes that allow automatically programmed regular percolation.

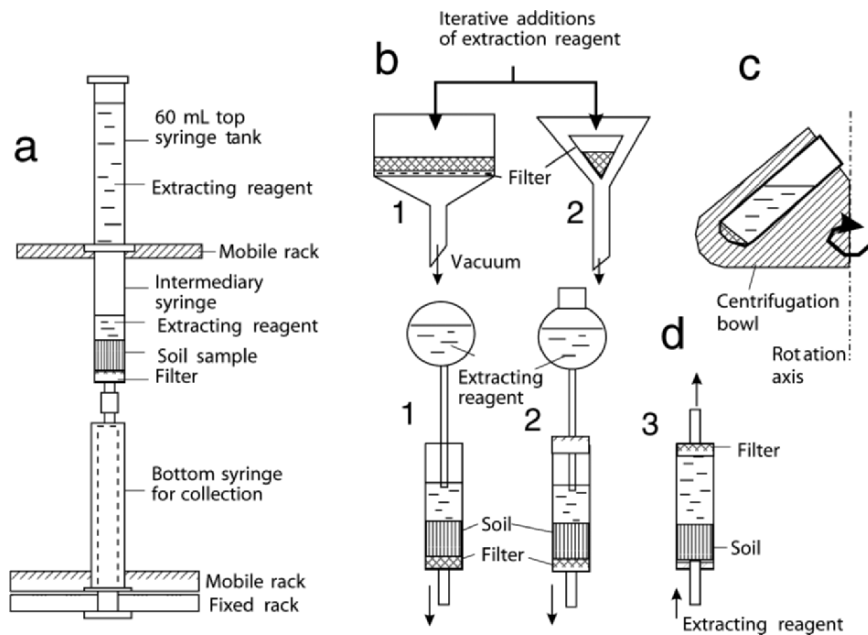

**Fig. 22.1.** Devices for putting in contact and separating the solid and liquid phases. **a:** automated extraction according to Kalra and Maynard (1991), **b:** percolation on filter, 1: Büchner funnel under vacuum, 2: simple gravity system, **c:** contact and separation by centrifugation, **d:** percolation on column, 1: closed flask, 2: open flask, 3: *per ascensum*

When using systems on columns, variable local speeds (preferential or laminar currents) and a radial gradient of permeability have to be avoided. The quality of filling can be critical and the quantity of the soil sample should consequently be limited to ensure satisfactory permeability, but also to avoid excessive concentration of the percolation front.

## 22.2 Ammonium Acetate Method at pH 7

### 22.2.1 Principle

The soil is saturated by the  $\text{NH}_4^+$  cation in a buffered (or not buffered) medium at pH 7.0. The exchangeable cations are moved and pass into the liquid phase where they are titrated by atomic absorption or inductively coupled plasma spectrometry.

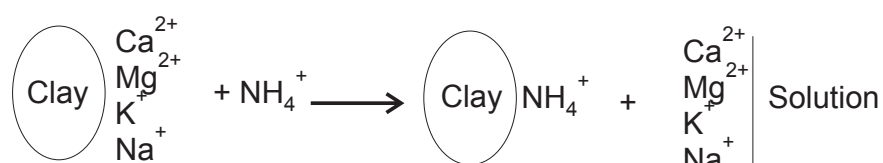

This method is reliable for most soils except in the presence of high rates of limestone, gypsum, soluble salts (solubilization) and hydrated vermiculite or micas (retrogradation).

The method in not buffered medium extracts the exchangeable cations at a pH near to that of the soil. It is used for effective cation exchange capacity (cf. Sect. 26.2 of Chap. 26). In soils with mainly variable charges, the method in buffered medium at pH 7.0 gives higher results than not buffered medium. Exchangeable manganese can be titrated in this medium to check manganese toxicity.

In soils able to fix potassium,  $\text{NH}_4^+$  can partially replace fixed  $\text{K}^+$ , giving too high results for exchangeable  $\text{K}^+$ .

### 22.2.2 Procedure

#### Reagents

##### *Ammonium Acetate 1 mol L<sup>-1</sup> Buffered at pH 7*

- Dissolve 77.08 g of RP  $\text{CH}_3\text{COONH}_4$  in about 950 mL of deionized water
  - bring the pH to 7.0 by adding diluted ammonia or acetic acid
  - complete to 1,000 mL with deionized water.
- Or:
- Add 58 mL of glacial acetic acid ( $\text{CH}_3\text{COOH}$ )
  - add about 300 mL of deionized water, then 71 mL of RP ammonia density = 0.90
  - let cool

- adjust the pH to 7.0 by adding ammonia or acetic acid
- bring the volume to 1,000 mL with deionized water.

**Ammonium Chloride 1 mol L<sup>-1</sup>**

- Dissolve 53.5 g of RP NH<sub>4</sub>Cl in deionized water and bring to 1,000 mL (the pH is about 4.5–5.0).

**Manual Method – Usual Procedure**

- Weigh 10 g (equivalent to soil dried at 105°C) of soil sample sieved to 2 mm
  - put in contact with 25 mL of extracting reagent (ammonium acetate chloride) in a 100 mL beaker
  - homogenize and leave in contact overnight
  - agitate and let decant, then filter; repeat this procedure three times leaving in contact for 15 min between each extraction; mix the extracted portions and bring to 100 mL; homogenize
  - titrate Ca<sup>2+</sup>, Mg<sup>2+</sup>, K<sup>+</sup>, Na<sup>+</sup> in this filtrate by flame emission or atomic absorption spectrometry or by inductively coupled plasma spectrometry (Pansu et al. 2001). Titrate the same elements in the blank essay (extractant only) and deduce the values from the previous ones.
- The results are expressed in Cmol (+) kg<sup>-1</sup> of soil dried at 105°C.

Two controls should be performed per series: a standard control for reproducibility over time, and a randomly chosen soil replicate for reproducibility within the series.

**Remarks**

The international standard NF X 31-108 (1992) recommends only one agitation and 1 h for the test specimens and volumes listed in Table 22.1.

**Table 22.1.** Sample specimens and volumes recommended in standard NF X 31-108 (1992)

sample specimen (g)	volume of extracting solution (mL)	vessel volume (mL)
5	100	125–150
10	200	250–300

In the case of saline soils, if conductivity exceeds 0.5 mS, the soil should be washed to eliminate soluble salts before measuring exchangeable cations. As the exchange complex is Na<sup>+</sup> saturated, the elimination of soluble salts modifies the distribution of the exchangeable cations.

In the case of calcareous and/or gypseous soils, ammonium acetate can cause solubilization of calcium and magnesium carbonates or sulphates.

If the limestone content is high, the exchange complex can be considered to be  $\text{Ca}^{2+}$  saturated. The pH 8.1 extraction method can limit the effects of carbonate dissolution.

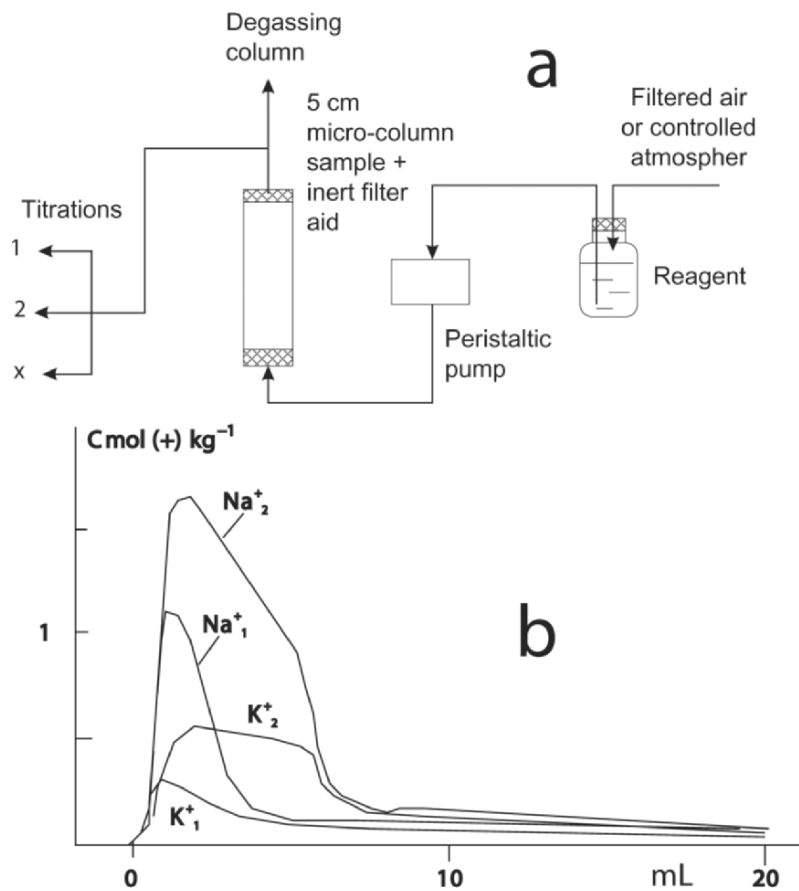

**Fig. 22.2.** Example of the dynamics of column extraction (a) automated system with continuous titration (b) example of cation exchange at pH 7 with the  $1 \text{ mol } (\text{CH}_3\text{COONH}_4) \text{ L}^{-1}$  solution. 1: without previous contact, 2: with 24 h contact Gautheyrou et al., 1967)

Another possible approach uses double percolation: the first includes exchangeable plus solubilized elements, the second, solubilized elements. The exchangeable elements are obtained by calculating the difference between the two.

The procedure using normal ammonium acetate at pH 7 can be combined with the measurement of CEC with  $\text{NH}_4$  (cf. Chap. 26) of which it represents the initial phase of saturation.

### 22.3. Automated Continuous Extraction

The use of dynamic displacement techniques makes it possible to analyse adsorption and desorption phenomena by means of soil columns percolated per ascensum by a mobile liquid phase of suitable concentration (Fig. 22.2). The flow is controlled and maintained constant by peristaltic pumps and the titration of the effluents is uninterrupted (Gautheyrou et al. 1967–1981). Continuous flow should be selected to reach the exchange equilibrium in a short time.

Data analysis allows the equilibrium laws of the exchangeable cations to be studied. Column methods were used to control exchange kinetics with respect to – for example (1) the mineralogical nature of clays and the lixiviation phenomena, (2) potassium fixing capacity, (3) chemical transport of cations and anions (e.g. Sparks et al. 1980, Sparks and Jardine 1981, Schweich et al. 1983, van Genuchten and Parker 1984, Carski and Sparks 1985, Shaviv et al. 1986, Jardine et al. 1988, Kool et al. 1989, Moog et al. 1998, Communar et al. 2004).

### References

- Carski TH and Sparks DL (1985) A modified miscible displacement technique for investigating adsorption–desorption kinetics in soils. *Soil Sci. Soc. Am. J.*, 49, 114–116
- Communar G, Keren R and FaHu Li (2004) Deriving boron adsorption isotherms from soil column displacement experiments. *Soil Sci. Soc. Am. J.*, 68:481–488
- Gautheyrou J and Gautheyrou M (1981) *Contribution à l'étude de la capacité d'échange des sols à allophane. Aspects analytiques de la CEC et ses conséquences sur l'interprétation pédo-agronomique.*, ORSTOM-Antilles, notes de laboratoire. Tome I: 276 p Tome II: 129 p Tome III: profils (200 p)
- Gautheyrou J and Gautheyrou M (1967) *Dosage des cations échangeables du sol.*, ORSTOM-Antilles, notes de laboratoire, 27 p
- Gillman GP, Skjemstad JO and Bruce RC (1982) A comparison of methods used in Queensland for determining cation exchange properties. *CSIRO Aust. Div. Soils Tech. Pap.*, 44, 1–18

- Jardine PM, Wilson GV and Luxmoore RJ (1988) Modeling the transport of inorganic ions through undisturbed soil columns from two contrasting watersheds. *Soil Sci. Soc. Am. J.*, 52 : 1252–1259
- Kalra YP and Maynard DG (1991) *Methods manual for forest soil and plant analysis.*, Forestry Canada, Northern Forestry Center, Information report NORX-319, 15, 84–94
- Kool JB, Parker JC and Zelazny LW (1989) On the estimation of cation exchange parameters from column displacement experiments. *Soil Sci. Soc. Am. J.*, 53, 1347–1355
- Moog HC, Streck T, Cammenga HK (1998) Modeling Ca/K exchange kinetics by montmorillonite and vermiculite. *Soil Sci.*, 163, 382–39
- NF X 31-108 (1992) Détermination des cations Ca, Mg, K, Na extractibles par l'acétate d'ammonium. In *Qualité des sols*, AFNOR, Paris, 1996, 59–65
- NF X 31-130 (1993) Détermination de la capacité d'échange cationique et des cations extractibles. In *Qualité des sols*, AFNOR, Paris, 1996, 103–116
- NF ISO 11260 (1994) Détermination de la capacité d'échange cationique effective et du taux de saturation en bases échangeables à l'aide d'une solution de chlorure de baryum. In *Qualité des sols*, AFNOR, Paris, 1996, 243–256
- NF ISO 13536 (1995) Détermination de la capacité d'échange cationique potentielle et de la teneur en cations échangeables en utilisant une solution tampon de chlorure de baryum à pH = 8.1. In *Qualité des sols*, AFNOR, Paris, 1996, 293–303
- Okazaki R, Smith HW and Moodie CD (1962) Development of a cation-exchange capacity procedure with few inherent errors. *Soil Sci.*, 93, 343–349
- Pansu M, Gautheyrou J and Loyer JY (2001) *Soil Analysis – Sampling, Instrumentation and Quality control.* Balkema, Lisse, Abington, Exton, Tokyo, 489 p
- Schweich D, Sardin N and Gaudet JP (1983) Measurement of a cation exchange isotherm from elution curves obtained in a soil column: preliminary results. *Soil Sci. Soc. Am. J.*, 47, 32–37
- Shaviv A, Jury WA and Pratt PF (1986) Exchange, fixation and precipitation of cations during leaching of soils amended with manure: 1/ column experiments. *Soil Sci.*, 141, 237–243
- Sparks DL, Zelazny LW and Martens DC (1980) Kinetics of potassium desorption in soil using miscible displacement. *Soil Sci. Soc. Am. J.*, 44, 1205–1208
- Sparks DL and Jardine PM (1981) Thermodynamics of potassium exchange in soil using a kinetics approach. *Soil Sci. Soc. Am. J.*, 45, 1094–1099
- Van Genuchten MTh and Parker JC (1984) Boundary conditions for displacement experiments through short laboratory columns. *Soil Sci. Soc. Am. J.*, 48, 703–708

---

**Bibliography**

- Hao XY and Chang C (2002) Effect of 25 annual cattle manure applications on soluble and exchangeable cations in soil. *Soil Sci.*, 167, 126–134
- Holmgren GGS, Juve RL and Geschwender RC (1977) A mechanically controlled variable rate leaching device. *Soil Sci. Soc. Am. J.*, 41, 1207–1208
- Kukier U, Sumner ME and Miller WP (2001) Distribution of exchangeable cations and trace elements in the profiles of soils amended with coal combustion. *Soil Sci.*, 166, 585–597
- Liu CL, Wang MK and Yang CC (2001) Determination of cation exchange capacity by one-step soil leaching column method. *Communications in Soil Science and Plant Analysis*, 32, 2359–2372
- Luer B and Bohmer A (2000) Comparison between percolation and extraction with 1M NH<sub>4</sub>Cl solution to determine the effective cation exchange capacity (CEC<sub>eff</sub>) of soils. *J. Plant Nutr. Soil Sci.*, 163, 555–557
- Ogwada RA and Sparks DL (1986) Kinetics of ion exchange on clay minerals and soil : evaluation of methods. *Soil Sci. Soc. Am. J.*, 50, 1158–1162 and 1162–1166
- Van Reuwijk LP (1987) *Procedures for soil analysis.*, ISRIC, 9–1 à 9–11.



## Exchangeable Acidity

### 23.1 Introduction

#### 23.1.1 Origin of Acidity

Exchangeable acidity, which appears during soil genesis processes (e.g. podzolization), can be regarded as a deterioration of the exchange surfaces (Pedro 1987). Clay can undergo hydrolysis (acidolysis, acidocomplexolysis) which causes destabilization of the 2:1 lattices, resulting in some of the  $\text{Al}^{3+}$  cations of the octahedral layer passing into exchangeable positions. So the surface exchangeable cations decrease and gradually aluminium dominates the negative charges, the pH of the soil drops towards 4.0 and phenomena of non-congruent dissolution can occur.

Acid rains that accompany fossil fuel emissions, and repeated application of acidifying fertilizers during crop cycles can accelerate soil deterioration. For example, with ammonium fertilizers, protons are produced during nitrification:

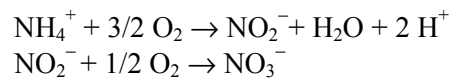

Is on the whole:



If the sample is treated with a not buffered electrolyte solution e.g. a potassium chloride solution,  $\text{Al}^{3+}$  ions are exchanged and transferred into solution where they can be hydrolyzed with release of protons. These reactions are complex. According to the Lewis theory, the  $\text{Al}^{3+}$  ion is an acceptor of electrons, able to hydrate itself:

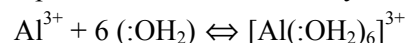

There is then a sequence of dissociation in aqueous medium.

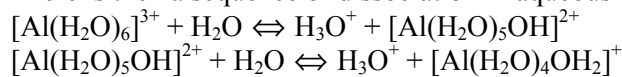

In addition,  $\text{Al}^{3+}$  can react with the anions as a function of the pH.

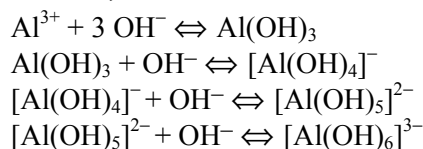

Monomeric forms are the most abundant at low pH, i.e. towards pH 4.0, whereas polymeric forms gradually become predominant towards pH 4.5–4.7.

Organic compounds can release protons, and, in acid soils containing reduced forms of sulphur (mangroves, organic soils subjected to waterlogging), acidity can result from oxidation reactions in contact with the air. With pyrite, for example:

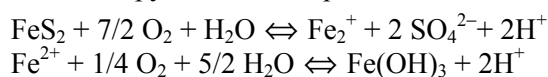

Below pH 4.5 the microbial activity of *Thiobacillus ferrooxidans* is strong and acidification increases according to the reaction:

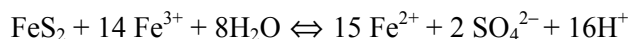

In reducing medium below pH 5.5, the  $\text{Mn}^{2+}$  ion can present phytotoxicity which is added to that of  $\text{Al}^{3+}$ .

Exchangeable acidity is distinguished from free acidity that results from the concentration of  $\text{H}^+$  ions in the soil solution. Exchangeable acidity forms part of potential acidity which includes more or less ionized acid functions, weak organic acids and easily exchangeable cations.

Potential acidity can be measured volumetrically by neutralizing the charges with a strong base. Potential acidity is one of the main components of the soil buffering effect. Acidity known as “extractable” is measured at pH 8.2 with a  $\text{BaCl}_2$ –triethanolamine reagent, and its measurement can be combined with that of charges that depend on the pH.

### 23.1.2 Aims of the Analysis

For soil taxonomy, the 1 mol (KCl)  $\text{L}^{-1}$  extract is considered to include only exchangeable forms  $\text{Al}^{3+}$ ,  $\text{AlOH}^{2+}$ ,  $\text{Al}(\text{OH})_2^+$  and  $\text{H}^+$ , possibly neglecting non-exchangeable solubilized products (e.g. amorphous gel, hydroxypolymers, gibbsite, aluminium phosphate,  $\text{Fe}^{2+}$  iron,  $\text{Mn}^{2+}$ ).

The actual acidity of a soil is measured in moles of protons which can be titrated per unit mass (this exchangeable acidity is sometimes called acidity displaced by salts). In practice, above pH 5.2, no significant quantities of exchangeable aluminium are found as the Al ion is precipitated at this pH.

It is possible to separate exchangeable from non-exchangeable aluminium in an unambiguous way by leaching with strong electrolytes and plotting curves of cumulated solubility values (Skeen and Sumner 1965). As the dissolved quantities of non-exchangeable aluminium during extraction are constant, the sum of these contributions is then subtracted.

KCl exchangeable acidity is used for the measurement of effective cation exchange capacity by summation with the exchangeable cations extracted at soil pH ( $\text{Ca}^{2+}$ ,  $\text{Mg}^{2+}$ ,  $\text{K}^+$ ,  $\text{Na}^+$ ). A relatively high concentration of the extraction solution at  $1 \text{ mol L}^{-1}$  is necessary to account for the effect of the diffuse layer.

Measurement of exchangeable acidity is useful in agronomy to determine aluminic phytotoxicity which is closely correlated with the rate of exchangeable aluminium. However, this measurement does not constitute an index of toxicity: indeed, forms of mono- or polymeric aluminium and the ionic force of soil solution influence aluminium bio-activity, as does the presence of phosphorous and calcium in the root environment. The plant genotype must also be taken into account as some plants are more tolerant than others. In some tropical soils,  $\text{Al}^{3+}$  extractable by KCl is not always correlated with  $\text{pH}_{\text{water}}$ . Certain soils with a pH close to 4 can contain less exchangeable aluminium than soils with a pH near 5. The correlation with  $\text{pH}_{\text{KCl}}$  is more satisfactory. The  $\Delta\text{pH} = \text{pH}_{\text{KCl}} - \text{pH}_{\text{water}}$  can be an indicator of mineralogical instability if it is significant (on the other hand if it is very weak, the soil pH is close to  $\text{pH}_0$ , (cf. Chap. 20).

The exchangeable Al:CEC ratio (with CEC measured at the soil pH) allows estimation of the risk of Al-phytotoxicity or Al tolerance for a given crop. Espiau and Peyronnel (1976, 1977) suggested the use of the rate of exchange acidity:

$$A\% = 100 \frac{A}{\text{effective } T}$$

Where  $A$  = exchangeable acidity extracted by  $1 \text{ mol (KCl) L}^{-1}$  solution =  $\text{Al}^{3+} + \text{H}^+ \text{ cmol (+) kg}^{-1}$  and effective  $T$  = effective CEC =  $\text{ECEC} = A + \Sigma(\text{K}^+, \text{Na}^+, \text{Ca}^{2+}, \text{Mg}^{2+})$  in  $\text{cmol (+) kg}^{-1}$ .

The desaturation percent is expressed by:  $100 \frac{T-S}{T}$  ( $T$  being the cation exchange capacity and  $S$  the sum of exchangeable cations). In many cases measurement of  $T-S$  at soil pH is sufficient.

## 23.2 Method

### 23.2.1 Principle

The sample is percolated with a not buffered 1 mol (KCl) L<sup>-1</sup> solution which enables extraction of exchangeable acidity (H<sup>+</sup> and Al<sup>3+</sup>). Titration is carried out by volumetry. Aluminium is measured either by volumetry or by atomic absorption spectrometry.

### 23.2.2 Reagents

- 1 mol L<sup>-1</sup> potassium chloride: weigh 74.56 g of KCl; dissolve in about 950 mL of deionized water; let the temperature stabilize and complete to 1,000 mL
- 0.025 mol L<sup>-1</sup> sodium hydroxide: dissolve 4 g of NaOH pellets in deionized water and after cooling, bring to 1,000 mL; titrate with the standard HCl solution; store in plastic bottles protected from air CO<sub>2</sub>; the solution should be freshly prepared at least once a week; titrated commercial solutions can be used but their concentration must be checked by titration
- 0.025 mol L<sup>-1</sup> hydrochloric acid: starting from a titrated commercial solution, prepare 0.1 mol L<sup>-1</sup> commercial solution
- Phenolphthalein: dissolve 100 mg phenolphthalein in 100 mL of 15% ethanol solution
- 1 mol L<sup>-1</sup> potassium fluoride (or possibly less soluble 40 g L<sup>-1</sup> sodium fluoride): dissolve 58.10 g KF in about 950 mL water, then bring to 1,000 mL.

### 23.2.3 Procedure

The moisture content of the air-dried soil should be measured on a separate sample to correct the results to soil dried at 105°C.

#### **Extraction**

- Place 10 g of soil sieved to 2 mm in a 100 mL beaker
- add 20 mL of 1 mol (KCl) L<sup>-1</sup> solution and leave in contact for 15 min agitating from time to time
- filter on thin analytical filter (blue filter)
- collect the filtrate in a 100 mL volumetric flask
- add fractions of approximately 10 mL of the KCl solution, leave in contact for 15 min after each addition
- after adding the last fraction, complete to 100 mL and homogenize
- the total duration of the extraction should be standardized at 120 – 150 min

#### **Measurement of Exchangeable Acidity**



- pour an aliquot of 25 mL of extract described in section 2.3.1 into a 250 mL Erlenmeyer flask; add three drops of phenolphthalein solution
- titrate with 0.025 mol (NaOH) L<sup>-1</sup> solution until the mixture turns pale pink
- add one drop of phenolphthalein and wait 1 min; the colour should remain stable; do not titrate to dark pink to limit the precipitation of aluminium hydroxide
- make two blank assays. Preserve the extracts to measure aluminium by titrimetry

#### **Calculation**

$$\text{Exchange acidity cmol (H}^+\text{) kg}^{-1} \text{ (soil)} = \frac{100 (x - y) M A f}{w}$$

$w$  is the weight of air dried soil,  $x$  is the mL NaOH used for titration,  $y$  is the mL NaOH used for blank assay,  $M$  is the molarity of NaOH,  $A$  is the aliquot factor (= 4),  $f$  is the correction factor to express results as soil dried at 105°C.

**Note**

This result can be used for effective cation exchange capacity (ECEC cf. Chap. 26)

$\text{ECEC} = \text{exchangeable acidity cmol (+) kg}^{-1} + \text{exchangeable cations (Ca}^{2+}, \text{Mg}^{2+}, \text{K}^+, \text{Na}^+)$ .

**Measurement of Exchangeable Aluminium**

Depending on the laboratory equipment available, exchangeable aluminium can be measured by atomic absorption or inductively coupled plasma spectrometry, or possibly by titrimetry or automated colorimetry with continuous-flow analysis (Pansu et al. 2001).

**Atomic Absorption Spectrometry**

- Prepare calibration ranges of 0, 10, 20, 30, 40, 50 mg (Al) L<sup>-1</sup> in 1 mol (KCl) L<sup>-1</sup> medium starting from a 500 mg (Al) L<sup>-1</sup> stock solution
- take absorption measurements at 309.3 nm in a C<sub>2</sub>H<sub>2</sub>/N<sub>2</sub>O flame directly on the extraction, calibration and blank solutions
- express the results in cmol (+) kg<sup>-1</sup> of aluminium and subtract from the exchangeable acidity to obtain exchangeable H<sup>+</sup>:  
exchangeable acidity = H<sup>+</sup> + Al<sup>3+</sup> in cmol (+) kg<sup>-1</sup>

This result can be used for the calculation of ECEC (cf. Chap. 26) by differentiating Al<sup>3+</sup> and H<sup>+</sup>.

**Titrimetry**

- To the 25 mL of solution used to measure exchangeable acidity (cf. “Measurement of Exchangeable Acidity”), add a micro-drop of 0.025 mol (HCl) L<sup>-1</sup> solution to return to just before the end point and to destroy the pale pink colour.
- add 10 mL of potassium fluoride 1 mol (KF) L<sup>-1</sup> to complex aluminium. If aluminium is present, the solution will again turn pink after the alkalizing reaction:  
Al(OH)<sub>3</sub> + 6 KF → K<sub>3</sub>AlF<sub>6</sub> + 3 KOH.  
(If the solution does not turn pink, it is not necessary to continue, and exchangeable aluminium can be considered to be absent)
- titrate with 0.025 mol (HCl) L<sup>-1</sup> solution until discolouration occurs. Wait 1–2 minutes and add one drop of phenolphthalein to check discolouration is permanent. The quantity of acid added corresponds to the quantity of exchangeable aluminium. Treat the blanks in the same way. They should not consume HCl. The difference between exchangeable acidity and exchangeable aluminium gives exchangeable protons.

**Calculation**

$$\text{Exchangeable aluminium cmol (1/3Al}^{3+}\text{) kg}^{-1} \text{ sol} = \frac{100 V M A f}{w}$$

Where  $w$  is the weight of air dried soil,  $V$  is the mL HCl used for titration,  $M$  is the HCl molarity,  $A$  is the aliquot factor (= 4),  $f$  is the correction factor to express results as soil dried at 105°C.

Exchangeable  $\text{H}^+$  ( $\text{cmol kg}^{-1}$ ) = exchangeable acidity ( $\text{cmol kg}^{-1}$ )  
exchangeable Al ( $\text{cmol (1/3Al}^{3+}\text{) kg}^{-1}$ ).

**Observations**

- The expression of results on the basis of soil dried at 105°C is particularly necessary for soils containing high rates of oxides and hydroxides, or aluminosilicates of the allophane type, because of the very variable but nevertheless high residual moisture content of air-dried soils. This form of expression enables comparison with other analytical results
- the presence of iron oxide can cause errors: if the extract is coloured by iron, it may be necessary to carry out iron titrations at the same time as aluminium titration by spectrometry
- the presence of soluble organic matter can obstruct volumetric titration.

**23.3 Other Methods**

The charge deficit can vary with the extraction medium (nature and concentration of the electrolyte, pH, etc.). The best extraction would be at the same pH as soil pH in the field with a liquid phase identical to the soil solution.

Many saline mediums have been tested to determine exchangeable aluminium selectively: either not buffered mediums at different concentrations which react at a pH near the soil pH, or buffered mediums at different pH.

Not buffered salts include: KCl (Yuan 1959), NaCl and BaCl<sub>2</sub> (McLean et al. 1959), NH<sub>4</sub>Cl, MgCl<sub>2</sub>, CaCl<sub>2</sub> (Skeen and Sumner 1967), LaCl<sub>3</sub> (Bloom, 1979), CuCl<sub>2</sub> (Juo and Kamprath 1979). Buffered salts include: acetates of K, Na, La, Cu at concentrations of from 0.2 to 1 or 2 mol L<sup>-1</sup>.

All these reagents allow extraction of different forms of Al<sup>3+</sup> which have been named, for example, exchangeable Al, organic matter associated Al, interfoliaceous Al or non-exchangeable polymeric hydroxy-Al.

The KCl method described in section 2 above is simple to use and seems to give the best performance, but the barium method is useful for more diversified studies (Pratt and Bair 1961, Skeen and Sumner 1965, Vermeulen et al. 1975, Espiau and Peyronnel 1976, Gillman 1979, Espiau and Pedro 1980). Thus, exchangeable acidity in an extract with barium chloride was the object of a proposal for the international NF ISO 14254 (1997) standard, as the extraction also allows the measurement of the effective cation exchange capacity and exchangeable cations (NF ISO 11260 1994).

## References

- Bloom PR (1979) Titration behavior of aluminum organic matter. *Soil Sci. Soc. Am. J.*, 43, 815–817
- Espiau P and Pedro G (1980) Caractérisation du complexe d'échange des sols acides. Le taux d'acidité d'échange et sa signification pédogénétique sous climat tempéré. *Ann. Agron.*, 31, 363–383
- Espiau P and Peyronel A (1976) L'acidité d'échange dans les sols. Méthode de détermination de l'aluminium échangeable et des protons échangeables. *Sci. du Sol.*, 3, 161–175
- Gillman GP (1979) A proposed method for the measurement of exchange properties of highly weathered soils. *Austr. J. Soil Res.*, 17, 129–139
- Juo ASR and Kamprat EJ (1979) Copper chloride as an extractant for estimating the potentially reactive Al pool in acid soils. *Soil Sci. Soc. Am. J.*, 43, 35–38
- NF ISO 14254 (1997) Détermination de l'acidité échangeable dans un extrait au chlorure de baryum, AFNOR, Paris, X31–422
- NF ISO 11260 (1994) Détermination de la capacité d'échange cationique effective et du taux de saturation en bases échangeables à l'aide d'une solution de chlorure de baryum. In *Qualité des sols*, AFNOR, Paris, 1996
- Pansu M, Gautheyrou J and Loyer JY (2001) *Soil analysis – sampling, instrumentation and quality control*. Balkema, Lisse, Abingdon, Exton, Tokyo, 489 p
- Pédro G (1987) Géochimie, mineralogie et organisation des sols. Aspects coordonnés des problèmes pédogénétiques. *Cah. ORSTOM Ser. Pédol.*, XXIII, 169–186
- Pratt PR and Bair FL (1961) A comparison of three reagents aluminium for the extraction of Aluminium. *Soil Sci.*, 91, 355–357
- Skeen JB and Sumner ME (1965) Measurement of exchangeable Aluminium in acid soils. *Nature*, 208, 712



## Chronobibliography

- Hissink DJ (1925) Base exchange in soils. *Trans. Far. Soc.*, 551–617
- Jackson ML (1963) Aluminium bonding in soils: a unifying principle in soil science. *Soil Sci. Soc. Am. Proc.*, 27, 1–10
- Little I (1964) The determination of exchangeable aluminium in soils. *Austr. J. Soil Res.*, 2, 76–82
- Rich CI (1970) Conductometric and potentiometric titration of exchangeable aluminium. *Soil Sci. Soc. Am. Proc.*, 34, 31–38
- Sivasubramaniam S and Talibudeen O (1972) Potassium–aluminium exchange in acid soils. I – Kinetics. *J. Soil Sci.*, 23, 163–176
- Herbillon AJ (1974) Modifications des propriétés de charge provoquées par l'altération chimique. *Pédol.*, 24, 100–118
- Rouiller J, Guillet B and Bruckert S (1980) Cations acides échangeables et acidités de surface. Approche analytique et incidences pédogénétiques. *Sci. du Sol.*, 2, 161–175
- Herbillon AJ (1981) Degree of weathering and surface properties of clays. In *Characterisation of soils in relation to their classification and management*, Greenland DJ ed. Oxford University Press, 5, 80–97
- Aleksandova AM, Krupskiy NK and Daragan YuV (1983) The nature of soil acidity. *Pochvovedeniye*, 3, 34–43
- Gillman GP and Sumpter EA (1985) KCl-extractable aluminium in highly weathered soils. Is it exchangeable? *Commun. Soil Sci. Plant Anal.*, 16, 561–568
- Logan Kab, Floate MJS and Ironside AD (1985) Determination of exchangeable acidity and exchangeable aluminium in hill soils. Part I – Exchangeable acidity. *Soil Sci. Plant Anal.*, 16, 301–308
- Wagatsuma T and Ezoe Y (1985) Effect of pH on ionic species of aluminium in medium and on aluminum toxicity under solution culture. *Soil Sci. Plant Nutr.*, 31, 547–561
- Manrique LA (1986) The relationship of soil pH to aluminum saturation and exchangeable aluminum in ultisols and oxisols. *Commun. Soil Sci. Plant Anal.*, 17, 439–455
- Willoughby EJ (1986) A comparison of methods for measuring aluminium in KCl extracts of soils. *Commun. Soil Sci. Plant Anal.*, 17, 667–677
- Wagatsuma T and Kaneko M (1987) High toxicity of hydroxy-aluminum polymer ions to plant roots. *Soil Sci. Plant Nutr.*, 33, 57–67
- Pansu M, Gavinelli R and Espiau P (1990) Etude de précision des mesures de l'acidité d'échange par KCl N dans les sols. In *Actes Journées laboratoires*, IRD (ex-Orstom), Paris, 114–126
- Bertsch PM and Bloom PR (1996) Aluminium. In *Methods of soil analysis, part 3 Chemical methods*, Bigham JM and Bartels JM ed., SSSA, ASA, Madison WI, Etats-Unis, 517–550
- Coscione AR, Andrade JC de, Raj B van (1998) Revisiting titration procedures for the determination of exchangeable acidity and exchangeable aluminum in soils. *Communications-in-Soil-Science-and-Plant-Analysis*, 29, 1973–1982

- 
- Derome J, Lindroos AJ (1998) Effects of heavy metal contamination on macronutrient availability and acidification parameters in forest soil in the vicinity of the Harjavalta Cu–Ni smelter, SW Finland, *Environmental-Pollution.*, 99, 225–232
- Filep G and Filep T (1999) Characterization of forms of potential soil acidity. A potenciales talajsavanyusag formainak jellemzese, *Agrok. Talajtan.*, 48, 33–48
- Dai KH and Richter DD (2000) A re-examination of exchangeable acidity as extracted by potassium chloride and potassium fluoride. *Commun. Soil. Sci. Plant Anal.*, 31, 115–139

## Lime Requirement

### 24.1 Introduction

#### 24.1.1 Correction of Soil Acidity

The English physicist Davy was the first to explain the effect of liming by the “neutralization of soil acidity” in 1813. The measurement of “lime requirement” (which is essential for land use of very acid soils) can be defined as the part of the charges that depend on pH between the natural soil pH and the pH required for a given crop. When total soil acidity is more than about 15% of cation exchange capacity, problems of phytotoxicity can appear depending on:

- Acidity itself for certain plants and micro-organisms
- Aluminic (and manganic) toxicity, by inhibition of root growth
- Induced deficiencies in major elements (e.g. Ca or Mg lixiviation) or in trace elements

This phenomenon can be very serious in soils with permanent charges of the 2:1 clay type. It can be corrected by amendments which decrease acidity and increase the pH to a level that enables better land use.

On the one hand, the increase in pH increases mineralization kinetics and on the other hand, decreases the value of soluble and exchangeable  $Al^{3+}$  which forms hydroxyaluminum polymers (cf. Chap. 23). These polymers improve the availability of phosphorus for plants.

Depending on the crop, the optimal pH will take into account (1) the economic constraints (minimum inputs and thus minimum cost for the best possible output), (2) plant tolerance to Al–Mn acidity and toxicity, (3) the mineralogical nature of clays and different colloids, (4) the quantity of organic matter, (5) climatic constraints and seasonal

variations in pH, (6) irrigation, (7) lixiviation and proton inputs during application of acidifying fertilizers.

The precipitation of  $\text{Al}^{3+}$ ,  $\text{Al}(\text{OH})_3$  or  $\text{Al}(\text{OH})\text{SO}_4 \cdot 5\text{H}_2\text{O}$  (jurbanite) can be induced by addition of calcium carbonate (limestone) or calcium sulphate (gypsum). Clay is then gradually saturated by  $\text{Ca}^{2+}$  ions which means fertilization must be balanced, or as an old French proverb puts it “liming without manuring brings unforeseen ruin”<sup>1</sup>.

In soils with variable charges in which the minerals are stable at relatively acid pH, the buffering effect is weak at pH 0 (cf. Chap. 20), but becomes strong on each side of pH 0. During liming, the increase in pH in these soils is slow and the study of the range between pH 4 and pH 6 – which is useful for agronomy – will suffice, as well as reaching the critical pH for  $\text{Al}(\text{OH})_3$  precipitation, i.e. 5.2–5.5. Many large-scale farms have improved their output by raising the soil pH to this level, as the assimilation of N, P, K, Ca, Mg, S, B and Mo is then facilitated. On the other hand, increasing pH to more than 7.5 can result in deficiencies in P, B, Zn, Fe, but can reduce Mn toxicity.

Increasing pH initially causes the neutralization of  $\text{H}^+$  sites then stops the genesis of exchangeable aluminium, and finally induces formation of  $\text{Al}(\text{OH})^{2+}$  and  $\text{Al}(\text{OH})_2^+$  polymers covering active surfaces of colloids and decreasing exchangeable acidity. In addition, the adsorbing complex becomes saturated with  $\text{Ca}^{2+}$  ions:

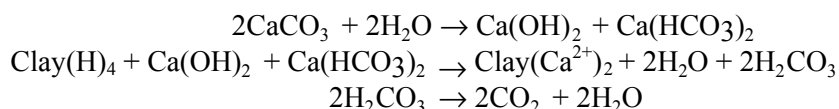

If the pH drops at the level of the plant roots (acid exudation), the exchangeable  $\text{Ca}^{2+}$  cations again pass in solution. In soils containing 2:1 clays where acidity is aluminic, phosphorus is precipitated in the form of aluminum phosphate; by eliminating soluble  $\text{Al}^{3+}$ , liming modifies the fixing of P.

If exchangeable Al is neutralized (polymeric Al, organo-Al compounds), sites are created that are accessible for cation exchange and CEC increases slightly.

### 24.1.2 Calculation of Correction

In the laboratory, lime requirement is expressed in milli-equivalents of  $\text{CaCO}_3$  per kg of soil and in agronomy in tons of  $\text{CaCO}_3$  per hectare.

<sup>1</sup> In French: “*Qui chaule sans fumer, se ruine sans y penser*”.

Initially, due to their lack of knowledge on the complexity of exchange in different soils, when trying to correct soil pH agronomists systematically aimed for neutrality. The lime requirement could then be estimated from  $T - S$  ( $T$  being total cation exchange capacity in buffered solution at pH 7,  $S$  being the sum of exchangeable cations).

Mehlich (1939) located the lime requirement between the exchangeable acidity extracted by a not buffered saline solution and the total acidity neutralized by a buffer solution adjusted to pH 8.1. An estimate of the exchangeable acidity per  $T - S$  with  $T$  measured at soil pH also enables calculation of the quantity of calcium needed for the correction of acidity (Duchaufour and Souchier 1980).

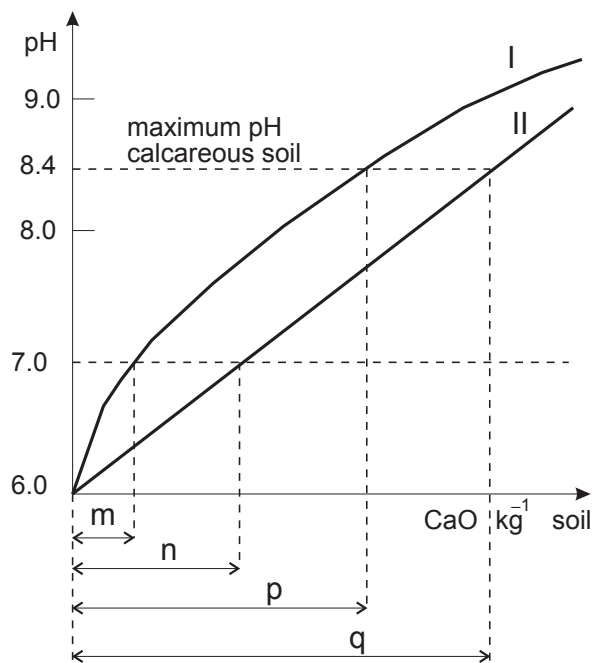

**Fig. 24.1.** Chaminade method (1933). I, pH values measured at  $T_0$ ; II, pH values measured at T48 h

$$x = n \frac{q}{p - m + n} = \text{CaO\% soil necessary for neutralization at pH 7.0}$$

$$(\text{CaCO}_3/\text{CaO}) = (100/56) = 1.786$$

Lime requirements can also be evaluated by titration using techniques similar to those used for the measurement of exchange acidity (cf. Chap. 23) or with pH0 and measurement of charge (cf. Chaps. 20 and 21). However, equilibrium takes a long time to establish in the soils and most

acidity is not detectable by instantaneous reaction with a base. The analytical determination is influenced by the degree of weathering, the content of clay and organic matter, the forms of acidity and the initial soil pH. Thus the amount of crushed limestone measured in the laboratory in soils from Congo would not cause exactly the expected increase of pH in natural conditions (Djondo 1995). In practice, the three following types of approach are used:

- Analysis by incubation with limestone; this is a time-consuming method in which laboratory conditions closely resemble field conditions (moisture, temperature, microbial activity).
- Incubation with progressively increasing quantities of calcium hydroxide (lime water) and titration after contact of a few hours.
- Soil–buffer equilibration enabling acidity to be neutralized without subjecting the soil to a pH higher than that desired, taking into account the soil matrix and the crops to be cultivated.

Lime water methods (of which the stability is random since it is closely linked with the composition of the surrounding atmosphere) combined with measurements of pH at times T0 and T48 h (Fig. 24.1) were formerly used to correct soil acidity (Chaminade 1933). These methods have been more or less abandoned because of the temporary excessive rise in pH they cause. The procedure described in Sect. 24.2 below concerns an equilibration technique with buffer solutions.

## 24.2 SMP Buffer Method

### 24.2.1 Principle

This method was proposed by Shoemaker, McLean and Pratt (1962) which explains its name ‘SMP’. A complex buffer is used with a pH close to neutral, that of carbonate–bicarbonate–CO<sub>2</sub> equilibrium of the soil atmosphere at normal pressure. It enables neutralization of both bases and acids and avoids variations in pH in a soil system that itself possesses buffering power. In this way, the soil is not subjected to localized increases in pH that are too high.

The pH of a solution expresses the energy level of protons, the pH of a buffer measures potential acidity. The change in pH of the buffer enables quantification of the lime requirement of soils whose initial pH water is lower than 6.0 and whose aluminic toxicity is high.

The method described here is that of the double buffer (McLean 1982; Sims 1996) partly based on the procedure of the initial SMP method

(Shoemaker, McLean and Pratt 1962) of equilibration in a buffer solution and partly on a supplement to this procedure (McLean et al. 1977, 1978).

### 24.2.2 Reagents

#### *SMP buffer solution at pH 7.5*

- Weigh 3.24 g of p-nitrophenol  $C_6H_5NO_3$  (mw = 139.11).
- Weigh 5.40 g of potassium chromate  $K_2CrO_4$  (mw = 194.20).
- Weigh 95.58 g of calcium chloride dihydrate  $CaCl_2 \cdot 2H_2O$  (mw = 147.03)  
Place these in a 2 L Pyrex bottle (with a graduation mark at 1,800 mL) with approximately 900 mL water. Agitate by turning the bottle upside down and back for 5 min to avoid caking → solution A.
- Weigh 3.60 g of calcium acetate  $Ca(CH_3COO)_2 \cdot H_2O$ , mw = 176.18 and dissolve in 500 mL of deionized water → solution B.
- Mix solution A and solution B → solution C; shake for 3 h on a rotary shaker.
- Add 4.5 mL of triethanolamine  $N(CH_2-CH_2OH)_3$  mw = 149.19 and shake for 8 h on a rotary shaker → solution D.
- Bring to 1,800 mL and adjust to pH 7.5 with a 0.2 mol (NaOH)  $L^{-1}$  solution with pH meter.
- Filter and preserve from free atmospheric carbon dioxide with a trap made from a tube filled with ascarite (asbestos impregnated with soda) between two tubes filled with drierite or anhydrite (anhydrous calcium sulphate); use rapidly.

### 24.2.3 Procedure

In a 50 mL centrifugation tube that can be closed hermetically:

- Weigh 5 g (equivalent weight of soil dried at 105°C) of air-dried soil sieved to 0.5 mm.
- Add 5 mL water.
- Mix and leave in contact for 1h.
- With a pH meter previously standardized between pH 7.0 and 4.0, measure the pH of the soil suspension while agitating the electrode in the fluid paste until a stable reading is reached (cf. Chap. 15) →pH water.
- Add 10 mL of SMP buffer solution to this suspension and agitate for 15 min; let stand for 15 min, agitate until stabilization and measure the pH

of the suspension  $\rightarrow$   $\text{pH}_1$  soil-buffer; this is the pH of the suspension before addition of any acid.

- Add to the suspension an aliquot of HCl at the quantity required to bring 10 mL of buffer solution from pH 7.5 to pH 6.0 (1 mL of HCl  $0.206 \text{ mol L}^{-1} = 0.206 \text{ mmol L}^{-1}$ ).
- Agitate for 10 min – let stand for 30 min and read the pH of the suspension while agitating  $\rightarrow$   $\text{pH}_2$  soil-buffer; this is the final pH of the soil-buffer suspension after addition of HCl acid.

The acidity “ $A$ ” measured in mmol ( $\text{H}^+$ ) for 5 g of soil is written:

$$A = \Delta \text{pH}_2 \frac{\Delta d_2^0}{\Delta \text{pH}_2^0} + \left[ \left( \Delta \text{pH}_1 \frac{\Delta d_1^0}{\Delta \text{pH}_1^0} - \Delta \text{pH}_2 \frac{\Delta d_2^0}{\Delta \text{pH}_2^0} \right) \left( \frac{6.5 - \text{pH}_2}{\text{pH}_1 - \text{pH}_2} \right) \right],$$

where  $\Delta \text{pH}_1$  is  $7.5 - \text{pH}_1$ ,  $\Delta \text{pH}_2$  is  $6.0 - \text{pH}_2$ ,  $\frac{\Delta d_1^0}{\Delta \text{pH}_1^0}$  is

change in acidity per unit change in pH of 10 mL of pH 7.5 buffer obtained by titration with standard HCl, i.e. approximately 0.137 mmol per unit of pH,

$$\frac{\Delta d_2^0}{\Delta \text{pH}_2^0} = \text{change in acidity per unit change in pH of}$$

10 mL of pH 6 buffer, i.e. approximately 0.129 mmol per unit of pH,

6.5 is the desired pH of the soil after liming (another pH can be selected).

The lime requirement (LR) is expressed in the laboratory by:

$$\text{LR in cmol (+) kg}^{-1} = 1.69 (20 A) - 0.86 = 33.8 A - 0.86$$

and in field units at a depth of 20 cm:

$$\text{LR in ton ha}^{-1} = 45.5 A - 1.16.$$

#### 24.2.4 Remarks

This method takes total  $\text{H}^+$ , and soluble and exchangeable aluminum into account. It is suitable for soils which require lime correction of more than 1 ton per hectare (soil depth of 20 cm) whose pH is lower than 5.8–6.0.

The content of organic matter should not exceed about 15%. It is not usually necessary to make this measurement on soils with a pH of more than 6.0, as in this case the soil does not require liming, but possibly calcic fertilizer. Very organic soils are only significantly improved by liming if their pH is lower than 5.3.



The method of Adams and Evans (1962) is also a rapid technique for equilibration in buffer solution (pH 8.0), it is often used in sandy soils or soils with low organic matter contents.

## References

- Adams F and Evans CE (1962) A rapid method for measuring lime requirement of red-yellow podzolic soils. *Soil Sci. Soc. Am. Proc.*, 26, 355–357.
- Chaminade R (1933) Mode d'action de la chaux sur les sols et correction de leur activité. *Ann. Agron.*, 453–477.
- Davy H (1813) *Elements of agricultural chemistry.*, Longman éd.
- Djondo MY (1995) *Propriétés d'échange ionique des sols ferrallitiques argileux de la vallée du Niari et sableux du plateau Mbe-Bateke au Congo - application à la correction de leur acidité.*, Thèse, Document IRD (ex-Orstom) Montpellier, France, 5.
- McLean EO, Trieweiler JF and Eckert DJ (1977) Improved SMP buffer method for determining lime requirement in acid soils. *Commun. Soil Sc. Plant Anal.*, 8, 667–675.
- McLean EO, Eckert DJ, Reddy GY and Trierweiler JF (1978) An improved SMP soil lime requirement method incorporating double-buffer and quick-test features. *Soil Sci. Soc. Am. J.*, 42, 311–316.
- McLean EO (1982) Soil pH and lime requirement. In *Methods of soil analysis. Part 2. Chemical and microbiological properties* 2nd edition, Page AL ed., *Am. Soc. Agronomy.*, *Soil Sci. Soc. Am.*, 199–224.
- Shoemaker HE, McLean, EO and Pratt PF (1962) Buffer methods for determination of lime requirement of soils with appreciable amount of exchangeable aluminium. *Soil Sci. Soc. Am. Proc.*, 25, 274–277.
- Sims JT (1996) Lime requirement. In *Methods of soil analysis. Part 3. Chemical methods*, Bigham JM and Bartels JM, *Soil Sci. Soc. Am.*, *Am. Soc. Agronomy*, Madison, WI, 491–515.
- Mehlich A (1939) Use of triethanolamine acetate-baryum hydroxide buffer for the determination of some base-exchange properties and lime requirement of soil. *Soil Sci. Soc. Am. Proc.*, 3, 162–166.

## Chronobibliography

- Davy H (1813) *Elements of agricultural chemistry.*, Longman, éd.
- Clark JS and Nichol WE (1966) The lime potential, percent base saturation relations of acid surface horizons of mineral and organic soils. *Can. J. Soil Sci.*, 46, 281–315.
- Collins JB, Whiteside EP and Cress CE (1970) Seasonal variability of pH and lime requirements in several southern Michigan soils when measured in different ways. *Soil Sci. Soc. Am. Proc.*, 34, 56–61.

- Kamprath EJ (1970) Exchangeable aluminium as a criterion for liming leached mineral soils. *Soil Sci. Soc. Am. Proc.*, 34, 252–254.
- McLean EO (1970) Lime requirements of soils. In active toxic substances or favorable pH range ? *Soil Sci. Soc. Am. Proc.*, 34, 363–364.
- CAB (1971) Annotated bibliography no 1529. *Liming of tropical soils*, 1971–1959. CAB : 25 pages, 101 references.
- Yuan TL (1974) A double buffer method for the determination of lime requirement of acid soils. *Soil Sci. Soc. Am. J.*, 38, 437–440.
- Almeida de AM and Bornemisza E (1977) Efecto del encalado sobre las cargas electricas y otras propiedades quimicas de tres inceptisoles de Costa-Rica. *Turrialba*, 27, 333–342.
- McLean EO (1978) Principles underlying the practice of determining lime requirements of acid soils by use of buffer methods. *Commun. Soil Sci. Plant Anal.*, 9, 699–715.
- Cochrane TT, Salinas JG and Sanchez RA (1980) An equation for liming acid mineral soils to compensate crop aluminium tolerance. *Trop. Agric.*, 57, 133–139.
- Duchaufour P and Souchier B (1980) pH et besoins en chaux. *C. R. Acad. Agric. (Fr.)*, 66, 391–399.
- Totev TP, Palaveyev TD and Kolarov V (1982) Advantages of a KCl extracts for determining soil acidity and liming requirements. *Pochvovedeniye*, 3, 117–120.
- Nômmik H (1983) A modified procedure for rapid determination of titrable acidity and lime requirement in soils. *Acta Agric. Scand.*, 33, 337–348.
- Oates KM and Kamprath EJ (1983) Soil acidity and liming. I : effect of the extracting solution cation and pH on the removal of aluminium from acid soils. *Soil Sci. Soc. Am. J.*, 47, 686–689.
- Oates KM and Kamprath EJ (1983) Soil acidity and liming. II - Evaluation of using aluminum extracted by various chloride salts for determining lime requirements. *Soil Sci. Soc. Am. J.*, 47, 690–692.
- Pavan MA, Bingham FT and Pratt PF (1984) Redistribution of exchangeable calcium, magnesium, and aluminum following lime or gypsum applications to a brazilian oxisol. *Soil Sci. Soc. Am. J.*, 48, 33–38.
- Haile A, Pieri C and Egoumenides C (1985) Effet des amendements minéraux sur les propriétés d'échange de sols acides tropicaux. *Agron. Trop.*, 40, 98–106.
- Alva AK, Edwards DG, Asher CJ and Blamey FPC (1986) Effects of phosphorus/aluminum molar ratio and calcium concentration on plant response to aluminum toxicity. *Soil Sci. Soc. Am. J.*, 50, 113–137.
- Harvey KC and Dollhoph D (1986) *Acid mine-soil reclamation advancements in the Northern plains.*, Montana State Univ. Res. Publ. (01).
- Meng Ci-Fu, Luu Yong-Jin, Kong Fan-Gen and Shui jian-Guo (1986) Effects of limestone on soil acidity and crop yields on a red earth. *Soil Science Society of China. Current progress in soil research in people's republic of China*, 377–383.

- Borges AL, Braga JM, Defelipo BV, Ribeiro AC and Thiebaut JTL (1987) Evaluation of analytical methods for estimating soil liming requirement. *Revista Cérès*, 34, 17–32.
- Nobrega de MT (1988) *Contribuição ao estudo da estabilização de solos tropicais com adição de cal para fins rodoviários. Aspectos mineralógicos e morfológicos de alguns solos das regiões sul e sudeste do Brasil.*, Dissertação de mestrado University Sao Paulo, 189 p.
- Bailey JS, Stevens RJ and Kilpatrick DJ (1989) A rapid method for predicting the lime requirement of acidic temperate soils with widely varying organic matter contents: I - development of the lime requirement model. *J. Soil Sci.*, 40, 807–820.
- Naidu R, Syers JK, Tillman RW and Kirkman JH (1990) Effect of liming and added phosphate on charge characteristics of acid soils. *J. Soil Sci.*, 41, 157–164.
- Rossi PL, Ildefonse P, Nobrega de AT and Chauvel A (1990) Transformations mineralogiques et structurales d'argiles latéritiques brésiliennes provoquées par l'addition de chaux. In *ORSTOM Séminaire «Organisation et fonctionnement des altérites et des sols.*, (5 fév.) Thème 5 (multigraphié).
- Aitken RL, Moody PW, Dickson T, Date RA (ed.), Grundon NJ (ed.); Rayment G.E. (ed.), Probert ME (1995). In *Plant–soil interactions at low pH: principles and management. Proceedings of the Third International Symposium, Brisbane.*, Kluwer; Dordrecht, 479–484.
- Tsakelidou R (1995) Comparison of lime requirement methods on acid soils of northern Greece. *Commun. Soil Sci. Plant Anal.*, 26, 541–551.
- Owusu-Bennoah E, Acquaye DK, Mahamah T (1995) Comparative study of selected lime requirement methods for some acid Ghanaian soils. *Commun. Soil Sci. Plant Anal.*, 26, 937–950.
- Coutinho J (1997) Calibration of the single- and double- buffer SMP lime requirement methods by root elongation bioassay, *Commun. Soil Sci. Plant Anal.*, 28, 1127–1139.
- Pottker D and Ben JR (1998) Lime for a crop rotation under direct planting. Calagem para uma rotação de culturas no sistema plantio direto. *Revista Brasileira de Ciencia do Solo*, 22, 675–684.
- Quigley MN, Wallace A (ed.) and Terry RE (1998) Testing soils for lime requirement. In *Handbook of soil conditioners: substances that enhance the physical properties of soil*, Dekker, New York, 293–308.
- Rossel RAV and McBratney AB (1998) A response-surface calibration model for rapid and versatile site-specific lime-requirement predictions in south-eastern Australia, *Aust. J. Soil Res.*, 2001, 39, 185–201.
- Gustafsson K and Stafford JV (1999) Models for precision application of lime. In *Precision agriculture, Papers-presented at the 2nd European*

- Conference on Precision Agriculture*, Odense, Denmark, 11–15 July 1999, Sheffield Academic, Sheffield, UK.
- Pintro JC and Tesaro MD (1999) Correction of an acid soil using the base saturation method and influence on chemical parameters. *Acta Scientiarum*, 21, 479–482.
- Rajkhowa KM and Talukdar MC (1999) Lime requirement of soils as influenced by soil test methods, *J. Agri. Sci. Soc. North East India*, 12, 9–12.
- Rossel RAV, McBratney AB and Stafford JV (1999) Calibration of a lime requirement buffer for site-specific lime applications in South-Eastern Australia. In *Precision agriculture, Papers-presented at the 2nd European Conference on Precision Agriculture*, Odense, Denmark, 11–15 July 1999, Sheffield Academic, Sheffield, UK.
- Martins E de S, Linhares NW, Giustina C and de S Martins E (2000) Rock analysis reference method for correcting soil acidity. Metodo de referencia para caracterizacao de rochas utilizadas como corretivos de acidez do solo. Comunicado-Tecnico -Embrapa-Cerrados., No.38, 3 p.
- Gilmour JT and Anderson P (2001) A new approach to lime recommendations in Arkansas. *Res. Ser. Arkansas Agri. Exp. Station*, 480, 39–41.
- Ozenc DB and Mehlenbacher SA (2001) Methods of determining lime requirements of soils in the Eastern Black Sea hazelnut growing region. *Acta Horticulturae*, 556, 335–341.

## Exchange Selectivity, Cation Exchange Isotherm

### 25.1 Introduction

The study of the adsorption-desorption properties of the exchange complex by measurement of exchangeable cations (cf. Chap. 22) can be supplemented by the measurement of exchange selectivity which enables a better understanding of the exchange processes during soil weathering.

When a soil is subjected to cycles of leaching–retention, the state of the exchange complex can be measured by evaluating the retention of exchangeable cations. This measurement only indirectly reflects the possible selectivity of a system for a given element. Indeed, if the exchange properties of the soils were only under the influence of the concentration and the charge of the cations, the ratios between cations fixed on the complex would be identical to the ratios of the same cations in solution. The soluble elements of the parent rock would then be fixed at their respective concentrations. Other factors occur that modify the retention properties of two cations (or anions) A and B whose charge is identical:

$$\frac{A \text{ solution}}{B \text{ solution}} = K \frac{A \text{ adsorbed}}{B \text{ adsorbed}}$$

where  $K$  is the selectivity coefficient. It expresses the inequality of the activity ratios of A and B ions in solution and adsorbed.

By measuring the changes in composition of the adsorbed phase and of the liquid phase containing ions added in given proportions, an exchange isotherm can be built. The term isotherm, which refers to thermodynamics, should not mask other significant variables of the system such as ion valences and concentrations, the degree of hydration, the density of charges of colloids. An isotherm is a partition diagram which results in a

graph of the balance of ion concentrations between an ionic liquid phase and a solid exchange matrix at constant ionic strength. The ionic strength of the liquid phase or the temperature can also be changed to determine thermodynamic parameters.

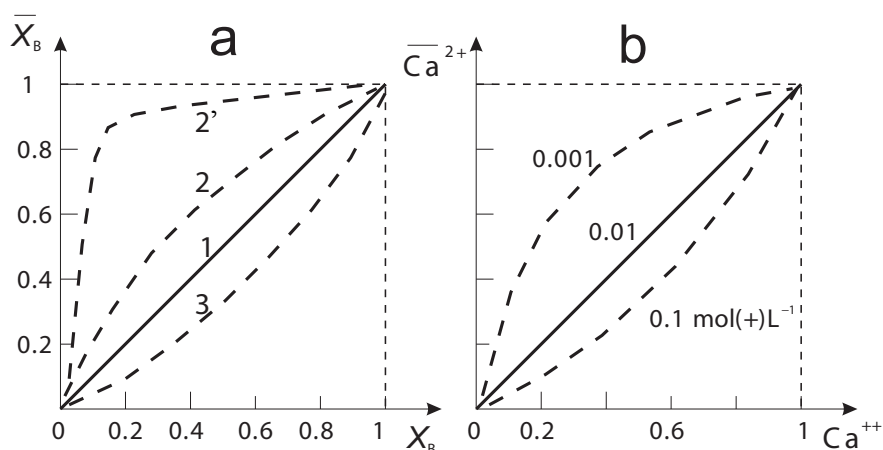

**Fig. 25.1. (a)** Exchange isotherm at constant concentrations and ionic strength:

$\bar{X}_B = f(X_B)$ , where  $\bar{X}_B$  equivalent fraction of the B ion retained by the exchanger and  $X_B$  equivalent fraction of the B ion in solution. 1, linear isotherm - no selectivity, same affinity for ions A and B. 2, selectivity for A. 2', strong selectivity for A. 3, selectivity for B (Sometimes S-curves can be observed with inversion of selectivity starting from a certain concentration. The curve then crosses 1 at the inversion point), (b) isotherm variable with concentration and ionic force (dilution effect) ex:  $Na^+$  homoionic system and displacement  $Na^+ - Ca^{2+}$ . The variability of the selectivity coefficient with the ionic strength of the solution poses a problem for the portion of the equations concerning the liquid phase

As shown in Fig. 25.1a and b, only graphs plotted under the same conditions of temperature, concentration and ionic force should be compared in order to avoid erroneous interpretation. Measurement of the ion moved during adsorption in a homoionic system enables the constancy of the cation exchange capacity to be verified.

The soil components form an inorganic and organic complex exchange matrix including reactions that are often very different. This analysis can be performed either on the whole soil or on fractions selected by granulometry and/or chemical treatments.

All exchange selectivity equations take the ratios of the ion activities in solution into account. The law of the exchange ratios of Schofield (1967) specifies the conditions of selectivity of the mono-, di- and trivalent ions.

Since studies by Kerr (1928), many empirical equations have been established, improved or simplified to make them suitable for different soil situations and to attempt to replicate field conditions under a variety of mineralogical and climatic constraints.

The Kerr equation (1928)

$$K_{\text{Kerr}} = \frac{[M_{\text{adsorbed}}^{y+}]^x [M_{\text{solution}}^{x+}]^y}{[M_{\text{adsorbed}}^{x+}]^y [M_{\text{solution}}^{y+}]^x}$$

is for a heterovalent system ( $M^+$  is the monovalent cation and  $M^{2+}$  is the divalent cation)

$$K_{\text{Kerr}} = \frac{[M_{\text{adsorbed}}^+]^2 [M_{\text{solution}}^{2+}]}{[M_{\text{adsorbed}}^{2+}] [M_{\text{solution}}^+]^2}$$

In the processes of heterovalent exchange, modification of the Kerr equation by Vanselow (1932) allows the cumulated activities of the ions to be taken into account:

$$K_{\text{Vanselow}} = \frac{[M_{\text{adsorbed}}^{y+}]^x [M_{\text{solution}}^{x+}]^y}{[M_{\text{adsorbed}}^{x+}]^y [M_{\text{solution}}^{y+}]^x} [M_{\text{adsorbed}}^{y+} + M_{\text{adsorbed}}^{x+}]^{y-x}$$

for example in a  $\text{Ca}^{2+}$ - $\text{NH}_4^+$  system:

$$K_V = \frac{[\text{NH}_4^+_{\text{adsorbed}}]^2 [\text{Ca}^{2+}_{\text{solution}}]}{[\text{Ca}^{2+}_{\text{adsorbed}}] [\text{NH}_4^+_{\text{solution}}]^2} \frac{1}{[\text{Ca}^{2+}_{\text{adsorbed}} + \text{NH}_4^+_{\text{adsorbed}}]}$$

Following statistical studies, this equation was again modified by Krishnamoorthy and Overstreet (1949) by assigning variable coefficients to the ions according to valence, which gave the general equation:

$$K_{K-O} = \frac{[M_{\text{adsorbed}}^{y+}]^x [M_{\text{solution}}^{x+}]^y}{[M_{\text{adsorbed}}^{x+}]^y [M_{\text{solution}}^{y+}]^x} [a M_{\text{adsorbed}}^{x+} + a M_{\text{adsorbed}}^{y+}]^{y-x},$$

where  $a = 1$  for the monovalent cations, 1.5 for the divalent cations, and 2.0 for the trivalent cations. In a system of di- and monovalent ions:

$$K_{K-O} = \frac{[M_{\text{solution}}^{2+}] [M_{\text{adsorbed}}^+]^2}{[M_{\text{solution}}^+]^2 [M_{\text{adsorbed}}^{2+}]} \frac{1}{[M_{\text{adsorbed}}^+ + 1,5 M_{\text{adsorbed}}^{2+}]}$$

To correct the solvent effects in the Kerr formula, Gaines and Thomas (1983) introduced a factor that took into account the fraction of the sites occupied by a cation A and molar quantities of adsorbed cations.

$$K_{G-T} = \frac{[M_{\text{adsorbed}}^{y+}]^x [M_{\text{solution}}^{x+}]^y}{[M_{\text{adsorbed}}^{x+}]^y [M_{\text{solution}}^{y+}]^x} \frac{x}{y} \left[ x M_{\text{adsorbed}}^{x+} + y M_{\text{adsorbed}}^{y+} \right]^{y-x}$$

$$= \frac{x}{y} K_{\text{Kerr}} \left[ x M_{\text{adsorbed}}^{x+} + y M_{\text{adsorbed}}^{y+} \right]^{y-x}$$

in a binary heterovalent system:

$$K_{G-T} = \frac{[M_{\text{solution}}^{2+}] [M_{\text{adsorbed}}^+]^2}{[M_{\text{solution}}^+]^2 [M_{\text{adsorbed}}^{2+}]} \frac{1}{2 [M_{\text{adsorbed}}^+ + 2 M_{\text{adsorbed}}^{2+}]}$$

All these equations are based on molar expression. The coefficient of Gapon (1933) was also widely used, but was subject to criticism (Sposito, 1977) because it was based on an expression in equivalents:

$$K_{\text{Gapon}} = \frac{[M_{\text{adsorbed}}^{y+}]}{[M_{\text{adsorbed}}^{x+}]} \frac{(M^{x+})^{1/x}}{(M^{y+})^{1/y}}$$

is in a 1–2 system:

$$K_{\text{Gapon}} = \frac{[M_{\text{adsorbed}}^+]}{[M_{\text{adsorbed}}^{2+}]_2} \frac{(M_{\text{solution}}^{2+})^{1/2}}{(M_{\text{solution}}^+)}$$

Selectivity equations were established for certain soils with specific problems, for example saline soils (sodic-salic) with  $\text{Na}^+$ ,  $\text{Ca}^{2+}$ ,  $\text{Mg}^{2+}$  systems (Richards, 1954; cf. Chap. 18). An equation for sodium adsorption ratio (SAR) is used:

$$\text{SAR}_{(\text{mmoles L}^{-1})} = \frac{[\text{Na}^+]}{([\text{Mg}^{2+}] + [\text{Ca}^{2+}])^{1/2}}$$

Generally, SAR is given simultaneously with the exchangeable sodium ratio (ESR).

$$\text{ESR}_{(\text{cmol Kg}^{-1})} = \frac{\text{Na}_{\text{ech}}}{\text{CEC} - \text{Na}_{\text{ech}}}$$

In  $\text{K}^+$ ,  $\text{Ca}^{2+}$ ,  $\text{Mg}^{2+}$  systems a nonreversible exchange or a nonlinear exchange is often observed, often with low rates of  $\text{K}^+$  compared to  $\text{Ca}^{2+}$  and  $\text{Mg}^{2+}$ . The potassium adsorption ratio (KAR or PAR) can enable interpretation of the effects of liming (cf. Chap. 24) on the activity



ratios and  $K^+$  release. Affinity order, often called lyotropic series, can be modified by the mineral matrix, for example 2:1 smectites preferentially adsorb the least hydrated cations likely to be fixed in the interfoliaceous cavities.

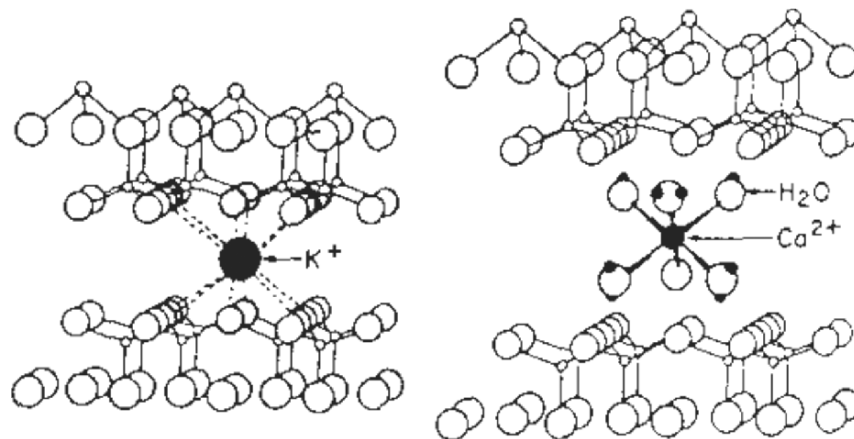

**Fig. 25.2.** Adsorption of  $K^+$  and  $Ca^{2+}$  (Sposito 1984): inner-sphere surface complex of potassium in vermiculite (*left*), outer-sphere surface complex of calcium in montmorillonite (*right*).

In practice, the exchange complex of anthropic soils can be modified by selectively adsorbed anions (e.g. phosphate-enriched fertilizers), elimination of organic matter by burning or deforestation, changes in oxide contents, etc. This can lead to different relative equilibration rates which have to be measured in agronomical and soil genesis studies. Modifications in the relative concentrations of cations in the soil solution also modify the trophic capacity per unit of time. This selectivity is due to reactions governed by chemical thermodynamics.

For example with monovalent ions and 2:1 smectites there is no selectivity if the adsorption mechanisms only use outer-sphere surface complexes (for example calcium hexahydrated ion in montmorillonite, Fig. 25.2). On the other hand, if inner-sphere complexes are formed (inclusion of potassium ion in vermiculite for example), there is necessarily exchange between water molecules of cation solvation and the hydroxyl ions of surface functional groups.

The complexes with inner-sphere surface, which are more stable, form a Lewis base with the monovalent cations, which are rather weak acids because of their solvation by water molecules. The ionization energy and the ionic radius of the monovalent cations give the sequence:  $Cs^+ > Rb^+ > K^+ \cong NH_4^+ > Na^+ > Li^+$  for the stability of the complexes with inner-sphere surface formed in the siloxane cavities.

For di- or plurivalent cations, the problem is more complex, cations can present different valences depending on redox conditions of the medium, and a complex of the ligand type can be neo-formed in the soluble phase (congruent and incongruent isotherms).  $\text{Ca}^{2+}$  and  $\text{Mg}^{2+}$  can produce  $\text{CaCl}^+$  and  $\text{MgCl}^+$  complexes presenting higher affinities than the free  $\text{Ca}^{2+}$  and  $\text{Mg}^{2+}$  cations. The selectivity of Ca on Mg could be explained by the better thermodynamic stability of  $\text{CaCl}^+$  (Sposito et al. 1983).

## 25.2 Determination of the Exchange Isotherm

### 25.2.1 Principle

The different points of the isotherm are plotted by means of a not buffered ionic binary liquid phase whose total equivalent concentration is constant (Sondag et al. 1990). In this binary mixture, each ion can react alone or in relation to the other ions. For each point, the proportion of the two cations is variable. After saturation of the sample, allow it to reach equilibrium (at the end of cation adsorption), then desorb the two cations with a counter-ion. Titrate the two cations by atomic absorption or inductively coupled plasma spectrometry and plot the isotherm, using the model with two sites (Duffey and Delvaux 1989) which enables a realistic approach to the functioning of the soil when it is subjected to variable hydrous and chemical constraints.

### 25.2.2 Reagents

*First solution of equilibration-saturation* ( $\text{K}^+$ - $\text{Ca}^{2+}$  equilibrium). From potassium chloride (mw = 74.56), prepare a 1 mol (KCl)  $\text{L}^{-1}$  solution and from anhydrous calcium chloride (mw = 110.99) a 1 mol ( $\text{CaCl}_2$ )  $\text{L}^{-1}$  solution. Prepare K-Ca stock solutions 1 mol (+)  $\text{L}^{-1}$  corresponding to the  $\frac{\text{K}}{\sqrt{\text{Ca}}}$  ratios in Table 25.1.

*Second K-Ca equilibration solutions.* Prepare as above but with 0.01 mol (+)  $\text{L}^{-1}$  solutions (Table 25.1).

*Desorption solution* 1 mol  $\text{L}^{-1}$  ammonium chloride prepared from  $\text{NH}_4\text{Cl}$  (mw = 53.49)

*Standard solution: ranges*

$\text{K}^+$  0–6  $\text{mg L}^{-1}$ ,  
 $\text{Ca}^{2+}$  0–6  $\text{mg L}^{-1}$ ,  
 $\text{Al}^{3+}$  0–1  $\text{mg L}^{-1}$ .

**Table 25.1.** Composition of equilibration solutions (total normality = 0.01 (+) L<sup>-1</sup>;  $N_K$  and  $N_{Ca}$  = K and Ca normalities)

$K/\sqrt{Ca}$ (mol L <sup>-1</sup> ) <sup>1/2</sup>	K(mmol L <sup>-1</sup> )	Ca(mmol L <sup>-1</sup> )	$N_K$ (Meq (+) L <sup>-1</sup> )	$N_{Ca}$ (meq (+) L <sup>-1</sup> )
0.2	0.44	4.78	0.44	9.56
0.4	0.86	4.57	0.86	9.14
0.8	1.64	4.18	1.64	8.36
1.6	2.99	3.50	2.99	7.01
2.4	4.12	2.94	4.12	5.88
3.2	5.04	2.48	5.04	4.96
6.6	7.45	1.27	7.45	2.55
29.6	9.78	0.11	9.78	0.22

### 22.2.3 Procedure

- Tare a series of eight 50 mL centrifugation tubes
- weigh 3 g of air-dried soil in each tube.

#### **First Equilibration**

- In each tube, add 25 mL of K + Ca 1 mol (+) L<sup>-1</sup> solution with a  $K/\sqrt{Ca}$  ratio corresponding to the isotherm to be determined
- shake for 1 h, centrifuge and decant the supernatant
- wash quickly with deionised water to put the centrifugation pellet in suspension
- centrifuge; repeat this treatment twice.

### ***Isotherm Measurement***

- Carry out six successive equilibrations with 25 mL of 0.01 mol (+) L<sup>-1</sup> K–Ca solution with a  $\frac{K}{\sqrt{Ca}}$  ratio corresponding to that of the isotherm to be determined (with no intermediate washing with water)
- for each equilibration, maintain contact for 30 min
- centrifuge at 5,000g
- after the sixth equilibration, titrate K and/or Ca and continue equilibrations if the value is different from that of the corresponding exchange solution (a simple check of equality of spectrometric absorbance is sufficient)
- when equilibrium is reached, determine the exact K and Ca concentration (which is always a little different from the initial concentration) and measure aluminium in order to check that it is not involved in the exchange (concentration < 10<sup>-5</sup>–10<sup>-7</sup> mol L<sup>-1</sup>).

### ***Desorption***

- After the last centrifugation, weigh the centrifugation tube in order to determine the quantity of solution trapped in the centrifugation pellet
- add 20 mL of 1 mol (NH<sub>4</sub>Cl) L<sup>-1</sup> solution; agitate for 2 h
- centrifuge and decant the supernatant in a 100 mL volumetric flask
- repeat desorption twice each time leaving the suspension in contact for 1 h
- complete the total extract to 100 mL with deionised water

### ***Titration***

- Titrate K, Ca and Al and subtract the concentration of the trapped solution to determine the K/K + Ca point of the isotherm.
- K and Ca should be titrated ten times by atomic absorption spectrometry using a diluted range from 0 to 6 mg L<sup>-1</sup> with addition of lanthanum; Al is titrated by inductively coupled plasma spectrometry or spectro-colorimetry (Pansu et al. 2001).

### **25.2.4 Remarks**

The soil exchange complex is a composite unit which does not be considered to present uniform surfaces with homogeneous densities of charge.

The influence of organic matter on the surface properties can be studied on samples before and after destruction of organic matter. Each granulometric phase (sands, silts, coarse clays, clays  $<0.2 \mu\text{m}$ ) can present very different selectivity (Sondag et al. 1990).

The economic importance of the calcium–potassium exchanges led to many studies that attempted to explain the adsorption of K in the presence of Ca more satisfactorily (Beckett and Nafady 1967, Goulding and Talibudeen 1980, Escudey and Galindo 1988, Rhue and Mansell 1988, Duffey and Delvaux 1989, Sondag et al. 1990).

Simultaneous estimation of the cation exchange capacity and the coefficients of exchange selectivity starting from disturbed or undisturbed soil columns was attempted using different mono- and divalent binary systems (e.g. Scheich et al. 1983, Parker et al. 1984, Kool et al. 1989).

The development of data-processing models now enables the study of the transfer of ionic species in soil–ion exchanges. These methods can be used for ions that are usually taken into account in the determination of exchangeable cations and cation exchange capacity: the simplest model with two cations is then sufficient (Duffey and Delvaux, 1989). In environmental studies, more sophisticated multi-species models may be necessary to measure – for example – the migration of heavy metals in field soil conditions, as these can pollute the groundwater (Mansell et al. 1986).

## References

- Beckett PHT and Nafady MHM (1967) Potassium–calcium exchange equilibria in soils : the location of non specific gapon and specific exchange sites. *J. Soil Sci.*, 18, 263–281
- Delvaux B (1988) *Constituants et propriétés de surface des sols dérivés de pyroclastes basaltiques du Cameroun occidental. Approche génétique de leur fertilité.*, Thèse UCL Fac. Sc. Agron., 335 p
- Duffey JE and Delvaux B (1989) Modeling potassium–calcium exchange isotherms in soils. *Soil Sci. Soc. A. J.*, 53, 1297–1299
- Escudey M and Galindo G (1988) Potassium–calcium exchange on inorganic clay fractions of Chilean andepts. *Géoderma*, 41, 275–285
- Gapon EN (1933) Theory of exchange adsorption in soils. *J. Gen. Chem.*, USSR, 3, 144
- Goulding KWT and Talibudeen O (1980) Heterogeneity of cation exchange sites for Ca–Mg exchange in alumino-silicates. *J. Colloid Interface Sci.*, 78, 15–24
- Kerr HW (1928) The identification and composition of the soil aluminosilicate active in base exchange and soil acidity. *Soil Sci.*, 26, 385

- Kool JB, Parker JC and Zelazny LW (1989) On the estimation of cation exchange parameters from column displacement experiments. *Soil Sci. Soc. Am. J.*, 53, 1347–1355
- Krishna Moorthy C and Overstreet R (1949) Theory of ion-exchange relationships. *Soil Sci.*, 68, 307
- Mansell RS, Bloom SA, Rhue RD and Selim HM (1986) Multispecies cation leaching during continuous displacement of electrolyte solutions through soil columns. *Geoderma*, 38, 61–75
- Pansu M, Gautheyrou J and Loyer JY (2001) *Soil analysis – sampling, instrumentation and quality control.*, Balkema, Lisse, Abington, Exton, Tokyo, 489 pp.
- Parker JC and Genuchten MTh van (1984) Determining transport parameters from laboratory and field tracer experiments. *Virg. Univ. Agric. Exp. Station*, 84, 3
- Rhue RD and Mansell RS (1988) The effect of pH on sodium-calcium and potassium-calcium exchange selectivity for Cecil soil. *Soil Sci. Soc. Am. J.*, 52, 641–647
- Richards LA (1954) *Diagnosis and improvement of saline and alkali soils.*, USDA, Agriculture Handbook, 60, 160 p
- Schweich D, Sardin M and Gaudet JP (1983) Measurement of a cation exchange isotherme from solution curves obtained in a soil column – preliminary results. *Soil Sci. Soc. Am. J.*, 47, 32–37
- Sondag F, Feller C and Delcambre L (1990) Etude de la sélectivité d'échange K-Ca dans divers sols tropicaux. Effet de la matière organique. In *ORSTOM – Journées Laboratoires (Bondy, France)*, 127–138
- Sposito G (1977) The Gapon and Vanselow selectivity coefficients. *Soil Sci. Soc. Am. J.*, 41, 1205
- Sposito G, Hotzclaw KM, Jouany C and Charlet L (1983) Cation selectivity of sodium-calcium, sodium-magnesium and calcium-magnesium exchange on Wyoming bentonite at 298 K. *Soil Sci. Soc. Am. J.*, 47, 917–921
- Sposito G (1984) *The surface chemistry of soils.* Oxford University Press, 234 p
- Vanselow AP (1932) Equilibria of the base-exchange reactions of bentonites, permutites, soil colloids and zolites. *Soil Sci.*, 33, 95

## Chronobibliography

- Schofield RK (1947) A ratio law governing the equilibrium of cations in the soil solution. *Proc. 11th Int. Congr. Pure Appl. Chem.*, 3, 257
- Gaines GL Jr and Thomas HC (1953) Adsorption studies on clay minerals. II, A formulation of the thermodynamics of exchange adsorption. *J. Chem. Phys.*, 21, 714
- Assa A (1976) Phénomène de sélectivité d'échange cationique dans certains minéraux argileux. I – La sélectivité du potassium dans un système potassium-calcium. *Cahiers ORSTOM – Sér. Pédol.*, XIV, 219–226

- Delvaux B (1988) *Constituants et propriétés de surface des sols dérivés de pyroclastes basaltiques du Cameroun occidental. Approche génétique de leur fertilité*. Thèse Un. Cat. Louvain Fac. Sc. Agron., 335 p
- Fontaine S, Delvaux B, Dufey JE and Herbillon AJ (1989) Potassium exchange behaviour in Carribean volcanic ash soil under banana cultivation. *Plant Soil*, 120, 283–290
- Bond WJ and Phillips JR (1990) Cation exchange isotherms obtained with batch and miscible displacement techniques. *Soil Sci. Soc. Am. J.*, 54, 722–728
- Phillips IR and Black AS (1991) Predicting exchangeable cation distributions in soil by using exchange coefficients and solution activity ratios. *Austr. J. Soil Res.*, 29, 403–414
- Ishiguro M (1992) Ion transport in soil with ion exchange reaction: effect of distribution ratio. *Soil Sci. Soc. of Am. J.*, 56, 1738–1743
- Wada SI, Matsuura T and Seki H (1993) Prediction of cation exchange isotherms at different total cationic concentrations. *Soil Sci. and Plant Nutri.*, 39, 183–187
- Baruah TC, Raj Pal, Poonia SR and Siyag RS (1995) Calcium-potassium, ammonium-potassium and calcium-ammonium exchange equilibria in soils of semi-arid region of Haryana and humid region of Assam. *J. of Potass. Res.*, 11, 277–290
- Bond WJ (1995) On the Rothmund-Kornfeld description of cation exchange. *Soil Sci. Soc. Am. J.*, 59, 436–443
- Siantar DP and Fripiat JJ (1995) Lead retention and complexation in a magnesium smectite (hectorite). *J. Colloid Interface Sci.*, 169, 400–407
- Borah N, Baruah TC, Patgiri DK and Thakur AC (1996) Exchange equilibria of calcium versus aluminium, potassium and ammonium in Alfisols of Assam. In *Proceedings of the Seminar on Problems and Prospects of Agricultural Research and Development in North-East India.*, Assam Agricultural University, Jorhat, India, 27–28 November 1995, 204–212
- Butcher B, Hinz C, Gfeller M and Fluhler H (1996) Cadmium transport in an unsaturated stony subsoil monolith. *Soil Sci. Soc. Am. J.*, 60, 716–721
- Mukhopadhyay SS (1996) Calcium-potassium exchange and thermodynamics in micaceous soils. *J. Potassium Res.*, 12, 1–13
- Sumner ME and Miller WP (1996) Cation exchange capacity and exchange coefficients. In *Methods of soil analysis, part 3, chemical methods*, Bigham JM and Bartels JM ed., SSSA-ASA, Madison, WI Etats-Unis, 1201–1229
- Shen SiYan, Tu Shu I and Kemper WD (1997) Equilibrium and kinetic study of ammonium adsorption and fixation in sodium-treated vermiculite. *Soil Sci. Soc. Am. J.*, 61, 1611–1618
- Moog HC, Streck T and Cammenga HK (1998) Modeling Ca/K exchange kinetics on montmorillonite and vermiculite. *Soil Sci.*, 163, 382–393

- 
- Endo T, Yamamoto S, Honna T, Eneji AE (2002) Sodium–calcium exchange selectivity as influenced by clay minerals and composition. *Soil Science*, 167, 117–125
- Saeki, K, Wada SI, Shibata M (2004)  $\text{Ca}^{2+}$ – $\text{Fe}^{2+}$  and  $\text{Ca}^{2+}$ – $\text{Mn}^{2+}$  exchange selectivity of kaolinite, montmorillonite and illite. *Soil Science*, 169, 125–132



## Cation Exchange Capacity

### 26.1 Introduction

#### 26.1.1 Theoretical Aspects

Like pH measurement or analysis of exchangeable cations (cf. Chap. 22), cation exchange capacity (CEC) is an essential measurement in agronomy and soil science to estimate the physicochemical state of a soil. It enables distinctions to be made in the classification of certain soils like oxisols, alfisols or ultisols.

In precisely defined conditions (particularly pH) it expresses the potential quantity of cations likely to neutralize the negative charges of a soil. Converted into  $\text{cmol (+) kg}^{-1}$ , these results allow comparison of the agronomic value of soils and exchange complexes that developed under different climates and inorganic or organic matrices.

As the colloidal fraction of the soil has a very large electrically charged surface, it can retain varying quantities of cations and anions, which enables some groundwater and air pollution to be avoided and also represents a source of nutrients for plants. The complex interactions of permanent and variable surface charges limit variations in the soil pH under the influence of chemical and biological factors that result in a buffering power. When the concentration of the soil solution stored in the micropores decreases, the exchange complex releases ions to equilibrate the system. The equations concerning the exchange phenomena have in common a constant relationship between adsorbed cations and free cations in solution (law of mass action, Gapon theory, Donnan equilibrium, etc.).

Soil negative charges are the result of isomorphic substitutions in phyllosilicate structures, non-compensated bonds at the edges of reticular plans, or dissociation of functional organic groups (cf. Chap. 19). These charges can be schematically divided into (a) permanent or fixed charges,

which are independent of the pH, valence and nature of the counter-ion, soil-to-solution ratio and (b) variable charges, which depend closely on the pH and on all the parameters that characterize the liquid and solid mediums and the interface of the two phases:

- Concentration, nature, valence, ionic strength, dissociation constant of the reagent, nature of the anion associated with the index ion, temperature, contact time, exchange kinetics, soil-to-solution ratio, and the polymers and complexes that can be formed;
- Dielectric constant of the medium, preliminary drying of the sample, crushing, surface potential of the adsorbent, nature of the surfaces and charges, preferential or selective adsorptions.

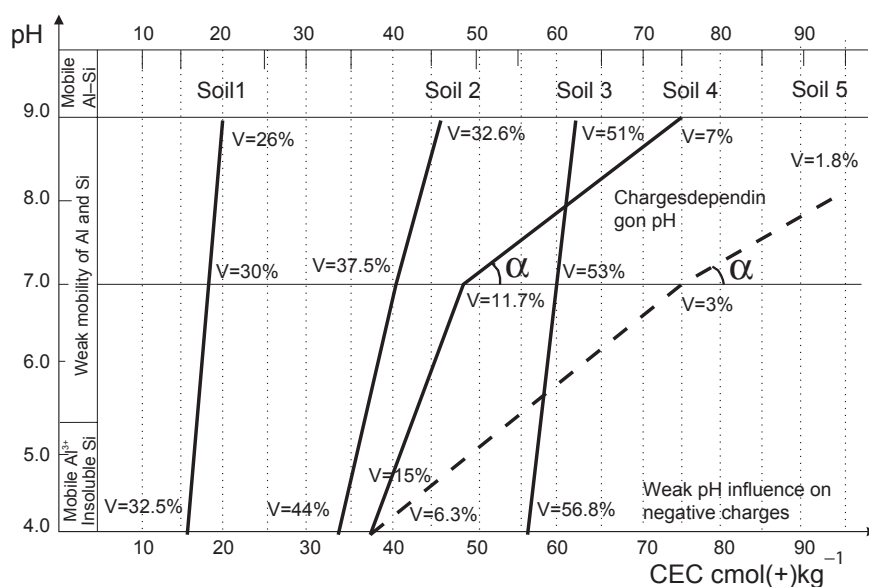

**Fig. 26.1.** Effect of pH on CEC measurement and on calculation of the saturation percent  $V$  (26.1) for some tropical soils of different texture (Gautheyrou and Gautheyrou 1981):

soil 1, ferrallitic soil with kaolinite from Guadeloupe; soil 2, eutrophic soil with halloysite from Martinique; soil 3, vertisol with acid montmorillonite from Martinique; soils 4 and 5, andosols from Costa Rica  $\alpha$ , strong predominance of Allophane

Methods for measuring CEC thus depend on measuring conditions, and the constraints are more obvious than for the measurement of exchangeable cations. For publication in abstract bulletins, the method used should be justified, and the reference state of the exchange matrix specified, i.e. total untreated soil, pretreated sample (e.g. drying, crushing, destruction of organic matter, elimination of soluble salts, iron removal, homoionic treatment for clay saturation). Results without these precise details are only of limited value.

In the past, it was common practice to characterize the adsorbing complex and to evaluate potential fertility by the saturation rate “*V*” obtained by the ratio of the exchangeable cations *S* (sum of Ca<sup>2+</sup>, Mg<sup>2+</sup>, K<sup>+</sup> Na<sup>+</sup>) and the CEC *T*:

$$V = 100 \frac{S}{T} \quad (26.1)$$

with *S* and *T* in cmol (+) kg<sup>-1</sup> (soil).

This rate of saturation is unfortunately very variable and is also subject to errors in the estimation of CEC generated by the choice of pH for extraction, the initial soil pH, the nature of the exchange complex and charges. Figure 26.1 shows that the rate of saturation can vary greatly in soils with predominantly variable charges.

### 26.1.2 Variables that Influence the Determination of CEC

#### *Influence of pH*

The choice of pH for extraction gave rise to controversy that was not necessarily always justified, but subsequently, thanks to the study of the nature of charges of the exchange complex (cf. Chap. 19), these arguments became more reasonable. The concept of chemical equilibration enables quantification of the parameters that determine the lattice bonds. The methods used can be grouped in three main categories:

1. Measurement of CEC at the soil pH → effective CEC;
2. Measurement of CEC at a given buffered pH;
3. Measurement of CEC at the pH for which the charge is zero (zero point charge (ZPC) or pH 0 (cf. Chap. 20).

#### *Measurement of CEC at the Soil pH*

This measurement enables the existing CEC to be identified and the phenomenon to be observed under conditions that are close to real conditions. Both the evolution of soils subjected to entropic constraints (influence of anion fixation of phosphorus or of calcium silicate causing a decrease in pH 0 and a rise in CEC, the influence of liming which increases the net charge, etc.) and the nutritional aspect of the exchange complex can be studied. This method enables calculation of the effective CEC by summation which is a good indicator of the real negative charges under field conditions.

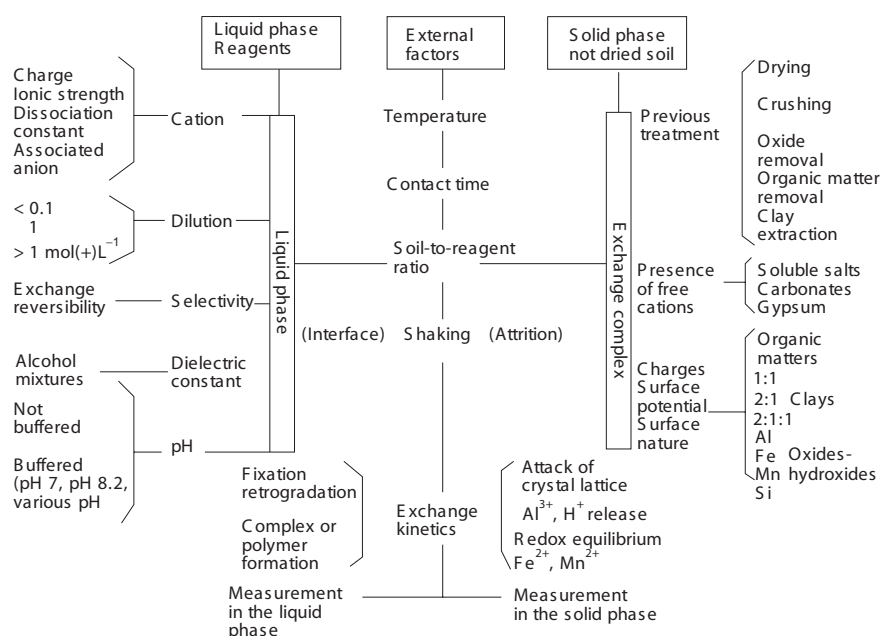

**Fig. 26.2.** Factors influencing measurement of CEC (Gautheyrou and Gautheyrou 1981)

Not-buffered reagents are used (e.g. KCl, NH<sub>4</sub>Cl, organo-metallic cations) to quantify firstly exchangeable cations (Ca<sup>2+</sup>, Mg<sup>2+</sup>, K<sup>+</sup>, Na<sup>+</sup>), and secondly the cations involved in exchangeable acidity (like H<sup>+</sup>, Al<sup>3+</sup>, Fe<sup>2+</sup>, Mn<sup>2+</sup>).

This method is suitable for acid soils with variable charges and with large quantities of interlayer aluminium hydroxyl-polymers which partially neutralize negative charges.

### **Measurements in Buffered Medium**

Buffered solutions are used to eliminate the influence of variations in pH on the measurement and to express all the results on the same basis, i.e. the chosen pH. These methods are standardized and the two most frequently used pH values are 7.0 and 8.1–8.2.

*The methods at pH 7.0* were selected by international decision to try and homogenize the results used for the soil classification. pH 7.0 corresponds to neutrality. It is close to the pH equilibrium of the soil-HCO<sub>3</sub><sup>-</sup>-CO<sub>2</sub> buffer system at normal atmospheric pressure.

The method using molar ammonium acetate at pH 7 belongs to this category. It has been used for nearly 60 years as an international reference because it is easy to implement, titration ends with a simple distillation and titrimetry, and it can be performed in the field. In addition, as ammonium is used to move the exchangeable cations in the saturation phase of the exchange complex, two methods can be combined and the saturation coefficient can be measured on the same extract. The ammonium acetate CEC method was considered to be precise, at least at the agronomic scale, which explains why this method has continued to be used.

However, this does not mean that it has never been subject to criticism, especially in the presence of illites, smectites and vermiculites where phenomena of selective adsorption of  $\text{NH}_4^+$  can be observed. Many other salts have been used to try to mitigate these problems or to adapt the method to specific cases.

These methods are appropriate for soils with predominant permanent charges or for soils presenting pH values close to neutral. The CEC of acid soils is often overestimated, especially for soils with significant variable charges, their saturation rate then appears to be lower.

*The methods at pH 8.1–8.2* were designed for soils with an exchange complex in which divalent cations predominate and with a high pH. At 25°C, pH 8.2–8.4 corresponds to the  $\text{CO}_2$  equilibrium at normal pressure of a system where bicarbonate is transformed into carbonate (upper titration point), and is also close to the complete neutralization of hydroxy-aluminium compounds. The charges measured are close to those that are actually observed in calcareous soils.

These methods include total exchangeable acidity, the CEC of variable charges; furthermore, using a well-buffered medium at this pH means measurements are “independent” of the initial soil pH. A cation like divalent barium is generally chosen as counter-ion because (a) it is practically non-existent in most soils and (b) its valence is the same as calcium and magnesium which are predominant in the adsorbing complex. However, this method is not suitable for soil genesis studies in acid medium.

*CEC extractions and titration at several buffered pH* enable estimation of changes in the charge at a given pH (Fig. 26.1). Below pH 5.2, the influence of  $\text{Al}^{3+}$ ,  $\text{Fe}^{2+}$ ,  $\text{Fe}^{3+}$  is more and more marked thereby weakening the CEC.

Between pH 5.2 and 8.5–9.0, Al and Fe are precipitated but as they are practically electrically neutral, they no longer significantly influence the results. Above pH 9.0,  $\text{Al}(\text{OH})_3$  is transformed into  $\text{AlO}_2^-$  aluminate

which is added to the clay negative charge, increasing the CEC and edge Al ions, Al–OH aluminols are transformed into anion form. Thus values between pH 4.0 and pH 9.0 are used to avoid the zones where significant dissolution of ions could disturb the exchange processes to be observed.

#### *Measurements at pH Corresponding to ZPC-pH 0*

These measurements are used for detailed studies but are not suitable for repetitive analysis because of the length and cost of the procedure which is difficult to robotize.

At the ZPC value (cf. Chap. 20) the soil has equal capacities for cation (CEC) and anion (ECA) exchange. If the pH of extraction is higher than the ZPC, the charge  $\Sigma v$  is negative and the CEC is overestimated.

If the pH is lower than the ZPC, the positive charges increase and the anion exchange capacity (AEC) are overestimated. These methods enable studies on the nature of the ionic environments and the energy levels of the equilibriums during hydrogeochemical cycles.

#### *Influence of the Nature and Concentration of Cations*

Monovalent and divalent ions are the most widely used. Hydrated ions, which are completely dissociated in diluted aqueous medium, are generally easily exchangeable and follow the lyotropic series shown in Table 26.1 for a concentration lower than 0.1 mol (+) L<sup>-1</sup>.

**Table 26.1.** Exchangeable monovalent or divalent cations

monovalent	Cs <sup>+</sup>	Rb <sup>+</sup>	K <sup>+</sup> NH <sub>4</sub> <sup>+</sup>	Na <sup>+</sup>	Li <sup>+</sup>
ionic radius (Å)	1.67	1.52	1.38	1.02	0.76
Divalent		Ba <sup>2+</sup>	Sr <sup>2+</sup>	Ca <sup>2+</sup>	Mg <sup>2+</sup>
ionic radius (Å)		1.35	1.18	1.0	0.72

Except in case of selective adsorption, the exchange capacity is in the same as the order of valence:

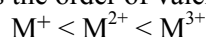

However, above a concentration of 0.1 mol (+) L<sup>-1</sup>, some monovalent cations can have an exchange capacity with different selectivity.

In smectites, the least hydrated ions reach the interfoliaceous cavities (K<sup>+</sup>, NH<sub>4</sub><sup>+</sup>) more easily, but because of the contraction of 2:1 clays, these

ions can be trapped and become non-exchangeable (fixed or retrogressed ions). The basal space can be as small as 9.8–10.8 Å (cf. Chap. 4).

Conversely, with ions like  $\text{Ca}^{2+}$ , and  $\text{Mg}^{2+}$  with strong hydration energy and which are completely solvated, interfoliaceus expansion of up to 15–20 Å occurs which makes the cations more mobile and the exchange reversible, without marked exchange selectivity (cf. Chap. 25).

This phenomenon can be observed in micas and illites, vermiculites and minerals with a strong interlayer charge. The cations are sometimes replaced by organomineral compounds. These large molecules (for example the cobaltihexamine ion which has a ionic radius of 7 Å) can display steric impossibilities to reach some exchange positions. In certain clays, abnormally low exchange capacities are then observed with a significant interfoliaceus surface, or zeolites which play the role of molecular sieves.

### ***Influence of Contact Times, Agitation and Equilibration***

These methods use very different contact times which can influence the resulting values:

- A short contact time of less than 1 h may be necessary if the kinetics of dissolution of the exchange matrix is high, involving an increase in background noise (double percolation can be used to correct the results); in this case, diffusion of the liquid within the structure of clays and colloids has to be rapid to enable the exchange phenomena to reach a stable value as soon as possible; gentle agitation by ultrasound often enables satisfactory exchange: dissolution ratio to be obtained;
- A contact time of less than 24 h is usually used with reagents that enable complete reagents-matrix exchange equilibriums without significant dissolution and
- A time of contact of more than 24 h requires reagents with limited dissolving capacity.

It is necessary to check for matrix solubilization, possible neoformation in the crystalline or amorphous phase, and the stoichiometry of the exchanges.

### ***Influence of the Modes of Extraction: Soil-to-Solution Ratio***

The CEC is measured in a system with two phases, each of which is analyzed (Fig. 26.2):

- a stationary solid phase represented by the soil exchange matrix and
- a mobile liquid phase containing a counter-ion (index ion).

Equilibration between these two phases defines the exchange (adsorption–sorption relations) and the total charge of the solid. The exchange is more complete if the ratio of the liquid to the solid phase is high (weak concentration in the liquid phase).

The ionic force of the counter-ion must be sufficient to move the ions fixed on the exchange matrix but not to solubilize other materials. The analytical conditions of measurement are far from real conditions. The CEC can be measured in the liquid phase which is enriched in elements released by the soil matrix and in which counter-ions are reduced. Excess counter-ions are measured before and after the exchange and the CEC is given by the difference between the two.

CEC can also be measured on the solid phase made homoionic after saturation by the counter-ion and by the elimination of excess counter-ions. This ion is thus exchanged and analyzed directly from the solid phase, provided this phase does not release other ions of similar nature (for example, direct distillation of the soil to titrate fixed  $\text{NH}_4^+$ ). The CEC is then equal to the total charge of the fixed ions.

CEC can also be measured by a method combining saturation by a counter-ion, elimination of the excess, then displacement of the counter-ion by another counter-ion, assuming a stoichiometric exchange in both cases.

The excess counter-ion solution is eliminated by a highly diluted solution of the same ion to avoid dispersion or excessive hydrolysis, then by weighing to measure the quantity of solution retained in order to correct the results. Elimination can also be achieved with miscible solvents (methanol, ethanol, isopropanol) which modify the permittivity of the medium. ISRIC<sup>1</sup> (1987) recommended washing with an ethanol–water mixture (80% ethanol).

### ***Influence of Free Ions, Soluble Salts, Limestone, Gypsum***

The presence of these substances in the soil disturbs measurements and causes an immediately detectable anomaly between the sum of extracted cations ( $S$ ) and the exchangeable capacity ( $T$ ):  $S > T$  whereas in most other cases  $S < T$  or at the most  $S = T$ . The CEC value is thus erroneous as are values for the exchangeable cations. The exchange complex is saturated with  $\text{Ca}^{2+}$ ,  $\text{Mg}^{2+}$ , or  $\text{Na}^+$  depending on the case.

---

<sup>1</sup> ISRIC, International Soil Research Information Center, P.O. Box 353, 6700 AJ Wageningen, the Netherlands. Tel. +31 - 317 - 471711; Fax: +31 - 317 -471700. E-mail:soil.isric@wur.nl



### ***Influence of Soil Pretreatments***

#### ***Drying***

In andosols with permanent moisture, drying results in a very significant reduction in the CEC. Measurements must thus be made on samples stored with their field moisture, and the water contained in the samples must be taken into account in calculations. A specific volume of soil corresponding to an equivalent weight of soil dried at 105°C is used in order to obtain results corresponding to the same exchange surface whatever the initial moisture of the samples (between 10 and 300%). The results are expressed in  $\text{cmol (+) kg}^{-1}$  of soil dried at 105°C.

#### ***Crushing***

In clays with a weak charge like 1:1 clays, the effect of edge charges increases with over grinding because of the discontinuities of structure caused by the treatment. During weathering, the presence of badly crystallized forms can have the same effect (silanol–aluminol groups, cf. Chap. 21).

In 2:1 clays, whose charge is high, the edge charge can be negligible in proportion to the total charge. The effect of moderate crushing will consequently be less serious than in 1:1 clays.

Amorphous substances and gels with very high charges are practically unchanged by crushing, whereas the apparent CEC can increase in crystalline forms with weak charges.

#### ***Chemical Pretreatments***

The CEC can be drastically modified by preliminary saturation of an andosol sample by reagents containing anions that can be fixed selectively. Among these anions, the following series is particularly active:  $\text{F}^- > \text{PO}_4^{3-} > \text{SO}_4^{2-}$ .

The CEC of allophane soils can be increased three or four times by the simple addition of phosphate.

Sometimes oxalate can be observed during destruction of organic matter by perhydrol and this can disturb measurements. The addition of concentrated ammonia to destroy the excess of perhydrol can saturate the complex with the  $\text{NH}_4^+$  ion and cause errors in 2:1 clays.

The elimination of amorphous substances using the CBD method involves reduction of ferric iron to ferrous iron. In 2:1 minerals, if this action occurs at the level of the octahedral layers, the negative surface charge increases. During soil washings, ferro-iron can precipitate again as ferri-iron and be adsorbed with silicon and aluminium ions on the matrix thereby blocking exchange sites and giving incorrect CEC values

(Stucki et al. 1984). In this case it is necessary to estimate the possible effects of this treatment in minerals containing iron in their structure, like nontronite.

## 26.2 Determination of Effective CEC by Summation (ECEC)

### 26.2.1 Principle

Exchangeable cations ( $\text{Ca}^{2+}$ ,  $\text{Mg}^{2+}$ ,  $\text{K}^+$ ,  $\text{Na}^+$ , cf. Chap. 22) are added to the cations extracted with the exchangeable acidity method ( $\text{H}^+$ ,  $\text{Al}^{3+}$ ,  $\text{Fe}^{2+}$ ,  $\text{Fe}^{3+}$ ,  $\text{Mn}^{2+}$ ), cf. Chap. 23; Yuan 1959):

$$\text{ECEC (cmol (+) kg}^{-1}\text{)} = [\text{Ca}^{2+} + \text{Mg}^{2+} + \text{K}^+ + \text{Na}^+] + [\text{H}^+ + \text{Al}^{3+} + (\text{Fe}^{2+} + \text{Fe}^{3+} + \text{Mn}^{2+})]$$

This measurement (Coleman and Thomas 1967; Kamprath 1970) is considered to be representative of the CEC measured at the soil pH under conditions of surface charges identical to natural conditions (Juo et al. 1976). It applies to acid or neutral soils. However, the ionic strength of the extraction solution is higher than that of the soil solution. This has the advantage of allowing the results of two different analyses to be used:

- exchangeable cations, which estimates the proportion and nature of the available elements in soil;
- exchangeable acidity, which specifies the nature of soil acidity (e.g.  $\text{H}^+$ ,  $\text{Al}^{3+}$ ).

The rate of saturation  $V$  obtained by these two analyses is close to field conditions but appears to be more representative of acid soils with variable charge.

### 26.2.2 Alternative Methods

Either the method using 0.1 mol L<sup>-1</sup> ammonium acetate at pH 7 or a method using a not-buffered solution of 1 mol L<sup>-1</sup> ammonium chloride can be used to extract the exchangeable cations.

The determination of exchangeable aluminium with multiple mono- and polymeric forms can result in values that are too low, as not all the forms are exchangeable.

Other methods have been proposed for the ECEC. They all use not-buffered reagents that are likely to exchange either the exchangeable cations, or cations representing the exchange acidity: Ag–thiourea (Pleysier and Juo 1980),  $\text{SrCl}_2$  (Edmeades et al. 1981),  $\text{NH}_4\text{-NO}_3$  (Stuanes et al. 1984),  $\text{BaCl}_2$  (Hendershot and Duquette 1986),  $\text{NH}_4\text{Cl}$  (Gangaiya and Morrison 1987).

## 26.3 CEC Measurement at Soil pH in Not-Buffered Medium

### 26.3.1 Principle

The soil is saturated with a counter-cation in not-buffered medium. The exchange is carried out at a pH near the soil pH. After elimination of excess counter-cation with a diluted solution of the same ion, this cation is moved by another counter-cation. The titration of the moved cation enables determination of the CEC.

Diluted solutions of ionic force near to that found in the soil solution at a moisture rate of approximately pF 2 (cf. Table 1.1 of Chap. 1) should be used to avoid serious deterioration of the surface of colloids (Gillman 1979; Gillman et al. 1983; Rhoades 1982). These methods are only suitable for acid soils with variable charges, as the measurement of CEC at pH 7.0 gives highly over-estimated values. The acid or neutral soils should not contain soluble salts or gypsum. The organic matter can also be dissolved resulting in a too low CEC.

### 26.3.2 Methods Using Not-Buffered Metallic Salts

#### ***Barium Chloride and Magnesium Sulphate–Procedure***

##### *Principle*

In this well-described technique (Gillman 1979; Rhoades 1982; NF ISO 11260 1994), the exchangeable cations are extracted with a not-buffered 0.1 mol (BaCl<sub>2</sub>) L<sup>-1</sup> solution. The exchangeable cations (like Ca<sup>2+</sup>, Mg<sup>2+</sup>, K<sup>+</sup> Na<sup>+</sup>) can be titrated in the extract. The soil residue is put in contact with a 0.02 mol (MgSO<sub>4</sub>) L<sup>-1</sup> solution. The Mg<sup>2+</sup> ions move the exchanged Ba<sup>2+</sup> ions and BaSO<sub>4</sub> precipitates in the medium maintained at an ionic strength near that of the soil solution. The difference between the added Mg<sup>2+</sup> and the Mg<sup>2+</sup> which remains in solution gives the CEC. Magnesium is titrated by atomic absorption spectrometry (AAS).

##### *Reagents*

– *Saturation solution* of 0.1 mol L<sup>-1</sup> barium chloride: dissolve 24.43 g of BaCl<sub>2</sub> · 2H<sub>2</sub>O (mw = 244.3) and bring to 1 L with deionised water.

- *Equilibration solution* of 0.0025 mol L<sup>-1</sup> barium chloride: take 25 mL of 0.1 mol (BaCl<sub>2</sub>) L<sup>-1</sup> solution and bring to 1 L with deionized water.
- *Counter-ion solution* of 0.02 mol L<sup>-1</sup> magnesium sulphate: dissolve 4.9296 g of MgSO<sub>4</sub>·7H<sub>2</sub>O (mw = 246.50) in 1 L of deionized water.
- *Reagents for titration by atomic absorption and emission spectrometry*:
  - (a) *Lanthanum nitrate*: weigh 15.7 g of La(NO<sub>3</sub>)<sub>3</sub>·6H<sub>2</sub>O (mw = 433.02); add 42 mL of concentrated HCl and bring to 500 mL with deionized water;
  - (b) *Caesium chloride*: weigh 10 g of CsCl (mw 168.36); add 83 mL of concentrated HCl and bring to 1 L with deionized water;
  - (c) *Mg standards*: range 0, 0.01, 0.02, 0.03, 0.04 and 0.05 mmol L<sup>-1</sup> (CEC);
  - (d) *Na standards*: range 0, 4, 8, 12, 16, 20 mg L<sup>-1</sup> (EC);
  - (e) *K standards*: range 0, 10, 20, 30, 40, 50 mg L<sup>-1</sup> (EC);
  - (f) *Ca and Mg standards*: mixed range (EC) containing:
    - Mg: 0, 0.1, 0.2, 0.3, 0.4, 0.5 mg L<sup>-1</sup>,
    - Ca: 0, 1, 2, 3, 4, 5 mg L<sup>-1</sup>.

### Procedure

#### Displacements

Measure the soil moisture on another sample specimen to correct the results on the basis of soil dried at 105°C if necessary (cf. Chap. 1).

- Put 2.5 g of soil < 2 mm in a 50 mL centrifugation tube, and weigh tube + soil + screw cap:  $m_1$
- Add 30 mL of 0.1 mol (BaCl<sub>2</sub>) L<sup>-1</sup> solution and agitate for 1 h.
- Centrifuge at 5,000g and transfer the supernatant in a 100 mL volumetric flask.
- Repeat saturation twice and mix the extracts in a 100 mL flask.
- Complete to 100 mL; this solution contains the exchangeable cations: S1 solution.
- Add 30 mL of 0.0025 mol (BaCl<sub>2</sub>) L<sup>-1</sup> to the centrifugation pellet and shake overnight.
- Centrifuge, discard the supernatant and weigh the tube + centrifugation pellet + retained 0.0025 mol (BaCl<sub>2</sub>) L<sup>-1</sup> solution:  $m_2$ .
- Add 30 mL of 0.02 mol (MgSO<sub>2</sub>) L<sup>-1</sup> solution and agitate for 2 h.
- Centrifuge and filter the supernatant for CEC quantification: S2 solution.

### Measurement of CEC

- Place 0.2 mL of the S2 filtrate in a 100 mL volumetric flask.
- Place 0.2 mL of the counter-ion solution (MgSO<sub>4</sub>) in another 100 mL flask.
- Add 10 mL of the 10 g (La) L<sup>-1</sup> solution to each flask and complete to 100 mL.
- Measure the Mg concentrations by AAS at 285.2 nm:
  - $C_0$  is the concentration of the diluted counter-ion solution,
  - $C_1$  is the concentration of the diluted S2 solution.

### Calculation of CEC

Correct the  $C_1$  concentration for the effect of the volume of liquid retained in the sample after treatment:

$$C_2 = \frac{C_1 (30 + m_2 - m_1)}{30}$$

$C_2$ : corrected Mg concentration mmol L<sup>-1</sup>

$C_1$ : Mg concentration from AAS measurement mmol L<sup>-1</sup>

$m_1$ : weight tube + soil

$m_2$ : weight tube + soil + retained liquid

$$\text{CEC} = \frac{3,000 (C_2 - C_0)}{m} \quad (\text{in cmol (+) kg}^{-1})$$

$m$ : sample weight in g (2.5 g)

$C_0$ : concentration of the diluted counter-ion solution.

If CEC exceeds 40 cmol (+) kg<sup>-1</sup>, repeat the analysis with a lower weight of soil.

### Measurement of the Exchangeable Cations

- In 10 mL volumetric flasks, pipette 2 mL of the S1 solution, add 1 mL of CsCl and bring the volume to 10 mL with deionised water.
- Measure Na and K by flame emission.
- Again pipette 1 mL of the S1 extracts in 10 mL volumetric flasks, add 1 mL of lanthanum nitrate solution and bring to 10 mL with deionised water.
- Measure Ca and Mg by AAS.

### Calculation of the Exchangeable Cations

$$C_{ech} = \frac{c - c_b}{m} \times \frac{10 v}{M}$$

$C_{ech}$ , concentration of the exchangeable Na, K, Ca or Mg cation in cmol (+) kg<sup>-1</sup>,  $C$  and  $C_b$ , concentrations in the extracts and blank,

respectively, in  $\text{mg L}^{-1}$ ;  $m$ , weight of soil in g;  $v$ , charge of the cation (1 for Na and K, 2 for Ca and Mg);  $M$ , atomic mass of the cation in g.

### **Remarks**

This method is relatively simple and enables measurement of the permanent and variable charges of strongly weathered tropical soils, as well as of exchangeable cations and possibly of exchangeable acidity (NF ISO 14254 1997).

The use of  $\text{MgSO}_4$  is questionable for andosols because of the selective fixing of sulphate ion in these soils in which the presence of allophane and substances with short distance organization are predominant. Matsue and Wada (1985) proposed the use of  $0.01 \text{ mol (SrCl}_2\text{) L}^{-1}$  for saturation of the complex, then desorption of exchanged Sr with a  $0.5 \text{ mol (HCl) L}^{-1}$  solution.

Another approach was recommended by Hendershot and Duquette (1986) in which  $\text{MgSO}_4$  is replaced by  $\text{MgCl}_2$  as  $\text{Cl}^-$  is not selectively retained by soils containing allophane. A similar method was used for peats:  $\text{BaCl}_2 - \text{MgCl}_2$  (Lambert et al. 1988).

$\text{Ba}^{2+}$ ,  $\text{Sr}^{2+}$ ,  $\text{Mg}^{2+}$  do not cause contraction of any 2:1 clays that may be present.

When it is possible to compare  $\text{Sr}^{2+}$  and  $\text{Ba}^{2+}$  in not-buffered medium and with a moderate ionic force ( $C = 0.01\text{--}0.1 \text{ mol L}^{-1}$ ) the results will be similar to those obtained with the ammonium method (not-buffered medium).

It is also possible to measure aluminium, manganese and iron in the extracts; these elements may be present in large quantities in spodosols.

## **26.3.3 Procedure Using Not-Buffered Organometallic Cations**

### ***Cobalti-Hexamine Chloride System***

#### ***Principle***

The steric obstruction of certain organometallic cations makes it possible to avoid their penetration in the clay layers. Measuring the CEC with cobalti-hexamine chloride (Esquevin 1954; Morel 1957; Amavis 1959) gives values that are generally low but well suited to repetitive measurements of acid soils with variable charges.

The soil is saturated by the cobalti-hexamine cation  $\text{Co(NH}_3\text{)}_6^{3+}$  in excess (3–7 times the expected CEC according to Rémy and Orsini 1976). Ca, Mg, K, Na, Al cations are titrated directly in this solution.

The CEC is calculated by the difference between the quantity added and the quantity remaining in solution. The calculated adsorbed  $\text{Co}^{3+}$  corresponds to the soil CEC in not-buffered medium at a pH near the soil pH. The analysis can be performed on the whole soil or on clay fractions, and macro or micro methods can be used.

### Reagent

*Cobalti-hexamine chloride* ( $\text{Co}(\text{NH}_3)_6\text{Cl}_3$  mw = 267.50)  $1/60 \text{ mol L}^{-1}$  ( $0.05 \text{ mol (+) L}^{-1}$ ) solution: weigh 4.4583 of  $\text{Co}(\text{NH}_3)_6\text{Cl}_3$  and dissolve in 1 L of water (1 mL = 0.05 milliequivalents CEC); prepare fresh each week and store in a brown lightproof bottle.

### Procedure

- Weigh 4 g of soil in a 150 mL centrifugation tube.
- Add 100 mL of N/20 cobalti-hexamine chloride solution.

The concentration should be adjusted as a function of the CEC and be suitable for a minimum of two to a maximum of seven times the theoretical value of the CEC. Alternatively the weight of the sample of soil or clay can be changed. For example, at a concentration of  $0.05 \text{ mol (+) L}^{-1}$ , 100 mL of reagent representing 5 mmol (+) CEC, it is possible to measure the CEC of a sample of 2 g montmorillonite with a CEC of approximately  $100 \text{ cmol (+) kg}^{-1}$  with adequate precision.

- Mix and shake on a rotary agitator for 2 h.
- Centrifuge at 5,000 g for 5 min and recover the supernatant.
- Titrate
  - $\text{Ca}^{2+}$ ,  $\text{Mg}^{2+}$ ,  $\text{K}^+$ ,  $\text{Na}^+$  (exchangeable cations),
  - $\text{Al}^{3+}$  (exchangeable acidity),
  - $\text{Co}^{3+}$  (CEC),

by atomic absorption or inductively coupled plasma emission spectrometry (Pansu et al. 2001). Alternatively, the CEC can be titrated by ammonium distillation directly on the extract, the cobalti-hexamine chloride being broken up above pH 10 in the presence of soda according to the reaction:

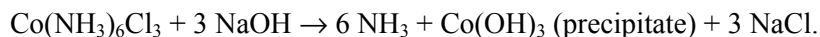

Ammonia is then titrated by acidimetry, which makes this method usable even under uncertain analytical conditions (Esquevin 1954; Gautheyrou and Gautheyrou 1958). Orsini and Rémy (1976) proposed ammonium titration by automated spectrophotometry.

The results are expressed in  $\text{cmol (+) kg}^{-1}$  knowing that  $1/3 \text{ mole Co}^{3+} \leftrightarrow 2 \text{ NH}_3$ .

### Remarks

Cobalti-hexamine chloride dissolves only a very low fraction of carbonates, which allows quantification of exchangeable calcium in not too calcareous soils.

Under certain conditions, the cobalti-hexamine chloride may be broken down giving an overestimation of the CEC (Cornell and Aksoyoglu 1991).

The works of Mantin and Glaeser (1960) Johanson (1961) Fripiat and Helsen (1966) Oliver (1984) Fallavier et al. (1985) and Keita and Van Der Pol (1987) studied these reactions in detail and compared methods.

**Fig. 26.3.** Cobalti-hexamine chloride

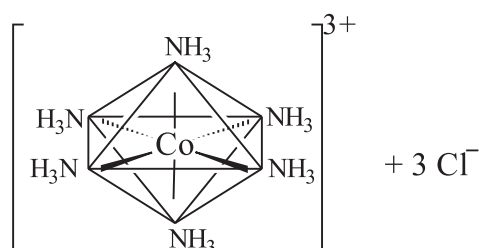

Cobalti-hexamine chloride or hexamino-cobalt chloride is a large organometallic cation obtained by oxidation of an ammoniacal solution of cobalt chloride containing ammonium chloride in the presence of activated carbon as catalyst:



The cobalt atom is hexacoordinate (Fig. 26.3), each  $\text{NH}_3$ -nitrogen being located at the apical ends of a regular octahedron. The radius of the cobalti-hexamine is approximately  $3.25 \text{ \AA}$ , which may explain the phenomena of steric limitation on interfoliaceous surface of clays and the weak ionic force.

### Ag–Thiourea System

#### Principle

The soil is saturated by a monovalent organometallic cation (silver–thiourea), which displays strong affinity for the negative charges of colloids.

The exchangeable cations pass in solution where they can be titrated. The titration of  $\text{Ag}^+$  ion remaining in solution enables quantification of the fixed  $\text{Ag}^+$  by difference and thereby determination of the CEC. The medium is not buffered and extraction is performed at the soil pH (Pleyssier and Juo 1980; Searle 1986; ISRIC 1987).



The ionic strength of the reagent solution is lower than that of the 1 mol (KCl) L<sup>-1</sup> solution ( $I \approx 0.01$ ).

### Reagents

- *Silver nitrate 0.02 mol L<sup>-1</sup>*: dissolve 3.4 g of AgNO<sub>3</sub> (mw = 169.89) in 500 mL of water and store in a brown lightproof bottle.
- *0.2 mol (thiourea) L<sup>-1</sup> solution*: dissolve 15.25 g of thiourea (H<sub>2</sub>N–CS–NH<sub>2</sub> mw = 76.12) in 900 mL water and bring to 1,000 mL. Let stand overnight and filter if there is a deposit.  
*Toxicity*: thiourea is slightly toxic by inhalation or by contact.
- *Solution to determine the CEC at the soil pH*: just before use, mix in the following order: 1 L of 0.2 mol (thiourea) L<sup>-1</sup> solution, 500 mL of deionised water and homogenize; slowly add 500 mL of 0.02 mol L<sup>-1</sup> silver nitrate solution while agitating; silver forms a stable complex with thiourea (Bolt 1982).
- *Standards for silver titration by AAS*: put 50 mL of a 1,000 mg (Ag<sup>+</sup>) L<sup>-1</sup> stock solution in a 200 mL volumetric flask and complete to 200 mL with deionised water: solution A (250 mg L<sup>-1</sup> solution). Put 2.5 mL of 0.2 mol (thiourea) L<sup>-1</sup> solution and 5 mL of 1 mol (HNO<sub>3</sub>) L<sup>-1</sup> solution into six 250 mL volumetric flasks. Take exact volumes of 0-5-10-15-20-25 mL of solution A and add them in each flask while agitating. Bring to volume with deionised water and homogenize, giving a standard range of 0-5-10-15-20-25 mg (Ag) L<sup>-1</sup>.

### Procedure (ISRIC 1987)

#### Extraction

- Weigh 1 g of soil (0.5 mm particle size) in a centrifugation tube;
- add 40 mL of silver–thiourea solution and close the tube;
- shake for 4 h, centrifuge at 5,000g and recover the supernatant.

#### Exchangeable Cations

- Titrate Ca<sup>2+</sup>, Mg<sup>2+</sup>, K<sup>+</sup>, Na<sup>+</sup> and Ag by AAS with standards containing the same thiourea matrix;
- titrate two blanks (the same reagents without the soil sample), a reference sample and a randomly chosen control sample in the series.

#### CEC

Take 2 mL of the extract, add 5 mL 1 mol (HNO<sub>3</sub>) L<sup>-1</sup> solution and bring to volume with 100 mL water. Homogenize and measure Ag<sup>+</sup> by AAS at 328.1 nm using the 0–25 mg L<sup>-1</sup> standard range.

**Calculation**

$$\text{Ag}^+ = 107.87$$

$$\text{CEC (cmol(+) kg}^{-1}) = \frac{(b-a) \times 50 \times 100}{25 \times 107.87} \frac{f}{w} = \frac{1.85 (b-a) f}{w}$$

*a*: mg (Ag<sup>+</sup>) L<sup>-1</sup> in the extract diluted 50 times;

*b*: mg (Ag<sup>+</sup>) L<sup>-1</sup> in the blank diluted 50 times;

*w*: weight of air-dried soil sample;

*f*: moisture correction factor.

**Remarks**

The method is rapid and only one extraction is needed to titrate the exchangeable cations (Ca, Mg, K, Na) and CEC (Pleysier and Cremer 1975; Chabra et al. 1976). It enables measurement of the CEC up to 20 cmol (+) kg<sup>-1</sup> (soil). If the CEC exceeds this value, the sample can be extracted with 80 mL of silver–thiourea reagent or a smaller soil sample can be used; these modifications then need to be taken into account in the calculations.

The silver–thiourea solution can damage the electrodes of pH-meters. The electrodes should not be left in contact with the solution for too long and should be rinsed immediately after use with diluted nitric acid and then soaked in deionised water (Siegried et al. 1986). A concentration of 1 mol (HNO<sub>3</sub>) L<sup>-1</sup> should not be exceeded in order to avoid the precipitation of an insoluble thiuronium nitrate compound.

It is possible to use this method at fixed pH by incorporating 0.1 mg L<sup>-1</sup> ammonium acetate or sodium acetate buffer.

The method can be used up to pH 9.0 for calcareous or gypseous soils, (Van Rosmalen 1980), saline soils and possibly soils containing organic matter and with variable charges, like histosols, podzols or andisols (Pleyser and Juo 1980; Bolt 1982; Searle 1986). The stability of the reagent is modified in alkaline medium at pH > 8.0. The decomposition of the silver–thiourea complex results in deterioration of the extraction solution.

The exchange affinity is high for clay minerals like montmorillonite, illite, kaolinite and even vermiculite, where the silver–thiourea complex seems to penetrate the interlayer space (Pleysier and Cremer 1973, 1975). Selectivity is slightly different from that observed for ammonium acetate extraction at pH 7. Extracted K<sup>+</sup> is often higher in the silver–thiourea method. On the other hand, extracted Ca<sup>2+</sup> and Mg<sup>2+</sup> are generally lower depending on the organic matter content and the soil pH (Pleysier et al. 1986). However, calcite can be slightly dissolved resulting in overestimation of the exchangeable cations.

Effective CEC (cf. Sect. 26.2 earlier) can be measured using this method. The results are a little lower than with the ammonium acetate or potassium chloride methods. However, extraction of manganese by the silver–thiourea complex can be higher than by potassium chloride (Searle 1986). The effect on iron extraction should be checked as thiourea is a neutral ligand with reducing properties.

### ***Not-Buffered Ethylene Diamine + Inorganic Cations***

Clay is saturated by a cation (e.g. Co, Cu) giving homoionic clay. Ethylene diamine is added in excess and, through contact with the added cation, is fixed quantitatively. If there is formation of a soluble complex of the cation with ethylenediamine, there will be saturation of the exchangeable positions (Fripiat and Helsen 1996; Mantin 1969). These complexes are strongly stabilized within clay (Peigneur 1976; Mas et al. 1978). The CEC corresponds to the concentration of the complex fixed by the matrix, resulting in a reduction in the concentration of ethylene diamine (Cornell and Aksoyoglu 1991).

These methods have the same disadvantage as a method by difference. It should be noted that the reagent can irritate the skin and mucous membranes and cause allergic dermatoses and asthma; these risks can be avoided by working under a fume hood.

Researchers studying soil genesis and weathering processes also use the exchange of the alkylammonium ion which makes it possible to measure the density of interlayer cations if the molecular weight of the basic exchanger unit is known. Only purified fractions should be used. In 2:1 clays, depending on the degree of crystallinity of the clay, the total CEC generally includes approximately 80% of interlayer CEC for approximately 20% of edge CEC. For example, the transformation processes of micas (of illite into smectites) or the transformation of bentonite into smectites can be monitored (Lagaly 1981).

Complexes of ethylene diamine ( $\text{NH}_2\text{-CH}_2\text{-CH}_2\text{-NH}_2$ ) with cations like Al, Co, Cu, Fe, Mn, Ni, Zn have also been used; however these methods are used more especially for detailed studies on clays.

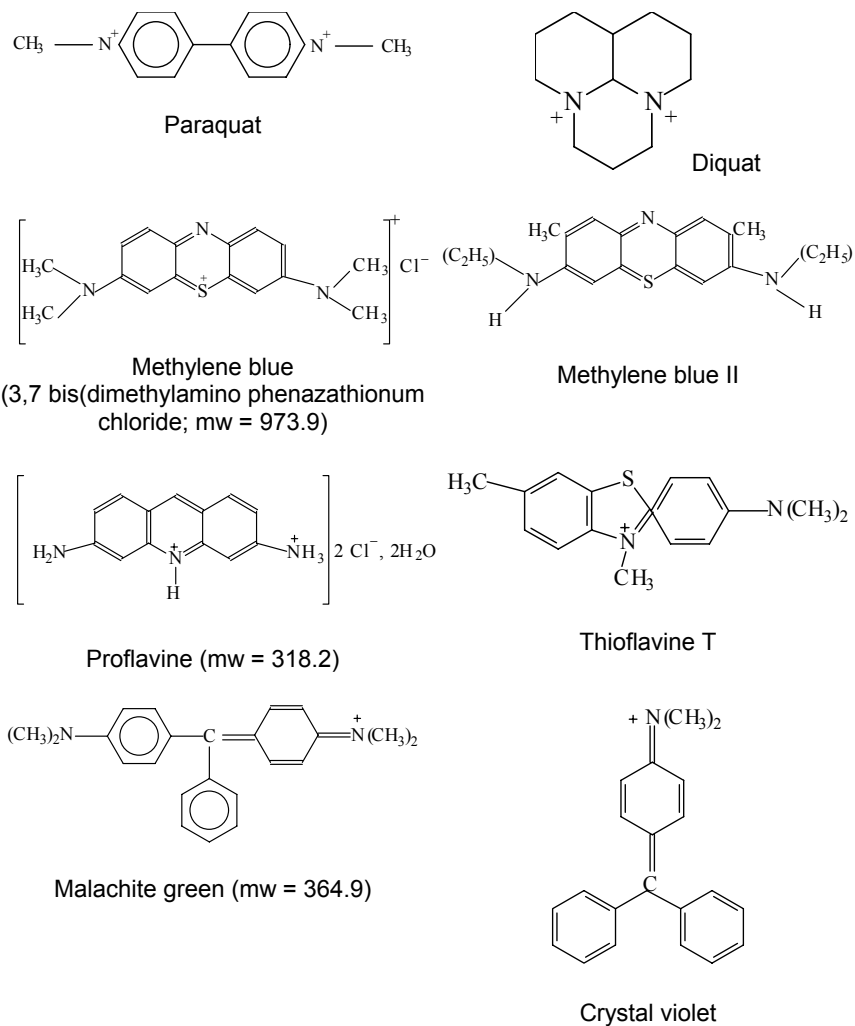

**Fig. 26.4.** Organic molecules used for measurement of cation exchange capacity

### 26.3.4 Not-Buffered Methods Using Organic Cations

Interest in these methods increased with the commercial availability of large organic molecules (Fig. 26.4) used as pesticides and with

knowledge of the environmental impact of such molecules (e.g. saturation of the adsorbing complex, biodegradation, pollution of ground water by Paraquat and Diquat).

If possible, these methods should be combined with methods for the determination of clay specific surfaces and macro-methods for the determination of the CEC.

The study of the fixation mechanisms requires knowledge of the modes of action of monovalent or divalent organo-cations in order to avoid confusion between exchange and physical adsorption.

The quantities of inorganic cations exchanged by the organo-cation should be proportional or equal to the quantities of adsorbed exchanger. The size of the organic ions means methods of centrifugation at high speed which would be likely to separate molecules of the exchanger should not be used. Exchange capacities are determined starting from the plates of the exchange isotherms (Margulies et al. 1988). The main colorants used are methylene blue, flavins, malachite green, and crystal violet (Fig. 26.4).

The methods used are based on incubation of Na<sup>+</sup> homoionic clay with the colouring exchangers for a period of from 1 to 15 days depending on the clay.

A 20 mL sample clay in 0.5% solution is sufficient.

After percolation and filtration on Millipore 0.45 µm filter, absorption is measured:

- at 662 nm for methylene blue;
- at 588 nm for crystal violet.

The displaced inorganic cations are titrated by inductively coupled plasma spectrometry (Rytwo et al. 1991). Saturation by Na<sup>+</sup> is best with methylene blue (Hoffman and Dammler 1969). Potassium delays the sorption of this colouring reagent.

The dimerisation of methylene blue can result in errors by modifying the concentration curves. The concentration of the aqueous solution must be carefully controlled. The absorption bands of monomer species decrease and, at low wavelengths, the bands of dimer and trimer species become more intense (metachromatism). The monomer methylene blue absorbs at 673 and 653 nm, the dimer at 600 nm, and the trimer at 570 nm (Cenens and Schoonheydt 1990; Bergmann and O'konski 1963).

## 26.4 CEC Measurement in Buffered Medium

### 26.4.1 Buffered Methods — General Information

The determination of charges of the soil exchange complex at constant pH is used with mono- or divalent cations at different pH (cf. “Influence of pH” in section 26.1.2). In a well-buffered medium, variations due to the soil pH are eliminated, but if the buffered pH is higher than the soil pH, they are likely to create negative charges on clay minerals and organic matter by dissociation of weak organic acids. The results are then overestimated, particularly in acid soils with variable charge.

For *monovalent cations* the most widely used buffering systems are:

- Ammonium acetate ( $\text{CH}_3\text{COONH}_4$ , mw = 77.08) at pH 4.0, 7.0 or 9.0;
- Sodium acetate ( $\text{CH}_3\text{COONa}\cdot 3\text{H}_2\text{O}$ , mw = 136.09) at pH 4.0, 8.0 or 8.2;
- Potassium acetate ( $\text{CH}_3\text{COOK}$ , mw = 98.14) at pH 7.0 or 8.3;
- Lithium acetate ( $\text{CH}_3\text{COOLi}\cdot 2\text{H}_2\text{O}$ , mw = 102.02) at pH 8.2;

and for divalent cations:

- Calcium acetate ( $(\text{CH}_3\text{-COO})_2\text{Ca}\cdot\text{H}_2\text{O}$ , mw = 176.18) at pH 4.8, 7.0 or 8.2;
- Calcium chloride ( $\text{CaCl}_2$ , mw = 110.99) + triethanolamine (TEA,  $\text{N}(\text{CH}_2\text{CH}_2\text{OH})_3$ , mw = 149.19) at pH 7.0;
- Barium acetate ( $(\text{CH}_3\text{-COO})_2\text{Ba}\cdot\text{H}_2\text{O}$ , mw = 273.47) at pH 7.0;
- Barium chloride ( $\text{BaCl}_2\cdot 2\text{H}_2\text{O}$ , mw = 244.31) + triethanolamine at pH 8.1–8.2;
- Magnesium acetate ( $\text{Mg}(\text{CH}_3\text{COO})_2\cdot 4\text{H}_2\text{O}$ , mw = 214.47);
- Strontium acetate ( $\text{Sr}(\text{CH}_3\text{COO})_2\cdot 1/2\text{H}_2\text{O}$ , mw = 214.73).

Counting the combinations of different salts used for saturation of the exchange complex (counter-cation), concentrations, contact times, soil-to-solution ratios, pH, processes of elimination of the excess of counter-cation and its displacement and the methods of characterization, more than 200 different or alternative methods were proposed between 1960 and 1980 alone (Gautheyrou and Gautheyrou 1981). However in practice, only a few methods are used regularly at the international scale:

- the  $1\text{ mol L}^{-1}$  ammonium acetate method at pH 7.0 which is regarded as the reference method for soil cartography and taxonomy;
- the barium method at pH 8.1 or 8.2 buffered by triethanolamine;

– Some methods are suitable for soils whose CEC is particularly difficult to measure, like that of soils that evolved in an arid climate which are generally rich in limestone, gypsum or soluble salts.

Andisols and soils with variable charge are usually analyzed by not-buffered methods.

Methods using a cation that does not exist in the soil make it possible to measure exchangeable cations (Ca, Mg, K, Na) in the saturation phase.

The choice of a method is often determined by the laboratory equipment available, the simplicity of the procedures and the ability to conduct serial analyses at an acceptable cost. For example, *in fine* the ammonium ion can be distilled and titrated by volumetry, the titration of the potassium ion is more sensitive than sodium titration by flame photometry using air-propane flame (calcium and barium ions are not measurable), the dispersion of clays is more frequent with sodium salts which make separation difficult without ultracentrifugation, and the high sodium contents are awkward during titration by emission spectrometry, etc.

Some studies focus on the requirements of agronomy and soil science such as the risk of potassium and ammonium fixation for example in illites and vermiculites, the predominant presence of divalent calcium and magnesium cations in the majority of non-acid soils, the questionable efficiency of the ammonium ion to displace protons and aluminium ions in 1:1 clays, the use of sodium as counter-ion in saline soils to limit the displacement of charges, the choice of a high pH to approach the pH of equilibration of certain soils with  $\text{pH} > 7.0$  and to limit the phenomena of solubilization.

For repetitive analyses the quality: price ratio is obviously important and the methods used must be able to deal with large sample numbers (cartography, agronomic controls). Methods based on knowledge acquired through research have been available for many years. The statistical exploitation of the results may enable models to be developed or farming advisory systems to be set up (for example, the DRIS<sup>2</sup> and the PARADES<sup>3</sup> system in California, which covers nearly 60 crops and many different climatic conditions with or without irrigation).

---

<sup>2</sup> DRIS, Diagnosis and Recommendation Integrated System (interactive system of research and extension).

<sup>3</sup> PARADES, Plant Analysis Recommendations and Diagnosis System.

## 26.4.2 Ammonium Acetate Method at pH 7.0

### Principle

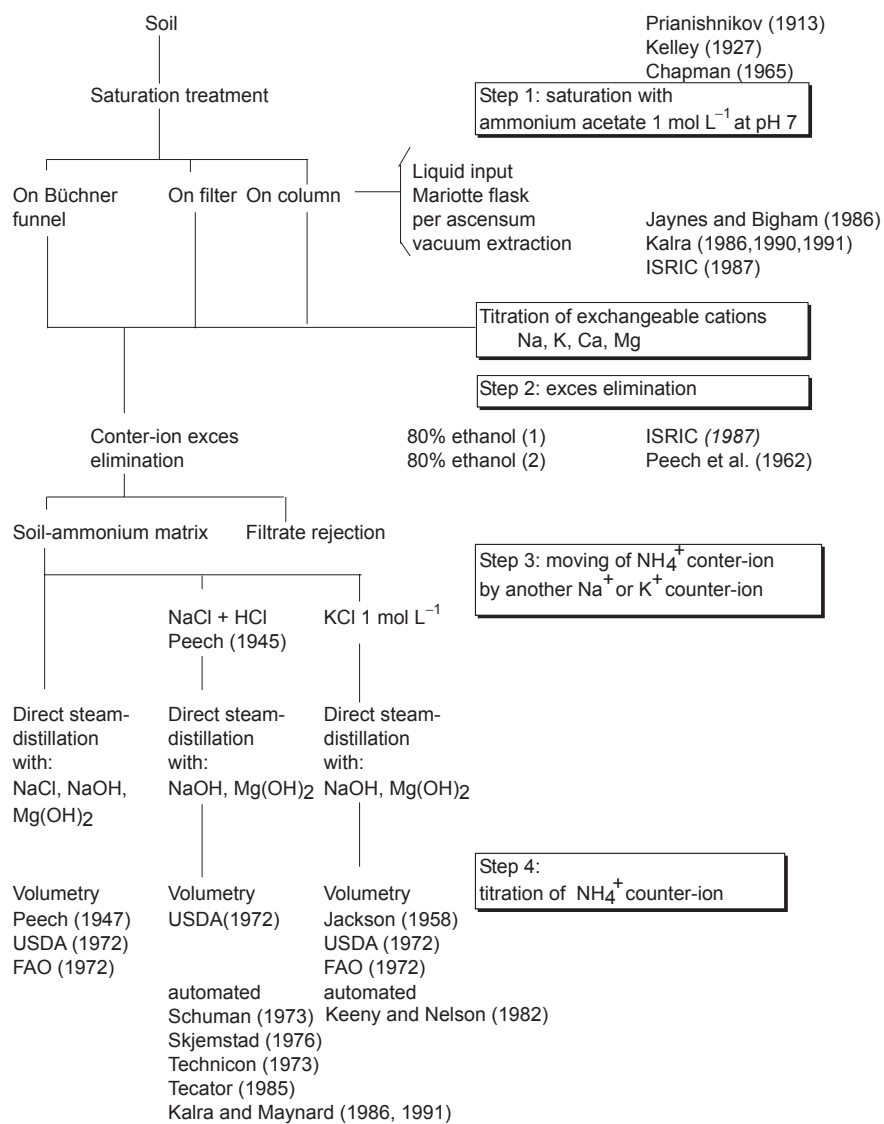

Fig. 26.5. Basic methods using ammonium acetate buffered solution

The soil is saturated by the ammonium counter-ion in a buffered medium at pH 7.0. Ammonium is adsorbed and an equivalent quantity of



cation is moved. The exchangeable cations are titrated in the percolation solution by flame photometry, atomic absorption or ICP spectrometry (Pansu et al. 2001). The excess counter-ion is eliminated by a solvent (e.g. 80% ethanol) thereby limiting hydrolysis. The counter-ion is moved by the potassium ion of a standard not-buffered potassium chloride solution (or by sodium acetate at pH 7.0, or by sodium chloride). To measure the CEC (total quantity of counter-cation that a soil can retain), ammonium can be titrated by distillation and volumetric analysis or automated spectrophotometry (Fig. 26.5). Note that the possible fixing of ammonium by clays is not significant in the determination of exchangeable cations, but can lower the CEC.

### **Improvements in the Method**

Determination of the CEC with buffered ammonium acetate is a multi-form method that has undergone considerable modification (Fig. 26.5). Originally used for the titration of exchangeable potassium (Prianishnikov 1913), then for the soil reaction (Schollenberger 1927) and finally for determination of the CEC (Schollenberger and Simons 1945; Kelley 1948; Peech et al. 1947), in the last 50 years the method has become an international reference.

The combination of the initial saturation treatment with treatments for the elimination of the excess ammonium ion, the nature of the counter-cation needed to displace ammonium and the final titration techniques led to very different procedures that generate significantly different results. Figure 26.5 lists some modifications made to the method that are still applied.

### **Reagents**

- $1 \text{ mol L}^{-1}$  ammonium acetate at pH 7.0: weigh 770.08 g of  $\text{CH}_3\text{COONH}_4$  (mw = 77.08) or dilute 600 mL of glacial acetic acid ( $\text{CH}_3\text{-COOH}$ , mw = 60.05) in approximately 9 L of deionised water and gradually add 750 mL of ammonia ( $\text{NH}_4\text{OH}$ ,  $d = 0.90$ ); let cool and check the pH; adjust to pH 7.0 with ammonia or acetic acid and complete to 10 L with deionised water.
- *Ethanol*: 80% ethanol 96° + 20% deionised water.
- $1 \text{ mol L}^{-1}$  potassium chloride: dissolve 745 g of KCl (mw = 74.5) in approximately 9 L of deionised water; after temperature equilibration, complete to 10 L with deionised water.
- *Nessler reagent* (test): (a) weigh 45.5 g of mercuric iodide ( $\text{HgI}_2$ , mw = 454.45) and 35.0 g of potassium iodide (KI, mw = 166.02); dissolve in a little water; (b) weigh 112 g of potassium hydroxide (KOH mw =

- 56.10) and dissolve in 500 mL of deionised water (from which CO<sub>2</sub> has been eliminated by boiling for 1 h and the water was stored safe from the air while cooling); mix a and b and bring to 1 L; store in a brown lightproof bottle protected from the air; prepare fresh each week; in the presence of ammonium ion the reagent gives a yellow–brown colouring (or brown flocculation if the ammonium contents are very high).
- *Taschiro reagent*: mix one part of 0.1% methyl red in ethanol and three parts of 0.1% bromocresol green in ethanol.
  - *Calcined heavy magnesia*: (Mg(OH)<sub>2</sub>, mw = 58.34).
  - *2% boric acid* (H<sub>3</sub>BO<sub>3</sub> mw = 61.84) in water.
  - *1/40 mol L<sup>-1</sup> (N/20) standard sulphuric acid solution*.
  - *1% phenolphthalein in ethanol*.

### **Procedure Using Steam Distillation**

#### **Exchange with the Ammonium Ion**

- Measure the moisture of the samples to correct the results on the basis of soil dried at 105°C.
- Weigh 2 g (or 5 g if the CEC is weak) of air-dried soil sieved to 0.5 mm.
- Put the soil in a 100 mL centrifugation tube with a screw cap and add 30 mL of 1 mol L<sup>-1</sup> ammonium acetate solution at pH 7.0.
- Homogenize on the vortex mixer for 2 min.
- Leave in contact overnight.
- Agitate again on the vortex mixer for 2 min and centrifuge at 5,000g for 5–10 min (depending on the physical properties of the soil).
- Decant the supernatant which must be limpid, without soil loss.
- Suspend again in 30 mL of ammonium acetate on the vortex mixer and leave in contact for 15 min.
- Centrifuge and decant the supernatant, add to the former.
- Repeat this treatment a third time, mixing all the supernatants.
- Titrate the exchangeable cations (Ca, Mg, K, Na) in the supernatant solution.

#### **Washing the Excess of Ammonium Ion**

- Add 30 mL of 80% ethanol.
- Homogenize on the vortex mixer.
- Centrifuge and discard supernatant alcohol.
- Repeat this treatment taking care to avoid soil loss.
- Using Nessler reagent, check the absence of ammonium in the third alcohol supernatant.

***Displacement of the Ammonium Ion***

- Add 30 mL of 1 mol (KCl) L<sup>-1</sup> solution.
- Shake on the vortex mixer and leave in contact for 30 min.
- Centrifuge and recover the supernatant taking care to avoid soil loss.
- Repeat this treatment twice; mix all the supernatants.
- Rinse the extraction solution carefully in a 600 mL Kjeldahl distillation flask (the solution can also be kept for ammonium titration by automated colorimetry).

***Titration of the Ammonium Ion by Steam Distillation***

- Immediately proceed to steam distillation (cf. section 14.2.1 in Chap. 14) after adding 5 g of calcined magnesia and one drop of phenol phthalein in the Kjeldahl flask (if a pink colour does not appear, add more magnesia to obtain an alkaline medium).
- Collect the distillate (approximately 100 mL) in 20 mL of 2% boric acid containing 3 drops of Taschiro indicator.
- Titrate with 1/40 mol (H<sub>2</sub>SO<sub>4</sub>) L<sup>-1</sup> solution until the colour turns greyish pink.

***Calculations***

One millilitre of H<sub>2</sub>SO<sub>4</sub> 1/40 mol L<sup>-1</sup> titrates 0.05 milliequivalents of CEC. For  $V$  mL of sulphuric acid solution, the CEC  $T$  is expressed in cmol (+) kg<sup>-1</sup> of air-dried soil:

$$T = V \times 0.05 \times 100.$$

The result can be corrected to take soil moisture into account. For soils with variable charge analyzed without preliminary drying,  $T$  is expressed compared to soil dried at 105°C by

$$T = V \times 0.05 \times 100 \times f$$

where  $f$  is moisture correction factor.

***Alternative Procedure Using Automated Colorimetry******Principle***

This alternative concerns only the final titration of the ammonium ion, while the other extraction and displacement procedures remain unchanged (cf. Sect. “Titration of the Ammonium Ion by Steam Distillation” earlier). The indophenol blue reaction in automated continuous-flow analysis was recommended for soil CEC by Nelson (1982) and Kalra and Maynard (1986, 1991). In alkaline medium and in the presence of sodium hypochlorite, ammonium ion results in a

blue colouring catalysed by sodium nitroprusside. The intensity of the colour is proportional to the quantity of ammonium ion and thus to the CEC.

### Reagents

- *Ammonium stock solution*: dissolve 0.4717 g of ammonium sulphate ( $(\text{NH}_4)_2\text{SO}_4$ , mw = 132.14) in distilled water and dilute to 1 L; the solution contains  $100 \mu\text{g} (\text{NH}_4^+\text{-N}) \text{mL}^{-1}$ ; store in a brown lightproof bottle in the refrigerator.
- $2 \mu\text{g} (\text{NH}_4^+\text{-N}) \text{mL}^{-1}$  *ammonium solution*: dilute 4 mL of stock solution to 200 mL.
- *Standard range for ammonium*: in 25 mL volumetric flasks, put 0, 2, 4, 6, 8, 10, 12  $\mu\text{g}$  of  $\text{NH}_4^+\text{-N}$  (0–6 mL of  $2 \mu\text{g} (\text{NH}_4^+\text{-N}) \text{mL}^{-1}$  ammonium solution) and add 15 mL of the NaCl or KCl reagent used for the displacement of the ammonium ion (or the same quantity as the volume actually used, cf. “Displacement of the Ammonium Ion” later); complete to 25 mL with deionised water.
- *Sodium nitroprusside reagent* ( $\text{Na}_2\text{Fe}(\text{CN})_5\text{NO}$ ,  $2\text{H}_2\text{O}$ , mw = 297.95): dissolve 68 mg in 100 mL deionised water; homogenize and store in a brown lightproof bottle in the refrigerator.
- *Phenol reagent* (mw = 94.11): dissolve 7 g of phenol in 100 mL deionised water; store in a brown lightproof bottle in the refrigerator.
- *Hypochlorite buffered reagent*: dissolve 1.480 g of sodium hydroxide (NaOH) in approximately 70 mL deionised water; add 4.98 g of anhydrous disodic phosphate ( $\text{Na}_2\text{HPO}_4$ , mw = 141.98); homogenize and after complete dissolution add 20 mL of a recently prepared 5% solution of sodium hypochlorite ( $\text{NaClO}$ ); the pH should be between 11.4 and 12; bring to 100 mL with deionised water.
- *Disodic EDTA*: dissolve 6 g of ethylene diamine tetra-acetic sodium salt ( $\text{C}_{10}\text{H}_{14}\text{O}_8\text{K}_2\text{Na}_2$ ,  $2\text{H}_2\text{O}$ , mw = 336.24) in approximately 80 mL deionised water; when dissolution is complete, adjust the pH to 7.0 with sodium hydroxide and complete to 100 mL.

### Procedure

- Take a filtered aliquot of the final KCl solution of the CEC (from 3 to 5 mL depending on the concentration).
- Add in a 25 mL volumetric flask:
  - 1 mL of EDTA reagent,
  - 2 mL of phenol reagent,
  - 2 mL of nitroprusside reagent,
  - 4 mL of buffered hypochlorite reagenthomogenize after each addition

- Bring to 25 mL with deionised water.
- Place in the water bath at 40 °C for 30 min, then cool for 15 min and measure absorbance at 636 nm.
- Measure two blanks (reagents without soil sample) and read all results from the curve of the standard range obtained in the same conditions.

This method can also be performed automatically by segmented continuous-flow analysis using the manifold shown in Fig. 26.6.

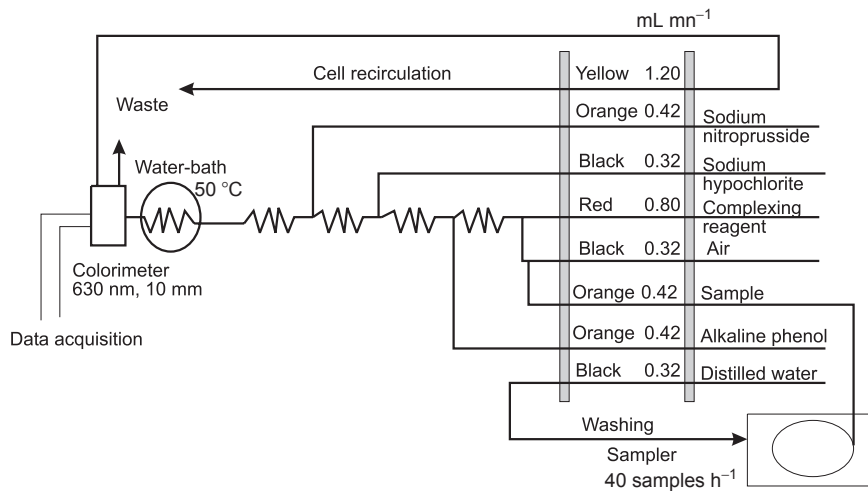

**Fig. 26.6.** Titration of ammonium ions in the NaCl extracts for measurement of the soil CEC by colorimetry with automated segmented continuous-flow analysis (Kalra and Maynard 1986, 1991).

### Remarks

The ammonium acetate method at pH 7 is appropriate for not-calcareous soils with a moderate pH of between 5.5 and 7.5 and permanent charges, but it is not recommended for organic soils, composts, and peats because of the solubility of organic matter in ammonium acetate and ethanol.

Calcium and magnesium carbonates, as well as soluble gypsum and salts, are more or less soluble in ammonium acetate and interfere in the exchange. In soils with variable acid charges, the CEC is then overestimated.

In the case of 1:1 minerals like kaolinite and halloysite, the ammonium ion cannot completely move the Al<sup>3+</sup> and H<sup>+</sup> ions. In 2:1 minerals like vermiculite and micas-illite, ammonium can be fixed and become non-exchangeable. For this reason, sodium and barium ions are sometimes

preferred as nowadays they are more completely exchanged and easily titrated.

The type of ammonium acetate (cf. "Reagents") depends on financial and practical considerations. Commercial salt is more expensive than its ammonia and acetic acid components and tends to harden in the bottle during prolonged storage.

The successive cation exchanges and stages of rinsing are potential sources of error, for example due to soil loss by dispersion or incomplete exchanges. Some authors prefer to use Büchner funnels equipped with a double filter. The 80% ethanol should be neutral but does not have to be neutralized by ammonia in the presence of an indicator. Ethanol can be distilled on calcium hydroxide. The 80% ethanol: 20% water mixture enables excessive dehydration to be avoided (ISRIC 1987).

Checking the elimination of surplus ammonium in the ethanol filtrates is based on the Nessler reaction:

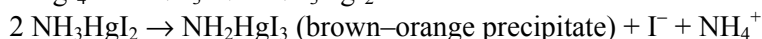
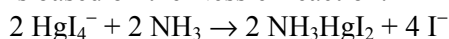

Direct distillation of the soil enables errors to be avoided by removing three sub-stages of saturation by the counter-ion with the risk of losses. But distillation can result in a positive error by releasing ammonium from organic matter, particularly if soda is used instead of magnesia.

### 26.4.3 Buffered method at pH 8.0–8.6

#### *Principle*

These methods were usually developed for soils resulting from weathering processes which, in arid regions, involves the release of alkaline and alkaline-earth salts. The exchange complex may be saturated with  $\text{Na}^+$ ,  $\text{Ca}^{2+}$ ,  $\text{Mg}^{2+}$  ions in calcareous ( $\text{CaCO}_3$ ,  $\text{MgCO}_3$ ), gypseous ( $\text{CaSO}_4$ ), salic and sodic (containing soluble salts giving  $\text{Na}^+$ ,  $\text{Cl}^-$ ,  $\text{SO}_4^{2-}$ ,  $\text{CO}_3^{2-}$  ions) soils. Some humic or peat acid soils are also analyzed by buffered methods at  $\text{pH} \geq 8.0$ . The main methods are based on:

- Buffered solutions at pH 8.0–8.6 close to the soil pH with low chemical dissolution of the alkaline-earth carbonates which could compete with the counter-cation; the use of anion exchange resins enables elimination of the dissolved carbonates and sulphate (Bergseth and Abdel-Aal 1975);
- the use of divalent ions that do not exist in the soil, and an exchange capacity close to calcium and magnesium ions which predominate in

- the main types of soils or possibly the use of sodium ions for saline soils, in order to limit modifications in charges;
- the use of solvents like ethanol or methanol which are less polar than water and limit solubilization and hydrolysis phenomena.

However, a modification in the degree of solvation of the exchangeable cations can affect some properties, in particular in the presence of zeolites (steric obstruction, molecular sieve). There is no universal method for the determination of the CEC on all soils in temperate and tropical climates, aridic or aquatic systems.

The methods are more complex and less precise when the CEC has to be determined in a medium that contains soluble limestone, gypsum and salts at the same time.

Many studies have been undertaken to try and obtain satisfactory results for complex soil genesis, to simplify procedures and improve the precision and specificity while eliminating stages that can generate errors.

Monovalent cations like sodium or lithium (linked to anions like acetate, formate or chloride), or divalent cations like barium, calcium or magnesium (chloride, nitrate, sulphate), have been used in combination with triethanolamine (TEA) to buffer the medium.

All these methods originated in the works of Mehlich (1938, 1942, 1953), Bower et al. (1952), Yaalon et al. (1962), Bascomb (1964), Bergseth and Abdel-Aal (1975), Polemio and Rhoades (1977), Sayeh et al. (1978), Gillman (1979), Rhoades (1982), Misopolinos and Kavovoulos (1984); Gupta et al. (1985), Tucker (1985), Frenkel et al. (1986), Begheyn (1987), Drechsel (1987), and Sharma and Dubey (1988).

### ***Sodium Acetate Buffered at pH 8.2***

#### ***Principle***

This method includes two stages (Rhoades 1982):

- The cationic sites of the exchange complex are saturated by sodium ions in the form of acetate or chloride as markers in a solution containing 60% of 95° ethanol to limit solubilization of the non-exchangeable forms;
- Sodium counter-ion is extracted with a magnesium cation in nitrate solution.

Sodium and chloride are titrated in the final extract (excess soluble sodium in the extraction solution can be deduced from total measured sodium giving exchangeable sodium equivalent to the CEC).

This method is suitable for soils containing carbonates, gypsum and zeolites and can also be used on salic and sodic soils. However, Gupta

et al. (1985) mentioned some difficulties in saline soils with a higher pH and suggest the pH of the saturation solution should be adjusted to that of the soil in aqueous medium and include a second stage with a magnesium nitrate solution at pH 8.6.

### **Reagents**

- *Saturation solution* of 0.4 mol L<sup>-1</sup> sodium acetate and 0.1 mol L<sup>-1</sup> sodium chloride in 60% ethanol: weigh 54.4320 g of sodium acetate (CH<sub>3</sub>COONa, 3H<sub>2</sub>O, mw = 136.09) and 5.8450 g of sodium chloride (NaCl, mw = 58.45); dissolve in approximately 300 mL of deionised water; add 600 mL of pure 95° ethanol and adjust the pH to 8.2 with 6 mol L<sup>-1</sup> soda; complete to 1 L with deionised water; titrate sodium and chloride ions and determine the Na<sup>+</sup>:Cl<sup>-</sup> ratio of the solution.
- *Extraction solution* of 0.25 mol L<sup>-1</sup> magnesium nitrate: weigh 6.411 g of magnesium nitrate (Mg(NO<sub>3</sub>)<sub>2</sub>, 6H<sub>2</sub>O, mw = 256.43) and dissolve in approximately 900 mL of deionised water; complete to 1 L.

### **Procedure**

- Determine the moisture of the samples to bring back the results to soils dried at 105°C.
- Weigh 5 g of air dried soil sieved to 0.5 mm in a 100 mL centrifugation tube with a screw cap.

### **Saturation**

- Add 33 mL of saturation solution (if the electric conductivity of the salt content is higher than 4 mmhos cm<sup>-1</sup> first carry out a preliminary extraction with 33 mL of deionised water).
- Centrifuge at 2,500g for 5 min and decant the supernatant taking care to avoid soil loss.
- Add 33 mL of saturation solution and shake the tube on the vortex mixer to remove the centrifugation pellet, then in an ultrasound tank for 30 s to disperse the sample.
- Agitate for 5 min, centrifuge and decant the supernatant.
- Repeat this treatment twice and discard the liquid fractions.

### **Displacement of the Sodium Counter-Ion**

- Add 33 mL of magnesium nitrate extraction solution to the centrifugation pellet.
- Stir on the vortex mixer and shake for 5 min.
- Centrifuge and decant the supernatant in a 100 mL volumetric flask.
- Again add 33 mL of extraction solution and repeat the extraction twice.
- Mix the three supernatants, complete to 100 mL with the extraction solution and homogenize.



**Titration of the Displaced Sodium Counter-Ion**

– Determine total sodium  $[Na^+T]$  by flame photometry and total chloride  $[Cl^-T]$  by coulometry–amperometry (cf. Sect. 18.3.6 of Chap. 18), in  $cmol\ L^{-1}$  in the extracts, using calibration ranges prepared in the magnesium nitrate extraction solution.

**Calculations**

$CEC = (Na^+T - \text{soluble } Na^+) \text{ in } cmol\ (+)\ kg^{-1}\ (\text{soil})$

$$CEC = \frac{10}{w} ([Na^+T] Df_{Na^+} - [Cl^-T] Df_{Cl^-})$$

$w$ , sample weight;  $Df$ , dilution factor, i.e. ratio of the final volume to volume of the aliquot.

**Barium Chloride–Triethanolamine (TEA) at pH 8.1****Principle**

The soil is saturated by barium ion in medium buffered by triethanolamine (TEA) at pH 8.1.

The barium counter-cation is moved by the magnesium divalent cation. Titration of the displaced barium is carried out by emission spectrometry at 489 nm or by atomic absorption spectrometry and gives the potential CEC at this pH; this is considered to be representative of the basic quantity adsorbed by a soil in the presence of limestone in equilibrium with air  $CO_2$  at normal pressure.

This method is used for acid, organic, calcareous or 1:1 clay soils. It overestimates the CEC values of soils whose pH is lower than 8.2.

It also enables measurement of total potential acidity to determine liming requirements (cf. Chap. 24).

**Reagents**

- *Barium chloride–triethanolamine buffered solution*: weigh 61.077 g of  $BaCl_2 \cdot 2H_2O$  (mw = 244.31); dissolve in about 900 mL of boiled deionised  $CO_2$ -free water, add 29.84 g of triethanolamine ( $N(CH_2-CH_2OH)_3$ , mw = 169.19); homogenize and bring to pH 8.1 with HCl; complete to 1 L; protect the reagent from contact with atmospheric  $CO_2$  by storing it in a bottle closed by a air intake tube filled with soda lime.
- *Replacement solution*: weigh 61.077 g of  $BaCl_2 \cdot 2H_2O$ , dissolve in approximately 900 mL boiled deionised  $CO_2$ -free water, add 0.4 mL of the above buffered solution; complete to 1 L and protect from atmospheric  $CO_2$  in the same way as the buffered solution.

- *Final exchange solution*: weigh 123.21 g of magnesium nitrate ( $\text{Mg}(\text{NO}_3)_2 \cdot 6\text{H}_2\text{O}$  (mw = 256.43) well dried in a desiccator; dissolve in about 900 mL of deionised water; bring to 1 L.
- *Bromocresol green indicator* (3,3', 5,5' tetrabromo m cresol sulfone phthalein): make a 0.1% solution in water.
- *Mixed indicator*: weigh 1.250 g of methyl red (*p*-dimethylamino azobenzene *O*-carboxylic acid; mw = 269.29); weigh 0.825 g of methylene blue (3,7 bis dimethylamino phenazathionium chloride, mw = 373.90); dissolve in 1 L of neutral 90° ethanol.

### Procedure

- Measure the soil moisture in order to correct the results to soil dried at 105°C.
- Weigh 5 g of soil, add 25 mL of buffer solution and homogenize.
- Leave in contact for 1 h avoiding contact with atmospheric  $\text{CO}_2$ .
- Transfer on a small Büchner funnel with a diameter of 50 mm equipped with a fine filter for quantitative analysis and filter slowly.
- Percolate with 75 mL buffer solution, added in small fractions at regular intervals.
- Place the percolate in a 200 mL volumetric flask.
- Add 100 mL of replacement  $\text{BaCl}_2$  solution in small fractions and mix the percolate in the 200 mL flask.
- Complete volume to 200 mL with the replacement solution (EA solution); store the wet soil in the Büchner funnel while waiting to continue CEC titration.
- Prepare a blank with 100 mL of buffer-TEA solution and 100 mL of replacement solution.
- Wash the soil with approximately 100 mL methanol until chloride is eliminated ( $\text{AgNO}_3$  test).
- Remove excess methanol by washing with  $0.0005 \text{ mol L}^{-1}$  (0.001 N) barium chloride solution.
- Pack the soil flat in the Büchner to eliminate 0.001 N  $\text{BaCl}_2$  (the error due to the presence of residual 0.001 N  $\text{BaCl}_2$  is negligible, but can be corrected by weighing Büchner + filter + soil).
- Add 250 mL of  $\text{Mg}(\text{NO}_3)_2$  exchange solution in small fractions leaving the Büchner under weak vacuum to obtain a total contact time of approximately 16 h.
- Complete the volume of the exchange solution to 250 mL (CEC solution).
- Titrate the barium ion by atomic emission (489 nm) or absorption or ICP spectrometry (Pansu et al. 2001), using a standard range prepared in the  $\text{Mg}(\text{NO}_3)_2$  exchange solution.

*Measurement of exchangeable acidity in EA solution:* add two drops of bromocresol green indicator and few drops of mixed indicator; titrate with a 0.1 mol (HCl) L<sup>-1</sup> solution until the colour turns greyish violet.

### Calculations

The exchange acidity *EA* is expressed in cmol (H<sup>+</sup>) kg<sup>-1</sup> (soil) by:

$$EA = \frac{100 (V_b - V_s) N}{w},$$

where  $V_b$ ,  $V_s$  are volumes of 0.1 mol (HCl) L<sup>-1</sup> solution necessary for the back-titration of the blank and the sample, respectively (EA percolate),  $w$  is the weight of the sample with correction of moisture content to that of soil dried at 105°C.

The CEC is expressed in cmol (+) kg<sup>-1</sup> by:

$$CEC = 25 \frac{T_{Ba}}{w} Df,$$

where  $T_{Ba}$  is the barium titre of the CEC solution in mmol (1/2Ba<sup>++</sup>) L<sup>-1</sup> given on the calibration curve,  $Df$  is the dilution factor.

### Remarks

This method involves the neutralization of several types of acidity (cf. Chap. 23):

- Acidity generated by exchangeable protons;
- Acidity resulting from hydrolysis phenomena in soils with a pH < 5.2,

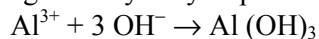

- Acidity resulting from organic matter (acid functional groups) especially at pH < 5.5 (Thomas 1982).

#### 26.4.4 Buffered Method at Different pH

These methods are very useful for the study of soils with variable charges. They enable standardization of repetitive procedures using CEC techniques in buffered medium with a simple change of extraction reagent. Charges developed at different pH can be checked using two or three measurements at acid, neutral and basic pH depending on the soil type. This gives an acceptable approximation of the CEC at the soil pH and helps sort out samples on which more complete charge analyses have to be performed (e.g. ZPC, cf. Chap. 20).

**Fig. 26.7.** Relation between pH and cation exchange capacity (measured with 1 mol L<sup>-1</sup> ammonium acetate solution on air-dried samples) on allophanic soils from Guadeloupe (Gautheyrou and Gautheyrou 1981)

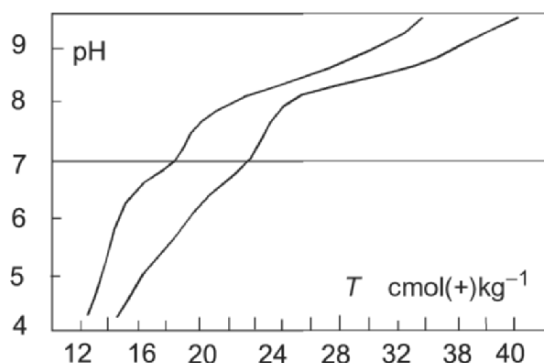

The exchange properties of allophanic soils have been characterized by measurements of the  $\Delta\text{CEC} = \text{CEC measured at pH 3.5} - \text{CEC measured at pH 10.5}$ . But the dissolution phenomena of mineral and organic fractions which appear at extreme pH in these types of soil sometimes make this measurement uncertain (Aomine and Jackson 1959; Yoshinaga and Aomine 1962; Alexiades and Paxinos 1965; Espinoza 1969).

The method of Fey and Leroux (1976) using 0.05 mol ( $\frac{1}{2}\text{CaCl}_2$ ) L<sup>-1</sup> was used

- at pH 3, 5 and 7 to measure the surface charges that depend on pH (CEC–AEC; Hendershot and Lavkulich 1983);
- at pH 3, 4, 5, 6, 7, 8 with a  $\text{Ca}(\text{NO}_3)_2\text{--NH}_4\text{Cl}$  system (Duquette and Hendershot 1987).

The 1 mol L<sup>-1</sup> ammonium acetate method was used from pH 4–9 for allophanic soils (Gautheyrou and Gautheyrou 1981), the stability constants of the ammonium acetate buffer enabling this pH zone to be covered without the use of other systems (Fig. 26.7).

In andosols, allophanic substances that are invisible to X-ray are easily detected by the sodium fluoride test, but the significant variations in the CEC values at pH 7 and especially at pH 9 are characteristic of soils with variable charges. This method makes it possible to measure (for a single pH) changes in the charges of a soil both preserved in its original moisture and after prolonged air drying. The effect of pretreatments can also be examined, for example the saturation of the AEC by a  $\text{PO}_4^{3-}$  reagent. Indeed, addition of  $\text{PO}_4^{3-}$  causes packing of the negative surface charges in the hydrandeps resulting in the lowering of the pH 0 value (El Swaify and Sayegh 1975).

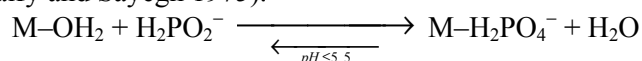

creation of negative charges (M = Fe, Al, Si, Ti).

In soils with strong aluminic acidity, the opposite effect can be observed with aluminium (Uehara and Keng 1975). Table 26.2 shows the effect of the phosphate ion on the CEC of different soils (Gautheyrou and Gautheyrou 1981).

**Table 26.2.** Variations in the CEC as a function of pretreatments of anionic saturation with phosphate ions (Gautheyrou and Gautheyrou 1981; soils in their natural moisture, not air-dried, results brought back to soils dried at 105°C)

soil	ref.	moisture %	T(NH <sub>4</sub> ) pH 7.0 cmol(+)kg <sup>-1</sup>		total P cg kg <sup>-1</sup>	
			1	2	1	2
cryandept	Ecuador E 264 a	35.31	10.50	13.50	100.00	234
hydrandept	AntillesB 570 c	189.43	22.25	38.00	177.50	1,450
imogolitic	Antilles B 570 f	116.68	19.50	44.00	67.25	1,700
ferrallitic	Antilles L 415 a	4.59	14.00	15.00	42.50	244
ferrallitic	Antilles L 415 b	4.23	11.50	11.50	25.00	310
halloysite	Antilles L 21 b	8.58	16.50	20.00	37.50	275

1, without preliminary treatment;

2, with saturation by dipotassic phosphate.

## References

- Alexiades CA and Paxinos SA (1965) A method for determination of allophane in soil clays. *Agric. Anals. Aristotelian Univ. (Thessaloniki)*, 275–301
- Amavis (1959) Comparaison des méthodes de mesure de la capacité d'échange d'ions d'un sol. Mise au point d'une méthode rapide. *Science du Sol*, AFES, 8, 317-325
- Aomine S and Jackson ML (1959) Allophane determination in ando soils by cation-exchange capacity delta value. *Soil Sci. Soc. Am. Proc.*, 23, 210–213
- Bascomb CL (1964) A rapid method for the determination of cation exchange capacity of calcareous and non calcareous soils. *J. Sci. Food. Agric.*, 15, 821–823
- Begheyn L Th (1987) A rapid method to determine cation exchange capacity and exchangeable bases in calcareous, gypsiferous, saline and sodic soils. *Commun. Soil Sci. Plant Anal.*, 18, 911–932

- Bergmann K and O'Konski CT (1963) A spectroscopic study of methylene blue monomer, dimer and complexes with montmorillonite. *J. Phys. Chem.*, 67, 2169–2177
- Bergseth H and Abdel-Aal Shi (1975) Ion exchange removal of calcium carbonate and gypsum from mineral material prior to determination of cation exchange capacity using  $^{89}\text{Sr}^{2+}$ . *Colloid Polym. Sci.*, 253, 322–324
- Bolt GM (1982) Soil Chemistry – B – physico-chemical models. ELSEVIER, Developments in soil science 5B, 226–229
- Cenens J and Schoonheydt RA (1990) Quantitative absorption spectroscopy of cationic dyes on clays. Proc. 9th Intern. Clay Conference, Strasbourg. In *Pub. Sci. Geol. Mem.*, Farmer VC and Tardy Y ed. 85, 15–23
- Chabra R, Pleysier J and Cremers A (1976) The measurement of the cation exchange capacity and exchangeable cations in soils : a new method. *Proc. Int. Clay Conf.*, 1, 439–449
- Coleman NT and Thomas GW (1967) The basic chemistry of soil acidity. In *Soil Acidity and Liming*, Pearson RN et Adams F ed. Am. Soc. Agr.
- Cornell RM and Aksoyoglu ES (1991) Simultaneous determination of the cation exchange capacity and the exchangeable cations on marl. *Clay Miner.*, 26, 567–570
- Cornell RM and Aksoyoglu ES (1991) Simultaneous determination of the cation exchange capacity and the exchangeable cations on marl. *Clay Miner.*, 26, 567–570
- Drechsel P (1987) Determining cation exchange capacity and exchangeable cations in saline, calcareous and gypserous soils. *Z. Pflanzenernähr. Bodenk.*, 150, 357
- Duquette M and Hendershot WH (1987) Contribution of exchangeable aluminium to cation exchange capacity at low pH. *Canad. J. Soil Sci.*, 67, 175–185
- Edmeades DC and Clinton OE (1981) A simple rapid method for the measurement of exchangeable cations and effective cation exchange capacity. *Commun. Soil Sci. Plant Anal.*, 12, 683–695
- El Swaify SA and Sayegh AW (1975) Charge characteristics of an oxisol and an inceptisol from Hawai. *Soil Sci.*, 120, 49
- Espinoza WG (1969) Determinacion de alofan en suelos de Nuble mediante el valor delta de la capacidad total de intercambio cationico. *Agricultura Tecnica (Chili)*, 29, 127–132
- Esquevin J (1954) *Mesure de la CEC des argiles par le chlorure de cobalti-hexamine*. Museum Histoire Naturelle, Paris
- Fallavier P, Babre D and Breyse M (1985) Détermination de la capacité d'échange cationique des sols tropicaux acides. *Agronomie Tropicale*, 40, 298–308

- Fey MV and Leroux J (1976) Electric charges on sesquioxidic soils clays. *Soil Sci. Soc. Am. J.*, 40, 359–364
- Frenkel H, Gerstl Z and Van de Veen JR (1986) Determination of gypsum and cation exchange capacity in arid soils by a resin method. *Geoderma*, 39, 67–77
- Fripiat JJ and Helsen J (1966) Use of cobalt hexamine in the cation exchange capacity determination of clays. *Clays Clay Miner.*, 14, 163–169
- Gangaiya P and Morrison RJ (1987) A simple non-atomic absorption procedure for determining the effective cation exchange capacity of tropical soils. *Soil Sci. Plant Anal.*, 18, 1421–1430
- Gautheyrou J and Gautheyrou M (1981) *Contribution à l'étude de la capacité d'échange des sols à allophane : aspect analytique de la CEC et ses conséquences sur l'interprétation pédo-agronomique.*, Notes laboratoires, Vol. 1, 274 pp., vol. 2, 123 pp. + annexe, 154 profils, IRD (ex-Orstom), Antilles, Paris
- Gillman GP (1979) A proposed method for the measurement of exchange properties of highly weathered soils. *Austr. J. Soil Res.*, 17, 129–139
- Gupta RK, Singh CP and Abrol IP (1985) Determining cation-exchange capacity and exchangeable sodium in alkali soils. *Soil Sci.*, 139, 326–332
- Hendershot WH and Lavkulich LM (1983) Effect of sesquioxide coatings on surface charge of standard mineral and soil samples. *Soil Sci. Soc. Am. J.*, 47, 1252–1260
- Hoffman U and Dammler J (1969) Die methylenblauadsorption on montmorillonite. *Chimia*, 23, 476–480
- ISRIC (1987) *Procedures for Soil Analysis*, 9-5/9-7. International soil reference and information center, 2e edition
- Johanson A (1961) Cobalt – an expedient agent in soil testing for T, S and exchangeable Ca, Mg and Mn. *Soil Sci.*, 364–368
- Johnson CE Jr (1957) Méthylène blue adsorption and surface area measurements. *131st National Meeting Am. Chem. Soc.*, 7–12
- Juo ASR, Ayanjala SA and Ogunwale JA (1976) An evaluation of cation exchange capacity measurements of soils in the tropics. *Commun. Soil Sci. Plant Anal.*, 1, 751–761
- Kamprath EJ (1970) Exchangeable Al as a criterium for liming leached mineral soils. *Soil Sci. Soc. Am. Proc.*, 34, 252–254
- Keita MK and Van Der Pol F (1987) Comparison of exchangeable bases and CEC by the cobalti-hexamine method and the standard ammonium acetate method on some malinese soils. *ISRIC*, 87–98
- Kelley WP (1948) *Cation exchange in soils.*, Reinhold. ACS Monograph no. 109, 144 pages
- Lagaly G (1981) Characterization of clays by organic compounds. *Clay Minerals*, 16, 1–21
- Mantin I and Glaeser R (1960) Fixation des ions cobalti-hexamine par les montmorillonites acides. *Bull. Groupe Fr. Argiles*, 12, 83–88

- Mantin I (1969) Mesure de la capacité d'échange des minéraux argileux par l'éthylène diamine et les ions complexes et l'éthylène-diamine. *C.R. Acad. Sc. Paris*, 269, 815–818
- Mas A, Peigneur P and Cremers A (1978) Stability of metal (uncharged) ligand complexes in ion exchanges. Part 2 : The copper–ethylene–diamine complex in montmorillonite and sulphonic acid resin. *J. Chem. Soc. Faraday Trans.*, 1 (74), 182–189
- Mehlich A (1938) Use for triethanolamine acetate–barium hydroxyde buffer for determination of some base exchange properties and lime requirements of soil. *Soil Sci. Soc. Am. Proc.*, 3, 165–166
- Mehlich A (1942) Rapid estimation of base-exchange properties of soils. *Soil Sci.*, 53, 1–14
- Mehlich A (1953) Rapid determination of cation and anion exchange properties and pH of soils. *J. Assoc. Agr. Chem.*, 36, 445–457
- Misopolinos ND and Kalovoulos JM (1984) Determination of CEC and exchangeable Ca and Mg in non-saline calcareous soils. *Soil Sci.*, 35, 93–98
- Morel R (1957) Etude expérimentale des phénomènes d'échange sur différents minéraux argileux. *Ann. Agron.*, 6, 5–90
- Nevins MJ and Weintritt DJ (1967) Determination of cation exchange capacity by methylene blue adsorption. *Am. Ceram. Soc. Bull.*, 46, 587–592
- NF ISO 11260 (1994) Détermination de la capacité d'échange cationique effective et du taux de saturation en bases échangeables à l'aide d'une solution de chlorure de Baryum. In *Qualité des sols*, 1999, AFNOR, Paris, 415–428
- NF ISO 14254 (1997) *Détermination de l'acidité échangeable dans un extrait au chlorure de baryum.*, AFNOR, Paris
- Oliver R (1984) Etude comparative de deux méthodes d'extraction et de dosage des bases et de la capacité d'échange sur les sols du Sénégal. *Agronomie Tropicale*, 39, 14–21
- Orsini, L. & Remy, J.C. 1976. Utilisation du chlorure de cobaltihexammine pour la détermination simultanée de la capacité d'échange et des bases échangeables des sols. *Science du Sol*, 4, 269–275.
- Pansu M, Gautheyrou J and Loyer JY (2001) *Soil Analysis – Sampling, Instrumentation and Quality Control.*, Balkema, Lisse, Abington, Exton, Tokyo, 489 pp
- Peech M, Alexander LT, Dean LA and Ree JF (1947) *Methods of Soil Analysis for Soil Fertility Investigations.*, US Dept. Agr., 757, 25 p
- Peigneur P (1976) *Stability and Adsorption Affinity of Some Transition Metalamine Complexes in Alumino-Silicates.*, Thèse Univ. Louvain
- Phelps GW and Harris DL (1967) Specific surface and dry strength by methylene blue adsorption. *Am. Ceram. Soc. Bull.*, 47, 1146–1150



**CEC with organic cations**

- Pleysier J and Cremers A (1973) Adsorption of silver thiourea complexes in montmorillonite. *J. Nat.*, 243, 86–87
- Pleysier J and Cremers A (1975) Stability of silver–thiourea complexes in montmorillonite clay. *Chem. J. Soc. Faraday Trans.*, I (71), 256–264
- Pleysier JL and Juo ASR (1980) A simple extraction method using silver. Thiourea for measuring exchangeable cations and effective CEC in soils with variable charges. *Soil Sci.*, 129, 205–211
- Polemio M and Rhoades JD (1977) Determining cation exchange capacity : a new procedure for calcareous and gypsiferous soil. *Soil Sci. Soc. Am. J.*, 41, 524–528
- Prianishnikov D (1913) Quantitative bestimmung der in boden vorhanden absorptiv gebunden basen. *Landw. Vers. Stat.*, (79/80), 667–680
- Rhoades JD (1982) Cation exchange capacity. In *Methods of Soil Analysis*, part 2, Page AL, Miller RH and Keeney DR ed. Am. Soc. Agronomy, 2, 154–157
- Rytwo G, Serban C, Nir S and Margulies L (1991) Use of methylene blue and crystal violet for determination of exchangeable cations in montmorillonite. *Clays Clay Miner.*, 39, 551–555
- Sayeh AH, Khan NA, Khan P and Ryan J (1978) Factors affecting gypsum and cation exchange capacity determinations in gypsiferous soils. *Soil Sci.*, 125, 294–300
- Schollenberger CJ and Simons RH (1945) Determination of exchange capacity and exchangeable bases in soils. *Soil Sci.*, 59, 13–24
- Schollenberger CJ (1927) Exchangeable hydrogen and soil reaction. *Science*, 65, 552–553
- Searle PL (1986) The measurement of soil cation exchange properties using the single extraction, silver thiourea method : an evaluation using a range of New Zealand soils. *Austr. J. Soil Res.*, 2, 193–200
- Sharma OP and Dubey DD (1988) Evaluation of suitable method for estimating CEC of sodic black soils. *J. Indian Soc. Soil Sci.*, 36, 546–549
- Siegried CH, Weinert W and Strelow FWE (1986) The influence of thiourea on the cation-exchange behaviour of various elements in dilute nitric and hydrochloric acids. *Talanta*, 33, 481–487
- Stuanes PO, Ognés G and Opem M (1984) Ammonium nitrate as extractant for soil exchangeable cations, exchangeable acidity and aluminum content. *Soil Sci. Plant Anal.*, 15, 773–778
- Stucki JW, Golden DC, Roth CB, (1984) Effects of reduction and reoxidation of structural iron on the surface charge and dissolution of dioctahedral smectites. *Clays Clay Miner.*, 32, 350–356
- Thomas GW (1982) Exchangeable cations. In *Methods of Soil Analysis*, part 2, Page AL, Miller RH and Keeney DR ed. Am. Soc. Agronomy, 2e edition, 9 (2), 159–165

- Tucker BM (1985) A proposed New Reagent for the measurement of cation exchange properties of carbonate soils. *Aust. J. Soil Res.*, 23, 633–642
- Uehara G and Keng J (1975) Management implications of soil mineralogy in Latin America. In *Soil Management in Tropical America*, Bornemisza E et Alvarado A ed. North-Carolina Univ. Press, 351
- Van Rosmalen HA (1980) *Evolution and Modification of the Determination of Exchangeable Bases and Cation Exchange Capacity of Calcareous and Gysiferous Soils by Using Silver–Thiourea.*, Royal Tropical Inst. Dept. Agric. Res. Project AOBO39 (Amsterdam), Report BO, 80–83
- Yaalon DH, Van Schuylenborgh J and Slager S (1962) The determination of cation exchange characteristics of saline and calcareous soils. *Nether. J. Agr. Sci.*, 10, 218–222
- Yoshinaga N and Aomine S (1962) Imogolite in some ando soils. *Soil Sci. Plant Nutr.*, 8, 22–29
- Yuan TL (1959) Determination of exchangeable hydrogen in soils by a titration method. *Soil Sci.*, 88, 164–167

## Bibliography

### CEC general theory

- Chu CH and Johnson LJ (1979) Cation-exchange behavior of clays and synthetic aluminosilica gels. *Clays Clay Miner.*, 27, 87–90
- Dyer A, Shaheen T and Newton GWA (1995) Speciation observed by cation exchange. *Sci. Total Environ.*, 173–174, 301–311
- Effron D, Jimenez MP, Horra AM de la (2000) Cation exchange capacity at the soil pH level to be applied to acid soils: methods and determination. Capacidad de intercambio cationica al pH del suelo, para suelos acidos: metodo de determinacion. *Agrochimica.*, 44, 61–68
- Erp PJ van, Houba VJG and Beusichem ML van (2001) Actual cation exchange capacity of agricultural soils and its relationship with pH and content of organic carbon, *Communications-in-Soil-Science-and-Plant-Analysis*, 32, 19–31
- Fauziah CI, Jamilah I and Omar SRS (1997) An evaluation of cation exchange capacity methods for acid tropical soils, *Pertanika J. Tropical Agric. Sci.*, 20, 113–119
- Kalra YP and Maynard DG (1994) A comparison of extractants for the determination of cation exchange capacity and extractable cations by a mechanical vacuum extractor. *Commun. Soil Sci. Plant Anal.*, 25, 1505–1515

- Khan NA (1994) Comparison of CEC values with and without pretreatment of gypsiferous soils. *Sarhad Journal of Agriculture*, 10, 713–720
- Liu CL, Wang MK and Yang CC (2001) Determination of cation exchange capacity by one-step soil leaching column method. *Commun. Soil Sci. Plant Anal.*, 32, 2359–2372
- Pleysier JL, Jansens J and Cremers A (1986a) A clay suspension stability and point titration method for measuring cation exchange capacity of soils. *Soil Sci. Soc. Am. J.*, 50, 887–891
- Pleysier JL, Jansens J and Cremers A (1986b) Extraction of cations from some kaolinitic soils of the tropics. ISRIC – *Proceedings of International Workshop on Laboratory Methods and Data Exchange Programme*, 51–65
- Ralchev T and Toncheva R (1997) Kinetics of the desorption of cations. I. A mathematical model testing. *Pochvoznanie, Agrokhimiya y Ekologiya.*, 32, 34–36
- Stucki JN, Golden DC and Roth CB (1984) Effects of reduction and reoxydation of structural iron on the surface charge and dissolution of dioctahedral smectites. *Clays Clay Miner.*, 32, 350–356
- Sumner ME and Miller WP (1996) Cation exchange capacity and exchange coefficients, (1996). In *Methods of Soil Analysis, part 3, Chemical Methods*, Bigham JM and Bartels JM ed. SSSA–ASA, Madison, WI Etats-Unis, 1201–1229
- Zhao BJ, Lam MT, Back MH, Gamble DS and Wang C (1997) Soil cation exchange capacity measurements using ultrafiltration techniques: comparison of different metal ions as substitutes. *Commun. Soil Sci. Plant Anal.*, 28, 161–171
- Zhi ZL, Rios A and Valcarel M (1994) Direct determination of the cation-exchange capacity of soils with automatic sample pretreatment in a flow system. *Anal. Chim. Acta.*, 298, 387–392

### Barium Method at soil pH

- Gillman GP, Bruce RC, Davey BG, Kimble JM, Searle PL and Skjemstad JO (1983) A comparison of methods used for the determination of cation exchange capacity. *Commun. Soil Sci. Plant Anal.*, 14, 1005–1014
- Hendershot WH and Duquette M (1986) A simple Barium chloride method for determining cation exchange capacity and exchangeable cations. *Soil Sci. Soc. Am. J.*, 50, 605–608
- Lambert K, Vanderdeelen J and Baert L (1988) An improved method for cation exchange capacity determination of peat soils. *Pédologie*, XXXVIII(1), 5–14
- Matsue N and Wada K (1985) A new equilibrium method for cation exchange capacity measurement. *Soil Sci. Soc. Am. J.*, 49, 574–578

**Buffered Method at pH 7.0**

- Arbelo CD and Hernandez-Moreno JM (1992) Cation exchange capacity of Andosols as determined by the ammonium acetate (pH7) method. Capacidad de cambio en Andosoles pro los metodos del acetato amonico (pH7) y cloruro de basio no tamponado. *Agrochimica*, 36: 1–2, 53–62
- Chapman HD (1965) Cation-exchange capacity. In *Methods of Soil Analysis. Part 2. Chemical and Microbiological Properties*, Black C.A. et al. ed. American Society of Agronomy, 9, 891–901
- FAO (1972) *Physical and Chemical Methods of Soil and Water Analysis.*, FAO Soils Bulletin no. 10
- Jackson ML (1958) *Soil Chemical Analysis.*, Prentice-Hall, New York
- Jaynes WF and Bigham JM (1986) Multiple cation-exchange capacity measurements on standard clays using a commercial mechanical extractor. *Clays Clay Miner.*, 1, 93–98
- Kalra YP and Maynard DG (1986) An evaluation of automated and manual methods for NH<sub>4</sub>-N analysis in the determination of cation exchange capacity of soils. In *Proceedings of International Workshop on the Laboratory Methods and Data Exchange Programme (Wageningen)*, Pleijssier LK ed. 67–76
- Kalra YP and Maynard DG (1990) An evaluation of a mechanical vacuum extractor for the determination of cation exchange capacity and extractable cations in calcareous soils. *Trans. 14th Int. Cong. Soil. Sci.*, Kyoto II, 451–452
- Kalra YP and Maynard DG (1991) Methods manual for forest soil and plant analysis. *Forêts Canada – Information Report NOR-X-319*, 84–94
- Kelley WP (1927) A general discussion of the chemical and physical properties of alkali soils. *1st Int. Congr. Soil Sci. Proc.*, 483–489
- Metson AT (1956) *Methods of Chemical Analysis for Soil Survey Samples.*, USDA – Soil Bureau, Bull. 12
- Peech M (1945) Determination of exchangeable cations and exchange capacity of soils. Rapid micromethods utilizing centrifuge and spectro photometer. *Soil Sci.*, 59, 25–38
- Schuman GE, Stanley MA and Knudsen D (1973) Automated total nitrogen analysis of soil and plant samples. *Soil Sci. Soc. Am. Proc.*, 37, 480–481
- Skjemstad JO and Reeve R (1976) The determination of nitrogen in soils by rapid high-temperature kjeldahl digestion and autoanalysis. *Commun. Soil Sci. Plant Anal.*, 7, 229–239
- TECHNICON (1973) *Method for NH<sub>4</sub>N 154-71 W (colorimetry).*, Technicon Instrument Corporation Industrial Methods
- USDA (1972) *Soil Survey Laboratory Methods and Procedures for Collecting Soil Samples.*, USDA – Soil survey investigations, report no. 1

**Cobaltihexamine CEC**

- Gautheyrou J and Gautheyrou M (1958) *Détermination des cations échangeables et de la CEC des sols à allophane développés sur cendres volcaniques récentes (soufrière de Guadeloupe) avec le chlorure de cobalti-hexamine.*, IRD (ex-Orstom), Guadeloupe, Paris, rapport multigraphié, 1–4
- Maes A, Tits J, Mermans G and Dierckx A (1992) Measurement of the potentially available charge and the dissociation behaviour of humic acid from cobalti-hexamine adsorption. *J. Soil Sci.*, 43, 669–677
- Ciesielski H and Sterckeman T (1997) Determination of cation exchange capacity and exchangeable cations in soils by means of cobalt hexamine trichloride. Effects of experimental conditions. *Agronomie*, 17: 1, 1–7

**Silver–Thiourea**

- Pleysier J (1976) *Silver uncharged ligand complexes in aluminosilicates: adsorption and stability.*, These Univ. Louvain
- Van Reeuwijk LP (1987) Procedures for soil analysis cation exchange capacity and exchangeable bases (silver-thiourea method). ISRIC, *International Soil Reference and Information Center, 2e edition*, 10-1 à 10-6

**CEC with organic cations (coloured reagents)**

- Brindley GW and Thompson TD (1970) Methylene blue adsorption by montmorillonite. Determination of surface areas and exchange capacities with different initial cation saturations. *Isr. J. Chem.*, 8, 409–415
- Cenens J and Schoonheydt RA (1988) Visible spectroscopy of methylene blue on hectorite, laponite B and barasym in aqueous suspension. *Clays Clay Miner.*, 36, 214–224
- Hang PT and Brindley GW (1970) Methylene blue absorption by clay minerals. Determination of surface areas and cation-exchange capacities (clay-organic studies XVII). *Clays Clay Miner.*, 18, 203–212
- Marguliers L, Rozen H and Nir S (1988) Model for competitive adsorption of organic cations on clays. *Clays Clay Miner.*, 36, 270–276
- Phelps GW and Harris DL (1967) Specific surface and dry strength by methylene blue adsorption. *Am. Ceram. Soc. Bull.*, 47, 1146–1150
- Santoni S, Bonifacio E and Zanini E (2001) Indophenol blue colorimetric method for measuring cation exchange capacity in sandy soils. *Commun. Soil Sci. Plant Anal.*, 32, 2519–2530

**Buffered methods pH 8.0–8.6**

Bower CA, ReiteMeier PF and Fireman M (1952) Exchangeable cation analysis of saline and alkali soils. *Soil Sci.*, 73, 251–261

**Barium chloride–Triethanolamine at pH 8.1**

Bradfields R and Allison WH (1933) Criteria of base saturation in soils. *Trans. 2d Comm. Int. Soil Sci.*, A, 63–79

Mehlich A (1938) Use of triethanolamine acetate–barium hydroxyde buffer for determination of some base exchange properties and lime requirement of soil. *Soil Sci. Soc. Am. Proc.*, 3, 162–166

Mehlich A (1953) Rapid determination of cation and anions exchange properties and pH<sub>0</sub> of soils. *J. Assoc. Agric. Chem.*, 36, 445–457

Peech M (1965) Exchange acidity. In *Methods of Soil Analysis* Black C.A. et al. part 2. *Am. Soc. Agronomy*, 9, 905–913

USDA (1972) *Soil Survey Laboratory Methods and Procedures for Collecting Soil Samples.*, USDA. Soil survey investigations report no. 1, p. 23

## Anion Exchange Capacity

### 27.1 Theory

Positive charges in the soil originate either from rupture of planes of the structural units and the resulting edge charges or of iron and aluminium oxides that cover some crystalline clays or occupy an interlayer position in lattice layers. These charges induce adsorption of anions (Zelazny et al. 1996).

Before 1975 anion exchange capacity (AEC) was rarely studied mainly because in the main soils in temperate zones the influence of anions is weaker than cations which link with negatively charged surfaces. This is particularly true for 2:1 clays whose zero point charge (ZPC, cf. Chap. 20) is badly defined, as the permanent negative charge is too great to be balanced by the less significant positive charges (Fig. 27.1) which appear at the edge of the rupture zones of the structural units, giving very high ratios of CEC to CEA (Bingham et al. 1965).

As the CEC is relatively low in 1:1 clays, the effects of the edge charges give low ratios of CEC to CEA, and the influence of AEC is consequently more significant, especially if the particles are small and display a significant level of disorder. These phenomena are significant in certain acid tropical soils including metallic oxides and organic anions (Theng 1979; Tate and Theng 1980; Eick et al. 1999). In spodosols, ultisols, oxisols and andosols, the values can vary from 1 to 10 mmol kg<sup>-1</sup> with ratios of CEC to CEA  $\leq 1$ . In andosols, allophane-imogolite and organic matter content can drastically modify exchange properties. The development of positive charges at the soil pH is high in these soils which have a ratio of silica to alumina of near one (Wada and Okamura 1977, 1980; Okamura and Wada 1978; Cruz Huerta and Kientz 2000).

On the other hand, if these soils contain aluminium–humus complexes, the positive charges are weak, and this makes it possible to differentiate Al–OH complexes in humus and in the mineral fraction (organic matter has a low pH<sub>0</sub> which lowers the soil pH<sub>0</sub> when it fixes large organic anions).

There is significant adsorption of phosphorous in andosols that involves exchange mechanisms as well as structural displacements (Rajan 1975; Parfitt and Henmi 1980).

**Fig. 27.1.** Dependence on pH of the surface charges on allophane and montmorillonite (Clark and McBride 1984; McBride 1989; ZPC, zero point charge; AEC, anion exchange capacity, CEC, cation exchange capacity)

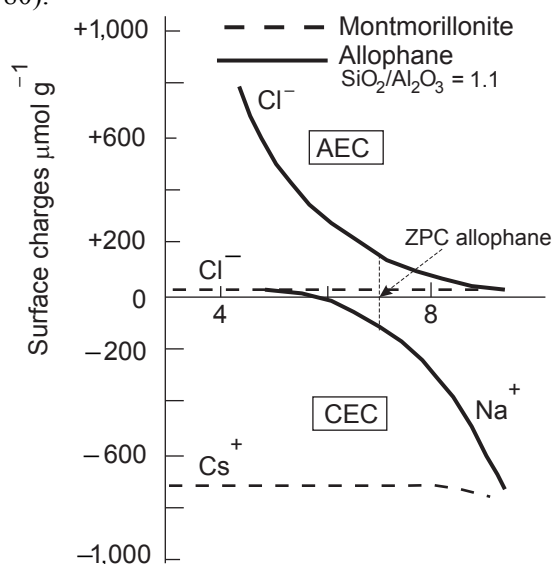

The polymers of iron oxides and aluminium hydroxides induce a strong AEC (Schwertmann and Taylor 1989).

In strongly weathered soils, the AEC values can be higher than the CEC values; for example when the method of Gillmann (1979) is used, acrohumox can have a CEC of  $0.6 \text{ cmol (+) kg}^{-1}$  and an AEC of  $3.7 \text{ cmol (-) kg}^{-1}$ .

The AEC was long considered to be a less important measurement than the CEC because the different anions involved in these exchanges are seldom retained by simple electrostatic bonds, but only by more complex strengths. Without selective fixation, only the exchange of  $\text{Cl}^-$ ,  $\text{NO}_3^-$  and  $\text{ClO}_4^-$  anions is possible; the exchange of one anion with another anion of similar ionic force does not modify the electrophoretic mobility of the particles. There is no change in specificity related to the size of the anion and probably not to phenomena of steric impossibility (Schwertmann and Taylor 1989).

Other anions can be more strongly retained on the oxide surfaces by coordination bonds or chemisorption (e.g. different silicates, molybdates, arsenates, selenates, organic anions). Acetate is adsorbed by coulombic interaction, whereas citrate, which forms ligands with aluminium, is strongly retained. The behaviour of the anions can be defined by the adsorption model of Bowden et al. (1980).



In the case of polyanions, whose economic repercussions in agronomy are considerable (e.g.  $\text{PO}_4^{3-}$ ,  $\text{SO}_4^{2-}$ ), the AEC cannot account for exchangeable forms. Indeed, in addition to the exchange phenomena, other phenomena like precipitation of insoluble salts with iron, aluminium or alkaline-earth elements also have to be considered. Phosphate retention can be empirically divided into two fractions:

- A labile fraction which is extractable in different acid or basic reagents using many different methods. This labile fraction is often wrongly named “plant available phosphorus” or “easily available phosphorus” or “extractable phosphorus” (cf. Chap. 29).
- A fraction which is fixed by different mechanisms, in particular by precipitation or inclusion in complexes and can be quantified by differential analysis in a saturating medium containing an excess of phosphorus using retention methods (cf. Sect. 29.4 in Chap. 29).

Soils with variable charges that are rich in aluminium and iron oxides, and have a soil  $\text{pH} < \text{pH} 0$  (i.e. more acid than the equilibrium  $\text{pH}$  where positive and negative charges are in equal quantities, cf. Chap. 20), have a positively charged surface. As iron and aluminium hydroxides have high  $\text{pH}_0$  values of around  $\text{pH} 7\text{--}8$ , the soils in which these hydroxides are predominant have a strong AEC.

The specific fixation of anions such as fluoride can also result in considerable release of  $\text{OH}^-$  which makes it possible to test the soils containing active aluminium forms (allophanic soils, soils containing organometallic aluminium–humus complexes) using the NaF test (Kawaguchi et al. 1954; Fieldes and Perrott 1966; USDA 1975; Shoji and Ono 1978; Parfitt and Henmi 1980; Pansu et al. 2001).

Saturation of the positive charges of the exchange complex by  $\text{PO}_4^{3-}$  ions can have an indirect effect by increasing the CEC of allophanic soils as reported by many authors (Mekarus and Uehara 1972; Schalscha et al. 1972, 1974; Juo and Madukar 1972; Sawhney 1974; Rajan 1976; Ryden and Syrs 1975, 1976; Parfitt and Atkinson 1976; Galindo and Bingham 1977; Garcia-Miragaya 1984). The replacement of the water molecule bound to a metal by phosphate leads to a reduction in the positive charge and thus to an increase in the net negative charge. Additional negative charges can be created in anthropic mediums by addition of phosphate-enriched fertilizers. In the field, the reactions are slow and continuous, and phosphorous mobility is low (Fig. 27.2). The structure of the bonds at the colloid surfaces is not yet well known, in particular for aluminium, iron or manganese oxides and amorphous substances. Mono or binuclear complexes can be formed with iron (Fig. 27.3; Schwertmann and Taylor 1989). The exchange capacity can be modified at the water–colloid interface (Charlet and Schlegel 1999), in particular under the effect of waterlogging (Triana et al. 1995).

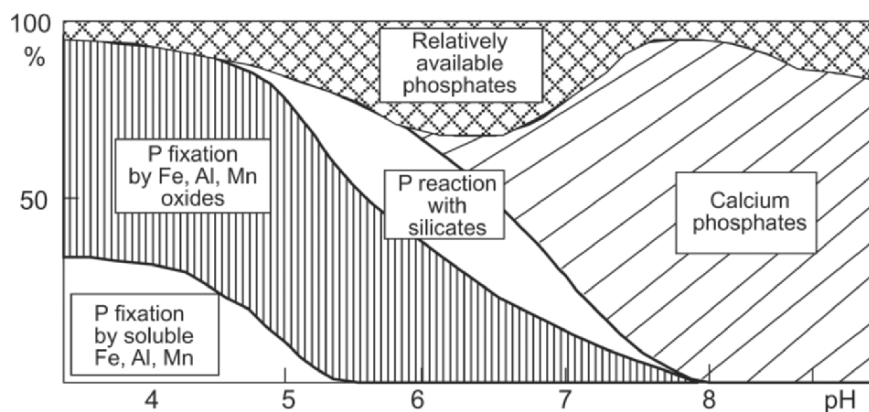

**Fig. 27.2.** Soil fixation and phosphate availability for plants as a function of the soil pH (after Brady 1974)

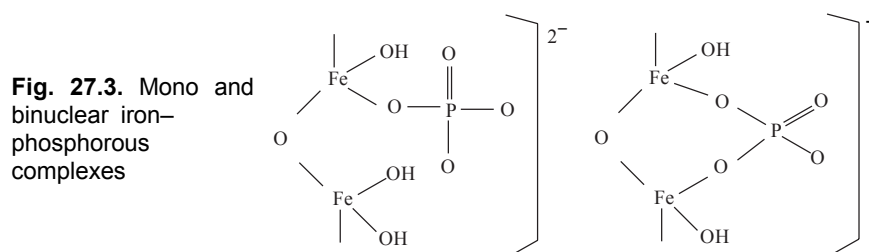

When there is no precipitation of insoluble salts, the lyotropic series of the most current anions in agronomy is (Bolt and De Hann 1982):

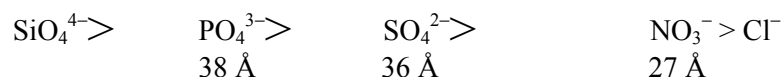

Figure 27.4 shows adsorption of the fluoride, silicate and phosphate anions on goethite as a function of pH.

## 27.2 Measurement

### 27.2.1 Principle

Methods for the measurement of the AEC are based on the same principles as the CEC and are subject to the same constraints. Only the

valence signs have to be reversed. If the surface is positively charged, any anion excess maintained by electrostatic links in the double layer is exchangeable. The AEC is the maximum quantity of anion likely to be linked per unit of soil weight.

**Fig. 27.4.** Sorption of the phosphate, silicate and fluoride anions on goethite (after Hingston et al. 1972)

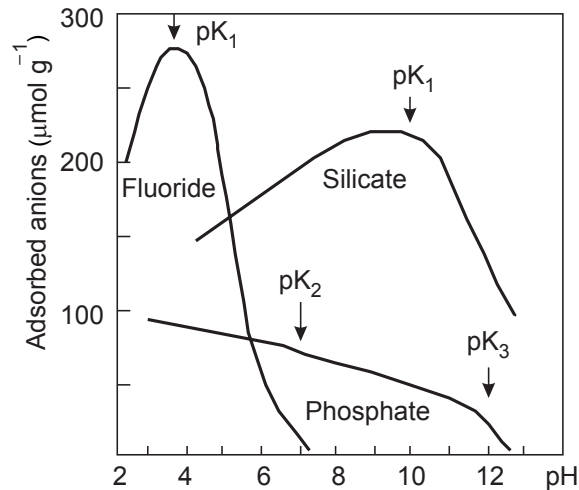

The anion exchange complex is saturated by a counter-anion that is not specifically fixed under suitable conditions of pH and ionic strength (generally chloride or nitrate anions, as nitrate cannot be used in the presence of marked redox phenomena). The anion excess is then eliminated, the fixed counter-anion is moved by another counter-anion and measured in moles of adsorbed anion per mass unit.

Similar rules to those for the determination of the CEC must be respected: the ratio of the pH concentration of solutions to sorbed quantities, the need for iterative additions to lower the buffering capacity and to move the equilibria, the influence of contact times and of temperature which affects reaction kinetics towards equilibrium.

As the AEC is concerned with ions that can be easily moved, polyvalent anions like sulphate and phosphate cannot be used because of their specific adsorption (coordination) and because of precipitation of insoluble salts with the exchangeable cations of the medium. The AEC generally accounts for 1–5% of the CEC (Bolt and de Haan, 1982).

The method described below was proposed by Wada and Okamura (1977).

### 27.2.2 Method

#### Reagents

- 1 mol L<sup>-1</sup> ammonium chloride solution (NH<sub>4</sub>Cl, mw = 53.50).
- 0.1 mol L<sup>-1</sup> ammonium chloride solution.
- 1 mol L<sup>-1</sup> potassium nitrate solution (KNO<sub>3</sub>, mw = 101.10).

#### Procedure

- Measure the moisture content of the sample to bring back the results to soil dried at 105°C.
- Weigh 0.5 g of soil ground to 0.5 mm in a previously tared centrifugation tube.
- Add 10 mL of the 1 mol (NH<sub>4</sub>Cl) L<sup>-1</sup> saturation solution (the pH of this solution should be around 6.0).
- Shake for 30 min; centrifuge at 5,000g and discard the supernatant.
- Suspend the centrifugation pellet five times in 10 mL of the 0.1 mol (NH<sub>4</sub>Cl) L<sup>-1</sup> solution centrifuging between each treatment.
- Weigh the tube containing the centrifugation pellet of Cl<sup>-</sup> saturated soil in order to quantify the quantity of 0.1 mol (NH<sub>4</sub>Cl) L<sup>-1</sup> solution retained: rC in cmol (-) kg<sup>-1</sup> (soil).
- Move the Cl<sup>-</sup> ion by five additions of 10 mL of 1 mol (KNO<sub>3</sub>) L<sup>-1</sup> solution centrifuging between each treatment; mix the extracts and bring to 50 mL, this is total Cl<sup>-</sup>.
- Titrate Cl<sup>-</sup> in the extract by spectrophotometry; tC is expressed in cmol (-) kg<sup>-1</sup> (soil).

The AEC is expressed in cmol (-) kg<sup>-1</sup> (soil) by tC– rC.

### 27.3 Simultaneous Measurement of AEC, EC, CEC and net CEC

#### 27.3.1 Aim

Many analytical methods have been tested with the aim of simultaneously characterizing the potential and charge of the soil which are the cause of the exchange phenomena in strongly weathered soils. Not-buffered and very dilute mediums were used to try to approach field conditions (pH and ionic strength of the soil solution).

The use of  $\text{Ba}^{2+}$  barium cation and its salts was included in many methods (e.g. Bascomb 1964; Gillman 1979; Gillman and Bakker 1979; Uehara and Gillman 1981; Gillman and Sumpter 1986).

Unfortunately  $\text{Ba}^{2+}$  cannot be used with anions like sulphate which is often present in allophanic soils or is used to correct soil deficiencies and the effects of aluminic acidity in strongly weathered soils (e.g. superphosphate fertilizer or calcium sulphate amendments). Other anions like chloride and nitrate were consequently tested as they are not very abundant in the exchange complex and not likely to be bonded by selective adsorption. The simplicity of the titrations and their low cost means they can be used for routine analysis with a satisfactory degree of reproducibility.

### 27.3.2 Description

#### **Principle**

The method described here (Cochrane and De Souza 1985) concerns strongly weathered soils with variable charges. The soil sample is equilibrated with a diluted saturation solution of a counter-cation and a counter-anion with an ionic strength close to that of the soil solution. The fixed cation and anion are then moved by other counter-ions and titrated for the calculation of CEC and AEC with correction for weight. The net CEC is obtained by difference.

#### **Reagents**

– *Ionic saturation.* 0.5 mol L<sup>-1</sup> ammonium nitrate solution ( $\text{NH}_4\text{NO}_3$ , mw = 80.05): weigh 40.02 g of  $\text{NH}_4\text{NO}_3$  and dissolve in about 900 mL of deionized water, complete to 1 L.

– *Ionic strength equilibration.* 0.0215 mol L<sup>-1</sup> ammonium nitrate solution: weigh 1.721 g of  $\text{NH}_4\text{NO}_3$  and dissolve in 1 L of deionized water.

– *Displacement of the counter-ion.* 0.02 mol L<sup>-1</sup> potassium chloride solution (KCl, mw = 74.55): weigh 1.491 g of KCl and dissolve in about 900 mL of deionized water; complete to 1,000 mL after equilibration of the temperature.

## **Procedure**

### **Extractions**

- Weigh 3 g of soil sieved to 0.5 mm and put in a previously tared 50 mL centrifugation tube with a screw cap.
- Add 30 mL of 0.5 mol (NH<sub>4</sub>NO<sub>3</sub>) L<sup>-1</sup> solution.
- Shake for 2 h and centrifuge at 6,000g.
- Decant the supernatant: this is solution A.
- Suspend the soil residue in 30 mL of 0.0215 mol (NH<sub>4</sub>NO<sub>3</sub>) L<sup>-1</sup> solution which roughly represents the value of the osmotic potential of the soil solution (this concentration can be adjusted to fit a particular case).
- Shake for 60 min.
- Centrifuge at 6,000g.
- Discard the supernatant; repeat this equilibration twice.
- Weigh the tube + the soil centrifugation pellet to calculate the quantity of 0.0215 mol (NH<sub>4</sub>NO<sub>3</sub>) L<sup>-1</sup> solution retained, rA is the ammonium (or nitrate) retained expressed in cmol kg<sup>-1</sup> (soil).
- Add 30 mL of the 0.02 mol (KCl) L<sup>-1</sup> displacement solution (which has an osmotic potential similar to the 0.0215 mol (NH<sub>4</sub>NO<sub>3</sub>) L<sup>-1</sup> solution).
- Suspend and shake for 60 min.
- Centrifuge at 6,000g.
- Reserve the supernatant containing exchanged ammonium and nitrate ions.
- Repeat this treatment twice and mix the three extracts.
- Bring to 100 mL with 0.02 mol (KCl) L<sup>-1</sup> solution: this is solution B.

### **Determination of the CEC and the AEC**

- On solution B, titrate total ammonium (cf. Chap. 28 or use the method of Bremner and Keeney 1966) which includes exchangeable ammonium and ammonium resulting from the 0.0215 mol (NH<sub>4</sub>NO<sub>3</sub>) L<sup>-1</sup> solution (titration is generally carried out by automated colorimetry or micro distillation and volumetry): this is tA.  
Calculate the CEC by the exchanged ammonium (cf. Chap. 26) express the results in cmol (+) kg<sup>-1</sup> (soil):  
CEC = tA – rA.
- Titrate total nitrate (cf. Chap. 28) which includes exchangeable nitrate and nitrate resulting from the 0.0215 mol (NH<sub>4</sub>NO<sub>3</sub>) L<sup>-1</sup> solution: this is tN.  
Calculate the AEC by exchanged nitrates, the results are expressed in cmol (-) kg<sup>-1</sup> by:  
AEC = tN – rA;

– The net CEC is obtained by:

$$\text{Net CEC} = \text{CEC} - \text{AEC}$$

If titration cannot be performed the same day as extraction, add two drops of toluene to prevent biochemical evolution and store the extracts in the refrigerator protected from the light.

### *Determination of Exchangeable Cations*

On solution A, measure the pH and titrate Ca, Mg, K, Na, Fe, Mn, Al by atomic absorption or inductively coupled plasma spectrometry, measure sulphate and chloride by absorption spectrometry (cf. Chap. 31 or Pansu et al. 2001):

$$\text{Ca} + \text{Mg} + \text{K} + \text{Na} = \text{EC (exchangeable cations)}$$

$$\text{Al} + \text{Fe} + \text{Mn} \cong \text{EA (exchangeable acidity)}$$

$$\text{EC} + \text{EA} = \text{effective CEC by summation.}$$

Excess of chloride or sulphate indicates that the soil contains probably soluble salts or gypsum.

## References

- Bascomb CL (1964) Rapid method for the determination of cation-exchange capacity of calcareous and non-calcareous soils. *J. Sci. Food Agric.*, 15, 821–823
- Bingham FT, Sims JR and Page AL (1965) Retention of acetate by montmorillonite. *Soil Sci. Soc. Am. J.*, 29, 670–672
- Bolt GH and De Haan FAM (1982) Anion exclusion in soil. In *Soil Chemistry, B – Physico Chemical Models*, Bolt GH ed. Elsevier Amsterdam, Development in Soil Sciences, 5 B, 233–257
- Bowden JW, Nagarajah S, Barrow NJ, Posner A and Quirk JP (1980) Describing the adsorption of phosphate, citrate and selenite on a variable charge mineral surface. *Aust. J. Soil Res.*, 18, 49–60
- Brady NC (1974) *The Nature and Properties of Soils.*, MacMillan New York, 8th edition
- Bremner JM and Keeney DR (1966) Determination and isotope ratio analysis of different forms of nitrogen in soils: 3-exchangeable ammonium, nitrate and nitrite by extraction-distillation methods. *Soil Sci. Soc. Am. Proc.*, 30, 577–583
- Charlet L and Schlegel ML (1999) La capacité d'échange des sols. Structures et charges à l'interface eau/particule. *Comptes-Rendus-de-l'Academie-d'Agriculture-de-France*, 85, 7–24
- Clark CJ and McBride MB (1984) Cation and anion retention by natural and synthetic allophane and imogolite. *Clays Clay Miner.*, 32, 291–299
- Cochrane TT and Desouza GDM (1985) Measuring surface charge characteristics in oxisols and ultisols. *Soil Sci.*, 140, 223–229

- Fieldes M and Perrott KW (1966) The nature of allophane in soils. Part 3, Rapid field and laboratory test for allophane. *N. Z. J. Sci.*, 9, 623–629
- Galindo GG and Bingham FT (1977) Homovalent and heterovalent cation exchange equilibria in soils with variable surface charge. *Soil Sci. Soc. Am. J.*, 41, 883–886
- Garcia-Miragaya J (1984) Effect of phosphate sorption of the cation exchange capacity of two Savannah ultisols from Venezuela. *Commun. Soil Sci. Plant Anal.*, 15, 935–943
- Cruz Huerta L and Kientz DG (2000) Electric charge of andosols of ‘Cofre de Perote’, Veracruz, Mexico Carga electrica de los andosoles del Cofre de Perote, Veracruz, Mexico. *Terra*, 18, 115–124
- Eick MJ, Brady WD and Lynch CK (1999) Charge properties and nitrate adsorption of some acid southeastern soils. *J. of Environ. Quality*, 28, 138–144
- Gillman GP and Bakker P (1979) *The Compulsive Exchange Method for Measuring Surface Charge Characteristics of Soil.*, CSIRO-Division of Soils, Report 40
- Gillman GP and Sumpter EA (1986) Modifications to the compulsive exchange method for measuring exchange characteristics of soils. *Aust. J. Soil Res.*, 24, 61–66
- Gillman GP (1979) A proposed method for the measurement of exchange properties of highly weathered soils. *Aust. J. Soil Res.*, 17, 129–139
- Hingston FJ, Posner AM and Quirk JM (1972) Anion adsorption by goethite and gibbsite. 1) The role of the proton in determining adsorption envelopes. *J. Soil Sci.*, 23, 177–192
- Juo ASR and Madukar HP (1974) Phosphate sorption of some nigerian soils and its effect on cation exchange capacity. *Commun. Soil Sci. Plant Anal.*, 5, 479–497
- Kawaguchi KH, Fukutani H, Murakami H and Hattori T (1954) Ascension of pH values of ventral NaF extracts of allitic soils and semi quantitative determination of active alumina by the titration method. *Bull. Res. Inst. Food Sci.*, (Kyoto University, Japan), 14, 82–91
- McBride MB (1989) Surface chemistry of soil minerals. In *Minerals in Soil Environments*, Dixon JB and Weed SB ed. Soil Science Society of America, 2, 35–88
- Mekarus T and Uehara G (1972) Anion adsorption in ferruginous tropical soils. *Soil Sci. Soc. Am. Proc.*, 36, 296–300
- Okamura Y and Wada K (1978) Charge characteristics of Kuroboku soils : effect of pH and ion concentration. *Soil Sci. Soil Manure* (Japan), 24, 32
- Pansu M, Gautheyrou J and Loyer JY (2001) *Soil Analysis – Sampling, Instrumentation and Quality Control.*, Balkema, Lisse, Abington, Exton, Tokyo, 489 p
- Parfitt RL and Atkinson RJ (1976) Phosphate adsorption of goethite ( $\alpha$ -FeOOH). *Nature*, 264, 740–742
- Parfitt RL and Henmi T (1980) Structure of some allophanes from New Zealand. *Clays Clay Miner.*, 28, 285–294



- Rajan SSS (1975) Mechanism of phosphate adsorption by allophanic clays. *N. Z. J. Sci.*, 18, 93–101
- Rajan SSS (1976) Changes in net surface charge of hydrous alumina with phosphate adsorption. *Nature*, 262, 45–46
- Ryden JC and Syers JK (1975) Charge relationships of phosphate sorption. *Nature*, 255, 51–53
- Ryden JC and Syers JK (1976) Calcium retention in response to phosphate sorption by soils. *Soil Sci. Soc. Am. J.*, 40, 845–846
- Sawhney BL (1974) Charge characteristics of soils as affected by phosphate sorption. *Soil Sci. Soc. Am. Proc.*, 38, 159–160
- Schalscha EB, Pratt PF and Soto D (1974) Effect of phosphate adsorption on the cation-exchange capacity of volcanic ash soils. *Soil Sci. Soc. Am. Proc.*, 38, 539–540
- Schalscha EB, Pratt PF, Kinjo T and Amar JA (1972) Effect of phosphate salts as saturation solutions in cation-exchange capacity determinations. *Soil Sci. Soc. Am. Proc.*, 39, 912–914
- Schwertmann U and Taylor RM (1989) Iron hydroxydes. In *Minerals in Soil Environments*, Dixon JB and Weed SB ed. Soil Science Society of America, 8, 379–438
- Shoji S and Ono T (1978) Physical and chemical properties and clay mineralogy of andosols from Kitakami (Japan). *Japan Soil Sci.*, 126, 297–312
- Tate KR and Theng BKG (1980) In *Soils with Variable Charge. Organic Matter and its Interactions with Inorganic Soil Constituents*, Theng BKG ed. New Zealand Society of Soil Science, 225–249
- Theng BKG (1979) *Formation and Properties of Clay-Polymer Complexes.*, Elsevier Amsterdam, 362 pages
- Triana A, Lefroy RDB, Blair GJ, Date RA ed. Grundon NJ ed. Rayment GE ed. and Probert ME (1995) The effect of flooding on S sorption capacity and AEC of variable charge soils. In *Proceedings of the Third International Symposium, Brisbane, Queensland, Australia, 12–16 September 1993*, Kluwer Dordrecht, 135–139
- Uehara G and Gillman G (1981) *The Mineralogy Chemistry and Physics of Tropical Soils with Variable Charge Clays.*, Westview Tropical Agriculture Series, 4, 170 pages
- USDA (1975) *Soil Survey Staff., A Basic System for Making and Interpreting Soil Surveys.*, USDA Handbook, 436 p
- Wada K and Okamura Y (1977) Measurements of exchange capacities and hydrolysis as means of characterizing cation and anion retention by soils. Proceedings of the International Seminar on Soil Environment and Fertility Management in Intensive Agriculture. *Soc. Sci. Soil Manure* (Japan), 811–815
- Wada K and Okamura Y (1980) Electric charge characteristics of ando A<sub>1</sub> and buried A<sub>1</sub> horizon soils. *J. Soil Sci.*, 31, 307–314

---

Zelazny LW, Liming HE and An Vanwormhoudt M (1996) Charge analysis of soils and anion exchange. In *Methods of Soil Analysis, Part 3, Chemical Methods*, Bigham JM and Bartels JM ed. SSSA-ASA, Madison, WI Etats-Unis, 1231–1253

## Inorganic forms of nitrogen

### 28.1 Introduction

#### 28.1.1 Ammonium, Nitrate and Nitrite

The degradation of nitrogenous organic matter results in ammonia salts, which oxidize into nitrites and nitrates under the influence of nitrifying bacteria. Nitrate anion is found in drainage water, spring waters and rivers after leaching by irrigation or rainwater. In tropical areas where thunderstorms are frequent, rainwater can contribute some nitrates which result from direct synthesis starting from atmospheric nitrogen.

In the soil, ammonia salts are partly adsorbed on the exchange complex and are not directly extractable with water, in contrast to nitrates which are very soluble. Extraction of exchangeable ammonium thus requires displacement by exchange with another cation of a saline solution. Moreover, part of ammonium can be fixed in the clay layers thereby becoming inaccessible for exchange.

Nitrate anion is considered to be a health risk at a concentration of 80 mg L<sup>-1</sup> in water. WHO<sup>1</sup> standards recommend maximum values of 44 mg L<sup>-1</sup> for adults and 20 mg L<sup>-1</sup> for children. The massive presence of nitrates is often a sign of pollution. In lakes, they contribute to eutrophication phenomena. Nitrates can be reduced to nitrites by denitrifying germs.

Nitrite anion is not stable in natural water. When its presence is observed in water, it is a sign of pollution and the water probably has a nitrite content of more than 0.1 mg L<sup>-1</sup>. The sterilization of water by chloramines generates ammonia transformed into nitrite by bacteria.

---

<sup>1</sup>WHO: World Health Organization.

### 28.1.2 Sampling Problems

The distribution of ammonia, nitrate and nitrite varies considerably in the soil. Differences of up to 40% have been found between samples taken from an area of only 2 ha. Sampling should thus be undertaken with great care for this type of analysis.

For the results to be accurate, it is essential to use a strict procedure for both field sampling and for the preparation of the samples, and all operations should be perfectly standardized. It is better to use the sampling device designed by Guiot (1975) than a helical auger. The Guiot probe resembles a semi-cylindrical auger and allows samples to be taken at a precise soil depth and, in addition, the soil samples are less disturbed than with the other devices.

The samples should be prepared immediately in their wet state and stored at less than 10°C for not more than 3 days. Alternatively, extraction can be performed in the field and the solutions brought back to the laboratory. In addition, one aliquot of each sample should be dried in the drying oven at 105°C to identify the corrective coefficient factor for the results. Soil sampling and sample storage for the determination of inorganic nitrogen on fresh soil are the subject of the standard XP X31-115 (1995). If possible, measurements should be taken in situ.

### 28.1.3 Analytical Problems

The extracts can be unstable but can be stabilized by adding 1 mL of a saturated solution of mercurous chloride per 100 mL, particularly if nitrite titration is required.

The extraction medium inevitably contains many awkward ions at unknown concentrations and may also be coloured or turbid. These phenomena can make precise colorimetric titration difficult, if not impossible.

The classical method of titration of ammonia salts by distillation in alkaline medium involves the risk of neo-formation of ammonia starting from soluble nitrogenous organic matter, even when working under vacuum.

Consequently it is often preferable to first separate the inorganic nitrogen form to be titrated. Separation by micro-diffusion of ammonium (cf. Sect. 28.2.2) is suitable for trace titration and is easy to implement. After separation, ammonium can be titrated without interference.

## 28.2. Usual Methods

### 28.2.1 Extraction of Exchangeable Forms

Simple extraction with water is theoretically appropriate for nitrates that are very soluble, but in this case the extraction of other forms of inorganic N is not complete, particularly ammonium adsorbed on the exchange complex. Consequently, salt solutions should be used for extraction. The most widely used is  $1 \text{ mol L}^{-1}$  potassium chloride solution. However, in soils containing gypsum, the solubility of calcium sulphate can cause errors during titration particularly by colorimetry. The use of a  $0.5 \text{ mol L}^{-1}$  potassium sulphate solution enables solubility of calcium sulphate to be reduced with the same efficiency as potassium chloride for the extraction of the ammonium ion.

#### *Equipment and Reagents*

- 500 mL bottles with stopper
- Rotary agitator,  $30 \text{ rotations min}^{-1}$
- *Extraction solution.*  $0.5 \text{ mol (K}_2\text{SO}_4) \text{ L}^{-1}$  potassium sulphate solution

#### *Procedure*

- Place 50 g of soil, (see preparation in Sect. 28.1.2) in the 500 mL bottles with 100 mL of extraction solution.
- Shake the stopped bottles for 1 h on the rotary agitator; decant until a clear supernatant solution is obtained; if the solution is not clear, filter or centrifuge.
- The filtrate is used for the titration of exchangeable ammonium, nitrite and nitrate. If titration cannot be performed immediately, store the solutions at  $4^\circ\text{C}$  protected from the light.

#### *Note*

Fifty grams is the recommended weight of a sample specimen of soil for soils low in nitrogen (tropical soils). For richer soils, the sample weight can be lower. Keeney and Nelson (1982) and Mulvaney (1996) proposed 10 g of soil for the same 100 mL volume of extraction solution.

## 28.2.2 Separation by Micro-diffusion

### **Principle**

This method was discovered and used by Schloesing in 1851 and by Fresenius in 1889, and was codified by Conway in 1962. It is recommended for soil analysis because of its simplicity and precision particularly on coloured and turbid extracts (Mulvaney 1996; Mulvaney et al. 1997; Mulvaney and Khan 1999; Khan et al. 2000).

It has been demonstrated that at room temperature, a slightly alkaline solution containing ammonium ions with a large surface area and a low thickness, can lose all its ammonium as gaseous ammonia. The method consists in selectively moving the molecules concerned from a solution where their vapour pressure is high to a solution where their vapour pressure is nil.

The inorganic forms of nitrogen have to be transformed into the removable volatile form of ammonia. For ammonium ions, simple alkalization of the medium is sufficient. Nitrates and nitrites must first be transformed into ammonium ions by reduction with Dewarda mixture.

The displaced ammonia can be collected in a boric acid solution containing an indicator and titrated with a 0.01 mol L<sup>-1</sup> sulphuric acid solution in a technique similar to the titration of total nitrogen (cf. "Procedure (Macro-Method)" in Chap. 10) and of organic forms of nitrogen (cf. Sect. 14.2.1 in Chap. 14). But as the rate of inorganic forms of N is often low, it is better to use the technique described below based on highly sensitive colorimetric titration.

### **Equipment**

The equipment required is simple; it was inspired by the Conway technique and adapted for soil analysis by Blachère and Ferry (1957). The device described below enables serial analyses (Susini and Gandjui 1964).

Wide mouth 500 mL Erlenmeyer flasks are used; they should have rubber stopper intersected by a glass tube with a diameter of 10 mm ending in a hollow glass bulb approximately 20 mm in diameter. When the stopper is in place, the glass bulb should be suspended half way from the bottom of the flask (see Fig. 28.1).

### **Reagents**

– *Normal solution of sulphuric acid.* Put 2.7 mL of concentrated sulphuric acid in 100 mL of distilled water; this solution is used to impregnate the glass bulbs.

- Saturated solution of potassium carbonate (approximately 112 g for 100 mL at 20°C).
- *Conway solution*. One part of 40% caustic soda solution and three parts of saturated potassium carbonate solution.
- Dewarda mixture in powder form (50% aluminium powder, 45% copper powder and 5% zinc powder), 1 g of this mixture can release approximately 50 mL of nascent hydrogen.
- *Sulphamic acid* ( $NH_2SO_3H$ ). Put 2 g in 100 mL water; store in the refrigerator and prepare just before each analysis series to limit hydrolysis.

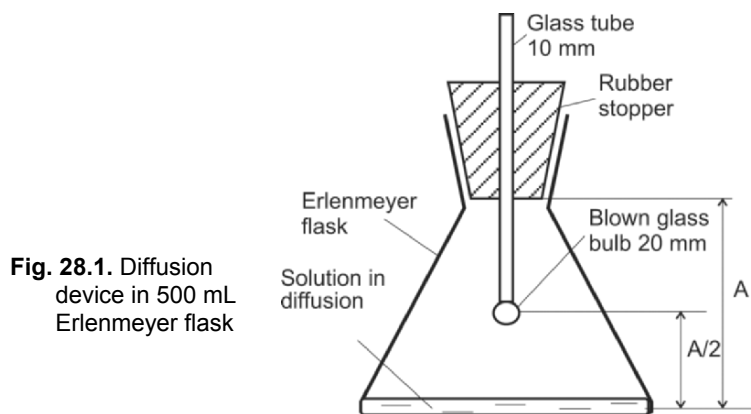

**Fig. 28.1.** Diffusion device in 500 mL Erlenmeyer flask

### **Procedure (Ammonium, Nitrate + Nitrite)**

Put exactly 20 mL of the extract obtained in “Procedure” under Sect. 28.2.1 into a 500 mL Erlenmeyer flask (Fig. 28.1). It is a good idea to prepare series of ten flasks at a time. Start by soaking the glass bulb in the N sulphuric acid solution. Wet carefully with the liquid, withdraw and drain off excess. Put 1.5 mL of saturated potassium carbonate solution into each flask; insert the stopper with the glass bulb. Make sure the flask is well stoppered. Let stand at room temperature for 48 h.

After this period, carefully open the flask taking care not to touch the walls with the glass bulb and not to lose a drop of liquid impregnating the ball. Hold the glass bulb over the funnel (cf. Fig. 28.2) and rinse the bulb with a little distilled water, allowing the rinsing water to collect in a 20 mL volumetric flask. Complete to 20 mL with distilled water, stop and leave to stand until titration. Add 40–50 mg of Dewarda mixture in powder form to the Erlenmeyer flask containing the extraction residue.

As before, soak the glass bulb in the sulphuric acid solution. Add 4.5 mL of Conway mixture in the Erlenmeyer flask; stop the flask immediately and continue as before. This time the displaced ammonium corresponds to nitrates and nitrites reduced by the Dewarda mixture.

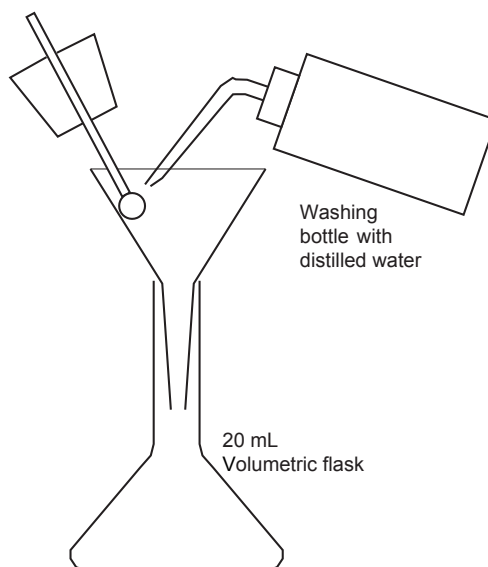

**Fig. 28.2.** Recovery of the displaced ammonium (Fig. 1)

#### *Note*

The Dewarda mixture can result in the release of hydrogen creating a slight overpressure which may eject the stopper; care should be taken to ensure the stopper is really secure or weighed down.

#### ***Destruction and Estimation of Nitrites***

The term “nitrates” is often used for the sum of nitrates + nitrites; both react to treatment with Dewarda mixture in the same way. As nitrites are particularly unstable, they may be thought to make a negligible concentration in comparison to nitrates, but this is not always the case and it may be necessary to titrate the nitrites separately.

It is also possible to destroy the nitrite before titration of nitrate. Acidification of the extract at pH 1 plus contact with the air for 1 h is sufficient to destroy nitrite. Another technique is to add 0.2 mL of sulphamic acid solution, agitate and wait 5 min before starting micro-diffusion. The combination of the procedures with and without nitrite destruction makes it possible to estimate nitrite by difference.



### 28.2.3 Colorimetric Titration of Ammonium

#### **Principle**

This colorimetric method is suitable for micro-determination. In alkaline medium and in the presence of hypochlorite and with phenol, ammonia gives a blue colour due to the formation of indophenol. This titration is a reference method. If it is carried out on ammonia separated by micro-diffusion (cf. Sect. 28.2.2), no interference will occur. This method enables measurement of:

- Ammonium on the extract of the first micro-diffusion
- the sum of nitrites + nitrates on the second micro-diffusion in the presence of Dewarda mixture
- nitrates alone if nitrites have been eliminated beforehand (cf. “Destruction and Estimation of Nitrites”)

Ammonium can also be titrated directly on the extraction solution (cf. Sect. 28.2.1) in a concentration range of 0.005–20 mg L<sup>-1</sup> (Keeney and Nelson 1982) but with the risk of additional error due to interference by calcium and magnesium. These interferences can be reduced by using a very diluted medium and by adding EDTA.

Colorimetric titration of ammonium can also be automated as described in Chap. 10 (“Procedure” under Sect. 10.2.7) and Chap. 26 (“Procedure” under Sect. 26.4.2).

#### **Equipment and Reagents**

Colorimetry is carried out in monochromatic radiation. Choose the wavelength that gives the strongest absorption (636 nm according to Keeney and Nelson 1982) in the 590–650 nm zone (orange). A colorimetric cell of 20 mm optical course provides good sensitivity. Values from 0.05 to 0.3 mg (N) L<sup>-1</sup> display a linear response.

#### **Reagents for the Colorimetric Reaction**

- *Sodium phenolate solution.* Dissolve 2.5 g of caustic soda in approximately 40–50 mL of distilled water; let cool, add 5 g of very pure phenol, dissolve and bring to 100 mL; this solution must be perfectly colourless.
- *0.2 mol (Na<sub>2</sub>HPO<sub>4</sub>) L<sup>-1</sup> disodic phosphate solution.* Add 71.65 g of Na<sub>2</sub>HPO<sub>4</sub>·12H<sub>2</sub>O in 1 L of deionized water.
- 0.05% sodium nitroprussiate solution prepared just before use, starting from a 1% stock solution.

– Sodium hypochlorite solution at four chlorometric degrees, starting from a commercial solution at 20–22°. The exact titre of commercial solutions should be checked in the following way: take 1 mL of commercial solution, add 50 mL of distilled water, a few potassium iodide crystals and 5 mL of pure acetic acid; shake the mixture and titrate (until disappearance of the yellow colour due to the released iodine) with a sodium hyposulphite solution containing 24.8 g of  $\text{Na}_2\text{S}_2\text{O}_3 \cdot 5\text{H}_2\text{O}$  per litre (0.1 N). The titre of the solution is expressed by:

Chlorometric degree = mL hyposulphite solution  $\times$  1.12.

– *EDTA solution*. Dissolve 6 g of disodic salt of ethylene diamine tetraacetic acid in 80 mL deionized water, adjust the pH to 7, bring the volume to 100 mL and shake well.

### **Standard Range**

A- *Stock solution of ammonium chloride*. Weigh 0.191 g of pure  $\text{NH}_4\text{Cl}$ ; bring to 500 mL with distilled water. One mL of solution A contains 0.1 mg of N.

B- Make diluted ammonium chloride solution by diluting solution A 1:100. One mL of solution B contains 0.001 mg of N.

### *Note.*

Solution B cannot be kept for more than a few hours. A significant difference between the results and data from previous series means that all the standard solutions need to be freshly made.

### **Procedure**

#### **Calibration**

Put the volumes of ammonium chloride solution B shown in Table 28.1 in 20 mL volumetric flasks, and then add in the following order, agitating after each addition:

- 2 mL of sodium phenolate
- 2 mL of 0.2 mol L<sup>-1</sup> disodic phosphate solution
- 0.5 mL of 0.05% nitroprussiate solution
- 2 mL of sodium hypochlorite solution at 4 chlorometric degrees

Complete to 20 mL with distilled water. Shake, let the colour develop for at least 30 min in the dark. Then take the colorimetric measurement at the optimal wavelength in the 590–650 nm zone (cf. “Equipment and reagents” under Sect. 28.2.3). The Beer-Lambert law applies in the concentration range given in Table 28.1. The adjustment “Optical density =  $f$ (concentration)” is linear, and the colour remains stable for more than 24 h.

**Table 28.1.** Preparation of the colorimetric range of titration by dilution of 1  $\mu\text{g N mL}^{-1}$  B solution

mL of B solution for 20 mL	mg (N) L <sup>-1</sup> (solution)	$\mu\text{g (N) g}^{-1}$ (soil)	$\mu\text{g (NH}_4\text{) g}^{-1}$ (soil)	$\mu\text{g (NO}_3\text{) g}^{-1}$ (soil)
1	0.05	0.1	0.13	0.44
2	0.1	0.2	0.26	0.89
4	0.2	0.4	0.51	1.77
6	0.3	0.6	0.77	2.66
10	0.5	1	1.29	4.43

(Corresponding soil concentrations for inorganic N extracted from 50 g of soil in 100 mL)

### Titration

Add exactly the same quantities of reagents as for the standard curve (see “Calibration” above in this Sect. 28.2.3) to the 20 mL volumetric flasks containing the rinsing solution collected after rinsing the glass bulbs. Let the colour develop and read absorptions in the same way as for the standard calibration.

Depending on the micro-diffusion technique used (cf. Sect. 28.2.2), the results express either ammonium, or the sum of nitrites + nitrates, or nitrates alone.

Solutions that are too deeply coloured can be diluted. The control should be diluted to exactly the same degree.

It is also possible to increase sensitivity by concentrating the colour using an extraction of the coloured complex in isobutanol and reading the absorption at 655 nm.

### Note

If the micro-diffusion technique (cf. Sect. 28.2.2) is not being used, place an aliquot of exactly 5 mL of the extract described in Sect. 28.2.1 above in the 20 mL volumetric flasks. Add 1 mL of 5 g (EDTA) L<sup>-1</sup> solution, shake and wait 1 min then continue as in “Titration” above. In this case, the calibration range (“Calibration”) should be prepared using the extraction solution (cf. Sect. 28.2.1).

## 28.2.4 Colorimetric Titration of Nitrites

### Principle

This technique (Rodier 1984; Charlot 1974) uses diazotization of nitrites with sulfanilic acid at pH 2.5, and then reaction of the compound formed

with  $\alpha$ -naphthylamine (Griess reagent). A red azo dye is obtained and the colorimetric absorption is measured at 520 nm. Sensitivity can be increased by concentrating the coloured complex by extraction with chloroform at pH 9.5–10.

### Reagents

For the preparation of reagents and solutions, nitrite-free water should be used that has been purified by ion exchange on a mixed resin (1 volume of cationic resin+ 2 volumes of anionic resin).

- *Sulfanilic acid solution*. Add 1.2 g of pure sulfanilic acid in approximately 140 mL of hot purified water, cool, add 40 mL of pure hydrochloric acid, complete to 200 mL with deionized water.
- *$\alpha$ -Naphthylamine solution*. Add 1.2 g of pure  $\alpha$ -naphthylamine, 2 mL of pure hydrochloric acid, complete to 200 mL with deionized water.
- *Sodium acetate buffer solution*. Weigh 54.4 g  $\text{CH}_3\text{COONa}\cdot 3\text{H}_2\text{O}$  (or 32.8 g of anhydrous salt), dissolve and complete to 200 mL with deionized water.
- *5 g (EDTA)  $L^{-1}$  solution*. Used to complex iron and heavy metals which can cause interference.

### Standard Solution of Nitrite

#### Preparation

This solution is prepared starting from sodium nitrite ( $\text{NaNO}_2$ ), a hygroscopic and very water soluble salt with a melting point of  $271^\circ\text{C}$  which is very easily oxidized in contact with air or moisture. It is thus advisable to check the quality of the product before use. The solutions can be preserved by adding a little chloroform. Weigh exactly 150 mg of sodium nitrite, dissolve and complete to 100 mL with deionized water. One mL of this solution contains 0.1 mg of nitrite.

As nitrites are extremely unstable, the concentration of the standard solution should be checked.

#### Checking

#### Principle

Check the solution by volumetric analysis using the following oxidation technique with an excess of potassium permanganate:

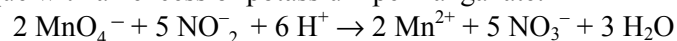

The excess of oxidant is titrated by iodometry.

**Procedure**

- Add exactly 10 mL of 0.01 N permanganate solution, and 2 mL of ½ sulphuric acid to a sample volume SV (20 mL) of the nitrite solution to be titrated.
- Shake and add 5 mL of 10% potassium iodide solution.
- Titrate iodine with the sodium hyposulphite solution ( $C = 0.01$  N), this gives volume  $V$  of hyposulphite solution.
- Repeat the titration using 20 mL of distilled water instead of the nitrite solution, this gives  $V_0$  the new volume of hyposulphite solution.

$$\text{NO}_2^- \text{ in mg L}^{-1} = C \frac{V_0 - V}{SV} 23,000$$

Starting from this solution, prepare a stock solution containing 1 mg  $(\text{NO}_2^-) \text{ L}^{-1}$

**Range of Calibration**

Prepare the calibration range shown in Table 28.2 starting from the stock solution containing 1 mg  $(\text{NO}_2^-) \text{ L}^{-1}$ .

**Table 28.2.** Calibration range for the colorimetric titration of nitrites

volume of the 1 mg $(\text{NO}_2^-) \text{ L}^{-1}$ solution (mL)	Corresponding concentration of the 50 mL solution (mg $\text{L}^{-1}$ )
1	0.02
2	0.04
4	0.08
6	0.12
8	0.16
10	0.20

**Procedure**

- Take a sample specimen of the soil extract (cf. “Procedure” under Sect. 28.2.1) within the calibration range (i.e. 50 mL or less); complete to 50 mL with deionized water.
- Add 1 mL of EDTA solution; shake.
- Add 1 mL of sulfanilic acid solution; shake and wait 10 min.
- Add 1 mL of  $\alpha$ -naphthylamine solution, 1 mL of buffer solution, shake, wait 30 min, perform colorimetric measurement at maximum absorbance (520–540 nm); the total volume of the solution measured is 54 mL; the absorbance curve is linear in the range concerned.

If  $C_s$  and  $C_L$  express the soil concentration in  $\mu\text{g (NO}_2\text{-N) g}^{-1}$  and the extract concentration in  $\mu\text{g (NO}_2\text{-N) mL}^{-1}$  respectively, and if  $f$  is the corrective moisture factor:

$$C_s = 2 C_L f.$$

*Note*

If the soil extraction solution (cf. Sect. 28.2.1) is coloured or turbid, it can be purified before measurement as follows:

- To 100 mL of extract, add 5 mL of the 120 g L<sup>-1</sup> aluminium sulphate solution, then gradually add alkalizing solution (100 g of Na<sub>2</sub>CO<sub>3</sub>·10H<sub>2</sub>O + 50 g of NaOH in a total volume of 300 mL) until alkaline reaction.
- Separate the precipitate by filtration.
- Recover the clear solution of the filtrate for titration.

### 28.2.5 Colorimetric Titration of Nitrates

#### **Principle**

Nitrates can be titrated by selective micro-diffusion (Sect. 28.2.2) on the soil extracts (Sect. 28.2.1), reduction and colorimetric titration of ammonium (Sect. 28.2.3). Several other colorimetric techniques are available for nitrates. One of the most sensitive and accurate consists in reducing nitrate into nitrite then titrating nitrite by colorimetry as described in Sect. 28.2.4. Nitrates are reduced by passing the soil extract solutions (Sect. 28.2.1) on columns of copper cadmium

#### **Equipment and Reagents**

- *Copper cadmium for reduction.* Put 50 g of cadmium in coarse powder or granule form (1 × 2 mm) in a 400 mL Erlenmeyer flask; attack for 1 min with 250 mL of 6 mol (HCl) L<sup>-1</sup> chlorhydric acid; decant the acid and rinse well with deionized water; treat twice with 250 mL of 2% cupric sulphate solution (w/v of CuSO<sub>4</sub>·5H<sub>2</sub>O); decant and rinse several times with deionized water.
- *20% ammonium chloride solution.* Dissolve 100 g of NH<sub>4</sub>Cl in deionized water and complete to 500 mL.
- *Diluted NH<sub>4</sub>Cl solution.* Take 50 mL of 20% NH<sub>4</sub>Cl solution and complete to 2 L with deionized water.
- *Other reagents.* See “Reagents” under Sect. 28.2.4.

**Procedure**

Reduction can be carried out manually on Pyrex columns with a diameter of 1 cm filled to 20 cm with the copper cadmium and eluted with approximately 75 mL diluted solution of  $\text{NH}_4\text{Cl}$ . But this operation is time consuming and it is better to automate the method using continuous flow equipment. A well-designed manifold enables titration of nitrates and nitrites with or without a passage on the reduction column.

**28.2.6 Extracted Organic Nitrogen****Principle**

The extracting reagent used in Sect. 28.2.1 (0.5 mol  $(\text{K}_2\text{SO}_4)$   $\text{L}^{-1}$  potassium sulphate solution) can solubilize a little organic nitrogen. The alkaline reagent used for ammonia displacement starting from ammonium salts during micro-diffusion (cf. Sect. 28.2.2) can act on the N organic matter of the extract. A little supplementary ammonia may be formed that does not come from the soil ammonium ion. It has been shown that more alkaline is the displacement reagent, more the dissolved organic matter is transformed to ammonia. With caustic potash, the transformation can reach 50% (Blachère and Fery 1957), whereas it is only 20% with the Conway reagent and 6% with saturated potassium carbonate. It is recommended to use this property to quantify possible changes in N organic matter (with respect to its state of complexity).

**Procedure**

The extracted solution (cf. Sect. 28.2.1) is subjected to double diffusion (cf. Sect. 2.2):

- The first sample specimen is subjected to diffusion using saturated potassium carbonate.
- The second sample specimen is subjected to diffusion using the Conway reagent.

Ammonia is titrated on the two displaced solutions. The comparison of the results and calculation of the ratio of the two titrations indicates the stability of organic matter and enables its transformation to be monitored.

## 28.3. Other Methods

### 28.3.1 Nitrate and Nitrite by UV Photometric Absorption

#### *Principle*

Solutions containing nitrate and nitrite strongly absorb ultraviolet radiation, particularly at 210 nm. At this wavelength, the law of Beer-Lambert is applicable up to approximately  $10 \text{ mg (N) L}^{-1}$ .

The sum of nitrate + nitrite is estimated by measurement of UV absorption at 210 nm before and after elimination of these anions by treatment with Raney catalyst (Ni–Al). Nitrite is estimated before and after its elimination with sulphamic acid.

This technique is satisfactory for the analysis of soil extracts (Norman and Stucki 1981; Norman et al. 1985). Its main advantage is simplicity as it does not require a colouring reagent.

However, it does require a UV spectrophotometer, which is more expensive than a simple visible spectrometer. Moreover, the limit of detection is higher than in the colorimetric method described in Sect. 28.2.5.

#### *Reagents*

- 20% sulphuric acid solution, made from concentrated  $\text{H}_2\text{SO}_4$ ,  $d = 1.84$ .
- 2% sulphamic acid solution from  $\text{H}_3\text{NO}_3\text{S}$  should be stored in the refrigerator.
- Raney catalyst (approximately 50% Ni and 50% Al).
- *Standard solutions of nitrate.* For the stock solution, weigh 3.606 g of pure  $\text{KNO}_3$ , dissolve in deionized water, complete to 1,000 mL, 1 mL contains 0.5 mg of N or 2.214 mg of  $\text{NO}_3^-$ , 1:50 diluted solution of stock solution, 1 mL contains 0.01 mg of N or 0.044 mg of  $\text{NO}_3^-$ .
- 0.1 mg ( $\text{NO}_2$ )  $\text{mL}^{-1}$  standard solution of nitrite (see “Standard Solution of Nitrite”).
- *Extraction solution.* 0.5 mol  $\text{L}^{-1}$  potassium sulphate (see “Equipment and Reagents” under Sect. 28.2.1).
- *Discolouration solution.* 120 g  $\text{L}^{-1}$  aluminium sulphate.
- *Alkalinizing solution.* 100 g  $\text{Na}_2\text{CO}_3$  + 50 g NaOH in 300 mL of deionized water.



## Procedure

### Preparation of the Soil Solution

Put 10 g of soil (see preparation in Sect. 28.1.2) then 30 mL of extraction solution in 100 mL bottles, stop, agitate on a rotary shaker for 10 min, decant and filter the clear part. If the solution is coloured, add 1 mL aluminium sulphate solution, alkalize by progressive addition of alkalizing solution until formation of hydroxide and then filter.

### Preparation of Ranges of Calibration Standards

Prepare two series of solutions for nitrate and nitrite using the range of standard solutions listed in Table 28.3. Bring to a volume of 30 mL with the extraction solution. Measure absorption compared to a blank containing the extraction reagent alone in the following spectrometric conditions: wavelength 210 nm, narrow slit of approximately 0.8 mm, quartz measuring cell with a path length of 1 cm. Plot two calibration curves, one for nitrate and the other for nitrite.

**Table 28.3.** Range of calibration standards for titration of nitrate and nitrite by UV spectrometry

	mL of the 0.044 mg (NO <sub>3</sub> <sup>-</sup> ) mL <sup>-1</sup> solution for 30 mL	µg (NO <sub>3</sub> <sup>-</sup> ) g <sup>-1</sup> (soil) for 10 g soil in 30 mL
NO <sub>3</sub> <sup>-</sup>	0.5	2.2
	1	4.4
	2	8.8
	4	17.6
	8	35.2
	10	44
	mL of the 0.1 mg (NO <sub>2</sub> <sup>-</sup> ) mL <sup>-1</sup> solution for 30 mL	µg (NO <sub>2</sub> <sup>-</sup> ) g <sup>-1</sup> (soil) for 10 g soil in 30 mL
NO <sub>2</sub> <sup>-</sup>	0.1	1
	0.2	2
	0.4	4
	1	10
	2	20
	4	10

### Titration of Nitrate

– To 25 mL of the extracted solution, add 1 mL of the 2% sulphamic acid solution; shake for 1 min to obtain a solution free from nitrite. Measure

its absorption at 210 nm; compare it with a 25 mL blank containing 1 mL of sulphamic acid solution in the extraction solution; this value is "A".

- To 5 mL of the nitrite-free solution, add successively: approximately 0.3 g of catalyst, 0.5 mL of 20% sulphuric solution; mix well, place the tube in a drying oven regulated at 60°C for about 40 min; let cool; this solution is free from nitrate and nitrite. Measure its absorption at 210 nm, compare it with a blank containing 5 mL of extraction solution plus 1 mL of sulphamic acid solution plus 0.3 g of catalyst, plus 0.5 mL of 20% sulphuric acid solution, dry in the oven like the sample; this adsorption value is "B".

The absorption value originating from the nitrate is:

$$(1.04 A) - (1.1 B).$$

To obtain the result in  $\mu\text{g}(\text{NO}_3^-) \text{ g}^{-1}$  (soil), the absorption values should be plotted on the calibration curve for nitrate. The coefficients 1.04 and 1.1 correct the influence of the slight dilutions caused by the sulphamic acid and sulphuric acid.

#### *Titration of Nitrite*

Put 5 mL of the soil extract solution in a test tube, measure its absorption at 210 nm; compare it with a blank containing 5 mL of extraction solution, this value is "D".

Add 5 mL of the sulphamic acid solution to the 5 mL of soil extract and shake for 1 min; read absorption at 210 nm; compare it with a blank containing 5 mL of the extraction solution plus 5 mL of sulphamic acid solution, this value is "E".

The absorption value of nitrites is:  $D - (2E)$ .

(Coefficient 2 corrects for dilution in the second measurement).

#### *Calculation of the Results*

The values are obtained by reading the calibration curves, for the operating conditions described earlier. Each value obtained should be corrected by the moisture coefficient of the soil sample.

### **28.3.2 Ammonium Titration Using a Selective Electrode**

#### ***The Measurement Electrode***

The electrode is of the gas diffusion type (Fig. 28.3) and consists of a gas-permeable hydrophobic membrane. Ammonium contained in the

sample has to be moved by an alkaline solution. The ammonium diffuses through the electrode membrane until equilibrium is reached between the partial pressures on each side. The gas dissolves in the internal solution giving hydroxyl ions.

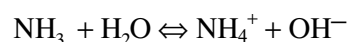

The equilibrium constant is expressed by:

$$K = \frac{[\text{NH}_4^+][\text{OH}^-]}{[\text{NH}_3]}$$

The internal ammonium ion concentration ( $0.22 \text{ mol } (\text{NH}_4 \text{ Cl}) \text{ L}^{-1}$ ) can be considered as constant, thus:  $[\text{OH}^-] = K' [\text{NH}_3]$

The electrode (like a pH electrode) is sensitive to hydroxyl ions. The potential of the electrode is thus linked with the ammonia concentration of the sample.

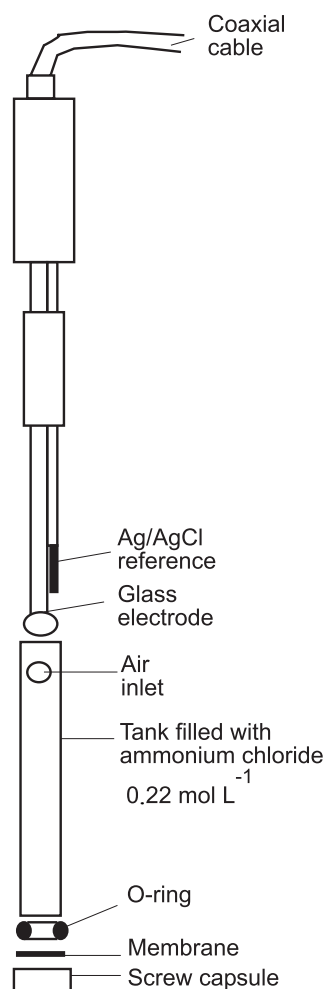

**Fig. 28.3.** Schematic diagram of a gas diffusion electrode for titration of the ammonium ion

## Equipment and Reagents

### Reagents

- 0.22 mol L<sup>-1</sup> ammonium chloride solution (to fill the electrode). Weigh 1.17 g of pure NH<sub>4</sub>Cl, dissolve and complete to 100 mL with distilled water.
- 0.5 mg (N) mL<sup>-1</sup> standard stock solution of ammonium chloride (A). Weigh 0.955 g of pure NH<sub>4</sub>Cl, dissolve and complete to 500 mL with distilled water.
- 0.01 mg (N) L<sup>-1</sup> solution of ammonium chloride (B). Dilute solution A 1/50.
- Calibration range. Prepare the calibration solutions in 20 mL volumetric flasks using the quantities of standard solutions listed in Table 4.

**Table 28.4.** Range of calibration for titration of exchangeable ammonium and nitrates using the ammonium electrode, the extraction procedures of Sect. 28.2.1 and micro-diffusion procedures in Sect. 28.2.2 (50 g soil sample, 100 mL extracting reagents, 20 mL sample specimen for diffusion, calibration points completed to 20 mL)

mL of NH <sub>4</sub> Cl solutions for 20 mL				
solution A 0.5 mg (N) mL <sup>-1</sup>	solution B 0.01 mg (N) mL <sup>-1</sup>	mg (N) L <sup>-1</sup>	μg (N) g <sup>-1</sup> (soil)	μg (NO <sub>3</sub> ) g <sup>-1</sup> (soil)
	0.5	0.25	0.5	2.21
	1	0.5	1	4.42
	2	1	2	8.84
	4	2	4	17.7
	10	5	10	44.2
	20	10	20	88.7
0.8		20	40	176.6
2		50	100	442

### Preparation of the Electrode

Depending on the make, all the electrodes may not look the same, but the components are always similar.

- Unscrew the cap and remove the glass electrode (Fig. 28.3).
- Put the glass bulb of the electrode to soak in a 0.1 mol L<sup>-1</sup> hydrochloric acid solution. The acid solution must not reach the reference part of the electrode which consists of a silver wire covered with silver chloride.
- After 24 h of contact, rinse abundantly with distilled water and then leave in distilled water until use.
- Place a very fine membrane of Teflon at the bottom of the electrode tank (Fig. 28.3) and then screw the cap tight.

- Lower the glass electrode until the membrane bulges slightly, showing that the glass bulb is in contact with the membrane.
- Fill the tank electrode with the reference liquid, in this case 1 mL of a 0.22 mol L<sup>-1</sup> ammonium chloride solution.

The electrode is now ready for use. It can be stored in a 0.1 mol L<sup>-1</sup> ammonium chloride solution. When it is not going to be used for more than 2 weeks, tank and electrodes should be separated and the glass electrode stored in distilled water.

### **Procedure**

#### *Calibration of the Electrode, Value of the Slope “S”*

- Before using the electrode, the slope value of the response curve should be established; this is expressed in mV (generally ranging between 45 and 60 mV for a variation of concentration of a factor 10).
- In 20 mL volumetric flasks, prepare five points: 0.5, 1, 5, 10, 50 mg (N) L<sup>-1</sup> for the volumes of solution listed in Table 28.4. Complete to 20 mL with distilled water; all these solutions will be brought to a temperature of 25°C for measurement.
- Put 20 mL of distilled water (25°C) in a beaker, immerse the electrode prepared as described in “Equipment and Reagents” under Sect. 28.3.2; add 2 mL of 40% soda and shake; after 5 min, read the potential in mV. If adjustment of potential is possible, adjust to zero value; if not, note the  $E_0$  value
- Measure the first point of the calibration range, 0.5 mg L<sup>-1</sup> by transvasing the 20 mL flask containing this solution in a beaker. Immerse the electrode, add 2 mL soda, and agitate. After 5 min, read the potential  $E_1$ . Repeat the operation up to point  $E_5$  and plot the calibration curve  $mV = f(N)$  to determine the slope of the electrode.

#### *Measurements*

Measurements are carried out on the 20 mL of soil extract as previously described (cf. Sect. 28.2.2). Use direct measurements from the slope or the standard addition method.

If  $C_e$  is the content of nitrogen in mg L<sup>-1</sup> found in the extract and  $f$  the moisture corrective factor, the ammonium-N content  $C_s$  in  $\mu\text{g (N) g}^{-1}$  (soil) is expressed by:

$$C_s = 2 C_e f.$$

Expressed in  $\mu\text{g (NH}_4^+) \text{ g}^{-1}$  and  $\mu\text{g (NO}_3^-) \text{ g}^{-1}$  (previous reduction by Raney catalyst, see section 3.1), the contents are:

$$C_s^{\text{NH}_4} = 2.56 C_e f,$$

$$C_s^{\text{NO}_3} = 8.84 C_e f.$$

### 28.3.3 Measurement of Nitrates with an Ion-Selective Electrode

#### **Combined Measurement-Reference Electrode**

The response to the nitrate ions of a compact combined electrode with an active plastic membrane (Ingold) is approximately 56 mV when concentration is multiplied or divided by 10. It is linear for nitrate contents ranging from 1 g L<sup>-1</sup> to 5 mg L<sup>-1</sup>. Beyond the limit of the linearity domain, the electrode is still usable down to 1 mg L<sup>-1</sup>.

Among anions found in soil extracts, the most serious interferences come from NO<sub>2</sub><sup>-</sup>, Cl<sup>-</sup>, HCO<sub>3</sub><sup>-</sup> ions and to a lesser extent from SO<sub>4</sub><sup>2-</sup> ions. A nitrate-to-nitrite ratio equal to one induces 20% error. The Cl<sup>-</sup>-to-NO<sub>3</sub><sup>-</sup> ratio must be lower than one, the HCO<sub>3</sub><sup>-</sup>-to-NO<sub>3</sub><sup>-</sup> ratio must be lower than 25, the SO<sub>4</sub><sup>2-</sup>-to-NO<sub>3</sub><sup>-</sup> ratio must be lower than 100.

It is possible to work in a broad range of pH (between 2 and 12).

A reference electrode of the mercurous sulphate/potassium sulphate type should be used to avoid pollution of the medium by the chloride ion. At 22°C, this electrode develops an electromotive force of +402 mV more than the calomel electrode in saturated potassium chloride. It can be used in a temperature range of from 0 to 60°C, with a thermal coefficient of +0.13 mV K<sup>-1</sup>.

#### **Equipment and Reagents**

- pH/mV meter allowing a resolution of ± 0.5 mV for a measurement range of ± 1 V.
- Ingold nitrate electrode (or similar).
- Reference mercurous sulphate electrode (or similar).
- *Calibration solutions.* 0.5 mg (NO<sub>3</sub>-N) mL<sup>-1</sup> and 0.01 mg (NO<sub>3</sub>-N) mL<sup>-1</sup>, see "Reagents" under Sect. 28.3.1.
- *Extraction solution.* 0.005 mol L<sup>-1</sup> potassium sulphate.
- 2% sulphamic acid solution NH<sub>2</sub> SO<sub>3</sub> H.

#### **Calibration**

Put the test specimens listed in Table 28.5 in 50 mL beakers, complete to 20 mL with the extraction solution. Add 0.5 mL of sulphamic acid solution, shake for 1 min and let stand for 10 min. Note the temperature which should be close to 25°C. Immerse the electrodes and take measurements without agitating. Read the potential in mV after stabilization of the measurement (2 min) and plot the calibration curve.

Make a blank with 20 mL of extraction solution treated with sulphamic acid in the same way as for the samples.

### Titration

- Carry out the soil extraction as described in Sect. 28.2.1, but using the diluted solution of potassium sulphate.
- Put 20 mL of the soil extract solution in 50 mL beakers.
- Add 0.5 mL of sulphamic acid solution in each beaker; shake for 1 min and let stand for 10 min to remove nitrites.

**Table 28.5.** Preparation of the calibration range for nitrate titration by ionometry

calibration points mg (NO <sub>3</sub> -N) L <sup>-1</sup>	mL of the 0.01 mg (NO <sub>3</sub> -N) mL <sup>-1</sup> solution	Volume needed to complete to 20 mL	mL of the 0.5 mg (NO <sub>3</sub> -N) mL <sup>-1</sup> solution	volume needed to complete to 20 mL
2	4	16		
3	6	14		
5	10	10		
10			0.4	19.6
50			2	18
100			4	16

Complete to 20 mL with the 0.005 mol (K<sub>2</sub>SO<sub>4</sub>) L<sup>-1</sup> extraction solution

- Note the temperature which should be close to the calibration temperature.
- Immerse the electrodes in the blank and check that the zero point set for calibration has not changed.
- Immerse in the sample solutions. After allowing the measurement to stabilize for approximately 2 min read the potential in mV without agitating. Note the corresponding concentrations  $C_i$  expressed in mg (NO<sub>3</sub>-N) L<sup>-1</sup> on the calibration curve.

Using the procedure described in Sect. 28.2.1 above (50 g soil, 100 mL extraction solution), the concentration  $C_s$  is expressed in  $\mu\text{g (NO}_3^-) \text{ g}^{-1}$  (soil):

$$C_s = \frac{4.428 \times 1.02 \times 100 \times 20}{1,000} C_i f = 9.032 C_i f,$$

( $f$  is the moisture correction factor, 4.428 is the NO<sub>3</sub>:N ratio, 1.02 = 20.5/20 is the sulphamic acid correction factor). If the concentration is too high, dilute the test specimen. If the concentration is too low, increase the soil sample.

### 28.3.4 In situ Measurement

#### *Principle*

Forms of mineral nitrogen can change rapidly and the turnover can be high. Consequently in situ measurement can be particularly useful for optimizing cultivation techniques or controlling pollution. A Tensionic (SDEC<sup>2</sup>) consists of a porous plug tensiometer adapted for measurements on the soil solution. Djurhuus and Jacobsen (1995) compared the method using porous ceramic plugs and extraction with potassium chloride for nitrate titration. Exchange is by simple ionic diffusion between the soil solution and the internal water of the plug; the apparatus gives the tensiometric value at the same time.

#### *Description*

##### *The Probe*

The probe is a porous plug (Fig. 28.4) for the measurement of high-flow soil moisture.<sup>3</sup> It is tightly stopped with a PVC stopper, and three fine Nylon capillary tubes go down to the bottom of the plug. One tube is used for tensiometric measurement, and another is used for extraction of the solution contained in the plug. The third tube emerges at the top of the plug and allows the circuit to be purged at the beginning and can also be used to put the solution back after analysis. The whole unit is contained in an opaque PVC rod whose length depends on the aim of the study (often 50 cm or 1 m).

##### *The Measuring Apparatus*

The probe is supplied with a battery and a peristaltic pump which works in two directions and is connected to the exit of the collection and purging tubes, and emerges in a watertight tank with an ionic electrode connected to a milli-voltmeter for measurement. A three-way stopcock on the pump circuit enables aliquots to be removed for other analyses.

---

<sup>2</sup> - SDEC, BP 4233, 37 000 Tours, France.

<sup>3</sup> - Soil Moisture, P.O. Box 30025, Santa Barbara, CA 93105, USA.



**Procedure**

During purging the plug device should be filled with distilled water to avoid creation of a vacuum. After purging, close the purging and collection tubes with clamps. Dig a cylindrical cavity in the soil that is slightly broader than the plug; remove soil in sections as a function of depth. Mix the soil from the bottom with distilled water, and inject the resulting paste back into the bottom of the hole. Insert the plug and push it down to the bottom of the paste; fill the remainder of the hole with the soil corresponding to the depth at which it was removed; pack the soil down slightly. Place a protective ring on the surface of the soil to prevent infiltration around the plug.

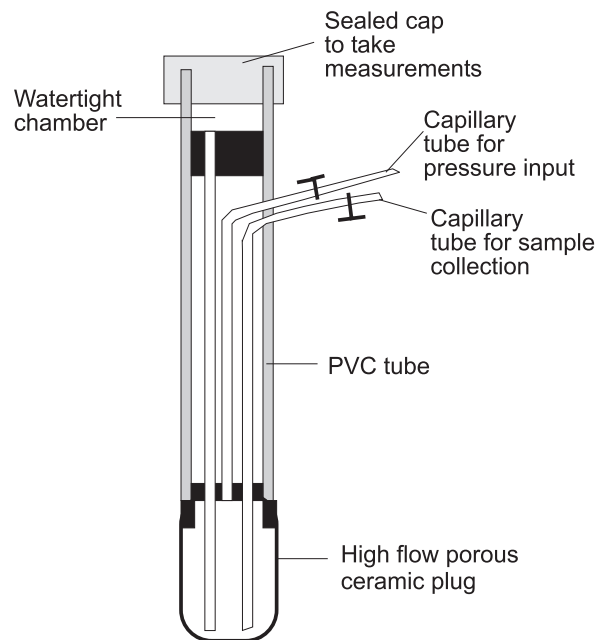

**Fig. 28.4.** Schematic diagram of the Tensionic apparatus (SDEC)

Measurements can be taken after equilibration of the soil solution, which requires 8–10 days. Start the pump to transfer the solution from the plug into the watertight tank containing the electrodes. The technique described in Sect. 28.3.3 can be used for nitrate titration without the addition of sulphamic acid to destroy nitrites, which are titrated with nitrates.

### 28.3.5 Non-Exchangeable Ammonium

#### **Principle**

Some soil ammonium may be fixed in the clay layers and are not exchangeable in saline solutions and thus practically inaccessible to plants and micro-organisms. Three methods have been proposed for the estimation of non-exchangeable soil ammonium (1) Kjeldhal distillation at 400°C after elimination of organic nitrogen and exchangeable ammonium, (2) estimation by the difference between ammonium distilled in the presence of soda and ammonium distilled with potash and (3) estimation of the ammonium released by hydrofluoric acid treatment for destruction of the clay layers. The method described here, which is based on that of Keeney and Nelson (1982), belongs to the last category. Before the HF treatment, the organic matter and exchangeable ammonium are destroyed using a mixture of potash and potassium hypobromite which is known to be not too destructive for non-exchangeable ammonium.

#### **Equipment and Reagents**

- *Potassium hypobromite solution (KBrO)*. Slowly add 6 mL of bromine to 200 mL of stirred, ice-cold 2 mol L<sup>-1</sup> potash solution; this solution should be prepared immediately before use.
- *0.5 mol (KCl) L<sup>-1</sup> solution*. Dissolve 186 g of KCl in 5 L of water.
- *5 mol (HF)–1 mol (HCl) L<sup>-1</sup> solution*. Use a polyethylene flask with a graduation mark at 2 L. Fill with about 1.5 L of water, then while stirring, add 167 mL of concentrated hydrochloric acid (HCl,  $d=1.19$ ) and 325 mL of 52% hydrofluoric acid (31 mol L<sup>-1</sup>). Complete to 2 L with deionized water and swirl the contents of the flask carefully.

#### **Procedure**

Place 1 g of finely crushed soil sample in a 200 mL tall form beaker and add 20 mL of potassium hypobromite solution. Stir and cover the beaker with a beaker cover; let stand for 2 h. Add 60 mL of water and boil for 5 min. Let stand overnight and decant the clear supernatant. Transfer the residue in a 100 mL polyethylene centrifugation tube using a washing bottle filled with the 0.5 mol (KCl) L<sup>-1</sup> solution. Fill the tube to around 80 mL with the 0.5 mol (KCl) L<sup>-1</sup> solution (equilibrate the weight between samples), stop, shake manually for a few seconds and centrifuge at 1,100g for 10 min. Decant the supernatant and repeat the extraction operation with the 0.5 mol (KCl) L<sup>-1</sup> solution.

Add 20 mL of HF–HCl solution to the centrifugation pellet using a polyethylene volumetric tube. Close the centrifugation tube and shake for 24 h on a mechanical shaker.

Released ammonium can be titrated directly by distillation (cf. Chaps. 10 and 14) or by micro-diffusion as described in Sect. 28.2.2 above. In each case care should be taken to avoid contact between the solution containing hydrofluoric acid and the glass walls of the equipment: Use long-stemmed polyethylene funnels to transfer the contents of the centrifugation tube in alkaline medium, use plastic Erlenmeyer flasks for micro-diffusion.

## References

- Blachère H and Ferry P (1957) Dosage de l'azote minéral dans les sols par micro-diffusion. *Ann. Agr.*, 8, 111–118, 495–498
- Charlot G (1974) *Chimie analytique quantitative*. Masson. T II, 347
- Conway EJ (1962) *Micro-diffusion analysis and volumetric error.*, Crosby lockwood, London, 5ème édit
- Djurhuus J and Jacobsen OH (1995) Comparison of ceramic suction cups and KCl extraction for the determination of nitrate in soil. *Eur. J. Soil Sci.*, 46, 387–395
- Guiot J (1975) Estimation des réserves azotées du sol par détermination de l'azote minéral. *Revue de l'Agriculture*, 5, 1117–1132
- Guito J, Goffart JP and Destain JP (1992) Le dosage des nitrates dans le sol. *Bull. Rech. Agron.*, Gembloux, 27, 61–74
- Keeney DR and Nelson DW (1982) Nitrogen – inorganic forms. In *Methods of Soil Analysis*, Page AL, Miller RH and Keeney DR ed. ASA-SSSA, Agron. Monograph No 9, 2nd ed. Madison, WI Etats-Unis, 643–698
- Khan SA, Mulvaney RL and Hoelt RG (2000) Direct-diffusion methods for inorganic-nitrogen analysis of soil. *Soil Sci. Soc. Am. J.*, 64, 1083–1089
- Mulvaney RL and Khan SA (1999) Use of diffusion to determine inorganic nitrogen in a complex organic matrix. *Soil Sci. Soc. Am. J.*, 63, 240–246
- Mulvaney RL (1996) Nitrogen – Inorganic forme. In *Methods of Soil Analysis, Part 3, Chemical Methods*, Bigham JM and Bartels JM ed. SSSA-ASA, Madison, WI Etats-Unis, 1123–1184
- Mulvaney RL, Khan SA, Stevens WB and Mulvaney CS (1997) Improved diffusion methods for determination of inorganic nitrogen in soil extracts and water. *Biol. Fertil. Soils*, 24, 413–420
- Norman RJ and Stucki JW (1981) The determination of nitrates and nitrites in soil extracts by UV spectrophotometry, *Soil Sci. Soc. Am. J.*, 45, 347–353

- Norman RJ, Edberg JC and Stucki JW (1985) Determination of nitrates in soil extracts by dual-wavelengths UV spectrophotometry, *Soil Sci. Soc. Am. J.*, 49, 1182–1185
- Rodier J (1984) *Analyse chimique et physico-chimique de l'eau*. Dunod (Paris)
- Susini J and N'Gandjui C (1964) Dosage de l'azote minéral. *Cah. ORSTOM Sér. Pédol.*, 2, 57–71
- XP X31-115 (1995) Qualité des sols. Prélèvement et conservation des échantillons de sol en vue de la détermination de l'azote minéral sur sol frais, *AFNOR*, 8 p

## Bibliography

- Boltz DF and Howell JA (1978) *Colorimetric Determination of Non Metals.*, Wiley, New York
- Bremmer JM (1987) Laboratory techniques for determination of different forms of nitrogen cycling in agriculture ecosystems. *Proc. Symp. Adv. Nitrogen*, Brisbane, Australia : 11–15 mai 1987
- Cheverry C (1983) L'extraction de la "Solution du Sol" par le biais de bougies poreuses. *Bulletin du groupe français d'humidimétrie neutronique (GFHN)*, 14, 47–71
- Gautheyrou J and Gautheyrou M (1965) Dosage simultané de l'azote ammoniacal et nitrique dans les sols – Contribution à l'étude de la dynamique de l'azote. *Cah. Orstom Ser. Pédol.*, 4, 367–391
- Morie GP and Ledford CJ (1972) Determination of nitrate and nitrite in mixtures with a nitrate ion electrode. *Anal. Chim. Acta.*, 60, 397–403
- Moutonnet P, Guiraud G and Marol C (1989) Le tensiomètre et la teneur en nitrates de la solution du sol. *Bulletin du groupe français d'humidimétrie neutronique (GFHN)*, 26, 11–28
- prNF ISO 14256-2 (2002) *Qualité du sol* – Dosage des nitrates, des nitrites et de l'ammonium dans des sols bruts par extraction avec une solution de chlorure de potassium. AFNOR, X 31-423-2
- Taras MJ (1971) Standard methods for the examination of water of wastewater. *13e edit. American Public health association*, Washington, DC 20036

## Phosphorus

### 29.1 Introduction

Although phosphorus (P) is not very abundant<sup>1</sup> in soils, it is nevertheless a major element and plays a fundamental role in agronomy and biogeochemical cycles. P exists in all the living organisms. It is able to form innumerable covalent organo-phosphorous compounds and to bind to C, N, O, Al, Fe, Ca. It is involved in the fundamental transfer processes from radiant electromagnetic energy to chemical energy (photosynthesis) and sustains the development of the radicular systems of the plants.

The characterization and speciation of the different forms of P in the soil are thus indispensable for the quantification of plant needs and the implementation of land management methods likely to satisfy them. This nutritional aspect is closely linked with pedogenic transformations and to the risk of environmental pollution.

More than 220 minerals containing P have been identified that are stable at the geological time scale. In addition, manufactured products such as fertilizers, pesticides, detergents and compounds like water-softeners, fire retardants, fuel additives, and plastics contain a very wide range of phosphorous compounds. These compounds are widespread in the human environment and play an important role in ecology. They represent new problems for the analyst, one example being the impact of anthropization of arable lands and certain farming techniques. For example slash and burn agriculture generates pyrophosphates, applying sewage sludge adds polyphosphates and organic forms of P that do not exist in the natural environment. It is generally accepted that plants can

---

<sup>1</sup> P is quantitatively ranked ninth of the elements composing the earth's crust. It is particularly common in the orthophosphate state bound to calcium (apatites) with average contents estimated at about 0.1%.

only assimilate phosphorus directly in the form of orthophosphates in the soil solution.

The main organic forms of P (50–75%) are used as reserves and are in continual transformation, the cycle of immobilization and mineralization of organic–inorganic-P in soil being influenced by pH, redox and biochemical phenomena (phosphatases) such as climatic conditions. In soils with a pH of between 3.5 and 10, the orthophosphate forms are primarily  $\text{H}_2\text{PO}_4^-$  in acid medium and  $\text{HPO}_4^{2-}$  in basic medium. The activity of the two ions is about equal at pH 7.2, the  $\text{H}_3\text{PO}_4$  form becomes predominant below pH 3.5 and the  $\text{PO}_4^{3-}$  form is predominant above pH 11–12.

The purpose of the different methods is to evaluate total P, especially the forms that are available to varying degrees in the short and medium term (White and Beckett 1964, Dalal and Hallsworth 1976, Roche et al. 1978, Pierzynski 2000):

- quantity ( $Q$ ) of different forms of P: extractable, occluded, total P
- intensity ( $I$ ), chemical potential of the  $\text{PO}_4^{3-}$  ions in the soil solution that enable normal plant growth throughout the vegetative cycle
- capacity of maintenance of the P concentration in the soil solution expressed by the fixing power of P, adsorption isotherms ( $\Delta Q/\Delta I$ )
- kinetics of desorption over time
- diffusibility, extent of the zone likely to provide the soil solution.

Thus the chemical and biochemical changes which occur during the dynamic process of the phosphorus cycle can be measured, and possibly controlled and directed.

Unlike the C, H, N, O, S cycles, in the P cycle, no losses occur due to volatilization (except possibly  $\text{H}_3\text{P}$  whose existence in the natural state has not yet been demonstrated, even in very reducing medium). This specificity can increase the risk of water eutrophication by pollution, as the action of P continues over a period of many years, even after the sources of pollution have been removed.

## 29.2 Total Soil Phosphorus

### 29.2.1 Introduction

The term total phosphorus covers all forms of P in the soil, i.e. organic, inorganic, occluded and available P. It is the total flow of P at a given time. The soil P content depends on the nature of the parent rock, climatic factors

and the deterioration that results (degree of weathering, biotic activity, erosion, leaching). P contents are very varied. Soils on calcareous mediums that are rich in apatite can contain high percentages of total P in not very wet climates. On the other hand, acid soils that developed on granitic rocks with low P contents, also present low P contents in their natural state.

Chemical analysis first has to destroy the matrix (inorganic and organic) in order to solubilize the fixed or occluded forms which are mainly insoluble (like some calcium, iron or aluminium phosphates) and which correspond to medium and long-term soil reserves.

Mineralization can be accomplished (i) using a wet process e.g. an acid attack in oxidizing medium to avoid loss of forms of phosphorus which could appear in the reducing medium, (ii) using dry methods e.g. alkaline fusion in oxygenated furnace followed by an acid attack of the products of fusion.

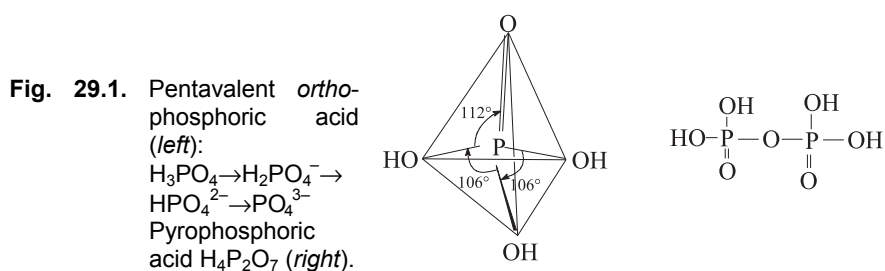

Phosphorus has five valence electrons and forms almost only covalent bonds. In the fundamental state there are three p orbitals, each filled by only one electron. This corresponds to an electronic distribution of spherical symmetry and a great energy of ionization. Phosphorus often forms covalent compounds. Free enthalpies of the different oxidation states in solution at pH0 show that the molecules are relatively unstable and can be transformed. Hydrolysis results in maximum oxidation giving *ortho*-phosphoric acid, the pentavalent form of phosphorus with maximum thermodynamic stability. It thus provides the basis for the majority of chemical titrations (Fig. 29.1).

## 29.2.2 Wet Mineralization for Total Analyses

### *Principle*

Wet mineralization procedures for total analysis (cf. Sect. 31.2 of Chap. 31) can be used for analysis of total P. However, if the only analysis required is total phosphorus, the procedures can be simplified. The soil is

subjected to an oxidizing acid attack i.e. prolonged boiling with nitric or perchloric acid. The different forms of P are all brought to the *ortho* state. The organic matter is destroyed and the P compounds on which it was bound are released. Apatites are dissolved along with phosphates of iron and aluminium, phosphites ( $\text{HPO}_3^{2-}$ ), tripolyphosphates ( $\text{Na}_5\text{P}_3\text{O}_{10}$ ), metaphosphates and pyrophosphates.

However, the soil residue may still contain primary minerals with unattacked P inclusions that can only be destroyed with hydrofluoric acid (cf. Sects. 31.2.3 and 31.2.4 of Chap. 31).

### **Equipment**

- Analytical balance (1/10 mg)
- electric sand bath or hotplate
- 150 mL Pyrex boiling Kjeldahl flasks
- rack for filtration and funnels
- hardened analytical filters
- lab glassware.

### **Reagents**

- Nitric acid ( $\text{HNO}_3$  *d*: 1.4, (boiling point 120°C)
- 60% perchloric acid for analysis (can be deflagrating)
- deionized water.

### **Procedure with Nitric Acid**

- Weigh aliquots of 5 g of soil dried at 105°C and crushed to 0.2 or 0.1 mm and put them in 150 mL Pyrex boiling Kjeldahl flasks
- add 30 mL of concentrated nitric acid
- cover with long-stemmed micro-funnels; place in the sand bath and boil for 3 h (do not allow to go dry)
- cool and dilute carefully with deionized water
- filter on hardened analytical filters in long stem funnels
- wash the filter with deionized boiling water and collect all filtrates in a 250 mL Pyrex beaker
- evaporate to almost dry
- dissolve with 1 mL of perchloric acid (or sulphuric acid)
- dilute with deionized water to 50 or 100 mL (depending on the soil type and supposed contents); homogenize.



Titration is carried out on aliquots by spectrophotometry or other spectographic methods (cf. Sect. 29.5 below or Chap. 31). The results are expressed on the basis of soil dried at 105°C.

### *Remarks*

Nitric attack does not mineralize the entire soil matrix and leaves a relatively large residue.

In organic (e.g. histosols) or humus-bearing soils, the organic matter is unlikely to be completely destroyed. In this case, bring to almost dry and add perhydrol until complete discolouration, then attack again with 1 mL of nitric acid

The attack solution contains silica. If it is dried, silica can become sintered and not easily resolubilized but can be partly eliminated by filtration.

The nitric method may have certain disadvantages, but involves fewer risks than mineralization with perchloric acid (cf. the following section).

### ***Procedure with Perchloric Acid***

- Weigh 2–5 g of soil dried at 105°C and crushed to 0.2 or 0.1 mm
  - put it in a 150 mL Pyrex boiling Kjeldahl flask and add 30 mL of 60% perchloric acid
  - continue as described in 2.2.4 above boiling gently for approximately 30 min until white smoke appears and discolouration occurs
  - without boiling, reduce the volume until almost white sands are obtained
  - filter and complete the volume to 250 mL, homogenize.
- Titrate on an aliquot (cf. Sect. 29.5 or Chap. 31).

### *Remarks*

As the perchlorates are unstable, they must not be allowed to go dry.

Boiling should be gentle particularly at the beginning of mineralization when organic matter is still abundant (for very organic soils, the destruction of organic matter can be incomplete and require addition of nitric acid then concentration to almost dry and an attack with 1 mL of perchloric acid).

### 29.2.3 Dry Mineralization

#### **Principle**

Alkaline fusion can destroy the structural matrix resulting in amorphous solid solutions that are easily attacked in acid medium. The attack is generally very complete and is suitable for total analyses, including refractory elements. Thus in addition to the method described in this section, the methods described in Sect. 31.2.6 of Chap. 31 can also be used for the analysis of total P.

Soil is mixed with sodium carbonate in a platinum crucible and melted in open oxidizing medium. The different forms of P are transformed into orthophosphate form, and then solubilized by an acid attack. Too-prolonged heating after fusion should be avoided because of the risk of the appearance of monoperphosphoric ( $\text{H}_3\text{PO}_5$ ) and perphosphoric ( $\text{H}_4\text{P}_2\text{O}_7$ ) acids.

#### **Equipment**

- 50 mL platinum crucibles
- electric furnace able to function while open (oxidizing atmosphere)
- crucible tongs
- lab glassware.

#### **Reagents**

- Anhydrous sodium carbonate ( $\text{Na}_2\text{CO}_3$ , melting point =  $851^\circ\text{C}$ );
- deionized water
- 5 mol ( $\text{HNO}_3$ )  $\text{L}^{-1}$  nitric acid
- 5 mol ( $\frac{1}{2}\text{H}_2\text{SO}_4$ )  $\text{L}^{-1}$  sulphuric acid.

#### **Procedure**

- Weigh 1 g of soil dried at  $105^\circ\text{C}$  and crushed to 0.2 or 0.1 mm
- place the soil in a platinum crucible and mix with 5 g of sodium carbonate
- heat the sample gradually and move it around in the furnace until the beginning of fusion ( $850^\circ\text{C}$  approximately) taking care to avoid projections

- half cover the crucible with the lid to preserve an oxidizing atmosphere and maintain the temperature of the furnace for 20 min
- holding the crucible with the tongs, swirl the contents around to distribute the product in fusion on the walls; let cool
- put the crucible and its lid in a 250 mL Pyrex beaker, gradually and carefully add 30 mL of 5 mol ( $\frac{1}{2}\text{H}_2\text{SO}_4 \text{ L}^{-1}$ ) acid taking care not to cause projections (avoid HCl which can attack the platinum crucibles)
- boil until complete dissolution
- if necessary add 5 mL of 1 mol ( $\frac{1}{2}\text{H}_2\text{SO}_4 \text{ L}^{-1}$ )  $\text{L}^{-1}$  sulphuric acid solution
- filter on analytical hardened filter
- complete to 250 mL with deionized water and homogenize
- remove one aliquot for P titration (cf. Sect. 29.5)
- calculate the results on the basis of soil dried at 105°C.

### *Remark*

Total P is directly linked with the content of the parent rock and the processes involved in the evolution of the soil; it provides no information about the availability of P for plants. Total P accounts for the total phosphorous balance of a natural soil and the evolution of a cultivated soil undergoing regular fertilization. It enables monitoring of P enrichment or of exports by different processes such as harvesting, erosion or leaching.

## **29.3 Fractionation of Different Forms of Phosphorus**

### **29.3.1 Introduction**

Analysis of total P sheds no light on the complex chemical and microbiological mechanisms that modify the forms of P. The organic fraction can vary between 20% and 80%. The different forms of P are usually present in too small quantities and are too finely differentiated to be easily detected with instrumental methods like XRD, IR spectrometry (cf. Chap. 4 and 5) or differential thermal analysis (cf. Chap. 7). Direct methods using electronic microscopy and EDX probes (cf. Chap. 8) are useful for detailed studies of mineralogical evolution but are not a reliable test of potential fertility.

Indirect methods use extraction reagents following a precise procedure which enables titration of solubilized forms of P. Some sequential methods make it possible to isolate different representative pools. Reagents modify

the chemical equilibria of the soil. Buffered or not-buffered media can be used. The selectivity of these methods varies with the type of soil and with farming practices, making it possible to define the general tendency of the P reactions as a function of climate and of biogeochemical processes. Farming experimentation is the method of choice to identify correlations between plant yields and extracted forms of P and to define the assimilability of P in a given area. Most plants are known to assimilate P in the  $\text{H}_2\text{PO}_4^-$  and/or  $\text{HPO}_4^{2-}$  forms contained in the soil solution but this depends on the pH. Organic P has sometimes been considered to be a direct source for plants, but this issue is very controversial. The complex process of plant assimilation involves enzymes (e.g. phosphatases) in contact with the rootlets that are able to release *ortho*-P. In the rhizosphere, exchanges between pools are rather rapid at least until equilibrium of the soil solution has been reached.

### 29.3.2 Sequential Methods

#### *Principle*

These methods allow some petrologic, mineralogical, biogeochemical or agronomic mechanisms to be revealed by measuring the differences in solubility of inorganic- or organic-P in “selective” reagents. Many attempts have been made (particularly the Chang and Jackson method, 1957) to measure the inorganic forms of P and the transformation of P added in the form of amendments or fertilizer. The reagents used enable separation of P fractions assumed to be bound to aluminium, iron or calcium and two fractions of P occluded in iron-aluminium complexes. But some reagents are not specific enough. In particular, the use of ammonium fluoride in calcareous soils often causes the precipitation of calcium fluoride from calcium carbonate and leaching of P which is then found in another form.

The methods of Williams et al. (1967) and Syers et al. (1972) improved specificity by modifying the nature and concentration of some reagents. Unfortunately, these methods are very time consuming and do not account for organic P which predominates in the soil and plays a major role in the P cycle.

A more complex method was developed by Hedley et al. (1982) that makes it possible to split soil P into six pools including organic and inorganic forms. Treatment with chloroform causes lysis of microbial cells, providing an additional biochemical dimension. The technique can

be used to identify the equilibriums of the forms of soil P in long fallow systems and long-term experiments, but also in short-term incubation tests or crop trials in the greenhouse. In this way short-term dynamics can be quantified then extended to try and explain long-term transformations.

### **Equipment**

- 0.1 mm mesh sieve
- small mesh nylon bags (for the resin)
- centrifuge and 50 mL centrifugation tubes with screw caps
- shaker
- ultrasonic tank
- micro-wave furnace for mineralization with 50 mL Teflon bottle
- lab glassware.

### **Products**

- Deionized water
- Dowex 1 8X50 anionic resin in bicarbonate form (or similar)
- 0.5 mol (NaHCO<sub>3</sub>) L<sup>-1</sup>, sodium hydrogen carbonate
- chloroform, CHCl<sub>3</sub>
- analytical filters
- 0.1 mol (NaOH) L<sup>-1</sup>, sodium hydroxide
- 1 mol (HCl) L<sup>-1</sup>, hydrochloric acid
- perhydrol
- concentrated sulphuric acid.

### **Sample**

Organic phosphorus can be modified by air drying and prolonged crushing. It is recommended to use soil samples that have been stored in their natural moisture at -40°C before analysis. The samples should then be rapidly dried in a thin layer in the air and then crushed to 2 mm. One aliquot should be crushed to 0.1 mm.

Residual moisture should be measured on another sample specimen to calculate all the results on the basis of soil dried at 105°C.

### **Procedure**

- Weigh two 0.5 g soil samples crushed to 0.1 mm (cf. “Products” in Sect. 29.3.2) and put the two samples (A and B) in 100 mL centrifugation tubes with screw caps
- add a nylon bag containing 0.4 g of anion exchange resin
- add 30 mL of water; shake for 16 h at 24°C
- remove the nylon bag and rinse it to recover all the soil
- centrifuge the water/sample mixture and discard the supernatant
- phosphorus fixed on the resin is the most biologically available inorganic P, similar to P in the soil solution. The resin can either be (i) destroyed by attack with a strong acid (perchloric acid) or (ii) extracted by exchange with 10 mL of a 10% NaCl solution at 80°C (cf. “Procedure” in Sect. 29.3.2); complete the extraction or attack solution to 50 mL with deionized water This is compartment 1, “resin extractable P”.

The soil residue is used for subsequent extraction. It can be stored wet for 24 h at 24°C without closing the tubes to ensure incubation in sufficiently oxygenated medium.

### **Sample A**

- To residue A from the resin extraction, add 30 mL of the 0.5 mol (NaHCO<sub>3</sub>) L<sup>-1</sup> solution and shake for 16 h at 24°C
- centrifuge and filter the supernatant which contains labile inorganic and organic P with a little P of microbial origin. Discard the soil residue
- bring the liquid to 50 mL by neutralizing with 5 mL of 4 mol L<sup>-1</sup> sulphuric or perchloric acid. This is compartment 2A, “bicarbonate extractable P”.

### **Sample B**

- To residue B from the resin extraction, add 1 mL of chloroform
- close the tube and agitate for 1 h
- evaporate chloroform overnight
- add 30 mL of the 0.5 mol (NaHCO<sub>3</sub>) L<sup>-1</sup> solution
- shake for 16 h at 24°C
- centrifuge and filter the supernatant
- bring to 50 mL by neutralizing with 5 mL of 4 mol L<sup>-1</sup> sulphuric or perchloric acid. This is compartment 2B, “Chloroform–bicarbonate extractable P”
- calculate the P resulting from microbial lysis by difference:  
[compartment 2B-P] – [compartment 2A-P].

Perform the following sequential extraction on soil residue B:

- Add 30 mL of the 0.1 mol (NaOH) L<sup>-1</sup> solution; shake for 16 h at 24°C
- centrifuge and filter the supernatant which contains inorganic and organic P retained by chemisorption of iron and aluminium compounds at the surface of the particles; bring to 50 mL while neutralizing as previously. This is compartment 3, “diluted soda extractable P”.

Again place the soil residue in contact with 20 mL of the 0.1 mol (NaOH) L<sup>-1</sup> solution and subject it to ultrasound for 2 min in a tank containing melting ice. Complete the volume to 30 mL with the 0.1 mol (NaOH) L<sup>-1</sup> solution and shake for 16 h at 24°C. Centrifuge and filter the supernatant which contains inorganic and organic P retained on the internal surfaces of the soil aggregates. Bring to 50 mL while neutralizing. This is compartment 4, “ultrasound-assisted diluted soda extractable P”.

Put the soil residue in contact with 30 mL of the 1 mol (HCl) L<sup>-1</sup> solution. Shake for 16 h, centrifuge and filter the supernatant which contains apatitic minerals and also some inorganic and organic P occluded in the weathered soils. Bring to 50 mL with deionized water. This is compartment 5, “hydrochloric acid extractable P”.

Subject the residual soil to oxidizing acid mineralization using a mixture of sulphuric acid and perhydrol (or perchloric acid, cf. Sect. 29.2.2) for 3 h. This enables solubilization of stable forms of organic P and not easily soluble forms of inorganic P. Cool, filter and bring the filtrate to 50 mL with deionized water. This is compartment 6, “Residual P”.

For analysis of each extract, take:

- one aliquot at the concentration suitable for P titration by spectrophotometry (cf. Sect. 29.5.2); this method should be used to titrate only the *ortho*-P form;
- one aliquot which will be mineralized by sulphuric acid plus perhydrol before titration in order to obtain total P (organic + inorganic; mineralization need not be performed in the case of inductively coupled plasma spectrographic titration of organic plus inorganic-P). In this way organic P can be distinguished by difference. Titration should be carried out without delay to limit hydrolysis.

In compartment 1 “Resin extractable-P” and in the final soil residue, it is difficult to separate the organic and inorganic forms which comprise medium and long-term reserves.

### **Remarks**

This method is time consuming and cannot be used for routine agronomic tests, but may be useful for research programs that include plant tests or soil incubation.

A correction factor of microbial P suitable for the soil type is often used to estimate total bacterial and fungic microbial flora.

The spectrophotometric method used is that of Murphy and Riley (1962) or with later improvements. This method is specific to *ortho*-phosphates and allows inorganic and organic forms of P to be distinguished. Separation is satisfactory in spite of the risk of hydrolysis of the organic forms.

Direct determination of soil total P (cf. Sect. 29.2) makes it possible to check summation of the extracted forms.

The forms of organic P present in the bicarbonate, soda and soda-ultrasound extracts have molecular weights <30,000. In the "residual soil" compartment, organic P is included in molecules of weights ranging between 30,000 and 70,000 which may correspond to the humin fractions (cf. Chap. 11).

### **29.3.3 Selective Extractions – Availability Indices**

#### ***Presentation of the Methods***

These methods are based on a single extraction of inorganic *ortho*-P with a reagent carefully chosen to dissolve specific available form of P. These methods are only suitable for mediums with acid or basic pH, either for soil chemistry studies or for simple fertility tests.

The soil may come from uncultivated land or intensively cultivated land ploughed regular, and include the reuse or not of plant residues, inputs of more or less soluble fertilizer (for rectification, maintenance, correction of deficiencies) which seriously disturb the dynamics of P turnover and influence the agricultural management of soils. The terminology used for the evaluation of the different extracted forms varies considerably reflecting the complexity of the phenomena of distribution and exchanges of P in the soil, and the intensity of the inter-compartmental flows that determine the dynamics of the system.



- These methods enable quantification of two categories of P forms:
- mobile P forms from weak chemical bonds, called active, easily removable, available, exchangeable, extractable, easily hydrolyzed, unstable, soluble or usable P forms, depending on the author;
  - not easily removable and/or strongly adsorbed P forms from chelation bonds, calcium or iron P inclusion, occluded organic and inorganic P, biomass P, P fixed to the lattice.

**Table 29.1.** Some reagents used for P extraction in soil

Type	method, extracting reagent	author(s)
miscellaneous	water, anionic resin, $^{32}\text{P}$ or $^{33}\text{P}$ isotopic dilution, electro-dialysis, electro-ultrafiltration	
extraction with complexing agents	EDTA, $\text{NH}_4\text{HCO}_3$ , + DTPA pH 7.6	Soltanpour
extractions at basic pH	$\text{NaOH}$ , $\text{KOH}$ , $\text{NH}_4\text{OH}$ , $\text{Na}_2\text{CO}_3$ , $\text{NaHCO}_3$ pH 8.5 $\text{K}_2\text{CO}_3$ , $(\text{NH}_4)_2\text{CO}_3$	Olsen Michigan
extraction with organic acids and their salts	acetic acid – ammonium or sodium acetate at pH 2.5 and pH 4.8 citric acid – ammonium citrate	Morgan Dyer (1894) Demolon (1932) NF X31-160 (1993)
	lactic acid – ammonium or calcium lactate oxalic acid – ammonium oxalate	Joret and Hébert (1955) NF X31-161 (1993)
	thioglycolic acid + $\text{NH}_4\text{F}$ acetic acid + ammonium lactate	Egner-Riehm
extraction with strong inorganic acids and their salts	$\text{HCl}$ + $\text{H}_2\text{SO}_4$	Mehlich (no. 1) (1953)
	$\text{HCl}$ + $\text{NH}_4\text{F}$	Bray and Kurtz (1) (1945)
	$\text{H}_2\text{SO}_4$ 0.001 mol $\text{L}^{-1}$ pH 3.0	Truog
	0.01 mol $\text{L}^{-1}$ pH 2.0	Peech
	0.005 mol $\text{L}^{-1}$	Keer
	$\text{CaSO}_4$ 0.005 mol $\text{L}^{-1}$	Stieglitz
	$\text{CaCl}_2$ 0.005 mol $\text{L}^{-1}$	

Many methods are available to evaluate the capacity of fixation and exchange, potential, retention, retrogradation or adsorbing capacity of phosphorus in soils.

If some terms express the mobile character of P (like exchangeable P), not all the procedures result in a selective form. In theory, a direct relationship exists between available P and the normal needs of the plant which can increase plant growth and yield (response to fertilization). However, unless a correlation has been established between the plant, the soil type and extracted P, the use of the term 'available P' is completely arbitrary.

There are many methods that use acid, basic or complexing reagents which act in different ways such as simple dissolution, iron reduction, complexation or precipitation of aluminium, iron or calcium. The most widely used reagents are buffered or not buffered strong or weak inorganic or organic acids, and a range of inorganic and organic bases and the salts of these acids and bases (Table 29.1). Each method has an index value. The pH of the reagents is generally buffered in zones where  $\text{H}_2\text{PO}_4^-$  and  $\text{HPO}_4^{2-}$  exist, i.e. between pH 2.0 and 6.0 for acid soils and at pH 8.5 for alkaline soils. In other cases, the soil pH determines the method of extraction (e.g. water extraction, electrodialysis, electro ultra-filtration, resin extraction).

For a given reagent, a number of experimental variables can influence the dissolution process: pH, concentration, soil-to-solution ratio, contact time, temperature, particle size, agitation (ultrasounds). When results have to be compared, it is essential to ensure procedures are rigorously respected.

Water extraction gives the P concentration in the soil solution. Basic reagents enable extraction of organic and inorganic labile forms and a little microbial P at around pH 8.5. The insoluble forms bound to calcium are not really attacked by the reagent at this pH. At higher pH, P forms bound to humus are solubilized and the compounds retained by chemisorption are extracted.

Humic, fulvic acids and some humin are extracted with a hot 5 mol (NaOH)  $\text{L}^{-1}$  solution with intense colouring of the extracts.

Weak organic acids or their salts can be used to make well-buffered mediums. The extraction pH varies between 2 and 8 depending on the method. Oxalic acid-ammonium oxalate reagent can complex aluminium and iron and active calcium if precipitated. Citric acid-ammonium citrate reagent can attack the crystal lattice of silicates, precipitate calcium, attack iron compounds towards pH 5.0 and aluminium compounds from pH 3–8.

A mixture of tartaric acid and tartarates can complex iron and aluminium (pH 3.2–7.5). A mixture of lactic acid and lactates preferentially extracts P bound to calcium, and only a little P bound to iron or aluminium (pH 3.5–3.7). Mixtures of boric acid and borates and of acetic acid and acetates at pH 2.5 or 4.8 extract only a little P.

Diluted strong inorganic acids can solubilize P bound to calcium, and varying quantities of P bound to iron and aluminium. The pH generally ranges from 1 to 3 (apatite P, occluded P, weathered soils). The effectiveness of the extraction (which is not linked with farming practices) depends on the type of acid in the lyotropic series  $\text{H}_2\text{SO}_4 > \text{HCl} > \text{HNO}_3$ . For example, HCl facilitates the separation of P from organic colloids (rupture of the bonds of polyvalent salts). Strong acids cause hydrolysis of organic P which is not easy to control. Hydrofluoric acid can solubilize organic and inorganic P by attacking the silicate lattices. Ammonium fluoride and fluorhydric acid can complex aluminium and iron in acid soils, but cannot be used in a calcareous medium because of the random precipitation of calcium fluoride (Syers et al. 1972):

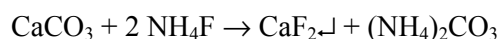

The calcium fluoride that is formed results in underestimation of the P not occluded in iron and P bound to aluminium, and overestimation of P occluded with iron oxides and iron hydroxides, and of P bound to calcium.

Sequestering agents like EDTA or DTPA, enable solubilization of P bound to oxides and hydroxides of aluminium and iron, and to different forms of calcium. The reaction is generally slow, except in the labile forms.

### **Equipment**

Except for a few minor details (like size of the centrifugation tubes), similar equipment is required for all methods of section 29.3.3 explained later:

- analytical balances ( $\pm 1/10$  mg)
- 100 and 250 mL centrifugation tubes with screw caps
- shaker
- centrifuge
- long-stemmed Pyrex funnels for filtration
- 20 mL syringe for filtration
- lab glassware
- stainless steel sieve  $\varnothing$  50, 0.25 mm mesh standard AFNOR NF 25 (cf. recovery of resin in the following “Procedure”).

## **Water Soluble P**

### *Principle*

The method of extraction in water (or in 0.01 mol L<sup>-1</sup> solution of calcium chloride or calcium sulphate) enables evaluation of a P concentration close to that in the soil solution and of possible thresholds of deficiency.

The permanent turnover of P in the soil solution is very important for plant nutrition throughout the vegetative cycle. It is ensured by the action of micro-organisms and enzymes like phosphatases. If the kinetics of P input in the soil solution is lower than the transfer to the plant of the quantity of P required for normal growth (deficiency threshold), there will be a reduction in plant activity (e.g. dwarfism).

### *Equipment and Reagents*

- Deionized water
- disc-filters or 0.22 μm membrane for syringe
- very fine analytical filters
- 0.01 mol L<sup>-1</sup> calcium chloride solution
- 0.01 mol L<sup>-1</sup> calcium sulphate solution (solubility 2.09 g L<sup>-1</sup>).

### *Procedure*

- Weigh 5 g of air-dried soil (2 mm particle size) in a centrifugation tube with a screw cap; add 50 mL of deionized water and shake for 5 min
- centrifuge for 15 min at 10,000g until the liquid is clear; filter on very fine analytical filter (blue) or on a 0.22 μm filter placed in the 20 mL syringe; remove an aliquot containing approximately 10 μm of P to analyse water soluble P (cf. Sect. 29.5).

**Remarks.** If the soil solution is obtained in situ using low-pressure microporous tubes, the concentration will be very close to that of the solution in contact with the plant roots; however, this requires the installation of equipment at field stations, which limits its use. Climatic conditions make sampling impossible at certain periods of the year in particular in arid areas, when the equilibrium between “soil solution P” and “labile inorganic P” is modified or non-existent as is the activity of micro-organisms.

### ***Sodium Bicarbonate Extractable P at pH 8.5 (Olsen)***

#### ***Principle***

When extracted with this method, P corresponds to the most biologically available forms of P, i.e. labile organic and inorganic forms and includes a fraction of microbial P.

This method can be used for basic, neutral or acid soils. The extracting agent decreases the concentration of the calcium in solution by precipitating insoluble calcium carbonate. The solubility of calcium phosphates increases with a decrease in calcium activity (effect of liming on P availability). The reagent extracts part of labile organic P and of inorganic P bound to calcium. In acid soils, phosphates of iron and aluminium (strengite–variscite) become more soluble with an increase in pH, with an optimum towards pH 6–7 where levels of  $\text{H}_2\text{PO}_4^-$  and  $\text{HPO}_4^{2-}$  forms are the same. In the Olsen method, which was modified by Dabin (1967), ammonium fluoride is added. This reagent enables iron and aluminium to be complexed and thus a greater quantity of P to be solubilized. In certain tropical soils with low calcium content, extracted P is better correlated with plant yields.

#### ***Reagents***

- 0.5 mol  $\text{L}^{-1}$  solution of sodium bicarbonate ( $\text{NaHCO}_3$  mw = 84.01): adjust to pH 8.5 with a 1 mol ( $\text{NaOH}$ )  $\text{L}^{-1}$  solution; the solutions should be freshly made and stored in hermetically sealed bottles.
- P-free activated carbon (DARCO 60, or similar), if necessary for controls purify with a 2 mol ( $\text{HCl}$ )  $\text{L}^{-1}$  solution then with  $\text{NaHCO}_3$  reagent and rinse with deionized water.

#### ***Procedure***

- Weigh 5 g of air-dried soil (2 mm particle size); put in a 250 mL centrifugation tube.
- add 100 mL of sodium bicarbonate reagent; shake for 30 min.
- centrifuge for 5 min at 10,000 g and filter (adding P-free activated carbon enables a clear and colourless filtrate to be obtained for colorimetric analysis, however this addition should not be systematic but should be reserved for samples where the extraction solution is still turbid after filtration); remove one aliquot for titration after neutralisation (cf. Sect. 29.5).

### ***Anion Exchange Resin Extractable P***

#### ***Principle***

Resins enable extraction of most biologically available forms of inorganic P. Varying the contact time can also provide information on the kinetics of P extraction. An anion exchange resin with a particle size greater than 0.5 mm should be used.

#### ***Reagents***

- Anion exchange resin (e.g. Dowex 1X8-50) in bicarbonate form
- anion exchange resin (Dowex 2) in chloride form
- resin fractions should have a particle size equal to or higher than 0.5 mm, check by sieving wet. Discard the finest particles
- 10% sodium chloride solution.

#### ***Procedure***

- Weigh 5 g of air-dried soil crushed to 0.1 mm in a 100 mL centrifugation bottle
- add 5 g of sieved resin
- add 50 mL of deionized water; shake for 16 h
- separate the resin on a sieve with a 0.250 mm mesh (AFNOR NF 25); wash with water and recover the resin on the sieve
- with a jet of water from a washing bottle, transfer the resin in a 50 mL beaker; eliminate water by decantation and add 25 mL of the 10% NaCl solution; heat in a water bath at 80°C for 45 min
- cool and decant the solution in a 50 mL volumetric flask; rinse the resin with 10% NaCl solution and bring to 50 mL; homogenize and remove one aliquot to titrate exchanged P.

**Note.** With this method P can be extracted without deteriorating the sample or modifying the soil pH and the method also enables root action to be simulated. By leaving the sample in contact for varying periods of time, precise information can be obtained on the quantity, capacity and kinetics of P. In this case the method requires prolonged contact of from 48 h to three weeks or more.

### ***Ammonium Oxalate Extractable P***

#### ***Principle***

This method (Jorret and Hébert 1955) is the subject of the AFNOR NF X31-161 (1993) standard. It can be used for all types of soil except those very rich in organic matter.

#### ***Reagents***

- Deionized water
- ammonium oxalate,  $(\text{NH}_4)_2\text{C}_2\text{O}_4 \cdot \text{H}_2\text{O}$
- 0.1 mol  $(\text{NH}_4\text{OH}) \text{L}^{-1}$  ammonia solution
- extraction solution (should be freshly made each day): dissolve 14.21 g of ammonium oxalate in 900 mL of deionized water agitating the solution with a magnetic stirrer with a Teflon bar; adjust the pH to 7.0 with the ammonia solution; transfer the solution in a 1 L volumetric flask; rinse the beaker with water and bring to 1,000 mL; homogenize.

#### ***Procedure***

- Weigh 5 g of air-dried soil (particle size 2 mm) and put in a 250 mL centrifugation tube with a screw cap; add 100 mL of ammonium oxalate solution at 20°C; shake for 2 h
- filter the extract which should be clear and titrate P on an aliquot fraction (in the presence of  $\text{As}^{5-}$ , arsenic interference can be eliminated by reducing  $\text{As}^{5-}$  to  $\text{As}^{3-}$  by adding sodium hyposulphite, and formol to clarify the solution).

### ***Double Acid Extractable P (HCl–H<sub>2</sub>SO<sub>4</sub>)***

#### ***Principle***

This method was developed by Mehlich (1953) for acid soils (North Carolina, USA) that fix P vigorously and have low organic matter content. It is used as a basic method for testing soil in fertilization studies like the methods of Bray (1945) and Olsen (calcareous soils).

It uses a mixture of hydrochloric and sulphuric acid which is considered to be more effective than hydrochloric acid alone for extraction of P linked with the response of plants cultivated on soils rich in iron phosphate. The method is simple, fast and reproducible, but cannot be used in calcareous soils because of random neutralization of the extraction solution.

### *Reagents*

- Deionized water
- concentrated sulphuric acid,  $\text{H}_2\text{SO}_4$  *d*: 1.84
- concentrated hydrochloric acid,  $\text{HCl}$  *d*: 1.19
- extraction solution: mix 6 mL of concentrated sulphuric acid and 36 mL of concentrated hydrochloric acid in approximately 7.5 L of deionized water; bring the volume to 9 L (the extraction solution is  $0.05 \text{ mol (HCl) L}^{-1}$  and  $0.025 \text{ mol (1/2H}_2\text{SO}_4) \text{ L}^{-1}$ )
- activated carbon (DARCO G6 or similar) (free from P)
- analytical filters.

### *Procedure*

- Weigh 5 g of air-dried soil (2 mm particle size) in a 50 mL centrifugation tube; add 200 mg of activated carbon, then 20 mL of extraction solution
- shake for 5 min and filter on analytical blue filter or with a syringe equipped with a 0.45 or 0.20  $\mu\text{m}$  filter-membrane; remove one aliquot for P titration.

## ***Ammonium Fluoride Hydrochloric Acid Extractable P***

### *Principle*

The first method proposed by Bray (1945) was based on solubilization of P compound in acid and on the action of fluoride anion to reduce the activity of the  $\text{Al}^{+++}$  cation and of  $\text{Fe}^{+++}$  and  $\text{Ca}^{++}$  cations by forming complexes.

It is used for neutral and acid soils, but cannot be used in calcareous soils (random neutralization of the reagent, dissolution of calcium carbonate and precipitation of calcium fluoride). Repeatability depends on how rigorously the procedure is respected.

### *Reagents*

- Deionized water
- $0.5 \text{ mol (HCl) L}^{-1}$  hydrochloric acid solution: add 20.3 mL  $\text{HCl}$  in 500 mL of deionized water
- ammonium fluoride  $\text{NH}_4\text{F}$
- $1 \text{ mol (NH}_4\text{F) L}^{-1}$  solution: dissolve 37 g of ammonium fluoride in 400 mL of deionized water in a plastic beaker; dilute and bring to 1,000 mL; homogenize and store in a polyethylene bottle
- extraction solution: mix 30 mL of the  $1 \text{ mol (NH}_4\text{F) L}^{-1}$  solution and 50 mL of the  $0.5 \text{ mol (HCl) L}^{-1}$  solution. Bring to 1,000 mL with deionized water. The solution contains  $0.025 \text{ mol (HCl) L}^{-1}$  and  $0.03$



mol (NH<sub>4</sub>F) L<sup>-1</sup>, the pH is 2.6; the reagent is stable if stored in a polyethylene bottle.

#### *Procedure*

- Weigh 2 g of air-dried soil (particle size 2 mm) in a 50 mL centrifugation tube
- add 20 mL of extraction solution at pH 2.6 and shake for 5 min on an oscillating shaker (regulated at 180 oscillations per minute)
- immediately filter on fine analytical paper (blue) or with a syringe equipped with a 0.45 or 0.20 µm filter membrane. Titrate P on one aliquot of this solution.

**Remarks.** The action of ammonium fluoride enables aluminium and ferric phosphates to be dissolved with the formation of aluminium and iron complexes, the forms bound to calcium should be extracted by the action of acid.

A number of modifications aimed at obtaining a better correlation of P extracts with plant yields, either by increasing the volume of extracting reagent, or by increasing the extraction time from 1 to 5 min. Reproducibility is difficult to ensure with contact times under 5 min, and the procedure is difficult to implement without automation, for example agitation on site with filtration by aspiration on 0.20 µm micro-membrane.

### **29.3.4 Isotopic Dilution Methods**

Methods for the study of fertilization based on <sup>32</sup>P isotopic dilution appeared in the 1950s (Dean et al. 1947).

Different techniques were developed to estimate the quantity of P isotope exchange by means of a plant test (L value, Larsen 1952) or to measure the flow of phosphate ions per unit of time in a soil-solution system (E value, Gunnarson-Frederickson 1952).

This method gives a good estimation of the bioavailability of P in the soil and the sediments. Bioavailable phosphorus was defined (Fardeau 1997) as “all phosphorus that can move into the soil solution in the form of phosphate ions in a time that is compatible with the requirements of the growing plant”.

The method of kinetics of <sup>32</sup>P exchange with stationary systems enables factors of intensity (concentration of P in the soil solution), quantity and capacity to be identified by measuring the ions transferred from the solid phase to the liquid phase in 1 min, one day, three months, one year or even longer, however, without providing precise details on the mineralization of the organic matter.

These methods require special laboratory management for the handling of labelled substances. To obtain a high degree of accuracy, it is necessary to eliminate fine particles in suspension, which means centrifugation at more than 100,000g or filtering on 0.01  $\mu\text{m}$  membranes. Measurements are taken without modifying the state of the system making it possible to quantify labile forms.

These methods also require special equipment like a liquid scintillation counter or a 120,000g ultracentrifuge. Tracer techniques should be implemented away from other activities in which isotopic tracers are naturally abundant to avoid possible contamination. P tracer procedures are described in detail in Fardeau (1988–1993) and Gachon (1988).

### 29.3.5 Determination of Organic Phosphorus

#### *Introduction*

The study of organic P is extremely complex due to the diversity of the organic forms, but also because permanent transformation occurs under the influence of micro-organisms. Biological turnover results in biochemical and chemical reactions between the plant and the soil. Mineralization and immobilization reactions occur with respect to clays and oxides, and during the course of soil genesis these differentiate the compartments where P exists in forms of varying degrees of availability.

Depending on the type of soil, climatic conditions and the activity of micro-organisms, organic phosphorus can represent from 20% to 80% of total P. Specific compounds can be found inside this P compartment; the most common forms being inositol phosphate, which can represent more than half organic P, phospholipides (approximately 5%) and nucleic acids (approximately 2%).

All these forms are difficult to analyse because they hydrolyze with varying degrees of difficulty. Methods like nuclear magnetic resonance ( $^{31}\text{P}$ -NMR) make it possible to identify the molecular structure of some simple products if they are sufficiently abundant. But NMR is not very sensitive ( $10^{-5}$  g approximately), is expensive and consequently not suitable for repetitive analysis. Other methods have been developed which can be classified in two main groups: overall estimation of organic P by calcination, in which the organic matter is destroyed (cf. "Measurement of Organic P by Thermal Destruction") or solubilization and extraction in acid and base solutions (cf. "Extraction of Organic P in Acid and Base Reagents").

### ***Measurement of Organic P by Thermal Destruction***

#### ***Principle***

Organic P is converted into inorganic P by calcination and estimated by difference:

$$\text{organic P} = \text{inorganic P of burnt soil} - \text{inorganic P of untreated soil.}$$

This method is simple and fast, but its precision is low due to (i) hydrolysis of organic P during extraction in untreated soil and (ii) the error transmitted during calculation by difference (Pansu et al. 2001).

#### ***Equipment***

- Muffle furnace
- porcelain or quartz crucibles 45 mm in diameter
- 100 mL polyethylene centrifugation tubes with screw caps
- centrifuge
- filtration rack
- analytical hardened filters
- lab glassware.

#### ***Reagent***

- 0.5 mol (H<sub>2</sub>SO<sub>4</sub>) L<sup>-1</sup> sulphuric acid solution.

#### ***Procedure***

##### **(1) Calcination extract**

- Weigh 1 g of soil crushed to 0.1 mm in a porcelain or quartz crucible
- place in a cold furnace and gradually raise the temperature to 550°C in oxygenated medium; maintain this temperature for 2 h
- let the crucible cool, transfer the soil residue in a 100 mL centrifugation tube (A); add 50 mL of the 0.5 mol (H<sub>2</sub>SO<sub>4</sub>) L<sup>-1</sup> solution.

##### **(2) Direct extract**

- Weigh 1 g of soil crushed to 0.1 mm in a 100 mL centrifugation tube (B)
- add 50 mL of the 0.5 mol (H<sub>2</sub>SO<sub>4</sub>) L<sup>-1</sup> solution.

### (3) Extraction

- Close the A and B tubes and shake for 16 h
- centrifuge at 5 000 g for 10 min
- filter on hardened filter and store a suitable aliquot in a plastic bottle for P titration. Organic P is calculated by difference: P of burnt soil minus P of the unheated sample (these results are compared to total P to estimate inorganic P).

**Remarks.** Soil should be calcinated in a well-oxygenated furnace to avoid losses by reduction which can occur above 400°C (H3P).

The final temperature and calcination time must be respected to avoid modifying the relative solubility of the products obtained at this temperature as this would cause random estimates of organic P.

### ***Extraction of Organic P in Acid and Basic Reagents***

#### ***Principle***

These methods (Mehta et al. 1954) extract the organic and inorganic P forms chemically (sequential treatments with strong acid and strong base).

Pretreatment with strong acids enables the polyvalent bonds to be broken and the bound cations to be extracted (mostly Fe, Al and Ca) which makes inorganic P insoluble, with the hydrolysis of organic compounds as a side effect. The alkaline treatment that makes it possible to solubilize the organic matter also causes hydrolysis of organic P.

Mineralization is performed on one aliquot of the extract; organic phosphorus is transformed into *ortho*-phosphates and estimated by difference:

organic P = inorganic P after mineralization – inorganic P in the initial extract.

#### ***Equipment***

- Aluminium mineralization block or rack for the attack
- 100 mL polyethylene centrifugation tube with a screw cap
- Water bath heated to 70–90°C
- vortex stirrer
- ventilated drying oven heated to 100°C.

### *Reagents*

- Concentrated hydrochloric acid
- 0.5 mol (NaOH) L<sup>-1</sup> aqueous solution
- deionized water.

### *Procedure*

#### Extraction:

- Weigh 1 g of air-dried soil (0.1 mm particle size) in a 100 mL centrifugation tube
- add 10 mL of concentrated hydrochloric acid; homogenize and heat in a water bath for 10 min at 70°C
- add another 10 mL of concentrated hydrochloric acid and leave in contact for 1h at ambient temperature; add 50 mL of water; homogenize and centrifuge at 5,000 g for 5 min
- decant the supernatant in a 250 mL volumetric flask; wash the centrifugation pellet with a little water and centrifuge for 5 min; decant in the same 250 mL volumetric flask
- treat the soil residue with 30 mL of 0.5 mol (NaOH) L<sup>-1</sup>; suspend by shaking energetically with the vortex stirrer and leave in contact for 1 h at ambient temperature
- centrifuge and decant the supernatant in the volumetric flask containing the hydrochloric extract (decant very gradually while homogenizing)
- add another 60 mL of the 0.5 mol (NaOH) L<sup>-1</sup> solution to the residue, suspend by shaking energetically with the vortex stirrer and maintain at 90°C for 8 h in the water bath or in a ventilated drying oven
- centrifuge; after complete cooling transfer the supernatant in the 250 mL volumetric flask containing the other extracts; complete the volume with deionized water and homogenize; this is solution (A).

#### Mineralization of total extracted P:

- Shake solution A to put the precipitated materials in suspension and quickly remove a 5 mL aliquot in a Pyrex tube that fits in the mineralization block (or use a tall form beaker)
- add 2 drops of concentrated sulphuric acid and 1 mL of 72% perchloric acid
- homogenize, cover with a watch glass and mineralize until white smoke appears; leave to digest for 30 min at 200°C
- cool and transfer in a 50 mL volumetric flask while rinsing with deionized water, complete to 50 mL.

If the soil has a high P content, take a suitable aliquot for titration; for low P content use a volumetric flask for P analysis.

#### Inorganic and organic P analysis:

- Let solution A decant; take an aliquot of supernatant, filtrate and titrate inorganic P as above
- organic P is calculated by the difference between total P titrated in the mineralized extract and inorganic P titrated in extract A (spectrocolorimetry, cf. Sect. 29.5.2).

#### Remarks:

- The extracts of soils with high humus content may be coloured. They should then be treated with activated carbon (Darco 60 free from P)
- hydrochloric acid treatment can cause hydrolysis of phosphorous esters, e.g. glycerophosphates
- about 80% of P is extracted by this method (to be compared to total P extracted by perchloric acid attack)
- the 16 h extraction can be replaced by a shorter treatment using ultrasound
- organic P is underestimated as a consequence of hydrolysis, and the results obtained by difference are not very precise
- the percentage of total organic P can be linked to soil microbial biomass and to the activity of micro-organisms, and can reveal transport of P by plants with a vertical distribution of P that is modified by the deposit of organic residues at the surface of the soil.

## 29.4 Retention of Phosphorus

### 29.4.1 Introduction

Soil cultivation results in exports of phosphorous from the soil to harvested crops and in the relatively long term, a deficiency in fertilizing elements. This decrease in available elements is partly due to acceleration of carbon mineralization which accompanies farming practices, and the organic matter content is significantly reduced.

Fertilization enables a satisfactory level of available P to be maintained for plant growth and the flows of phosphorus to be regulated. To maintain the equilibrium of inputs in phosphate-enriched fertilizers, it is necessary to estimate exports, and also to determine the capacity of a soil to retain and restore P.

Anions can be bound on exchange sites and play a role in the anion exchange capacity (AEC, cf. Chap. 27). Generally the AEC is much lower than the CEC (cf. Chap. 26), and depends on the soil pH, electrolyte level and type of clay. The lyotropic series:  $\text{SiO}_4^{4-} > \text{PO}_4^{3-} > \text{SO}_4^{2-} > \text{NO}_3^- \cong \text{Cl}^-$  shows that  $\text{SiO}_4^{4-}$  and  $\text{PO}_4^{3-}$  are strongly adsorbed in acid soils as a consequence of the  $\text{PO}_4^{3-}$  bonds with octahedral aluminium. Phosphates remain insoluble and not easily usable for plants. This is the phenomena of (i) "P retention" which can be measured by extraction in a highly diluted acid or (ii) "fixing of P" which represents forms of P that cannot be extracted using diluted acids.

The lower the pH, the higher the concentration of polyvalent cations (Al, Fe, Mn) and the greater the rate of P retention. The acidification process can lead to formation of insoluble P forms: variscite ( $\text{AlPO}_4 \cdot 2\text{H}_2\text{O}$ ) and strengite ( $\text{FePO}_4 \cdot 2\text{H}_2\text{O}$ ) in the soil. Silicates, arsenites, selenites, and fluorides can replace phosphate forms. In alkaline conditions, phosphates can react with different forms of calcium (especially carbonates) giving insoluble calcium phosphates which pose serious problems for the cultivation of arid carbonated soils.

Certain soils like andosols can adsorb large quantities of P. Failure to respond to fertilization and changes in the CEC (CEC can be multiplied by two or three) will be observed in these soils when they are cultivated. It is thus necessary to measure the level of P retention of the soil, to determine adsorption indices, and to establish isotherms of adsorption according to Lang-Muir or Freundlich's equation. The soils can then be classified according to their adsorption characteristics and links established between the quantities of adsorbed P in g per  $\text{m}^2$  and the concentration of the soil solution at equilibrium.

#### 29.4.2 Determination of P Retention

##### ***Principle***

The method proposed by Blakemore et al. (1981) uses equilibration of a soil sample with a solution containing soluble P, and measurement of

phosphate remaining in solution. At pH 4.6, retention of P is close to maximum.

### **Equipment**

- Centrifuge
- shaker.

### **Reagents**

- Deionized water
- solution for P retention (1,000 ppm P): dissolve 8.79 g of potassium dihydrogen phosphate and 32.8 g of anhydrous sodium acetate in about 1 L of water; add 23 mL of glacial acetic acid; complete to 2 L in a volumetric flask with deionized water.

### **Procedure**

- Weigh 5 g of air-dried soil (particle size 2 mm) and put in a 50 mL centrifugation tube with a screw cap; add 25 mL of P retention solution
- shake for 24 h at 20°C
- centrifuge at 5,000g for 15 min
- filter, homogenize and remove one aliquot for titration of P remaining in the solution, and an identical aliquot of the reagent (blank) to calculate P retention by difference. Titrate the two solutions by spectrophotometry.

**Calculation.** –Calculate P retention by difference: P in the blank minus P in the equilibration solution, and express the result as a percentage.

**Remarks.** In oxisols and lateritic soils, P is very strongly fixed at pH < 4.0 (P–Fe and P–Al bonds) and results in severe deficiencies. Iron and aluminium oxides are positively charged below the zero point charge. In allophanic soils P fixes on the surface of oxides to form P-organic matter complexes and inorganic aluminium bridges.



## 29.5. Titration of P in the Extracts

### 29.5.1 Introduction

#### *Methods*

Many methods have been developed for the titration of P. Their sensitivity is not the same and some are suitable for extracts with high P contents and other for extracts containing only traces of P.

Gravimetric methods, which are rarely used today, are based on precipitation of ammoniaco-magnesian phosphate or ammonium phosphomolybdate. Titrimetric methods may use this precipitate for dissolution in soda and back titration by acidimetry, or the precipitate can be titrated by techniques like complexometry or manganometry. The most common spectrophotometric absorption methods use a molybdo-vanadophosphoric complex which absorbs at 430 nm, or molybdenum blue which absorbs between 650 and 890 nm, depending on its composition. Sometimes these measurements are automated or even robotized.

Other physicochemical methods such as atomic absorption, amperometry, potentiometry, conductimetry, coulometry, and polarography, use indirect determination, for example via molybdenum after formation of phos-phomolybdate complex. Flame or inductively coupled plasma emission can titrate the organic and inorganic forms simultaneously, but cannot titrate them separately. These measurements are not very sensitive to P (cf. Chap. 31).

#### *Clarification of the Extracts*

Whatever the method of titration, the extracts must contain only soluble forms and no mineral or organic particles in suspension.

Filtration on a very fine blue cellulose filter (or hardened filters for very acid extracts) is often insufficient, but can be improved by recycling the first filtered fractions to partly clog the filter. Membranes with pores of about 0.45–0.20  $\mu\text{m}$  mounted on syringe filters of the Luer type are suitable. These membranes have a very low flow and quickly become clogged, but when they are equipped with a pre-filter, the membranes rapidly provide 1–2 mL of extract, which is sufficient for routine analyses and ensures satisfactory precision. For difficult cases, for example in the case of proteins, simultaneous ultracentrifugation at about 50,000–100,000g may be necessary.

Electrodialysis (or electro-ultrafiltration) is sometimes used, the breaking threshold being at about 0.02  $\mu\text{m}$ . But there is a risk of a change in pH near the electrodes inducing a risk of precipitation and excessive dilution of the sample. For very detailed research, certain authors count the residual contents of suspended particles with Laser radiation counters (Nanosizer) and check the nature of the particles with an electron microscope.

### **Types of Titration**

After the extract has been purified, the optimal zones of titration, the range of concentration, maximum sensitivity and possible interferences should be taken into account when choosing the appropriate measurement method.

Generally direct titration on the extraction solution is chosen. But it is sometimes necessary to choose the minimal volume of extract that can be measured with precision in order to limit interactions between very fine elements in suspension or in solution.

Narrow measurement cells are preferable for spectrophotometric methods if they are sufficiently sensitive. The use of 50 or 100 mm cells amplifies the effects of micro-particles in suspension making careful preliminary ultrafiltration necessary. The reactions can take place cold or hot in mediums of varying degrees of acidity or alkalinity. To limit hydrolysis of organic P, cold titration in mediums with a weak concentration at controlled pH should be used. But phytins cannot be titrated cold and some phytins are titrated at 60°C by spectrophotometry. The same goes for inorganic P in the pyrophosphate state or in other forms.

If possible, intermediate stages should be avoided as some separation treatments have random effects on results (e.g. changes in pH, contamination, resin purification of extracts, extraction of coloured compounds, additives for filtration, activated carbon which is seldom P-free).

The selectivity of the titration is important:

- spectrophotometric titrations (manual, flow injection analysis, segmented flow) are only selective for *ortho*-phosphate forms and organic forms are not titrated in the extracts
- atomic spectrometry (inductively coupled plasma or flame spectrometry) measures all forms of P; the results can be two to three times higher than with colorimetry
- $^{31}\text{P}$  nuclear magnetic resonance ( $^{31}\text{P}$ -NMR) differentiates the different P forms; *ortho*- *pyro*- and organic-P can be estimated simultaneously without destroying the sample.

## 29.5.2 Titration of *Ortho*-phosphoric P by Spectrocolorimetry

### *Spectrocolorimetry Using Molybdenum Blue*

#### *Principle*

A thorough knowledge of the chemical reactions and of possible interferences is very important for quality control. Controlled experimental conditions enable measurement of the intensity of the spectra at the optimal wavelength on a compound with a perfectly defined chemical composition (Gautheyrou and Gautheyrou 1989).

The molybdenum blue reaction must be carried out under well-defined conditions of pH, acid concentration, redox potential, temperature and reaction time to move equilibrium towards the most condensed forms, as a maximum of 12 atoms of molybdenum can surround the P atom. With this composition optical density remains constant. Only high rates of silica, arsenic and germanium interfere.

The reaction consists in combining molybdic acid with *ortho* forms of phosphorus. This condensation can only be carried out in acid medium with a high ionic force. A reducing compound catalysed by the antimonyl tartrate leads to the formation of the highly coloured blue complex of the phosphomolybdic anion.

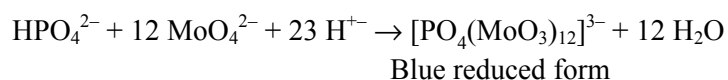

**Remarks.** The redox potential depends on the pH. It is thus necessary to standardize the procedures to ensure that the quantity of acid and reducer is as constant as possible and that the temperature remains the same. The kinetics of formation of phosphomolybdate is proportional to the concentration of P.

Many mineral and organic reducing compounds have been used.<sup>2</sup> Ascorbic acid combined with potassium antimonyl tartrate (Murphy and Riley 1962) has a strong catalytic power in cold acid medium. It enables an intense blue complex to be obtained that is stable for 24 h. A 1:1 Sb-

to-P ratio is required to obtain maximal intensity, and this ratio should not be exceeded to avoid precipitation.<sup>3</sup> Absorbance is maximal at the limit of the visible and near infrared spectra: 880–890 nm.

Sensitivity is lower in hydrochloric acid than in sulphuric acid medium. The stability of the compounds is excellent in a perchloric acid medium. A sulphuric acid concentration of from 0.15 to 0.25 mol L<sup>-1</sup> makes it possible to work at a pH below one.

**Interferences.** In the structure of a P polyanion, either oxygen atoms or the central atom can replace an element with a similar ionic radius and structural properties like Si, Ge, As, Ti. Compounds like (SiMo<sub>12</sub>O<sub>40</sub>)<sup>4-</sup> or (AsMo<sub>12</sub>O<sub>40</sub>)<sup>3-</sup> can be formed. The optimal conditions for formation of P, As or Si compounds are not identical: for P and As, the stable molybdic compound is formed specifically between pH 0.8 and 1.4. Si and Ge complexes are formed only between pH 1.8 and 2.5. It is thus necessary to carry out the reaction in sufficiently acid medium to limit interference by silicium. Arsenic is generally relatively problem free. Interferences can also be caused by:

- elements that can replace molybdenum, for example tungsten which has an ionic radius of 0.60 Å close to that of molybdenum (0.59 Å), or vanadium (0.58 Å)
- elements that catalyze the reaction (Sn, Sb, Bi) whose action is synergistic during reduction (as the contents of these elements in the soil are low, this type of interference is not very significant)
- elements with coloured salts: the presence of Cr<sup>3+</sup>, Ni<sup>2+</sup>, Ni<sup>4+</sup>, Cu<sup>2+</sup>, Mn<sup>2+</sup>, Mn<sup>4+</sup>, Fe<sup>3+</sup> is tolerable up to approximately 1,000 mg L<sup>-1</sup> (although organic matter absorbs at another wavelength, it can cause interference by reducing radiation transmission and should consequently be destroyed)
- elements that are likely to precipitate in the medium resulting in insoluble compounds
- oxidizing elements that interfere with the reduction reaction

---

<sup>2</sup> For example 1 amino 2 naphthol 4 sulphonic acid, ascorbic acid, SnCl<sub>2</sub>, diamminophenol, hydrazine, hydroquinone, thiourea

<sup>3</sup> Solubility is improved by heating, but there is a risk of hydrolysis of organic P compounds.

- organic acids are able to complex molybdenum (e.g. oxalic acid and oxalates, tartaric acid and tartrates, citric acid and citrates); if the pool extracted by these reagents has to be analyzed, the matrix should be destroyed to avoid obstruct the phosphomolybdic reaction
- alcohols in which potassium antimonyl tartrate is not very soluble
- proteins which can precipitate slightly.

### Equipment

- Spectrocolorimeter usable in the 800–900 nm zone
- 10–100 mm measuring cells.

### Reagents

- 2.5 mol (H<sub>2</sub>SO<sub>4</sub>) L<sup>-1</sup> sulphuric acid: carefully add 140 mL of concentrated sulphuric acid in 900 mL of deionized water; let cool and complete to 1,000 mL
- ammonium molybdate solution: weigh 20 g of (NH<sub>4</sub>)<sub>6</sub>Mo<sub>7</sub>O<sub>24</sub> and dissolve in 500 mL of deionized water (prepare fresh each week)
- hemihydrate potassium antimonyl tartrate solution K<sub>2</sub>SbO(C<sub>4</sub>H<sub>4</sub>O<sub>6</sub>)<sub>2</sub>·0.5H<sub>2</sub>O

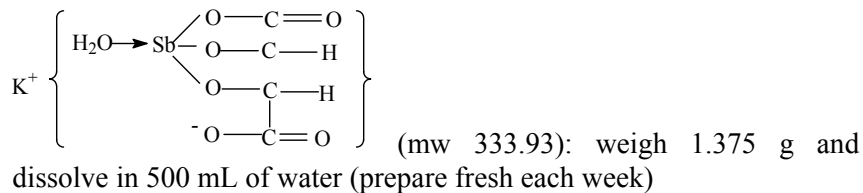

- ascorbic acid solution

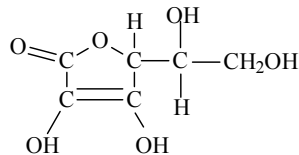

- : dissolve 8.75 g of ascorbic acid in 500 mL of deionized water (prepare fresh each day)
- mixed reagent: mix in the order below, agitating and homogenizing between each addition: 165 mL of 2.5 mol (H<sub>2</sub>SO<sub>4</sub>) L<sup>-1</sup> solution, 50 mL of ammonium molybdate solution, 100 mL of ascorbic acid solution, 16 mL of potassium antimonyl tartrate solution, complete to 100 mL with deionized water (prepare fresh each day).

**Phosphate Standards.** For each type of extract, it is better to prepare the calibration range in the same medium as the samples to be analyzed and to systematically (i) make a blank just with reagents subjected to the

same treatments as the samples, (ii) regularly reconstruct the calibration range and compare it with the previous range to detect any temporal drift, or possibly modifications which could reduce precision.

- 100  $\mu\text{g (P) mL}^{-1}$  stock solution: dissolve 0.4393 g of dihydrogen potassium phosphate ( $\text{KH}_2\text{PO}_4$ ) in deionized water and complete to 1,000 mL; 1 mL contains 100  $\mu\text{g}$  of P; store in the refrigerator protected from the light
- intermediate solution (A) 10  $\mu\text{g (P) mL}^{-1}$  (can be stored in the refrigerator for one week): dilute 100 mL of stock solution in 1,000 mL of deionized water.
- intermediate solution (B) 1  $\mu\text{g (P) mL}^{-1}$ : dilute 100 mL of intermediate solution (A) and complete to 1,000 mL (prepare before each series) with deionized water.
- calibration ranges suitable for each method: each day prepare the volume required for the analytical apparatus to be used, 50 or 100 mL. 0.0 (blank), 0.1, 0.2, 0.4, 0.6, 0.8, 1.0, 2.0  $\mu\text{g (P) mL}^{-1}$

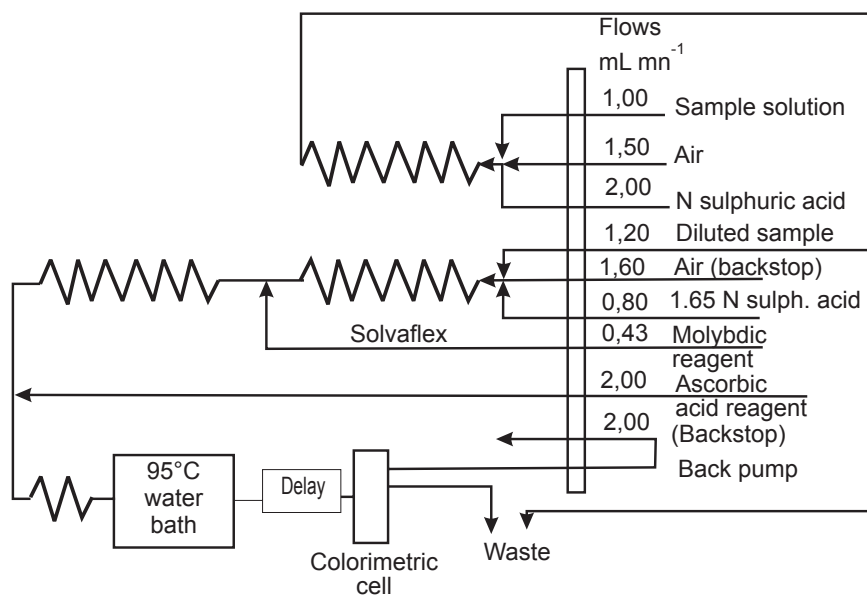

**Fig. 29.2.** Titration of total *ortho*-phosphorus by automatic colorimetry at 625 nm (Gautheyrou and Gautheyrou 1978)

### Procedure

- Take exactly  $V_0$  mL of the extraction solution containing between 10 and 20  $\mu\text{g}$  of P, i.e. an aliquot of from 1 to 15 mL maximum (for water, resin or isotopic extraction of  $^{32}\text{P}$ , the volume of the aliquot is the biggest; for extraction methods of mobile forms in acid or basic medium, the volume of the aliquot is smaller; for total P, intermediate dilution rates are used)
- put the aliquot in a 25 mL volumetric flask; add 5 mL of mixed reagent and complete to 25 mL with deionized water; homogenize; wait 30 min for titration (colour will remain stable for around 24 h).
- read absorbance at 890 nm on the spectrophotometer using a 10 mm colorimetric cell (or a larger cell depending on the intensity of the colour, possibly a 100 mm cell for water extracts). Continue in the same way for each point of the calibration range
- plot a graph with P concentration on the  $X$ -coordinate and absorbance on the  $Y$ -coordinate. Read the P concentration of the sample solution:  $x$   $\mu\text{g mL}^{-1}$ . If  $V$  is the volume (mL) of the extraction solution,  $P$  the weight of soil sample (g) and  $f$  the possible moisture correction factor, the results are expressed on the basis of soil dried at  $105^\circ\text{C}$ , and the soil content is expressed by:

$$C = f x V/P$$

in mg (P)  $\text{kg}^{-1}$  (soil)  
or  $C = 2.29 f x V/P$   
in mg ( $\text{P}_2\text{O}_5$ )  $\text{kg}^{-1}$  (soil)

Alternatively, the process can be automated, for example in a system with segmented continuous flow analysis (see manifold for total phosphorus in Fig. 29.2).

### **P Titration by Spectrophotometry of the Phosphomolybdic Yellow Complex**

This method is less sensitive than the method described in “Spectrophotometry Using Molybdenum Blue” and is often used for P titration in extracts of total-, total organic- or retention-P with high P contents. *Ortho*-phosphate forms are titrated spectrometrically according to the reaction of the formation of a yellow complex absorbing at 420–466 nm:

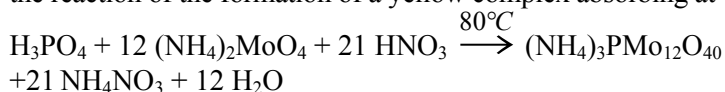

Arsenates can produce  $(\text{NH}_4)_3\text{AsMo}_{12}\text{O}_{40}$  which interferes with the measurement of colour. Iron can obstruct and must be eliminated if it colours the extracts (Salvage and Dixon 1965, Ruf 1966).

### 29.5.3 P Titration by Atomic Spectrometry

P titration by inductively coupled plasma atomic absorption spectrometry (cf. Sect. 31.2.14 in Chap. 31) accounts for all P forms in an extract but cannot differentiate between them (between organic and inorganic P, for example). The sensitivity of the method is low enough for direct titration of P. Lines 213.62 and 214.91 nm are generally used. Copper, chromium, iron, vanadium, and titanium interfere. Inter-element corrections reduce precision.

The separation of the  $\text{PMo}_{12}$  complex (cf. Sects. 29.5.1 and 29.5.2) and molybdenum titration is sensitive and precise using the UV lines 177.50, 178.77 nm and especially 178.29 nm. Vanadium, titanium, nickel copper manganese and chromium do not interfere up to  $200 \text{ mg L}^{-1}$ . Iron, aluminium, calcium, silicium do not interfere up to around  $1,000 \text{ mg L}^{-1}$ .

In flame emission spectrometry, the initial state of P does not influence the results to any great extent and the intensity of emission reflects the concentration of total P. The emission spectra are complex. Bands 5249, 5597 or 5097 Å (H-PO) and bands 2478, 2464, 2540 Å (PO) can be used. The limit of detection is around  $1 \text{ mg L}^{-1}$  depending on the source of excitation used.

### 29.5.4 Titration of Different Forms of P by $^{31}\text{P}$ NMR

The NMR technique (cf. Sect. 12.3.4 of Chap. 12) produces different signals for *ortho*- and pyrophosphate forms and for the more or less complex organic forms of P.

The  $^{31}\text{P}$  nucleus presents a spin magnetic moment. When it is placed in a magnetic field and excited by radiometric waves, transition energy is produced. The resulting spectrum provides information on the immediate chemical environment of the P atom without destroying the sample (Fig. 29.3). High resolution NMR applied to the liquid phase is currently the most commonly used for soil P studies; solid phase NMR is used less frequently. Sensitivity is lower than the proton NMR spectrum, i.e. about  $10^{-5}$  g.

Forms of inorganic phosphates produce clearly differentiated peaks for the short linear chains (*ortho*-P, pyro-P, tripolyphosphates). Molar ratios are obtained by measuring the surfaces of the peaks. Mono- and di-esters of P are easy to measure. Inorganic phosphates with long chains and condensed organic phosphates can have complex spectra. Correct interpretation may require the simultaneous use of  $^{31}\text{P}$ - and proton-NMR spectra.



This method is very specific and can be used for different P extracts of soil (Gautheyrou et al. 1990).

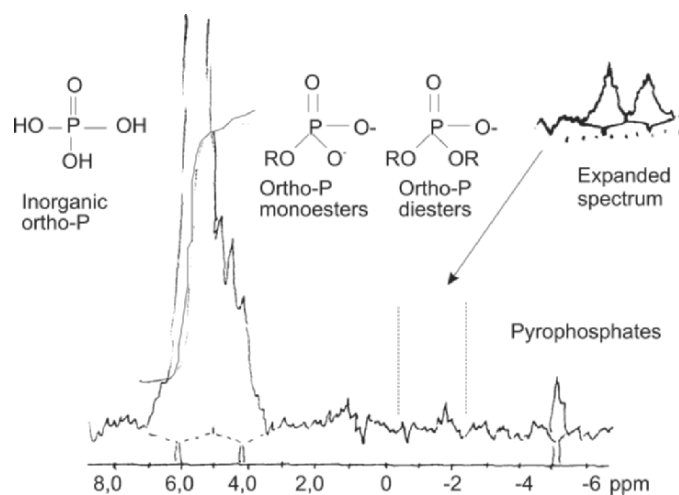

**Fig. 29.3.**  $^{31}\text{P}$  NMR Spectrum of P forms in a  $0,5 \text{ mol (NaOH) L}^{-1}$  extract of soil (Gautheyrou et al. 1990)

### 29.5.5 Separation of P Compounds by Liquid Chromatography

The extracts are injected and entrained by a mobile phase (for example phthalic acid  $0.5 \text{ mmol L}^{-1}$  at pH 2.7) in a column filled with an anion exchange resin (Karlson and Frankenberger 1987). The technique is used particularly for the determination of organo-phosphorous pesticides (cf. Sect. 13.3.4 of Chap. 13), but also to separate anionic forms of P. Phospholipids can be also studied by chromatography (cf. lipid studies in Sects. 13.2.5 and 13.3.3 of Chap. 13) after extraction with solvents.

## 29.6. Direct Speciation of P in situ, or on Extracted Particles

Determining P on thin sections (cf. Sect. 2.2 of Chap. 8) or on minerals separated by particle size fractionation (cf. Chap. 3) is extremely complex. Indeed, more than 220 natural minerals containing P are known to exist with numerous atom substitutions. Although forms bound to calcium, aluminium and iron predominate, the soil particles are difficult to identify.

The P minerals are generally concentrated in the clay and oxide fractions (e.g. apatites, aluminophosphates, variscite, vivianite). The magnetic fraction extracted from certain tropical soils contains more iron oxide forms with short range organization than crystalline. This explains the mechanisms of P sorption on iron oxide and hydroxides surfaces e.g. on goethite, hematite, lepidocrocite or amorphous gels (Schwertmann, 1964).

The addition of phosphate-enriched fertilizers can result in very high local concentrations of P and redistribution in the soil based on displacement of organic P. The product of this reaction can be estimated chemically using physicochemical techniques like micro-diffraction (Belle and Black 1970). Needles of calcium sulphate formed on apatite micro-crystals can be observed under an optical microscope or a scanning electron microscope with an EDX microprobe on uncovered thin blades treated with diluted sulphuric acid. Distribution charts of calcium and phosphorus can be drawn up if local concentrations are sufficient (Subbarao and Ellis 1975). In scanning transmission electron microscopy and scanning electron microscopy with energy dispersive X-ray microprobes, the bombardment of electrons generates X-rays which enable observation of P concentrations around particles and identification of the chemical composition of a zone of about  $1 \mu\text{m}^2$ . By micro-diffraction, the structure of mineralogical associations allows forms of P minerals to be identified. The thermodynamic properties of these compounds can be transformed into solubility values enabling relations with P of the soil solution to be established. The P/Al, P/Fe, P/Ca ratios can be calculated, but the organic forms require a more complex approach. Such methods are required for a detailed study of mineralogical and petrographic mechanisms, in particular during the fixing of fertilizers by the soil (El Zahaby and Chien 1982, Freeman and Rowell 1981, Henstra et al. 1981).

### References

- Bell BC and Black CA (1970) Comparison of methods for identifying crystalline phosphate produced by interaction of orthophosphate fertilizers with soils. *Soil Sci. Soc. Am. Proc.*, 34, 579–582

- Blackemore LC, Searle PL and Daly BK (1981) *Methods for chemical analysis of soils.*, N.Z. Soil Bur. Sci., Rep. 10A
- Bray RH and Kurtz LT (1945) Determination of total, organic and available forms of phosphorus in soils. *Soil Sci.*, 59, 39–45
- Chang SC and Jackson ML (1957) Fractionation of soil phosphorus. *Soil Sci.*, 84, 133–144
- Dabin B (1967) Application des dosages automatiques à l'analyse des sols (3<sup>e</sup> partie) – 3. Analyse du phosphore assimilable dans les sols tropicaux. *Cah. Orstom Ser. Pédol.*, V, 278–286
- Dalal RC and Hallsworth EG (1976) Evaluation of the parameters of soil phosphorus availability factors in predicting yield response and phosphorus uptake. *Soil Sci. Soc. Amer. J.*, 40, 541–546
- Dean L.A (1947) Application of radioactive tracer technique to studies of phosphatic fertilizer utilization by crops. I – Greenhouse experiments. *Soil Sci. Soc. Am. Proc.*, 12, 107–112
- Demolon A (1932) *La dynamique du sol.* Dunod, 262
- Dyer B (1894) On the analytical determination of probably available “ mineral ” plant food in soils. *J. Chem. Soc.*, 65, 115–167
- El Zahaby EM and Chien SH (1982) Effect of small amounts of pyrophosphate sorption by calcium carbonate and calcareous soil. *Soil Sci. Soc. Am. P.*, 46, 38–46
- Fardeau JC and Jappe J (1988) Valeurs caractéristiques des cinétiques de dilution isotopique des ions phosphate dans les systèmes sols-solution. In *Phosphore et Potassium dans les relations sol-plante, conséquence sur la fertilisation*, Gachon L. ed. Lavoisier-INRA, 79–99
- Fardeau JC (1993) Le phosphore assimilable des sols : sa représentation par un modèle fonctionnel à plusieurs compartiments. *Agronomie*, 13, 317–331
- Fardeau JC (1997) Biodisponibilité du phosphore dans les sols, les déchets et les sédiments : des approches isotopiques. In *Le phosphore dans les sols, les déchets et les eaux*, AFES, Journées thématiques de Mars
- Freeman JS and Rowell DL (1981) The adsorption and precipitation of phosphate on calcite. *J. Soil Sci.*, 32, 75–84
- Gachon L (1988) *Phosphore et Potassium dans les relations sol-plante, conséquence sur la fertilisation.*, Lavoisier-INRA, 79–99
- Gautheyrou J and Gautheyrou M (1978) *Méthodologies mécanisées – Introduction à l'automatisation des opérations analytiques dans les sols, les végétaux et les eaux d'irrigation.*, IRD (ex-Orstom), Guadeloupe, Paris, Notes laboratoire, 113 p
- Gautheyrou J and Gautheyrou M (1989) Dosage du phosphore ortho. la réaction céruléo molybdique. In *Compte-rendu Journées laboratoires IRD*, Bondy, France, 134–154
- Gautheyrou M, Gautheyrou J and Quantin P (1990) La spectroscopie RMN haute résolution de <sup>31</sup>P – Etude des formes de phosphore d'un Andosol soumis à l'écobuage. *Actes Congrès Int. Sci. du Sol*, Kyoto, Japan

- Gunnarson O and Frederickson L (1951) A Method for determining plant available phosphorous in soil by means of  $^{32}\text{P}$ . *Proc. isotope technical conf.*, Oxford, 1, 427–431
- Hedley MJ, Stewart WB and Chauhan BS (1982) changes in inorganic and organic soil phosphorous fractions induced by cultivation practices and by laboratory incubations. *Soil Sci. Soc. Am. J.*, 46, 970–976
- Henstra SD, Eijk van der, Boekestein A, Thiel F and Plas van L (1981) Compositional change in triple superphosphate fertilizer granule. *Scanning Electron Microscopy*, 1, 439–446
- Joret G and Hebert J (1955) Contribution à la détermination du besoin des sols en acide phosphorique. *Ann. Agron.*, 2, 233–299
- Karlson U and Frankenberger Jr. WT (1987) Single column ion chromatography. III – Determination of orthophosphate in soils. *Soil Sci. Soc. Am. J.*, 51, 72–74
- Larsen S (1952) The use of  $^{32}\text{P}$  in studies on the uptake of phosphorous by plants. *Plant and Soil*, 4, 1–10
- Mehlich A (1953) *Determination of P, Ca, Mg, K, Na, NH<sub>4</sub>*. North Carolina Soil Test Division, Rapport multigraphié
- Mehta NC, Legg JD, Goring CAI and Black CA (1954) Determination of organic phosphorous in soil. 1. Extraction method. *Soil Sci. Soc. Am. Proc.*, 18, 443–449
- Murphy J and Riley JP (1962) A modified simple solution method for the determination of phosphates in natural waters. *Anal. Chim. Acta.*, 27, 31–36
- NF X31-160 (1993) Détermination du phosphore soluble dans une solution à 20 g L<sup>-1</sup> d'acide citrique monohydraté. In *Qualité des sols*, 3rd ed. 1996, AFNOR, 147–154
- NF X31-161 (1993) Détermination du phosphore soluble dans une solution d'oxalate d'ammonium à 0.1 mol L<sup>-1</sup>. In *Qualité des sols*, 3rd ed. 1996, AFNOR, 157–165
- Pansu M, Gautheyrou J and Loyer JY (2001) *Soil Analysis – Sampling, Instrumentation and Quality control*, Balkema, Lisse, Abington, Exton, Tokyo, 489 p
- Pierzynski GM ed. (2000) *Methods of Phosphorus Analysis for Soils, Sediments, Residuals, and Waters*, South. Coop. Ser. Bull. 396, Dep. of Agronomy, 2004 Throckmorton Plant Sciences Ctr., Kansas USA, [http://www.soil.ncsu.edu/sera17/publications/sera17-2/pm\\_cover.htm](http://www.soil.ncsu.edu/sera17/publications/sera17-2/pm_cover.htm)
- Roche P, Grière L, Babre D, Calba H and Fallavier P (1978) La carence en phosphore des sols intertropicaux et ses méthodes d'appréciation. *Science du sol.*, 4, 251–268
- Ruf F (1966) The conditions for spectrophotometric determination of orthophosphate with molybdovanado phosphate. *C.R. Geol. Com. Nat. Malgache Geol.*, 70, 4
- Salvage T and Dixon JP (1965) The colorimetric determination of phosphorus in organic compounds on the microgram scale. *Analyst.*, 90, 24–28

- Schwertmann U (1964) The differentiation of iron oxide in soils by a photochemical extraction with acid ammonium oxalate. *Z. Pflanzenenahr. Dueng Bodenkd*, 105, 194–292
- Subbarao YV and Ellis R (1975) Reaction products of polyphosphates and orthophosphates with soils and influence of uptake of phosphates by plants. *Soil Sci. Soc. Am. Proc.*, 39, 1085–1088
- Syers JK, Smillie GW and Williams JDH (1972) Calcium fluoride formation during extraction of calcareous soils with fluoride. I – Implications to inorganic P fractionation schemes. *Soil Sci. Soc. Am. Proc.*, 36, 20–25
- White RE and Beckett PT (1964) Studies on phosphate potentials of soils. 1 – The measurement of phosphate potential. *Plant and Soil*, 20, 1–16
- Williams JDH, Syers JK and Walker TN (1967) Fractionation of soil inorganic phosphate by a modification of Chang and Jackson's procedure. *Soil Sci. Soc. Amer. Proc.*, 31, 736

### Chronobibliography

- Kurtz LT (1942) Elimination of fluoride interference in molybdenum blue reaction. *Ind. Eng. Chem. Anal.*, 14, 855
- Palache C, Berman M and Frondel C (1951) *The systems of mineralogy.*, Wiley Chapman, New York/London
- Olsen SR (1952) Measurement of surface phosphate on hydroxylapatite and phosphate rock with radiophosphorus. *J. Phys. Chem.*, 56, 630–632
- Nelson WL, Mehlich A and Winters E (1953) The development, evaluation and use of soil tests for phosphorus availability. In *Soil and fertilizer phosphorus*, Pierre W.H. and Norman A.G. ed., A.S.A. No. 4
- Watanabe FJ and Olsen SR (1965) Test of an ascorbic acid method for determining phosphorus in water and NaHCO<sub>3</sub> extracts from soils. *Soil Sci. Soc. Am. Proc.*, 29, 677
- Lehr JR, Brown EH, Frazier AW, Smith JP and Thrasher RD (1967) Crystallographic properties of fertilizer compounds. *Chem. Eng. Bull.*, (Alabama, Etats-Unis) No. 6
- Fox RL and Kamprath EJ (1970) Phosphate sorption isotherms for evaluating the phosphate requirements of soils. *Soil Sci. Soc. Am. Proc.*, 34, 902–907
- Povarennykh AS (1972) *Crystal chemical classification of minerals.*, Plenum New York, Vols. I and II
- Franzen DW and Peck TR (1995) Spatial variability of plant analysis phosphorus levels. *Commun. in Soil Sci. Plant Anal.*, 26, 2929–2940
- Frossard E, Brossard M, Hedley MJ and Metherel A (1995) Reactions controlling the cycling of P in soils. In *Phosphorus in the global environment.*, Wiley New York 107–137
- Fardeau JC, Guiraud DG and Morel C (1996) The role of isotopic techniques on the evaluation of effectiveness of P fertilizers. *Fert. Res.*, 45, 101–109

- Kuo S (1996) Phosphorus. In *Methods of soil analysis, part 3, chemical methods*, Bigham J.M. and Bartels J.M. ed., SSSA-ASA, Madison, WI Etats-Unis, 869–919
- Cade-Menun BJ and Preston CM (1996) A comparison of soil extraction procedures for  $^{31}\text{P}$  NMR spectroscopy. *Soil Science*, 161, 770–785
- Condon HJ and Frossard LME (1997) Isotopes techniques to study phosphorus cycling in agricultural and forest soils : a review. *Fert. Res.*, 24, 1–12
- Robinson JS and Johnston CT (1998) Combined chemical and  $^{31}\text{P}$ -NMR spectroscopic analysis of phosphorus in wetland organic soils. *Soil Sci.*, 163, 705–713
- Isik Y and Ekiz H (2000) The phosphorus demand of durum wheat grown in Konya and the calibration of Olsen phosphorus analysis. Konya yoresinde yetistirilen makarnalik bugdayin fosforlu gubre istegi ve Olsen fosfor analiz metodunun kalibrasyonu. Ministry of Agriculture and Rural Affairs, Bahri Dagdas International Winter Cereals Research Center; Konya; Turkey 230–239
- Steege A, Govers G, Beuselinck L, Oost K van, Quine TA, Rombaut A, Stone M (2000) The use of phosphorus as a tracer in erosion/sedimentation studies. In *The role of erosion and sediment transport in nutrient and contaminant transfer. Proceedings of a symposium held at Waterloo, Ontario, Canada in July 2000*, IAHS Wallingford, UK
- Elrashidi MA (2001) Testing methods for phosphorus and organic matter. <http://soils.usda.gov/technical/methods>
- Boruvka L, Rechcigl JE (2003) Phosphorus retention by the AP horizon of a spodosol as influenced by calcium amendments. *Soil Sci.*, 168, 699–706
- Escudéy M, Galindo G and Briceno M (2004) Influence of particle size on  $^{31}\text{P}$  NMR analysis of extracts from volcanic ash-derived soils in Chile. *J. Chil. Chem. Soc.*, 49, 5–9

## Sulphur

### 30.1 Introduction

#### 30.1.1 Sulphur Compounds

Sulphur is not a very abundant element in most soils and can come from various origins: volcanic emission of sulphur products, deterioration of eruptive rocks, metamorphic or sedimentary transformations, the action of surface water, ground water, or sea water, the biological contribution of different animals and plants. Agricultural, industrial and domestic activities also contribute to soil enrichment in sulphur compounds, in particular the use of amendments, fertilizer, compost and pesticides. The use of fossil fuels also contaminates the atmosphere and has consequences for soils through rainfall. Except in certain specific soils such as acid sulphated soils, swampy histosols or gypseous soils, the sulphur content of most soils is usually low (a few tens of  $\text{mg kg}^{-1}$ ).

Qualitatively speaking, sulphur exists in both organic and mineral forms. The variety of simple or complex, amorphous or crystalline molecular structures of sulphur compounds in soils is a characteristic of this element. The existence and stability of the different sulphur derivatives depends to a large extent on the physicochemical conditions of the medium (in particular on redox potential and soil pH). The different forms of sulphur can also be determined by analysing the microbiological reactions generated by sulfato-reducing or sulfo-oxidizing bacteria. Apart from some relatively stable, not very soluble sulphated forms such as gypsum or jarosite, most sulphur compounds are subject to transformations that are part of the sulphur cycle in soils and in living organisms.

**Table 30.1.** Main sulphur minerals present in sedimentary deposits (evaporites\*), efflorescences, crusts and soils

oxidation state	link	mineral	chemical formula	inter-reticular distance (Å)			solubility g L <sup>-1</sup> water		
							0°C	30°C	100°C
sulphates	Ca <sup>2+</sup>	gypsum	CaSO <sub>4</sub> ·2H <sub>2</sub> O	7.56	3.05	4.27	2.41	2.6	2.22
		hemihydrate	CaSO <sub>4</sub> ·0.5H <sub>2</sub> O	3.00	6.01	2.80		3.0	
		bassanite	CaSO <sub>4</sub> ·0.5H <sub>2</sub> O	3.00	6.01	2.80			
		*anhydrite	CaSO <sub>4</sub>	3.49	2.85	2.32		2.09	1.62
sulphates	Mg <sup>2+</sup>	epsomite	MgCaSO <sub>4</sub> ·7H <sub>2</sub> O	4.21	5.35	2.68		710.0	910.0 (40°C)
		hexahydrite	MgCaSO <sub>4</sub> ·6H <sub>2</sub> O	4.43	4.04	2.94			
		*kieserite	MgCaSO <sub>4</sub> ·H <sub>2</sub> O	3.41	4.84	3.33			684.0
sulphates	Na <sup>+</sup>	thenardite	Na <sub>2</sub> SO <sub>4</sub>	2.78	4.66	3.18	47.6		427.0
		mirabilite	Na <sub>2</sub> SO <sub>4</sub> ·10H <sub>2</sub> O	5.48	3.28	3.26	110.0	927.0	
oxidized forms	Mixite	bloedite	Na <sub>2</sub> Mg(SO <sub>4</sub> ) <sub>2</sub> ·4H <sub>2</sub> O	3.25	4.56	3.29			
		*loewelite	Na <sub>2</sub> Mg(SO <sub>4</sub> ) <sub>2</sub> ·5/2H <sub>2</sub> O	3.17	4.29	4.04			
		*vanthoffite	Na <sub>2</sub> Mg(SO <sub>4</sub> ) <sub>2</sub> ·5/2H <sub>2</sub> O	2.91	3.44	3.43			
		natrojarosite	NaFe <sub>3</sub> (OH) <sub>6</sub> (SO <sub>4</sub> ) <sub>2</sub>	5.04	3.05	3.12			
		*langbeinite	K <sub>2</sub> Mg <sub>2</sub> (SO <sub>4</sub> ) <sub>3</sub>	3.14	2.65	4.05			
		*picromerite	K <sub>2</sub> Mg(SO <sub>4</sub> ) <sub>2</sub> ·6H <sub>2</sub> O	3.70	3.04	2.38			
		*polykalite	K <sub>2</sub> MgCa <sub>2</sub> (SO <sub>4</sub> ) <sub>4</sub> ·2H <sub>2</sub> O	2.90	3.18	2.85			





From an agricultural point of view, as sulphur is an essential element for plant growth, it can cause a crop to fail. Failures can be due to sulphur either deficiency or toxicity in the soil environment, with thresholds that vary depending on the sensitivity of the species.

Two types of soils that are particularly rich in sulphur require specific analyses (1) acid sulphated fluviomarine soils (e.g. mangroves or polders) and (2) gypseous soils. Some analytical techniques described in this chapter are designed specifically for one or the other of these two soil types. Most of the techniques can be used with other soils that are less rich in sulphur compounds.

### 30.1.2 Mineralogical Studies

Two hundred mineral sulphates and 228 sulphide species have been indexed in the natural environment. Sulphur exists in countless natural and industrial organic forms. The most common inorganic forms in soils are listed in Table 30.1. In soils under arid or semi-arid climates, surface crystallizations are frequently preserved in their natural state. Oxidized forms are stable and no particular problems are involved in their storage.

On the other hand, samples comprising reduced forms (e.g. iron sulphides) should be stored in closed bottles protected from the light, and crushed immediately before analysis.

Mineralogical observations can be carried out under the optical microscope or the scanning electron microscope coupled to an EDX microprobe (cf. Chap. 8). In the latter case, possible transformations caused by the instrumental technique (e.g. high vacuum or intensity of the electron beam) need to be taken into account.

#### ***Widespread Mineral Forms and Soil Classification***

\**Evaporites*. Geological deposits – sediments accumulated by drainage and evaporation – hydrothermal action. The most soluble salts accumulate in efflorescence forms due to capillary bottom-up flows and surface evaporation. Very soluble magnesium or sodium sulphates are found on the soil surface only under arid climates.

*Thenardite* ( $\text{Na}_2\text{SO}_4$ ) is more stable than *mirabilite* ( $\text{Na}_2\text{SO}_4 \cdot 10\text{H}_2\text{O}$ ) and other sulphates like *bloedite* ( $\text{Na}_2\text{Mg}(\text{SO}_4)_2 \cdot 4\text{H}_2\text{O}$ ), *hexahydrate* ( $\text{MgSO}_4 \cdot 6\text{H}_2\text{O}$ ), *epsomite* ( $\text{MgSO}_4 \cdot 7\text{H}_2\text{O}$ ). Temperature should be taken into account since it affects solubility. *Gypsum* ( $\text{CaSO}_4 \cdot 2\text{H}_2\text{O}$ ) is the least soluble soil sulphate and the most abundant in natural environments. Gypsum deposits often occur simultaneously with calcium carbonate deposits when calcium sulphate solubility is exceeded.

The first field tests made it possible to perform analyses safely. Soils whose main properties depend on the presence of sulphur compounds are indexed in international soil classification systems.

In the French classification system (CPCS 1967), sulphur compounds appear in a subclass (gypseous soils) and group with respect to the individualization of calcium sulphate; in a class (sodic soils) and subclass (saline soils) with respect to soils containing sulfidic materials in a reduced state in hydromorphic–halomorphic environments, or in an oxidized state in aerobic drained environments.

The main FAO units (1968) *vermosols* and *xerosols* include *gypsic* subdivisions, and *Gleysols* and *Fluvisols* include *thionic* subdivisions for mangrove soils.

In the US Soil Taxonomy (USDA 1975), sulphur compounds appear in main groups (*gypsiorthids*, *natrargids*, *natriborolls*) and in inorganic and organic reduced soil groups (*sulfaquents*, *sulfhemists*) or in acid sulphated soil groups (*sulfaguepts*, *sulfohemists*); and finally, in the group of horizons with predominance of a process involving the passage of time: *gypsic*, *petrogypsic*, *sulphuric* soils and even *salic* or *natric* soils in the presence of different soluble salts.

In practice, only a limited number of sufficiently stable minerals can be identified due to the lack of sensitivity of the methods and the difficulty involved in separating the different components without causing structural modifications (particularly in the case of compounds with low sulphur content in saline matrices with very high sulphur contents), but also because of climatic constraints (e.g. the temperature or rainfall regime) or drainage conditions.

## 30.2 Total Sulphur and Sulphur Compounds

### 30.2.1 Characteristics of Fluviomarine Soils

This type of soil is particularly rich in sulphur and is found in deltas, estuaries or polders under different climates. Under equatorial or tropical climates in particular, the brackish soils and sediments are colonized by specific mangrove vegetation with a very dense root system that produces abundant organic matter.

In this submerged reducing medium, marine sulphates are reduced by microbial action into sulphides which, by reaction with ferruginous materials, produce pyrites. If the environment remains anaerobic, the accumulation of pyrites in soil materials remains stable. A drop in the

level of groundwater due to natural drought or artificial drainage disturbs this equilibrium causing oxidation of pyrite and release of sulphuric acid and iron oxyhydroxides. The soil environment is acidified; under drier tropical conditions, salinization may be also intensified by the concentration of salts. Intense acidification can release aluminium by attacking the crystal lattices of clays (acidolysis). The result of these processes is the formation of a mixture of sulphate of aluminium, iron and magnesium represented by jarosite, natrojarosite and different forms of alums (Vieillefon 1974; Marius 1980; Le Brusq et al. 1987; Montoroi 1994; Génin et al. 2001; Montoroi et al. 2002).

The rapid changes, which affect these soil environments and their components, mean special care has to be taken during sampling and storage, as well as during the extraction and titration of the different forms of sulphur present at a given time in soils (Pansu et al. 2001). The S element is represented by a mixture of different isotopes ( $^{32}\text{S}$  and  $^{34}\text{S}$ ). S compounds are found in gaseous forms (e.g. hydrogen sulphide), soluble forms (sulphides, sulphates), not very soluble or insoluble forms (polysulphides, pyrites, elementary sulphur, gypsum, mixed sulphates), and more or less oxidizable organic compounds.

To interpret soil genesis, during analysis a clear distinction must be made between the sulphur forms in a fresh sample which are representative of *in situ* conditions (sulphide forms) from the S forms which can appear after oxidation (sulphate forms) in an air-dried soil (Marius et al. 1976).

### 30.2.2 Soil Sampling and Sample Preparation

In soils containing oxidized products (e.g. gypsum cf. Sect. 30.3), sampling is standard and the soil samples are prepared in the usual way.

Soils in reducing environments often pose particular sampling problems. Oxidation of sulphur compounds has to be avoided. Hydrogen sulphide is lost very rapidly. The evolution of sulphides (even in their metastable forms) has to be controlled by protecting the samples from contact with the air and by storing them at a low temperature protected from the light.

In mangroves and mud flats, sampling is carried out with a hollow mud scoop (with a diameter of 60–100 mm) that has a sharp edge to cut fibrous materials or roots (Pansu et al. 2001). A succession of extension rods (1 m in length) makes it possible to take progressively deeper samples. Generally 1 m is sufficient for agronomic studies. The mud scoop is inserted vertically in the movable sediments, then rotated

slightly to free the base of the soil column and extracted taking care not to disturb the sample. The mud scoop is then laid flat on the ground and the core separated with a blade. Each level of the soil should be noted, the necessary sample specimens removed, and direct measurements made on the soil column (pH and certain field tests).

When deeper samples are required, samplers equipped with a stationary piston in metal or plastic tubes of varying length (1–3 m) enable cores to be removed undisturbed. The ends of the tubes containing the cores should immediately be tightly sealed with plastic. If possible the tubes should be kept in a cold room until they are sawed open lengthwise in the laboratory. The samples taken at different depths are usually separated into four fractions:

- A section of undisturbed sample for examination of soil morphology should be stored in the refrigerator in an airtight box.
- One fraction should be air dried and sieved to 2 mm; part of this fraction should be crushed on an AFNOR NF 21 sieve (100  $\mu\text{m}$ ) and used for total analysis, as reduced forms are usually oxidized.
- One fraction should be stored wet for analysis of the reduced forms; after rapid homogenisation on a 4 mm sieve to eliminate roots and stones, the sample specimens can be stored for a short time in airtight lightproof bottles in the refrigerator, or for a long time in the freezer. The water content should be measured.
- One fraction should be freeze-dried to avoid hardening of the sample and reduced metastable forms.

Samples should be stored in lightproof bottles in the refrigerator. The moisture content should be measured at each sampling.

In the field, water should be sampled in the sampling hole for immediate analysis e.g. pH, conductivity,  $\text{H}_2\text{S}$  content; one water sample should be put in an airtight bottle to take back to the laboratory. Leaving piezometers in the most representative sampling holes enables subsequent changes in the ground water to be monitored (e.g. level, pH, salt concentration).

### 30.2.3 Testing for Soluble Sulphur Forms

An in situ search for soluble sulphur forms and particularly sulphides can be made on a sample of water from a waterlogged soil (using a field test e.g. Hach H-5-6 n° 223800, ranges: 0–0.6 or 0–5 mg  $\text{H}_2\text{S}$ ).

The presence of hydrogen sulphide is perceptible by its odour even at very low contents (0.025 mg  $\text{kg}^{-1}$ ) and it is water soluble (0.102 mol  $\text{L}^{-1}$ ).

The presence of soluble sulphides is revealed by an acid attack followed by a lead acetate test:

- Attack a few grams of soil with 6 mol (HCl) L<sup>-1</sup> hydrochloric acid in a test-tube:

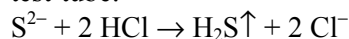

- Cover the opening with lead acetate paper for 5 s; the appearance of a dark reddish brown colour indicates high levels of hydrogen sulphide according to the reaction:

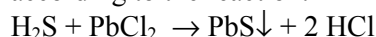

### 30.2.4 Titration of Total Sulphur

Many organic- and inorganic-S compounds can result from (1) the many oxidation states of the S element (-2 to +6), (2) possible S bonds (covalence, coordination, ionic) and (3) the different coordination geometries. For total analysis, it is consequently necessary to transform S forms into stable forms:

- By oxidation into the S<sup>+VI</sup> state (sulphate), which is very stable.
- By reduction into the S<sup>2-</sup> state (sulphide); because thermodynamically stable sulphides are very easily oxidizable, titration must be performed protected from the air; this technique is used for titration especially after oxidation into sulphate.

Dry or wet oxidation methods can be used. Dry methods include:

- Alkaline fusion in the presence or not of an oxidizing additive: Na<sub>2</sub>CO<sub>3</sub>, Na<sub>2</sub>CO<sub>3</sub> + NaNO<sub>3</sub>, Na<sub>2</sub>CO<sub>3</sub> + Na<sub>2</sub>O<sub>2</sub>;
- Calcination (1) in the presence of NaHCO<sub>3</sub> + Ag<sub>2</sub>O, (2) in an oxygen flow, (3) in a closed medium in the presence of sodium carbonate and (4) with the Schöniger technique (or similar) in a stream of oxygen in a closed environment.

Wet oxidation can take place in an:

- Acid medium     H<sub>3</sub>PO<sub>4</sub> + K<sub>2</sub>Cr<sub>2</sub>O<sub>7</sub>  
                          HClO<sub>4</sub> + HNO<sub>3</sub>  
                          KMnO<sub>4</sub> + H<sub>3</sub>PO<sub>5</sub> (peroxophosphoric acid)
- Alkaline medium with sodium hypobromite (the risk of loss of H<sub>2</sub>S, SO<sub>2</sub>, SO<sub>3</sub> is reduced)

Titration of sulphur depends on the quantities present, the forms of S obtained and the composition of the soil matrix. The different methods used include gravimetry, turbidimetry, colorimetry, ionic chromatography(IC), indirect spectrography.

### 30.2.5 Total S Solubilization by Alkaline Oxidizing Fusion

#### **Principle**

The S compounds of soil are transformed into sulphate by fusion at 700°C in the presence of a mixture of sodium carbonate and potassium nitrate (the oxidizing agent potassium nitrate can be replaced by sodium nitrate or by sodium peroxide, Na<sub>2</sub>O<sub>2</sub>).

#### **Equipment**

- Tall form platinum or nickel crucibles with lids (40 mL)
- 1,000°C muffle furnace
- Water bath
- Pyrex lab glassware
- Centrifuge and filtering device
- Laboratory balances ( $\pm 1/10$  mg)

#### **Reagents**

- Sodium carbonate, Na<sub>2</sub>CO<sub>3</sub>.
- Potassium nitrate, KNO<sub>3</sub>.
- *Fusion mixture.* mix 100 g of Na<sub>2</sub>CO<sub>3</sub> and 10 g of KNO<sub>3</sub>.
- Concentrated hydrochloric acid HCl (37%).
- $\approx 2$  mol (HCl) L<sup>-1</sup> hydrochloric acid solution. In a Pyrex volumetric test tube, mix 800 mL of deionised water and 160 mL of concentrated hydrochloric acid; cool and complete to 1,000 mL with deionized water while homogenizing.

#### **Procedure**

- Dry the soil sample in the air or preferably freeze-dry and crush to 0.1 mm.
- Weigh on the precision balance between 200 and 500 mg of soil in a 40 mL tall form platinum crucible.
- Weigh 1 g of the fusion mixture, mix with the sample; add 200 mg of the fusion mixture on the surface.
- Put the closed crucible in the open muffle furnace and gradually heat to 700°C; maintain at 700°C for 40 min.
- Swirl the crucible to distribute the fusion mass on the walls; allow to cool.

– Carefully add 10 mL of 2 mol (HCl) L<sup>-1</sup> solution; if necessary disaggregate the mass with a Pyrex rod.

After effervescence has ended, place the crucible in a boiling water bath to finish the reaction. Cool and transfer in a centrifugation tube. Centrifuge and filter the supernatant in a 100 mL volumetric flask while rinsing the centrifugation pellet.

Bring to 100 mL with deionized water and homogenize.

This acid solution containing the S compounds in sulphate oxidized form is ready for the analysis of total S.

### **Remarks**

The residue is mainly composed of precipitated white silica.

If the mass is greenish and becomes pink in hydrochloric solution, manganese can be assumed to be present (the platinum crucibles may be slightly attacked by the hydrochloric acid).

If the mass is opaque and strongly coloured, the attack was incomplete.

### **30.2.6 Total Solubilization by Sodium Hypobromite in Alkaline Medium**

#### **Principle**

The organic and inorganic forms of sulphur are oxidized in sulphate by sodium hypobromite (Tabatabai and Bremner 1970a).

#### **Equipment**

- Lab glassware and special apparatus after Johnson and Nishita (1952)
- Magnetic stirrer with Teflon bar magnets
- 5 mL Teflon micro-pipette
- Sand bath
- Fume hood

#### **Reagents**

- Sodium hydroxide, NaOH, in pellet form.
- $\approx 2 \text{ mol (NaOH) L}^{-1}$  sodium hydroxide solution. Dissolve 80 g of sodium hydroxide in 1,000 mL of deionized water and protect from the carbon dioxide of the air during storage.



- Suprapur bromine, Br<sub>2</sub>.
- *Sodium hypobromite solution*, (NaBrO, prepare just before use under a fume hood) Add 100 mL of the 2 mol L<sup>-1</sup> soda solution in a 150 mL Erlenmeyer flask. Stir with a magnetic stirrer equipped with a Teflon bar and, using a micropipette, add 3 mL of bromine drop by drop. Cover with a beaker cover and use as soon as possible.
- Formic acid, HCOOH.

### Procedure

Use air-dried soil (or preferably freeze-dried soil) crushed to 0.1 mm.

- Weigh 100–200 mg of soil (containing from 20–50 µg of S) and put it into the 50 mL boiling flask (B in Fig. 30.1) of the Johnson and Nishita apparatus; work under a fume hood.
- Add 3 mL of hypobromite solution; swirl the flask for a few seconds and leave in contact for 5 min.
- Swirl again to put the particles into suspension.
- Heat on the sand bath heated to 255 ± 5°C avoiding foam overflow; evaporate to dry; maintain heat for 30 min; cool.
- Add 1 mL of water and heat for a moment to suspend the residue; cool.

Titrate this solution as soon as possible using the method of Johnson and Nishita (1952) with methylene blue (cf. Sect. 30.2.7).

## 30.2.7 S Titration with Methylene Blue Colorimetry

### Principle

According to the method of Johnson and Nishita (1952), the sulphates obtained by oxidizing mineralization are reduced to hydrogen sulphide with a mixed solution of hydroiodic (HI), phosphinic (hypophosphorous acid, H<sub>3</sub>PO<sub>2</sub><sup>1</sup>) and formic (H-COOH)<sup>2</sup> acid. The hydrogen sulphide released is adsorbed in a zinc acetate and sodium acetate buffer forming sulphides. Treatment with the mixture of *p*-aminodimethylaniline

<sup>1</sup> Hypophosphorous acid is a reducing oxoacid whose group is ionizable and a donor of protons.

<sup>2</sup> Formic acid enables acidification of the medium and reduction of the bromine residues according to the reaction: HCOOH + Br<sub>2</sub> → CO<sub>2</sub>↑ + 2HBr. Salts of formic acid play an identical role e.g. HCOONa + Br<sub>2</sub> → CO<sub>2</sub>↑ + HBr + NaBr. In the case of total analysis, where the destroyed organic compounds are not likely to be hydrolyzed, the formic acid prevents interference by nitrates.

sulphate and double ammonium–iron sulphate results in methylene blue (reaction of 2 mol of *p*-aminodimethylaniline + 1 mol of sulphide).

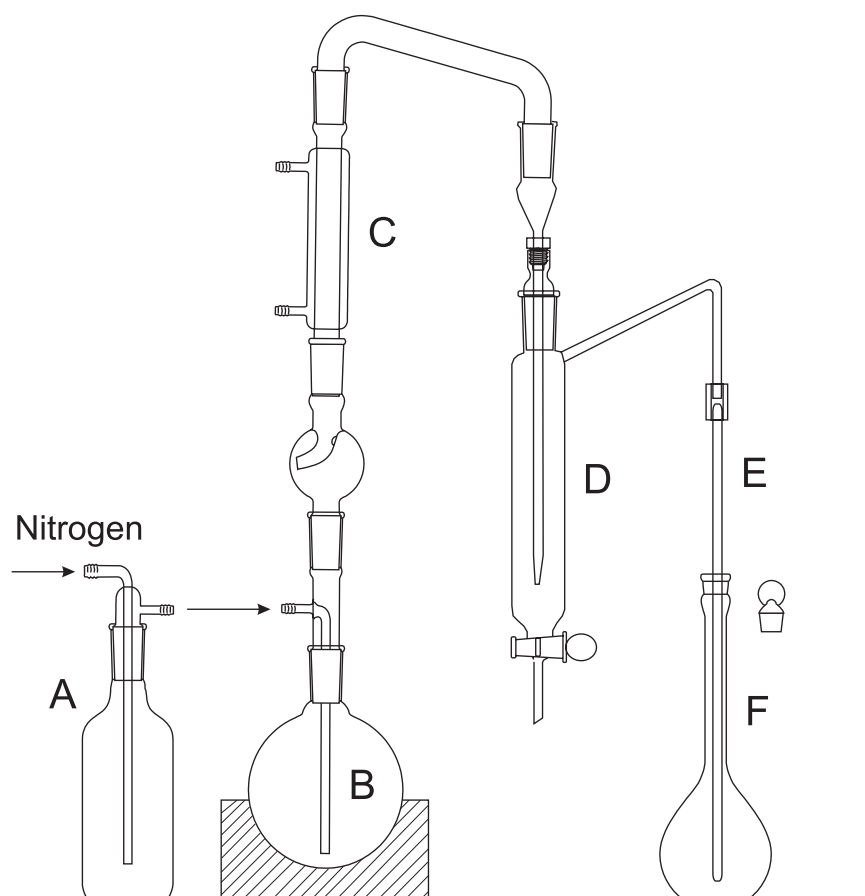

**Fig. 30.1.** Johnson and Nishita apparatus (1952)

The intensity of the colour is measured at 667–670 nm. The colour remains stable for 24 h if the solutions are stored in the dark protected from the air.

### **Equipment**

Apparatus of Johnson and Nishita (1952) including:

- A nitrogen tank (99.90% N<sub>2</sub>) with pressure regulator
- 125 mL washing bottle (A in Fig. 30.1)
- 50 mL Pyrex round bottom boiling flask (for digestion and distillation, B in Fig. 30.1)

- A bubbling device, guard bulb and condenser (C in Fig. 30.1)
- A bubbling device with plug cock (D in Fig. 1) and an outlet tube at the top equipped with a removable bubbling tube (E in Fig. 30.1)
- A 100 mL volumetric flask with a ground stopper (F in Fig. 30.1)
- An electric heating flask.

All ground glass joints should be standardized and used with Teflon sealing sleeves made to fit by damping with deionized water but without silicone grease.

- Spectrocolorimeter
- Apparatus for preparation of the reducing reagent (Fig. 30.2)

### Reagents

- Deionized water (without S).
- Potassium permanganate,  $\text{KMnO}_4$ .
- Mercuric chloride,  $\text{HgCl}_2$ .
- *Solution for purification of nitrogen.* Mix 100 mL of 2% solution of potassium permanganate in deionized water and 10 g of mercuric chloride.
- Hydroiodic acid,  $\text{HI } d = 1.70$ .
- Hypophosphorous (or phosphinic) acid, 50%  $\text{H}_3\text{PO}_2$ .
- 90% formic acid,  $\text{HCOOH}$ .
- *Reducing mixture.* Under a fume hood mix 400 mL of hydroiodic acid, 100 mL of hypophosphorous acid (phosphinic acid) and 200 mL of formic acid in a 1 L three-necked round bottom boiling flask (Fig. 30.2); place in a thermostatically controlled heating mantle; connect the boiling flask to the nitrogen bubbling tube, the thermometer and a splash head; connect the splash head to an Erlenmeyer flask containing approximately 150 mL of cold water; open the pressure regulator of the nitrogen bottle and regulate the bubbling speed (two bubbles a second) in the purifying flask (between the nitrogen bottle and the boiling flask); after 2–3 minutes, slowly heat to  $116 \pm 1^\circ\text{C}$  and maintain for 10 min at this temperature without exceeding  $117^\circ\text{C}$  (release of toxic phosphine,  $\text{H}_3\text{P}$ ); cool under continuous nitrogen bubbling. Transfer in a 1 L bottle and store in the dark.
- 1, 2, 3 benzene triol (pyrogallol).
- Sodium dihydrogen phosphate,  $\text{NaH}_2\text{PO}_4 \cdot \text{H}_2\text{O}$ .
- *Solution for elimination of the oxidizing gas products.* Dissolve 10 g of sodium dihydrogen phosphate and 10 g of pyrogallol in 10 mL of deionized water; bubble the mixture with nitrogen during dissolution; this solution should be freshly made each day.
- Dihydrate zinc acetate,  $(\text{CH}_3\text{COO})_2\text{Zn} \cdot 2\text{H}_2\text{O}$ .
- Sodium acetate trihydrate  $\text{CH}_3\text{COONa} \cdot 3\text{H}_2\text{O}$ .

- *Solution for adsorption of hydrogen sulphide.* Dissolve 50 g of zinc acetate and 12.5 g of sodium acetate in 800 mL of deionized water; complete to 1,000 mL; the mixture should be clear; if not filter on blue analytical filter.

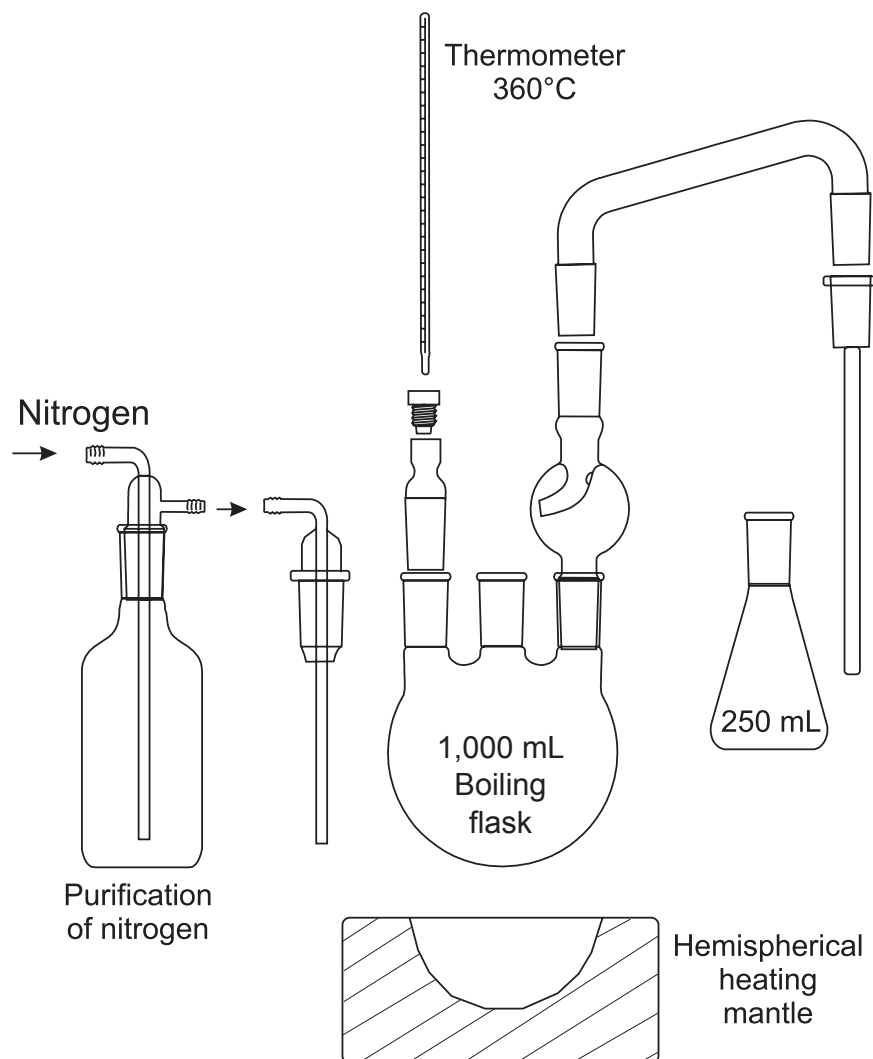

**Fig. 30.2.** Apparatus for preparation of the reducing reagent

- Sulphuric acid  $\text{H}_2\text{SO}_4$ ,  $d = 1.80$ .
- *p-aminodimethylaniline sulphate solution.* Dissolve 2 g of *p*-aminodimethylaniline sulphate in 1.5 L of deionized water in a 2 L Pyrex boiling flask. Place in cold water with ice and slowly add 400 mL of

- concentrated sulphuric acid while agitating with a Pyrex rod. Let cool and bring to 2,000 mL.
- *Double sulphate of ammonium and iron,  $Fe_2(SO_4)_3(NH_4)_2SO_4 \cdot 24H_2O$ .* Dissolve 25 g of double sulphate in a mixture of 195 mL of deionized water and 5 mL of sulphuric acid; let cool; stir on magnetic stirrer until complete dissolution.
  - Potassium sulphate,  $K_2SO_4$ .
  - *Standard stock solution.* Weigh 5.434 g of potassium sulphate and dissolve in 800 mL of S-free deionised water; complete to 1 L. One millilitre contains 1 mg of  $SO_4^{2-}$ -S.
  - *Calibration range.* Add 1, 2, 3, 4, 5 mL of standard stock solution in 100 mL volumetric flasks and complete to 100 mL with S-free distilled water. One millilitre contains 10, 20, 30, 40, 50  $\mu$ g of  $SO_4^{2-}$ -S.

### Procedure

- *Starting the Johnson and Nishita apparatus.* All ground glass joints should be assembled with a Teflon sleeve moistened with deionised water to make it adhere. Pipette 10 mL of pyrogallol–sodium phosphate solution in the bubble trap (D in Fig. 30.1). Add 10 mL of zinc and sodium acetate in the 100 mL volumetric flask (F in Fig. 30.1), add 50 mL of deionised water and homogenize. Submerge the tube (E in Fig. 30.1) until it touches the bottom of the volumetric flask and connect it to the outlet of the bubble trap (D in Fig. 30.1) with a flexible connection made of Tygon. Start the water circulating in the condenser (C in Fig. 30.1).

### Analysis

- After preparing the sample using the oxidation method described in Sect. 30.2.6<sup>3</sup> mix the sample with 1 mL of formic acid in the boiling flask B (Fig. 30.1). Homogenize and leave in contact for 30 min agitating by rotation two or three times. Quickly add with a pipette 4 mL of mixed reducing solution ( $HI + H_3PO_2 + HCOOH$ ) and connect boiling flask B to the apparatus using a Teflon ring that fits the ground glass joint. Regulate the nitrogen flow in the washing bottle A to two bubbles a second, i.e. approximately 200 mL a minute. Nitrogen purges the air and is then used as a neutral vector for hydrogen sulphide. Purge for 5 min.

<sup>3</sup> If the fusion-oxidation method (cf. Sect. 30.2.5) is used, take an aliquot of from 1 to 10 mL of the hydrochloric solution containing approximately 50  $\mu$ g of  $SO_4^{2-}$ -S and reduce the volume to approximately 2 mL by boiling gently. In this case formic acid treatment is not necessary.

- Boil gently for 1 h. Disconnect the flexible Tygon connection from the tube (E in Fig. 30.1) and remove the volumetric flask (F). Quickly rinse the tube (E) with a jet from the washing bottle (if the tube contains zinc sulphide deposits, it should be used as an agitator in the following *p*-amino dimethyl aniline treatment and rinsed afterwards).
- With the Teflon precision pipette, add 10 mL of the *p*-amino dimethyl aniline solution in the volumetric flask (F). Close the flask and shake to homogenize. Add 2 mL of the solution of ammonium and iron double sulphate. Close the flask and homogenize. Complete to 100 mL with deionized water and homogenize. Let the reaction develop for 30 min (the colour remains stable for approximately 24 h if the solution is protected from the air and light during storage).
- Treat 1 mL aliquots of solution of from 0 to 50  $\mu\text{g}$  ( $\text{SO}_4^{2-}\text{-S}$ )  $\text{mL}^{-1}$  (calibration range) and the blank with 4 mL of reducing mixture under the same conditions as the samples. Plot the calibration curves for the absorbance/ $\text{SO}_4^{2-}\text{-S}$  concentrations.

### Remarks

Maximum absorbance is at 667.8 nm. In the range 1–50  $\mu\text{g mL}^{-1}$ , absorbance follows the Beer-Lambert law and the calibration curve is linear. A higher concentration can be evaluated after dilution in the same medium (*p*-amino dimethyl aniline and double sulphate of iron and ammonium). But if the quantities of *p*-amino dimethyl aniline are insufficient to react with all the sulphides, addition of ferric iron will oxidize the surplus of sulphides making the results more or less erroneous due to dilution. A second analysis using a smaller sample of soil will provide more reliable results.

This method can also be used for the analysis of plants and water.

Some authors prefer to finish titration after hypobromite oxidation by turbidimetry with colloidal bismuth sulphide (Kowalenko and Lowe 1972; Kowalenko 1985; Buurman et al. 1996).

### 30.2.8 Sulphate Titration by Colorimetry with Methyl Thymol Blue

#### Principle

These methods quantify the forms of S oxidized in the form of sulphate. Methyl thymol blue (MTB) includes two N.N' groups (dicarboxy methyl)

amino methyl bound in positions 3 and 3' (Fig. 30.3), so it can sequester one metal atom on each one of its apical groups.

The reagent is composed of an equimolecular mixture of MTB and barium chloride. In the absence of sulphate, all barium ions are sequestered resulting in a dark blue colour which absorbs at 610 nm in strongly basic medium:

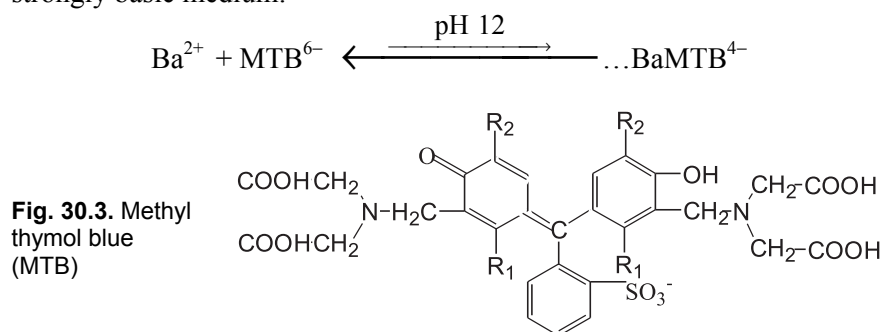

In the presence of  $\text{SO}_4^{2-}$  ions, the reagent produces barium sulphate with release of  $\text{MTB}^{6-}$  ions which absorb at 460 nm (grey).

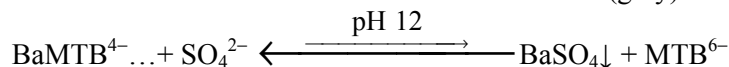

Progressive shades of blue appear whose intensity reveals the presence of unsequestered methyl thymol (grey) linked with the concentration of the sulphate. Measurement of absorbance at 460 nm is not significantly disturbed by the presence of the residual colour as this absorbs at 610 nm.

Calcium ions interfere and should be eliminated on cation resin either directly on the manifold, or beforehand by filtering each sample on a microfilter containing 1.0 g of cation exchange resin (e.g. Dowex 50W-X8).

### Equipment

- Segmented continuous-flow analytical chain with manifold and filter for colorimetric measurement at 460 nm (Fig. 30.4).
- Lab glassware.

### Reagents

- *Barium chloride solution.* Dissolve 1.526 g of dihydrate barium chloride ( $\text{BaCl}_2 \cdot 2\text{H}_2\text{O}$ ) in 800 mL of deionized water; homogenize and complete to 1,000 mL; filter on blue analytical filter if necessary.
- Sodium hydroxide in pellet form.

- 0.18 mol (NaOH) L<sup>-1</sup> solution. Dissolve 7.2 g of sodium hydroxide in 1,000 mL of deionized water.
- Methanol, CH<sub>3</sub>OH (or ethanol C<sub>2</sub>H<sub>5</sub>OH).
- Concentrated hydrochloric acid and 1 mol (HCl) L<sup>-1</sup> solution.
- Methyl thymol blue<sup>4</sup> (MTB or 3,3'-Bis[N,N-di(carboxymethyl) amino-methyl] thymolsulfonephthalein, sodium salt). Dissolve 0.1182 g of MTB in 500 mL of methanol; add 25 mL of barium chloride solution, 4 mL of 1 mol (HCl) L<sup>-1</sup> solution, 71 mL of deionized water. Complete to 1,000 mL with methanol. The purity of the MTB should be tested after each new purchase.

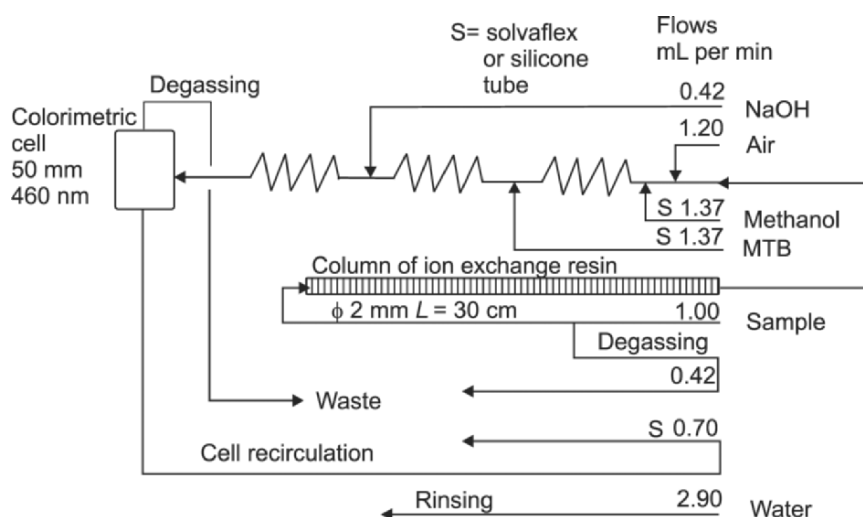

**Fig. 30.4.** Titration of the sulphate extracts by automatic colorimetry with segmented continuous-flow analysis

- Potassium sulphate, K<sub>2</sub>SO<sub>4</sub>.
- Calibration range. 0–10 μg (SO<sub>4</sub><sup>2-</sup>) mL<sup>-1</sup> depending on the manifold used.

<sup>4</sup> Commercial colouring agents like MTB are only 90% or even 80% pure. Their purity should consequently be checked in order to respect the equimolarity of the reagent which determines the linearity of response absorbance vs. sulphate concentration (Colovos et al. 1976). If MTB is not pure, there will be excess Ba<sup>2+</sup> in the reagent and binuclear complexes will be formed according to the reaction: Ba<sub>2</sub>MTB<sup>2-</sup> + SO<sub>4</sub><sup>2-</sup> ⇌ BaSO<sub>4</sub> + BaMTB<sup>4-</sup>. The absorption of the binuclear complex at 460 nm is lower than that of the expected mononuclear compound and consequently, absorption appears to represent only part of the sulphate ion that reacted.



### **Procedure**

If the organic matrix was destroyed using the Schöniger method, the samples should no longer contain excess perhydrol to avoid decomposition of the organic colouring reagents. The extract containing the sample sulphur in sulphate form is titrated by automated spectrophotometry with segmented continuous flow (Fig. 30.4) in comparison with the calibration range of standard sulphates (McSwain et al. 1974; Colovos et al. 1976).

The sensitivity of titration can be increased either by choosing a longer measurement cell for example a 50 mm cell instead of 15 mm cell but with the risk of an increase in background noise, or by changing the input flow of the sample, for example  $2.00 \text{ mL min}^{-1}$  instead of  $1.00 \text{ mL min}^{-1}$ .

For the same coding, the flows in R4000 Solvaflex tubes (recommended for solvents) are slightly different from flows in PVC tubes of the Tygon 3603 type. Silicone tubes are more resistant and less subject to deformation than Solvaflex tubes. With the 50 mm measurement cell which is more easily contaminated, faster cell recirculation can limit deposits.

### **30.2.9 Total Sulphur by Automated Dry CHN(OS) Ultimate Analysis**

With suitable catalysts, CHN(OS) apparatus allow analysis of samples containing different forms of S using dry processes (cf. Chap. 10). Automation enables rapid analysis of total S in a sample that is simply crushed to 0.1 mm.

Analysis of  $^{34}\text{S}$  and  $^{32}\text{S}$  isotopes can also be performed if the apparatus is coupled with a mass spectrometer detector.

Very sensitive and selective electron capture detectors can be used to titrate traces of sulphur, as sulphur dioxide has an affinity for free electrons.

Each manufacturer has their own system of traps and catalysts: tungstic anhydride ( $\text{WO}_3$ ) allows the conversion of S into  $\text{SO}_2$ , vanadium pentoxide ( $\text{V}_2\text{O}_5$ ) is often used for oxidation of  $\text{SO}_2$  into  $\text{SO}_3$ .

Apparatus of the 'Fisons 1108 CHN-OS' type include two furnaces for thermal treatment of the samples. The furnace used for S measurement contains tungstic anhydride. The different forms of S are oxidized in the furnace heated to  $1,100^\circ\text{C}$ . The combustion-flash of the tin capsule containing the sample increases the temperature to  $1,600^\circ\text{C}$ . A flow of helium carries the combustion gases on a copper column then on a chromatographic column where  $\text{SO}_2$ -S is separated. Quantification is then

carried out on a thermal conductivity detector (catharometer). The NA 1,500 (NCS) apparatus can handle samples up to 100 mg and performs a complete analysis in approximately 10 min.

The 'Perkin Elmer CHNS' uses a water trap for H determination and a catharometer to measure CO<sub>2</sub>-C, N<sub>2</sub>-N and SO<sub>2</sub>-S.

For the determination of total S, the 'LECO-S' analyzer uses combustion accelerators (CrO<sub>3</sub>, MoO<sub>3</sub>, powder iron) in the presence of oxygen, the temperature of the induction furnace being 1,600°C. The SO<sub>2</sub> released is titrated by iodometry on an automatic titrimeter:  $\text{SO}_2 + \text{I}_2 + 2\text{H}_2\text{O} \rightarrow \text{H}_2\text{SO}_4 + 2\text{HI}$ . The SC 132 model, which is equipped with a furnace heated to 1,400°C in oxygen atmosphere, uses IR absorption through an IR cell to quantify gaseous SO<sub>2</sub>-S.

In the 'Heraeus' apparatus (Foss-UIC) the sample is placed in a furnace heated to 1,150°C containing tungsten oxide. A flow of 90% helium–10% oxygen carries SO<sub>2</sub>-S on a magnesium perchlorate column where it is dehydrated. A chromatographic column (e.g. Porapak) separates impurities such as methane. Finally SO<sub>2</sub>-S is measured by IR detection.

'Antek' apparatuses use detection by chemi-luminescence for determination of nitrogen and pyro-fluorescence for determination of total S. Soil samples of from 50 mg to 1 g can be used depending on the sulphur content. The sample is oxidized in a furnace heated to 1,000°C with a catalyst to release sulphur dioxide. After drying on the trap, the gas is exposed to UV radiation:  $\text{SO}_2 + \text{H}\nu \rightarrow \text{SO}_2 + \text{H}\nu'$ . A photomultiplier amplifies the fluorescence signal of frequency  $\nu'$ . This reaction is specific to SO<sub>2</sub>-S and the response vs concentration is linear.

Wösthoff proposed a dedicated apparatus called a sulmograph. Total sulphur is titrated by combustion of the sample in a current of oxygen at 1,350°C producing sulphur dioxide. SO<sub>2</sub>-S is then absorbed by an oxidizing sulphuric acid aqueous solution in which carbon dioxide is not retained. The sulphur concentration is then determined by the change in conductivity before and after passage of the gas in the cell containing the oxidizing solution. This equipment was not automated, which made it less attractive despite its satisfactory precision (Marius et al. 1976).

These examples show the wide range of dry methods that can be used for S determination. Specific procedures have to be respected in each case. Automated apparatuses with computerized measurement procedures are generally the simplest to use. The sample is reduced to 0.1 mm, dried on phosphoric anhydride or in a drying oven at 105°C, weighed in a silver or tin capsule, then introduced directly into the system by a sampler. The results are printed directly by the software.

However, perfect maintenance and management of the equipment is necessary to ensure satisfactory performance: renewal of catalysts, changing the traps, cleaning the furnaces, filters, O-rings, etc. There is a risk of explosion when samples containing flammable and volatile products are analysed using dry methods.

Apparatuses for thermal analysis (cf. Chap. 7) are also used for the study of sulphur in soils, particularly when they are coupled with apparatuses for the analysis of evolved gases (EGA). Many measurements can be made simultaneously like weight loss, transition and decomposition temperatures and the nature of evolved gas like  $\text{SO}_2$ ,  $\text{SO}_3$  or  $\text{H}_2\text{S}$ . For a description of these methods, see Gerzabek and Schaffer (1986), David et al. (1989), Bremner and Tabatabai (1971), Bergheijn and van Schuylenborgh (1971), Tabatabai and Bremner (1970b, 1991).

### 30.2.10 Titration of Total $\text{SO}_4^{2-}$ -S by Ionic Chromatography

IC is a fast, selective and very sensitive method that makes it possible to simultaneously analyse many anions and cations in complex solutions (cf. Sect. 18.3.8 of Chap. 18). In spite of these advantages, IC is not a universal method and its operating range is limited in total analysis. In the natural environment, it is a useful alternative to chemical analysis in not very saline soils, as the detection limits are about  $0.2 \text{ mg } (\text{SO}_4^{2-}\text{S}) \text{ L}^{-1}$  and the titration range lies between  $0.5$  and  $100 \text{ mg L}^{-1}$  (cf. Chap. 18).

#### ***Equipment and Principle***

IC is a high pressure liquid chromatography (HPLC) technique specifically used for ion analysis (Pansu et al. 2001). Schematically, the apparatus consists of an ion exchange column which is the stationary phase (for  $\text{SO}_4^{2-}$  an anion resin in  $\text{H-CO}_3^-$  form can be used) subjected to the flow of a mobile phase by means of a constant-displacement pump. The sample to be analysed is injected in the mobile phase. The ions are retained by the stationary phase depending on their affinity; they then leave the column after a reproducible retention time and are quantified on a conductimetric detector.

The direct injection of polyelectrolyte solutions on the exchange column can decrease the life of the column and reduce its performance due to contamination. A precolumn filled with the same analytical resin is recommended to protect the separation column. Alternatively Donnan dialysis can be used to separate the dominant anions of the matrix. In this way the reduction in the performance of the column and its consequences (gradual modification of retention times and decrease in resolution) is limited.

As detection is by conductimetry, the ions of the eluting phase have to be eliminated physicochemically or electronically.

Sulphate anion has a relatively high retention time that varies with pH. A buffered mobile phase at a pH allowing a sufficiently short retention time for sulphate should thus be chosen. For anion determination of sulphate, the mobile phase is generally a carbonate–bicarbonate buffer with an isocratic flow.

### ***Application range***

The samples should not contain solid particles so the solutions should be filtered on discs with 0.45 or 0.22  $\mu\text{m}$  pores.

For total S analysis, all the S forms in the soil have to be oxidized to sulphate forms. These operations imply still other difficulties because the oxidation procedures by alkaline fusion (cf. Sect. 30.2.4) or by hypobromite (cf. Sect. 30.2.5) result in significant quantities of salts of strong acids (nitrate, chloride, perchlorate). Even after strong dilution, these solutions are unsuitable for titration by IC, because of the too high ionic charge on the columns and resulting disturbance due to too intense peaks. Oxidation methods using perhydrol should be used instead. All the sulphides and the S forms bound to organic matter are quantitatively solubilized without creating an excess of anion.

The organic matter has to be destroyed to release the organic forms of S but the residual colouring of this organic matter does not interfere with detection of conductivity.

The concentration of the extraction reagents (e.g. Morgan reagent) required for the analysis of some S pools makes determination impossible. On the other hand, analysis of the soil solution by simple filtration and dilution is easy if the total content of soluble salts is not too high (cf. Chap. 18).

If solubilization is not complete, downward biases may be significant, for example in soils containing insoluble barite ( $\text{BaSO}_4$ ).

In the natural environment, a high rate of a dominant anion mineral species, for example chloride in sea water, polders, mangroves, natural salinas, can prevent precise measurement. Oxidation is essential in hydrogeothermal mediums as well as in acid sulphated soils with pyrite rich in sulphides.

It should be noted that organic anions have an equivalent conductance lower than that of inorganic anions and give narrower peaks. Acetic acid should be preferred to oxalic acid because of the insoluble salts the latter forms with calcium.

The elution order of anions may vary depending on the operating conditions. In most cases the following series is observed in increasing order of retention time:  $F^- < Cl^- < NO_2^- < NO_3^- < PO_4^{3-} < Br^- < SO_4^{2-}$ . The  $SO_3^{2-}$  peak is not usually separated from the  $SO_4^{2-}$  peak. A  $S_2O_3^{2-}$  peak seldom appears. More information can be found in the works of Tabatabai and Dick (1979), Tabatabai et al. (1988), Tabatabai and Bremner (1991), Artiola and Ali (1990), Tabatabai and Basta (1991), Kamarkar and Tabatabai (1992), Aswa and Tabatai (1993), Tabatabai and Frankenberger (1996).

### 30.2.11 Total S Titration by Plasma Emission Spectrometry

Soil samples weighing from 0.5 g to 2 g are used. The soil is air dried and crushed to 0.1 mm and mineralized by alkaline fusion (cf. Sect. 31.2.6 of Chap. 31) or ignition by  $NaHCO_3/Ag_2O$  or  $NaBrO$ . The total sulphur obtained in sulphate form is dissolved in a 1 mol (HCl)  $L^{-1}$  solution, filtered and brought to the required volume.

The emission line at 182.03 nm is used to limit calcium interference in measurement of the background noise at 182.08 nm.

Interference by iron and aluminium must be controlled. Iron presents a weak emission line at 182.04 nm and a broad diffuse emission band at 182.02–182.12 nm. Aluminium presents an emission band from 193 to 181.9 nm.

Salt contents must not be too high to avoid obstruction of the nebulizer (Perrott et al. 1991).

### 30.2.12 Titration by X-ray Fluorescence

It should be noted that this method can only be used by geo-chemistry laboratories able to justify the cost of semi-heavy equipment. This is the reference method described in Sect. 31.3.2 of Chap. 31. For total S, the procedure involves fusion and pelletizing. If organic matter contents are high (histosols, andosols, peats), weight losses mean the matrix effects will require correction (Tabatabai and Bremner, 1970b).

### 30.2.13 Titration by Atomic Absorption Spectrometry

In this case titration is indirect. After oxidizing mineralization, the sulphates obtained are precipitated in barium sulphate. After separation of

the precipitate, washing and acid dissolution, the barium corresponding to the initial sulphate ions is titrated at 553.5 nm with an acetylene–nitrous oxide flame and correction of background noise.

### 30.2.14 Analytical Fractionation of Sulphur Compounds

#### *Forms of Sulphur and their Biogeochemical Cycle*

In the natural environment, soil is subjected to phases of mineralization and immobilization of S compounds controlled by the activity of micro-organisms, climatic constraints and vegetation. The S biogeochemical cycle is linked to the C and N cycle and the establishment of characteristic C:S and N:S ratios enables net losses and increases to be determined.

The weathering of mineral compounds, inputs from irrigation and rainwater of the gaseous form of S from the atmosphere, inputs of fertilizer in agricultural areas enables plants to find the energy they need for growth. They transform sulphate (the most stable and oxidized mineral form) into complex organic compounds linked to C and N. The plant residues are then subjected to complex biotic processes of reduction and oxidation. Organic and inorganic S is transformed and partly incorporated in the microbial and fungic biomass. The intensity of flows from the different S pools varies considerably depending on the type of soil and vegetation. At equilibrium in a given system, organic forms of S can represent up to 90% of total S.

#### **Organic S**

The chemical nature of sulphur compounds in soil organic matter is complex and has not yet been clearly defined. Reliable methods to specifically isolate the total organic S pool are not yet available. First, organic S is quantified by the difference between total S (obtained by alkaline fusion, or a wet oxidation process) and inorganic S obtained by extraction using water, diluted acids (HCl), or salts (NaHCO<sub>3</sub>).

The study of the chemical nature of the S compounds in soil resulted in two groups whose properties and behaviour were recognized to be different, but whose limits were not clearly defined (Tabatabai and Bremner 1970b; Freney et al. 1970).

### *S organic Compounds Bound to C (S-C)*

This group includes compounds containing sulphur amino acids like:

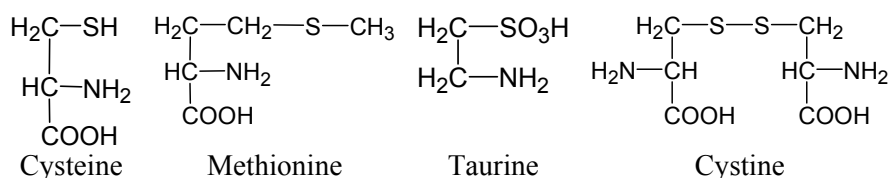

These compounds resist to microbial attacks and are hydrolyzed very slowly to sulphate. They are reduced by Raney alloy (Ni-Al), whereas S combined with humic and fulvic acids are not, or only partially, reduced.

### *S organic compounds not directly bound to C*

These compounds are mostly sulphate esters (e.g. C-O-SO<sub>3</sub>H, phenolic esters, polysaccharides), for example, choline sulphate. They are hydrolyzed into sulphates by acids and bases. Compounds with high and low molecular weight can be regarded as transitory forms resulting from short-term mineralization. They are reduced by hydroiodic acid (HI) in hydrogen sulphide.

Other compounds may be retained as they are not reduced either by HI, or by Raney alloy. These compounds can be estimated by difference in the balances, and are probably of the C-S bound type, though this has not yet been demonstrated.

## 30.2.15 Titration of Organic S Bound to C

### **Principle**

These compounds can be estimated by reduction with Raney alloy (nickel – 50% aluminium). In the form of finely divided powder, this alloy reacts quickly in strongly basic medium and enables hydrogenation of the S organic compounds. The reduction is catalyzed by nickel:

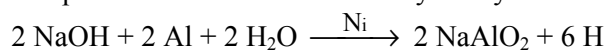

This method is used to determine S bound to C (SC) but also elementary S and certain rare inorganic forms of S in soils (S<sub>2</sub>O<sub>3</sub><sup>2-</sup> thiosulfate, S<sub>2</sub>O<sub>4</sub><sup>2-</sup> dithionite, S<sub>4</sub>O<sub>6</sub><sup>2-</sup> tetrathionate). For example elementary S is reduced in the reaction:

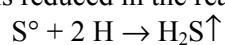

H<sub>2</sub>S released by acidification is titrated by colorimetry using methylene blue (cf. Sect. 30.2.7).

S bound to C can also be estimated by difference between total S and HI reducible S while ignoring unknown products whose presence can distort the results.

### Equipment

- The same equipment as listed in Sect. 30.2.7.
- Adapter for the Johnson and Nishita apparatus (Fig. 30.1) to add hydrochloric acid (Fig. 30.5).
- 150 mL boiling flask (B in Fig. 30.1) with a Teflon sleeve.

### Reagents

- Sodium hydroxide (NaOH) in pellet form.
- 5% soda solution. Dissolve 50 g of NaOH in 800 mL water; homogenize, let cool and complete to 1,000 mL with deionized water.
- 20% hydrochloric acid (HCl,  $d = 1.17$ ) solution.
- Activated Raney alloy catalyst in powder form; the Raney alloy gradually loses its reducing power after about 6 months; it is classified “suspected to be carcinogenic”.

### Procedure

- Dry the soil in the air and crush to 0.1 mm. Measure residual moisture. Weigh 0.2–0.5 g of soil containing from 10 to 50  $\mu\text{g}$  of C bound S in a boiling flask (B in Fig. 30.1) for digestion. Add 100 mg of Raney catalyst, 5 mL of 5% soda solution, and 25 mL of deionized water and homogenize. Fit a Teflon sleeve on the ground glass joint of the boiling flask and attach it to the apparatus. Open the water flow in the condenser; start a nitrogen flow of 200 mL min<sup>-1</sup> into the reaction mixture. Boil gently for 30 min avoiding the formation of excess foam. Let cool under a stream of nitrogen.
- Put the reagents in the washing column D and reception flask F (Fig. 30.1) of the Johnson and Nishita apparatus as described in “Procedure” under Sect. 30.2.7. Using the adapter shown in Fig. 30.5, add 5 mL of 20% hydrochloric acid solution to the boiling flask (B). Continue bubbling and boil gently for 30 min until complete displacement of hydrogen sulphide. Produce and titrate methylene blue as described in “Procedure” under Sect. 30.2.7. Check there are no traces of precipitated sulphide on the walls of the flask.



**Fig. 30.5.** Adapter to add hydrochloric acid for the determination of S bound to C using the Johnson and Nishita apparatus (see Fig. 30.1)

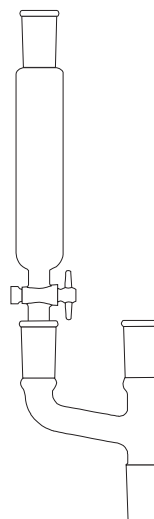

### **Remark**

The result of the analysis can be checked by adding standard compounds of known composition. For example for an amino acid sample (L-methionine), weigh 116.3 mg of L-methionine and dissolve in approximately 300 mL of water. Bring to 500 mL with deionized water. The solution contains 50 mg (S) L<sup>-1</sup>. Take 600 μL and transfer in the boiling flask (B in Fig. 30.1).

## **30.2.16 Titration of Organic S not Bound to C**

### **Principle**

This method is based on reduction by hydroiodic acid; it enables extraction of the most unstable forms of organic S which can be hydrolyzed into sulphate S in strongly basic and acid mediums. S-organic compounds in the form of sulphate esters (C–O–S– bonds) are reduced as are S-polysaccharides, S-lipids, S-choline. Some components of fulvic and humic acids are also reduced. Soluble inorganic forms of S (in water or 0.1 mol (LiCl) L<sup>-1</sup> solution) are also reduced, which means the results need to be corrected:

HI-reducible organic S = HI-reducible total S – soluble inorganic S

The main redox reactions between sulphur and iodine compound were reported by pioneer chemists:

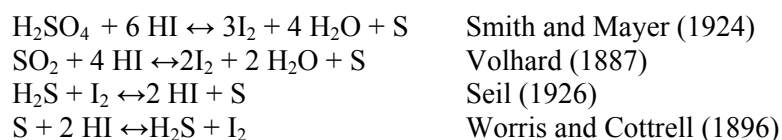

### Equipment

- Johnson and Nishita apparatus (Fig. 30.1)
- Lab glassware
- Precision balance ( $\pm 1/10$  mg)

### Reagents

- cf. “Reagents” under Sect. 30.2.

### Procedure

Dry in the air a recently sampled soil sample and crush to 0.1 mm. Measure residual moisture.

- Weigh 0.2–0.5 g of soil containing between 20 and 100  $\mu\text{g}$  of total S and put it in the distillation flask (B in Fig. 30.1) of the Johnson and Nishita apparatus. Add 2 mL of water and 4 mL of reducing mixture ( $\text{HI} + \text{H}_3\text{PO}_2 + \text{HCOOH}$ ) and carry out reduction as in Sect. 30.2.15 followed by methylene blue colorimetry (cf. Sect. 30.2.7).
- Correct the results for moisture and the rate of inorganic S extractable by water or 0.1 mol (LiCl)  $\text{L}^{-1}$  solution (cf. “Principle” under Sect. 30.2.16).

### Remarks

- The use of fresh samples stored in the freezer limits the degradation of HI-reducible S compounds.
- In air-dried samples rich in organic matter, light particles can float and may have bad contact with the water; swirl the flask well to homogenize.
- The efficiency of the reducing treatment can be tested on a sample of 4-nitrophenyl sulphate (potassium salt,  $\text{O}_2\text{NC}_6\text{H}_4\text{OSO}_3\text{K}, \text{H}_2\text{O}$ ).

### 30.2.17 Extraction and Titration of Soluble Sulphides

#### Principle

The hydrogen sulphide is moved in a closed environment by hydrochloric acid and collected in a zinc and cadmium acetate solution. The resulting zinc and cadmium sulphides are titrated by iodometry according to the reactions:

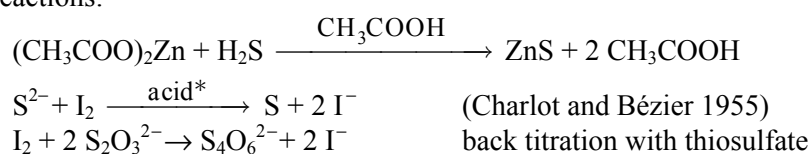

\*The redox potential of I is independent of pH up to pH 9, but iodine can be more oxidizing at higher pH values than in other systems whose redox potential decreases with an increase in pH. This is why it is necessary to use an acid medium. In a basic medium, the following reaction can occur:

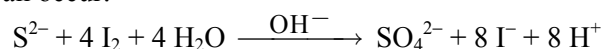

#### Equipment

- Analytical balance ( $\pm 0.1$  mg)
- Distillation apparatus (Fig. 30.1)
- Washing bottles
- Titration burette ( $\pm 1/10$  mL)
- Lab glassware

#### Reagents

- Zinc acetate,  $\text{Zn}(\text{CH}_3\text{COO})_2$ .
- Cadmium acetate,  $\text{Cd}(\text{CH}_3\text{COO})_2$ .
- Acetic acid,  $\text{CH}_3\text{COOH}$ .
- *Mixed solution.* Weigh 17 g of zinc acetate and 8 g of cadmium acetate; dissolve in a mixture of 200 mL of acetic acid and 600 mL of distilled water; bring to 1,000 mL with distilled water.
- Hydrochloric acid,  $\text{HCl}$ ,  $d = 1.16$ .
- $\approx 1 \text{ mol (HCl) L}^{-1}$  solution. Take 100 mL of concentrated hydrochloric acid and bring to 1,000 mL with distilled water.

- Soluble starch powder.
- Mercuric iodide,  $\text{HgI}_2$ .
- *Starch indicator*. Weigh 10 g of starch powder and dissolve in 50 mL of distilled water. Add 40 mg of mercuric iodide (or 40 mg of hydroxybenzoic acid) as preservative agent. Pour the mixture into 950 mL of boiling distilled water. Boil for 2 min. Let cool and complete to 1,000 mL. Store in a brown bottle stopped with emery. The solution is stable for approximately 6 months. The indicator is blue up to pH 8.0 and colourless above this limit.
- 0.1 N iodine, commercial volumetric solution.
- 0.1 N sodium hyposulfite ( $\text{Na}_2\text{S}_2\text{O}_3 \cdot 5\text{H}_2\text{O}$ ), commercial volumetric solution.
- Carbon dioxide,  $\text{CO}_2$  in a gas bottle with a pressure reducer and regulator.

### **Procedure**

Using the technique of Gony and Parent (1966), weigh the fresh sample (50 g) and place it in a boiling flask with a ground glass joint (another sample specimen should be used to measure the soil moisture). Add 50 mL of 1 mol (HCl)  $\text{L}^{-1}$  solution. Switch on the condenser (Fig. 30.1) and set up two consecutive wash-bottles filled with 50 mL of zinc and cadmium solution at the gas outlet. Boil gently for 1 h. While transferring the hydrogen sulphide in a flow of carbon dioxide (3–4 bubbles a second) in the first wash-bottle. The second wash-bottle makes it possible to check if all hydrogen sulphide has been trapped.

### **Titration**

In the first wash-bottle, add 5 mL of the 0.1 N iodine solution (or 10 mL of 0.01 N iodine solution if the sulphide precipitate is weak) then 2 mL of the starch indicator. Titrate the excess iodine with 0.1 N (or 0.01 N) sodium hyposulfite solution.

### **Calculations**

1 mL  $\text{Na}_2\text{S}_2\text{O}_3$  0.1 N = 1.603 mg of S  
The results are expressed in g (S)  $\text{kg}^{-1}$  of soil dried at 105°C.

### **Remarks**

The action of cold hydrochloric acid enables free hydrogen sulphide and  $\text{H}_2\text{S}-\text{S}$  of amorphous iron sulphide to be moved. Mackinawite and

greigite, which are more stable forms of iron minerals, only react when hot. Micro crystallites of pyrite do not react in this hydrochloric medium.

Other volatile compounds can be identified in a waterlogged natural environment, e.g. a combination of S and C synthesized by micro-organisms:

CS<sub>2</sub> Carbon disulphide (CH<sub>4</sub> methane + 4S → CS<sub>2</sub> + 2H<sub>2</sub>S),  
CH<sub>3</sub>-SH methyl mercaptan,  
CH<sub>3</sub>-S-CH<sub>3</sub> dimethyl sulphide,  
CH<sub>3</sub>-S-S-CH<sub>3</sub> dimethyl disulphide,  
CH<sub>3</sub>-CH<sub>2</sub>-S-CH<sub>2</sub>-CH<sub>3</sub> diethyl sulphide,  
C-O-S carbonyl sulphide.

### 30.2.18 Titration of Sulphur in Pyrites

#### *Introduction*

Pyrites, sulphides and polysulphides formed in reducing mediums can be observed in soils in the form of small black concretions. As the density of pyrite is 5.02, it can be isolated by washing and flotation. These compounds deteriorate rapidly in oxidizing medium. In waterlogged soils, proteolytic bacteria are able to release hydrogen sulphide by hydrolysis of sulphur compounds like sulphured amino acids (e.g. cysteine, cystine, methionine). The process can also occur by reduction of sulphate.

Studies of the diagenesis of pyrite compounds led to the identification of complex reaction kinetics where the sulphur reduced to hydrogen sulphide reacts with the amorphous reduced compounds of iron to form a metastable iron sulphide which crystallizes in the form of tetragonal mackinawite (FeS), thermally stable hexagonal pyrrhotite (FeS), greigite Fe<sub>3</sub>S<sub>4</sub>, orthorhombic marcasite in old sediments, or cubic pyrite in recent marine sediments. This authigenic pyrite form is thermally stable and must be measured because it is the end product of a process of evolution.

Pyrite is insoluble in hot hydrochloric acid, which means it can be distinguished from other soluble sulphides titrated using the method described in Sect. 30.2.17.

### Tests

X-ray diffractometry (XRD) is an excellent way to determine pyrites extracted by flotation. But generally XRD is not sensitive enough to detect the intermediate phases without concentration. Table 1 lists the characteristic XRD peaks of pyrite, marcasite, greigite and mackinavite.

In differential thermal analysis (DTA), pyrite presents endothermic reactions at 354, 443, 551 and 613°C and an exothermic peak at 450°C.

Under the scanning electron microscope (+EDX microprobe), pyrite is easily detected in the form of 1–10 µm grains of characteristic raspberry shape. This enables the pyrites of biogenic origin to be distinguished from the crystalline pyrite clusters found in volcanic environments.

### Principle

In the case of reducing soils without sulphate or jarosite, the sample should be used on which the reduced compounds of sulphur (different non-pyrite sulphides) and the ferric and ferrous compounds have already been extracted in hydrochloric acid medium. This sample is then oxidized by hot nitric acid. The solubilized iron is titrated by atomic absorption spectrometry.

If the soils contain both oxidized (sulphate-jarosite) and reduced (pyrites) minerals, the sample should be used on which the Na<sub>3</sub>-EDTA soluble forms have already been extracted. Sulphates obtained by oxidation are titrated by turbidimetry or colorimetry (cf. Sect. 30.2.21).

### Equipment

- Lab glassware
- Freeze dryer
- Thermostatic water bath
- Atomic absorption spectrometer (AAS)

### Reagents

- Nitric acid HNO<sub>3</sub> (70%).
- Hydrochloric acid, HCl,  $d = 1.17$ .
- 4 mol (HCl) L<sup>-1</sup> solution. In a 1 L volumetric flask, put about 500 mL of deionized water and add 320 mL of hydrochloric acid; let cool, complete to 1,000 mL with deionized water and homogenize.
- Commercial standard iron solution for AAS containing 1 mg (Fe) mL<sup>-1</sup>.
- Sodium chloride, NaCl.

- *Dilution solution for the determination of iron (1% NaCl–0.2 mol (HCl) L<sup>-1</sup>)*. Dissolve 10 g of sodium chloride in about 500 mL of water; add 50 mL of 4 mol (HCl) L<sup>-1</sup> solution, complete to 1,000 mL and homogenize.
- *Standard stock solution of iron at 100 mg L<sup>-1</sup>*. Use a precision pipette to put 10 mL of the 1 mg (Fe) mL<sup>-1</sup> standard iron solution in a 100 mL volumetric flask; complete to volume and homogenize.
- *Standard calibration range*. In 100 mL volumetric flasks put 0, 5, 10, 15, 20, 25 mL of the iron solution containing 100 mg (Fe) L<sup>-1</sup>; add 2.5 mL of 4 mol (HCl) L<sup>-1</sup> solution in each flask, complete to 100 mL with deionized water and homogenize. The concentrations of the calibration range are: 0 (blank), 5.0, 10.0, 15.0, 20.0 and 25.0 mg (Fe) L<sup>-1</sup>.

### **Procedure**

- Wash the sample remaining after sulphide extraction (cf. Sect. 30.2.17) then dehydrate by freeze-drying; if necessary crush with an agate mortar to 0.1 mm.
- Weigh a sample of 250–500 mg and place in a 50 mL Pyrex boiling flask.
- Add 10 mL of 70% nitric acid and put in the boiling water bath.
- Evaporate to dry, and then add 5 mL of 4 mol (HCl) L<sup>-1</sup> to the residue and heat for 5 min in the water bath.
- Transfer in a centrifugation tube and centrifuge for 10 min at 5,000g.
- Decant the supernatant in a 100 mL volumetric flask.
- Add approximately 40 mL of deionized water in the centrifugation tube and centrifuge again for 10 min at 5,000g.
- Add the supernatant to the first fraction; filter and wash the soil residue; complete to 100 mL and homogenize.
- Titrate iron in this solution; make a v:v mixture with the 1% NaCl + 0.2 mol (HCl) L<sup>-1</sup> dilution solution and perform the AAS measurement at 248.3 nm in air–acetylene flame.

### **30.2.19 Titration of Elementary Sulphur**

#### **Origin**

In certain soil horizons or in the rhizosphere, the rise of water in the soil due to capillary action starting from a groundwater rich in sulphides can

cause crystallization of elementary sulphur (plots of straw yellow colour) near the soil surface, or in certain soil horizons, or near the plant roots.

### Tests

- Sulphur with a density of 2.07 can be enriched by flotation.
- DTA reveals an enantiotropic change from the orthorhombic into monoclinic form at 113°C under inert atmosphere. Fusion occurs at 124°C, followed by other transformations and boiling at 179°C and 446°C.
- Scanning electron microscopy makes it possible to determine the crystalline system in certain cases (orthorhombic), but stability under the electronic beam is low.

### Principle

After removal of hydrogen sulphide with hydrochloric acid (cf. Sect. 10.2.17), elementary sulphur is extracted with acetone.<sup>5</sup> Titration is by turbidimetric analysis of colloidal sulphur in water (it is also possible to perform Soxhlet extraction in presence of metallic copper, then to titrate the resulting copper sulphide by iodometry, for example).

### Equipment

- Shaker
- Centrifuge
- Spectrophotometer turbidimeter
- Analytical balance ( $\pm 1/10$  mg)

### Reagents

Do not use rubber caps for any reagents that contain sulphur.

---

<sup>5</sup> – Acetone (2-propanone) is the least dangerous solvent of elementary sulphur, in spite of the fact that it is flammable and can cause irritation when inhaled. S solubility in acetone is 2.65 g for 100 mL at 25°C.

Other solvents are more dangerous and should be avoided:

- Benzene S (solubility 24 g L<sup>-1</sup> at 30°C) is toxic by inhalation and carcinogenous.
- Trichloromethane (chloroform) CHCl<sub>3</sub>, S solubility 15 g L<sup>-1</sup> at 18°C toxic by inhalation, and anaesthetic.
- CH<sub>2</sub>I<sub>2</sub> – di-iodomethane (methylene iodide) S solubility 91 g L<sup>-1</sup> at 10°C viscous, high density).
- Pyridine C<sub>5</sub>H<sub>5</sub>N toxic by inhalation.



- Acetone,  $\text{CH}_3\text{--CO--CH}_3$ .
- 99.99% (or 99.5%) sulphur S.
- *Calibration range of elementary sulphur.* Weigh 62.5 mg of sulphur in fine powder form and transfer in a 250 mL boiling flask; add 150 mL of acetone and shake until complete dissolution; transfer in a 250 mL volumetric flask, complete to volume with acetone and homogenize; 1 mL contains 0.25 mg of elementary sulphur; put (0) 1, 2, 3, 4, 5 mL of this standard solution in 100 mL volumetric flasks containing 80 mL of water; homogenize acetone contents by adding 5 mL of acetone in flask 0, 4 mL in flask 1, 3 mL in flask 2, 2 mL in flask 3, 1 mL in flask 4, 0 mL in flask 5; complete to volume with water and homogenize;

The contents of the calibration range are 2.5, 5.0, 7.5, 10.0, 12.5 mg (S)  $\text{L}^{-1}$ .

### **Procedure**

- Use the solid residue remaining after sulphide extraction (cf. Sect. 30.2.17). Wash the residue, freeze-dry it, and again crush to 0.1 mm if necessary. Weigh 250 mg of the residue in a 20 mL centrifugation tube with a polypropylene screw cap. Add exactly 10 mL of acetone, shake for 30 min and centrifuge for 15 min at 5,000g.
- Put 80 mL of deionized water in a 100 mL volumetric flask. Using a precision pipette, add 5 mL of the acetone extract. Shake and complete to 100 mL with deionized water. Let stand for 3 h with occasional shaking. Measure absorbance at 420 nm.

The absorbance vs concentration response is linear in the calibration range. Organic matter can interfere by co-precipitation or colouring.

## **30.2.20 Titration of Water Soluble Sulphates**

### **Forms**

Sulphated salts are of marine origin but have undergone transformation during soil genesis, i.e. reduction, reoxidation, leaching and precipitation. Sulphates can be found in calcium sulphate form in calcareous-rich soils (cf. Sect. 30.3). Tropical soils, which are generally poor in calcium, are more likely to contain sodium sulphate in deteriorated zones or very

soluble mixed sulphates (alums) of aluminium, iron and magnesium (Le Brusq et al. 1987; Montoroi, 1994).

### **Extraction**

Soluble sulphate can be titrated on the 1:10 aqueous extract for the determination of soluble salts (cf. Chap. 20). This extract will quantitatively account for calcium sulphate only in the case of low sulphate contents. The same goes for barium or strontium sulphates coprecipitated with calcium carbonate. Basic sulphates of iron and aluminium, coquinbite ( $\text{Fe}_2(\text{SO}_4)_3 \cdot 5\text{H}_2\text{O}$ ) and jarosite  $\text{KFe}_3(\text{OH})_6(\text{SO}_4)_2$ , are not solubilized and are thus not accounted for with soluble sulphates.

For agronomic studies, a range of saline extracts can also be used to characterize exchangeable and soluble sulphate (cf. Sect. 30.4.2).

### **Equipment**

- Lab glassware
- Analytical balance ( $\pm 1/10$  mg)
- Muffle furnace (1,000°C)

### **Reagents**

- 10% Barium chloride ( $\text{BaCl}_2$ ) solution
- 10% Hydrochloric acid ( $\text{HCl}$ ) solution
- 1% Silver nitrate ( $\text{AgNO}_3$ ) solution

### **Procedure**

Take an aliquot of the 1:10 water extract (cf. Chap. 18) as a function of total soil salinity (20–50 mL). Put in a 250 mL beaker and add 5 mL of the 10% hydrochloric acid solution. Bring to the boil and add the barium chloride solution in the boiling liquid drop by drop. Let cool and leave to stand for 24 h. Filter on blue laboratory filter with a diameter of 20 mm, wash the precipitate until elimination of chloride (silver nitrate test). Put the filter in a tared refractory crucible and heat to 900°C in the muffle furnace in contact with the air. Let cool, weigh and calculate the results in  $\text{mmol } (\frac{1}{2}\text{SO}_4^{2-}) \text{ L}^{-1}$  and  $\text{mg (S) kg}^{-1}$ .

### 30.2.21 Titration of Na<sub>3</sub>-EDTA Extractable Sulphates

#### Principle

Gypsum, little soluble sulphate and exchangeable sulphates are extracted by the Na<sub>3</sub>-EDTA sequestering reagent. The extracted SO<sub>4</sub><sup>2-</sup>-S is measured by turbidimetry after precipitation of barium sulphate.

#### Equipment

- Lab glassware
- Shaker
- Thermostatic water bath
- Spectrophotometer

#### Reagents

- Trisodic ethylene diamine tetraacetic acid (Na<sub>3</sub>-EDTA) monohydrate,

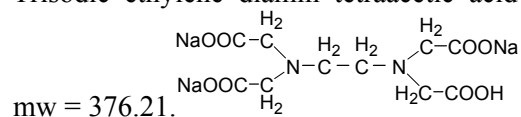

- 0.1 mol L<sup>-1</sup> Na<sub>3</sub>-EDTA solution. Dissolve 18.8 g of Na<sub>3</sub>-EDTA in about 250 mL of water, bring to 500 mL and homogenize.
- 65% nitric acid, HNO<sub>3</sub>.
- 37% hydrochloric acid, HCl.
- *Aqua regia*. Under a fume hood, mix 180 mL of 37% HCl and 60 mL of 65% HNO<sub>3</sub> in a beaker and cover with a beaker cover.
- 25% nitric acid solution. Add 600 mL of water and 360 mL of nitric acid in a 1 L graduated cylinder; let cool, bring to 1,000 mL with deionized water and homogenize.
- 85% phosphoric acid, H<sub>3</sub>PO<sub>4</sub>.
- Glacial acetic acid, CH<sub>3</sub>COOH.
- *Acetic acid phosphoric acid solution*. Mix 180 mL of glacial acetic acid and 60 mL of 85% phosphoric acid.
- *Gum arabic and acetic acid*. Weigh 0.5 g of gum arabic and dissolve in 50 mL of deionized water; add 50 mL of glacial acetic acid; mix and filter on hardened acid-resistant laboratory filter.
- Sodium sulphate, Na<sub>2</sub>SO<sub>4</sub>.
- 0.3% sodium sulphate solution. Dissolve 0.3 g of sodium sulphate in 100 mL of deionized water.

- Barium chloride,  $\text{BaCl}_2, 2\text{H}_2\text{O}$ .
- *Barium chloride solution*. Dissolve 18.0 g of barium chloride in 44 mL of water heated to  $80^\circ\text{C}$ ; add 1.5 mL of 0.3% sodium sulphate solution; bring to the boil; cool rapidly and add 4 mL of gum arabic-acetic acid solution; prepare before each analysis series.
- Standard calibration range  $\text{S-SO}_4^{2-}$  (cf. Sects. 30.2.7 and 30.2.8).

### Procedure

#### Extraction

This method is adapted from Buurman et al. 1996. The soil sample is freeze-dried and crushed to 0.1 mm (moisture is measured on another sample specimen).

- Weigh a 250 mg sample and put it in a 20 mL polypropylene centrifugation tube. Add 10 mL of the  $\text{Na}_3\text{-EDTA}$  solution and agitate on a rotary agitator for 3 h. Centrifuge for 15 min at 5,000g (after washing, the centrifugation pellet can be kept for jarosite analysis, if required).
- Put 2 mL of the supernatant liquid in a 50 mL Pyrex capsule. Add 2 mL of aqua regia and 1 mL of 85% phosphoric acid. Evaporate in a boiling water bath until nearly dry, then add 2 mL of aqua regia and evaporate. Add 10 mL of deionized water and put in the boiling water bath for a few minutes. Let cool, homogenize and transfer in a 50 mL volumetric flask. Wash, complete to 50 mL with deionized water and homogenize.

#### Titration

- With a precision pipette, transfer 20 mL of the extraction solution (see “Titration” under Sect. 30.2.21) in a 50 mL volumetric flask with a ground stopper. Add 10 mL of water, 5 mL of 25% nitric acid solution and 3 mL of glacial acetic acid. Homogenize, add 1 mL of barium chloride solution and immediately add 0.5 g of  $\text{BaCl}_2, 2\text{H}_2\text{O}$  in powder form, swirl the flask after each addition.
- After 15 min shake, then again after 5 min. Add 2 mL of gum arabic-acetic acid solution. The reagent addition must be very constant<sup>6</sup>. Bring

<sup>6</sup> The kinetics of precipitation of barium sulphate in solutions containing hydrochloric acid (to avoid the precipitation of calcium sulphate and of sulphates of heavy di- and quadrivalent elements which can interfere with titration) must be controlled by respecting a strict procedure. Precipitation is slowed down by hydrochloric acid. Acid concentration, temperature, the solution to  $\text{BaCl}_2$  ratio, the concentration of  $\text{BaCl}_2$ , addition of saline products and mode of addition can upset the uniformity of charge distribution, and the regularity of nucleation and granulation kinetics.



Jarosite ( $\text{KFe}_3(\text{OH})_6(\text{SO}_4)_2$ ) appears at the same time as the formation of sulphuric acid, which can make the drained soils very acid (sulphuric horizons, sulfaquept, sulfohemist). Some clay lattice structures can become unstable. Aluminic acidity can appear.

Glauconite alteration is a source of potassium for the production of jarosite in this environment. In marine environments, natrojarosite ( $\text{NaFe}_3(\text{OH})_6(\text{SO}_4)_2$ ) can be found. The ammonium ion obstructs the formation of these compounds. Jarosite is metastable at  $\text{pH} < 4.5$  in soil and can be hydrolyzed into goethite- $\text{FeO}(\text{OH})$  which results in the appearance of rust-coloured spots at the top of soil profiles.

Jarosite and natrojarosite produce yellow efflorescence in the soil when drying, or near plant roots. Chamayou and Legros (1989) described a series of chemical reactions concerning pyrite oxidation in these soils. One pyrite mole produces one  $\text{H}^+$  mole when all the iron is oxidized into ferric iron:



If the medium is not sufficiently oxygenated, iron remains in ferrous form but acidification is high:

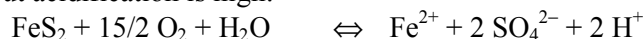

Acidification is also high if iron is transformed into ferric hydroxide. The soil pH can reach pH 2 in very wet but well-aerated soil:

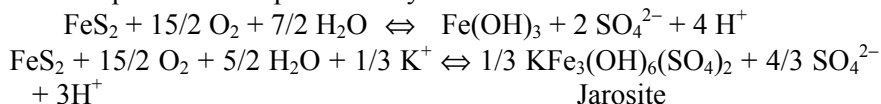

## Tests

Yellow efflorescences on the surface of the soil or near plant roots can be collected and stored in sealed flasks after rapid drying in the air. Purity is about 80%.

XRD spectra can be obtained after saturation treatments with magnesium or potassium cations, glycerol treatment and heating to 300 and 550°C (cf. Chap. 4). Inter-reticular distances enable identification of:

K jarosite 3.08–3.11–2.29 Å (copper radiation on powder)

Na jarosite 5.06–3.06–3.12 Å (copper radiation on powder)

DTA in nitrogen atmosphere (cf. Chap. 7) gives an exo-thermic peak near 500°C corresponding to a  $\text{KFe}_3(\text{SO}_4)_2(\text{OH})_6$  degradation giving  $\text{K}_2\text{SO}_4$ ,  $\text{X}_2(\text{SO}_4)_3$ . The second peak near 800°C corresponds to decomposition of  $\text{X}_2(\text{SO}_4)_3$ . An endothermic peak is also observed at 416°C.

Scanning electron microscopy (cf. Chap. 8) reveals cubic particles with small octahedral faces. Measurement of the 1:2.5 water pH just after the soil and water is mixed, then 24 h later reveals acidification induced by jarosite hydrolysis.

---

**Principle of Titration**

After determination of Na<sub>3</sub>-EDTA soluble sulphates, (cf. Sect. 30.2.21). The solid residue of the soil sample is used for titration of jarosite. Jarosite is dissolved in hot hydrochloric acid which does not attack pyrite. The extracted sulphate is titrated by turbidimetry using the barium method.

**Equipment**

- Lab glassware
- Thermostatic water-bath
- Spectrophotometer
- Centrifuge.

**Reagents**

- 37% hydrochloric acid, HCl.
- 4 mol (HCl) L<sup>-1</sup> solution. Under a fume-hood add about 500 mL of deionised water then 320 mL of 37% hydrochloric acid in a 1 L graduated cylinder. Cool, complete to 1,000 mL with deionized water and homogenize.
- See also reagents for Na<sub>3</sub>-EDTA analysis (“Reagents” under Sect. 30.2.21).

**Procedure**

- After determination of Na<sub>3</sub>-EDTA soluble sulphates, wash the residue twice by centrifugation for 10 min at 5,000g with 10 mL of deionized water. Discard the washing water.
- Transfer the residue in a 50 mL beaker and add 10 mL of 4 mol (HCl) L<sup>-1</sup> solution. Cover with a beaker cover and place in a boiling water-bath for 2 h. Let cool, transfer in a centrifugation tube and centrifuge for 10 min at 5,000g. Decant the supernatant in a 50 mL volumetric flask, bring to volume with deionized water and homogenize. Titrate sulphate in this solution by turbidimetric titration as in “Titration” under Sect. 30.2.21 above. The soil residue can be used for pyrite titration (cf. Sect. 30.2.18).

### 30.2.23 Sequential Analysis of S Forms

Analytical objectives and environmental conditions determine the choice of the methods described earlier. These analyses can also be performed in sequence depending on the solubility criteria and the order of elimination of titrated S forms. The method in Fig. 30.6 was recommended for acid sulphated soils by the Department of Soil Science and Geology of Wageningen Agricultural University (Buurman et al. 1996).

IC may be suitable for sulphur anions, but the carrier solution can react with some forms. For example,  $\text{H}_2\text{S}$  and  $\text{H}_2\text{S}_2\text{O}_3$  are not stable in acid medium; polysulphides produce elementary sulphur or hydrogen sulphide.

An original chemical approach was proposed by Sonne and Dasgupta (1991) for analysis of inorganic S forms in kerogen zones. The simultaneous analysis of sulphide, polysulphides, sulphite, thiosulphate and sulphate is performed by automated continuous-flow injection analysis (FIA) using turbidimetric and colorimetric detection on soil water extracts and saline waters. A complex manifold enables simultaneous measurement of:

- Sulphides and polysulphides by moderate acidification of the medium and displacement of sulphur; turbidimetric measurement of colloidal sulphur enables quantification of polysulphides; colorimetric measurement using pentacyanonitroferrate (II) in alkaline medium enables quantification of the resulting hydrogen sulphide (sulphite does not cause interference).
- Sulphites by displacement of sulphur dioxide and colorimetric measurement specific to  $\text{S}^{\text{IV}}$  valence (discolouring of triphenylmethane in neutral solution).
- Thiosulphates by discolouring of potassium permanganate in weak acid medium after precipitation of sulphide and polysulphide and sequestering of sulphite by hydroxymethylsulphonate.
- Sulphates with turbidimetric measurement after precipitation with barium chloride; the precipitation of polysulphide is compensated for by differential measurement of absorbance before and after the addition of barium chloride.



Fig. 30.6. Sequential analysis of sulphur forms in acid sulphated soils (\*gypsum, slightly soluble or extractable sulphates)

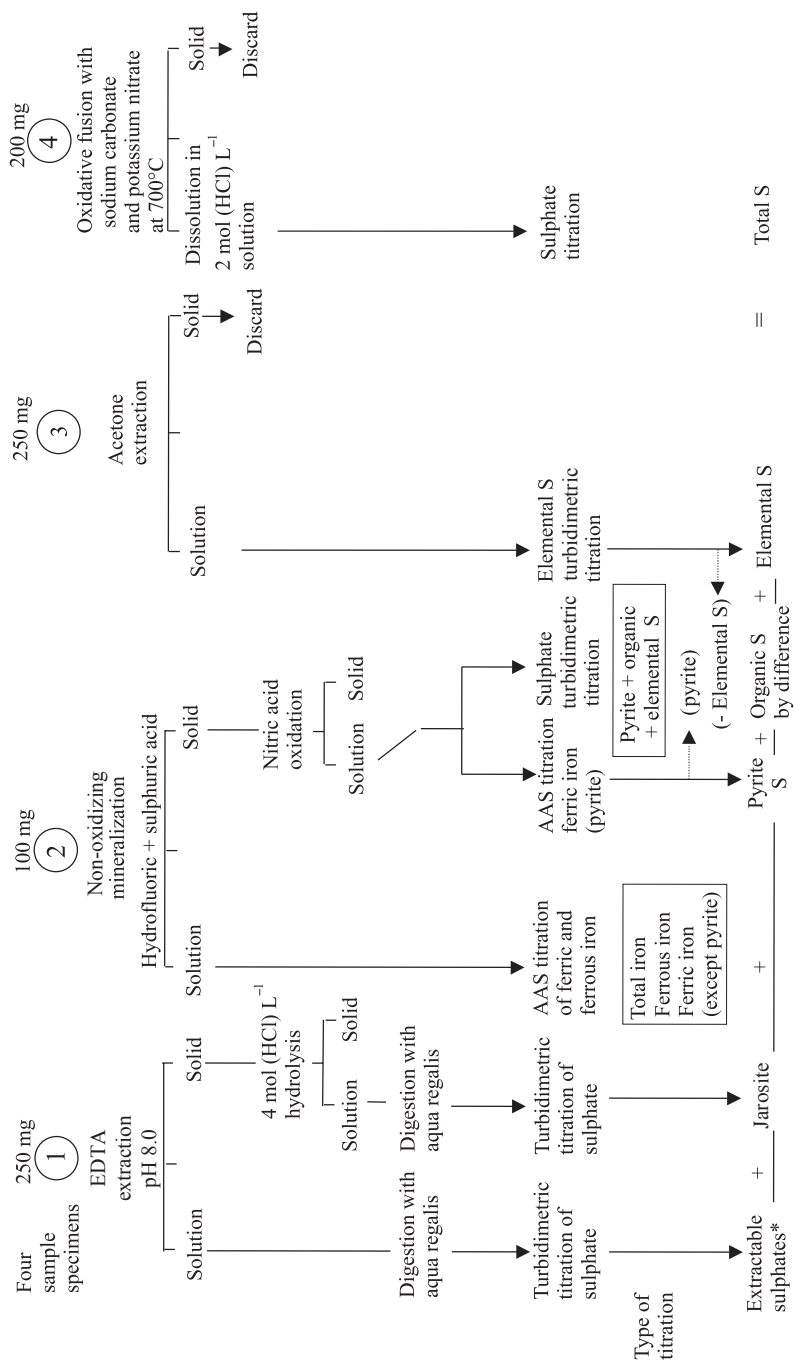

### 30.3. Sulphur of Gypseous Soils

#### 30.3.1 Gypseous Soils

In mangrove soils, calcium sulphate can originate from original sediments or from transformations undergone by different sulphur compounds during soil genesis in these specific environments. But calcium sulphate contents are generally low and these are titrated at the same time as insoluble sulphates of the jarosite type (cf. Sects. 30.2.20, 30.2.21, 30.2.22).

Real gypseous soils (*gyposols*, *gypsisols*) are characteristic of arid and semi-arid zones and are common in North Africa and the Middle East. The main source of gypsum is evaporitic material. Calcium sulphates are also redistributed by water transport in these soils. Newly formed gypsum can also accumulate deep in certain soils in easily flooded environments and is linked to the genesis of hydromorphic or saline soils.

The forms of calcium sulphate observed in these soils belong to three principal chemical components linked to the degree of dehydration of salt:

- Gypsum,  $\text{CaSO}_4 \cdot 2\text{H}_2\text{O}$ , which represents the most stable phase
- Bassamite,  $\text{CaSO}_4 \cdot 0.5\text{H}_2\text{O}$ , semi-hydrated phase
- Anhydrite,  $\text{CaSO}_4$  with no water molecule

The solubility of gypsum in pure water is  $2.6 \text{ g L}^{-1}$  at  $25^\circ\text{C}$ , but its solubility is highly influenced by temperature and by the presence of other salts. Salts like sodium sulphate or calcium carbonate decrease the solubility of calcium sulphate, whereas a salt like sodium chloride considerably increases its solubility. These different degrees of solubility due to salt interactions present serious problems for extraction and titration.

From a quantitative point of view, the gypsum contents measured in a soil can be very high ( $> 50\%$ ), even if its accumulation is not clearly visible (e.g. crust, encrusting, desert rose crystals, cluster nodules, pseudo-mycelium). There are many microscopic forms (Pouget 1995) disseminated in the soil mass.

### 30.3.2 Preliminary Tests

#### *Water of Crystallization*

##### *Principle*

Soil samples containing gypsum have to be subjected to specific treatment because of the lower solubility of calcium sulphate compared to other soluble salts extracted with water (cf. Chap. 30). In the absence of visual confirmation of the presence of gypsum, it is recommended to carry out a preliminary detection test in order to select the most appropriate soil-to-water ratio for complete extraction of the sample.

The principle is based on measurement of the weight loss of a gypseous sample by drying in a drying oven until constant weight compared to weight loss under phosphoric anhydride.

This test gives a reasonably precise estimate of gypsum content. It is quite rapid and can be used for series analyses. The best results are found in the *gypsic* or *petrogypsic* horizons (which can represent 60–85% of gypsum).

##### *Procedure*

- Weigh 5 g of air-dried soil and place it in a desiccator containing phosphoric anhydride or silica gel and leave for 48 h.
- Weigh with the laboratory balance ( $\pm 1/10$  mg); place the sample in a drying oven at 125°C (or 150°C) for 24 h; transfer in the desiccator, let cool and weigh.

Calculate the weight loss. The second weight gives the soil moisture. The third weight gives the loss of water of crystallization from the gypsum.

##### *Remark*

In DTA at low temperatures, a double endothermic peak is observed corresponding to the loss of 1.5 mol H<sub>2</sub>O resulting in hemihydrate, and then to the loss of 0.5 mol H<sub>2</sub>O resulting in anhydrite:

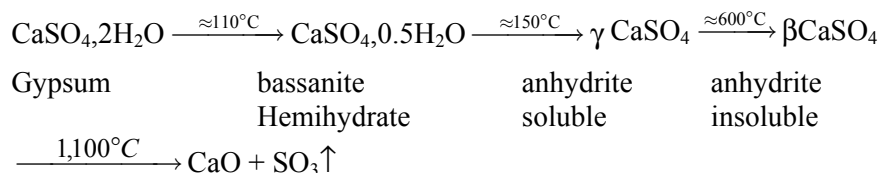

Interferences are minimal if the temperature is kept under (1) the breakdown point of organic molecular structures and (2) the dehydration points of clays and oxides (e.g. gibbsite). At 150°C the results are a little too high.

### XRD Test

– XRD lines at 7.56, 3.059, 4.27 Å

### IR test

Figure 30.7 shows the characteristic spectra of gypsum materials.

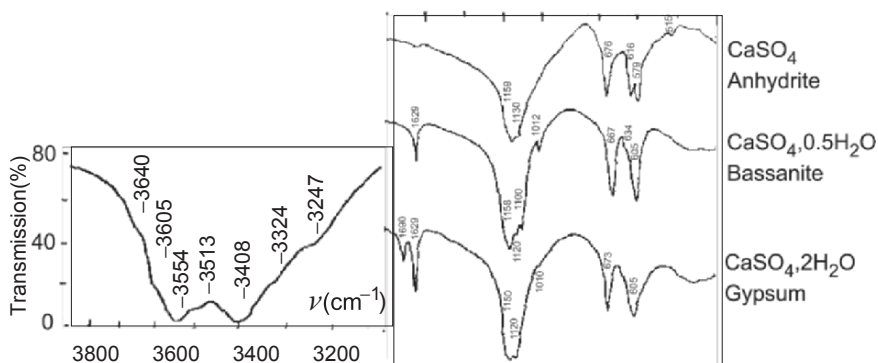

**Fig. 30.7.** Infra-red spectra of gypseous materials (KBr pelletizing); on the left, stretching vibrations of the OH zone: water molecules are in equivalent positions in the lattice, each one forms two hydrogen bonds with the oxygen atoms of the sulphate ion

### Acetone Test

This method is based on the solubility differential. To a given volume of diluted aqueous extract (1:2 or 1:5), the same volume of acetone ( $\text{CH}_3\text{CO-CH}_3$ ) is added. The presence of gypsum is indicated by the immediate formation of varying degrees of off-white precipitate (Richards 1954) depending on the quantity of the dissolved calcium sulphate precipitated in acetone. This test can also be used to titrate gypsum (cf. Sect. 20.3.4).

### 30.3.3 Extraction and Titration from Multiple Extracts

#### **Principle**

All the gypsum in the gypseous sample is not dissolved in a simple saturated extract. Several extractions with more and more diluted aqueous extracts are needed to obtain complete extraction of gypsum. Air-dried samples are generally used rather than oven-dried samples. Loeppert and Suarez (1996) recommend the successive use of three extracts: saturated, 1:4 (soil: water) and 1:40 (gypsum is the least soluble of the sulphated minerals found in significant quantities in soils). The calcium ion is titrated by atomic absorption spectrometry (AAS), and the sulphate anion is titrated gravimetrically using the barium method.

#### **Extraction and Titration**

Prepare about 100 g of air-dried soil sample crushed to 200  $\mu\text{m}$  and homogenized. Split into three fractions of 25 g:

- Use the first fraction to prepare the saturated extract (cf. Chap. 18);
- Extract the second 25 g fraction with 100 mL of deionized water;
- Extract the third fraction with 1 L of deionized water.

Shake the two last soil/water suspensions overnight and then filter. Titrate calcium with AAS at 422.7 nm. Sulphate is titrated by weighing the barium sulphate precipitate obtained with barium chloride.

#### **Calculations**

The molar concentration of gypsum is considered to be that of calcium ions and sulphate ions. Excess calcium content may be due to the release of calcium from exchange complexes, so it is better to use the concentration of sulphate. If  $V_s$  and  $V_1$  (mL) are the respective water volumes of the saturated and diluted extracts, and  $T_{\text{S-SO}_4}$  and  $T_{1\text{-SO}_4}$  are the corresponding sulphate concentrations of the extracts in  $\text{mmol mL}^{-1}$ , the extracted gypsum is expressed in mmoles by:

$$n_{\text{gypsum}} = T_{1\text{-SO}_4} V_1 - T_{\text{S-SO}_4} V_s$$

and the soil concentration is expressed in  $\text{g kg}^{-1}$  by:

$$C_{\text{gypsum}} = 0.172 \times n_{\text{gypsum}} \times 1,000/25 = 6.88 n_{\text{gypsum}}$$

**Remarks**

If the soil is heated to 105°C the night before crushing, gypsum is transformed into bassanite (Rivera et al. 1982) which is more soluble and more rapidly dissolved than gypsum, resulting in a more complete dissolution reaction.

Slightly soluble sulphates (alkaline earth sulphates) and lead, chromium, iron, mercury and bismuth sulphates do not cause significant interference. These elements can, however, be titrated in the extraction solution by AAS if necessary.

**30.3.4 Gypsum Determination by Acetone Precipitation****Principle**

A test of the presence of gypsum (cf. "Acetone Test") can be used for quantitative determination (Buurman et al. 1996). Soil gypsum is dissolved in a water extract at varying degrees of dilution depending on the gypsum content of the sample. The gypsum precipitate is separated and then dissolved again in water. The calcium in the final solution is titrated by AAS.

**Reagents**

- Control sample of pure gypsum,  $\text{CaSO}_4 \cdot 2\text{H}_2\text{O}$ .
- 37% Hydrochloric acid, HCl.
- *Barium chloride solution*. Add 60 g of  $\text{BaCl}_2 \cdot \text{H}_2\text{O}$  in 25 mL of water.
- Acetone,  $\text{CH}_3\text{COCH}_3$ .
- *2% lanthanum oxide solution,  $\text{La}_2\text{O}_3$* . Mix 100 mL of 5% lanthanum solution, 50 mL of 1 mol (HCl)  $\text{L}^{-1}$  hydrochloric acid solution, and complete to 250 mL with deionized water.
- *Calibration range*. Put exactly 5 mL of a 1,000 mg (Ca)  $\text{L}^{-1}$  standard commercial solution in a 100 mL volumetric flask, complete to 100 mL with deionized water giving a 50 mg (Ca)  $\text{L}^{-1}$  stock solution; put successively 0 (blank assay), 5, 10, 20 mL of stock solution in 50 mL volumetric flasks; add 10 mL of the 5% lanthanum solution and bring to 50 mL to give the calibration range 0, 5, 10, 20 mg (Ca)  $\text{L}^{-1}$ .

### Procedure

- Weigh 10 g of soil sample (200 µm particle size) in a 250 mL flask. Add 100 mL of deionized water and shake overnight.
- Put 35 mL of the suspension in a 50 mL centrifugation tube made of transparent glass and centrifuge for 15 min at 3,500g (solution A).
- *To check the presence of calcium sulphate.* Take 3 mL of supernatant and add ten drops of 1 mol (HCl) L<sup>-1</sup> solution and 2 mL of BaCl<sub>2</sub> solution. If the solution remains clear, the soil does not contain gypsum, if a precipitate is formed, continue analysis.
- Take 20 mL of the supernatant solution A. Add 20 mL of acetone, homogenize and wait 10 min. Centrifuge for 10 min at 2,500g and discard the supernatant.
- Dry the centrifugation tube in a ventilated drying oven at 50°C. Let cool, and then add 40 mL of deionized water to solubilize the precipitate. Take 5 mL, add 5 mL of the 2% lanthanum solution and homogenize.
- Analyse calcium by AAS at 422.7 nm after diluting with 1% lanthanum solution if necessary.

### Calculations

If  $C$  and  $B$  are the calcium concentrations of the extract and blank respectively,  $V$  the volume of water used for extraction (100 mL),  $D$  the dilution factor ( $D = 4$  in most cases: 20 mL aliquot of aqueous extract in 40 mL of water, 5 mL of sample specimen mixed with 5 mL of lanthanum solution),  $f$  the moisture corrective factor and  $P$  the soil sample weight, gypsum ( $G$ ) is expressed in mg g<sup>-1</sup> (soil) by:

$$G = \frac{(C - B) V D f}{1,000 P} \frac{M_{CaSO_4 \cdot 2H_2O}}{M_{Ca}} \cong 0.172 (C - B) f.$$

### Remark

If the gypsum content of the soil is higher than 2%, a more diluted soil:water ratio should be used for extraction.

## 30.4. Sulphur and Gypsum Requirement of Soil

### 30.4.1 Introduction

A clear distinction must be made between (1) methods intended to identify requirements and deficiencies in S compounds which is an

essential element for plant growth and (2) the gypsum requirements intended to amend saline soils and to allow them to be cultivated.

S plays a very important role in soil fertility. Its deficiency results in serious plant growth disorders like dwarfism, leaf symptoms, reduction in photosynthetic activity and severe disturbances in fructification.

In wet or semi-wet areas, most S is in organic forms. The multiple organic components and their relationships with plant nutrition are still not well understood. The biochemical synthesis of some essential living components like certain proteolysis enzymes, amino acids and proteins, hormones or glycosides can only be accomplished when S is present in the medium.

A high total S soil content does not provide information about the state of each S form and does not always mean there is sufficient S for plant nutrition. Total S contents can be low, e.g. about 0.05% in peat soils and arid soils.

Simple ratios between C, N and S contents can be calculated as characteristics of links of these three elements in the biogeochemical cycle. The C:N ratio (cf. introduction in Chap. 10) is very widely used in soil science. In the same way, the C:S and N:S ratios are useful data. A low N:S ratio indicates a high level of non-proteinic S. Soluble sulphates are considered to be the most representative of the capacity of the soil to satisfy plant nutritional requirements. But the aptitude of soils to generate this form depends on many factors like (1) the nature and properties of the soil matrix (e.g. pH, CEC, clay content), (2) plant compounds and S content of plant residues, (3) the climatic constraints (especially temperature and moisture) that control microbial activity and (4) changes in aerobic or anaerobic conditions.

Sulphur is subjected to an annual cycle which, in contrasted climates, includes strong oscillations, for example little activity below 10°C and serious leaching in rainy periods.

### 30.4.2 Plant Sulphur Requirement

Soil preparation should not significantly modify the distribution of S forms. But simple air drying can result in an increase in the rate of available sulphate.

Furthermore, variations in S depend on spatial distribution (vertically in a soil profile or horizontally in the surface soil of agricultural land) and time distribution (sampling season, storage and length of exposure to the air). So the interpretation of the results is often difficult.



### ***Microbiological Techniques***

These approaches simulate microbiological and biochemical processes (of the Neubauer type) resembling those in the soil in natural conditions. Constant incubation temperatures are generally used to optimize microbial activity depending on the particular mediums and climatic areas.

The soluble sulphate produced is measured after a given incubation time. Estimation of S requirement for a given crop should be linked (1) to observed yields which represent the global response and (2) if possible to plant analysis (leaf diagnosis) which enable deficiencies to be corrected.

Microbiological techniques require care in the choice of:

- Representative soil and plant samples.
- Dates of sampling allowing evaluation of plant requirements at different stages of the vegetative cycle (seeding, root development and plant growth, flowering and fruit production), and of microbial activity (depending on moisture and temperature) linked to S mineralization or immobilization.

Other plant nutrients, particularly nitrogen, should also be taken into account. These analyses enable scales of correlation to be established with simple, rapid and reproducible methods of extraction using chemical reagents.

### ***Chemical Extraction***

To solubilize the different forms of S, the extracting reagents need to be selective, but in practice, extracting reagents are rarely selective; depending on the reagent used, variable quantities of adsorbed  $\text{SO}_4^{2-}$ -S or hydrolyzed organic S can be solubilized. Insoluble sulphates (like barium sulphate or mixed aluminium and iron sulphate) are not titrated. Elementary sulphur has to be displaced.

The simplest test uses water extraction, but often results in soil dispersion.

Extraction in diluted saline reagents (like  $0.01 \text{ mol (CaCl}_2) \text{ L}^{-1}$ ,  $\text{MgCl}_2$ , 0.15% LiCl) limits dispersion but extracts some adsorbed S. Furthermore, lithium acts as an inhibitor of microbial activity.

Extraction in buffered medium ( $0.25 \text{ mol L}^{-1}$  acetic acid +  $0.5 \text{ mol L}^{-1}$  ammonium acetate) limits the hydrolysis of organic S compounds.

Extraction with the alkaline Olsen reagent ( $0.5 \text{ mol (NaHCO}_3) \text{ L}^{-1}$  at pH 8.5) is better suited for soils with a pH > 7 but sodium hydrogen carbonate can solubilize a little organic S and block the pores of the filter making separation of the solid and liquid phase difficult.

In extraction with phosphate solutions (0.01 M  $\text{KH}_2\text{PO}_4$  or  $\text{Ca}(\text{H}_2\text{PO}_4)_2$ ) the phosphate anion displaces the sulphate anion from the adsorption sites thereby increasing negative surface charges. Some labile S that is available in the short term can be extracted with phosphoric salts thanks to the eluting power of P anions. In decreasing order of eluting power, anions are classified as follows:

hydroxyls > phosphates > sulphates = acetates > nitrates = chlorides

Titration is performed after extraction using the methods described in previous sections: colorimetry (Sects. 30.2.7 and 30.2.8), turbidimetry ("Titration" under Sect. 30.2.21) or AAS (Sect. 30.2.13).

**Remark**

Soils like andosols with high rates of compounds with short range organization (e.g. allophane) can strongly fix  $\text{SO}_4^{2-}$ -S by absorption.

### 30.4.3 Gypsum Requirement

**Introduction**

Sodic soils (sodisols) whose structure is degraded by an excess of exchangeable sodium ( $\text{Na}/\text{T} > 15\%$ ) can be restored by gypsum amendments (or directly by sulphuric acid in the case of calcareous soils). Under rainfall or irrigation water, sodium fixed on the exchange complex (cf. Chap. 22) is progressively replaced by the calcium of gypsum and the soil structure and hydrodynamic properties are progressively improved. The sodium sulphate that results is eliminated from the soil profile by leaching:

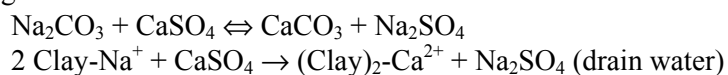

**Equipment**

- Lab glassware
- Mechanical shaker
- Laboratory balance
- Atomic absorption spectrometer

### Reagents

- Calcium sulphate,  $\text{CaSO}_4 \cdot 2\text{H}_2\text{O}$  (gypsum).
- *Saturated solution.* 5 g of  $\text{CaSO}_4 \cdot 2\text{H}_2\text{O}$  in 1 L of deionized water, stir for 1 h, filter on blue analytical filter and measure the exact calcium concentration ( $\text{mmol } (\frac{1}{2}\text{Ca}^{2+}) \text{ L}^{-1}$ ) by AAS.

### Procedure

- Weigh 5 g of air-dried soil in a 250 mL Pyrex flask.
- Using a precise dispenser of volumic fractions add exactly 100 mL of saturated  $\text{CaSO}_4$  solution. Shake for 30 min on a rotary shaker.
- Filter on blue analytical filter (without washing).
- Titrate calcium by AAS on a clear aliquot fraction of the filtrate.

### Calculation

Gypsum requirement ( $B_g$ ) in  $\text{mmol } (\frac{1}{2}\text{Ca}^{2+}) \text{ kg}^{-1}$  (soil):

$$B_g = (A - B) \frac{100}{5} \frac{1,000}{1,000} = 20(A - B)$$

A is the concentration of the initial solution and B is the concentration of the filtrate in  $\text{mmol } (\frac{1}{2}\text{Ca}^{2+}) \text{ L}^{-1}$ .

These results can be expressed in tons (gypsum)  $\text{ha}^{-1}$  as a function of the depth of soil to be transformed. For example, for a depth of 10 cm (1,500 tons (soil)  $\text{ha}^{-1}$  for soil bulk density  $\approx 1.5$ ), the gypsum requirement in  $\text{mol } (\frac{1}{2}\text{Ca}^{2+}) \text{ ha}^{-1}$  is:

$$D_g = 1,500 B_g$$

i.e. in tons (gypsum)  $\text{ha}^{-1}$ :

$$P_g = 0.129B_g$$

### Remarks

In practice, the solid-solution contacts are lower since the sodium exchange by calcium in the field is not the same as in the laboratory. The amount of sodium actually exchanged is consequently lower than the amount calculated in the laboratory and the calculated amount of gypsum amendment should be increased by about 25%.

For example, to exchange 10  $\text{mmol } (\text{Na}^+) \text{ kg}^{-1}$  (soil), it is necessary to add 1,300 kg (gypsum)  $\text{ha}^{-1}$ . Generally the quantities required to improve saline soils are in the range of 5–10 tons (gypsum)  $\text{ha}^{-1}$ .

## References

- Artiola FF and Ali AMS (1990) Determination of total sulphur in soil and plant samples using sodium bicarbonate/silveroxide, dry ashing and ion chromatography. *Commun. Soil Sci. Plant Anal.*, 21, 941–949
- Aswa HA and Tabatabai MA (1993) Comparison of some methods for determination of sulfate in soils. *Commun. Soil Sci. Plant Anal.*, 24, 1817–1832
- Begheijn L and Van Schuylenborgh J (1971) *Methods for the analysis of soils used in the laboratory of soil genesis of the Department of Regional Science*, Wageningen
- Bremner JM and Tabatabai MA (1971) Use of automated combustion techniques for total carbon, total nitrogen and total sulfur in soils. In *Instrumental Methods for Analysis of Soils and Plant Tissue*, Walsh L.M. ed., SSSA, 1–15
- Buurman P, Van Lagen B and Velthorst EJ (1996) *Manual for Soil and Water analysis.*, Backhuys, Leiden, The Netherlands, 314 p
- Chamayou H and Legros JP (1989) *Les bases physiques et minéralogiques de la Science du Sol.*, Presses Universitaires de France, 485–486
- Charlot G and Bezier D (1955) *Analyse quantitative minérale*, Masson, Paris.
- Colovos G, Panesar MR and Parry EP (1976) Lime arizing the calibration curve in determination of sulfate by the methylthymol blue method. *Anal. Chem.*, 48, 1693–1696
- Commission de pédologie et de cartographie des sols (CPCS), (1967) *Classification des sols.*, Lab. Geol. Pedol., Ecole Nat. Sup. Agron., Grignon, France, 87 p
- David MB, Mitchell MJ, Aldcorn D and Harrison RB (1989) Analysis of sulfur in soil, plant and sediment materials. Sample handling and use of an automated analyser. *Soil Biol. Biochem.*, 21, 119–123
- FAO, (1968) *Definition of Soil Units for the Soil Map or the World*, no. 33
- Freny JR, Melville GE and Williams CH (1970) The determination of carbon bounded sulphur in soils. *Soil Sci.*, 109, 310–318
- Génin JMR, Refait P, Bourrié G, Abdelmoula M and Trolard F (2001) Structure and stability of Fe (II) – Fe (III) green rust ‘‘fougerite’’ mineral and its potential for reducing pollutants in soil solutions. *Appl. Geochem.*, 16, 559–570
- Gerzabek MH and Schaffer K (1986) Determination of total sulphur in soil. A comparison of methods. *Bodenkultur*, 37, 1–6
- Gony J and Parent Ch (1966) Etude géochimique d’une tranche de sédiments fins actuels. *Bull. BRGM*, 5, 28–31
- Johnson CM and Nishita H (1952) Microestimation of sulfur in plant materials, soils and irrigation waters. *Anal. Chem.*, 24, 736–742
- Karmarkar SV and Tabatabai MA (1992) Eluent composition effect on ion chromatographic determination of oxyanions in solution equilibrated with soils. *Chromatographia*, 34, 643–648

- Kowalenko CG and Lowe LE (1972) Observations on the bismuth sulphide colorimetric procedure for sulphate analysis in soil. *Commun. Soil Plant Anal.*, 3, 79–86
- Kowalenko CG (1985) A modified apparatus for quick and versatile sulphate sulphur analysis using hydroiodic acid reduction. *Commun. Soil Sci. Plant Anal.*, 16, 289–300
- Le Brusq JY, Loyer JY, Mouguenot B and Carn M (1987) Nouvelles paragenèses à sulfates d'aluminium, de fer et de magnésium, et leur distribution dans les sols sulfatés acides du Sénégal. *Sc. du Sol.*, 25, 173–184
- Loeppert RH and Suarez DL (1996) Carbonate and Gypsum. In *Methods of Soils Analysis. Part 3, Chemical Methods*, Sparks DL et al. ed., SSSA book series no. 5, 437–474
- Marius C (1980) *Les mangroves du Sénégal. Ecologie, pédologie et utilisation.*, IRD (ex. Orstom) éd., Paris
- Marius C, Paycheng C and Lopez J (1976) *La détermination du soufre et de ses composés au laboratoire Orstom de Dakar*, Sénégal. Documentation IRD, Dakar, Paris, 16 p
- McSwain MR, Watrous RJ and Douglas, JE (1974) Improved methyl thymol blue procedure for automated sulfate determinations. *Anal. Chem.*, 46, 1329–1331
- Montoroi JP (1994) *Dynamique de l'eau et géochimie des sels d'un bassin versant aménagé de Basse-Casamance*, Sénégal. Th. Univ. Nancy I, 349 p
- Montoroi JP, Grunberger O and Nasri S (2002) Groundwater geochemistry of a small reservoir catchment in central Tunisia. *Appl. Geochem.*, 17, 1047–1060
- Pansu M, Gautheyrou J and Loyer JY (2001) *Soil Analysis – Sampling, Instrumentation and Quality control.*, Balkema, Lisse, Abington, Exton, Tokyo, 489 p
- Perrott KW, Kerr BE, Kear MJ and Sutton MM (1991) Determination of total sulphur in soil using inductively coupled plasma atomic emission spectrometry. *Commun. Soil Sci. Plant Anal.*, 22, 1477–1487
- Pouget M (1995) Gypsoles. In *Référentiel Pédologique*, INRA, France, 161–165
- Richards LA (1954) *Diagnosis and Improvement of Saline and Alkali Soils.*, USDA Handbooks, 60, US Gov. Print Office, 160 p
- Rivera ED, Hallmark CT, West LT and Drees LR (1982) A technique for rapid removal of gypsum from soil samples. *Soil Sci. Soc. Am. J.*, 46, 1338–1340
- Sonne K and Dasgupta PK (1991) Simultaneous photometric flow injection determination of sulfide, polysulfide, sulfite, thiosulfate and sulfate. *Anal. Chem.*, 63, 427–432
- Tabatabai MA and Basta NT (1991) Ion chromatography. In *Soil Analysis*, Smith KA ed., Dekker, New York, 229–259
- Tabatabai MA and Bremner JM (1970a) An alkaline oxidation method for determination of total sulfur in soils. *Soil Sci. Soc. Am. Proc.*, 34, 62–65

- Tabatabai MA and Bremner JM (1970b) Comparison of some methods for determination of total sulfur in soils. *Soil Sci. Soc. Am. Proc.*, 34, 417–420
- Tabatabai MA and Dick WA (1979) Ion chromatographic analysis of sulfate and nitrate in soils. In *Ion Chromatographic Analysis of Environmental Pollutants*, Mulik JD and Sawickie ed., Ann. Arbor Sci. Publ., 2, 361–370
- Tabatabai MA and Frankenberger WT Jr (1996) Liquid chromatography. In *Methods of Soil Analysis, Part III Chemical Methods*, Sparks DL et al., SSSA Book, 5, 225–245
- Tabatabai MA (1996) Sulfur. In *Methods of Soil Analysis, Part 3, Chemical Methods*, Bigham JM and Bartels JM ed., ASA-SSSA Book, Serie no. 5, Madison, WI Etats-Unis, 921–960
- Tabatabai MA, Basta NT and Pirela HJ (1988) Determination of total sulphur in soils and plant materials by ion chromatography. *Commun. Soil Sci. Plant Anal.*, 19, 1701–1714
- USDA, (1975) *Soil Taxonomy. A Basic System of Soil Classification for Making and Interpreting Soil Surveys.*, USDA, Agriculture Handbook no. 436, 754
- van Breemen N and Harmsen K (1975) Translocation of iron in acid sulfate soils. I – Soil morphology and the chemistry and microbiology of iron in a chronosequence of acid sulfate soils. *Soil Sci. Soc. Am. Proc.*, 39, 1140–1148
- Vieillefon J (1974) *Les sols de mangroves et de tannes de Basse Casamance, Sénégal.*, IRD (ex. Orstom) ed. Paris

## Chronobibliography

- Johnson CM and Ulrich A (1959) *Analytical Methods for Use in Plant Analysis.*, California Agric. Exp. Str. Bull., 766
- Gustafsson L (1960) Determination of ultra micro amounts of sulphate as methylene blue. 1<sup>ère</sup> partie : Réaction. *Talanta*, 4, 222–235
- Gustafsson L (1960) Determination of ultra micro amounts of sulphate as methylene blue. 2<sup>ème</sup> partie : Réduction. *Talanta*, 4, 236–243
- Kilmer VJ and Neapass DC (1960) The determination of available sulfur in soils. *Soil Sci. Soc. Proc.*, 337–339
- Sherman GD, Schultz F and Alway FJ (1962) Dolomite in soils of the red river valley, Minnesota. *Soil Sci.*, 94, 304–313
- Steinbergs A, Iismaa O, Freney JR and Barrow NJ (1962) Determination of total sulphur in soil and plant material. *Anal. Chim. Acta.*, 27, 158–164
- Bardsley CE and Lancaster JO (1965) Sulfur. In *Methods of Soil Analysis.*, American Society of Agronomy, 1102–1116

- Dean GA (1966) A simple colorimetric finish for the Johnson–Nishita micro-distillation of sulphur. *Analyst*, 91, 530–532
- Beaton JD, Burns GR and Platou J (1968) *Determination of Sulphur in Soils and Plant Material.*, Sulphur Institute (Washington), Technical Bulletin no. 14
- Khan SU and Webster GR (1968) Determination of gypsum in solonetz soils by an XR technique. *Analyst*, 93, 400–402
- Lowe LE (1969) Sulfur fraction of selected alberta profiles of the gleysolic order. *Can. J. Soil Sci.*, 49, 375–381
- Tabatabai M and Bremner JM (1970) An alkaline oxydation method for determination of total sulphur in soils. *Soil Sci. Soc. Am. Proc.*, 34, 62–65
- Wakayama FJ (1971) Calcium complexing and the enhanced solubility of gypsum in concentrated sodium-salt solutions. *Soil Sci. Am. Proc.*, 35, 881–883
- Hesse PR (1972) *A Textbook of Soil Chemical Analysis.*, Chemical Publishing Co., 520 p
- Darmody RG, Fanning DJ, Drummond WJ Jr and Foss J. (1977) Determination of total sulfur in tidal marsh soils by X-Ray spectroscopy. *Soil Sci. Soc. Am. J.*, 41, 761–765
- Nor YM and Tabatabai MA (1977) Oxidation of elemental sulfur in soils. *Soil Sci. Soc. Am. J.*, 41, 736–741
- Begheijn LTh, Van Breemen N and Velthorst EJ (1978) Analysis of sulphur compounds in acid sulphate soils and other recent marine soil. *Commun. Soil Sci. Plant Anal.*, 9, 873–882
- Nelson RE, Klameth LC and Nettleton WD (1978) Determining soil gypsum content and expressing properties of gypsiferous soils. *Soil Sci. Soc. Am. J.*, 42, 659–661
- Cronan CS (1979) Determination of sulfate in organically colored water samples. *Anal. Chem.*, 51, 1333–1335
- Siemer DD (1980) Reduction-distillation method for sulfate determination. *Anal. Chem.*, 52, 1271–1274
- Rivera ED, Hallmark CT, West LT, Drees LR (1982) A technique for rapide removal of gypsum from soil samples. *Soil Sci. Soc. Am. J.*, 46, 1338–1340
- Freney JR, Jacq VA and Baldensberger JF (1982) The significance of the biological sulfur cycle in rice production. In *Microbiology of Tropical Soils and Plant Productivity*, Dommergues YR and Diem AG ed. Martinus Wijnhoff, 10, 271–317
- Adams TMC and Lane PW (1984) A comparison of four methods of analysing aqueous soil extracts for sulphate. *J. Sci. Food Agric.*, 35, 740–744
- Lebel A and Teh Fu Yen, (1984) Ion chromatography for determination of metabolic pattern of sulfate-reducing bacteria. *Anal. Chem.*, 56, 807–808
- Wainwright M (1984) Sulfur oxidation in soils. In *Advances in Agronomy*, Academic, New York, 37, 350–396
- Lee R, Blakemore LC, Daly BK, Gibson EJ, Speirt W and Orchard VA (1985) Sulphur supply to ryegrass during a pot trial and correlations with

- soil biological activity: The influence of two different methods of determining the adsorbed sulphate status of soils. *Commun. Soil Sci. Plant Anal.*, 16, 97–117
- Kowalenko CG (1985) A modified apparatus for quick and versatile sulphate sulphur analysis hydroiodic acid reduction. *Commun. Soil Sci. Plant Anal.*, 16, 284–300
- Scott NM (1985) Sulphur in soils and plants. In *Soil Organic Matter and Biological Activity*, Vaughan D and Malcolm RE ed., Martinus Nijhoff/Junk, 379–401
- Gimeno Adelantado JV and Bosch Reig F (1986) Mineralization of some organic sulphur compounds by fusion with molten alkali. *Talanta*, 33, 757–759
- Keller LP, Mc Carthy GF and Richardson JL (1986) Mineralogy and stability of soil evaporites in North-Dakota. *Soil Sci. Soc. Am. J.*, 50, 1069–1071
- Krupa SV and Tabatabai MA (1986) Measurement of sulfur in the atmosphere and in natural waters. In *Sulfur in Agriculture*, Tabatabai MA ed. ASA, CSSA, Agron. Monogr. 27, 491–548
- Bansal KN and Npal AR (1987) Evaluation of a soil test method and plant analysis for determining the sulphur status of alluvial soil. *Plant and Soil*, 98, 331–336
- Vaugh CE, Junes MB and Center DM (1987) Sulfur tests on Northern California sub-clones annual grass pasture surface soils. *Soil Sci.*, 143, 184–191
- Bolan NS, Syers JK, Tillman RW and Scotter DR (1988) Effect of liming and phosphate additions on sulphate leaching in soils. *J. Soils Sci.*, 39, 493–504
- David MB, Mitchell MJ, Aldcorn D and Harrison RB (1989) Analysis of sulfur in soil, plant and sediment materials: sample handling and use of an automated analyser. *Biol. Biochem.*, 21, 119–123
- Sharp GS, Hoque S, Killham K, Sinclair AH and Chapman ST (1989) Comparison of methods to evaluate the sulphur status of soils. *Commun. Soil Sci. Plant Anal.*, 20, 1821–1832
- Hue NV, Fox RL and Wolt JD (1990) Sulfur status of volcanic ash-derived soils in Hawai. *Commun. Soil Sci. Plant Anal.*, 21, 299–310
- Hauge S and Maroy K (1991) Detection of sulphate by flame emission spectrometry. *Anal. Chim. Acta.*, 243, 227–237
- Morante C (1991) Determination of plant sulphur and sulphate-sulphur by flow-injection analysis using a two-live manifold. *Anal. Chim. Acta.*, 249, 479–488
- Singh RP, Pambid ER and Abbas NM (1991) Determination of sulfate in deep sub surface waters by suppressed ion chromatography. *Anal. Chem.*, 63, 1897–1901
- Tabatabai MA and Bremner JM (1991) Automated instruments for determination of total carbon nitrogen and sulfur in soils by combustion technique. In *Soil Analysis*, Smith K.A. ed., Dekker, New York, 261–285
- Michel JP and Fairbridge RW (1992) *Dictionnary of Earth-Sciences.*, Wiley, New York, 300 p
- Blanc GJ, Lefroy RDB, Chinoim N, Anderson GC and Barrow NJ (1993) Sulfur soil testing. *Plant Soil*, 383–386
- Boruah RK and Ghosh P (1993) Quantitative estimation of available sulphur in tea soils *Two and a Bud*, 40, 26–30



- Jansson H (1994) Sulphur status of soils – a global study *Norwegian J. Agric. Sci.*, SN 15, 27–30
- Tan Z, McLaren RG and Cameron KC (1994) Forms of sulfur extracted from soils after different methods of sample preparation. *Aust. J. Soil Res.*, 32, 823–834
- Trivedi BS, Gami RC and Patel KG (1994) Standardization of method for determining available sulphur and its critical limit for lowland paddy. *Gujarat Agric. Univ. Res. J.*, 20, 35–41.
- Zhao F and McGrath SP (1994) Extractable sulphate and organic sulphur in soils and their availability to plants. *Plant Soil*, 164, 243–250
- Santoso D, Lefroy RDB and Blair GJ (1995) A comparison of sulfur extractants of wealthered acid soils. *Aust. J. Soil Res.*, 33, 125–133
- Shaw Xiao-Quan and Chen Bin (1995) Determination of carbon-bonded sulfur in soils by hydroiodic acid reduction and hydrogen penoxide oxidation. *Fresenius J. Anal. Chem.*, 351, 762–767
- Simo R and Grimalt JO (1996) Determination of volatile sulphur species in soil samples of interest for prospecting for metal sulphide deposits. *J. Chromatog., A*, 726, 161–166
- Zhao FJ, Loke SY, Crosland AR and McGrath SP (1996) Method to determine elemental sulphur in soils applied to measure sulphur oxidation. *Soil Biol. Biochem.*, 28, 1083–1087
- Prochnow LI, Boaretto AE and Vitti GC (1997) Ion-exchange resin to evaluate sulphur availability in soils. Utilizacao da resina trocadora de ions para avaliacao do enxofre disponivel do solo. *Revista Brasileira de Ciencia do Solo*, 21, 335–339
- Gowrisankar D and Shukla LM (1999) Evaluation of extractants for predicting availability of sulphur to mustard in Inceptisols. *Communi. Soil Sci. Plant Anal.*, 30, 19–20, 2643–2654; 33 ref
- Matula J (1999) Use of multinutrient soil tests for sulphur determination. *Commun. Soil Sci. and Plant Anal.*, 30, 1733–1746
- Zbiral J (1999) Comparison of some extraction methods for determination of sulphur in soils of the Czech Republic. Porovnaní vybraných extrakčních postupů pro stanovení síry v půdách ČR. *Rostlinná Výroba*, 45, 439–444
- Prietzl J and Hirsch C (2000) Ammonium fluoride extraction for determining inorganic sulphur in acid forest soils. *Eur. J. Soil Sci.*, 51, 323–333
- Crosland AR, Zhao FJ and McGrath SP (2001) Inter-laboratory comparison of sulphur and nitrogen analysis in plants and soils. *Commun. Soil Sci. Plant Anal.*, 32, 685–695

## **Analysis of Extractable and Total Elements**

### **31.1 Elements of Soils**

#### **31.1.1 Major Elements**

Soils contain the chemical elements of the lithosphere, i.e. stable elements of the periodic table, with respect to geochemical distribution and soil genesis processes. This chapter deals with the analysis of solid phases only. Oxygen is the most abundant element in soils and rocks, but it is generally not titrated; instead its approximate content is deduced from the rates of other major elements during conversions of elements to oxide concentrations (Table 31.1). The analysis of carbon, which is the main chemical element in organic matters and carbonate minerals is dealt with in Part 2 and in Chap. 17, respectively. Hydrogen, another important element in rocks, water and organic matter is usually analysed in its organic form (plus constitutive water) when an automated CHN analyser is available (cf. Chap. 10), during thermal analysis (cf. Chap. 7), or in proton exchange studies (cf. Chaps. 15 and 23). Nitrogen is another important element in the biosphere and in the atmosphere; nitrogen analysis is discussed in Chaps. 10 (total N), 14 (organic N) and 28 (inorganic N).

Silicated minerals originating from igneous rocks contain mostly oxygen and major elements of the third and fourth period of the periodic table. These metals can produce basic oxides, the most basic of which originate from alkaline metals, sodium and potassium, then from alkaline earth metals: calcium and potassium, and finally from transition metals (iron, titanium and manganese) and aluminium. Silicated minerals also include non-metals (especially silicon and phosphorus) that produce acid oxides. Two types of magmas are classified on the basis of their silica content. One is described as acid and granitic with a high silica content (>60%) and relatively high sodium and potassium contents. The other is

basic and basaltic with a silica content lower than 50% and relatively high iron, magnesium and calcium contents. For a more precise classification, see Table 31.1.

**Table 31.1.** Mean elemental composition of few igneous rocks (from Turekian and Wedepohl 1961)

El.	stable oxide	<i>k</i>	percentage concentration							
			Ultra-basic rocks		Basaltic rocks		Granitic rocks		Acid rocks	
			SiO <sub>2</sub> <45%		45 < SiO <sub>2</sub> <52%		52 < SiO <sub>2</sub> <68%		SiO <sub>2</sub> > 66%	
			El.	Ox.	El.	Ox.	El.	Ox.	El.	Ox.
Si	SiO <sub>2</sub>	2.139	20.5	43.9	23.0	49.2	31.4	67.2	34.7	74.3
Al	Al <sub>2</sub> O <sub>3</sub>	1.889	2.0	3.8	7.8	14.7	8.2	15.5	7.2	13.6
Fe	Fe <sub>2</sub> O <sub>3</sub> <sup>a</sup>	1.430	9.4	13.4	8.6	12.3	3.0	4.3	1.4	2.0
Ca	CaO	1.399	2.5	3.5	7.6	10.6	2.5	3.5	0.5	0.7
Mg	MgO	1.658	20.4	33.8	4.6	7.6	0.9	1.5	0.2	0.3
Na	Na <sub>2</sub> O	1.348	0.4	0.5	2.0	2.7	2.8	3.8	2.6	3.5
K	K <sub>2</sub> O	1.205	0.004	0.005	0.8	1.0	2.5	3.0	4.2	5.1
Ti	TiO <sub>2</sub>	1.668	0.030	0.050	1.4	2.3	0.34	0.6	0.12	0.2
Mn	MnO	1.291	0.160	0.207	0.15	0.2	0.054	0.1	0.04	0.1
P	P <sub>2</sub> O <sub>5</sub>	2.291	0.022	0.050	0.11	0.3	0.092	0.2	0.06	0.1
total%			99.2		101.0		99.6		99.9	
O	%		43.8		44.9		47.8		48.9	

El. element, Ox. stable oxide, *k*: multiplicative coefficient = oxide mw-to-element mw ratio

<sup>a</sup> In reducing medium, replace by FeO (*k* = 1.286)

The composition of the soil (Greenland and Hayes 1983) varies depending on its genesis under different weathering processes and also on human activities. But the major elements of igneous rocks are often found

in variable proportions in soils. As shown in Table 31.1, the first way to check the accuracy of the analysis consists in adding the calculated percent of the more stable oxides of the major elements. Taking moisture and organic matter into account, and in some cases other elements present in large quantities, the total should be near 100%.

### 31.1.2 Trace Elements and Pollutants

As is true for the major elements, the concentrations of trace elements in soils (Baize 1997) are often linked to the concentrations of the subjacent parent rock, though with marked irregularities. The subjacent rock does not always have the most influence, soil materials may also originate from allochthon heterogeneous parent rocks or pollution.

Table 31.2 summarizes the range of concentrations reported by Aubert and Pinta (1971) for a few trace elements in soils. The contents of some elements such as chromium, vanadium or zinc, are generally well correlated with parent rock content. Other elements like boron, cobalt or molybdenum depend on the soil type and genesis. Elements like iodine or lead are generally found in much higher concentrations in soils than in subjacent rocks (particularly in sedimentary contributions of marine origin as is the case for iodine). Organic soils can be very rich in certain elements like selenium.

In the case of organic pollution, the pollutant molecules were usually not originally present in the soil and can consequently be identified and titrated (cf. Chap. 13) perhaps with difficulty, but at least with no doubt about their origin. The same is not true for inorganic elements: it is not always easy to distinguish geochemical and anthropogenic origins (Bourrelie and Berthelin 1998).

Depending on his or her knowledge of the soil type and parent rock, the trained geochemist will note concentrations which appear to be too high. This is sometimes obvious for elements like copper whose contents are generally well correlated with soil type and parent rock, but which is found in excess in most vineyard soils.

However, in most cases identifying the origin is more difficult, and the content at the suspected source of pollution and the contents of neighbouring samples of the same type of soil and parent rock have to be statistically compared. The contents are also linked to exchange properties of elements with the soil exchange complex (cf. Chap. 19).

**Table 31.2.** Concentration of a few trace elements in soil (From Aubert and Pinta 1971), total elements ( $\text{mg kg}^{-1}$ ) and easily extractable elements (% of total elements)

element	minimal concentration ( $\text{mg kg}^{-1}$ )	maximal concentration ( $\text{mg kg}^{-1}$ )	mean concentration ( $\text{mg kg}^{-1}$ )	mean easily extractable fraction (% of total concentration)
B	1–2 (podzols Belarus)	250–270 (eutrophic peat, Israel)	20–50	0.1–10 (1) or more (sodic soils)
Cr	traces	3,000–4,000	100–300	0.01–0.4 (2) 0.1–1 (3)
Co	0.05 (podzols Russia)	300 (Vertisols Central Aafrica)	10–15	0.5–50 (2)
Cu	traces	200–250 (Vertisols India)	15–40	0.3–21 (3) 0.05–5 (2) 7–17 (4) 18–60 (5)
I	0.1 (hydromorphic, amour daria)	25 (humic gley – Latvia)	1–5	
Mo	traces	24 (forest brown soil, Russia)	1–2	2–20 (3, 2, 6)
Ni	traces	>5,000 (indurate horizons, New Caledonia)		2 (2) 7–20 (5)
Pb	traces	1,200 (podzols, Canada)	15–25	1–30 (2)
Se	0.1	1,000 (peat soil, Ireland)	1–7	
V	traces	400	100–200	0.4–0.6 (2)
Zn	traces	900	50–100	0.2–20 (3)
Li	5	200		
Rb	10	500		
Ba	100	3,000	500	
Sr	50	1,000	350	
Ga	2	100	30	

*Right column:* extracting reagent: (1) hot water, (2) 2.5%  $\text{CH}_3\text{COOH}$  pH 2.5, (3) 1 mol  $(\text{CH}_3\text{COONH}_4)$   $\text{L}^{-1}$  at pH 7, (4) EDTA, (5) 1 mol  $(\text{HCl})$   $\text{L}^{-1}$ , (6) buffered oxalic acid–ammonium oxalate solution at pH 3.3 (Grigg's reagent)

### 31.1.3 Biogenic and Toxic Elements

Some major elements (cf. Sect. 31.1.1) and trace elements (cf. Sect. 31.1.2) are particularly important for life on Earth; in these cases analysis is more often required and the behaviour of these elements in soils must be carefully analysed.

The major elements that make up plant tissues are carbon, oxygen, hydrogen, nitrogen, phosphorous, sulphur, potassium, calcium, magnesium and sometimes sodium in salt-resistant plants or silicon in graminaceae or exceptional accumulation of another element.

Other elements are necessary for plant physiology, mainly copper, iron, manganese, zinc, boron and molybdenum. Though present in cellular tissues at often very low rates (minor or trace elements) from a few  $\text{mg kg}^{-1}$  to few  $\text{g kg}^{-1}$ , a deficiency in these elements can inhibit plant growth. Inversely too high availability results in toxicity (Coppenet and Juste 1982, Abo 1984). A good knowledge of the concentration and availability of biogenic and toxic elements is thus required.

In soils, these elements are often found at a trace level (copper, zinc, boron and molybdenum) but they can also be major elements (iron or manganese). Their availability depends not only on their concentration, but also on the physico-chemical equilibrium with the molecular structures of the soil (cf. Mineralogy in Part 1. and Organic materials in Part 2) and is thus linked to soil pH (cf. Chap. 15), redox potential (cf. Chap. 16), the charges of the exchange complex (cf. Chaps. 20 and 21), cation exchange capacity (cf. Chap. 26), and anion exchange capacity (cf. Chap. 27). Other elements like aluminium, which can result in exchange acidity (cf. Chap. 23), may also be toxic for plants in certain environments.

Other elements are also important for living organisms even though they are present at lower trace levels (Aubert and Pinta 1971, Baize 1997). For example, animals need cobalt for the formation of haemoglobin. Bovines and ovines can suffer from anaemia as a result of cobalt deficiency in soils and consequently in forage plants. Iodine is an important element for humans, and plays a role in the composition of thyroid hormone. Its deficiency can cause goitre, which, in the past, was a common disease in regions with iodine deficiency. Molybdenum plays an important role in both plants and animals, for example in the nitrogen cycle, where it facilitates reduction of nitrogen dioxide to nitrogen. Vanadium has a similar function. Selenium can accumulate in plants and become toxic for livestock.

### 31.1.4 Analysis of Total Elements

Total analysis uses a whole range of chemical and physico-chemical methods (Smith 1991, Tan 1996, He et Xiang 1999, Pansu et al. 2001). These include (i) analyses which require the separation of the elements from the organic and mineral lattices by solubilization, (ii) analyses which can be performed directly on solid mediums.

#### *Analysis by Solubilization*

The first methods developed for analysis of natural silicate materials used solubilization. Indeed classical chemical methods of analysis are based on the properties of the elements in solution.

These methods were subsequently extended to atomic spectrographic measurements and are still widely used today because atomic absorption spectrometry (AAS), inductively coupled plasma (ICP) atomic emission spectrometry (ICP-AES) and ICP mass spectrometry (ICP-MS) are performed more easily on liquid mediums than on solid mediums.

#### *Analysis on Solid Medium*

For analysis on a solid medium the material is subjected to an appropriate flux of radiation. The aim is to induce transformations in atomic structures at the level of electronic layers or of the atomic nucleus. The measurement of radiation energies during the relaxation processes enables identification and quantification of the elements.

When the energies used are not too high, the corresponding methods are called non-destructive: atoms are brought back to their fundamental state, so the original state of the matter is considered to be unmodified. This is not always the case for transitions occurring at the level of the nucleus, such as neutron activation analysis, or when the matter is subjected to too high thermal energy, as in arc or spark spectrography or ICP emission in solid medium.

Depending on the excitation source and on the analysis of the radiation emitted, many techniques are available to analyse the solid medium.

The most common are X-ray fluorescence using excitation of deep electronic layers in a X-ray flux (cf. Sect. 31.3.2), electronic microprobes which use energy from an electron flux (cf. Chap. 8) and neutron activation analysis in which matter is subjected to a neutron flux (cf. Sect. 31.3.3).

### **31.1.5 Extractable Elements**

Assay of total elements does not always provide sufficient information about the availability for plants of nutritive elements in the soil. Moreover in small laboratories with limited equipment, total analysis of big analytical series can be cumbersome. Reagents are often very aggressive so safety requirements are strict and laboratory equipment is expensive. This is why for many years agronomists have been trying to replace total analysis with simple but sufficiently accurate chemical or biochemical tests to identify thresholds of deficiency and toxicity for plants (Peck and Soltanpour 1990). As the aim of these tests is often to identify fertilizer requirements, they are designed for specific environments and cannot be used in all cropping systems.

The efficiency of the extraction varies with the type of soil. The correlation between the extractability of a given element and the effect of this element on the plant concerned must be known, either in the field or in controlled conditions in the greenhouse. Different degrees of availability can be estimated depending on the extracting power of the reagent used. The elements most commonly studied with respect to their availability are major plant nutrients: inorganic nitrogen (cf. Chap. 28), potentially available nitrogen (cf. Chap. 14), forms of phosphorus (cf. Chap. 29), forms of sulphur (cf. Chap. 30), exchangeable cations (cf. Chap. 22). This chapter deals with complementary procedures for the study of other forms of elements in soils that are available or potentially available.

## **31.2. Methods Using Solubilization**

### **31.2.1 Total Solubilization Methods**

Solubilization methods for ultimate analysis of soils are similar to methods for more general geochemical analyses. Adjustments are sometimes necessary depending on the conditions found in certain soil mediums, for example high organic matter content.

Total analysis requires destruction of both the organic matter structures and of the mineralogical lattice of aluminosilicates. Attacks generally have to be strong, they take a rather long time, and can be dangerous. Thus, the methods to be used should be chosen with care (Kawasaki and Arai 1996). There are three main causes of error in total analysis using solubilization (i) contamination by the reagents and equipment, (ii)



incomplete attack of the soil matrix and (iii) interference caused by the attack reagents during measurements.

*Contamination* can affect the titration of trace elements. Blank assays (with all the reagents and the entire reaction process but no sample) are often needed to be able to subtract the concentration in the blank from the concentration in the sample. During these calculations, the variance of the blank and sample measurements is added. When the concentration in the sample approaches the concentration in the blank, measurement by solubilization becomes impossible, and instead reagents with a higher degree of purity must be used, or analysis must be carried out on directly the solid medium. Ongoing progress in instrumentation and new analytical needs for environmental studies and geosciences results in the identification of new requirements with respect to purity and choice of reagents.

*Incomplete attack* of the soil matrix is another possible source of error. Certain minerals can be extremely difficult to solubilize completely even if solid residues are no longer visible after the attack. Among the elements that are very difficult to solubilize are chromium, titanium and zirconium. To complete the dissolution of these elements, it is sometime necessary to change the type and proportion of reagents and the attack process (e.g. open or closed vessel, heating on hot plate, microwave heating, etc.).

Several types of *interference* can be caused by reagents depending on the analytical method used. A typical physical interference that can result in serious errors both in atomic absorption spectrometry (AAS) and in flame or plasma emission spectrometry originates from the dissolved solid material from the analytical matrix which can clog the sample input system. One of the main causes of error noted by Burman (1987) in ICP-AES was caused by deposit of solids in the nebulizer, which affected the input flow in the burner. In AAS, reagents can cause several different types of chemical interferences. However, the careful choice of attack reagents can avoid interferences (Jeanroy 1974). In emission spectrometry, possible spectral interference should be taken into account. In ICP-MS, the different polyatomic species that can form between plasma atoms and reagents and possible interference with the titrated element due to their mass should be taken into account.

Solubilization methods can be classified in three groups:

- acid digestion in an open vessel
- acid attack in a closed vessel
- alkaline fusion.

Different acids can be used for digestion of the sample depending on the type of material concerned. The choice of the attack reagent also depends on the technique to be used for subsequent analytical

measurements. It is important to examine the properties of the main analytical reagents with respect to their suitability for a given analytical method.

### 31.2.2 Main Reagents for Complete Dissolution

#### *Hydrochloric Acid*

At high temperatures, concentrated hydrochloric acid (36%, 12 mol (HCl) L<sup>-1</sup>, *d*: 1.18) can attack many silicates, oxides, sulphates and fluoride minerals. It has a weak reducing power and is generally not suitable for the digestion of organic materials, apart from specific uses like protein hydrolysis to separate amino acids (cf. Chap. 14). It has often been used as the final medium in the preparation of solutions for AAS titration because it reduces the impact of some interferences. But it is not suitable for ICP-MS analysis because some polyatomic species like ArCl<sup>+</sup>, ClO<sup>+</sup> or ClOH<sup>+</sup> can cause major interferences in the titration of As, V, Cr, Fe, Ga, Ge, Se, Ti, Zn (Jarvis 1994b). As the boiling point of HCl–H<sub>2</sub>O azeotrope is lower than that of azeotrope (HNO<sub>3</sub>–H<sub>2</sub>O), hydrochloric acid can be eliminated efficiently by successive evaporations with nitric acid.

#### *Nitric Acid*

Nitric acid is one of the most frequently used reagents for the preparation of samples. It can liberate trace elements in the nitrate state which are very soluble in a complex matrix. One volume of concentrated HNO<sub>3</sub> (16 mol L<sup>-1</sup>) mixed with three volumes of concentrated HCl (12 mol L<sup>-1</sup>) is called “aqua regia”, a strong reagent recommended for the solubilization of trace elements in soils (AFNOR standard NF ISO 11,466 1995). Concentrated nitric acid (68%, 16 mol (HNO<sub>3</sub>) L<sup>-1</sup>, *d*: 1.42) is a strong oxidizing reagent that can destroy organic matter in soils with low organic content. However, its oxidizing power is reduced because the boiling point of azeotrope (122°C) limits the temperature of the attack in an open vessel. The complete destruction of the organic matrix often requires reagents with higher oxidizing power like hydrogen peroxide or perchloric acid. To avoid the risk of explosion when dealing with very organic samples, a preliminary attack with nitric acid is recommended before stronger oxidizing reagents are used.

Like hydrochloric acid, nitric acid is a suitable medium for titration solutions for AAS and emission spectrometry despite its weaker corrective effect on some interferences. The nitric medium is especially useful for ICP-MS techniques, as the polyatomic species that can be produced by  $\text{HNO}_3$  in the argon plasma at high temperatures are no different from those resulting from the constant presence in plasma of H, N and O elements.

### **Hydrofluoric Acid**

This is the only acid able to dissolve silica-based materials by forming hexafluorosilicate ions which can be transformed into volatile silicon tetrafluoride according to global reactions of the following type:

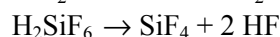
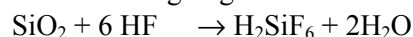

Because of the volatility of  $\text{SiF}_4$ , hydrofluoric acid cannot be used for attacks in open vessels for the quantification of silica. Furthermore, fluorides of other elements like boron, arsenic, antimony and germanium, may also be volatile depending on their degree of oxidation. Attacks are generally performed with mixtures of concentrated hydrofluoric acid (48%, 29 mol (HF)  $\text{L}^{-1}$ ,  $d$ : 1.16) and oxidizing acids (like nitric or perchloric acid) which complete dissolution and result in high oxidation states of the elements dissolved in the analytical medium.

If silica does not have to be quantified, eliminating this major element may be an advantage as it reduces the quantity of solids in the analytical solution thereby minimizing often serious error due to clogging of the nebulization systems in emission and absorption spectrometry (Burman 1987). Hydrofluoric acid has a rather high vapour pressure and results in an azeotrope with water with a relatively low boiling point: 112°C. This acid can thus be easily eliminated from the final medium by evaporation.

One disadvantage of hydrofluoric acid is its ability to attack glass and silica even at weak concentrations. This means only plastic containers should be used, preferably PTFE. Furthermore, in plasma emission spectrometry, this acid can attack certain nebulizers and silica ICP-torches and must consequently be completely eliminated from the final mediums. It can be sequestered by adding saturated boric acid, but this has the disadvantage of increasing of the quantity of solids. If titration of silica is not required, silicon and hydrofluoric acid should be eliminated by successive evaporations, though with a risk of losses of other elements.

### **Safety**

Hydrofluoric acid is a highly corrosive and toxic compound and it is extremely dangerous to handle. It can rapidly cause irreversible lesions of the skin and eyes. It is essential that the laboratory be equipped with a fume hood in good working order. Protective clothing is recommended. In the case of contact with the skin, rinse abundantly with water and, if possible, apply a calcium gluconate gel to the skin. In case of contact with the eyes, a doctor or the emergency service of the nearest hospital should be contacted without delay.

### **Perchloric Acid**

Perchloric acid is one of the strongest inorganic acids and is a very strong oxidative reagent. In the concentrated state (HClO<sub>4</sub> 72%,  $d = 1.67$ ) and when hot, it can explode in contact with organic material (particularly with fats), but this does not occur when it is used cold or is diluted. Perchloric acid should consequently only be used diluted at least four times in another acid, generally nitric acid. A preliminary attack with nitric acid is also used.

Perchloric acid gives an azeotropic mixture with water at 72% HClO<sub>4</sub> with a boiling point of 203°C. Used in combination with hydrofluoric acid, it facilitates the attack of refractory minerals by raising the boiling point. The mixture then has increased power to dissolve minerals and to simultaneously mineralize organic materials. Furthermore, the higher boiling point favours the elimination of HF and SiF<sub>4</sub> during the evaporation stage.

Another advantage of this acid is that it produces soluble salts with the majority of elements, which is not true of all acids, particularly sulphuric acid. One disadvantage of perchloric acid for analysis by ICP-MS is interference in the measurement of small quantities of arsenic and vanadium:  $^{40}\text{Ar}^{35}\text{Cl}^+$  on  $^{75}\text{As}$ ,  $^{35}\text{Cl}^{16}\text{O}^+$  on  $^{51}\text{V}$  (Jarvis 1994b).

### **Safety Precautions**

Perchloric acid is not recommended for the direct attack of very organic samples, particularly if they contain large quantities of fats (certain sewage sludges for example). In this case, a preliminary attack using another technique is required. Oils and greases will not be attacked by the perchloric acid-nitric acid mixture and will explode during evaporation with nitric acid. Many solid perchlorates are explosive.

Safety precautions must be strictly respected when perchloric acid is used. Fume hoods made of inert plastic equipped with a fume cleaning system must be used. The inside surfaces must be cleaned regularly to avoid accumulation of potentially explosive perchlorates. The fume hood

should only be used for acid attacks and should in no circumstances contain organic products.

### **Reagents for Alkaline Fusion**

These methods use alkaline reagents able to destroy the silicate lattices at high temperature and to form solid solutions (glasses) during cooling. Dissolution of these solid solutions in diluted acids is then easy. These methods are suitable for attack of geological materials but not of biological materials. Their advantage is that there is usually total dissolution without volatilization enabling quantification of silica, for example. Their main disadvantage is the introduction of a large quantity of dissolved solids in the analytical solutions which often requires high dilution and increases the detection threshold in the analysis of trace elements.

Different melting reagents have been recommended: strontium metaborate ( $\text{SrBO}_2$ ), lithium metaborate ( $\text{LiBO}_2$ ), lithium tetraborate ( $\text{Li}_2\text{B}_4\text{O}_7$ ), carbonates ( $\text{Na}_2\text{CO}_3$ ,  $\text{K}_2\text{CO}_3$ ), hydroxides (e.g.  $\text{NaOH}$ ,  $\text{KOH}$ ), peroxides (e.g.  $\text{Na}_2\text{O}_2$ ), fluorides ( $\text{KHF}_2$ ). Strontium metaborate was recommended for flame atomic absorption spectrometry (FAAS) (Jeanroy 1974) because strontium facilitates correction of interactions.

These methods are not well adapted to analysis by ICP-MS because of the large number of spectral interferences caused by the atoms of the melting reagent. Lithium metaborate is considered to be the best substrate for ICP-MS (Jarvis 1994a).

### **31.2.3 Acid Attack in an Open Vessel**

#### **Principle**

This technique is suitable for titration of many elements including Zn, Cu, Ni, Co, Ti, Mn, Mo, Sc, and rare earths. It cannot be used for titration of silica, or of volatile elements like Pb, Cd, As or Hg. It is suitable for spectrometric titration particularly of trace elements, because it results in reduced quantities of dissolved solids from reagents and lowers the total quantity of dissolved solids by volatilization of silica. Errors due to clogging of the input circuits of nebulizers of the spectrophotometers are then also avoided (cf. Sect. 31.2.1).

Different solutions have been proposed for acid attacks. The AFNOR standard NF X 31-151 (1993) recommends two types of attacks for soils, sediments and sewage sludge (i) a reflux attack with aqua regia, (ii) calcination at  $450^\circ\text{C}$  followed by digestion with a mixture of hydrofluoric

acid and perchloric acid on a hot plate. Hossner (1996) recommended digestion with a mixture of hydrofluoric, sulphuric and perchloric acid. The French AFNOR standard NF X 31-147 (1996) and the international standard Pr ISO CD 14869-part 1 (1998) suggest only digestion with the hydrofluoric and perchloric acid mixture, possibly with pretreatments in the case of very organic soils.

The technique described below is based on the international standard. Hydrofluoric acid (cf. "Perchloric Acid") enables destruction of silicate lattices in combination with perchloric acid (cf. "Reagents for Alkaline Fusion") which raises the boiling temperature. Perchloric acid is a very strong oxidizing reagent which enables total destruction of organic matter. However, with very organic soils, the reaction may result in some explosive stages and a more moderate attack is thus recommended. The French AFNOR standard NF X 31-147 (1996) recommends three alternative methods depending on the rate of organic carbon (C):

- $C < 20 \text{ g kg}^{-1}$ , no pre-treatment
- $20 < C < 40 \text{ g kg}^{-1}$ , preliminary nitric acid digestion
- $C > 40 \text{ g kg}^{-1}$ , no calcination before attack.

These ranges show that (i) a pretreatment with nitric acid is generally sufficient for most soils that developed under cold or moderate climates, (ii) attack without pre-treatment can be used with a lot of tropical soils. In all cases, it is better to avoid the use of sulphuric acid in the attack mixture as it results in insoluble salts, is viscous, difficult to eliminate by volatilization and not compatible with ICP-MS measurements (Jarvis 1994a).

### **Reagents**

- Ultra-pure deionized water with conductivity lower than  $0.5 \mu\text{S cm}^{-1}$
- hydrofluoric acid, HF,  $d$ : 1.16
- perchloric acid,  $\text{HClO}_4$ ,  $d$ : 1.67
- hydrochloric acid, HCl,  $d$ : 1.19
- nitric acid,  $\text{HNO}_3$ ,  $d$ : 1.41
- $\frac{1}{2}\text{HCl}$  solution: mix 500 mL of HCl ( $d$ : 1.19) with 450 mL of water, shake, let cool, complete the volume to 1 L while homogenizing
- $\frac{1}{2}\text{HNO}_3$  solution: as above but with 500 mL of  $\text{HNO}_3$  ( $d$ : 1.41).

All acids must be of high purity recommended for spectrographic analysis. Blank assays should be performed to check the purity of reagents.

### **Equipment**

- Polytetrafluorethylene (PTFE) crucibles,<sup>1</sup> interior diameter: 5 cm, height: 2 cm, approximate volume: 40 mL; the crucibles should be left filled with diluted nitric acid at least overnight and rinsed with deionized water. The treatment is more efficient if the crucibles are boiled for several hours with 8 mol (HNO<sub>3</sub>) L<sup>-1</sup>, followed by abundant rinsing with deionized water and then drying at 105°C to eliminate any absorbed acid (Jarvis 1994a). Worn crucibles should be replaced as they can more easily adsorb and desorb elements.
- Alternatively use platinum crucibles,<sup>2</sup> interior diameter: 4 cm, height: 2.5 cm, approximate volume: 30 mL.
- Acid-proof hot plate (but in any case, no equipment can survive contact with the mixtures used for very long).
- Efficient, easy to clean, plastic laboratory fume hood (cf. safety precautions in “Perchloric Acid”) equipped with a fume cleaning system for acids. For attacks required for the analysis of trace elements, the atmosphere should be dust free. One solution consists in using a laminar flow hood. The fume hood can be also installed in a clean room with an air filtration system. It is imperative to use protective clothing (nylon overalls, plastic goggles and gloves) and to respect safety precautions, particularly for handling hydrofluoric and perchloric acid (cf. “Hydrofluoric Acid” and “Perchloric Acid”).
- 50 mL volumetric flasks.
- Muffle furnace with temperature programming up to 500°C.

### **Procedure**

#### ***Not very Organic Soils***

Soil samples prepared in a standard way by crushing to 0.2 mm (Pansu et al. 2001) are generally used.

- (E1) accurately weigh approximately 0.5 g ( $\pm 0.1$  mg) of sample in a PTFE capsule or platinum crucible
- (E2) add few drops of deionized water to moisten the whole sample
- (E3) add in the following order: approximately 10 mL of concentrated HF and 5 mL of concentrated HClO<sub>4</sub>
- cover the samples with a PTFE plate (leaving a space between the sample and the lid to avoid condensation) and leave in contact overnight

<sup>1</sup> Techniverre, 93 380 Pierrefitte sur Seine, France.

<sup>2</sup> Lyon Alemand Louyot SA, 75 139 Paris Cedex 03, France.

- uncover, heat on a hot plate at 40–50°C until the appearance of white smoke indicating the beginning of evaporation of perchloric acid
- add 5 mL of concentrated hydrofluoric acid. Raise the heat to around 150°C
- dry until there is no more white smoke.
  
- (R1) Add 10 mL of ½HCl solution to the residue
- bring to dry slowly without additional calcination
- (R2) add 5 mL ½HCl solution
- add boiling deionized water, if necessary heat for a few minutes to facilitate dissolution
- let cool and transfer quantitatively in a 50 mL volumetric flask
- complete to 50 mL with deionized water.

**Remarks.** This medium (5% hydrochloric acid) is appropriate for molecular and atomic absorption spectrometry and also for flame- or ICP-AES.

Platinum capsules are very expensive but are easier to use than PTFE capsules. They allow the heating time to be reduced and better control of temperature.

#### *Alternative Method for ICP-MS*

The following precautions should be respected when using this highly sensitive technique: work in a clean dust-free room, protect your body, hair and shoes, use only ultra-pure reagents.

The final medium should be diluted with nitric acid instead of hydrochloric acid (cf. Sect. 31.2.2). Perchloric acid should be completely eliminated in the titration matrix.

Up to stage R1, the method is identical to that described in “Not Very Organic Soil”:

- (R1) Add 10 mL ½HNO<sub>3</sub> to the residue
- bring to dry slowly without additional calcination
- add 10 mL ½HNO<sub>3</sub> and repeat the previous stage
- (R2) add 5 mL ½HNO<sub>3</sub> and continue as in “Not Very Organic Soil”.

Five percent nitric acid can also be used as a final medium for other spectrometric methods in spite of its reduced ability to correct certain interferences.

#### *Alternative for Soils with Medium Organic Content*

For soils containing less than 40 g (C) kg<sup>-1</sup>:

- proceed as in “Not Very Organic Soil” for stages E1 and E2, then
- add 10 mL of concentrated nitric acid
- heat on hot plate for about 30 min.



Let cool, add a few drops of deionized water and continue as in “Not Very Organic Soils” starting from stage E3.

#### *Alternative for Very Organic Soils*

- (E1) Weigh approximately 0.5 g ( $\pm 0.1$  mg) of sample in a platinum capsule (or failing this a porcelain crucible).
- Place in a muffle furnace and programme a slow increase in temperature up to 450°C in about 1 h (slow increase avoids losses by projection). Maintain the same temperature for 3 h.

Let cool. If you are using a platinum capsule, proceed as in “Not Very Organic Soils” starting from stage E2, possibly dividing the volumes of acids in half (if the capsules are too small). If a platinum capsule is not available, quantitatively transfer the content of the porcelain crucible in a PTFE capsule and then proceed as in “Not Very Organic Soils” starting from stage E2.

#### *Alternative for Refractory Minerals*

Refractory minerals like chromite, garnet, magnetite or zirconia are only partially attacked using the procedure described above. During the first recovery of stage R1 described in “Not Very Organic Soils”, the possible presence of not attacked solid fragments should be checked. Attack can be completed by bringing to dry again and repeating stage E3. But an incomplete attack does not inevitably result in problems in titration, particularly if elements like Cr, Hf, Mo, Sc, Zr or heavy rare earth Gd to Lu do not have to be analysed (Totland et al. 1992). In this case, the final mediums should be decanted or preferably centrifuged before spectrometric measurements are made to avoid interference by solid residues. The presence of solid residues should also be mentioned in the final analytical report.

Sulphur minerals may not be completely decomposed by the HF–HClO<sub>4</sub> mixture. Jarvis (1994a) recommended their elimination with a preliminary attack of 10 mL of aqua regia (1 volume HNO<sub>3</sub> + 3 volumes HCl). Let the sample react at room temperature until the end of effervescence, bring to 60°C and let stand for one hour before dry evaporation at 150°C. Finally complete digestion with the HF–HClO<sub>4</sub> mixture as described in “Not Very Organic Soils”.

Vernet and Govindaraju (1992) suggested other modifications of the analytical procedure: adding nitric acid to the HF–HClO<sub>4</sub> mixture to dissolve certain sulphurized minerals like galena or pyrite, limiting the temperature to 100°C to avoid transformation of phosphorus into phosphates, and using aqua regia for mercury analysis.

### 31.2.4 Acid Attack in a Closed Vessel

#### *Principle*

Attacks in closed vessels are mainly used for quantification at the trace and ultra-trace level of volatile elements like Pb, Cd, As, Sc, B, Hg, Sb, Se or Sn. This type of attack also facilitates the dissolution of refractory phases and shortens the attack time. It allows temperatures to be increased due to the increase in the boiling point of acids and in pressure. Smaller volumes of reagents should be used since they will not evaporate. The smaller quantities of reagents means less contamination and increased protection against dust particles. In addition, the quantity of acid, corrosive and toxic fumes is reduced.

Depending on the temperature to be reached, different types of attack containers or “bombs” are available. The high pressure Parr acid digestion bomb enables temperatures of over 250°C and internal pressures of 12.4 MPa (safety valve at 24 MPa) to be used. The pack includes a 23 mL PTFE beaker with a PTFE cover, and the whole device comes in a steel container with a screw cap ensuring a satisfactory seal between the beaker and cap. These bombs are expensive and not easy to use. If the attacks are to be performed at a lower temperature and pressure, simpler forms of attack containers can be used. In the method described here, the attack containers are entirely made of Teflon, and have a PTFE screw cap.

Different authors have described attacks using different mixtures, for example: HNO<sub>3</sub>–HClO<sub>4</sub>–HF (Totland et al. 1992), HNO<sub>3</sub>–HF (Jarvis 1994a), aqua regia–HF (Hossner 1996), HNO<sub>3</sub>–HCl–HF below. The attack can be followed by acid elimination (especially hydrofluoric acid), by successive dry evaporations with the addition of diluted nitric or hydrochloric acid. Like the technique described in Sect. 31.2.3, this technique enables the quantity of dissolved solids to be reduced and hydrofluoric acid to be eliminated as these can upset titration. However, it does not allow quantification of silica and includes the risk of loss of certain fluorides by volatilization or insolubilization.

The addition of an excess of boric acid after the attack is another way to avoid evaporation. Boric acid reacts with hydrofluoric acid resulting in fluoboric acid (HBF<sub>4</sub>) according to the two-stage exothermic reaction:

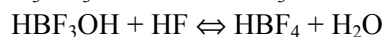
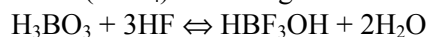

Reactions are strongly moved towards the right in the presence of an excess of boric acid. Hydrofluoric acid is sequestered and does not cause problems for at least two hours (Bernas 1968). According to Lim and

Jackson (1982), the addition of boric acid completes digestion by dissolving insoluble metallic hexafluorides, and the "HBF<sub>4</sub>-H<sub>3</sub>BO<sub>3</sub>-silicate ionic component" medium is suitable for titration using atomic absorption spectrometry.

According to Jarvis (1994a), this technique is less suitable for titration by plasma emission spectrometry. Even when neutralized, hydrofluoric acid can still attack glass, particularly in the fragile atomizers of the Meinhard type. Furthermore, the required quantity of boric acid results in a large quantity of solid residues, more than alkaline fusion techniques, and this can interfere with the detection of many trace elements.

### **Reagents**

All reagents must be of the degree of purity required for the type of spectrographic analysis used. Blank assays should be performed to check the purity of reagents:

- concentrated hydrofluoric acid
- concentrated nitric acid
- concentrated hydrochloric acid
- boric acid
- ultra-pure deionized water of conductivity less than 0.5  $\mu\text{S cm}^{-1}$ .

### **Equipment**

- Attack containers with PTFE screw caps, interior diameter: 45 mm, height: 60 mm (Techniverre, 93,380 Pierrefitte sur Seine, France)
- Thermostatically regulated water bath
- heating plate
- ultra-sonic tank
- 25 mL volumetric flasks
- plastic fume-hood with system for washing fumes.

### **Procedure**

#### *Usual Method*

- (A) Weigh about 250 mg ( $\pm 0.1$  mg) of sample (200  $\mu\text{m}$  particle size) and put in a PTFE reactor:
- add a few drops of deionized water to moisten the whole sample
  - add 1 mL of concentrated HF, 1 mL of concentrated HNO<sub>3</sub>, and 1 mL of concentrated HCl
  - close the reactor and leave in contact overnight
  - subject to ultra-sonic dispersion for 10 min

- leave in a water bath at 60°C for 24 h
  - let cool, open the reactor and check if the attack is complete or if solid residues are still present.
- (B) If the attack is complete, evaporate to dry on a hot plate at about 40°C protecting the sample against dust with a PTFE cover placed a few centimetres above the reactor:
- add 1 mL of concentrated nitric acid
  - evaporate to dry
  - add 1 mL of concentrated nitric acid and hot ultra-pure deionized water
  - transfer quantitatively in a 25 mL volumetric flask
  - let cool and bring to 25 mL with ultra-pure deionized water.

The final medium contains 4% nitric acid and is suitable for titration of trace elements by atomic absorption spectrometry using the hydride method or electrothermal atomization. It is also suitable for titration by ICP-AES.

#### *Alternative Method for Refractory Materials*

If the attack in “Usual Method” is not complete, at the end of stage A:

- add 1 mL of concentrated HF, and 1 mL of concentrated HNO<sub>3</sub>
- stop the PTFE reactor and leave in the water-bath at 60°C for 24 h
- continue as in “Usual Method”, stage B.

#### *Alternative Method to Prevent Fluoride Volatilization*

- After the attack described in “Usual Method” stage A, or “Alternative Method for Refractory Materials”, add boric acid to the reactor (2 g H<sub>3</sub>BO<sub>3</sub> dissolved in a small volume of water)
- stop, heat at 130°C for 15 min; let cool
- complete the volume to 200 mL with 1 mol (HNO<sub>3</sub>) L<sup>-1</sup> nitric acid and, if measurement is not carried out immediately, store in polypropylene bottles
- for ICP-MS analysis, the solutions must be diluted ten times before titration (Jarvis 1994a).

### **31.2.5 Microwave Mineralization**

Compared to the spectacular progress in analytical instrumentation, the preparation of the sample is still a limiting factor in the analytical

capacity of a laboratory. A modern spectrometer can provide the analytical results of several elements in only three to four minutes per sample. Acid solubilization of the same sample can require three to four days. Two ways were explored to improve the manual operations required before measurement, and were sometimes combined (1) automation and robotization, (2) improvement in the equipment used for preparation.

The first microwave apparatus for mineralization was produced in 1975 with the aim of reducing the time required for dissolution of the sample. These apparatus are often used with closed containers equipped with safety valves for the attack. The combined effect of the pressure and the energy of the microwave apparatus enables the time needed for solubilization to be reduced considerably. The organic materials are quickly broken up without the need for perchloric acid (Vernet and Govindaraju 1992), which also reduces the evaporation time after attack.

Microwave dissolution systems are also available for use with open vessels. They are more suitable when the procedure is completed automated starting from the input of the reagent up to final dissolution. It is possible to programme complex cycles including many attacks which can be performed without human intervention. In this way, the health hazards linked to the handling of dangerous acids (cf. Sect. 31.2.2) are minimized.

Historically, microwaves were first applied to biological samples. They were later used for geological materials, initially for mining (in 1970), and subsequently for other geochemical applications (Lamothe et al. 1986; Totland et al. 1992, Le Cornec et al. 1994). Comparative studies show that classical attacks in open vessels and microwave attacks give similar results for most of the elements of geological materials. Both techniques have problems of accuracy in the titration of Cr, Hf and Zr on certain samples. Consequently it is better to quantify these elements after alkaline attack by fusion with lithium metaborate (Totland et al. 1992).

According to Le Cornec et al. (1994), it is easier to control the different stages of acid digestion (cf. Sects. 31.2.3 and 31.2.4) in an open system. Moreover, the final evaporation is more difficult to control using microwave systems than the hot plate system. Zischa and Knapp (1997) believe that automated closed systems will be developed for microwave mineralization of solid materials, whereas systems for continuous flow mineralization will continue to be preferred for liquids and sludges.

Given the diversity of microwave systems, it is difficult to recommend a universal procedure for microwave acid digestions. We recommend adapting the classical systems described in Sects. 31.2.3 and 31.2.4 to suit your individual requirements.

### 31.2.6 Alkaline Fusion

#### *Principle*

This technique has three main advantages:

- it is suitable for titration of all major elements since it does not present the risk of elimination of silica;
- it is more rapid than classical acid attacks requiring heating on a hot plate or in a water bath in an open or closed vessel;
- it usually results in complete dissolution of the sample, and is thus the most efficient dissolution method for titration of refractory elements like V, Cr, Zr or Y.

The main disadvantage of the method is the quantity of solid residue that is generated. For spectrometry, greater dilution is needed to avoid clogging the nebulizers which can result in a decrease in sensitivity of titration of trace and ultra-trace elements.

In addition, the degree of heating required to perform the alkaline fusion can result in losses of certain volatile trace elements.

Even though many different reagents have been proposed for alkaline fusion (cf. “Reagents for Alkaline Fusion” in section 31.2.2), lithium metaborate is currently one of the most widely used. It is suitable for several different measurement techniques, especially ICP-MS (Jarvis 1994a). Another older fusion technique using strontium metaborate (Jeanroy 1974) was formerly used for atomic absorption spectrometry (Riandey et al. 1982), but today lithium metaborate is considered to be a better fusion reagent (Le Cornec, IRD Bondy, France, personal communication). The former procedure rules out lithium titration, and the second rules out strontium titration which is useful in soils. Furthermore, both procedures exclude the titration of boron, a trace element that can cause deficiency or toxicity during plant growth. Total boron can be determined by spectrophotometry or plasma emission spectrometry (ICP-AES) after solubilization using fusion with soda (Abo 1984).

#### *Reagents*

- Ultra-pure deionized water of conductivity lower than  $0.5 \mu\text{S cm}^{-1}$ .
- Fusion reagents and other reagents must be of high purity with certified concentrations with respect to the elements concerned.
- Lithium metaborate ( $\text{LiBO}_2$ ), or if not, an equimolar mixture of:
  - lithium oxide  $\text{Li}_2\text{O}$  or lithium carbonate  $\text{Li}_2\text{CO}_3$
  - boron oxide  $\text{B}_2\text{O}_3$ .

- Strontium metaborate  $\text{Sr}(\text{BO}_2)_2$ , or if not, an equimolar mixture of:
  - strontium carbonate  $\text{SrCO}_3$
  - boron oxide  $\text{B}_2\text{O}_3$ .
- Concentrated nitric or hydrochloric acid.
- 5% HCl or 5%  $\text{HNO}_3$ : in a 2 L volumetric flask, add 100 mL of concentrated HCl or  $\text{HNO}_3$  to approximately 1.8 L of ultra-pure water, shake, let cool and complete the volume to 2 L.
- 2% HCl or 2%  $\text{HNO}_3$ : in a 2 L volumetric flask, add 20 mL of concentrated HCl or  $\text{HNO}_3$  to approximately 1.8 L of water, shake, let cool and complete the volume to 2 L.

**Remarks.** If  $\text{Sr}(\text{BO}_2)_2$  is not available, the equivalent quantities of  $\text{SrCO}_3$  plus  $\text{B}_2\text{O}_3$  can be used (1 mol of each for 1 mol of  $\text{Sr}(\text{BO}_2)_2$ ). At the temperature of the crucible in the furnace, strontium metaborate is synthesized according to the reaction:

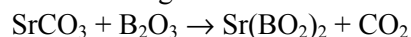

The same is true for  $\text{LiBO}_2$  which is equivalent to the equimolar mixture  $\text{Li}_2\text{O}-\text{B}_2\text{O}_3$  or  $\text{Li}_2\text{CO}_3-\text{B}_2\text{O}_3$ .

Lithium tetraborate ( $\text{Li}_2\text{B}_4\text{O}_7$  or a mixture of  $\text{Li}_2\text{O}-2\text{B}_2\text{O}_3$ , with a melting point of  $915^\circ\text{C}$ ), has been used as fusion reagent instead of metaborate (mp:  $845^\circ\text{C}$ ) which is more basic. Metaborate is better for attacking more acid siliceous materials, whereas tetraborate is better for more basic materials (aluminous, refractory, carbonaceous, etc.). A mixture of metaborate and tetraborate resulting in an eutectic point at  $832^\circ\text{C}$ , was recognized as an almost universal fusion reagent for geological materials (Vernet and Govindaraju 1992). It can be obtained by mixing 73%  $\text{B}_2\text{O}_3$  and 27%  $\text{Li}_2\text{O}$ .

### **Equipment**

- Round bottom cylindrical crucibles made of graphite<sup>3</sup> height = external diameter: 24 mm, depth and internal diameter: 18 mm
- muffle furnace set at  $1,100^\circ\text{C}$  or preferably an induction furnace under nitrogen atmosphere (Fig. 31.1)
- 200 mL beakers, with PTFE bar magnets for stirring
- 200 mL volumetric flasks
- 50 mL volumetric flasks.

<sup>3</sup> Sodemi, 95 370 St Ouen l'Aumone, France.

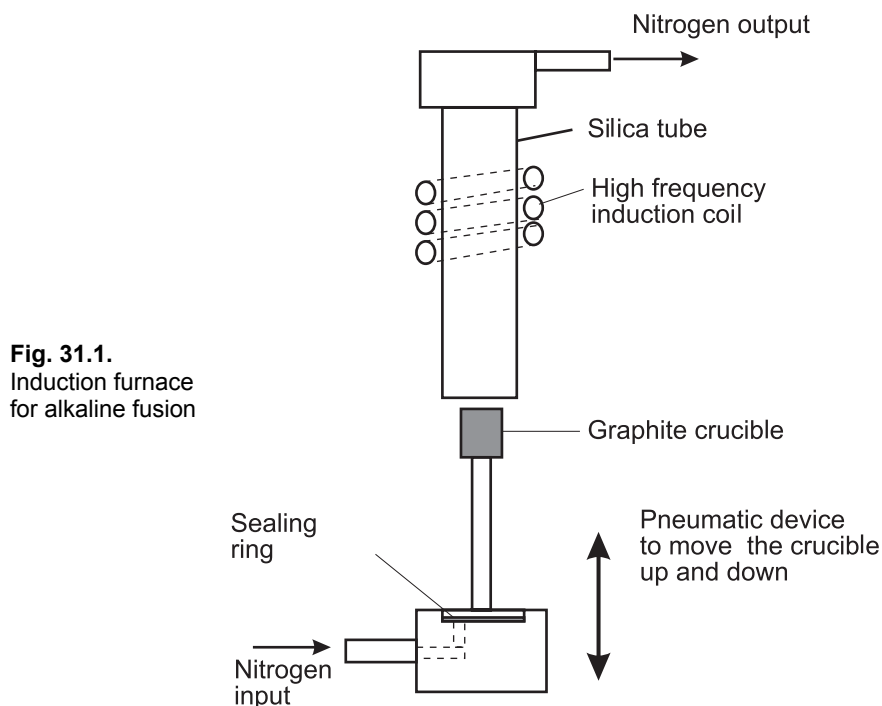

**Fig. 31.1.**  
Induction furnace  
for alkaline fusion

**Remarks.** An induction furnace is preferable to a muffle furnace for two reasons: first the heating mode increases the attack and dissolution (less than 5 min instead of 15–30 min), second its design facilitates work in a nitrogen atmosphere and greatly increases the shelf life of graphite crucibles. In a muffle furnace, the damage to crucibles by combustion can be reduced by placing them in graphite boxes.

Graphite crucibles are advantageous first because they are commercially available in very pure forms compatible with titration of trace elements, and second because the surface tension of the bead in fusion on graphite is weak which facilitates its quantitative transfer in the acid reagent for dissolution. Nevertheless, retention problems can occur with certain crucibles and worn crucibles should be replaced.

Some reduction phenomena can result in losses of elements like iron or cobalt during the fusion process. But these phenomena are not common during the fusion of silicate materials, especially when using an induction furnace which reduces the dissolution time.



Crucibles made of platinum–gold or gold–platinum–rhodium, non-dampening alloys, are interesting alternatives which are generally used for fusion with a muffle furnace or a Mecker gas burner. In this case, oxidizing conditions must be maintained, to avoid formation of alloys between the crucible and elements of the sample.

### **Procedure Using Strontium Metaborate**

- In a graphite crucible, accurately weigh approximately 100 mg ( $\pm 0.1$  mg) of soil sample (200  $\mu\text{m}$  particle size or less).
- Add 1 g of strontium metaborate (or equivalent  $\text{SrCO}_3 + \text{B}_2\text{O}_3$ ) and mix thoroughly.
- If the soil is organic ( $\text{C} > 40 \text{ g kg}^{-1}$ ), put it in a regulated furnace and increase the temperature slowly (over about 1 h) to  $450^\circ\text{C}$ . Maintain this temperature for 1 h.
- Bring to 1,100–1,200 $^\circ\text{C}$  for 5 min in an induction furnace, or for 15 min in a muffle furnace.
- Holding the crucible with a crucible tong, check the homogeneity of the melted bead and transfer it hot in a 200 mL beaker containing about 150 mL of 2% nitric acid.
- Let the crucible cool near the beaker. Then check for the presence of solid fragments and transfer them to the beaker if necessary.
- Put a PTFE bar magnet in the beaker and stir on a magnetic stirrer until total dissolution (about 30 min).
- Quantitatively transfer the content of the beaker to a volumetric flask and bring to 200 mL with the 2% nitric acid solution. The titration matrix is 0.5%  $\text{Sr}(\text{BO}_2)_2$ , 2%  $\text{HNO}_3$ .

**Remarks.** This solution is suitable for the titration of major elements and some trace elements by atomic absorption spectrometry, e.g.

- Fe, Mn, Mg, Na, K, Cu, Ni in air–acetylene flame;
- Si, Al, Ti, Ca in nitrous oxide–acetylene flame;
- and other trace elements by electrothermal atomization.

Si, Al, Ti and P can also be measured satisfactorily by spectrophotometry.

### **Procedure Using Lithium Metaborate**

#### **Major Elements**

- Weigh in a graphite crucible approximately 60 mg ( $\pm 0.1$  mg) of soil sample (200  $\mu\text{m}$  particle size or less).

- Add 0.5 g of  $\text{LiBO}_2$  and mix thoroughly with a spatula.
- If the soil is organic ( $\text{C} > 40 \text{ g kg}^{-1}$ ), place in a regulated furnace and slowly raise the heat (over about 1 h) to  $450^\circ\text{C}$ . Maintain this temperature for 1 h.
- Heat at  $1,100^\circ\text{C}$  in the high frequency induction furnace (or in a muffle furnace).
- Transfer the melted bead rapidly in a 250 mL beaker containing a PTFE bar magnet and 100 mL of 2% HCl solution. If necessary, transfer any solid fragments that remain after cooling.
- Stir until complete dissolution (15–20 min).
- Quantitatively transfer in a 200 mL volumetric flask and complete to volume with ultra-pure water. The final titration matrix is 1% HCl, 0.25%  $\text{LiBO}_2$ .

**Remarks.** This solution enables simultaneous quantification of the major elements: Ti, Fe, K, Na, Mg, Ca, Al, Si and possibly P in the case of high P content ( $\text{P}_2\text{O}_5 > 1\%$ ) by plasma emission (ICP-AES).

Alternatively, titration by flame emission or AAS can be used as described in “Procedure Using Strontium Metaborate”, with the addition of lanthanum to correct interference. Phosphorus and the Si, Al and Ti elements should also be sensitively quantified using spectrophotometry.

A 2% nitric acid solution can be used instead of 2% HCl in the final medium.

#### *Alternative Methods for Titration of Trace Elements (e.g. V, Cr, Zr, Y)*

Proceed as in “Major Elements”, but with a bigger sample specimen of 0.1 g or more. After alkaline fusion, dissolve the bead obtained in 5% HCl solution and bring to a final volume of 50 mL.

**Remarks.** This solution enables quantification of trace elements by ICP-AES and electrothermal AAS (EAAS). It is mostly useful for trace elements like V, Cr, Zr, Y which are refractory to acid attacks.

As the sample specimen is weaker than for acid attacks, the final medium more diluted, and the quantity of dissolved solids larger, this method is less convenient than acid attacks (cf. Sects. 31.2.3 and 31.2.4) for the other trace elements.

The technique is suitable for ICP-MS titration of ultra-trace elements but the 5% HCl final medium should be replaced by the 5%  $\text{HNO}_3$  medium.

### 31.2.7 Selective Extractions

#### *Extracting Reagents*

Many of the chemical extracting reagents used for agronomic tests only provide information on equilibrium values in the soil at a given date. Other methods (e.g. soil incubation) enable quantification of microbial action on the availability of a given element, for example nitrogen (cf. Chap. 14), phosphorus (cf. Chap. 29) or sulphur (cf. Chap. 30) studies. Plant roots have also complex effects on the extraction of nutrients (Callot et al. 1982) which are difficult to simulate accurately with simple tests.

*Extraction with water* (cf. Chap. 18) only provides information on the actual availability of elements from the soil solution. Boiling water is a more aggressive reagent which can be used to test boron availability for example (see S8 in “Extraction Solutions” or the AFNOR standard NF X 31-122, 1993).

Other reagents, used cold or hot, involve different mechanisms, hydrolysis, ion exchange, change in pH or redox potential, sequestering effect, etc.

Many different reagents are available for *extraction by ion exchange* in buffered or not buffered mediums. Potassium or calcium chloride, and sodium fluoride mediums enable titration of exchangeable protons or hydroxyls (cf. Chap. 15). Ammonium or sodium acetate, and barium chloride are typical reagents for exchangeable cations or analysing exchange capacities (cf. Chap. 22 and Chap. 26). Ammonium or sodium acetate buffered at pH 4.8 or 3 is used for studies of exchangeable iron linked to plant chlorosis, as is ammonium oxalate (standard FD X31-146, 1996). Potassium chloride and ammonium acetate enable quantification of exchangeable aluminium (cf. Chap. 23) and exchangeable manganese (Martens and Lindsay 1990). Reagents that work by ionic exchange are also used in studies of different forms of nitrogen (cf. Chap. 28), phosphorus (cf. Chap. 29) or sulphur (cf. Chap. 30). Ions can also act in solid form using ion exchange resins.

*Sequestering reagents* are also widely used for selective solubilization (which generally involves rather long equilibrium times) by chelate formation, often in combination with other reagents acting by ion exchange, redox or acid action. The most widely used sequestering reagents are ethylene diamine tetra-acetic acid (EDTA), diethylenetriamine

penta-acetic acid (DTPA), and triethanolamin (TEA). The standard NF X31-120 (1992) recommends extraction of copper, manganese (Gambrell and Patrick 1982) and zinc with a mixture of ammonium acetate and EDTA. The standard NF X31-121 (1993) is used for the estimation of the same elements plus iron including DTPA action. This standard uses the reagent DTPA–CaCl<sub>2</sub>–TEA, which is also recommended for extraction of toxic metals (Risser and Baker 1990).

*Reducing or oxidizing reagents* enable extraction of different forms of valence of certain elements. For example, specific forms of iron are extracted by 0.5% oxalic acid, 0.2% hydroquinone and ammonium acetate. One form of easily reducible manganese is extracted in the presence of sodium dithionite.

*Acid reagents* are often used to displace potentially available forms that are not easily extracted. Acetic acid at pH 2.5 enables the “total exchangeable cation” fraction to be solubilized. Boiling concentrated acetic acid solubilizes siderite. Hydrochloric acid is used at different dilutions (0.1, 0.5, 1 mol L<sup>-1</sup>) to extract some forms of Cu, Ni, Zn, Cd, Cr, Hg or Pb, and the same goes for phosphoric acid (e.g. forms of Mn). Attacking silicated lattices with hydrofluoric acid enables estimation of non-exchangeable ammonium (cf. Chap. 28).

An attack using three concentrated acids (1 vol. HNO<sub>3</sub>, 2 vol. HCl, 4 vol. H<sub>2</sub>SO<sub>4</sub>) has been recommended at various times for the differentiation of practically insoluble primary minerals from more recently formed minerals that are all soluble (Hardy and Follet-Smith 1931, Claisse 1968, Njopwouo and Orliac 1979).

### **Extraction Solutions**

Only standardized solutions and the most widely used extraction solutions are described here as too many possible alternatives exist to be able to describe them all.

– (S1) Standard NF X 31-120 (1992): solution of 1 mol L<sup>-1</sup> ammonium acetate and 0.01 mol L<sup>-1</sup> EDTA (extraction of Cu, Mn, Zn).

Dissolve 3.723 g of EDTA (C<sub>10</sub>H<sub>14</sub>Na<sub>2</sub>O<sub>8</sub>·2H<sub>2</sub>O) and 77 g of ammonium acetate (CH<sub>3</sub>COONH<sub>4</sub>) in a 1 L volumetric flask containing about 400 mL of deionized water. Bring to 800 mL. Measure the pH value and if necessary adjust to pH 7.0 with 1 mol L<sup>-1</sup> solution of ammonia or acetic acid. Complete to 1 L with deionized water while homogenizing.

- (S2) Lindsay and Norvell (1978), Risser and Baker (1990), standard NF X 31-121 (1993) and NF ISO 14870 (1998): mix 0.1 mol (TEA) L<sup>-1</sup>, 0.01 mol (CaCl<sub>2</sub>) L<sup>-1</sup>, 0.005 mol (DTPA) L<sup>-1</sup> (extraction of Cu, Mn, Zn, Fe, biogenic trace elements, toxic metals).  
In a 1 L volumetric flask dissolve in deionized water: 14.92 g of TEA, 1.967 g of DTPA and 1.47 g of calcium chloride di-hydrate. Bring to 800 mL with deionized water and adjust to pH 7.3 with ½HCl solution under agitation. Let cool and complete to 1 L with deionized water while homogenizing.
- (S3) Risser and Baker, 1990: diluted hydrochloric acid solution, 0.1 mol (HCl) L<sup>-1</sup> (Zn, alkalinity, toxic metals).  
Dilute 8.3 mL of concentrated hydrochloric acid in a 1 L volumetric flask containing 800 mL of deionized water. Complete to 1 L while homogenizing.
- (S4) Cox (1968), Risser and Baker (1990): double acid (toxic metals, soils with low pH, low CEC and low organic matter content).  
Dilute 8.3 mL of concentrated hydrochloric acid and 1.4 mL of concentrated sulphuric acid in 2 L of deionized water.
- (S5) Easily reducible manganese (Gambrell and Patrick 1982). Mixture of 1 mol (CH<sub>3</sub>COONH<sub>4</sub>) L<sup>-1</sup> ammonium acetate solution at pH 7, and 0.2% hydroquinone (or hydroxylamine).  
Dissolve 77.1 g of ammonium acetate in a 1 L beaker containing 750 mL of deionized water. Add 2 g of hydroxylamine chlorhydrate (NH<sub>2</sub>OH, HCl) or hydroquinone. Adjust the pH to 7 with a ½ammonia solution or a ½acetic acid solution. Complete the volume to 1 L.
- (S6) Total absorbed metals (US EPA,<sup>4</sup> 1986): concentrated nitric acid, concentrated hydrochloric acid, 30% hydrogen peroxide.
- (S7) “Free oxide” iron (Deb 1950, Pétard 1993). Sodium acetate and tartrate solution.  
In a 400 mL beaker dissolve 136 g of CH<sub>3</sub>COONa·3H<sub>2</sub>O in the minimum volume of deionized water necessary; in a 250 mL beaker dissolve 23 g of C<sub>4</sub>H<sub>4</sub>Na<sub>2</sub>O<sub>6</sub>·2H<sub>2</sub>O in the minimum volume of deionized water necessary; mix the two solutions and complete to 1 L.
- (S8) Boiling water boron (NF X 31-122, 1993), 0.01 mol (CaCl<sub>2</sub>) L<sup>-1</sup> solution.  
Use deionized boron-free water (check with a blank titration), dissolve 1.47 g of CaCl<sub>2</sub>·2H<sub>2</sub>O in a 1 L volumetric flask, complete to 1 L with boron-free water while homogenizing.

<sup>4</sup> US EPA = US Environment Protection Agency.

### **Equipment**

Only the most commonly used equipment is listed here:

- Top-loading balance ( $\pm 1$  cg) with suitable plastic scoop for powder
- 50, 100, and 200 mL plastic extraction flasks (tubes) with screw caps, if possible that can also be used for centrifugation
- flask for conservation of the extraction solution with suitable volume dispenser
- back and forth shaker or upside down rotation shaker able to load a sufficient number of 50, 100 or 200 mL extraction flasks. The agitation conditions should be regulated to insure they are reproducible at a speed enabling the entire mass of solid sample to be moved, without the speed of agitation being too high. The isothermal conditions of the shaker should be set at  $20^{\circ}\text{C}$  ( $\pm 1^{\circ}\text{C}$ )
- Centrifuge (at 5,000g) in tubes corresponding to extraction volumes.
- $\alpha$ -cellulose funnels and filters (Whatman No. 42 or similar) or a filtration device with a  $0.45\ \mu\text{m}$  filter membrane
- 250 mL round bottom boiling flasks with ground glass joint and suitable condenser for extraction of boron with boiling water
- 100 mL beakers with suitable beaker covers.

### **Procedure**

#### **General Procedure**

Use a soil sample prepared according to the procedure selected, (usually sieved to 2 mm and air dried)

- weigh the required mass (with respect to a specific standard, see below) of sample ( $\pm 0.01$  g) using a plastic powder scoop
- put the sample in an extraction flask of suitable volume (see later)
- add the required volume of extraction reagent
- stop the flask and shake on a preset shaker or shake manually in a thermostated room at a temperature of  $20^{\circ}\text{C}$  for the required time (see later).
- centrifuge or filter (or both) and store the extract until analysis.

**Remarks.** All operating conditions and particularly the extraction time should be standardized. Attack and equilibration phenomena need a rather long time, particularly sequestering reactions.

Always run a blank assay (reagent without sample using the same procedure).

Prepare the calibration ranges for spectrometric titration with the solution used for the extractions.

For extracts in neutral medium, limit storage of the extract to less than two days before analysis.

***Conditions for Extraction Reagent S1***

Flask: 100 mL, sample mass: 5 g, volume of extraction reagent: 50 mL, extraction time: 2 hours.

***Conditions for Extraction Reagent S2***

Flask: 100 mL, sample mass: 10 g, volume of extraction reagent: 20 mL, extraction time: 2 hours.

***Conditions for Extraction Reagent S3***

Flask (or stopped centrifugation tube): 50 mL, sample mass: 2 g, volume of extraction reagent: 20 mL, extraction time: 5 min, 3 successive extractions, bring the final volume to 100 mL.

***Conditions for Extraction Reagent S4***

Flask: 50 mL, sample mass: 5 g, volume of extraction reagent: 25 mL, extraction time: 15 min.

***Conditions for Extraction Reagent S5***

Flask: 200 mL, sample mass: 10 g, volume of extraction reagent: 100 mL, extraction time: 30 min (agitation), contact time: 6 h (intermittent agitation). Easily reducible manganese is obtained by subtracting the content found in this extract from the content of exchangeable manganese extracted with ammonium acetate 1 mol L<sup>-1</sup> at pH 7 (cf. Chap. 22).

***Alternative Method for Total Absorbed Metals S6 (US EPA 1986)***

Put 2 g of sample in a 100 mL Pyrex beaker, add 10 mL of concentrated nitric acid, cover with a beaker cover and heat for 25 min on a heating plate at 95°C without boiling. Let cool, add 5 mL of nitric acid and heat again for 30 min. Repeat this operation. Uncover  $\frac{1}{4}$  of the surface of the beaker and evaporate to a final volume of 5 mL without boiling. Cool, carefully add 2 mL of deionized water and 3 mL of 30% hydrogen peroxide. Heat carefully avoiding excess effervescence. Continue to add hydrogen peroxide in fractions of 1 mL until effervescence ends. Add 5 mL of concentrated hydrochloric acid and 10 mL of deionized water. Cover and heat again for 15 min without boiling. Filter on Whatman No. 41 filter paper (or similar) and complete to 50 mL with deionized water.

The final hydrochloric acid medium is not suitable for certain analytical techniques such as EAAS or ICP-MS. In these cases continue to heat the  $\text{HNO}_3\text{-H}_2\text{O}_2$  mixture until the volume is reduced to approximately 5 mL. Filter and complete the volume to 50 mL as previously. This method is not recommended for Hg analysis. It is designed to give concentrations of exchangeable trace elements or trace elements adsorbed by the soil components (e.g. Cd, Ni, Pb, Cr, As, Se), mostly to detect pollutants of industrial origin. It is not suitable for total elements associated with silicates nor is it recommended for total analysis.

#### *Alternative Method for Free Iron Oxide*

This is an alternative to the method proposed by Deb (1950) which is used by many laboratories (Pétard 1993).

Put 1 g of sample in a 100 mL centrifugation tube, add 50 mL of S7 acetate–tartrate solution, agitate vigorously with a glass rod, add 2g of sodium hydrosulphite and agitate well. Put in a water bath at 40°C for 40 min while stirring every 5 min. Centrifuge for 3 min at 3,000g and decant the supernatant in a 1 L volumetric flask. Add 50 mL of a 0.05 mol (HCl)  $\text{L}^{-1}$  solution to the centrifugation pellet, and again place in the water bath for 15 min while stirring at regular intervals. Centrifuge and decant the supernatant in the same volumetric flask. Repeat the extraction sequences (tartrate–acetate + hydrosulphite and washing with diluted hydrochloric acid) twice, adding each extract in the same 1 L volumetric flask. Add 10 mL of concentrated hydrochloric acid to the flask and complete to 1 L with deionized water while homogenizing. Let stand overnight and filter the solution before iron titration by atomic spectrometry or spectrophotometry.

#### *Alternative Method for Extractable Boron*

Weigh 25 g of sample and put it in a 250 mL boiling flask with a ground stopper. Add 50 mL of 0.01 mol ( $\text{CaCl}_2$ )  $\text{L}^{-1}$  solution (S8). Homogenize and boil for 5 min in a reflux condenser. Cool, filter at low filtration speed on ashless filter paper. Titrate boron by ICP-AES or by spectrophotometry using azomethine H.

### **31.2.8 Measurement Methods**

Before improvements in atomic spectrometry, analysing even major elements in soils or rocks was a long process. Analysis of only one particular element was often required rather than of all elements. In the same way, the methods of attack for multi-element analysis were not as standardized as the methods described in Sects. 31.2.3–31.2.6, but often



only suitable for one particular element. For example, concentrated nitric acid was the reagent used to attack total phosphorus (cf. Sect. 29.2.2 in Chap. 29), limestone was analysed by acid attack and volumetric measurement of carbon dioxide (cf. Chap. 17).

Total silica is often quantified after alkaline fusion (cf. Sect. 31.2.6) to avoid it being volatilized in the presence of hydrofluoric acid. Volatilization can be used for approximate gravimetric estimation of silica, but for more precise results, spectrophotometry is used. Silica reacts with ammonium molybdate at acid pH giving a yellow colour due to the production of silicomolybdic acid; oxalic acid is added to avoid interference with phosphorous and the colour can be measured at 420 nm. Silica can be also quantified by AAS using nitrous oxide–acetylene flame, but the detection limit is high. Analysis of silica by ICP-AES is more precise.

Phosphorous is almost unquantifiable by AAS and its analysis by ICP-AES is neither precise nor sensitive. The best method for analysis of phosphorous in solution is spectrophotometry: formation of a phosphomolybdic complex with ammonium molybdate in acid medium. The yellow complex can be either directly measured by spectrophotometry around 420 nm, or reduced resulting in a blue complex form measured at 830 nm (cf. Chap. 30).

Aluminium and titanium can be measured by AAS using nitrous oxide–acetylene flame but the method is not very sensitive as these two elements are refractory. Analysis using ICP-AES is better, but spectrophotometry is both a precise and inexpensive alternative for measurement of aluminium and titanium. Aluminium gives a red complex with eriochrome cyanine, titanium gives a yellow-orange complex with hydrogen peroxide in sulphuric acid medium.

Flame emission spectrometry is the recommended method for analysis of alkaline metals, particularly sodium and potassium, even using classical atomic absorption or emission spectrometers, and even using small cheap spectrometers, which, however, should be reserved for the titration of these elements (Pansu et al. 2001). The other major elements can be accurately measured by classical AAS using air–acetylene flame for Fe, Mn, Mg, Ni (or Na or K), and nitrous oxide–acetylene flame for Ca. In most soils, ICP-AES enables simultaneous quantification of all the major elements except phosphorous.

Analysis of trace elements is more problematic, but many methods have been explored over a period of many years (Pinta 1962). These methods were greatly improved by AAS techniques such as the hydride

method, the cold vapour method and especially electrothermal atomization. The ICP-AES technique also represented great analytical progress especially for multi-element analysis, but for many trace elements, ICP-AES is less sensitive than improved AAS techniques, for example electrothermal atomization.

A new era in the analysis of trace elements began with the introduction of ICP-MS. This technique enabled almost all elements of the periodic table to be studied, often with a better detection limit than with other techniques. In addition, it enabled access to certain isotopes of great interest for geochronological and ecological studies. But it is an expensive technique and is difficult to implement and is consequently usually reserved for certain specific research programmes.

The methods presented in this chapter concern the analysis:

- of P, Si, Al, Ti by spectrophotometry (cf. Sect. 31.2.9);
- of alkaline elements by flame emission spectrometry (cf. Sect. 31.2.10);
- by FAAS (cf. Sect. 31.2.11);
- by AAS, hydride and cold vapour methods (cf. Sect. 31.2.12);
- by EAAS (cf. Sect. 31.2.13);
- by ICP-AES (cf. Sect. 31.2.14);
- by ICP-MS (cf. Sect. 31.2.15).

### 31.2.9 Spectrophotometric Analysis

#### **Phosphorous**

When in *ortho*-phosphoric acid form, phosphorous reacts with molybdic acid giving a yellow phosphomolybdic complex. Absorbance can be measured at 420 nm. Reduction gives a blue colour which can be measured at 830 nm. Titration is very sensitive and selective for the *ortho*-phosphoric form. See procedure in Chap. 29.

#### **Silicium**

##### **Principle**

With ammonium molybdate at pH 1.2 silica results in yellow coloration of silicomolybdic acid. Oxalic acid prevents interference by phosphorous. Analytical solutions resulting from alkaline fusion are recommended (cf. Sect. 13) with a sample specimen weight of 60 mg, an analytical matrix of 1% HCl in a final volume of 200 mL.

**Reagents**

- 1.5% hydrochloric acid solution
- 10% ammonium molybdate solution: dissolve 50 g in 500 mL of deionized water, shake and filter. The solution is only stable for few days
- 50 g L<sup>-1</sup> oxalic acid solution
- standard solution: as the silica solution is not stable, a standard solution should be freshly prepared for each analytical series; during alkaline fusion (cf. Sect. 31.2.5), add a graphite crucible containing 60 mg of pure dried silica and subject it to alkaline fusion using the same procedure as for the soil samples.
- The calibration range prepared by dilution of the standard solution with 1% HCl solution is:

mL for 100 mL	0	10	20	50	100
% SiO <sub>2</sub> in the solid soil sample	0	10	20	50	100

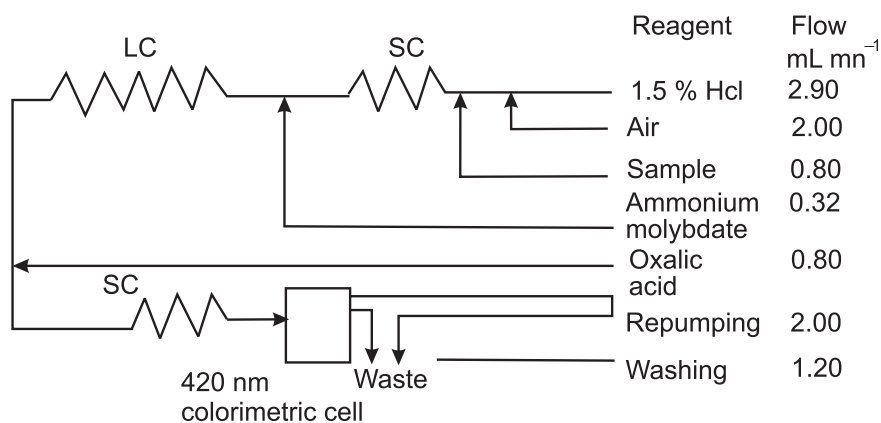

**Fig. 31.2.** Automation of the spectrophotometric titration of silica by segmented continuous-flow analysis (Paycheng 1980): SC: small mixing coil, LC: large coil, wavelength: 420 nm, rinsing with distilled water, speed: 30 samples per hour

Alternately, reference materials with known silica content can be used.

### **Procedure**

- In 50 mL flasks, add:
  - 10 mL of calibration or sample solution
  - 30 mL of 1.5% HCl solution
  - 5 mL of 10% ammonium molybdate solution
  - 5 mL of 5% oxalic acid solution.
- Homogenize, transfer in a colorimetric cell and measure absorbance at 420 nm. The calibration range provides the silica content of the initial solid sample without moisture correction. This titration can be automated by continuous-flow analysis (Fig. 31.2).

## **Aluminium**

### **Principle**

With eriochrome cyanine, aluminium gives a red-violet compound according to a very sensitive reaction which is not very stable. The procedure should be rigorously respected. The pH should be adjusted to 6.3. Interference by  $\text{Fe}^{\text{III}}$  is prevented by reduction into  $\text{Fe}^{\text{II}}$  by ascorbic acid.

### **Reagents**

- $1 \text{ g L}^{-1}$  eriochrome cyanine solution. Dissolve 1 g in 800 mL of deionized water, add 1 mL of concentrated nitric acid and complete to 1 L.
- 0.5% ascorbic acid solution.
- Buffer solution at pH 6.3. Dissolve 250 g of sodium acetate (anhydrous form or equivalent crystal form) in 500 mL of deionized water, add 10 mL of acetic acid. If necessary, adjust the pH on a pH-meter and complete the volume to 1 L with deionized water.
- $100 \text{ mg (Al}_2\text{O}_3) \text{ L}^{-1}$  stock solution. Attack 52.9 mg of pure aluminium powder with 10 mL of concentrated hydrochloric acid, complete to 1 L with deionized water, (more precise standard commercial solutions are also available).
- Calibration range. Between 0 and  $50 \text{ mg (Al}_2\text{O}_3) \text{ L}^{-1}$ , dilute the stock solution with 1% hydrochloric acid solution.

### **Procedure**

Solutions resulting from alkaline fusion in 1% HCl medium (cf. Sect. 31.2.6) are recommended.

- In a 50 mL flask, put 5 mL of sample or calibration point, add 15 mL of ascorbic acid solution
- allow to react for a few minutes then add 25 mL of buffer solution and 5 mL of eriochrome cyanine
- perform colorimetric measurement at 535 nm.

### **Remarks**

If the buffer solution is not sufficient to buffer the pH, treat with ammonia to neutralize the pH to a value just before the titration point.

Thioglycolate can be used as a reducing and sequestering agent instead of ascorbic acid.

A blank assay can be run by masking iron and aluminium with EDTA to enable subtraction of background absorbance coming from other elements (Charlot 1984).

Alternatively, eriochrome cyanine can be prepared according to Charlot (1984): in 200 mL of water, add 1 g of eriochrome cyanine, 25 g of sodium chloride, 25 g of ammonium nitrate, 2 mL of nitric acid, dissolve and bring to 1 L with deionized water. This preparation was found to be more efficient on extracts of saline soils than that described above in “Reagents” section (Paycheng 1980).

## **Titanium**

### **Principle**

The orange-yellow colour produced by titanium with hydrogen peroxide in sulphuric medium is measured. The addition of phosphoric acid enables correction of colour interference due to a high ferric iron content. The solution must not contain fluorides.

Other ions can also result in coloured complexes, but their intensity is generally weak (U, Mo, Nb), except in the case of V, which can be very awkward. Vanadium can be measured simultaneously with  $Ti^{IV}$  with a colorimetric measurement using two wavelengths: 410 (Ti) and 460 (V) nm. Addition of fluoride masks the titanium complex so that vanadium can be measured.

### **Reagents**

- 3% hydrogen peroxide solution: dilute 30% nitrogen peroxide ten times with deionized water
- sulphuric acid diluted eight times with deionized water
- phosphoric acid diluted three times with deionized water
- 1% hydrochloric acid solution

- 1 g (TiO<sub>2</sub>) L<sup>-1</sup> standard stock solution: weigh 600 mg of K<sub>2</sub>TiF<sub>6</sub> in a platinum crucible, add a few drops of deionized water and about three mL of concentrated sulphuric acid, evaporate to dry; repeat this operation, dissolve in 5% H<sub>2</sub>SO<sub>4</sub> solution and complete to 200 mL with deionized water
- Standard range: from 0 to 100 mg (TiO<sub>2</sub>) L<sup>-1</sup>, dilute stock solution with 1% HCl solution.

### Procedure

For major elements (cf. Sect. 31.2.6), extracts resulting from alkaline fusion in 1% HCl solution are recommended.

In a 50 mL flask, add 20 mL of sample or calibration solution, 10 mL of 1/8 sulphuric acid, 15 mL of 1/3 phosphoric acid, 5 mL of 3% hydrogen peroxide solution. Perform the colorimetric measurement at 410–420 nm.

## 31.2.10 Analysis by Flame Atomic Emission Spectrometry

### Conditions

Although atomic absorption spectrometry is often used instead of flame emission spectrometry (FES), FES is nevertheless useful for titration of alkaline elements, especially sodium and potassium. These elements are the easiest to atomize and ionize. To obtain maximum atomization and minimum ionization, the flame should not be too hot. An air–town gas, air–butane, air–propane or air–acetylene flame can be used. Alkaline elements can also be analyzed by plasma emission spectrometry (cf. Sect. 31.2.14), but sensitivity will be lower due to the high temperature of the plasma.

**Table 31.3.** Basal emission wavelength of alkaline elements in flame

element	Li	Na	K	Rb	Cs
$\lambda$ (nm)	670.79	589.00	766.49	780.02	852.11
		589.59	766.90	794.47	894.35

Ray of the shortest wavelengths (*top line*) is generally chosen for spectrometry, as the intensity is almost double that of the other

Emission corresponding to the transition between the fundamental electronic layer and the first excitation layer is the most useful for titration of alkaline elements. It often gives a radiating doublet with

approximately double the intensity of radiation at a lower wavelength (Table 31.3). The radiation of these radiating doublets is not always separated by commercial spectrometers, although this does not prevent satisfactory titration when the whole ray is used.

Other operating conditions depend on the type of apparatus. Elements other than alkaline elements can be also titrated by FES but AAS is generally preferred.

### **Calibration range and calculations**

Contents depend on the type of element and substrate. A range from 0 to 100 mg (K<sub>2</sub>O) L<sup>-1</sup> is generally chosen for potassium. A range between 0 and 50 mg (Na<sub>2</sub>O) L<sup>-1</sup> can be used for sodium. Commercial standard solutions can be used as can pure commercial products like K<sub>2</sub>CO<sub>3</sub> or Na<sub>2</sub>CO<sub>3</sub> using a technique similar to that used for the preparation of standards for AAS (cf. "Calibration Range"). The same standard can be used for AES and AAS techniques.

## **31.2.11 Analysis by Flame Atomic Absorption Spectrometry**

### **Major Elements by FAAS**

#### *Operating Conditions*

Table 31.4 lists the main instrumental conditions for titration of the major elements in soil solutions; the elements are classified according to their detection limit. In practice, phosphorous cannot be analysed using this method and Si, Ti and Al elements are less sensitive to this technique than to spectrophotometry (cf. Sect. 31.2.9). Trade publications (e.g. Wright and Stuczynski 1996; Pansu et al. 2001) or documentation accompanying commercial apparatuses should be consulted for more details on operating conditions.

#### *Calibration Range*

#### *Products*

- Commercial calibration solutions (cf. "Multi-Element Calibration for Major Elements") or commercial ultra-pure products can be used to prepare calibration ranges. The latter are classified in Table 31.5
- high-purity lanthanum oxide, La<sub>2</sub>O<sub>3</sub>
- ultra-pure concentrated hydrochloric acid
- ultra-pure concentrated nitric acid
- lithium metaborate (cf. Sect. 31.2.6)
- strontium metaborate (cf. Sect. 31.2.6).

**Table 31.4.** Main instrumental conditions for FAAS analysis of major elements of soils classified according to their detection limit (DL) in: (1) pure water (Varian documentation), (2) soil extract by alkaline fusion with mixture 0.5% Sr(BO<sub>2</sub>)<sub>2</sub> and 2% HNO<sub>3</sub> (Jeanroy 1972)

element	$\lambda$ (nm)	DL ( $\mu\text{g L}^{-1}$ ) (1)	DL ( $\mu\text{g L}^{-1}$ ) (2)	flame
Na	589.0	0.2	1	Air-C <sub>2</sub> H <sub>2</sub>
Mg	285.2	0.3	0.8	Air-C <sub>2</sub> H <sub>2</sub>
Ca	422.7	1	4	N <sub>2</sub> O-C <sub>2</sub> H <sub>2</sub>
Mn	279.5	2	5	Air-C <sub>2</sub> H <sub>2</sub>
K	766.5	3	2	Air-C <sub>2</sub> H <sub>2</sub>
Fe	248.3	6	12	Air-C <sub>2</sub> H <sub>2</sub>
Al	309.3	30	140	N <sub>2</sub> O-C <sub>2</sub> H <sub>2</sub>
Ti	365.4 364.3	50 100	250	N <sub>2</sub> O-C <sub>2</sub> H <sub>2</sub>
Si	251.6	300	400	N <sub>2</sub> O-C <sub>2</sub> H <sub>2</sub>
P	213.6	40,000		N <sub>2</sub> O-C <sub>2</sub> H <sub>2</sub>

- Matrix solution (A) according to the procedure for alkaline fusion described in “Procedure Using Strontium Metaborate” of section 31.2.6: dissolve 25 g of strontium metaborate in 200 mL of deionized water and 100 mL of concentrated nitric acid. Let cool and complete to 1 L. The resulting medium contains 2.5% of metaborate and 10% of nitric acid (five times the content of the attack matrix described in “Procedure Using Strontium Metaborate”).
- Matrix solution (A') according to the procedure for alkaline fusion described in “Procedure Using Lithium Metaborate” of section 31.2.6: dissolve 12.5 g of lithium metaborate in 200 mL of deionized water and 50 mL of concentrated hydrochloric acid. Let cool and complete to 1 L. The resulting medium contains 1.25% of metaborate and 5% of hydrochloric acid (five times the content of the attack matrix described in “Procedure Using Lithium Metaborate”).



– Lanthanum solution (L): dissolve 23.45 g of  $\text{La}_2\text{O}_3$  in 10 mL of 2% hydrochloric acid (10 mL of water + 2 mL of concentrated hydrochloric acid), complete to 100 mL. This solution contains 20% of lanthanum.

**Stock solution – procedure**

**Table 31.5.** Preparation of stock solutions (E or E') for analysis of major elements by atomic absorption spectrometry

element	oxide	maximal % oxide in the sample	solution concentration $\mu\text{g (oxide) mL}^{-1}$		usable product	weight in mg for 1L	
			attack of section 21.2.6			attack of section 21.2.6	
			E	E'		E	E'
Al	$\text{Al}_2\text{O}_3$	50	1,250	750	Al powder	661.7	397.0
Fe	$\text{Fe}_2\text{O}_3$	30	750	450	Fe powder	524.8	314.9
Mn	MnO	5	125	75	$\text{MnO}_2$	153.2	91.9
Mg	MgO	30	750	450	MgO	750.0	450.0
Ca	CaO	30	750	450	$\text{CaCO}_3$	1,339.3	803.6
Na	$\text{Na}_2\text{O}$	20	500	300	$\text{Na}_2\text{CO}_3$	854.8	512.9
K	$\text{K}_2\text{O}$	30	750	450	$\text{K}_2\text{CO}_3$	1,101.1	660.7
Ti	$\text{TiO}_2$	10	250	150	Ti powder	150.0	90.0
Si	$\text{SiO}_2$	100	2,500	1,500	$\text{SiO}_2$	2,500.0	1,500.0

The concentrations of stock solutions (column 4) correspond to five times the maximal concentration of the attack solution (cf. Sect. 21.2.6), i.e.

– for the attack E described in “Procedure Using Strontium Metaborate”: 100 mg sample, 200 mL final solution containing 0.5%  $\text{Sr}(\text{BO}_2)_2$  and 2%  $\text{HNO}_3$

– for the attack E' described in “Procedure Using Lithium Metaborate”: 60 mg sample, 200 mL final solution containing 0.25%  $\text{LiBO}_2$  and 1% HCl

The calibration solutions are prepared according to Jeanroy (1972) and Riandey et al. (1982). Table 31.5 lists the ingredients for the preparation of stock solutions for calibration ranges for the two types of soil attack by alkaline fusion described in “Procedure Using Strontium Metaborate” (E solution) and “Procedure Using Lithium Metaborate” (E' solution) with a concentration five times higher than the maximal content generally found in soils. Calibration solutions can be prepared either for one element or

for several elements in complex calibration solutions. Silica should be avoided in complex solutions as it leads to precipitation of aluminosilicates. The silica solution is prepared alone by alkaline fusion of pure silica, in the same way as for the fusion of the sample (cf. "Silicium"). Calibration solutions must be prepared in the same matrix as the attack matrix. Commercial standard solutions for AAS can be used. Alternatively solutions can be made with high-purity products (metals, oxides, carbonates, sulphates, etc.) as in the example below.

In a 400 mL beaker, put the exact mass of each standard product listed in Table 31.5 that is appropriate for the attack method used. Add a few mL of deionized water, then 20 mL of nitric acid (for the attack described in "Procedure Using Strontium Metaborate") or 10 mL of hydrochloric acid (for the attack described in "Procedure Using Lithium Metaborate"). Cover with a beaker cover and allow the attack to continue until total dissolution, heating slightly if needed. Let cool, transfer in a volumetric flask and complete to 1 L with deionized water.

**Table 31.6.** Required volumes of stock solution E or E' (Table 31.5) for 250 mL and corresponding contents in % oxide of soil samples for both attacks described in Section 31.2.6

no	volume of E or E' (mL) stock solution	volume of								
		Al <sub>2</sub> O <sub>3</sub> (%)	Fe <sub>2</sub> O <sub>3</sub> (%)	MnO (%)	MgO (%)	CaO (%)	Na <sub>2</sub> O (%)	K <sub>2</sub> O (%)	TiO <sub>2</sub> (%)	SiO <sub>2</sub> (%)
0	0	0	0	0	0	0	0	0	0	0
1	1	1	0.6	0.1	0.6	0.6	0.4	0.6	0.2	2
2	5	5	3	0.5	3	3	2	3	1	10
3	10	10	6	1	6	6	4	6	2	20
4	25	25	15	2.5	15	15	10	15	5	50
5	50	50	30	5	30	30	20	30	10	100

#### *Calibration Range – Procedure*

In 250 mL volumetric flasks, add the volumes of stock solution E or E' listed in Table 31.6. Add 50 mL of matrix solution A ("Procedure Using Strontium Metaborate") or A' ("Procedure Using Lithium Metaborate").

For solutions corresponding to the attack described in "Procedure Using Lithium Metaborate" add 1.25 mL of lanthanum solution L (for the attack described in "Procedure Using Strontium Metaborate", strontium is

sufficient to correct interference). Complete to 250 mL with deionized water.

Read the soil concentrations directly in % oxide on the calibration curves corresponding to Table 31.6 for the two attack procedures and "Procedure Using Strontium Metaborate" using sample specimens of respectively 100 mg E and 60 mg E' for 200 mL of solution. For other soil sample specimens using  $P$  (mg), multiply the final result by  $100/P$  (E) and  $60/P$  (E'), respectively. Moisture correction may be also necessary.

As an alternative to this external calibration technique (Table 31.6), the stock solutions listed in Table 31.5 can also be used for titration based on the method of standard additions.

**Table 31.7.** Trace elements measurable by FAAS using air–acetylene and nitrous oxide–acetylene flames

air–C <sub>2</sub> H <sub>2</sub> flame			N <sub>2</sub> O–C <sub>2</sub> H <sub>2</sub> flame		
element	$\lambda$ (nm)	DL ( $\mu\text{g L}^{-1}$ )	Element	$\lambda$ (nm)	DL ( $\mu\text{g L}^{-1}$ )
Cu	324.7	3	Mo	313.3	20
Co	240.7	5	Ba	553.6	20
Ni	232.0	10	Be	234.9	1
Cd	228.8	2	Eu	459.4	1.5
Zn	213.9	1	Sr	460.7	2
Ag	328.1	2	Tm	371.8	20
Cr	357.9	6	Yb	398.8	4
Cs	852.1	4			
Pb	217.0	10			
Pd	244.8	10			
Rb	780.0	10			
Rh	343.5	5			
Au	242.8	10			

Detection limits (DL) are for pure water and are thus lower than the DL that can be measured on soil extracts

### ***Trace Elements by FAAS***

A large number of trace elements can be determined by FAAS if their concentrations are not too low. Table 31.7 lists the main operating conditions for these elements.

The calibration ranges must be appropriate for the material to be analysed. For elements like Cu, Co, Ni, the usual ranges are between 0 and 2% oxide in soil. Generally the addition of lanthanum (cf. "Major Elements by FAAS" above) is not necessary for trace elements, but complementary assays should be run with and without added lanthanum. The calibration range can be prepared in the same way as for analysis of trace elements by ICP-AES, cf. "Complex Calibration Range for Titration of Trace Elements" in section 31.2.14).

### **31.2.12 Analysis of Trace Elements by Hydride and Cold-Vapour AAS**

#### ***Hydride AAS Technique***

##### *Principle*

**Table 31.8.** Elements titrated with the hydride method

element	CC ( $\mu\text{g L}^{-1}$ )	$\lambda$ (nm)
As	0.2	193.7
Bi	0.2	223.1
Hg	0.4	253.7
Sb	0.15	217.6
Se	0.3	196.0
Sn	0.4	235.5
Te	0.15	214.3

CC: characteristic concentration giving an absorbance signal of 0.0044 (1% absorption of incidental radiation), CC is 5–20 times greater than DL.  $\lambda$  is the recommended wavelength in nm

Some elements (see Table 31.8) can produce hydrides by action of sodium borohydride ( $\text{NaBH}_4$ ) in acid medium ( $\text{HCl}$  or  $\text{H}_2\text{SO}_4$ ). For an element E the reaction can be written:

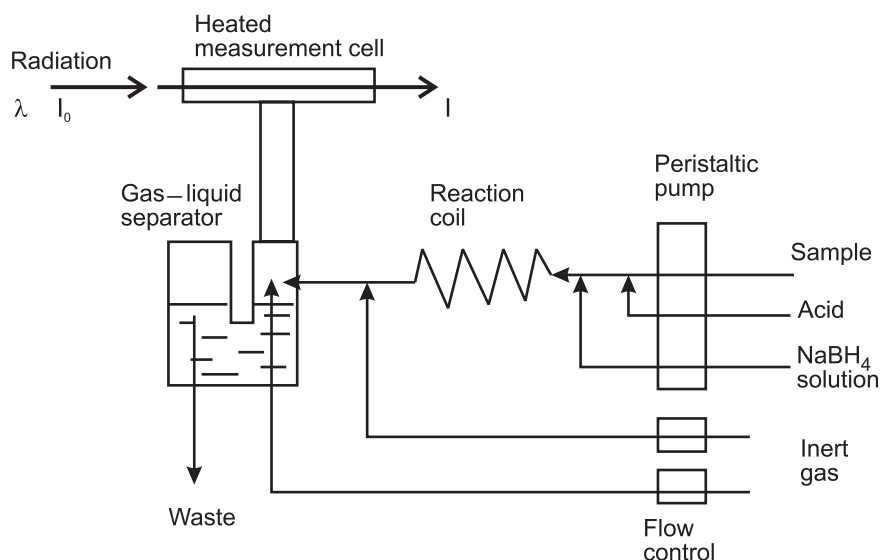
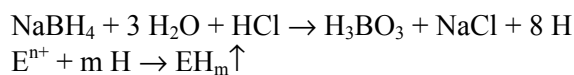

**Fig. 31.3.** Hydride atomic absorption spectrometry

Hydrides in gaseous form are drawn into an absorption cell formed by a silica tube (Fig. 31.3). Moderate heating of this tube at 800–900°C with an air–acetylene flame enables hydrides to be broken down into atomic forms of the elements. Absorbance of these elements is thus higher than in classical flame atomization (cf. Sect. 31.2.11) and the detection limit is greatly improved.

Most of the elements in Table 31.8 can be volatilized at high temperatures. Their determination in soils requires a suitable method of attack. We recommend acid attack in a closed vessel as described in Sect. 31.2.4.

### Reagents

- 0.6% sodium borohydride solution: in 50 mL of ultra-pure water, dissolve 0.5 g of soda then 0.6 g of sodium borohydride and complete to 100 mL with ultra-pure water. Fresh solution should be prepared each day
- ½ hydrochloric acid: add 50 mL of spectrographic grade concentrated hydrochloric acid in 40 mL of ultra-pure water, shake, let cool and complete to 100 mL
- 10% potassium iodide in ultra-pure water.

### **Standards**

Titration in the 0–100  $\mu\text{g L}^{-1}$  range can be performed for all elements in Table 31.8. Sometimes calibration curves are more linear in the 0–20  $\mu\text{g L}^{-1}$  range. It is easier to start with commercial standard solutions. For example, arsenic titration can start from a commercial solution at 1,000  $\text{mg (As) L}^{-1}$  which is diluted to 1  $\text{mg (As) L}^{-1}$  (two successive dilutions of 10 mL in 100 mL) to obtain the stock solution used to prepare the calibration range. In four 100 mL volumetric flasks, add 0, 0.5, 1 and 2 mL of the 1  $\text{mg (As) L}^{-1}$  stock solution. Complete the volumes to obtain the calibration range 0, 5, 10 and 20  $\mu\text{g (As) L}^{-1}$ . The final medium should be the same as that of the sample solution, (for the attack described in Sect. 31.2.4, add 4 mL of concentrated nitric acid giving a 4% nitric acid medium).

For certain elements like arsenic, it is recommended to perform reduction before analysis so only the  $\text{As}^{\text{III}}$  form is used. Indeed, the sensitivity of this titration depends on the yield of hydrides formed, which is itself linked to the oxidation state of this element in solution. Mix a sample of the As solution with 5 mL of  $\frac{1}{2}\text{HCl}$  + 5 mL of 10% KI solution. Heat for 20 min in a water bath at 60°C, let cool and complete to 50 mL with ultra-pure water.

### **Calculation**

If  $X$  is the content of a given element on the calibration curve in  $\mu\text{g L}^{-1}$  and  $V$  the volume (mL) of the attack solution,  $D$  the possible dilution factor before analysis and  $P$  the sample specimen of soil (g), the content  $T$  in ng (element)  $\text{g}^{-1}$  (soil) is expressed by  $T = X V D / P$ .

### **Cold-Vapour Technique**

#### **Principle**

This very sensitive technique is only used for titration of mercury. The apparatus is set up in the same way as for the hydride method shown in Fig. 31.3. The only difference is the measurement tube whose geometry is slightly different, allowing the output vapour to be trapped. A peristaltic pump enables addition of a stannous chloride solution and a hydroxylamine chlorhydrate solution which reduce mercury to the atomic state. The  $\text{Hg}^0$  element is then transported in vapour form by the inert gas into the measurement tube where absorbance is measured at 253.7 nm.

### Reagents

- 10% stannous chloride solution: dissolve 10 g of stannous chloride in 10 mL of ultra-pure hydrochloric acid, heat until complete dissolution, let cool and complete to 100 mL with ultra-pure water; fresh solution should be prepared each day
- 10% hydroxylamine chlorhydrate solution: dissolve 10 g in 100 mL of ultra-pure water
- ½ hydrochloric acid in ultra-pure water
- calibration range 0, 5, 10, 20  $\mu\text{g (Hg) L}^{-1}$  starting from a 1 mg (Hg)  $\text{L}^{-1}$  stock solution: in 100 mL volumetric flasks, add 50 mL of ultra-pure water, 4 mL of spectrographic grade concentrated nitric acid and 0, 0.5, 1 and 2 mL of stock solution, respectively. Complete to volume with ultra-pure water
- trap solution for mercury vapours: dissolve 3 g of potassium iodide and 0.25 g of iodine in 100 mL of deionized water.

Calculations are identical to those described in “Calculation”.

### 31.2.13 Analysis of Trace Elements by Electrothermal AAS

EAAS is currently one of the most sensitive techniques for titration of trace elements. For many elements, the detection limit of FAAS is lower by a factor of 100–1,000 with EAAS. The EAAS technique is particularly efficient when coupled with systems to correct non-selective absorption, particularly the Zeeman effect correcting system (Pansu et al. 2001). Furthermore, on liquid medium it is the most appropriate method for microanalysis as it requires only a few  $\mu\text{L}$  of solution for each element to be analyzed (usually 20  $\mu\text{L}$ ).

Satisfactory implementation of EAAS relies on optimization of instrumental parameters for each element in the titration medium, and very precise optimal atomization and decomposition temperatures. Chemical interferences can be minimized by using matrix corrective solutions added in the capillary tube at injection (for example 1  $\mu\text{L}$  for 10  $\mu\text{L}$  of sample). A matrix modifier that is often recommended is palladium nitrate ( $\text{Pd}(\text{NO}_3)_2$ ). Other modifiers can be used e.g.  $\text{Mg}(\text{NO}_3)_2$ ,  $\text{Ni}(\text{NO}_3)_2$  or  $\text{NH}_4\text{H}_2\text{PO}_4$  (see e.g. Hoenig and Kersabiec 1990). Table 31.9 lists the main trace elements titrated by EAAS. In addition, major elements can be titrated with much higher sensitivity than with FAAS (cf. “Major Elements by FAAS” in Sect. 31.2.11), however, these titrations generally do not justify the use of EAAS, which is more sophisticated and less repeatable than FAAS. These elements are consequently not included in Table 31.9.

The calibration range varies with the element concerned, and is often similar to the calibration ranges described in Sect. 31.2.12. Calculations are identical to those described in “Calculation” in Sect. 31.2.12.

**Table 31.9.** Trace elements in soils which can be analyzed by EAAS

element	$\lambda$ (nm)	CC ( $\mu\text{g L}^{-1}$ )	element	$\lambda$ (nm)	CC ( $\mu\text{g L}^{-1}$ )	element	$\lambda$ (nm)	CC ( $\mu\text{g L}^{-1}$ )
Ag	328.1	0.035	As	193.7	0.5	Au	242.8	0.22
Ba	553.6	0.85	Be	234.9	0.025	Bi	223.1	0.45
Cd	228.8	0.01	Co	240.7	0.21	Cr	357.9	0.075
Cs	852.1	0.55	Cu	324.7	0.3			
Ga	294.4	0.23	Ge	265.1	0.45	In	303.9	0.35
Li	670.8	0.2	Mo	313.3	0.35	Ni	232.0	0.24
Pb	217.0	0.28	Pd	244.8	0.43	Pt	265.9	3.5
Rb	780.0	0.05	Rh	343.5	0.4	Ru	349.9	0.75
Sb	217.6	0.5	Se	196.0	0.7	Sn	235.5	0.5
Sr	460.7	0.1						
Tb	432.7	0.18	Te	214.3	0.45	Tl	276.8	0.75
V	318.5	1.1	Yb	398.8	0.15	Zn	213.9	0.0075

CC: characteristic concentration in pure water giving an absorbance signal of 0.0044 (1% absorption of incidental radiation), CC is greater than DL,  $\lambda$  is the recommended wavelength in nm. The major elements in soils are not included in this table

### 31.2.14 Analysis by Inductively Coupled Plasma–AES

#### *Interest and Limitations*

ICP-AES is being increasingly used in geochemistry mainly because it is a multi-element technique. For most elements, its sensitivity is similar to



FAAS (cf. Sect. 31.2.11), but ICP-AES is less sensitive than EAAS (cf. Sect. 31.2.13), hydride or cold-vapour AAS (cf. Sect. 31.2.12), and ICP-MS (cf. Sect. 31.2.15).

Most disturbances that occur are caused by spectral interference due to the number of lines emitted at high temperatures in complex mediums. Mechanical disturbances may also occur due to changes in the input flow of the analytical solution and the resulting clogging of nebulizers in the case of solutions containing too high quantities of dissolved materials.

Another problem concerns the choice of a multi-element calibration strategy. Calibration solutions must have concentration ranges near the ranges of the mediums to be measured. Matrix interference is not common but can result in changes in sensitivity and in the curvature of the calibration curves, which may be different from those of the sample solutions. Two fundamental causes of variation in the emitted signal are (i) change in the temperature of the plasma, (ii) change in the input of analytical solution. Two possible ways to correct these disturbances are based on the use of internal standards. Ramsey and Coles (1992) recommended the use of a correcting programme based on two internal standards: rubidium to correct the change in sample input flow, and mercury to correct the emission temperature. For analysis of major elements (Si, Al, Fe, Mg, Ca and Na), Walsh (1992) proposed the use of gallium, cadmium and lithium as internal standards to reduce relative standard variation to about 0.5%. The elements added as internal standards are not analyzed; their initial amount in the analytical solution should be insignificant.

According to Walsh (1992) the random error resulting from the use of classical ICP-AES technique for analysis of geological materials is about 2%, i.e. of the same order of magnitude as other analytical techniques. In most cases the classical external calibration method can be used. For analytical mediums containing a small quantity of dissolved solid materials, precision is improved if the composition of the multi-element calibration range is as near as possible to that of the analytical medium. In addition, as with other methods, reference materials from inter-laboratory comparisons (Abbey 1992) enable the accuracy of analytical series to be checked.

### ***Multi-Element Calibration for Major Elements***

The medium for multi-element calibration range must be as similar as possible to the sample solution. The preparation described here concerns total analysis using the procedure with lithium metaborate described in "Procedure Using Lithium Metaborate". The weight of the sample speci-

men is 60 mg for a final volume of 200 mL. The final medium is 1% HCl, 0.25% LiBO<sub>2</sub>.

**Table 31.10.** Preparation of a multielement calibration range for major elements; contents expressed in % oxide in the soil sample (attack described in "Procedure Using Lithium Metaborate" of section 31.2.6: 60 mg sample specimen, 200 mL final volume), commercial stock solutions at 1 g (element) L<sup>-1</sup>.

	oxide solution	Al <sub>2</sub> O <sub>3</sub> (%)	Fe <sub>2</sub> O <sub>3</sub> (%)	TiO <sub>2</sub> (%)	CaO (%)	MgO (%)	Na <sub>2</sub> O (%)	K <sub>2</sub> O (%)	MnO (%)
mL of	0	0	0	0	0	0	0	0	0
1 g (el.) L <sup>-1</sup>	I	12.5	15	2.5	15	12.5	10	20	2.5
solution	II	25	30	5	30	25	20	40	5
	III	50	60	10	60	50	40	80	10
content of	0	0	0	0	0	0	0	0	0
solution (1 L)	I	23.62	21.45	4.17	20.99	20.73	13.48	24.09	3.23
mg (ox ) L <sup>-1</sup>	II	47.24	42.89	8.34	41.98	41.45	26.96	48.18	6.46
	III	94.47	85.78	16.68	83.95	82.90	53.92	96.37	12.91
% oxide	0	0	0	0	0	0	0	0	0
in soil	I	7.87	7.15	1.67	7.00	6.91	4.49	8.03	1.08
sample	II	15.75	14.30	2.78	13.99	13.81	8.99	16.06	2.15
	III	31.49	28.59	5.56	27.98	27.63	17.97	32.12	4.30

The calibration range in Table 31.10 corresponds to the elements Al, Fe, Ti, Ca, Mg, Na, K and Mn, the elements Si and P being quantified separately. For each element, prepare a blank assay (0) and 3 calibration points (I, II, III in Table 31.10) corresponding to possible oxide contents in soils and rocks.

Place the appropriate volume of each 1 g L<sup>-1</sup> stock solution in a 1 L volumetric flask (see Table 31.10), add 200 ml of a 12.5 g (LiBO<sub>2</sub>) L<sup>-1</sup> in 5% HCl solution. Complete to 1 L with deionized water to obtain the final medium of the sample solutions after attack (cf. "Procedure Using Lithium Metaborate"), i.e. 0.25% LiBO<sub>2</sub>, 1% HCl. This multi-element calibration range enables the results to be obtained directly as the percentage of oxide in the soil sample for a test specimen of 60 mg

(Table 31.10) and a final extraction volume of 200 ml. For a test specimen of  $M$  mg, the result has to be multiplied by  $60/M$ .

Titration of phosphorus is not very precise nor very sensitive with ICP-AES. Nevertheless, the P content can be measured if it is not too low. A calibration range can be prepared starting from a 1 g (P) L<sup>-1</sup> stock solution, giving P contents of 0, 10, 25, 50, 75 µg mL<sup>-1</sup>, corresponding to P<sub>2</sub>O<sub>5</sub> contents of 0, 22.90, 57.26, 114.52 and 171.77 µg mL<sup>-1</sup> in the solution and 0% 7.63% 19.09% 38.17% 57.25% in the initial sample.

Solutions containing silicon are not very stable. To measure silica, a standard reference material should be used (e.g. Geostandard, CRPG-CNRS 54 501 Vandœuvre les Nancy, France) and attacked in the same way as the samples. Alternatively, a known weight of pure commercial silica can be used. These solutions do not keep and silica should be titrated within two days after the attack.

### **Complex Calibration Range for Titration of Trace Elements**

The ICP-AES technique makes it possible to titrate 70 elements of the periodic table. In the same way as for the major elements (cf. "Multi-Element Calibration for Major Elements"), the standard solutions for the multi-element calibration range of trace elements should be prepared in the preparation medium. The sample calibration range in Table 31.11 corresponds to the eight trace elements that are most often titrated in soils and rocks. It is prepared in the same medium as for total attack in an open vessel (cf. "Procedure" in Sect. 31.2.3) and consequently does not include elements that can be lost by volatilization during the attack, e.g. Pb, Cd, As or Se. The Cr value may be underestimated in the event of incomplete attack of certain refractory minerals. As in "Multi-Element Calibration for Major Elements", the calibration range should be established starting from commercial stock solutions.

Prepare the solutions in 1 L volumetric flasks by adding the volumes of stock solutions listed in Table 31.11. Add 500 mL of ultra-pure deionized water, then 50 mL of concentrated hydrochloric acid and complete to 1 L with ultra-pure water at 20°C. Solution 0 (blank) can be prepared in the same way, but without addition of stock standard solution.

#### **Calculation**

For a sample specimen of  $P$  g (0.5 g) in a final volume  $V$  (mL) of solution (50 mL), the concentration  $C_s$  (µg g<sup>-1</sup>) for each element of the sample results from that found on the corresponding calibration curve  $C_1$  (µg mL<sup>-1</sup>) by:  $C_s = C_1 V/P$ .

**Table 31.11.** Example of multi-element calibration range for trace elements

element	mL of stock solution at 1 g L <sup>-1</sup> for 1 L of solution III	solution III (mg L <sup>-1</sup> )	solution II (mg L <sup>-1</sup> )	solution I (mg L <sup>-1</sup> )
Ba	15	15	7.50	3.75
Be	1	1	0.50	0.25
Co	5	5	2.50	1.25
Cr	5	5	2.50	1.25
Cu	2.5	2.5	1.25	0.62
Ni	5	5	2.50	1.25
Sr	15	15	7.50	3.75
Zn	5	5	2.50	1.25

### ***Calibration Range for Titration of Rare Earth***

Prepare the calibration range in the same way as for the other trace elements (cf. above “Complex Calibration Range for Titration of Trace Elements”) in a 5% hydrochloric acid medium corresponding to total attack in an open vessel (cf. “Procedure” in Sect. 31.2.3). Commercial stock solutions can be used. Quantities for the most concentrated solution III are listed in Table 31.12 (Le Cornec, IRD, Bondy, France, personal communication). The standard solutions are all in 5% hydrochloric acid medium.

### ***Operating Conditions for ICP-AES Equipment***

As each type of apparatus requires specific adjustments, the reader is advised to consult specialized publications and to respect the manufacturer’s instructions. Table 31.13 gives some wavelengths that can be used for the emission lines of soil elements by plasma emission spectrometry. For other measurements, the reader should refer to more complete publications (e.g. Boumans 1981; Winge et al. 1982).

**Table 31.12.** Preparation of a multi-element calibration range for titration of rare earth (+ Yttrium)

element	stock solution (g L <sup>-1</sup> )	mL stock solution for 1 L solution III	solution III (mg L <sup>-1</sup> )	solution II (mg L <sup>-1</sup> )	solution I (mg L <sup>-1</sup> )
Ce	1.0	2.0	2.00	1.000	0.500
Dy	0.1	5.0	0.50	0.250	0.125
Eu	0.1	2.5	0.25	0.125	0.062
Er	0.1	5.0	0.50	0.250	0.125
La	1.0	1.0	1.00	0.500	0.250
Nd	1.0	1.0	1.00	0.500	0.250
Sm	0.1	5.0	0.50	0.250	0.125
Yb	0.1	5.0	0.50	0.250	0.125
Y	1.0	2.0	2.00	1.000	0.500

### 31.2.15 Analysis by Inductively Coupled Plasma-Mass Spectrometry

#### *Interest and Difficulties*

ICP-MS is analysis by mass spectrometry of ions emitted in a plasma into which the sample solution is injected (Fig. 31.4). In theory, all the elements of the periodic table and their isotopes can be measured by mass spectrometry, and, in addition, this type of detection is extremely sensitive.

However, in practice its implementation is rather delicate and requires an experienced operator. The equipment is expensive and is time-consuming to install. All analyses and attacks should be performed in a dust-free room. Protective clothing must be worn, the lab glassware must be very carefully cleaned and all the reagents must be of high purity. These requirements are similar to those of other techniques for analysis of trace element such as EAAS (cf. Sect. 31.2.13) but in this case it is even more important to respect them.

**Table 31.13.** Some wavelengths ( $\lambda$  in nm) of emission lines usable in soil analysis by ICP-AES and corresponding detection limits (DL)

element	$\lambda$ (nm)	DL ( $\mu\text{g L}^{-1}$ )	element	$\lambda$ (nm)	DL ( $\mu\text{g L}^{-1}$ )	element	$\lambda$ (nm)	DL ( $\mu\text{g L}^{-1}$ )
Al	396.152	4	Ti	337.280	1	Si	288.158	18
	167.081	1.5		334.941	0.6		251.611	5
Fe	259.940	1.5	Mn	257.610	0.3			
Ca	317.933	6	Na	588.995	1	P	213.618	19
	393.366	0.03					177.499	18
Mg	285.213	0.9	K	769.896	20			
	279.553	0.1		766.490	10			
Sr	421.552	0.06	Cu	324.754	2	Co	228.616	5
	407.771	0.02						
Ni	231.604	5.5	Ba	455.403	0.07	Cr	267.716	4
Zn	213.856	0.9						
Y	371.030	0.2	La	408.672	0.02	Ce	413.380	9
				379.478	0.02		418.660	7.5
Nd	430.358	2.5	Dy	353.603		Sm	359.262	8
	401.225	2		353.170	0.3		442.434	7
Yb	328.937	0.3	Eu	381.967	0.3			

*Remarks:* DL ( $\mu\text{g L}^{-1}$ ) is measured in pure water matrix, for soil extracts the DL can be higher

- lines of Al at 167.081 nm and P at 177.499 nm require purging of the optical channel and monochromator (vacuum, Ar, N<sub>2</sub>) to avoid absorbance of O<sub>2</sub>
- line Ca at 393.366 nm may be too sensitive if the concentration is high
- line K at 766.490 nm can be obstructed by Mg
- line La at 379.478 nm is obstructed by V and Fe
- line Sm at 442.434 nm, the spectral background is disturbed by an argon line located nearby

Another important question is the choice of the isotopes or isotopic combinations to take into account for the analysis of a given element. The mass spectra record the response of the detector (per unit of time) according to the  $m/z$  ratio characteristic of each ionized form of mass  $m$  and charge  $z$ . Because of the high temperature of the argon plasma (>5,000 K), normally all the chemical species are atomized and ionized.

However the temperature decreases very rapidly at the plasma output and at the input of the spectrometer, and recombination of ions can occur particularly in the most abundant species: argon, oxygen, nitrogen, ions coming from the acid medium, and major matrix ions. It is thus important to consider all the atomic and molecular species that can exist in the spectrometer, even in a very transitory way. This phenomenon could cause isobaric interferences (the same  $m/z$  for two species) which then have to be located.

Many authors proposed solutions for problems of interference. A lot of elements have several isotopes of known natural abundance that can be used to avoid analytical interferences. It is more difficult to find solutions for naturally monoisotopic elements (natural abundance is 100%, Table 31.14).

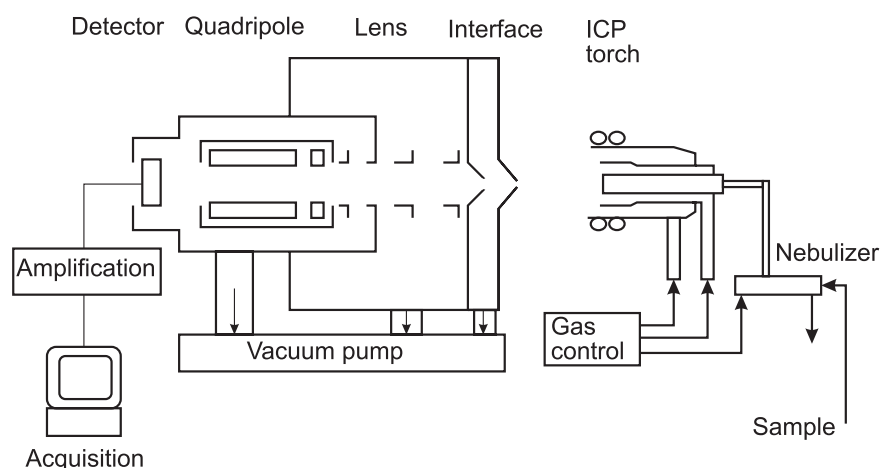

**Fig. 31.4.** Inductively Coupled Plasma - Mass Spectrometer

Table 31.14 lists the most commonly used isotopes and certain interferences, but other choices are possible depending on the type of study. For example, for paleoclimatology, Le Cornec and Corrège (1997) titrated U, Ca and Sr simultaneously in corals. There are marked differences in concentration between the ultra-traces of uranium and the major elements Ca and Sr. For uranium, the most abundant isotope  $^{238}\text{U}$  is used. The isotope  $^{40}\text{Ca}$  cannot be used due to interference with  $^{40}\text{Ar}$ . Because of the strong calcium concentration, the  $^{44}\text{Ca}$  (natural abundance na: 2.086% of total calcium) and  $^{42}\text{Ca}$  (na: 0.647%) isotopes are not usable as they saturate the detector. The  $^{43}\text{Ca}$  (na: 0.135%) and

$^{48}\text{Ca}$  (na: 0.187%) isotopes are used instead, but interference  $^{43}\text{Ca} - ^{43}\text{Ca}$  with  $^{86}\text{Sr}$  should be checked.

Another problem with the ICP-MS technique is the instability of measurements when analytical solutions are used that have large quantities of dissolved solids or particulate solid residues. The diagram in Fig. 31.4 shows the difficulty involved in setting up and running the apparatus. The torch provides an argon plasma at atmospheric pressure at more than 5,000 K, whereas the mass spectrometer functions cold and under vacuum. The vacuum pumps must have a strong flow. The interface between the torch and the spectrometer is formed by two cones each with a small opening through which gas species from the plasma penetrate at supersonic speed. Variations in flow at the interface can cause serious instability. The cones should be cleaned regularly. Methods such as internal calibration and isotopic dilution are recommended to control instability during the course of measurement. The time lag and number of rinses between each injection should be sufficient to avoid effects of memory from one sample to another. With matrix solutions with a small quantity of solid residues, stability is comparable to plasma atomic emission spectrometry and sensitivity is around 1,000 times better.

In spite of the above-mentioned difficulties, plasma-mass spectrometry is a very promising method thanks to its great sensitivity and especially to the availability of a great number of isotopes of natural elements. Exploration of the range of possibilities offered by this method for geochemistry (Falkner et al. 1995), cosmochemistry (Shinotsuka and Ebihara 1997), pedology (Soltanpour et al. 1996), sciences of the environment (Trolard et al. 2002), sedimentology, etc. is only beginning. There is no doubt that it represents progress in the entire range of soil sciences.

### ***Implementation***

The preparation of the sample solutions for ICP-MS has to be particularly thorough to avoid isobaric interference with the matrix solution. Diluted nitric acid is recommended as final medium (cf. Sect. 31.2.2) starting from acid digestions (cf. Sects. 31.2.3 and 31.2.4) after careful elimination of other acids. Lithium metaborate is also recommended as reagent for alkaline fusion (cf. Sect. 31.2.6). The preparation of multi-element calibration ranges is similar to plasma emission spectrometry (cf. Sect. 31.2.14). Microwave digestion is also possible (Das et al. 2001).



**Table 31.14.** Frequently used isotopes for ICP-MS analysis (from Jarvis 1994b, Navez 1997)

element	<i>m/z</i>	abundance	Interference	Element	<i>m/z</i>	abundance	interference
Li	7	92.5		Be	9	100	
B	11	80		Na	23	100	
Mg	24	79		Al	27	100	
Si	29	4.7	NH	P	31	100	NO, NOH
S	33	0.75	O <sub>2</sub> H	Cl	35	75.8	little sensitive
K	39	93.3		Ca	44	2.08	N <sub>2</sub> O
Sc	45	100	CaH	Ti	47/49	7.3/5.5	SOH, CaH
V	51	99.7	ClO	Cr	52/53	83.8/9.5	ClOH
Mn	55	100		Fe	56/57	91.7/2.2	ArO, ArOH
Co	59	100		Ni	60	26.1	
Cu	63/65	69.2/30.8		Zn	66/68	27.9/18.8	S <sub>2</sub>
Ga	71	39.9		Ge	72/73	27.4/7.8	FeO, FeOH
As	75	100	ArCl	Se	77	7.6	ArCl
Br	79/81	50.7/49.3		Rb	85	72.2	
Sr	88	82.6		Y	89	100	
Zr	90	51.4		Nb	93	100	
Mo	95	15.9 <sup>2</sup>		Ru	99/101	12.7/17.0	
Rh	103	100		Pd	105	22.3	
Ag	107/109	51.8/48.2		Cd	111	12.8	
In	115	95.7	Sn	Sn	118	24.2	
Sb	121	57.3		Te	125	7.1	
I	127	100		Cs	133	100	
Ba	137	11.2		La	139	99.9	
Ce	140	88.5		Pr	141	100	
Nd	143/145/146	44.4		Sm	147/149/152	28.8/26.7	BaOH, CeO
Eu	151/153	47.8/52.2	BaO	Gd	157	15.7	PrO, CeOH
Tb	159	100		Dy	163	24.9	NdOH, SmO
Ho	165	100	SmO	Er	166/167	33.4/56.3	SmO, NdO

Tm	169	100		Yb	172/173	21.8/38.1	GdO
Lu	175	97.4	GdOH	Hf	178	27.2	DyO
Ta	181	99.9		W	182	26.3	
Re	185	37.4		Os	189	16.1	
Ir	193	62.7		Pt	194/195	32.9/33.8	
Au	197	100		Hg	202	29.8	
Tl	205	70.5		Pb	206/207/208	98.6	sum of isotopes
Bi	209	100		Th	232	100	
U	238	99.3					

According to Falkner et al. (1995), *external calibration* methods ensure acceptable precision (3–8% coefficient of variation) for measurements far from the detection limits (DL) when similar mediums are used for calibration solutions and sample solutions. Measurements must be sufficiently spaced and rinsing must be sufficient to avoid possible effects of memory. At the IRD laboratory of Bondy (France), the degree of precision of the external calibration method is generally lower than 3% for concentrations above the DL, and 5–10% for concentrations close to DL (Le Cornec, IRD Bondy, France, personal communication). The method of *standard additions* can also improve the results in the case of complex and variable matrices. The *internal standard* method enables precision to be improved to 2–5% in both the external calibration method and the standard additions method. The internal standard must be close to the analyte in mass and ionization potential. This makes it possible to correct the measured signal by using its relationship with that of the internal standard as well as the standards or the samples. The *isotopic dilution* method uses one of the isotopes of the measured element as internal standard, thereby minimising the error of the internal standard method resulting from the proximity of the two isotopes in mass and ionization potential. Known volumes, concentrations and enrichment of the desired isotope (spike) have to be added to known volumes of titrated solutions. The concentration of the titrated element can then be calculated with a high degree of precision (0.1–1%).

The ICP-MS technique can be used to determine isotopic ratios, though generally with lower precision than that of thermal ionization-mass spectrometry (TIMS).

### 31.3. Analysis on Solid Medium

#### 31.3.1 Methods

It has always been more difficult to chemically analyse solids than solutions. The atomic organization of solids is very elaborate, electrons of the external layers of atoms are mobilized in the conduction and valence bands, and are thus not directly accessible for chemical analysis. Formerly, it was necessary to destroy the lattice to break down the atomic entities, after which the usual range of chemical reactions could be used.

However, the situation changed completely after major discoveries concerning atomic structure, quantum chemistry and the interactions between radiation and matter. These fundamental discoveries led to an increase in the number of techniques available making it possible to observe the different energy levels of matter (Pansu et al. 2001).

The study of the organization of solid structures or mineralogy is concerned with lower energetic levels (cf. Part 1). Optical and electronic microscopy use photons or electrons transmitted or reflected by the surface layers for imaging techniques. X-rays or electronic radiations from deeper crystalline planes make it possible to characterize crystalline structures. The vibrations caused by infra-red radiations enable characterization of certain molecular bonds.

Higher energy levels of excitation are necessary for the physico-chemical analysis of solid materials. In conducting materials, a high-intensity flow of electrons allows atomization of the matter into a gas state and excitation of the outer electron layers of the atoms. The radiation emitted during the relaxation processes makes it possible to characterize and quantify these atoms. This is arc or spark spectrometry which resembles techniques with other energy sources of atomization such as flame or plasma emission spectrometry described in Sect. 31.2.

Excitation can also concern internal electronic layers of atoms with more complex processes of relaxation. Depending on the source of excitation and radiation from the target material, a wide range of spectroscopic methods are available, particularly methods using X-ray fluorescence. Microprobe techniques provide an accurate map of the chemical composition of solid materials at a microscopic scale. Lastly, excitation can affect the atomic nucleus itself, generally under the effect of a neutron bombardment, and analysis of the radiation emission from relaxation of the nucleus. This is neutron activation analysis.

Most of the spectrometric techniques described in Sect. 31.2 can theoretically also be used for solid materials. And some of them, for example EAAS using the Zeeman effect, have in fact been used. However, their use for solid materials is often limited by methodological problems. The main difficulty in flame or plasma emission spectrometry, in AAS and in plasma mass spectrometry is the reproducible introduction of a solid sample into the atomization source. This problem has already been the subject of many tests and proposals. It was partly solved by introducing the solid sample in the form of a suspension (slurry) into a liquid. Nevertheless, analysis of solid samples has never been particularly successful. Consequently most analysts preferred the methods using solubilization described in Sect. 31.2 of this chapter as they are well tested and much more reproducible. This preference was often reinforced by the difficulty of obtaining standards with a solid matrix close to that of the samples. Today this argument is less justified thanks to the availability of reference materials.

Arc and spark spectrometry requires conducting samples and thus cannot be directly used for the main soil materials. The sample generally has to be prepared by mixing it with graphite powder to make it conducting. This is undoubtedly the reason these methods have been more commonly used in metallurgy than in geology and soil sciences, where they have often remained at the qualitative or semi-quantitative stage in spite of promising beginnings (Voïnovitch 1988).

The main methods of quantitative analysis that are currently used for solid geological materials are: (i) microprobe techniques (at a microscopic scale, cf. Chap. 8), (ii) at a macroscopic scale X-ray fluorescence (cf. Sect. 31.3.2) and neutron activation analysis (cf. Sect. 31.3.3).

### 31.3.2 X-ray Fluorescence Analysis

#### **Principle**

When a sample is bombarded with high-energy X-ray radiation, a secondary X-ray is emitted at different wavelengths characteristic of each element of the sample. The same type of emission spectrum can be observed when other excitation sources are used, for example a flow of electrons in electronic microprobe of Castaing (1961). This X-ray emission spectrum results from excitation of the electrons of the internal atomic layers which change temporarily to higher quantum levels of energy: K to L layer, K to M layer, L to M layer, etc. While returning to its initial state, the excited electron emits an energy  $E$  (eV) related to the wavelength  $\lambda$  (nm) according to the Planck relation:  $E = \frac{1240}{\lambda}$ .

The X-ray range extends from the 0.01 to 20 nm, between UV and  $\gamma$  radiations, but the range used in X-ray fluorescence is limited to from 0.02 to 2 nm. The lightest elements, H and He, do not have a spectrum of X-ray fluorescence. The number of possible transitions increases greatly with the atomic number, but the transitions used in analysis are generally simple. They are often those of the deep layers, particularly the K layer. These lines are also referred by the Siegbahn terminology, i.e. for an element of symbol Sy:  $SyK\alpha_1$ ,  $SyK\beta_2$ ,  $SyL\alpha$ , etc. This terminology shows the position of the electronic vacancy (e.g. layer K, L), the transition ( $\alpha$ : vacancy layer to next layer,  $\beta$ : vacancy layer to following layer, etc.) and relative intensity of the transition (1 more intense than 2, etc.). Lines  $K\beta$  are approximately six times less intense than the corresponding  $K\alpha$  lines.

#### **Equipment**

A diagram of X-ray fluorescence equipment can be seen in Fig. 31.5. The excitation source is an X-ray tube whose principle is well-known. Electrons emitted by a filament heated to a high temperature are accelerated in an electric field (the potential can reach 50 kV) towards an metallic anode (anticathode). The electrons are slowed down in contact with the anode with emission of an X-ray spectrum made of a continuous band, and lines of metal with high atomic numbers comprise the anode (e.g. rhodium, tungsten). The lowest wavelength of the spectrum can be calculated according to the relation of Planck (cf. "Principle" in Sect. 31.3.2).

The main difference between the apparatuses is the identification mode of secondary X rays emitted by the sample: one-channel system with filter, wavelength dispersion, energy dispersion. Apparatuses with *wavelength dispersion* are the most widely used in earth science. They function according to the Bragg law (cf. Chap. 4), connecting the wavelength  $\lambda$ , the incidence angle of the beam  $\theta$  and the reticular distance  $d$ :  $\lambda = 2d \sin \theta$ . With a crystal of known  $d$ , the wavelength is directly related to the angle of incidence on the rotating crystal. Several materials can be used for this crystal (Jones 1991). The choice of a suitable apparatus depends on the wavelengths analysed, the ideal being that the  $2d$  spacing of the reticular plans is similar to that of the wavelengths. Systems with a curved crystal aim to optimize focusing on the detector. The collimator is replaced by a slit, crystal and detectors are located on the same circle of focus or Rowland circle. *Energy dispersion* systems have been improved since the 1960s as a result of progress in electronics. A semi-conductor makes it possible to recognize each photon according to its energy and to count it in a measurement channel (multi-channel detectors).

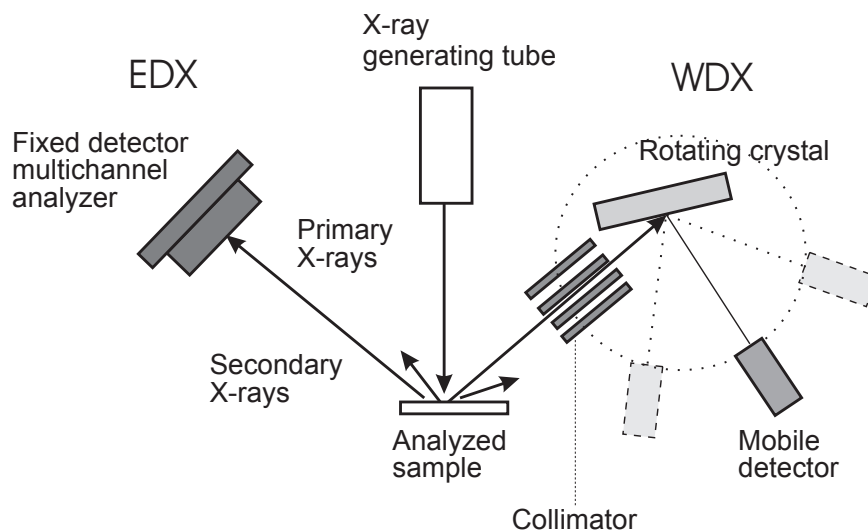

**Fig. 31.5.** Diagram of X-ray fluorescence equipment showing two possible types of detection: wavelength dispersive X-ray using flat or curved crystal (WDX on the *right*) and, energy dispersive X-ray (EDX on the *left*)

### ***Interest and Limits***

Another interesting aspect is that it is not destructive for the sample as during the relaxation process, the atoms return to their initial state.

X-ray fluorescence is a rapid analytical method that has a double advantage (i) multi-element analysis and (ii) direct analysis on solid materials. It enables detection of more than 80 elements with atomic numbers higher than eight (starting from fluorine). The method was used even for the analysis of lighter elements: carbon, nitrogen and oxygen in soils (Jones 1991). Certain elements like Br, S and P can be sensitively analyzed by X-ray fluorescence whereas their analysis using other techniques can be problematic.

X-ray fluorescence makes analysis of trace elements possible. However its sensitivity is often lower than the more powerful techniques of atomic absorption (cf. Sects. 31.2.12 and 31.2.13), plasma emission (cf. Sects. 31.2.14 and 31.2.15) or neutron activation (cf. Sect. 31.3.3). Jones (1991) provided an approximate guide to the minimum detectable concentrations which vary greatly with the atomic number of the element concerned. Thus from sodium ( $Z = 11$ ) to calcium ( $Z = 20$ ) the detectable minima decrease exponentially with the atomic number from  $1,000 \mu\text{g g}^{-1}$  for Na to approximately  $2 \mu\text{g g}^{-1}$  for Ca. The most sensitive elements are transition metals Cr to Zn with a detection limit near  $1 \mu\text{g g}^{-1}$ . This threshold then increases with the atomic number, and the detection limit for Ba ( $Z = 56$ ) is approximately  $10 \mu\text{g g}^{-1}$ .

The main difficulty in analysis by X-ray fluorescence concerns the matrix effects; this often resulted in the method only being used for qualitative or semi-quantitative analysis. Some disturbances are physical and concern homogeneity, particle size, surface quality and thickness of the sample. Other disturbances are chemical (i) spectral interferences between elements, (ii) inter-element effects of absorption or exaltation of the re-emitted radiation. Background noise from the matrix is a serious source of potential error. Indeed, contents are calculated by difference between a peak and the background noise on both sides of this peak.

Solid samples must be carefully prepared by very fine crushing, the sample must have a very smooth surface, and not be too thick to reduce background noise but thick enough to avoid reducing fluorescence. The composition of the calibration standards must be close to that of the sample.

For analysis of major elements, the best way to prepare a sample is to make a solid solution or glass with an alkaline borate in a similar way as for attack by alkaline fusion (cf. Sect. 31.2.6). In this way samples and standards are transformed into homogeneous thin flat discs. The works of Norrish and Hutton (1969) provided a reference for geological materials

on this subject. The same authors also proposed a method of calculation allowing correction of the matrix effects, thereby making X-ray fluorescence an appropriate method for quantitative analysis.

Alkaline solid solutions result in dilution of the sample and are consequently not suitable for analysis of trace elements, or even for analysis of not very sensitive major elements like sodium (and even magnesium in certain samples). Instead compressed disks are recommended for these elements in which great pressure is applied to the finely crushed sample and a thin flat disc is obtained.

### ***Analysis of Major Elements***

The method described here was originally proposed by Norrish and Hutton (1969), then by Jones (1982) and by Karathanasis and Hajek (1996).

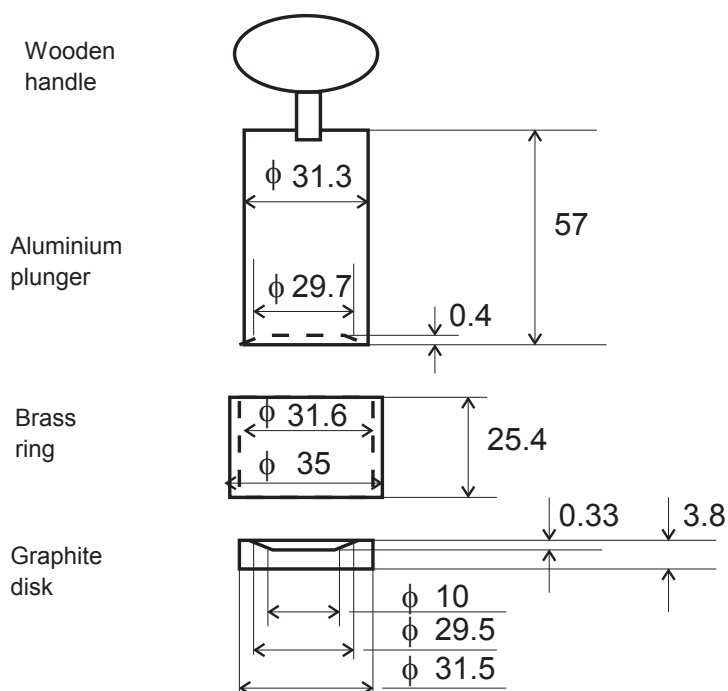

**Fig. 31.6.** Mould for preparation of disc-shaped samples of solid solution of borated glass for analysis of the major elements by X-ray fluorescence (according to Norrish and Hutton 1969; dimensions in mm)



### *Equipment*

- 15 mL crucibles made of 95% Pt and 5% Au alloy
- tongs with platinum tips for handling hot crucibles or a ring made of platinum wire for stirring the molten mixtures
- mould for the discs (Fig. 31.6)
- Meker burner or muffle furnace (1,000°C)
- heating plate regulated at 200°C.

### *Products*

- Fusion mixture: use a commercial mixture or prepare a synthesis mixture as follows: for 100 g, mix 46.53 g of lithium tetraborate ( $\text{Li}_2\text{B}_4\text{O}_7$ ), 36.24 g of lithium carbonate ( $\text{Li}_2\text{CO}_3$ ), 16.17 g of lanthanum oxide ( $\text{LaO}$ ), and 1.07 g of lithium nitrate ( $\text{LiNO}_3$ )
- sodium carbonate and diluted hydrochloric acid for cleaning the crucibles
- pure silica and other major oxides of soils for disks for the blank assay and standards of calibration.

### *Procedure*

- Use samples crushed to less than 200  $\mu\text{m}$  and dried at 110°C.
- Heat the mould (Fig. 31.6) on a heating plate set at 220°C.
- Introduce exactly 340 mg of sample and 1.8 g of melting mixture in a previously tared Pt/Au crucible. Mix carefully with a spatula, then bring slowly to melting with a Mecker burner or in a muffle furnace at 1,000°C. Stir the liquid in fusion with the platinum wire or swirl the crucible with a tong to mix well and to eliminate bubbles.
- Place the brass ring around the graphite disc (Fig. 31.6). Decant the melted mixture in the centre of the disk and immediately level it with the aluminium plunger. Withdraw the plunger and ring and transfer the disc sample between two heat insulators placed on the heating plate. At the end of the procedure, cool the heating plate slowly then put the disc-shaped samples into small numbered envelopes and store in a desiccator until analysis.
- In the same way as the samples prepare (i) a disc made of pure silica which is used as a blank for measurement of background noise, (ii) standard calibration discs starting from oxides mixed with pure silica. Reference samples can also be used as standards.
- For quantitative analysis, measure the weight loss of a sample separately by heating it to 1,000°C under the same conditions.

The measurement procedure for counting X-ray fluorescence radiations depends on the equipment used. As a source of excitation applied to the disc-samples, a chromium X-ray tube under 40–50 kV is

appropriate for all the major elements except Mn for which a tungsten tube is recommended.

### Calculations

For a given element,  $N_p$  is the measured counting rate of the sample peak or the standard peak (corrected for dead time of the equipment), and  $N_b$  is the peak of the background noise or blank assay.

Calculate the counting rate of the peak sample ( $N_e$ ) or standard ( $N_s$ ) by the respective differences peak minus blank ( $N_p - N_b$ ) or peak minus background noise ( $N_p - (N_{b+} + N_{b-})/2$  where  $N_{b+}$  and  $N_{b-}$  is the background noise measured on both sides of the peak).

$C_s$  being the percent concentration of the standard (in oxide percentage), the initial estimation of concentration  $C_e$  of the sample is expressed by

$$C_e = C_s \frac{N_e}{N_s}$$

The sum of percents of major elements and weight loss during fusion should be close to 100%. For more precise measurements, the calculation of matrix correction developed by Norrish and Hutton (1969) can be applied

$$C_e^1 = C_e \left( M + \sum_i p_i m_i + p_p m_p \right),$$

where  $C_e^1$  is the corrected concentration of oxide as a percentage of element  $e$ ,

$p_i$  is the mass fraction of each oxide ( $p_i = C_i/100$ ),

$p_p$  is the mass fraction of loss by volatilization during preparation,

$M$  is the correction coefficient of the matrix (borated glass) for element  $e$ ,

$m_i$  and  $m_p$  are the correction coefficients for element  $e$  of each oxide  $i$  of the sample and for loss by volatilization, respectively.

The correction coefficients  $M$ ,  $m_i$  and  $m_p$  were determined by Norrish and Hutton (1969) and by Jones (1982). For example, application of the formula to calculate the corrected percent of  $\text{Fe}_2\text{O}_3$  for an approximate concentration  $C_e = 8.4\%$  with a weight loss of 9.5% gives

$$\begin{aligned} C_{\text{Fe}_2\text{O}_3}^1 = & 8.4 [1.046 + (0.084 \times (-0.027)) - 0.031 p_{\text{MnO}} + 0.146 p_{\text{TiO}_2} + \\ & 0.134 p_{\text{CaO}} + 0.126 p_{\text{K}_2\text{O}} - 0.06 p_{\text{SO}_3} - 0.06 p_{\text{P}_2\text{O}_5} - 0.065 p_{\text{SiO}_2} \\ & - 0.074 p_{\text{Al}_2\text{O}_3} - 0.09 p_{\text{MgO}} - 0.110 p_{\text{Na}_2\text{O}} + (0.095 \times (-0.163))] \end{aligned}$$

The formula is applied in a similar way for all the oxides in the sample. Starting from the corrected percentages  $C_e^1$ , the new mass fractions are deduced and the correction formula is again applied to obtain the new

estimated percentage  $C_e^2$ . The correction process is continued until the difference between one and the following estimate is negligible. In the best possible case, the sum of corrected values and weight loss should be  $100 \pm 0.1\%$ . Manual calculations of correction coefficients are rather time-consuming, but can be done very rapidly with a computer thereby avoiding the risk of introducing errors in the coefficients.

### ***Analysis of Minor and Trace Elements***

There are many alternative methods for the analysis of minor and trace elements using X-ray fluorescence. The method described below was inspired by Norrish and Chappell (1977), Jones (1982) and Karathanasis and Hajek (1996). The goal is to obtain a pelletized sample with a homogeneous surface that is as flat and as smooth as possible for analysis. This is not possible with all soils and alternative solutions will be required, e.g. additives for crushing and pelletising or using film as a support.

#### ***Equipment and Reagents***

- Non-polluting grinder to reduce the samples to a very fine particle-size i.e. under  $50 \mu\text{m}$ . Several alternatives are possible, see Tan, 1996; Pansu et al. 2001
- 25 ton hydraulic press
- pressing mould of the type shown in Fig. 31.7.
- boric acid or cellulose or other type of coating to maintain the shape of the pellets.

#### ***Procedure***

Assemble the cylinder and the polished steel base plate of the mould (Fig. 31.7). Insert the filler tube in the aluminium cylinder. Add approximately 2 g of sample or standard in fine powder form with a particle size below  $50 \mu\text{m}$ . Flatten by pressing and rotating the filling piston. Withdraw the piston and filling cylinder so as to leave a vacuum between the compression cylinder and the sample. Cautiously add the coating powder around and above the sample.

Insert the polished steel piston in the cylinder and using the hydraulic press, apply enough pressure to obtain a satisfactory pellet (generally 5–10 ton for 1–2 min).

Replace the moulding base plate with the unmoulding plate (Fig. 31.7) and unmould the pellet with the press. Store the pellet samples and standards in small individual numbered envelopes in a desiccator until analysis.

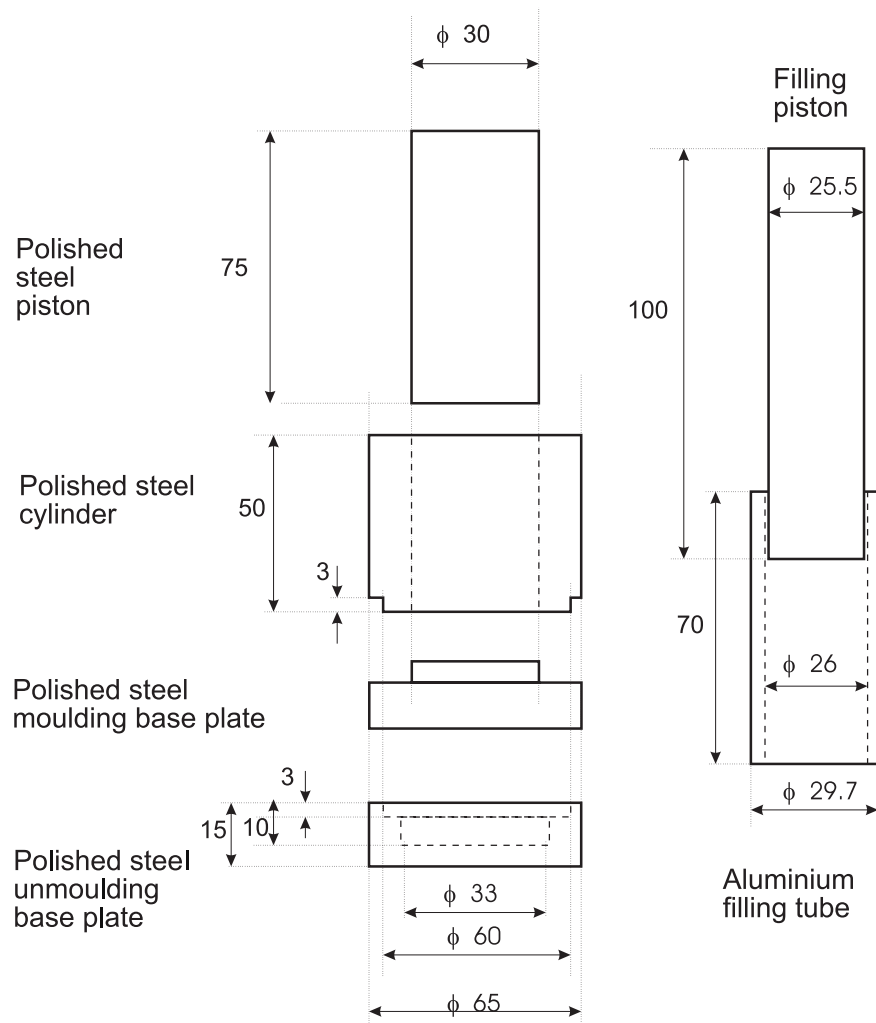

**Fig. 31.7.** Example of pelletising mould for analysis of minor and trace elements by X-ray fluorescence

### Calculations

For the samples and standards, calculate the number of net impulses measured during counting (cf. "Calculations" in "Analysis of major elements" above). Trace the calibration lines of the impulses vs. concentration for each element of the calibration standards and estimate the content of the samples starting from these lines. Matrix corrections

may also be necessary. They should be estimated for each type of sample and element and are less standardized than in "Calculations" in Analysis of major elements.

### 31.3.3 Neutron Activation Analysis

#### *Interest and Limits*

Whereas the main spectroscopic methods use transitions originating from electrons of the external (cf. Sect. 31.2) or internal (cf. Sect. 31.3.2) electronic layers of the atoms, neutron activation analysis (NAA) is concerned with transitions originating from the atomic nucleus. In this case, the results are not affected by variations in the state of the chemical bonds between elements.

NAA is a very sensitive and precise method which enables the determination of more than 70 elements of the periodic table. It was often used as reference for comparison with other techniques to test their precision. Contrary to many spectroscopic methods which require dissolutions (cf. Sect. 31.2), NAA is particularly well suited for the analysis of solid materials like soils and rocks. A possible source of error originating from dissolution is thus eliminated. Liquid materials can also be analysed by NAA, but these analyses are not recommended because of the dangers linked with the expansion of these mediums during irradiation.

The method was first proposed in 1936 only four years after the discovery of neutrons. At the beginning, these analyses used not very selective detectors and chemical separation was thus required; many different procedures were proposed by pioneers like Albert (1964). The primary interest of these separation methods was that they were applied after labelling of the sample by neutron activation. No pollution was introduced by unlabelled reagents as only labelled elements were measured. On the contrary, addition of the unlabelled form of the element to be quantified enabled the separation of the labelled form in a much more effective way than in a traditional chemical separation. This was the technique of isotopic carriers.

Today progress in electronics and detection systems enables quantification of many elements without chemical separation even at trace levels. Instrumental neutron activation (INAA) enables routine analysis of around 30 elements in soils, and this is consequently the only technique described here. But separation is required in a few cases to quantify ultra-traces of elements: the detection limit of the method can be lowered more than 1,000 times when using post-irradiation chemical

separation. So the separation methods with isotopic carriers are still useful for certain geochemical or environmental studies.

One drawback of the method is the aptitude of the elements to form radioactive isotopes with measurable radiation. The main technical difficulty is obtaining access to a nuclear reactor for neutron activation. The number of safety measures to be respected when handling the radioisotopes is also a serious constraint.

### **Principle**

#### *General Description*

Neutron activation analysis initially consists of exposing the material to a flow of radiation able to cause transformation of the atomic nuclei and produce artificial radioisotopes. The study of the radiations emitted by these synthetic radioisotopes then enables identification and quantification of the elements contained in the sample. Artificial radioisotopes of all the elements can be obtained using different types of projectiles: neutrons, protons,  $\alpha$  particles ( ${}^4_2\text{He}^{2+}$ ), deuterons ( ${}^2_1\text{H}^+$ ) or photons  $\gamma$ . However, neutron activation is the most widely used. The most common capture of a neutron by an element E of atomic mass  $m$  and atomic number  $Z$  is written:

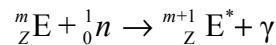

To simplify, specialists often describe this reaction by  ${}^m\text{E}(n, \gamma){}^{m+1}\text{E}$ , e.g., for potassium:  ${}^{41}\text{K}(n, \gamma){}^{42}\text{K}$ .

The radioactive relaxation of activated atoms can take place in five different ways: ejection of an electron ( $\beta^-$ ) from the nucleus, ejection of a positron ( $\beta^+$ ), ejection of 2 protons and 2 neutrons ( ${}^4_2\text{He}$ ,  $\alpha$ ), electron capture and fission. The most common way a decrease occurs in the isotopes produced by neutron activation is  $\beta^-$  emission which tends to compensate for the increase in the neutron/proton ratio of the nuclei by neutron activation. The radioactive decrease is accompanied by emission of  $\gamma$  radiations of different energies resulting from relaxation of the activated nuclear forms according to a specific relaxation scheme for each element. For an activated element E, the reaction is written:

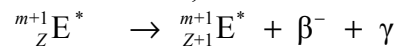

$\gamma$ -ray spectrometry is the most widely used approach in neutron activation because detection of  $\gamma$  radiations is the easiest. Each activated element provides a spectrum of radioactive decrease that is well indexed

in reference works and publications such as Lederer and Shirley (1978), Erdtmann and Soyka (1975a, 1975b), Lis et al. (1975a, 1975b). The choice of a  $\gamma$  line for analysis requires taking into account the half-life of the isotope, the intensity and the energy of the line and possible spectral interferences with other radioisotopes. Compilations like those of Koons and Helmke (1978), Helmke (1982) or Helmke (1996) provide useful information for the main soils.

### **Quantitative Analysis**

After irradiation, the decrease rate of a  ${}^m{}_Z\text{E}^*$  atom is proportional to  $N$  the number of this atom in the sample and  $\lambda$  the kinetic constant of decrease, i.e.  $dN/dt = -\lambda N$ . By integration,  $N_0$  being the number of atoms at time origin  $t_0$ , the decrease law is expressed by:

$$N = N_0 e^{-\lambda t}$$

The kinetic constant is often replaced by the half-life of the radioelement:  $T_{1/2}$  when  $N = N_0/2$  and thus  $T_{1/2} = \frac{\ln 2}{\lambda}$ .

If all the atoms of the element to be titrated were systematically transformed into measured radioisotopes, the decrease law would enable their concentration to be determined immediately using the initial number of atoms  $N_0$ . In practice, the number of radioactive atoms produced by irradiation of an element is proportional to its capture cross section and to the flow of neutrons. NAA is performed by comparison of the radiation counted on the sample and on a standard of calibration. As counting is not performed simultaneously on the sample and the standard, the exact time and date of counting of each one should be carefully recorded. All measurements are then brought back to the same reference time  $t_0$  by means of the above equation before calculation of the concentration.

## **Apparatus and Measurements**

### **Neutron Activation**

Although small neutron generators exist, the best sources of radiation for NAA of geochemical materials are the nuclear reactors used for research. They enable sensitive analysis because they provide big homogeneous flows of thermal neutrons of from  $10^{13}$  to  $10^{15}$  neutrons  $\text{cm}^{-2} \text{s}^{-1}$ .

Samples and standards are encapsulated in containers made of materials with a weak and homogeneous neutron capture section. These containers are transported automatically (usually pneumatically) into the flow of neutrons in the middle of the reactor. The length of irradiation depends on the analysis to be carried out. A duration of several times the half-life of the element to be analyzed may be required to obtain the maximum level of induced activity. Compromise and optimization is required in the case of multi-element titration. In practice, the irradiation times of geological materials vary from a few seconds for short-lived elements to 4–12 h for long-lived elements.

Irradiation is generally carried out by thermal neutrons, as most reactors, (e.g. Osiris, Saclay, France) provide an energy distribution of neutrons in the 0.01 eV zone. Depending on analytical requirements, it is possible to modify the relative activities of the activated elements. Indeed, the cross-sections of the elements vary with the energy of the neutrons. Thus, thermal neutrons can be eliminated from the radiation flux by surrounding the sample with cadmium leaf. In this case, only the epithermal neutrons with energy higher than 0.5 eV take part in activation (the length of irradiation is then generally increased, i.e. up to 25 h). Under these conditions the activity of certain elements like  $^{46}\text{Sc}$ , which produce high background noise, is considerably reduced and as a result, the titration of other elements, like Nd, Zr and Ni, is much more precise (Chayla et al. 1973).

### *$\gamma$ -Ray Spectrometry*

The function of the detector is to convert radiation into an electric signal whose amplitude is proportional to its energy. For  $\gamma$ -ray spectrometry, old scintillation detectors like NaI crystal doped with Tl, were replaced by modern detectors using semiconductors. Among the latter, the Ge(Li) detector (germanium doped with lithium) was used for many years. This detector performed well, but had the disadvantage of being very fragile due to the mobility of lithium at room temperature. The crystal had to be permanently cooled with liquid nitrogen and, in the absence of liquid nitrogen, detection properties could be destroyed in a few minutes. This is why Ge(Li) detectors have now been replaced by the *ultra-pure germanium detector*, also called intrinsic detector. This detector has a very good energy-discriminating capacity. But even though it is not destroyed at ambient temperature, it still needs to be cooled with liquid nitrogen during measurements.

The resolution of a  $\gamma$ -ray spectrometer varies with energetic level of the line concerned which is usually defined in terms of “full width at half the maximum height (FWHM)” of a peak. A resolution of 1.6 or 1.9 keV at 1,330 keV ( $^{60}\text{Co}$ ) is useful to distinguish very close peaks of several



major elements in soils (e.g. Sc and Zn, Br, As and Sb). The yield of a detector increases with its size, especially for high energy  $\gamma$ -rays. The cost also increases with size, so it is often necessary to find a compromise. The detector should be assembled on a cryostat containing about 30 L of liquid nitrogen. It should be set up far from any source of radiation and be protected from cosmic and terrestrial radiations with lead leaf.

Multi-channel analysers are needed to enable discrimination of the pulsation heights and count them in each channel connected to the incidental energy of radiation. They must have a minimum of 2,048 channels but 4,096 channels or more are preferable in INA. Both analog and digital systems are available. The time required for signal acquisition (counting time) varies from a few minutes to one to ten hours depending on the element analysed, the irradiation used and the delay between irradiation and acquisition. The geometry and positioning of the samples and standards on the detector must be perfectly reproducible.

After acquisition, the signal is treated by computer (manual treatment is also possible but time consuming) to locate the peaks and to identify them via the energy channel, to separate badly identified peaks by signal deconvolution, and to measure surfaces while subtracting background noise. Mass and time are then corrected on the samples and standards before the concentrations are calculated.

### **Procedure**

#### **Miscellaneous**

Many alternative procedures can be used depending on the aims of the analysis. The optimum length of irradiation depends on the element concerned (cf. "Neutron Activation"). The same is true of the time lag between irradiation and measurement. Salmon and Cawse (1991) demonstrated the importance of this time lag depending on the elements to be measured. A few minutes after irradiation, medium and long-lived elements are masked by considerable background noise, while very short-lived elements like Al, Mg or V are available. As the radioactivity of the sample decreases, the background noise decreases and other elements are detected and become measurable: Ca at 30 min, Mn and Na at 3 h, Br, La, Sc, K at 3–4 days, Tb, Th, Cr, Eu, Fe, Co after ten days, etc. The procedure described below is used at the Pierre Sue laboratory, Saclay, France, for titration of rare earth and medium and long-lived trace elements in rocks and soils.

### *Equipment and Reagents*

- Standard amples of soil and rocks provided by national or international organizations for quality control and standardization (Pansu et al. 2001)
- aluminium or plastic irradiation shuttles 10 cm length and 2 cm in diameter tightly sealed by crimping the edges
- ultra-pure aluminium paper
- nuclear reactor or neutron source
- automated system of transport between the laboratory and the neutron source with a special hood equipped with remote arm manipulators for the reception of irradiated samples
- glove box with sealed Plexiglas airlock
- 1 cm<sup>3</sup> cylindro-conical plastic container with tight stoppers
- lead bricks for protection
- ultra-pure germanium  $\gamma$ -ray detector (or Ge(Li) detector) with a resolution of less than 2 keV at 1,333 keV and a yield of 15–25%
- complementary cooling equipment containing about 30 L of liquid nitrogen
- lead leaf for radiation protection
- multi-channel analyser using 4,096 energy channels
- micro-computer with suitable software for the acquisition and treatment of signals.

### *Sample Preparation and Irradiation*

It is advisable to use two standards per irradiation shuttle: the first (E) for calculation of concentration by calibration, the second (C) for control of accuracy. Samples and standards must be dried in the same way (in the air or in a drying oven) and finely crushed to a particle-size of less than 100  $\mu$ m. Some crushing materials, such as tungsten carbide, should not be used because of pollution by trace elements. Agate crushers are recommended because of their high purity.

With scissors cut squares of aluminium paper with sides of approximately 3 cm. Fold the squares in half and write the reference of the sample or standard in felt pen. Unfold and accurately weigh approximately (depending on the contents) 100 mg ( $\pm 0.1$  mg) of the sample or standard in the square. Using fine laboratory forceps, carefully crimp the three edges of the square to seal the powder inside.

Pile up samples and standards in the shuttle (10–20) with one E standard at each end and one in the middle, and a C standard in the middle. For irradiation with epithermal neutrons, wrap all the samples in a cadmium leaf. Close the shuttle by crimping.

Send the shuttle into the flow of neutrons ( $2 \times 10^{14} \text{ n cm}^{-2} \text{ s}^{-1}$  at the Osiris reactor in Saclay, France) for the selected irradiation time: about 6 h under total flux for determination of rare earth and some transition elements, 12–25 h with epithermal neutrons.

### *Measurements*

Recover the irradiated shuttle and let it stand behind lead bricks in the recovery hood for ten days. Unseal the shuttle and transfer it in a glove box with a sealed airlock behind two lead bricks.

Using fine laboratory forceps, cautiously open the aluminium paper of each sample or standard and quantitatively transfer the sample powder in a  $1 \text{ cm}^3$  cylindro-conical plastic container marked with the same reference number as the corresponding aluminium paper. This should be carried out close to a moist filter paper to recover volatile radioactive dust.

Carefully stop the plastic containers. Recover the shuttle and used aluminium papers, the wet filter paper and the cleaning paper and put them in a small airtight bag in the radioactive waste bin. Check the radioactivity of the glove box with the Geiger counter and clean again with a wet filter paper if necessary.

Each plastic container to be counted should be successively placed in exactly the same position in the detector (the distance should be adjusted at the beginning as a function of signal amplitude), and the exact time and date of counting recorded. Let count for approximately 50 minutes using the same counting time for each sample or standard (note the time).

Again allow the activity of the samples to decrease behind lead bricks for approximately one month. Count in the same way as previously, but this time for ten hours. This counting is performed 40 days after irradiation and provides more complete and precise results on long-lived elements than the first counting 10 days after irradiation.

### *Calculations*

Locate and identify the element corresponding to each peak depending on the  $\gamma$ -ray energy of the measurement channel. Measure the peak surface by numerical integration of the counting rates “peak minus background noise”. It is necessary to take all peak overlapping into account as this could distort measurements. A range of methods make it possible to

avoid the overlap error: e.g. peak location by the null first derivative (top of peak) or null second derivatives (inflexion points), adjustment using the Gaussian law (or similar) and deconvolution, Fourier transformation. Moreover, the  $\gamma$ -ray spectrum of each element is well known and the possible spectral interferences clearly identified. Each element can be calculated several times using the different peaks of its  $\gamma$ -ray spectrum. The relative intensities between these peaks being known, spectrum libraries can be used to deconvolute the whole signal.

For a given element, if  $S_i$  is the counting rate found for the sample  $i$  of mass  $m_i$ , whose counting was carried out at time  $t_i$ .  $S_e$ ,  $m_e$  and  $t_e$  are the corresponding values for the standard  $e$ , of concentration  $C_e$ . If  $\lambda$  is the kinetic constant for decrease in the activity of the titrated element, the activities have to be corrected by means of the decrease formula (cf. "Quantitative Analysis" in Sect. 31.3.3) and the mass of the sample specimen. This results in  $Sc_i$  the corrected activity of the sample  $i$  and  $Sc_e$  the corrected activity of standard  $e$ . By choosing an arbitrary time  $t_0$  as decrease origin (date and time of the first sample counting for example):

$$Sc_i = \frac{S_i e^{\lambda(t_i - t_0)}}{m_i},$$

$$Sc_e = \frac{S_e e^{\lambda(t_e - t_0)}}{m_e},$$

The  $Sc_e$  is calculated for each repetition of the standard E (cf. "Sample Preparation and Irradiation" in Sect. 31.3.3). The average value or the average after elimination of a doubtful measurement must then be used. The result found for the standard of control C can help to make the choice. Finally, the concentration  $C_i$  of the sample is found by:

$$C_i = \frac{Sc_i}{Sc_e} C_e$$

The same calculation can be carried out for several peaks of the same element. The average value or that which appears to be the most reliable (most intense peak, value of the C standard, etc.) should be retained. The relative titration error is lower than 1%.

## References

- Abbey S (1992) Evaluation and application of reference materials for the analysis of rocks and minerals. *Chem. Geol.*, 95, 123–130

- Abo F (1984) *Influence du bore et du manganèse sur la production et le développement du blé sur sols de régions tempérée et aride.*, Thèse doctorat ès-sciences, Université Paris VII, 89–90
- Albert P (1964) L'analyse par radioactivation. In *Applications des sciences nucléaires*, Lefort M. ed. A de Visscher, Gauthier-Villars, Paris
- Aubert H and Pinta M (1971) Les éléments traces dans les sols. ORSTOM, Paris
- Baize D (1997) *Teneur totale en éléments traces dans les sols.*, INRA, Versailles, France
- Bernas B (1968) A new method for decomposition and comprehensive analysis of silicates by atomic absorption spectrometry. *Anal. Chem.*, 40, 1682–1686
- Boumans PWJM (1981) Conversion of «Tables of Spectral-Line Intensities» for NBS copper arc into tables for inductively coupled argon plasmas. *Spectrochim. Acta.*, 36B, 169–203
- Bourrelier PH and Berthelin J ed. (1998) *Contamination des sols par les éléments en traces: les risques et leur gestion.*, Académie des sciences, France, rapport No42, Lavoisier (Technique et documentation), Paris
- Burman JO (1987) Applications: geological. In *Inductively Coupled Plasma Emission Spectroscopy*, Part 2, Boumans PWJM ed. Wiley, 27–47
- Callot G, Chamayou H, Maertens C and Salsac L (1982) *Mieux comprendre les interactions sol-racine.*, INRA, Paris
- Castaing R (1961) The fundamentals of quantitative electron probe micro-analysis. *Adv. X-Ray Anal.*, 4, 351–369
- Charlot G (1984) *Chimie analytique quantitative, tome II.*, Masson, Paris
- Chayla B, Jaffrezic H and Joron JL (1973) Analyse par activation dans les neutrons épithermiques. Application à la détermination d'éléments en trace dans les roches. *C.R. Acad. Sci. Paris*, 277, D, 273–275
- Claisse G (1968) Etude expérimentale de l'analyse aux trois acides – comportement du quartz pur à l'attaque triacide. *Cah. Orstom sér. Pédol.*, VI, 129–149
- Coppenet M and Juste C (1982) Trace elements essential to the growth of plants and toxicity phenomena. In *Constituents and properties of soils*, Bonneau M and Souchier B ed. Masson, Paris, 458–466
- Cox (1968) Development of a yield response prediction and manganese soil test interpretation for soybeans. *Agron. J.*, 60, 521–524
- Das AK, Chakraborty R, Guardia M de la, Cervera ML and Goswami D (2001) multielement determination in fly ash after microwave-assisted digestion of samples. *Talanta.*, 54, 975–981
- Deb BC (1950) The estimation of free oxides in soils and clays and their removal. *J. Soil Sci.*, 1, 212–220
- Erdtmann G and Soyka W (1975a) The gamma-ray lines of radionuclides, ordered by atomic and mass number, part 1. *J. Radioanal. Chem.*, 26, 375–495
- Erdtmann G and Soyka W (1975b) The gamma-ray lines of radionuclides, ordered by atomic and mass number, part 2. *J. Radioanal. Chem.*, 27, 137–286

- Falkner KK, Klinkhammer GP, Ungerer CA and Christie DM (1995) Inductively coupled plasma mass spectrometry in geochemistry. *Annu. Rev. Earth Planet. Sci.*, 23, 409–449
- FD X31-146, (1996) Détermination de l'indice de pouvoir chlorosant (IPC) selon Juste and Pouget. In *Qualité des sols*, AFNOR, 117–125
- Gambrell RP and Patrick WH (1982) Manganèse. In *Methods of soil analysis, part 2 – chemical and microbiological properties 2nd ed.*, Page AL, Miller RH and Keeney DR ed. ASA-SSSA
- Greenland DJ and Hayes MHB (1983) Soils and soil chemistry. In *The chemistry of soil constituents*, Greenland DJ and Hayes MHB ed. Wiley, 1–27
- Hardy F and Follet-Smith RR (1931) Studies in tropical soils. – II. Some characteristic igneous rocks soil profiles in British Guiana, South America. *J. Agric. Sci.*, 739p
- Helmke PA (1982) Neutron Activation Analysis. In *Methods of soil analysis, part 2 – chemical and microbiological properties*, ASA-SSSA
- He LiYuan and Xiang YaLing (1999) Soil sampling error in agricultural environment. *Chinese J. Appl. Ecol.*, 10, 353–356
- Helmke PA (1996) Neutron Activation Analysis. In *Methods of soil analysis, part 3 – chemical Methods*, Bigham JM and Bartels JM ed. SSSA-ASA, Madison, WI Etats-Unis, SSSA, 141–159
- Hoening M and Kersabiec AM de (1990) *L'atomisation électrothermique en spectrométrie d'absorption atomique.*, Masson, Paris
- Hossner LR (1996) Dissolution for total elemental analysis. In *Methods of Soil Analysis, Part 3, Chemical methods*, Bigham JM and Bartels JM ed. SSSA-ASA, Madison, WI Etats-Unis, 49–64
- Jarvis I (1994a) Sample preparation for ICP-MS. In *Handbook of inductively coupled plasma mass spectrometry*, Jarvis KE, Gray AL and Houk RS ed. Blackie academic & professional, 172–224
- Jarvis I (1994b) Elemental analysis of solutions and applications. In *Handbook of Inductively Coupled Plasma Mass Spectrometry*, Jarvis KE, Gray AL and Houk RS ed. Blackie Academic and Professional, 225–264
- Jeanroy E (1972) Analyse totale des silicates naturels par spectrométrie d'absorption atomique. Application au sol et à ses constituants. *Chim. Anal.*, 54, 159–166
- Jeanroy E (1974) Analyse totale par spectrométrie d'absorption atomique, des roches, sols, minerais, ciments après fusion au métaborate de strontium. *Analisis*, 2, 703–712
- Jones AA (1982) X-ray Fluorescence Spectrometry. In *Methods of Soil Analysis – part 2*, Page AL, Miller RH and Keeney DR ed. ASA-SSSA, 85–121
- Jones AA (1991) X-Ray Fluorescence Analysis. In *Soil analysis – modern instrumental techniques*, 2nd ed. Smith K.A. ed. Dekker
- Karathanasis AD and Hajek BF (1996) Elemental Analysis by X-ray Fluorescence Spectroscopy. In *Methods of soil analysis, part 3*, Bigham JM and Bartels JM ed. SSSA-ASA, Madison, WI Etats-Unis, 161–223

- Kawasaki A and Arai S (1996) Evaluation of digestion methods for multi-elemental analysis of organic wastes by inductively coupled plasma mass spectrometry. *Soil Sci. Plant Nutr.*, 42, 251–260
- Koons RD and Helmke PA (1978) Neutron Activation Analysis of Standard Soils. *Soil Sci. Soc. Am. J.*, 42, 237–240
- Lamothe PJ, Fries TL and Consul JJ (1986) Evaluation of a microwave oven system for the dissolution of geological samples. *Anal. Chem.*, 58, 1881–1886
- Le Cornec F and Corrège T (1997) Determination of uranium to calcium and strontium to calcium ratios in corals by Inductively Coupled Plasma Mass Spectrometry. *J. Anal. Atom. Spectrom.*, 12, 969–973
- Le Cornec F, Riandey C and Richard ML (1994) Minéralisation par micro-ondes de matériaux géologiques (roches et sols) et comparaison avec les méthodes classiques de mise en solution. In *L'échantillonnage, du prélèvement à l'analyse*, Rambaud D ed. Orstom, Paris
- Lederer CM and Shirley VS (1978) *Table of isotopes*, 7th ed. Wiley, New York
- Lim CH and Jackson ML (1982) Dissolution for total elemental analysis. In *Methods of soil analysis, part 2*, Page AL, Miller RH and Keeney DR ed. ASA-SSSA
- Lindsay WL and Norvell WA (1978) Development of a DTPA test for zinc, iron, manganese and copper. *Soil Sci. Soc. Am. J.*, 42, 421–428
- Lis SA, Hopke PK and Fasching JL (1975a) Gamma-ray tables for neutron, fast-neutron and photon activation analysis – 1 – List of all the nuclides with their associated gamma-rays in order of increasing atomic number and mass. *J. Radioanal. Chem.*, 24, 125–247
- Lis SA, Hopke PK and Fasching JL (1975b) Gamma-ray tables for neutron, fast-neutron and photon activation analysis – 2 – list of all the nuclides with their associated gamma-rays in order of increasing atomic number and mass. *J. Radioanal. Chem.*, 25, 303–428
- Martens DC and Lindsay WL (1990) Testing soils for copper, iron, manganese and zinc. In *Soil testing and plant analysis 3rd ed.*, Westerman RL ed. SSSA book series 3, 231–260
- NF ISO 11466 (1995) Eléments en traces solubles dans l'eau régale. In *Qualité des sols*, AFNOR, 283–292
- NF ISO 14870 (X 31-427), 1998) *Extraction des oligo-éléments par une solution tamponnée de DTPA*, AFNOR, à l'étude
- NF X 31-147 (1996) Sols, sédiments – Mise en solution totale par attaque acide. In *Qualité des sols*, AFNOR, 127–138
- NF X 31-151 (1993) Sols, sédiments, boues de stations d'épuration – Mise en solution d'éléments métalliques en traces (Cd, Co, Cr, Cu, Mn, Ni, Pb, Zn) par attaques acides. In *Qualité des sols*, AFNOR, 139–145
- NF X 31-120 (1992) Détermination du cuivre, du manganèse et du zinc – Extraction par l'acétate d'ammonium en présence d'EDTA. In *Qualité des sols*, AFNOR, 75–81
- NF X 31-121 (1993) Détermination du cuivre, du manganèse, du zinc et du fer – Extraction en présence de DTPA. In *Qualité des sols*, AFNOR, 83–89

- NF X 31-122 (1993) Extraction du bore soluble à l'eau bouillante. In *Qualité des sols.*, AFNOR, 91–95
- Njopwouo D and Orliac M (1979) Note sur le comportement de certains minéraux à l'attaque triacide. *Cah. Orstom sér. Pédol.*, XVII, 283–328
- Norrish K and Chappell BW (1977) X-ray fluorescence spectrometry. In *Physical methods in determinative mineralogy*, 2nd ed. Zussman J ed. Academic Press Inc., 201–272
- Norrish K and Hutton JT (1969) An accurate X-ray spectrographic method for the analysis of a wide range of geological samples. *Geochim. Cosmochim. Acta.*, 33, 431–453
- Pansu M, Gautheyrou J and Loyer JY (2001) *Soil analysis – sampling, instrumentation and quality control*, 489 p, Balkema, Lisse, Abington, Exton, Tokyo
- Paycheng C (1980) *Méthodes d'analyse utilisées au laboratoire commun de Dakar.*, Document Orstom – Dakar – Paris, 103 p
- Peck TR and Soltanpour PN (1990) The principles of soil testing. In *Soil testing and plant analysis 3<sup>rd</sup> ed.*, Westerman RL ed. SSSA book series 3, 3–9
- Pétard J (1993) *Les méthodes d'analyse. Tome 1: analyses de sols.*, Notes techniques No. 5, Orstom, Nouméa, Paris
- Pinta M (1962) *Recherche et dosage des éléments traces.*, Dunod, Paris, 726 p
- Pr ISO CD 14869 (1998) *Soil quality – determination of total trace elements content – part 1: digestion with hydrofluoric and perchloric acids for the determination of total contents – part 2: solubilisation by alkaline fusion.*, AFNOR, Paris
- Ramsey MH and Coles BJ (1992) Strategies of multielement calibration for maximising the accuracy of geochemical analysis by inductively coupled plasma-atomic emission spectrometry. *Chemi. Geol.*, 95, 99–112
- Riandey C, Alphonse P, Gavinelli R and Pinta M (1982) Détermination des éléments majeurs des sols et des roches par spectrométrie d'émission de plasma et spectrométrie d'absorption atomique. *Analisis*, 10, 323–332
- Risser JA and Baker DE (1990) Testing soils for toxic metals. In *Soil testing and plant analysis 3<sup>rd</sup> ed.*, Westerman RL ed. SSSA book series 3, 275–298
- Shinotsuka K and Ebihara M (1997) Precise determination of rare earth elements, thorium and uranium in chondritic meteorites by inductively coupled plasma mass spectrometry – a comparative study with radiochemical neutron activation analysis. *Anal. Chim. Acta.*, 338, 237–246
- Smith KA ed. (1991) *Soil analysis – modern instrumental techniques*, 2nd ed. Dekker
- Soltanpour PN, Johnson GW, Workman SM, Jones JB and Miller RO (1996) Inductively coupled plasma emission spectrometry and inductively coupled plasma mass spectrometry. In *Methods of soil analysis, part 3, chemical methods*, Bigham JM and Bartels JM ed. SSSA-ASA, Madison, WI Etats-Unis, 91–139
- Tan KH (1996) *Soil sampling, preparation and analysis*, Dekker



- Totland M, Jarvis I and Jarvis K (1992) An assessment of dissolution techniques for the analysis of geological samples by plasma spectrometry. *In Plasma spectrometry in the earth sciences*, Jarvis I and Jarvis K ed. *Chemical geology*, special issue, 35–62
- Trolard F, Bourrié G, Jaffrezic A (2002) Distribution spatiale et mobilité des ETM dans les sols en région d'élevage intensif en Bretagne. In: *Les éléments traces métalliques dans les sols – approches fonctionnelles et spatiales*, (coord. M. Tercé & D. Baize), pp. 183–199. INRA, Collection un point sur..., Paris
- Turekian KK and Wedepohl KH (1961) Distribution of the elements in some major units of the earth's crust. *Geol. Soc. Am. Bull.*, 72, 175–191
- US Environmental Protection Agency, (1986) Acid digestion of sediment, sludge and soils. *In Test methods for evaluating solid waste*, SW-846. USEPA, Cincinnati
- Vernet M and Govindaraju K (1992) *Mise en solution des matériaux avant analyse.*, Techniques de l'ingénieur, P 222, 1–16
- Voïnovitch IA (1988) *Analyses des sols, roches et ciments – méthodes choisies.*, Masson, Paris
- Walsh JN (1992) Use of multiple internal standards for high-precision, routine analysis of geological samples by inductively coupled plasma-atomic emission spectrometry. *Chem. Geol.*, 95, 113–121
- Winge RK, Fassel VA, Peterson VJ, Floyd MA (1982) ICP emission spectrometry: on the selection of analytical lines, line coincidence tables, and wavelength tables. *Appl. Spectrosc.*, 36, 210–221
- Wright RJ and Stuczynski T (1996) Atomic absorption and flame emission spectrometry. In *Methods of soil analysis, part 3, chemical methods*, Bigham JM and Bartels JM ed. SSSA-ASA, Madison, WI Etats-Unis, 65–90
- Zischa M and Knapp G (1997) Microwave-assisted sample decomposition progress and challenges. *Analysis Europa*, Novembre, 18–23

## Index

---

- ( $\alpha$  amino acid)-N analysis, 508  
( $\text{NH}_3$ +amino sugars)-N analysis, 508  
( $\text{NH}_4^+$ )-N analysis, 508, 767, 773, 782  
 $\gamma$ -ray spectrometry, 962, 963  
(serine + threonine)-N analysis, 509  
 $^{13}\text{C}$ , 290, 325, 326, 329, 363, 401, 432, 447, 448, 526, 530, 546  
 $^{13}\text{C}$ -NMR, 427, 432, 433  
 $^{14}\text{C}$ , 290, 314, 325, 329, 363, 367, 370, 526, 530, 540  
 $^{15}\text{N}$ , 329, 363, 365, 369, 500, 502, 526, 530, 540  
 $^1\text{H}$ -NMR, 427  
2,4 D, 484  
 $^{31}\text{P}$ -NMR, 815  
 $^{32}\text{P}$  isotopic dilution, 805, 813
- AAS, 83, 185, 683, 704, 721, 726, 733, 743, 763, 900, 902, 926, 935-941, 945  
acetone precipitation, 882  
acid attack in closed vessel, 911  
acid attack in open vessel, 906  
acid digestions in open vessel, 902  
acid dissociation, 554  
acid herbicides, 457, 485, 488, 491  
acid hydrolysis of polysaccharides, 458  
acid hydrolysis, 372, 500  
acid reagents, 168, 806, 921  
acid sulphated soils, 337, 552, 553, 835, 836, 857, 876, 877, 889  
acidity constant, 555  
acidity, 212, 390, 401, 408, 409, 410, 411, 417, 418, 553, 557, 561, 567, 629, 667, 677-684, 685, 687, 688, 689, 691, 692, 693, 712, 713, 718, 719, 722, 723, 738, 741, 743, 745, 748, 761, 763, 822, 874, 899
- actinomycete, 289, 343  
active carbonate titration, 601  
active carbonates, 595, 602-604  
adsorbing complex, 629  
adsorption water, 3  
AEC, 327, 648, 714, 755, 756, 757, 759, 760, 761, 763, 819  
aggregates, 17, 32, 39, 54, 91, 94, 106, 128, 198, 200, 282, 291-323, 326, 373, 521, 554, 647, 660, 803  
akaganeite, 110, 175  
akdalaite, 71  
 $\text{Al}^{3+}$  toxicity, 168  
aldrin, 484  
algae, 289, 593  
alkaline fusion, 915  
alkaline hydrolysis, 420  
alkalinity, 553, 616, 617, 622, 822, 922  
allophane, 123, 125, 176, 179, 203, 215, 632, 710, 746  
aluminic toxicity, 553, 687, 691, 874  
aluminium phytotoxicity, 679  
aluminium, 111, 202, 216, 217, 239, 638, 639, 682, 684, 685, 928  
aluminosilicates, 104, 113, 115, 167, 170, 187, 200, 201, 206, 210, 646, 659, 683, 706, 749  
alunite, 839  
amid forms of proteins, 501  
amino acids, 371, 376, 399, 455, 501, 505, 510, 532-536, 537, 538, 541, 866, 884, 903  
amino sugars, 466, 501, 533, 537, 538, 542

- amino-sugars by gas  
  chromatography, 537
- ammonium acetate (pH 7.0), 732
- ammonium, 767, 769, 772, 773-775,  
  778, 782-791, 792, 807, 811,  
  812, 813, 825, 832, 833, 847,  
  849, 850, 920-927, 971
- analysis after solubilization, 900
- analysis of trace elements, 935, 939
- analysis on solid medium, 950
- anatase, 176
- andesine, 71
- andosol, 20, 29, 33, 186, 210, 215,  
  223, 315, 328, 331, 359, 374,  
  655, 656, 710, 717, 722, 744,  
  755, 756, 764, 765, 819, 858,  
  886
- anhydrite, 838
- anion exchange capacity, 755, 757,  
  819
- anions by ionic chromatography,  
  624
- ankerite, 593
- Anne method, 335, 340, 364
- anticathode, 87, 89
- antigorite, 84
- antimony electrode, 562
- arachnids, 289
- aragonite, 10, 71, 234, 356, 593
- arcanite, 606
- artificial radioisotopes, 961
- atomic absorption analysis, 858
- atomic absorption spectrometry,  
  hydride and cold vapour, 927
- atomic absorption, 190, 195, 199,  
  603, 672, 680, 682, 720, 722,  
  723, 725, 726, 741, 821, 867,  
  881, 882, 883, 887, 900, 903,  
  904, 912, 913, 915, 918, 919,  
  926, 931, 933, 934, 937, 940,  
  951, 954, 969, 970, 972
- atomic plan, 85
- atomic spectrometry, 615, 622, 925
- atrazine, 484, 491
- attack using three concentrated  
  acids, 921
- attenuated total reflectance, 146
- attenuated total reflection, 140
- Atterberg's limits, 6
- Auger electrons, 271, 280, 283
- automated extraction, 670
- availability index, 804
- azovskite, 177
- back-scattered electrons, 273, 280
- bacteria, 289, 343, 375, 767, 768,  
  835, 866, 874
- basaluminite, 839
- bassanite, 838
- bauxite, 71
- bayerite, 111
- beidellite, 71, 84, 101, 657
- Bernard calcimeter, 598
- bicarbonate extractable P, 809
- bioavailability of P, 814
- biochemical processes function of  
  Eh, 582
- biogenic and toxic elements, 899
- biogenic carbonates, 593
- biogenic silica, 177
- biological methods, 513, 522, 544
- biological P, 809
- biotite, 71, 84, 123
- birnessite, 176
- bloedite, 838
- boehmite, 70, 102, 111, 120, 123, 176
- bound lipids, 473
- Bouyoucos, 22, 42, 56, 573
- Bronsted acid-base concept, 556
- brookite, 176
- brown humic acids, 373, 401, 402,  
  404, 405
- tanning mechanisms, 399
- buffered methods at different pH,  
  743

- buffering effect, 373, 555, 660, 678  
buffering power, 553, 555, 559, 566,  
577, 578, 688, 690, 709
- C, N (H, O, S), 327  
C:N ratio, 290, 329  
cadavers, 289  
calcareous nodules, 17  
chalcedony, 177  
calcimeter determination, 596  
calcination at low temperature, 355  
calcite, 71, 103, 123, 356  
calibration in thermal analysis, 239  
calibration range, 621, 623, 774,  
849, 928, 929, 930, 931, 939  
calomel electrode, 563  
capillary water, 3  
carbamates, 457, 487, 490, 491, 492  
carbofuran, 484, 496  
carbonate analysis, 689  
carbonates, 593, 616  
Casagrande relation, 42  
cation exchange capacity, 125, 373,  
566, 567, 658, 679, 709, 711,  
747, 748  
cation saturation, 99  
CEC and AEC determination, 762  
CEC at soil pH, 711, 719, 725, 744  
CEC function of pretreatments, 745  
CEC in buffered medium, 730  
CEC, 32, 85, 125, 190, 215, 327,  
631, 648, 655, 657, 658, 660,  
661, 664, 667, 668, 669, 673,  
674, 679, 680, 687, 688, 698,  
705, 710-753, 755, 756, 757,  
759, 760, 761, 762, 763, 819,  
885, 922  
celadonite, 108  
cell constant, 612, 613  
cellular autolysis, 399  
chain hydrometer, 46  
chalcopyrite, 839  
characterization by fragmentation,  
419  
charge distribution, 31, 85, 631,  
649, 873  
chelation, 373, 630, 806  
chemical dispersion, 297  
chemical methods, 112, 168, 172,  
522, 545, 900  
chemical polymerisation, 399  
chemisorption, 3, 31, 636, 756, 803,  
806  
chloride by colorimetry, 619  
chlorite, 84, 102, 103, 116, 125  
chlorites, 28, 96, 99, 101, 116, 127,  
206, 243  
chloromagnesite, 606  
CHN(OS), 329-363, 853  
chromatogram of alditol acetates,  
471  
chromatographic methods, 419, 456,  
535  
chrysotile, 84  
clarification of extracts, 821  
clay classification, 632  
clay minerals, 84, 94, 99, 113, 114,  
117, 124, 128, 147, 223, 227,  
243, 373, 556, 707, 727, 730,  
748  
clay transformations, 224  
clay-organic compartment, 291, 456  
clinochlore, 84  
clintonite, 84  
coarse particles, 15  
coarse sands, 16, 34, 39, 41, 296,  
310, 311  
coarse silts, 16, 39, 51, 310  
coating and impregnation, 255  
coesite, 71  
cohesion, 17, 32, 65, 92, 255, 297,  
303  
cold water soluble, 474  
colligative properties, 440  
colloidal particles, 75, 197, 312

- colloidal systems, 65, 81  
colloids, 32, 41, 59, 289, 401, 566, 630, 645, 652, 659, 660, 688, 697, 715, 719, 725, 758, 807, 899  
colorimetric determination of ammonium, 773  
colorimetric determination of nitrate, 778  
colorimetric determination of nitrite, 775  
colorimetric methods, 456, 558, 464, 511, 533, 621  
colorimetric titration of Si, 928  
colorimetry of deoxyhexose sugars, 465  
colorimetry of hexose sugars, 465  
colorimetry of pentose sugars, 465  
colorimetry of total sugars, 464  
colorimetry with azomethine-H, 621  
colorimetry with methyl thymol blue, 851  
colorimetry with methylene blue, 846, 860, 863  
colorimetry with ninhydrin, 533  
column percolation, 669, 670  
compactness, 15  
comparison of measurements, 517  
complex with outer sphere, 701  
complex with inner sphere, 646, 701  
complex calibration range for trace elements, 943  
complex calibration range, 941, 943, 944  
complexing reagents, 307, 920  
conductance, 612, 613, 857  
conductivity *in situ*, 613  
conductivity meter, 611  
constitution water, 4, 30, 178, 895  
continuous extraction, 673  
cookeite, 84  
coquinbite, 839  
corundum, 71, 123  
coulometry, 618  
CPMAS-<sup>13</sup>C NMR, 431  
cristobalite, 71, 102  
cryptocrystalline substances, 167  
crystalline mesh, 85  
cyanazine, 484  
dating, 222, 290  
DDD, 484  
DDE, 484, 489  
DDT, 457, 484, 489  
dehydration, 8, 10, 99, 174, 223, 227, 235, 256, 282, 284, 562, 738, 879  
dehydroxylation, 8, 10  
deltamethrin, 484  
densimetric method, 42  
density separation, 293  
deoxyhexoses, 456, 457, 467, 468  
derivatives for GPC, 470  
detection limits, 119, 828, 856, 936, 949, 961  
deuteration, 146, 150  
dextran gel, 403, 406, 443  
diaspore, 71, 111, 176  
diatoms, 55, 67, 85, 116, 201  
dickite, 71, 108, 123  
dieltrin, 457, 484, 489  
differential conductivity, 55  
differential enthalpy analysis, 221  
differential scanning calorimetry, 222, 235, 236  
differential sequential methods, 206  
differential thermal analysis, 221  
differential thermogravimetry, 221  
diffraction spectra, 72  
diffractograms, 113, 114  
diffuse reflectance, 138, 140, 156, 362  
diffusion of electromagnetic radiations, 439  
digestion in closed vessel, 911

- dilatometry, 222  
diluted extracts, 607, 609, 882  
dioctahedral minerals, 114, 148, 149  
dioctahedral silicates, 103  
dioctahedral vermiculite, 84  
dioxins, 457  
direct P speciation, 830  
discontinuous acid hydrolysis, 531  
dispersing reagent, 18, 28, 31-37,  
45, 46, 53, 55, 66, 67, 75, 202  
dispersion in water, 297  
dispersion, 17, 18, 19, 20, 22, 23,  
29-36, 44, 46, 51, 54, 57, 58, 59,  
60, 61, 69, 70, 75, 82, 89, 100,  
111, 117, 136, 140, 153, 191,  
201, 214, 281, 282, 283,  
297-309, 313-326, 376, 385,  
589, 630, 652, 716, 731, 738,  
886, 953, 954  
dissociation constant, 433, 555,  
710  
dissolved solid matters, 614, 625  
distillable fraction, 509  
dithionite-citrate-bicarbonate  
method, 187  
diuron, 484  
dolomite, 593, 599, 600  
donbassite, 84  
Donnan's equilibrium, 634, 709  
DSC, 8, 83, 221-223, 227, 236, 237,  
238, 239, 242, 245, 246, 250  
DTA, 8, 9, 80, 83, 108, 110, 124,  
140, 158, 190, 213, 221-248,  
361, 362, 421  
DTG, 221, 222, 230, 233, 234, 248,  
421  
dynamic mechanical analysis, 222  
dynamics of extraction, 673  
  
E4:E6 ratio, 410-412, 437  
EAAS, 919, 924, 939, 951  
earth's gravity, 19, 21  
EC, 236, 609, 611, 612, 625, 720,  
760, 763  
ECEC, 212, 671, 681, 682, 712,  
718, 719, 727  
EDTA method, 192  
EDX probes, 83  
EDX, 55, 76, 124, 168, 169, 253,  
258, 261, 264, 265, 270, 273,  
282-284, 596, 800, 830, 836,  
866  
EELS, 273, 279  
effect of attenuation of mass, 121  
effective CEC by summation, 718,  
763  
EGA, 83, 140, 158, 222, 232, 240,  
251, 361, 596, 855  
EGD, 83, 158, 221, 247  
Eh colorimetric determination, 589  
Eh, 573, 574, 581-591, 615, 627,  
630  
elastic scattering, 273  
electrical conductivity, 610  
electro spin resonance, 411, 435,  
436  
electrofocusing, 415  
electromagnetic lens, 275  
electrometric measurement, 564  
electrometric method, 560, 574  
electron energy loss spectrometry,  
279  
electron gun, 274, 280, 281  
electron microdiffraction, 83, 210  
electron microprobe, 258, 280, 901,  
952  
electronic microscopy, 55, 74, 76,  
78, 83, 117, 261-264, 267,  
269-285, 441, 799  
electrophoresis, 402, 415  
electrothermal atomic absorption  
spectrometry, 927, 939  
electrothermal AAS, 939, 941, 945  
electro-ultrafiltration, 500, 538, 539  
elemental sulphur titration, 868

- elements quantified by hydrid  
method, 937
- elutriation, 52, 293, 294, 295, 312,  
322
- elutriator, 290
- emanating radioactive gas analysis,  
221, 249
- emission lines of alkaline elements,  
931
- ENDOR, 170
- energies of vibration, 133
- environmental scanning electron  
microscopy, 281
- environmental SEM, 271, 281
- EPR, 80, 168, 170, 186, 190, 435
- epsomite, 838
- ESEM, 271, 281, 286
- ESR, 435, 436, 437, 446
- ETA, 221
- ethylene glycol treatment, 105
- evansite, 176
- evolved gas analysis, 221
- evolved gas detection, 221
- EXAFS, 83, 160, 168, 170, 186, 190
- exchange acidity determination, 677
- exchange acidity, 553, 567, 629,  
667, 677-679, 682-685, 712,  
718, 719, 723, 743, 763
- exchange isotherm, 629, 697, 729
- exchange selectivity, 697-707
- exchangeable acidity, 680, 681, 682,  
683, 684, 688, 748
- exchangeable Al, 679, 682, 683, 688
- exchangeable aluminium, 681, 682,  
683, 684, 920
- exchangeable bases, 549, 571,  
667-675, 684, 748, 749
- exchangeable cations analysis, 667,  
721, 753, 763
- exchangeable cations, 10, 99, 149,  
234, 638, 651, 660, 667-675,  
677, 679, 680, 683, 689, 697,  
705, 709, 711, 712, 713, 717,  
718, 719, 720, 721, 722, 723,  
725, 726, 727, 731, 732, 734,  
739, 760, 763, 901, 920, 921
- exchangeable complex, 631
- exchangeable sodium ratio, 700
- extractable boron, 620
- extractable carbonates and  
bicarbonates, 616
- extractable cations, 615
- extractable chloride, 618
- extractable elements, 901
- extractable P by ammonium oxalate  
method, 811
- extractable P by anionic resin, 810
- extractable P by double acid  
method, 811
- extractable P by HCl + NH<sub>4</sub>F  
method, 812
- extracted phases by selective  
dissolutions, 179
- extraction by chemical way, 886
- extraction of plant-roots, 293
- extraction solutions, 921
- extraction with Soxhlet apparatus,  
472
- faecal pellets, 289
- fall height, 39, 42, 43
- far infrared, 172
- fatty acids, 420, 456, 478, 479-483,  
488, 495
- feitknechtite, 71
- feldspath, 71, 103
- FeOOH, 110, 176, 177, 218, 764
- feroxyhite, 177, 179
- ferrihydrite, 110, 177, 178, 179
- ferruginous concretions, 17
- fertility, 65, 168, 474, 510, 526,  
541, 553, 629, 667, 705, 707,  
711, 800, 804, 884
- field capacity, 4, 607
- filter percolation, 670

- fine earth, 6, 7, 15, 27, 570, 652, 672  
fine fractions, 59, 66, 74, 75, 81, 305  
fine gravels, 16  
fine sands, 16, 38, 39, 41, 46, 310, 311  
fine silts, 16, 85, 116, 308, 310, 594  
fixed or occluded N, 354  
flam atomic absorption spectrometry, 906, 927, 932, 935, 936, 939, 941  
flam emission spectrometry, 902, 919, 926, 927, 930, 951  
flash-carbon, 264, 265, 269  
flocculation, 18, 31, 32, 33, 36, 40, 54, 78, 96, 174, 184, 190, 319, 373, 379, 393, 567, 630  
flocculating power, 31  
fluorescence spectroscopy, 433  
forms of soil water, 223  
Fourier transform, 136, 426, 427, 428  
fractionation by solvents, 478  
fractionation of fatty acid methyl esters, 482  
fractionation of humin residue, 392  
fragments of fibres, 289  
free acidity, 678  
free fatty acids, 456, 478  
free iron oxides, 924  
free lipids, 473  
free organic matters, 9, 10, 310, 313, 314, 315, 322  
free sugars, 454, 456, 475  
freeze dryer, 257, 391, 867  
FTIR, 138, 168  
FTIR, 83  
fulvic acid fractionation, 407  
fulvic acids, 198, 343, 372-446, 455  
fundamental units of clays, 633  
fungi, 289, 885  
gamma-rays, 87  
Gapon coefficient, 700  
gas phase, 3, 247, 357, 362, 419, 421, 467, 468, 478, 480, 481, 482, 485, 488, 490, 496, 531, 535, 582  
gas-liquid chromatography, 479, 534  
gastropod, 289  
Ge(Li) detector, 964  
gel exclusion chromatography, 416  
gel permeation, 407  
gels, 80, 146, 162, 167, 168, 170, 174, 179, 180, 182, 205, 211, 213, 215, 216, 243, 253, 328, 389, 406, 407, 415, 416, 417, 439, 445, 678, 717, 746, 830  
geochemical distribution of nitrogen, 497  
gibbsite, 69, 71, 102, 111, 123, 176  
glass electrode, 561, 562, 564, 616, 784  
glauconite, 71  
glomalin, 538, 539, 542  
glycerides, 478  
glycerol treatment, 105  
glycolipids, 478  
goethite, 102  
goniometer, 88, 89, 92, 114, 141  
groutite, 71  
gravels, 15, 294, 296, 331, 573, 594  
greigite, 839, 866  
grey humic acids, 379, 401, 402, 404, 405  
grid of transmission electron microscopy, 262  
gypseous soils, 57, 738, 835, 836, 837, 878  
gypsum requirement, 884  
gypsum, 71, 102, 123, 332, 838, 880



- half-life of radioelement, 962  
halite, 606  
halloysite, 71, 84, 102, 103, 127,  
152, 225, 262, 745  
Hauser and Lynn method, 69  
hausmanite, 71, 177  
heavy metal transport, 168  
heavy mineral liquor, 313  
hectorite, 69, 71, 84, 103, 123, 178,  
251  
hemihydrate, 838  
Hettich cyto chamber, 141  
hexahydrite, 838  
hexametaphosphate, 19, 25, 28, 31,  
32, 33, 34, 39, 45, 48, 295, 307,  
308, 608, 610, 617  
hexosamins, 454, 475, 501-503,  
509  
hexose sugars, 454, 455, 458,  
464-466, 495  
hisingerite, 176  
histosols, 3, 7, 29, 33, 74, 186, 223,  
726, 797, 835, 858  
homoionic form, 80  
homoionic saturation, 228, 232, 241  
hot water extracts, 610  
hot water soluble, 474  
humic acid fractionation, 402, 403,  
406  
humic acids, 200, 202, 307, 309,  
334, 343, 372-450, 455, 806,  
860, 862  
humic compounds, 197, 311, 343,  
371-445, 472  
humified matters, 371, 375, 376  
humin residue, 375, 379, 385, 388,  
392-395, 431  
humin, 343, 372, 400, 804, 806  
humus typology, 329  
humus, 298, 325, 329, 333, 334,  
371-373, 376, 397, 399, 402,  
406, 445, 453, 456, 493, 660,  
756, 757, 806  
huntite, 593  
hydride and cold vapour AAS, 935  
hydrocarbons, 456, 457, 478, 479,  
495  
hydrofluoric acid attack, 532, 533  
hydrogen determination, 360  
hydrogen sulphide, 839  
hydrophilite, 606  
hydroxy-aluminium polymers, 687  
hygrometric water, 3  
hygroscopic water, 4, 244  
hymatomelanic acids, 373  
ICP, 83, 124, 185, 189, 209, 671,  
682, 702, 704, 729, 733, 743,  
763, 821, 823, 828, 900-909,  
914, 916, 919, 920, 924, 925,  
926, 935, 940-950, 969, 972  
ICP-AES, 900, 902, 909, 916, 919,  
925, 926, 935, 940-944, 946  
ICP-MS, 83, 900, 902, 903, 904,  
905, 906, 907, 909, 914, 920,  
924, 926, 941, 945-950  
IEP, 645  
ikaite, 593  
illite, 71, 123, 657  
ilmenite, 71  
imogolite, 108, 162, 176, 179, 180,  
203, 632, 750  
in situ measurement, 570, 586, 587,  
788  
in situ sampling of soil water, 610  
INA, 961, 964  
INAA, 961  
index of chlorosis, 603  
indicators in the 2.8 to 11 pH range,  
558  
induction furnace, 917  
inductively coupled plasma  
emission spectrometry, 913, 927  
inductively coupled plasma mass  
spectrometry, 927

- indurated soils, 4, 8, 17, 337, 567, 605, 606, 610, 615, 618, 620, 621, 622, 627, 628, 668, 672, 700, 731, 739, 898, 929
- inelastic scattering, 273
- infrared microscopy, 158
- infrared spectra of gypseous materials, 881
- infrared spectrography, 413
- infrared spectrometry, 133, 134
- inorganic carbon, 333, 334
- inorganic oxygen, 360
- insects, 289
- installation of sensors, 572
- instrumental conditions of titration, by flame AAS, 932
- Instrumental Neutron Activation Analysis, 961
- instrumental neutron activation, 961
- intercalation complex, 80, 106, 115
- inter-laboratory calibration, 385
- interlayer space, 80, 99, 117, 227
- interlayer water, 99, 111, 189, 243, 658
- inter-reticular distance of minerals, 102
- ion exchange extracting reagents, 920
- ion exchange resins, 32, 920
- ion selective electrode, 786
- ionic balance, 571, 625-626
- ionic chromatography, 475, 615, 616, 622, 843, 856, 857, 876
- ionic probe, 254
- ionometry, 352, 570, 578, 615, 787
- IR absorption bands in phyllosilicates, 149, 151
- IR microscope, 139
- IR spectrometry, 139, 160
- IR, 32, 33, 117, 133, 134-161, 164, 172, 210, 214, 223, 252, 267, 271, 273, 309, 360, 391, 414, 415, 419, 442, 446, 799, 824
- iron deficiency, 168
- iron removal, 104
- isoelectric point, 31, 32, 415, 630, 648, 649
- isoelectric point, 640, 645
- isotopes often used, 948
- isotopic studies, 290, 530
- jarosite analysis, 873
- jarosite, 838, 874, 875
- Johnson and Nishita apparatus, 845, 861
- jurbanite, 839
- kaolinite, 54, 71, 84, 102, 116, 123, 125, 225, 632, 657
- KBr pellet, 154
- Kerr's equation, 699
- kieserite, 838
- Kjeldahl method, 344, 353, 367, 545
- Kjeldahl, 332, 343-348, 351-354, 363, 365, 366, 367, 369, 502, 504, 507, 510, 511, 525
- kliachite, 177
- labelled elements, 21, 329, 961
- langbeinite, 838
- lansfordite, 593
- Laser particle size analyser, 53
- law of mass action, 555, 709
- law of Stokes, 24, 34, 66, 67, 96, 318
- lepidocrocite, 71, 110, 175
- leucoxene, 176
- lime requirement, 553, 629, 687, 689-694
- lime water methods, 689
- liming effect, 687
- limonite, 177
- lindane, 457, 484
- linuron, 484
- lipid classes, 478, 479

- lipids, 333, 371, 453, 456, 457, 472-474, 477-483, 484, 488, 490, 495, 862
- liquid chromatography, 138, 402, 467, 475, 484, 485, 491, 533, 538, 830, 856
- liquid phase chromatography, 478, 479
- liquid phase, 3, 23, 52, 105, 168, 169, 173, 582, 588, 630, 633, 634, 651, 663, 669, 671, 674, 683, 697, 698, 716, 761, 814
- lithiophorite, 177
- lizardite, 84
- loeweite, 838
- lyotropic series, 701, 758, 807, 819
- lytic mechanisms, 399
- mackinawite, 839
- macro-aggregate fractionation, 297
- macrofauna, 289
- maghemite, 110
- magnesite, 593
- magnetite, 103, 110
- Maillard's reaction, 399
- major elements by X-ray fluorescence, 956
- major elements, 895, 919, 932
- manganite, 71, 176
- manganosite, 71
- marcassite, 839
- margarite, 84
- mass spectrometers, 249, 362, 363
- maximal water holding capacity, 528
- mean elemental composition, 896
- measurement at soil pH, 711
- measurement of molecular size, 439
- measurement on buffered medium, 712
- measurement on soil monolith, 573
- measurement on soil suspensions, 565
- medium infrared, 134, 363
- metahalloysite, 102, 103
- metallization, 264, 265, 267, 441
- method precision, 320
- methods using solubilization, 901
- methylparathion, 484
- mica (illite), 102, 103
- mica weathering, 631, 727
- micas, 71, 84, 108, 225, 632
- Michelson's interferometer, 137
- micro-aggregate fragmentation, 302, 305
- microbial respiration, 530
- microbial synthesis, 400
- microbiological techniques, 885
- microdiffraction, 272, 275, 276
- microscopic analysis, 253
- microscopic observations, 441
- microwave mineralization, 914, 970
- mineralizable nitrogen (and carbon), 497
- mineralization kinetics, 526, 546
- mineralization potential de, 513, 517, 521, 523
- mineralization rack, 340
- mineralization, 83, 325, 327, 328, 330-340, 343, 347, 348, 349, 350, 351, 352, 353, 354, 366, 373, 498, 499, 500, 510, 511, 513, 514, 519, 521, 526-530, 540, 544, 687, 794-797, 801, 803, 814, 817-819, 846, 858-860, 885, 905, 915
- mineralogical analysis, 79
- mineralogical extraction, 169
- mineralogical separations, 167
- minor and trace elements by X-ray fluorescence, 958, 959
- mirabilite, 838
- MnO<sub>2</sub>, 29, 71, 358, 934

- model with three layers and four plans, 635  
moisture adjustment, 520  
moisture storage, 65  
moisture, 3-8, 11, 12, 15, 29, 40, 41, 95, 99, 108, 115, 138, 184, 191, 227, 228, 231, 234, 241, 259, 281, 328, 331, 359, 519, 528, 529, 552, 554, 570, 571, 572, 573, 600, 602, 607, 608, 610, 651, 660, 680, 683, 717, 719, 720, 734, 740, 742, 743, 744, 745, 760, 782, 801, 802, 841, 861, 863, 865, 872, 880, 884, 885, 935  
molecular weight determination, 437-440  
montmorillonite, 71, 84, 101, 102, 103, 123, 125, 639, 657  
morphoscopic analysis, 17  
Mössbauer spectroscopy, 442  
Mössbauer, 80, 83, 168, 172, 217  
mould for pelletizing, 959  
multichannel analyzers, 964  
multi-element analysis of rare earth elements, 945  
multi-element calibration solution, 942, 944  
multiple specular reflection, 138, 140  
muscovite, 71, 84, 123, 225  
myriapodes, 289
- Na<sub>3</sub>-EDTA extractable sulphates, 871  
nacrite, 108  
natroalunite, 839  
natrojarosite, 838  
natron, 593  
near infrared, 134, 156  
nematodes, 289
- net charge of surface, 645, 648, 649, 650  
neutral lipids, 478  
neutron activation analysis, 960  
neutron activation, 900, 901, 951, 952, 954, 960, 961, 962  
neutron generators, 963  
NIRS, 156, 157, 362, 363  
nitrate analysis, 521, 620, 773, 787, 788, 791  
nitrates and nitrites, 344, 354, 780  
nitratite, 606  
nitrogen cycle, 498, 499, 521  
NMR, 80, 83, 160, 170, 190, 205, 325, 419, 424-433, 442, 446, 447, 448, 815, 823, 829, 832  
nomographic method, 71  
non distillable fraction, 510  
non disturbed samples, 294  
non humic molecules, 453  
non-exchangeable ammonium, 790, 921  
non-hydrolysable nitrogen, 510, 511, 531  
nontronite, 71, 84, 657  
nordstrandite, 71, 111  
nsutite, 71  
nuclear magnetic resonance, 170, 424, 829  
number-average molecular weight, 438, 440
- octahedral layer, 632  
ODR, 581, 582, 587, 588, 589  
Oligochaetes, 289  
oligoclase, 71  
opal, 69, 71  
optical microscopy, 55, 83, 441, 951  
organic carbon, 200, 306, 309, 333, 334, 335, 340, 342, 357, 364, 366, 371, 454, 523, 907

- organic forms of nitrogen, 497, 500, 509  
organic P, 794, 795, 800-804, 807, 809, 814-818, 822-824, 828, 830  
organic phosphorous analysis, 814  
organic pollutants, 453, 456, 457  
organic S bound to C, 860  
organic S not bound to C, 862  
organic S, 842, 859, 860, 862, 886  
organochlorines, 457, 491  
organo-mineral bonds, 80, 200, 307, 374  
organo-mineral colloids, 289  
organophosphorous, 457, 484, 491, 793  
oriented diagrams, 94  
orthoclase, 71  
orthophosphates, 793, 794, 798, 817, 833  
orthophosphoric acid, 795  
oxidative alkaline fusion, 843  
oxidative fragmentation, 419  
oxidative or reducing reagents, 921  
oxygen and sulphur determination, 360  
oxyhydroxides, 91, 124, 148, 167, 172, 173, 176, 223, 659, 840
- P extraction, 195, 804, 805, 810  
P fixation, 168  
P form study by  $^{31}\text{P}$ -NMR, 828  
P forms, 793, 795, 796, 798, 799-810, 823, 828, 830  
P titration, 821  
paragonite, 84  
particle dispersion, 296  
particle size analysers, 18, 53, 75  
particle size analysis, 15-59, 61, 297, 307, 326  
particle size composition, 15, 28, 49  
particle size distribution, 152, 304, 323
- particle size fractionation, 15, 293, 290, 291, 310, 311, 314, 320  
PCBs, 457, 491  
penetrating ability, 15  
penninite, 84  
pentose sugars, 454, 458, 459, 461, 464, 465, 466, 495  
penwithita, 176  
permanent charges, 630, 646, 648, 649, 650, 657, 662, 710, 713, 737  
permeability, 15, 85, 373, 670  
permethrin, 484  
pesticide residues, 453, 483, 484  
pesticides, 328, 374, 414, 456-458, 483-492, 496, 667, 729, 793, 830, 835  
P-Fe complex, 758  
pH 7 methods, 712  
pH 8.1-8.2 methods, 713  
pH determination, 549, 553, 689  
pH measurement, 549, 569  
pH reference solutions, 558  
pH0, 645  
pH-K and pH-Ca determination, 567  
phlogopite, 71, 84  
pH-meter, 318, 506, 561-573, 584, 726, 738, 929  
pH-NaF measurement, 569  
phosphate analysis, 620  
phosphate availability, 758  
phosphatides, 478  
phosphomolybdic complex, 828  
phosphorous retention, 819  
phosphorous, 793, 831, 832, 927  
photoelectron spectroscopy, 442  
phyllosilicates, 99, 103, 113, 180, 201, 202, 284, 390, 631, 658, 710  
physical fractionation of organic matters, 289  
picromerite, 838  
pigments, 478

- pKA, 555  
plant debris compartment, 290  
plant residue weathering, 399  
plant roots, 289, 290, 293-296, 307, 312, 322, 455, 499, 594, 604, 610, 679, 687, 688, 808, 810, 841, 874, 875, 920  
plasma emission spectrometry, 913, 927, 931, 940, 944, 949, 972  
plasma mass spectrometry, 915, 926, 927, 944, 949, 951  
plasticity, 6, 15, 186, 327  
platinum quinhydrone electrode, 562  
point of zero charge, 181, 643, 645, 711, 756  
point of zero net charge, 645, 648  
point of zero net proton charge, 645, 648  
point of zero salt effect, 645, 648, 655  
polar lipids, 456  
polarization microscopes, 268  
pollutants, 282, 335, 453, 456-457, 483-490, 496, 667, 897  
polychlorobiphenyls, 457  
polyhalite, 836  
polynuclear aromatic hydrocarbons, 457  
polyphosphates, 793, 833  
polysaccharides, 296, 392, 393, 395, 408, 420, 453-458, 493, 494, 860, 862  
poral system, 65  
pore spaces, 172, 254, 270  
positive charges in soil, 755  
potential acidity, 553, 567, 678, 691, 741  
potential of H<sup>+</sup> ion, 549  
potentially mineralizable nitrogen, 500, 513-526  
potentiometric method, 561  
potentiometric titration, 647, 652  
powder diagrams, 76, 90, 93  
PPZC, 645  
pretreatment of clays, 99  
pretreatment of the electrode, 585  
preparation mould, 956  
preparation of alditol acetates, 469  
preparation of platinum electrode, 612  
Pristine point of zero charge, 645  
prochlorite, 84  
propazine, 484  
protozoaires, 289  
pseudo-sands, 17, 303  
Pt electrode, 583  
purification methods, 375, 389, 390, 391, 463  
purification of fulvic acids, 391  
purification of humic matters, 389  
pyrethrinoids, 457, 487, 490, 496  
pyrite, 71, 839  
pyrochlorite, 71  
pyrolusite, 71  
pyrolysis products, 362, 423, 424  
pyrophyllite, 84  
pyrophosphate method, 196  
PZC, 642, 645, 755, 756  
PZNC, 645-649  
PZNPC, 645, 648, 649  
PZSE, 645, 648, 649-654  
quantitative infrared analysis, 152  
quartz, 69, 71, 103, 123, 125, 239, 242  
ramsdelite, 71  
random error, 321, 322  
rare earth elements, 944  
rate of oxygen diffusion, 582, 587, 588  
rate of saturation, 553, 675, 684, 710, 711, 719, 748  
rate of water saturation, 608  
reagents for total dissolutions, 903  
redox potential measurement, 581

- redox potential, 581, 824  
reducing fragmentation, 420  
reflux heating acid hydrolysis, 420  
relaxation time, 167, 427, 430, 433  
resins, 32, 57, 60, 184, 189, 256, 257, 258, 259, 307, 308, 323, 324, 326, 334, 337, 356, 390, 391, 392, 456, 738, 776, 806, 810, 823, 920  
respirometry, 329, 527, 528, 530  
reticular plans, 87, 276, 953  
rH, 583, 589, 590  
Robinson-Köhn pipette, 34, 38  
rotating stage, 269  
rutile, 176
- salt bridge of connection, 584  
SANS, 170, 171  
saponification, 479, 480, 481, 482, 490  
saponite, 84, 657  
saturated paste extract, 607  
sauconite, 84  
SAXS, 170, 171  
scale of magnifying power, 267  
scanning electron microscopy, 74, 76, 83, 264, 269, 285, 441  
reflection scanning microscopes, 280  
scanning transmission electron microscopes, 279  
scattering, 273, 281  
scintillation detector, 964  
secondary electrons, 271, 273, 280, 281  
sedimentation cylinder, 24, 37, 320  
sedimentometry, 38, 290  
selective dissolution, 148, 167, 173, 180, 198, 215  
selective electrode, 620, 621, 615, 618, 782  
selective extractions, 804, 920  
selectivity coefficient, 697, 698  
selectivity equations, 699, 700  
selectivity, 139, 160, 169, 183, 192, 193, 194, 197, 203, 209, 485, 633, 697-707, 715, 727, 800, 806, 823  
SEM, 21, 55, 74, 168, 169, 210, 258, 264-267, 269-273, 275, 280-282, 596, 830  
separation by centrifugation, 670  
separation by distillation, 506  
sepiolite, 79  
sequential analysis of sulphur forms, 877  
sesquioxides, 16, 18, 27  
shellfishes, 289  
short range organization, 80, 93, 115, 120, 124, 134, 153, 167, 169, 170, 172, 174, 177, 186, 223, 632, 634, 659, 830, 886  
siderite, 233, 234, 332, 333, 334, 359, 593, 596, 599, 600  
sieving, 24, 33, 39, 48, 124, 290, 299, 312, 313, 314, 319, 320, 321, 322, 328, 330, 487, 568, 810  
silhydrite, 71  
silica gel, 177  
silicates, 56, 102, 103, 108, 251  
silicium, 258, 927  
silt-organic complex, 291  
silver/silver chloride electrode, 564  
simazine, 484  
SIMS, 254  
slaking, 15, 49, 65, 297  
SMP buffer method, 690  
sodium adsorption ratio, 59, 616, 641, 700  
soil lipids, 456, 495  
sol sugars, 453, 492  
solid phase, 3, 52, 76, 169, 477, 479, 630, 667, 716, 814, 895  
solid-state <sup>13</sup>C-NMR, 430

- solubility of hydroxides, 174  
soluble salts, 8, 10, 18, 41, 59, 124, 189, 232, 260, 333, 586, 594, 605-638, 668, 671, 672, 700, 711, 717, 719, 731, 737, 738, 739, 763, 837, 870, 879  
soluble sulphates, 870, 871, 875, 876, 884  
soluble sulphides, 842, 863, 866, 870  
soluble sulphured forms, 842  
solution of Light, 585  
solution of Zobell, 585  
solvation, 80, 97, 99, 104, 106, 120, 129, 702, 739  
sonic and ultrasonic dispersion, 297  
sorption of anions, 759  
specific electrical conductivity, 612, 627  
spectra of differential thermal analysis, 245  
spectrocolorimetric method, 804  
spectrocolorimetric methods, 824  
spectrocolorimetry, 195, 199, 336, 341, 348, 353, 704, 724, 733, 797, 818, 822, 823, 828, 853, 916-919, 925-927, 932  
spectrum  $^{31}\text{P}$ -NMR, 829  
spin number, 424, 425  
sputtering metallization apparatus, 266  
standard stock solutions, 934  
steam distillation, 504, 505, 512, 525  
STEM, 124, 168, 170, 271-273, 279, 830  
Stern theory, 635  
steroids, 456  
sterols, 478, 479  
stilpnosiderite, 177  
stishovite, 177  
stones, 15, 16, 294, 331, 841  
stretching vibrations, 149, 150  
structural models of humic molecules, 401  
structural unit, 85, 658  
structure of humic molecule, 400  
submicrometric analysis, 53  
substances with short range organization, 79, 118, 182, 241, 569, 722  
sудоite, 84  
sugars by liquid chromatography, 475  
sulfonylurea, 484  
sulphate analysis, 620, 878  
sulphate colorimetric titration, 852  
sulphates, 9, 360, 462, 605, 606, 620, 672, 836, 840, 846, 851, 853, 860, 862, 866, 867, 870-878, 882, 884, 886, 889, 903, 933  
sulphides, 9, 12, 234, 235, 360, 552, 553, 599, 836, 840-842, 847, 850, 857, 863, 865, 866, 868, 870, 874, 878  
sulphur amino acids, 859  
sulphur compounds, 835, 836, 837, 841, 858, 859, 878, 885  
sulphur forms, 858  
sulphur in pyrites, 865  
sulphur of gypseous soils, 878  
sulphur requirement of soil, 884  
sulphur, 360, 835, 837, 839, 853, 869  
surface charge, 645, 647, 650, 659, 744  
surface charges of hydroxylated materials, 659  
swelling water, 67  
sylvinite, 606  
talc, 84, 101, 102, 123, 632  
Tamm, 30, 57, 179, 182, 184, 188, 218



- Tamm's reagent, 27, 30, 125, 180  
technique of cold vapour, 938  
technique of hydrides in AAS, 935  
technique of sodic resins, 308  
techniques of dispersion, 290, 291,  
293, 297, 299, 300, 304, 307,  
308  
techniques of sieving, 291  
TEM-HR, 124, 168  
Tensionic apparatus, 789  
terbutylazine, 484  
textural classes, 17, 65  
texture triangles, 17  
TG, 221, 251, 421, 884  
TGA, 8, 9, 80, 83, 124, 140, 158,  
190, 221-248, 361  
thenardite, 606, 838  
theory of double layer, 634, 649  
theory of Gouy and Chapman, 635  
thermal analysis, 8, 9, 83, 117, 124,  
138, 140, 158, 190, 221-251,  
355, 361, 421, 596, 799, 855,  
866, 868, 875, 880  
thermal degradation, 421  
thermal effects on soil minerals, 243  
thermal treatment, 108, 115, 237  
thermo mechanical analysis, 222  
thermobalance, 228, 231, 232, 250  
thermocouples, 231  
thermogravimetric analysis, 158,  
221, 222, 226, 229, 361  
thermonatrite, 606  
thin section, 112, 253, 267, 269, 830  
thin sections, 140, 186, 255-261,  
269, 270, 275, 830  
thiocarbamates, 457  
titanium gel, 177  
titanium, 930  
titration of carboxyl groups, 408  
titration of functional groups, 417  
titrimeter, 616  
titrimetry, 344, 353, 531, 616, 617,  
618, 620, 682, 770  
TMA, 222  
todorokite, 177  
total absorbed metals, 924  
total acidity determination, 408  
total analysis, 970  
total carbonate analysis, 595  
total carbonates, 334, 595, 596, 925  
total elements, 900  
total lipids, 471, 473  
total nitrogen of hydrolysate, 507  
total organic matters, 332, 334  
total organic oxygen, 360  
total  $\text{SO}_4^{2-}$ -S by ionic  
chromatography, 855  
total solubilization by hypobromite,  
844  
total solubilization, 901  
total sulphur analysis, 842  
total sulphur ultimate analysis, 853  
total sulphur, 360, 837, 853  
trace elements, 897, 935, 936, 940  
transmission electron microscopy,  
261, 277  
transmittance, 135, 136, 137, 138,  
153  
triazins, 457, 485, 488  
tridymite, 71  
trimethylsilyl derivatives, 475  
trimethylsilylation, 211  
trioctahedral minerals, 114, 148  
trioctahedral silicates, 103  
trioctahedral vermiculite, 84  
turbomolecular pumps, 280  
types of radiation, 273  
ultimate analysis, 327, 365  
ultimate microanalysis, 282  
ultracentrifugation, 65, 68, 69, 97,  
116, 120, 139, 153, 429, 440,  
445, 731, 822  
ultracentrifuge, 53, 67, 69, 72, 98,  
416, 814

- ultrafiltration, 438, 439, 545, 751, 822  
ultramicrobalance, 139  
ultrapure germanium detector, 964  
ultrasonic probe, 300  
ultrasonics, 20, 32, 33, 54, 60, 299, 394, 912  
unsaponifiable products, 479  
urea analysis, 511, 543  
uronic acids, 454, 462, 465, 466, 475  
useful water storage, 6  
UV-visible spectrometry, 410, 446
- valence vibrations, 133  
Van der Waals forces, 3, 4, 31  
vanthoffite, 838  
variable charges, 645, 646, 649, 650, 657, 659, 661, 662, 663, 669, 671, 688, 710, 711, 712, 713, 723, 726, 744, 757, 761  
vaterite, 593  
vermiculite, 84, 102, 103, 116, 125, 637  
vernadite, 177  
very fine sands, 16, 39  
viscoelasticity, 222  
viscosimetry, 440  
viscosity, 19, 22, 23, 25, 35, 54, 66, 69, 258, 440, 486  
volumetry, 618
- Walkley and Black, 335  
Walpole comparator, 559, 560  
water extractions, 920  
water holding capacity, 4, 7, 15, 569  
water soluble organic, 474  
water soluble P, 808
- waxes, 371, 456  
WDX, 83, 168, 253, 264, 273, 283  
weak acid aqueous solution, 556  
weak base aqueous solution, 556  
weight-average molecular weight, 438  
wet mineralization, 796  
wilting point, 4  
worm pile, 289
- XANES, 170  
X-ray diffraction, 83  
X-ray diffractometry, 83, 90, 866  
X-ray fluorescence analysis, 858, 952  
X-ray fluorescence apparatus, 954  
X-ray fluorescence, 102, 900, 952, 953, 954, 955, 957  
X-ray tube, 87, 88, 114, 953, 957  
X-ray, 9, 22, 51, 53, 72, 76, 79, 80, 86-130, 153, 172, 271, 275, 276, 279, 282, 284, 393, 438, 439, 442, 450, 632, 830, 901, 952  
X-rays, 86, 124, 128, 172, 442, 951, 952, 953  
XRD, 74, 78, 80, 83-130, 134, 146, 148, 153, 168, 169, 170, 189, 190, 205, 210, 213, 214, 223, 261, 275, 276, 595, 799, 866, 875, 880  
zero point charge, 630, 645  
zero point of net charge, 645  
zero point titration, 645, 649  
zeta potential, 32, 54  
ZPC, 630, 645, 647-649, 654-656, 711, 714, 744, 765  
ZPNC, 645  
ZPT, 645, 649, 654, 655

## Periodic table of the elements\*

Period	Group								
	IA	IIA	IIIB	IVB	VB	VIB	VIIIB	VIII	
	1	2	3	4	5	6	7	8	9
1	<div style="display: flex; justify-content: space-between;"> <div style="width: 20%;"> <p><b>1</b> 1.00794 1,-1 <b>H</b> 1s<sup>1</sup> Hydrogen</p> </div> <div style="width: 70%; text-align: center;"> <p>Atomic number <b>14</b> 28.0855 +2,± 4 Symbol <b>Si</b> (Ne)3s<sup>2</sup>3p<sup>2</sup> Name Silicon Atomic mass Oxidation degree* Electronic configuration</p> </div> </div>								
2	<p><b>3</b> 6.941 +1 <b>Li</b> 1s<sup>2</sup>2s<sup>1</sup> Lithium</p>	<p><b>4</b> 9.01218 +2 <b>Be</b> 1s<sup>2</sup>2s<sup>2</sup> Beryllium</p>							
3	<p><b>11</b> 22.9898 +1 <b>Na</b> (Ne)3s<sup>1</sup> Sodium</p>	<p><b>12</b> 24.305 +2 <b>Mg</b> (Ne)3s<sup>2</sup> Magnesium</p>							
4	<p><b>19</b> 39.0983 +1 <b>K</b> (Ar)4s<sup>1</sup> Potassium</p>	<p><b>20</b> 40.078 +2 <b>Ca</b> (Ar)4s<sup>2</sup> Calcium</p>	<p><b>21</b> 44.95591 +3 <b>Sc</b> (Ar)3d<sup>1</sup>4s<sup>2</sup> Scandium</p>	<p><b>22</b> 47.867 +4,3,2 <b>Ti</b> (Ar)3d<sup>2</sup>4s<sup>2</sup> Titanium</p>	<p><b>23</b> 50.9415 +5,4,3,2 <b>V</b> (Ar)3d<sup>3</sup>4s<sup>2</sup> Vanadium</p>	<p><b>24</b> 51.9961 +6,3,2 <b>Cr</b> (Ar)3d<sup>5</sup>4s<sup>1</sup> Chromium</p>	<p><b>25</b> 54.93805 +7,4,3,2 <b>Mn</b> (Ar)3d<sup>5</sup>4s<sup>2</sup> Manganese</p>	<p><b>26</b> 55.845 +2,3 <b>Fe</b> (Ar)3d<sup>6</sup>4s<sup>2</sup> Iron</p>	<p><b>27</b> 58.9332 +2,3 <b>Co</b> (Ar)3d<sup>7</sup>4s<sup>2</sup> Cobalt</p>
5	<p><b>37</b> 85.4678 +1 <b>Rb</b> (Kr)5s<sup>1</sup> Rubidium</p>	<p><b>38</b> 87.62 +2 <b>Sr</b> (Kr)5s<sup>2</sup> Strontium</p>	<p><b>39</b> 88.90585 +3 <b>Y</b> (Kr)4d<sup>1</sup>5s<sup>2</sup> Yttrium</p>	<p><b>40</b> 91.224 +4 <b>Zr</b> (Kr)4d<sup>2</sup>5s<sup>2</sup> Zirconium</p>	<p><b>41</b> 92.9064 +5,3 <b>Nb</b> (Kr)4d<sup>4</sup>5s<sup>1</sup> Niobium</p>	<p><b>42</b> 95.94 +6,4 <b>Mo</b> (Kr)4d<sup>5</sup>5s<sup>1</sup> Molybdenum</p>	<p><b>43</b> 97.9072 +7,6,4 <b>Tc</b> (Kr)4d<sup>5</sup>5s<sup>1</sup> Technetium</p>	<p><b>44</b> 101.07 +2,3,4 <b>Ru</b> (Kr)4d<sup>7</sup>5s<sup>1</sup> Ruthenium</p>	<p><b>45</b> 102.905 +1,3 <b>Rh</b> (Kr)4d<sup>8</sup>5s<sup>1</sup> Rhodium</p>
6	<p><b>55</b> 132.905 +1 <b>Cs</b> (Xe)6s<sup>1</sup> Caesium</p>	<p><b>56</b> 137.327 +2 <b>Ba</b> (Xe)6s<sup>2</sup> Barium</p>	<p><b>57</b> 138.905 +3 <b>La</b> (Xe)5d<sup>1</sup>6s<sup>2</sup> Lanthanum</p>	<p><b>72</b> 178.49 +4 <b>Hf</b> 4f<sup>14</sup>5d<sup>2</sup>6s<sup>2</sup> Hafnium</p>	<p><b>73</b> 180.948 +5 <b>Ta</b> 4f<sup>14</sup>5d<sup>3</sup>6s<sup>2</sup> Tantalum</p>	<p><b>74</b> 183.84 +6,4 <b>W</b> 4f<sup>14</sup>5d<sup>4</sup>6s<sup>2</sup> Tungsten</p>	<p><b>75</b> 186.207 +7,6,4 <b>Re</b> 4f<sup>14</sup>5d<sup>5</sup>6s<sup>2</sup> Rhenium</p>	<p><b>76</b> 190.23 +3,4,6 <b>Os</b> 4f<sup>14</sup>5d<sup>6</sup>6s<sup>2</sup> Osmium</p>	<p><b>77</b> 192.217 +3,4 <b>Ir</b> 4f<sup>14</sup>5d<sup>7</sup>6s<sup>2</sup> Iridium</p>
7	<p><b>87</b> 223.020 +1 <b>Fr</b> (Rn)7s<sup>1</sup> Francium</p>	<p><b>88</b> 226.025 +2 <b>Ra</b> (Rn)7s<sup>2</sup> Radium</p>	<p><b>89</b> 227.028 +3 <b>Ac</b> (Rn)6d<sup>1</sup>7s<sup>2</sup> Actinium</p>	<p><b>104</b> 261.11 +4 <b>Unq</b> 5f<sup>14</sup>6d<sup>2</sup>7s<sup>2</sup> Unnilquad.</p>	<p><b>105</b> 262.1 +4 <b>Unp</b> 5f<sup>14</sup>6d<sup>3</sup>7s<sup>2</sup> Unnilpent.</p>	<p><b>106</b> 263.12 +6 <b>Unh</b> 5f<sup>14</sup>6d<sup>4</sup>7s<sup>2</sup> Unnilhex.</p>	<p><b>107</b> 262.12 +7 <b>Uns</b> 5f<sup>14</sup>6d<sup>5</sup>7s<sup>2</sup> Unnilsept.</p>	<p><b>108</b> (265) +8 <b>Uno</b> 5f<sup>14</sup>6d<sup>6</sup>7s<sup>2</sup> Unniloctium</p>	<p><b>109</b> (267) +8 <b>Une</b> 5f<sup>14</sup>6d<sup>7</sup>7s<sup>2</sup> Unnilen.</p>

Alkaline

Alkaline  
earth

Rare earth - Lanthanides						
<p><b>58</b> 140.115 +3,4 <b>Ce</b> 4f<sup>2</sup>5d<sup>0</sup>6s<sup>2</sup> Cerium</p>	<p><b>59</b> 140.908 +3 <b>Pr</b> 4f<sup>3</sup>5d<sup>0</sup>6s<sup>2</sup> Praseodymium</p>	<p><b>60</b> 144.24 +3 <b>Nd</b> 4f<sup>4</sup>5d<sup>0</sup>6s<sup>2</sup> Neodymium</p>	<p><b>61</b> 146.915 +3 <b>Pm</b> 4f<sup>5</sup>5d<sup>0</sup>6s<sup>2</sup> Promethium</p>	<p><b>62</b> 150.36 +3,2 <b>Sm</b> 4f<sup>6</sup>5d<sup>0</sup>6s<sup>2</sup> Samarium</p>	<p><b>63</b> 151.965 +3,2 <b>Eu</b> 4f<sup>7</sup>5d<sup>0</sup>6s<sup>2</sup> Europium</p>	<p><b>64</b> 157.25 +3 <b>Gd</b> 4f<sup>7</sup>5d<sup>1</sup>6s<sup>2</sup> Gadolinium</p>
Rare earth - Actinides						
<p><b>90</b> 232.038 +4 <b>Th</b> (Rn)6d<sup>2</sup>7s<sup>2</sup> Thorium</p>	<p><b>91</b> 231.036 +5,4 <b>Pa</b> 5f<sup>2</sup>6d<sup>1</sup>7s<sup>2</sup> Protactinium</p>	<p><b>92</b> 238.029 +6,5,4,3 <b>U</b> 5f<sup>3</sup>6d<sup>1</sup>7s<sup>2</sup> Uranium</p>	<p><b>93</b> 237.048 +6,5,4,3 <b>Np</b> 5f<sup>4</sup>6d<sup>1</sup>7s<sup>2</sup> Neptunium</p>	<p><b>94</b> 244.064 +6,5,4,3 <b>Pu</b> 5f<sup>6</sup>6d<sup>1</sup>7s<sup>2</sup> Plutonium</p>	<p><b>95</b> 243.061 +6,5,4,3 <b>Am</b> 5f<sup>7</sup>6d<sup>0</sup>7s<sup>2</sup> Americium</p>	<p><b>96</b> 247.070 +3 <b>Cm</b> 5f<sup>7</sup>6d<sup>1</sup>7s<sup>2</sup> Curium</p>

\*Only the oxidation degrees most commonly found in natural conditions are included

\*IUPAC base (International Union of Pure and Applied Chemistry, 1996-2001)

°systematic IUPAC name (not discovered)

		Group							Atomic layer	
		IB	IIB	IIIA	IVA	VA	VIA	VIIA	0	
		11	12	13	14	15	16	17	18	
									24.002602 0 <b>He</b> 1s <sup>2</sup> Helium	K
									5 10.811 +3 <b>B</b> 1s <sup>2</sup> 2s <sup>2</sup> 2p <sup>1</sup> Boron	K L
									6 12.011 ± 4,+2 <b>C</b> 1s <sup>2</sup> 2s <sup>2</sup> 2p <sup>2</sup> Carbon	
									7 14.0067 ± 3,2,1,+4,5 <b>N</b> 1s <sup>2</sup> 2s <sup>2</sup> 2p <sup>3</sup> Nitrogen	K L M
									8 15.9994 -2 <b>O</b> 1s <sup>2</sup> 2s <sup>2</sup> 2p <sup>4</sup> Oxygen	
									9 18.9984 -1 <b>F</b> 1s <sup>2</sup> 2s <sup>2</sup> 2p <sup>5</sup> Fluorine	K L M
									10 20.180 0 <b>Ne</b> 1s <sup>2</sup> 2s <sup>2</sup> 2p <sup>6</sup> Neon	
									13 26.9815 +3 <b>Al</b> (Ne)3s <sup>2</sup> 3p <sup>1</sup> Aluminium	K L M
									14 28.0855 ± 4,+2 <b>Si</b> (Ne)3s <sup>2</sup> 3p <sup>2</sup> Silicon	
									15 30.9738 ± 3,+5 <b>P</b> (Ne)3s <sup>2</sup> 3p <sup>3</sup> Phosphorus	L M N
									16 32.066 ± 2,+4,6 <b>S</b> (Ne)3s <sup>2</sup> 3p <sup>4</sup> Sulphur	
									17 35.4527 ± 1,+3,5,7 <b>Cl</b> (Ne)3s <sup>2</sup> 3p <sup>5</sup> Chlorine	L M N
									18 39.948 0 <b>Ar</b> (Ne)3s <sup>2</sup> 3p <sup>6</sup> Argon	
28 58.693 +2,3 <b>Ni</b> (Ar)3d <sup>8</sup> 4s <sup>2</sup> Nickel	29 63.546 +2,1 <b>Cu</b> (Ar)3d <sup>10</sup> 4s <sup>1</sup> Copper	30 65.39 +2 <b>Zn</b> (Ar)3d <sup>10</sup> 4s <sup>2</sup> Zinc	31 69.723 +3 <b>Ga</b> 3d <sup>10</sup> 4s <sup>2</sup> 4p <sup>1</sup> Gallium	32 72.61 ± 4,+2 <b>Ge</b> 3d <sup>10</sup> 4s <sup>2</sup> 4p <sup>2</sup> Germanium	33 74.9216 ± 3,+5 <b>As</b> 3d <sup>10</sup> 4s <sup>2</sup> 4p <sup>3</sup> Arsenic	34 78.96 -2,+4,6 <b>Se</b> 3d <sup>10</sup> 4s <sup>2</sup> 4p <sup>4</sup> Selenium	35 79.904 ± 1,+3,5 <b>Br</b> 3d <sup>10</sup> 4s <sup>2</sup> 4p <sup>5</sup> Bromine	36 83.80 0 <b>Kr</b> 3d <sup>10</sup> 4s <sup>2</sup> 4p <sup>6</sup> Krypton	L M N	
46 106.42 +2,4 <b>Pd</b> (Kr)4d <sup>10</sup> Palladium	47 107.868 +1 <b>Ag</b> (Kr)4d <sup>10</sup> 5s <sup>1</sup> Silver	48 112.411 +2 <b>Cd</b> (Kr)4d <sup>10</sup> 5s <sup>2</sup> Cadmium	49 114.818 +3 <b>In</b> 4d <sup>10</sup> 5s <sup>2</sup> 5p <sup>1</sup> Indium	50 118.710 ± 4,+2 <b>Sn</b> 4d <sup>10</sup> 5s <sup>2</sup> 5p <sup>2</sup> Tin	51 121.760 ± 3,+5 <b>Sb</b> 4d <sup>10</sup> 5s <sup>2</sup> 5p <sup>3</sup> Antimony	52 127.60 ± 2,+4,6 <b>Te</b> 4d <sup>10</sup> 5s <sup>2</sup> 5p <sup>4</sup> Tellurium	53 126.9045 ± 1,+3,5,7 <b>I</b> 4d <sup>10</sup> 5s <sup>2</sup> 5p <sup>5</sup> Iodine	54 131.29 0 <b>Xe</b> 4d <sup>10</sup> 5s <sup>2</sup> 5p <sup>6</sup> Xenon	M N O	
78 195.08 +2,4 <b>Pt</b> 4f <sup>14</sup> 5d <sup>9</sup> 6s <sup>1</sup> Platinum	79 196.967 +3,1 <b>Au</b> 4f <sup>14</sup> 5d <sup>10</sup> 6s <sup>1</sup> Gold	80 200.59 +2,1 <b>Hg</b> 4f <sup>14</sup> 5d <sup>10</sup> 6s <sup>2</sup> Mercury	81 204.383 +3,1 <b>Tl</b> 5d <sup>10</sup> 6s <sup>2</sup> 6p <sup>1</sup> Thallium	82 207.2 +4,2 <b>Pb</b> 5d <sup>10</sup> 6s <sup>2</sup> 6p <sup>2</sup> Lead	83 208.980 +3,5 <b>Bi</b> 5d <sup>10</sup> 6s <sup>2</sup> 6p <sup>3</sup> Bismuth	84 (209) ± 2,+4 <b>Po</b> 5d <sup>10</sup> 6s <sup>2</sup> 6p <sup>4</sup> Polonium	85 (210) ± 1,+5,7 <b>At</b> 5d <sup>10</sup> 6s <sup>2</sup> 6p <sup>5</sup> Astatine	86 222.02 0 <b>Rn</b> 5d <sup>10</sup> 6s <sup>2</sup> 6p <sup>6</sup> Radon	N O P	
110 <b>Uun</b> Ununnil.	111 <b>Uuu</b> Unununi.	112 <b>Uub<sup>o</sup></b> Ununbium	113 <b>Uut<sup>o</sup></b> Ununtrium	114 <b>Uuq<sup>o</sup></b> Ununquadr.	115 <b>Uup<sup>o</sup></b> Ununpent.	116 <b>Uuh<sup>o</sup></b> Ununhex.	117 <b>Uus<sup>o</sup></b> Ununsept.	118 <b>Uuo<sup>o</sup></b> Ununoct.	O P Q	

Noble  
gases

65 158.925 +3 <b>Tb</b> 4f <sup>9</sup> 5d <sup>0</sup> 6s <sup>2</sup> Terbium	66 162.50 +3 <b>Dy</b> 4f <sup>10</sup> 5d <sup>0</sup> 6s <sup>2</sup> Dysprosium	67 164.930 +3 <b>Ho</b> 4f <sup>11</sup> 5d <sup>0</sup> 6s <sup>2</sup> Holmium	68 167.26 +3 <b>Er</b> 4f <sup>12</sup> 5d <sup>0</sup> 6s <sup>2</sup> Erbium	69 168.934 +3 <b>Tm</b> 4f <sup>13</sup> 5d <sup>0</sup> 6s <sup>2</sup> Thulium	70 173.04 +3,2 <b>Yb</b> 4f <sup>14</sup> 5d <sup>0</sup> 6s <sup>2</sup> Ytterbium	71 174.967 +3 <b>Lu</b> 4f <sup>14</sup> 5d <sup>1</sup> 6s <sup>2</sup> Lutetium	N O P
---	--	--	--	--	---	---	-------------

97 247.07 +4,3 <b>Bk</b> 5f <sup>9</sup> 6d <sup>0</sup> 7s <sup>2</sup> Berkelium	98 251.08 +3 <b>Cf</b> 5f <sup>10</sup> 6d <sup>0</sup> 7s <sup>2</sup> Californium	99 252.08 +3 <b>Es</b> 5f <sup>11</sup> 6d <sup>0</sup> 7s <sup>2</sup> Einsteinium	100 257.10 +3 <b>Fm</b> 5f <sup>12</sup> 6d <sup>0</sup> 7s <sup>2</sup> Fermium	101 258.098 +2,3 <b>Md</b> 5f <sup>13</sup> 6d <sup>0</sup> 7s <sup>2</sup> Mendelevium	102 259.10 +2,3 <b>No</b> 5f <sup>14</sup> 6d <sup>0</sup> 7s <sup>2</sup> Nobelium	103 262.11 +3 <b>Lr</b> 5f <sup>14</sup> 6d <sup>1</sup> 7s <sup>2</sup> Lawrencium	O P Q
--	---	---	--	---	---	---	-------------