Medical Immunology

Fifth Edition

Revised and Expanded

edited by
Gabriel Virella

Medical Immunology

Fifth Edition
Revised and Expanded

edited by

Gabriel Virella

*Medical University of South Carolina
Charleston, South Carolina*



MARCEL DEKKER, INC.

NEW YORK • BASEL

Copyright © 2001 by Marcel Dekker, Inc. All Rights Reserved.

ISBN: 0-8247-0550-5

This book is printed on acid-free paper.

Headquarters

Marcel Dekker, Inc.
270 Madison Avenue, New York, NY 10016
tel: 212-696-9000; fax: 212-685-4540

Eastern Hemisphere Distribution

Marcel Dekker AG
Hutgasse 4, Postfach 812, CH-4001 Basel, Switzerland
tel: 41-61-261-8482; fax: 41-61-261-8896

World Wide Web

<http://www.dekker.com>

The publisher offers discounts on this book when ordered in bulk quantities. For more information, write to Special Sales/Professional Marketing at the headquarters address above.

Copyright © 2001 by Marcel Dekker, Inc. All Rights Reserved.

Neither this book nor any part may be reproduced or transmitted in any form or by any means, electronic or mechanical, including photocopying, microfilming, and recording, or by any information storage and retrieval system, without permission in writing from the publisher.

Current printing (last digit):
10 9 8 7 6 5 4 3 2 1

PRINTED IN THE UNITED STATES OF AMERICA

Preface

In 1986, Marcel Dekker, Inc., published the first edition of *Introduction to Medical Immunology*. It is remarkable that in 2001 the same publisher continues to enthusiastically back the publication of the fifth edition, now with the shorter title of *Medical Immunology*. This is a book that goes against the grain. Notes in the margins, boxes with correlations, or learning objectives will not challenge the reader. What we try to provide is a classic text with updated information, written with a solid medical perspective. We believe that this approach is the most appropriate one for the education of physicians of the 21st century. Whether used by a medical student or by a resident, intern, or young specialist, the book will provide a good balance between basic and clinical science. Of course, it is as true now as it was years ago that the field of immunology continues to grow at a brisk pace, and that many concepts are victims of constant revision. It is very true of immunology that the more we know the greater is our ignorance. But all of us involved in the fifth edition have enthusiastically undertaken the task of providing a general introductory book that should remain viable for half a decade. If we use past editions as a yardstick, we have achieved this goal.

This new edition has been thoroughly revised and reorganized. We have, obviously, maintained its emphasis on the clinical application of immunology. We also remain faithful to our strong conviction that this textbook is written not to impress our peers with extraordinary insights or revolutionary knowledge, but rather to be helpful to medical students and young professionals who need an introduction to the field. This means that the scientific basis of immunology needs to be clearly conveyed without allowing the detail to obscure the concept. The application to medicine needs to be transparently obvious, but without unnecessary exaggeration. The text must present a reasonably general and succinct overview, but needs to cover areas that appear likely to have a strong impact in the foreseeable future. The book should stimulate students to seek more information and to develop his or her own “thinking” but cannot be a castle of theoretical dreams (and nightmares).

With these goals in mind, one major change that we made in this edition was the redistribution of topics and rearrangement of chapters, to ensure a more logical and cohesive presentation. The first part, “Basic Immunology,” includes a new chapter on phagocytic cells preceding “Infections and Immunity,” thus bringing to a close a logical sequence that starts with the discussion of the cells and tissues involved in the immune response. The sec-

ond part, “Diagnostic Immunology,” consists of a single, new chapter in which the most modern aspects of diagnostic immunology are presented in a simple and effective fashion. The chapters in Part III (“Clinical Immunology”) have been thoroughly revised, and are peppered with cases in order to provide a solid anchor between the discussion of concrete problems presented by patients with diseases of immunological basis and the relevant scientific principles. A new part—“Immunodeficiency Diseases”—has been added to reflect the extraordinary significance of immunodeficiency diseases in clinical immunology, from providing experiments of nature that allow us to understand how the immune system is organized in humans to secondary immunodeficiencies (including those caused iatrogenically as well as the acquired immunodeficiency syndrome) encountered by physicians of all specialties with increasing frequency. Part IV contains three important chapters: one dealing with the diagnosis of immunodeficiencies, the second dedicated to primary immunodeficiencies, and the last dedicated to secondary immunodeficiencies.

In preparing this new edition, I have been lucky in securing the continuing participation of many of the collaborators responsible for previous editions, and I was also able to recruit new blood, bringing new perspectives to some key chapters. I also express our gratitude to Marcel Dekker for his continuing support, and to Ms. Kerry Doyle for her editorial efforts. We applied our best efforts to produce a concise textbook that should bring to the attention of our readers the intrinsic fascination of a discipline that seeks understanding of fundamental biological knowledge, with the goal of applying that knowledge to the diagnosis and treatment of human diseases. We hope that this new edition will be a worthy successor to the previous four.

Gabriel Virella, M.D., Ph.D.

Contents

<i>Preface</i>	<i>iii</i>
<i>Contributors</i>	<i>ix</i>
Part I Basic Immunology	
1. Introduction <i>Gabriel Virella</i>	1
2. Cells and Tissues Involved in the Immune Response <i>Gabriel Virella and Jean-Michel Goust</i>	11
3. Major Histocompatibility Complex <i>Jean-Michel Goust</i>	31
4. The Induction of an Immune Response: Antigens, Lymphocytes, and Accessory Cells <i>Gabriel Virella and Barbara E. Bierer</i>	51
5. Immunoglobulin Structure <i>Gabriel Virella</i>	77
6. Biosynthesis, Metabolism, and Biological Properties of Immunoglobulins <i>Gabriel Virella</i>	93
7. Genetics of Immunoglobulins <i>Janardan P. Pandey</i>	105
8. Antigen-Antibody Reactions <i>Gabriel Virella</i>	119
9. The Complement System <i>Robert Boackle</i>	135

vi	Contents
10. Lymphocyte Ontogeny and Membrane Markers <i>Virginia M. Litwin and Jean-Michel Goust</i>	161
11. Cell-Mediated Immunity <i>Barbara E. Bierer, Jean-Michel Goust, and Gabriel Virella</i>	193
12. The Humoral Immune Response and Its Induction by Active Immunization <i>Gabriel Virella</i>	225
13. Phagocytic Cells <i>Gabriel Virella</i>	245
14. Infections and Immunity <i>Gabriel Virella</i>	259
 Part II Diagnostic Immunology	
15. Diagnostic Immunology <i>Gabriel Virella and Virginia M. Litwin</i>	279
 Part III Clinical Immunology	
16. Tolerance and Autoimmunity <i>George C. Tsokos, Jean-Michel Goust, and Gabriel Virella</i>	313
17. Organ-Specific Autoimmune Diseases <i>Gabriel Virella and Jean-Michel Goust</i>	341
18. Systemic Lupus Erythematosus <i>George C. Tsokos and Jean-Michel Goust</i>	361
19. Rheumatoid Arthritis <i>Jean-Michel Goust and Gabriel Virella</i>	377
20. Hypersensitivity Reactions <i>Gabriel Virella</i>	397
21. IgE-Mediated (Immediate) Hypersensitivity <i>Jean-Michel Goust and Albert F. Finn, Jr.</i>	411
22. Immunohematology <i>Gabriel Virella and Mary Ann Spivey</i>	431
23. Immune Complex Diseases <i>Gabriel Virella and George C. Tsokos</i>	453
24. Immune System Modulators <i>Philip D. Hall, Jean-Michel Goust, and Gabriel Virella</i>	473

Contents	vii
25. Transplantation Immunology <i>Gabriel Virella, Richard Knight, and Jonathan Bromberg</i>	501
26. Tumor Immunology <i>Sebastiano Gattoni-Celli</i>	517
27. Malignancies of the Immune System <i>Gabriel Virella and Jean-Michel Goust</i>	529
Part IV Immunodeficiency Diseases	
28. Diagnosis of Immunodeficiency Diseases <i>Gabriel Virella and John Sleasman</i>	555
29. Primary Immunodeficiency Diseases <i>Gabriel Virella and John Sleasman</i>	573
30. AIDS and Other Acquired Immunodeficiency Diseases <i>Gabriel Virella</i>	599
<i>Index</i>	<i>631</i>

Contributors

Barbara E. Bierer, M.D. Chief, Laboratory of Lymphocyte Biology, National Heart, Lung, and Blood Institute, National Institutes of Health, Bethesda, Maryland

Robert J. Boackle, Ph.D. Professor and Director of Oral Biology and Professor of Immunology, Medical University of South Carolina, Charleston, South Carolina

Jonathan S. Bromberg, M.D., Ph.D. Professor of Surgery, Gene Therapy, Molecular Medicine, and Chief, Kidney/Pancreas Transplantation and Transplant Research, Recanati-Miller Transplant Institute, Mount Sinai School of Medicine, New York, New York

Albert F. Finn, Jr., M.D. Clinical Associate Professor of Medicine, Department of Medicine and Department of Microbiology, and Immunology, Medical University of South Carolina, Charleston, South Carolina

Sebastiano Gattoni-Celli, M.D. Professor, Department of Radiation Oncology and Department of Microbiology and Immunology, Medical University of South Carolina, Charleston, South Carolina

Jean-Michel Goust, M.D. Professor, Department of Microbiology and Immunology, Medical University of South Carolina, Charleston, South Carolina

Philip D. Hall, Pharm.D. Associate Professor, College of Pharmacy, Medical University of South Carolina, Charleston, South Carolina

Richard Knight, M.D. Associate Professor of Surgery, Recanati-Miller Transplant Institute, Mount Sinai School of Medicine, New York, New York

Virginia M. Litwin, Ph.D. Senior Research Investigator, Clinical Pharmacology/Experimental Medicine, Bristol-Myers Squibb Company, Hamilton Square, New Jersey

Janardan P. Pandey, Ph.D. Professor, Department of Microbiology and Immunology, Medical University of South Carolina, Charleston, South Carolina

John Sleasman, M.D. Professor and Chief, Division of Immunology and Infectious Diseases, Department of Pediatrics, University of Florida, Gainesville, Florida

Mary Ann Spivey, M.H.S., M.T. (A.S.C.P.), S.B.B. Department of Pathology–Laboratory Medicine, Transfusion Medicine Section, Medical University of South Carolina, Charleston, South Carolina

George C. Tsokos, M.D. Professor of Medicine and Molecular/Cell Biology and Director, Division of Immunology/Rheumatology, Uniformed Services University, Bethesda, and Chief, Department of Cellular Injury, Walter Reed Army Institute of Research, Silver Spring, Maryland

Gabriel Virella, M.D., Ph.D. Professor and Vice Chairman of Education, Department of Microbiology and Immunology, Medical University of South Carolina, Charleston, South Carolina

1

Introduction

Gabriel Virella

I. HISTORICAL OVERVIEW

The fundamental observation that led to the development of immunology as a scientific discipline was that an individual might become resistant for life to a certain disease after having contracted it only once. The term immunity, derived from the Latin *immunis* (exempt), was adopted to designate this naturally acquired protection against diseases such as measles or smallpox.

The emergence of immunology as a discipline was closely tied to the development of microbiology. The work of Pasteur, Koch, Metchnikoff, and many other pioneers of the golden age of microbiology resulted in the rapid identification of new infectious agents. This was closely followed by the discovery that infectious diseases could be prevented by exposure to killed or attenuated organisms or to compounds extracted from the infectious agents. The impact of immunization against infectious diseases such as tetanus, measles, mumps, poliomyelitis, and smallpox, to name just a few examples, can be grasped when we reflect on the fact that these diseases, which were at one time significant causes of mortality and morbidity, are now either extinct or very rarely seen. Indeed, it is fair to state that the impact of vaccination and sanitation on the welfare and life expectancy of humans has had no parallel in any other developments of medical science.

In the second part of this century immunology started to transcend its early boundaries and become a more general biomedical discipline. Today, the study of immunological defense mechanisms is still an important area of research, but immunologists are involved in a much wider array of problems, such as self-nonself discrimination, control of cell and tissue differentiation, transplantation, cancer immunotherapy, etc. The focus of in-

terest has shifted toward the basic understanding of how the immune system works in the hope that this insight will allow novel approaches to its manipulation.

II. GENERAL CONCEPTS

A. Specific and Nonspecific Defenses

The protection of our organism against infectious agents involves many different mechanisms—some nonspecific (i.e., generically applicable to many different pathogenic organisms) and others specific (i.e., their protective effect is directed to one single organism).

Nonspecific defenses, which as a rule are innate (i.e., all normal individuals are born with them), include:

- Mechanical barriers such as the integrity of the epidermis and mucosal membranes
- Physicochemical barriers, such as the acidity of the stomach fluid
- The antibacterial substances (e.g., lysozyme, defensins) present in external secretions
- Normal intestinal transit and normal flow of bronchial secretions and urine, which eliminate infectious agents from the respective systems
- Ingestion and elimination of bacteria and particulate matter by granulocytes, which is independent of the immune response

Specific defenses, as a rule, are induced during the life of the individual as part of the complex sequence of events designated as the immune response. The immune response has two unique characteristics:

1. *Specificity for the eliciting antigen*; for example, immunization with inactivated poliovirus only protects against poliomyelitis, not against viral influenza. The specificity of the immune response is due to the existence of exquisitely discriminative antigen receptors on lymphocytes. Only a single or a very limited number of similar structures can be accommodated by the receptors of any given lymphocyte. When those receptors are occupied, an activating signal is delivered to the lymphocytes. Therefore, only those lymphocytes with specific receptors for the antigen in question will be activated.
2. *Memory*, meaning that repeated exposure to a given antigen elicits progressively more intense specific responses. Most immunizations involve repeated administration of the immunizing compound, with the goal of establishing a long-lasting, protective response. The increase in the magnitude and duration of the immune response with repeated exposure to the same antigen is due to the proliferation of antigen-specific lymphocytes after each exposure. The numbers of responding cells will remain increased even after the immune response subsides. Therefore, whenever the organism is exposed again to that particular antigen, there is an expanded population of specific lymphocytes available for activation, and, as a consequence, the time needed to mount a response is shorter and the magnitude of the response is higher.

B. Stages of the Immune Response

To better understand how the immune response is generated, it is useful to consider it as divided into separate sequential stages (Table 1.1). The first stage, induction, involves a small

Table 1.1 A Simplified Overview of the Three Main Stages of the Immune Response

Stage of the immune response	Induction	Amplification	Effector
Cells/molecules involved	Antigen-presenting cells; lymphocytes	Antigen-presenting cells; helper T lymphocytes	Antibodies (+ complement or cytotoxic cells); cytotoxic T lymphocytes; macrophages
Mechanisms	Processing and/or presentation of antigen; recognition by specific receptors on lymphocytes	Release of cytokines; signals mediated by interaction between membrane molecules	Complement-mediated lysis; opsonization and phagocytosis; cytotoxicity
Consequences	Activation of T and B lymphocytes	Proliferation and differentiation of T and B lymphocytes	Elimination of nonself; neutralization of toxins and viruses

lymphocyte population with specific receptors able to recognize an antigen or antigen fragments generated by specialized cells known as antigen-presenting cells (APCs). The proliferation and differentiation of APCs is usually enhanced by amplification systems involving the APCs themselves and specialized T-cell subpopulations (T helper cells, defined below). This is followed by the production of effector molecules (antibodies) or by the differentiation of effector cells (cells that directly or indirectly mediate the elimination of undesirable elements). The final outcome, therefore, is the elimination of the organism or compound that triggered the reaction by means of activated immune cells or by reactions triggered by mediators released by the immune system.

III. CELLS OF THE IMMUNE SYSTEM

The peripheral blood contains two large populations of cells: the red cells, whose main physiological role is to carry oxygen to tissues, and the white cells, which have as their main physiological role the elimination of potentially harmful organisms or compounds. Among the white blood cells, lymphocytes are particularly important because of their central role in the immune response. Several subpopulations of lymphocytes have been defined:

1. B lymphocytes, which are the precursors of antibody-producing cells, known as plasma cells.
2. T lymphocytes, which can be divided into several subpopulations:
 - a. Helper T lymphocytes (T_H), which play a very significant amplification role in the immune responses. Two functionally distinct subpopulations of T helper lymphocytes emerging from a precursor population (T_H0) have been defined: 1) T_H1 lymphocytes, which assist the differentiation of cytotoxic cells and also activate macrophages (activated macrophages, in turn, play a role as effectors of the immune response), and 2) T_H2 lymphocytes,

which are mainly involved in the amplification of B-lymphocyte responses.

These amplifying effects of helper T lymphocytes are mediated in part by soluble mediators—*cytokines*—and in part by signals delivered as a consequence of cell-cell interactions.

- b. Cytotoxic T lymphocytes, which are the main immunological effector mechanism involved in the elimination of nonself or infected cells.
 - c. Immunoregulatory T lymphocytes, which lack unique membrane markers but have the ability to downregulate the immune response through the release of cytokines such as interleukin-10 (IL-10).
3. Antigen-presenting cells, such as macrophages and macrophage-related cells and dendritic cells, play a significant role in the induction stages of the immune response by trapping and presenting both native antigens and antigen fragments in a most favorable way for the recognition by lymphocytes. In addition, these cells also deliver activating signals to lymphocytes engaged in antigen recognition, both in the form of soluble mediators (interleukins such as IL-1, IL-12, and IL-18) and in the form of signals delivered by cell-cell contact.
 4. Phagocytic cells, such as monocytes, macrophages, and granulocytes, also play significant roles as effectors of the immune response. One of their main functions is to eliminate antigens that have elicited an immune response. This is achieved by means of antibodies and complement, as discussed below. However, if the antigen is located on the surface of a cell, antibody induces the attachment of cytotoxic cells that cause the death of the antibody-coated cell (antibody-dependent cellular cytotoxicity, ADCC).
 5. Natural killer (NK) cells play a dual role in the elimination of infected and malignant cells. These cells are unique in that they have two different mechanisms of recognition: they can identify malignant or viral-infected cells by their decreased expression of histocompatibility antigens, and they can recognize antibody-coated cells and mediate ADCC.

IV. ANTIGENS AND ANTIBODIES

Antigens are usually exogenous substances (cells, proteins, and polysaccharides) which are recognized by receptors on lymphocytes, thereby eliciting the immune response. The receptor molecules located on the membrane of lymphocytes interact with small portions of those foreign cells or proteins, designated as antigenic determinants or epitopes. An adult human being has the capability to recognize millions of different antigens, some of microbial origin, others present in the environment, and even some artificially synthesized.

Antibodies are proteins that appear in circulation after infection or immunization and that have the ability to react specifically with epitopes of the antigen introduced in the organism. Because antibodies are soluble and are present in virtually all body fluids (“humors”), the term humoral immunity was introduced to designate the immune responses in which antibodies play the principal roles as effector mechanism. Antibodies are also generically designated as immunoglobulins. This term derives from the fact that antibody molecules structurally belong to the family of proteins known as globulins (globular proteins) and from their involvement in immunity.

The knowledge that the serum of an immunized animal contained protein molecules able to bind specifically to the antigen led to exhaustive investigations of the characteris-

tics and consequences of the antigen-antibody reactions. At a morphological level, two types of reactions were defined:

1. If the antigen is soluble, the reaction with specific antibody under appropriate conditions results in precipitation of large antigen-antibody aggregates.
2. If the antigen is expressed on a cell membrane, the cell will be cross-linked by antibody and form visible clumps (agglutination).

Functionally, antigen-antibody reactions can be classified by their biological consequences:

Viruses and soluble toxins released by bacteria lose their infectivity or pathogenic properties after reaction with the corresponding antibodies (neutralization).

Antibodies complexed with antigens can activate the complement system. Nine major proteins or components that are sequentially activated constitute this system. Some of the complement components are able to promote ingestion of microorganisms by phagocytic cells, while others are inserted into cytoplasmic membranes and cause their disruption, leading to lysis of the offending microbial cell.

Antibodies can cause the destruction of microorganisms by promoting their ingestion by phagocytic cells or their destruction by cells mediating ADCC. Phagocytosis is particularly important for the elimination of bacteria and involves the binding of antibodies and complement components to the outer surface of the infectious agent (opsonization) and recognition of the bound antibody and/or complement components as a signal for ingestion by the phagocytic cell.

Antigen-antibody reactions are the basis of certain pathological conditions, such as allergic reactions. Antibody-mediated allergic reactions have a very rapid onset—a matter of minutes—and are known as immediate hypersensitivity reactions.

V. LYMPHOCYTES AND CELL-MEDIATED IMMUNITY

Lymphocytes play a significant role as effector cells in three main types of situations, all of them considered as expression of cell-mediated immunity, i.e., immune reactions in which T lymphocytes are the predominant effector cells.

A. Immune Elimination of Intracellular Infectious Agents

Viruses, bacteria, parasites, and fungi have developed strategies that allow them to survive inside phagocytic cells or cells of other types. Infected cells are generally not amenable to destruction by phagocytosis or complement-mediated lysis. The study of how the immune system recognizes and eliminates infected cells resulted in the definition of the biological role of the histocompatibility antigens (HLA) that had been described as responsible for graft rejection (see below). Those membrane molecules have a peptide-binding pouch that needs to be occupied with peptides derived from either endogenous or exogenous proteins. The immune system does not recognize self-peptides associated with self-HLA molecules. In the case of infected cells, peptides split from microbial proteins synthesized by the infected cell as part of the microbial replication cycle become associated with HLA

molecules. The HLA-peptide complexes are presented to the immune system and activate specific cytotoxic T lymphocytes as well as specific T_H1 lymphocytes. Both cytotoxic T cells and T_H1 lymphocytes can mediate killing of the infected cells against which they became sensitized. Cytotoxic T cells kill the infected cells directly, stopping the replication of the intracellular organism, while activated T_H1 cells release cytokines, such as interferon- γ , which activate macrophages and increase their ability to destroy the intracellular infectious agents.

B. Transplant (Graft) Rejection

As stated above, the immune system does not respond (i.e., is tolerant) to self-antigens, including antigens of the major histocompatibility complex (MHC), which includes the HLA molecules. However, transplantation of tissues among genetically different individuals of the same species or across species is followed by rejection of the grafted organs or tissues. The rejection reaction is triggered by the presentation of peptides generated from nonself MHC molecules. The MHC system is highly polymorphic (hundreds of alleles have been defined and new ones are added on a regular basis to the known repertoire), and this leads to the generation of millions of peptides, which differ in structure from individual to individual.

C. Delayed Hypersensitivity

While the elimination of intracellular infectious agents can be considered as the main physiological role of cell-mediated immunity and graft rejection is an unexpected and undesirable consequence of a medical procedure, other lymphocyte-mediated immune reactions can be considered as pathological conditions arising spontaneously in predisposed individuals. The most common example involves skin reactions, or cutaneous hypersensitivity, induced by direct skin contact or by intradermal injection of antigenic substances. These reactions express themselves 24–48 hours after exposure to an antigen to which the patient had been previously sensitized, and because of this timing factor received the designation of delayed hypersensitivity reactions.

VI. SELF VERSUS NONSELF DISCRIMINATION

The immune response is triggered by the interaction of an antigenic determinant with specific receptors on lymphocytes. It is calculated that there are several millions of different receptors in lymphocytes— 10^{15} – 10^{18} on T cells and 10^{11} on B cells—sufficient to respond to a wide diversity of epitopes presented by microbial agents and potentially noxious exogenous compounds. At the same time, the immune system has the capacity to generate lymphocytes with receptors able to interact with epitopes expressed by self antigens. During embryonic differentiation and adult life the organism uses a variety of mechanisms to ensure that potentially autoreactive lymphocytes are eliminated or turned off. This lack of response to self antigens is known as tolerance to self.

When the immune system is exposed to exogenous compounds, it tends to develop a vigorous immune response. The discrimination between self and nonself is based the fact that the immune system has the ability to recognize a wide variety of structural differences on exogenous compounds. For example, infectious agents have marked differences in their

chemical structure, easily recognizable by the immune system. Cells, proteins, and polysaccharides from animals of different species have differences in chemical constitution, which as a rule are directly related to the degree of phylogenetic divergence between species. Those also elicit potent immune responses. Finally, many polysaccharides and proteins from individuals of any given species show antigenic heterogeneity, reflecting the genetic diversity of individuals within a species. Those differences are usually minor (relative to differences between species) but can still be recognized by the immune system. Transfusion reactions, graft rejection, and hypersensitivity reactions to exogenous human proteins are clinical expressions of the recognition of this type of differences between individuals.

VII. GENERAL OVERVIEW

One of the most difficult intellectual exercises in immunology is to try to understand the global organization and control of the immune system. Its extreme complexity and the wide array of regulatory circuits involved in fine-tuning the immune response pose a formidable obstacle to our understanding. A concept map depicting a simplified view of the immune system is reproduced in Figure 1.1.

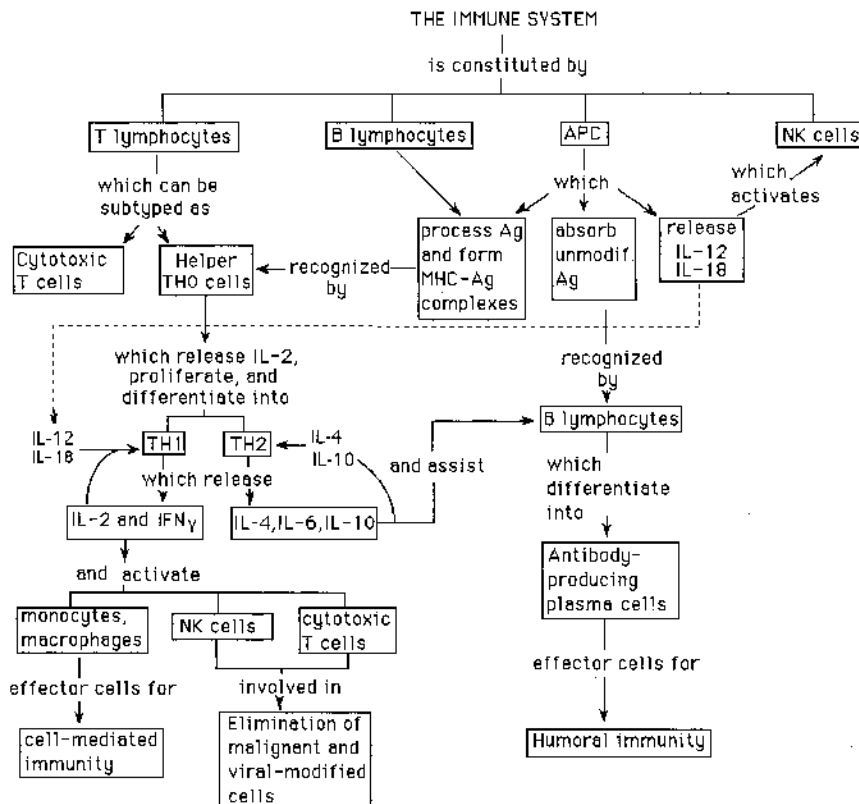

Fig. 1.1 A concept map representing the main components of the immune system and their interactions.

If we use as an example the activation of the immune system by an infectious agent that has managed to overcome the innate anti-infectious defenses, the first step must be the uptake of the infectious agent by a cell capable of presenting it to the immune system in favorable conditions for the induction of an immune response. In the case of T lymphocytes, APCs expressing MHC-II molecules play this role. A variety of cells can function as APCs, including tissue macrophages, B cells, and dendritic cells. Those cells adsorb the infectious agent to their surface, ingest some of the absorbed microorganism, and process it into small antigenic subunits. These subunits become intracellularly associated with histocompatibility antigens, and the resulting complex is transported to the cytoplasmic membrane, allowing stimulation of helper T lymphocytes. The interaction between surface proteins expressed by antigen-presenting cells and T lymphocytes as well as cytokines released by the antigen-presenting cells act as costimulants of the helper T cells. How antigen is presented to B cells is not very clear, but it is well established that the activation of an immune response takes place in a lymphoid organ (lymph node, peri-intestinal lymphoid tissues, spleen). All cellular elements necessary for the inductive and effector stages of an immune response are present on the lymphoid tissues, where there is ample opportunity for interactions and cooperation between those different cells.

Once stimulated to proliferate and differentiate, helper T cells become able to assist the differentiation of effector cells. However, not all helper T cells seem to assist all types of effector cells that require their help. Activated T_H1 helper lymphocytes secrete cytokines that act on a variety of cells, including macrophages (further increasing their level of activation and enhancing their ability to eliminate infectious agents that may be surviving intracellularly), and cytotoxic T cells, which are very efficient in the elimination of virus-infected cells. In contrast, activated T_H2 helper lymphocytes secrete a different set of cytokines that will assist the proliferation and differentiation of antigen-stimulated B lymphocytes, which then differentiate into plasma cells. The plasma cells are engaged in the synthesis of large amounts of antibody.

As stated earlier, antibodies are the main effector molecules of the humoral immune response. As specific antibodies bind to a microorganism and the complement system is activated, the microorganisms will either be ingested and destroyed by phagocytic cells or be killed by complement-mediated lysis or by leukocytes able to mediate ADCC.

Once the microorganism is removed, negative feedback mechanisms become predominant, turning off the immune response. The downregulation of the immune response appears to result from the combination of several factors, such as the elimination of the positive stimulus that the microorganism represented and the activation of lymphocytes with immunoregulatory activity that secrete cytokines that deliver inactivating signals to other lymphocytes.

At the end of the immune response, a residual population of long-lived lymphocytes specific for the offending antigen will remain. This is the population of memory cells that is responsible for protection after natural exposure or immunization. It is also the same generic cell subpopulation that may cause accelerated graft rejections in recipients of multiple grafts. As discussed in greater detail below, the same immune system that protects us can be responsible for a variety of pathological conditions.

VIII. IMMUNOLOGY AND MEDICINE

Immunological concepts have found ample applications in medicine in areas related to diagnosis, treatment, prevention, and pathogenesis.

1. The exquisite specificity of the antigen-antibody reaction has been extensively applied to the development of diagnostic assays for a variety of substances. Such applications received a strong boost when experiments with malignant plasma cell lines and normal antibody-producing cells resulted serendipitously in the discovery of the technique of hybridoma production, the basis for the production of monoclonal antibodies, which have had an enormous impact in the fields of diagnosis and immunotherapy.
2. Immunotherapy is a field with enormous possibilities, although the results of many attempts at the therapeutic application of immune strategies have been disappointing. Nevertheless, stimulation of the immune system with cytokines (particularly IL-2), downregulation of inflammatory reactions with anticytokine antibodies or recombinant soluble receptors, treatment of leukemia with monoclonal antibodies and immunotoxins, and prevention of graft rejection with monoclonal antibodies are but a few examples of successful medical applications of immunotherapy protocols.
3. The study of children with deficient immune system development (immunodeficiency disease) has provided the best tools for the study of the immune system in humans, while at the same time giving us ample opportunity to devise corrective therapies. The acquired immunodeficiency syndrome (AIDS) underscored the delicate balance that is maintained between the immune system and infectious agents in the healthy individual and has stimulated a considerable amount of basic research into the regulation of the immune system that may have enormous implications not only in the treatment of HIV/AIDS, but in many other areas of medicine.
4. The importance of maintaining self-tolerance in adult life is obvious when we consider the consequences of the loss of tolerance. Several diseases, some affecting single organs, others of a systemic nature, have been classified as autoimmune diseases. In such diseases the immune system reacts against cells and tissues; this reactivity can either be the primary insult leading to the disease or represent a factor contributing to the evolution and increasing severity of the disease. New knowledge of how to induce a state of unresponsiveness in adult life through oral ingestion of antigens has raised hopes for the rational treatment of autoimmune conditions.
5. Not all reactions against nonself are beneficial. If and when the delicate balance that keeps the immune system from overreacting is broken, hypersensitivity diseases may become manifest. Common allergies, such as asthma and hay fever, are prominent examples of diseases caused by hypersensitivity reactions. Manipulation of the immune response to induce a protective rather than harmful immunity was first attempted with success in this type of disease.
6. Research into the mechanisms underlying the normal state of tolerance against nonself attained during normal pregnancy continues to be intensive, since this knowledge could be the basis for more effective manipulations of the immune response in patients needing organ transplants and for the treatment or prevention of infertility.
7. The concept that malignant mutant cells are constantly being eliminated by the immune system (immune surveillance) and that malignancies develop when the mutant cells escape the protective effects of the immune system has been extensively debated, but not quite proven. However, anticancer therapies directed at

the enhancement of antitumoral responses continue to be evaluated, and some have met with encouraging results.

In the remaining chapters of this book, we will illustrate abundantly the productive interaction that has always existed in immunology between basic concepts and clinical applications. In fact, no other biological discipline better illustrates the importance of the interplay between basic and clinical scientists; in this lies the main reason for the prominence of immunology as a biomedical discipline.

2

Cells and Tissues Involved in the Immune Response

Gabriel Virella and Jean-Michel Goust

I. INTRODUCTION

The fully developed immune system of humans and most mammals is constituted by a variety of cells and tissues whose different functions are remarkably well integrated. Among the cells, the lymphocytes play a key role in the control and regulation of immune responses as well as in the recognition of infected or heterologous cells, which the lymphocytes can recognize as undesirable and promptly eliminate. Among the tissues, the thymus is the site of differentiation for T lymphocytes and, as such, is directly involved in critical steps in the differentiation of the immune system.

II. CELLS OF THE IMMUNE SYSTEM

A. Lymphocytes

The lymphocytes (Fig. 2.1A) occupy a very special place among the leukocytes that participate in one way or another in immune reactions due to their ability to interact specifically with antigenic substances and to react to nonself antigenic determinants. Lymphocytes differentiate from stem cells in the fetal liver, bone marrow, and thymus into two main functional classes. They are found in the peripheral blood and in all lymphoid tissues.

B lymphocytes or B cells are so designated because the bursa of Fabricius, a lymphoid organ located close to the caudal end of the gut in birds, plays a key role in their dif-

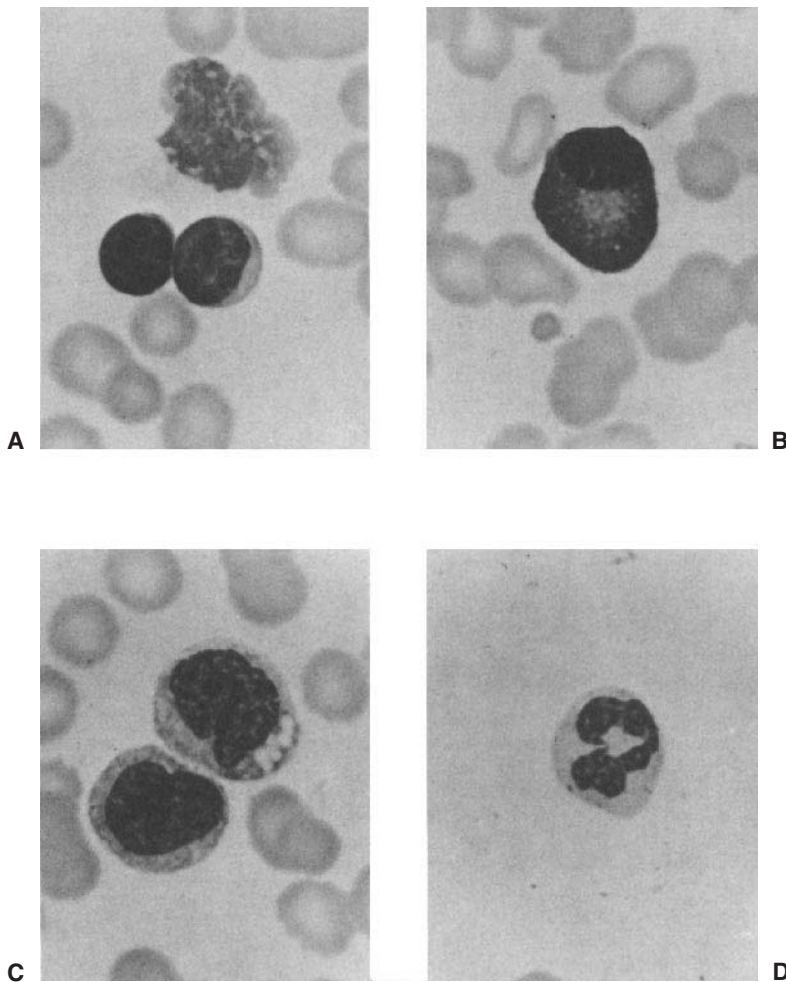

Fig. 2.1 Morphology of the main types of human leukocytes: (A) lymphocyte; (B) plasma cell; (C) monocyte; (D) granulocyte. (Reproduced with permission from Reich, P. R. *Manual of Hematology*. Upjohn, Kalamazoo, MI, 1976.)

ferentiation. Removal of this organ, at or shortly before hatching, is associated with lack of differentiation, maturation of B lymphocytes, and the inability to produce antibodies. A mammalian counterpart to the avian bursa has not yet been found. Some investigators believe that the bone marrow is the most likely organ for B-lymphocyte differentiation, while others propose that the peri-intestinal lymphoid tissues play this role.

B lymphocytes carry immunoglobulins on their cell membrane, which function as antigen receptors. After proper stimulation, B cells differentiate into antibody-producing cells (plasma cells). B lymphocytes can also play the role of antigen-presenting cells, which is usually attributed to cells of monocytic/macrophagic lineage (see Chapters 3 and 4).

T lymphocytes or T cells are so designated because the thymus plays a key role in their differentiation. The functions of the T lymphocytes include the regulation of immune responses and various effector functions (cytotoxicity and lymphokine production being the main ones) that are the basis of cell-mediated immunity (CMI). T lymphocytes also

carry an antigen-recognition unit on their membranes, known as T-cell receptors. T-cell receptors and immunoglobulin molecules are structurally unrelated.

Several subpopulations of T lymphocytes with separate functions have been recognized. The main two populations are the helper T lymphocytes, which are involved in the induction and regulation of immune responses, and the cytotoxic T lymphocytes, which are involved in the destruction of infected cells. It is also known that at specific stages of the immune response T lymphocytes can have suppressor functions, but the definition of a specific population of regulatory cells continues to elude immunologists. Actually, to this date there are no known markers that allow one to distinguish T lymphocytes with different functions, although it is possible to differentiate cells with predominant helper function from those with predominant cytotoxic function.

T-cell-mediated cytotoxicity is a complex process involving several possible pathways. Two of the pathways involve the release of proteins known as perforins, which insert themselves in the target cell membranes, forming channels. The formation of such channels may result in cell death by allowing diffusion of water into the hypertonic intracellular milieu, causing cellular swelling and eventually loss of integrity. On the other hand, the perforin channels also allow the diffusion of enzymes (granzymes, which are serine esterases) into the cytoplasm. Once in the cytoplasm, granzymes induce apoptosis, the pathway of which is Ca^{2+} -dependent. Another pathway, which is Ca^{2+} -independent, can be easily demonstrated in knockout laboratory animals in which the perforin gene is inactivated or by carrying out killing experiments in buffers without Ca^{2+} . This second proapoptotic pathway requires cell-cell contact and depends on signals delivered by the cytotoxic cell to the target cell, mediated by a molecule known as Fas and its respective ligand (see Chapter 11).

T lymphocytes have a longer lifespan than B lymphocytes. Long-lasting lymphocytes are particularly important because of their involvement on immunological memory.

Upon recognizing an antigen and receiving additional signals from auxiliary cells, a small, resting T lymphocyte rapidly undergoes blastogenic transformation into a large lymphocyte (13–15 μm). This large lymphocyte (lymphoblast) then subdivides to produce an expanded population of medium (9–12 μm) and small (5–8 μm) lymphocytes with the same antigenic specificity.

Activated and differentiated T lymphocytes are morphologically indistinguishable from a small, resting lymphocyte. In contrast, activated B lymphocytes differentiate into plasma cells, which are easy to distinguish morphologically from resting B lymphocytes.

B. Plasma Cells

Plasma cells are morphologically characterized by their eccentric nuclei with clumped chromatin and a large cytoplasm with abundant rough endoplasmic reticulum (Fig. 2.1B). Plasma cells produce and secrete large amounts of immunoglobulin but do not express membrane immunoglobulins. Plasma cells divide very poorly, if at all. Plasma cells are usually found in the bone marrow and in the peri-mucosal lymphoid tissues.

C. Natural Killer (NK) Cells

Morphologically, NK cells are described as large granular lymphocytes. These cells do not carry antigen receptors of any kind but can recognize antibody molecules bound to target cells and destroy those cells using the same general mechanisms involved in T-lymphocyte

cytotoxicity (antibody-dependent cellular cytotoxicity). They also have a recognition mechanism that allows them to destroy tumor cells and virus-infected cells.

D. Monocytes, Macrophages, and Related Cells

Monocytes and macrophages are believed to be closely related. The monocyte (Fig. 2.1C) is considered a leukocyte in transit through the blood, which when fixed in a tissue will become a macrophage. Monocytes and macrophages, as well as granulocytes (see below), are able to ingest particulate matter (microorganisms, cells, inert particles) and for this reason are said to have phagocytic functions. The phagocytic activity is greater in macrophages (particularly after activation by soluble mediators released during immune responses) than in monocytes.

Macrophages, monocytes, and related cells play an important role in the inductive stages of the immune response by processing complex antigens and concentrating antigen fragments on the cell membrane. In this form, the antigen is recognized by helper T lymphocytes, as discussed in detail in Chapters 3 and 4. For this reason, these cells are known as antigen-presenting cells (APC). APC include other cells sharing certain functional properties with monocytes and macrophages present in skin (Langerhans cells), kidney, brain (microglia), capillary walls, and lymphoid tissues. Langerhans cells can migrate to the lymph nodes, where they interact with T lymphocytes and assume the morphological characteristics of dendritic cells (Fig. 2.2).

All antigen-presenting cells express one special class of histocompatibility antigens, designated as class II MHC or Ia (I region-associated) antigens (see Chapter 3). The expression of MHC-II molecules is essential for the interaction with helper T lymphocytes. Antigen-presenting cells also release cytokines, which assist the proliferation of antigen-stimulated lymphocytes, including interleukins (IL)-1, -6, and -12.

Another type of monocyte-derived cell, the follicular dendritic cell, is present in the spleen and lymph nodes, particularly in follicles and germinal centers. This cell, apparently of monocytic lineage, is not phagocytic and does not express MHC-II molecules on the membrane, but it appears particularly suited to carry out the antigen-presenting function in relation to B lymphocytes. Follicular dendritic cells concentrate unprocessed antigen on the membrane and keep it there for relatively long periods of time, a factor that may be crucial for a sustained B-cell response. The follicular dendritic cells form a network in the germinal centers, known as the antigen-retaining reticulum.

E. Granulocytes

Granulocytes are a collection of white blood cells with segmented or lobulated nuclei and granules in their cytoplasm, which are visible with special stains. Because of their segmented nuclei, which assume variable sizes and shapes, these cells are generically designated as polymorphonuclear neutrophil leukocytes (PMN) (Fig. 2.1D). Different subpopulations of granulocytes (neutrophils, eosinophils, and basophils) can be distinguished by differential staining of the cytoplasmic granules, reflecting their different chemical constitution.

Neutrophils are the largest subpopulation of white blood cells and have two types of cytoplasmic granules containing compounds with bactericidal activity. Their biological importance derives from their phagocytic activity. Like most other phagocytic cells, they ingest with greatest efficiency microorganisms and particulate matter coated by antibody and

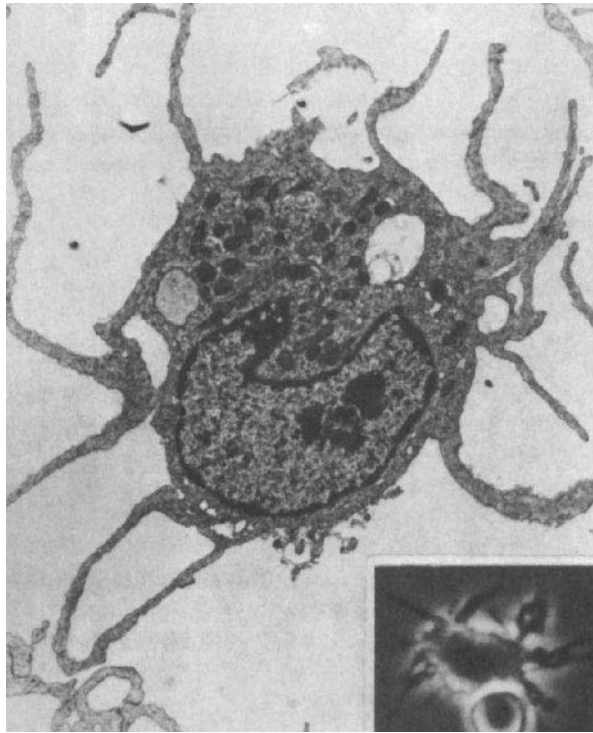

Fig. 2.2 Electron microphotograph of a follicular dendritic cell isolated from a rat lymph node ($\times 5000$). The inset illustrates the *in vitro* interaction between a dendritic cell and a lymphocyte as seen in phase contrast microscopy ($\times 300$). (Reproduced with permission from Klinkert, W. E. F., Labadie, J. H., O'Brien, J. P., Beyer, L. F., and Bowers, W. E. *Proc. Natl. Acad. Sci. USA*, 77:5414, 1980.)

complement (see Chapter 9). However, nonimmunological mechanisms have also been shown to lead to phagocytosis by neutrophils, perhaps reflecting phylogenetically more primitive mechanisms of recognition.

Neutrophils are attracted by chemotactic factors to areas of inflammation. Those factors may be released by microbes (particularly bacteria) or may be generated during complement activation as a consequence of an antigen-antibody reaction. The attraction of neutrophils is especially intense in bacterial infections. Great numbers of neutrophils may die trying to eliminate the invading bacteria. Dead PMN and their debris become the primary component of pus, characteristic of many bacterial infections. Bacterial infections associated with the formation of pus are designated as purulent.

Eosinophils are PMN with granules that stain orange-red with cytological stains containing eosin. These cells are found in high concentrations in allergic reactions and during parasitic infections; their roles in both areas will be discussed in later chapters.

Basophils have granules that stain metachromatically due to their contents of histamine and heparin. The tissue-fixed mast cells are very similar to basophils, even though they appear to evolve from different precursor cells. Both basophils and mast cells are involved in antiparasitic immune mechanisms and play key pathogenic roles in allergic reactions.

III. LYMPHOID TISSUES AND ORGANS

The immune system is organized on several special tissues, collectively designated as lymphoid or immune tissues. These tissues, as shown in Figure 2.3, are distributed throughout the entire body. Some lymphoid tissues achieve a remarkable degree of organization and can be designated as lymphoid organs. The most ubiquitous of the lymphoid organs are the lymph nodes, located in groups along major blood vessels and loose connective tissues. Other mammalian lymphoid organs are the thymus and the spleen (white pulp). Lymphoid tissues include the gut-associated lymphoid tissues (GALT)—tonsils, Peyer's patches, and appendix—as well as aggregates of lymphoid tissue in the submucosal spaces of the respiratory and genito-urinary tracts. The distribution of T and B lymphocytes within human lymphoid tissues is not homogeneous. As shown in Table 2.1, T lymphocytes predominate in the lymph, peripheral blood, and, above all, in the thymus. B lymphocytes predominate

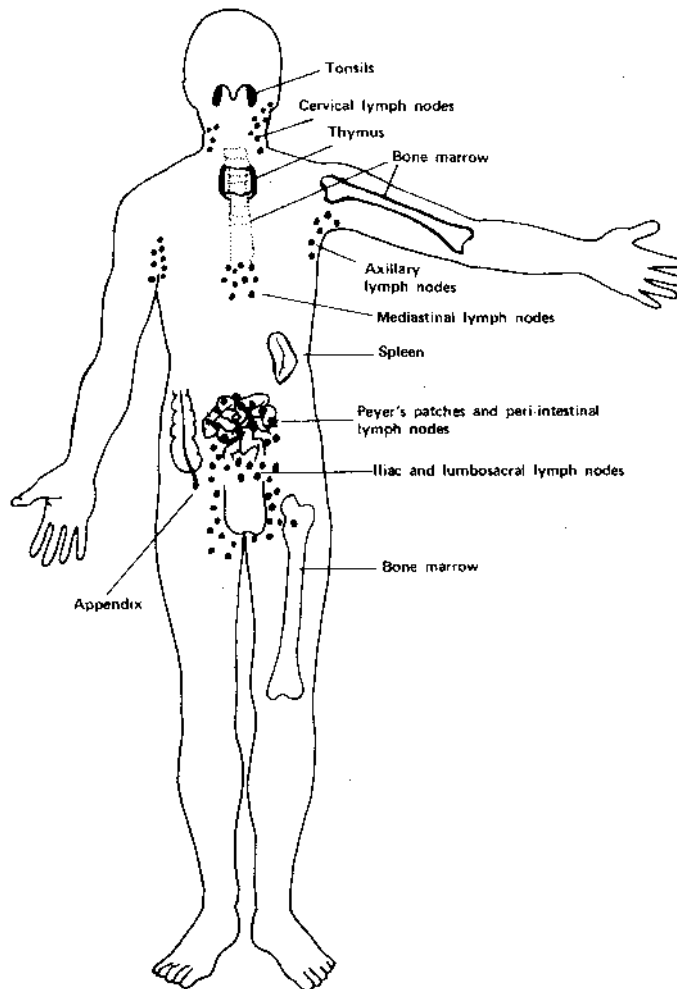

Fig. 2.3 Diagrammatic representation of the distribution of lymphoid tissues in humans. (Modified from Mayerson, H. S. *Sci. Am.*, 208:80, 1963.)

Table 2.1 Distribution of T and B Lymphocytes in Humans

Immune tissue	Lymphocyte distribution (%) ^a	
	T lymphocytes	B lymphocytes
Peripheral blood	80	10 ^b
Thoracic duct	90	10
Lymph node	75	25
Spleen	50	50
Thymus	100	<5
Bone marrow	<25	>75
Peyer's patch	10–20	70

^a Approximate values.

^b The remaining 10% would correspond to non-T, non-B lymphocytes.

in the bone marrow and perimucosal lymphoid tissues. Furthermore, lymphoid tissues can be subdivided into primary and secondary lymphoid tissues based on the ability to produce progenitor cells of the lymphocytic lineage, which is characteristic of primary lymphoid tissues (thymus and bone marrow).

A. Lymph Nodes

The lymph nodes are extremely numerous and disseminated all over the body. They measure 1–25 mm in diameter and play a very important and dynamic role in the initial or inductive states of the immune response.

1. Anatomical Organization

The lymph nodes are circumscribed by a connective tissue capsule. Afferent lymphatics draining peripheral interstitial spaces enter the capsule of the node and open into the subcapsular sinus. The lymph node also receives blood from the systemic circulation through the hilar arteriole. Two main regions can be distinguished in a lymph node: the cortex and the medulla. The cortex and the deep cortex (also known as paracortical area) are densely populated by lymphocytes, in constant traffic between the lymphatic and systemic circulation. In the cortex, at low magnification, one can distinguish roughly spherical areas containing densely packed lymphocytes, termed follicles or nodules (Fig. 2.4).

T and B lymphocytes occupy different areas in the cortex. B lymphocytes predominate in the follicles (hence, the follicles are designated as T-independent area), which also contain macrophages, follicular dendritic cells, and some T lymphocytes. The follicles can assume two different morphologies:

1. The primary follicles are very densely packed with small naive B lymphocytes.
2. In a lymph node draining an area in which an infection has taken place, one will find larger, less dense follicles, termed secondary follicles, containing a dark, packed mantle, where naive B cells predominate, and clear germinal centers where B lymphocytes are actively dividing as a result of antigenic stimulation.

Nonstimulated B cells enter the germinal center by the mantle area of the basal dark zone. In the light zone, B cells interact with antigens retained by the follicular dendritic cells and start to proliferate. The proliferation of B cells in germinal centers is associated

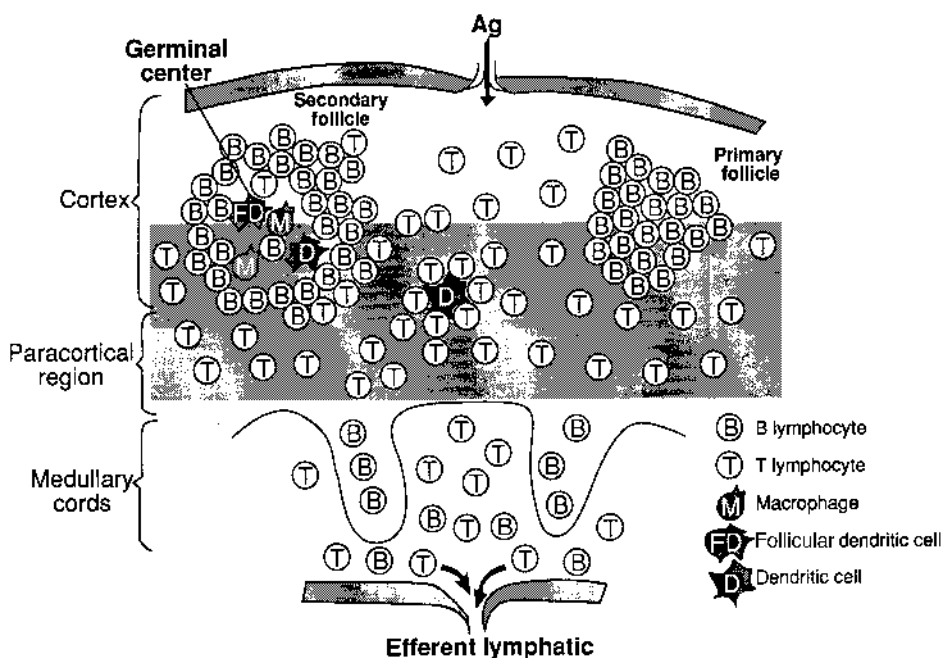

Fig. 2.4 Diagrammatic representation of the lymph node structure. B lymphocytes are predominantly located on the lymphoid follicles and medullary cords (B-dependent areas), while T lymphocytes are mostly found in the paracortical area (T-dependent area).

with phenotypic changes (membrane IgD ceases to be expressed) and with somatic mutations affecting the genes coding for the variable regions of the immunoglobulin molecule (see Chapters 5 and 7). The proliferation and differentiation of B cells continues on the apical light zone, where B lymphocytes eventually differentiate into plasma cells and memory B cells. In humans, both plasmablasts and memory B cells leave the lymph node through the medullary cords. Memory B cells enter recirculation patterns, described later in this chapter. Plasmablasts home to the bone marrow, where they fully differentiate into plasma cells.

In the deep cortex or paracortical area, which is not as densely populated as the follicles, T lymphocytes are the predominant cell population, and for this reason the paracortical area is designated as T-dependent. Dendritic cells are also present in this area, where they present antigen to T lymphocytes.

The medulla, less densely populated, is organized into medullary cords draining into the hilar efferent lymphatic vessels. Plasmablasts can be easily identified in the medullary cords.

2. *Physiological Role*

The lymph nodes can be compared to a network of filtration and communication stations where antigens are trapped and messages are interchanged between the different cells involved in the immune response. This complex system of interactions is made possible by the dual circulation in the lymph nodes. Lymph nodes receive both lymph and arterial blood flow. The afferent lymph, with its cellular elements, percolates from the subcapsular sinus

to the efferent lymphatics via cortical and medullary sinuses, and the cellular elements of the lymph have ample opportunity to migrate into the lymphocyte-rich cortical structures during their transit through the nodes. The artery that penetrates through the hilus brings peripheral blood lymphocytes into the lymph node; these lymphocytes can leave the vascular bed at the level of the high endothelial venules located in the paracortical area.

Thus, lymph nodes can be considered as the anatomical fulcrum of the immune response. Soluble or particulate antigens reach the lymph nodes primarily through the lymphatic circulation. Once in the lymph nodes, antigen is concentrated on the antigen-retaining reticulum formed by the follicular dendritic cells. The antigen is retained by these cells in its unprocessed form, often associated with antibody (particularly during secondary immune responses), and is efficiently presented to B lymphocytes. The B lymphocytes recognize specific epitopes but are also able to internalize and process the antigen, presenting antigen-derived peptides associated to MHC II molecules to helper T lymphocytes, whose "help" is essential for the proper activation and differentiation of the B cells presenting the antigen (see Chapter 4).

B. Spleen

The spleen is an organ with multiple functions. Its protective role against infectious diseases is related both to its filtering functions and to the presence of lymphoid structures able to support the initial stages of the immune response.

1. Anatomical Organization

Surrounded by a connective tissue capsule, the parenchyma of this organ is heterogeneous, constituted by the white and the red pulp. The white pulp is rich in lymphocytes, arranged in periarteriolar lymphatic sheaths that surround the narrow central arterioles, derived from the splenic artery after multiple branchings, and follicles, which lie more peripherally relative to the arterioles (Fig. 2.5). T cells are concentrated in the periarteriolar lymphatic sheaths, whereas B lymphocytes are concentrated in the follicles. The follicles may or may not show germinal centers, depending on the state of activation of the resident cells.

The red pulp surrounds the white pulp. Blood leaving the white pulp through the central arterioles flows into the penicillar arteries and from there directly into the venous sinuses. The red pulp is formed by these venous sinuses which are bordered by the splenic cords (cords of Billroth), where macrophages abound. From the sinuses, blood reenters the systemic circulation through the splenic vein.

Between the white and the red pulp lies an area known as the marginal zone, more sparsely cellular than the white pulp, but very rich in macrophages and B lymphocytes.

2. Physiological Role

The spleen is the lymphoid organ associated with the clearing of particulate matter, infectious organisms, and aged or defective formed elements (e.g., spherocytes, ovalocytes) from the peripheral blood. The main filtering function is performed by the macrophages lining up the splenic cords. In the marginal zone circulating antigens are trapped by the macrophages, which will then be able to trap and process the antigen, migrate deeper into the white pulp, and initiate the immune response by interacting with T and B lymphocytes.

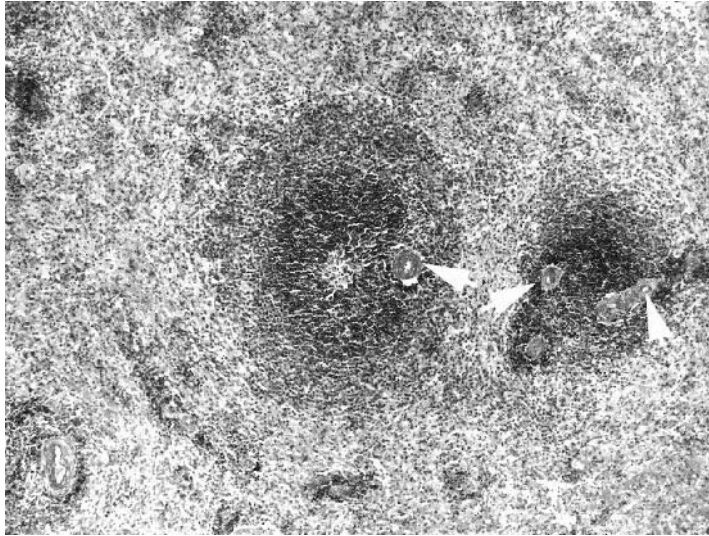

Fig. 2.5 Morphology of the white pulp of the spleen. Lymphoid cells are concentrated around small arterioles (arrows), forming a diffuse periarteriolar lymphoid sheet where T cells predominate and large follicles (as seen in the picture) where B cells predominate. (Image courtesy of Professor Robert W. Ogilvie, Department of Cell Biology and Anatomy, Medical University of South Carolina, Charleston, SC.)

C. Thymus

The thymus is the only clearly individualized primary lymphoid organ in mammals. It is believed to play a key role in determining the differentiation of T lymphocytes.

1. Anatomical Organization

The thymus, whose microscopic structure is illustrated in Fig. 2.6, is located in the superior mediastinum, anterior to the great vessels. It has a connective tissue capsule from which emerge the trabeculae, which divide the organ into lobules. Each lobule has a cortex and medulla, and the trabeculae are coated with epithelial cells.

The cortex, an area of intense cell proliferation, is mainly populated by immunologically immature T lymphocytes. A small number of macrophages and plasma cells are also present. In addition, the cortex contains two subpopulations of epithelial cells, the epithelial nurse cells and the cortical epithelial cells, which form a network within the cortex.

Not as densely populated as the cortex, the medulla contains predominantly mature T lymphocytes, and has a larger epithelial cell-to-lymphocyte ratio than the cortex. Unique to the medulla are concentric rings of squamous epithelial cells known as Hassall's corpuscles.

2. Physiological Role

The thymus is believed to be the organ where T lymphocytes differentiate during embryonic life and thereafter, although for how long the thymus remains functional after birth is unclear (recent data show that 30% of individuals 40 years of age or older retain substantial thymic tissue and function). The thymic cortex is an area of intense cell proliferation

and death (only 1% of the cells generated in the thymus eventually mature and migrate to the peripheral tissues).

The mechanism whereby the thymus determines T-lymphocyte differentiation is believed to involve the interaction of T-lymphocyte precursors with thymic epithelial cells. These interactions result in the elimination or inactivation of self-reactive T-cell clones and in the differentiation of two separate lymphocyte subpopulations with different membrane antigens and different functions. The thymic epithelial cells are also believed to produce hormonal factors (e.g., thymosin and thymopoietin) that may play an important role in the differentiation of T lymphocytes. Most T-lymphocyte precursors appear to reach full maturity in the medulla.

D. Mucosal-Associated Lymphoid Tissues

Mucosal-associated lymphoid tissues (MALT) encompass the lymphoid tissues of the intestinal tract, genito-urinary tract, tracheobronchial tree, and mammary glands. All of the mucosal-associated lymphoid tissues are unencapsulated and contain both T and B lymphocytes, the latter predominating. Gut-associated lymphoid tissue, on the other hand, is the designation proposed for all lymphatic tissues found along the digestive tract. Three major areas of GALT that can be identified are the tonsils, the Peyer's patches (located on the submucosa of the small intestine), and the appendix. In addition, scanty lymphoid tissue is present in the lamina propria of the gastrointestinal tract.

Tonsils, localized in the oropharynx, are predominantly populated by B lymphocytes and are the site of intense antigenic stimulation, as reflected by the presence of numerous secondary follicles with germinal centers in the tonsillar crypts (Fig. 2.7).

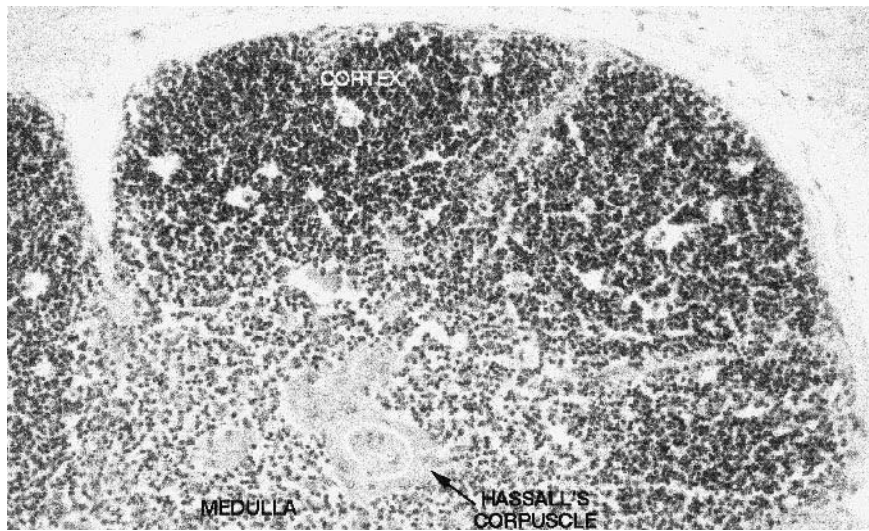

Fig. 2.6 Morphology of a thymic lobe. The densely packed cortex is mostly populated by T lymphocytes and by some cortical dendritic epithelial cells and cortical epithelial cells. The more sparsely populated medulla contains epithelial and dendritic cells, macrophages, T lymphocytes, and Hassell's corpuscles. (Image courtesy of Professor Robert W. Ogilvie, Department of Cell Biology and Anatomy, Medical University of South Carolina.)



Fig. 2.7 Morphology of the tonsils. The lymphoid tissue of these lymphoid organs is mostly constituted by primary and secondary follicles (characterized by the pale germinal centers), the latter predominating, as seen in this picture. The predominant cell population in the tonsillar follicles is B cells. (Image courtesy of Professor Robert W. Ogilvie, Department of Cell Biology and Anatomy, Medical University of South Carolina, Charleston, SC.)

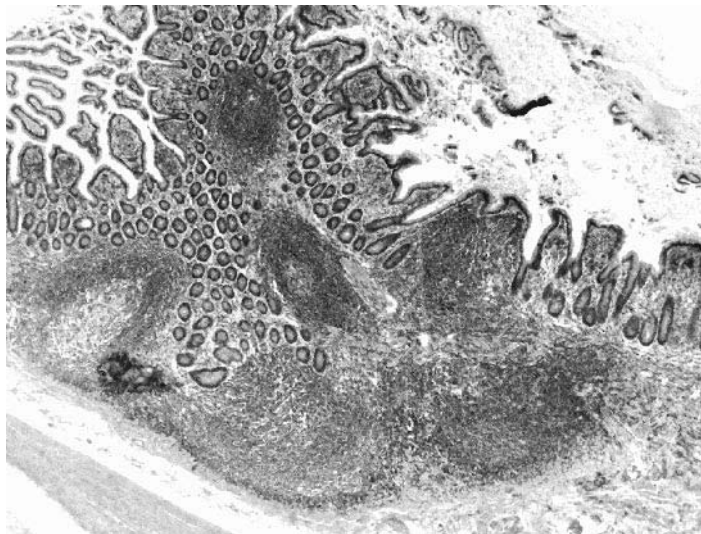

Fig. 2.8 Morphology of a Peyer's patch. Well-developed follicles with obvious germinal centers are characteristic of the normal Peyer's patch. B lymphocytes are the predominant cell population. (Image courtesy of Professor Robert W. Ogilvie, Department of Cell Biology and Anatomy, Medical University of South Carolina, Charleston, SC.)

Peyer's patches are lymphoid structures disseminated through the submucosal space of the small intestine (Fig. 2.8). The follicles of the intestinal Peyer's patches are extremely rich in B cells, which differentiate into IgA-producing plasma cells. Specialized epithelial cells known as M cells abound in the dome epithelia of Peyer's patches, particularly at the ileum. These cells take up small particles (virus, bacteria, etc.) and deliver them to submucosal macrophages, where the engulfed material will be processed and presented to T and B lymphocytes.

T lymphocytes are also diffusely present in the intestinal mucosa, the most abundant of them expressing membrane markers, which are considered typical of memory helper T cells. This population appears to be critically involved in the induction of humoral immune responses. A special subset of T cells, with a different type of T-cell receptor (γ/δ T lymphocytes), is well represented on the small intestine mucosa. These lymphocytes appear to recognize and destroy infected epithelial cells by a nonimmunological mechanism (i.e., not involving the T-cell receptors).

IV. LYMPHOCYTE TRAFFIC

The lymphatic and circulatory systems are intimately related (Fig. 2.9), and there is a constant traffic of lymphocytes throughout the body, moving from one system to another. Afferent lymphatics from interstitial spaces drain into lymph nodes, which "filter" these fluids, removing foreign substances. "Cleared" lymph from below the diaphragm and the upper left half of the body drains via efferent lymphatics, emptying into the thoracic duct for subsequent drainage into the left innominate vein. "Cleared" lymph from the right side above the diaphragm drains into the right lymphatic duct with subsequent drainage into the origin of the right innominate vein. The same routes are traveled by lymphocytes stimulated in the lymph nodes or peripheral lymphoid tissues, which will eventually reach the systemic circulation.

Peripheral blood, in turn, is "filtered" by the spleen and liver, the spleen having organized lymphoid areas while the liver is rich in Kupffer's cells, which are macrophage-derived phagocytes. Organisms and antigens that enter directly into the systemic circulation will be trapped in these two organs, of which the spleen plays the most important role as a lymphoid organ.

A. Lymphocyte Recirculation and Extravascular Migration

One of the most important biological characteristics of B and T lymphocytes is their constant recirculation, entering the lymphoid tissues to circulate through the vascular system, enter again the lymphoid tissues, or exit into the interstitial tissues if an inflammatory reaction is taking place.

Lymphocytes circulating in the systemic circulation eventually enter a lymph node, exit the systemic circulation at the level of the high endothelial venules (HEV), leave the lymph node with the efferent lymph, and eventually reenter the systemic circulation.

B lymphocytes of mucosal origin circulate between different segments of the mucosal-associated lymphoid tissues, including the GALT, the mammary gland-associated lymphoid tissue, and the lymphoid tissues associated with the respiratory tree and urinary tract.

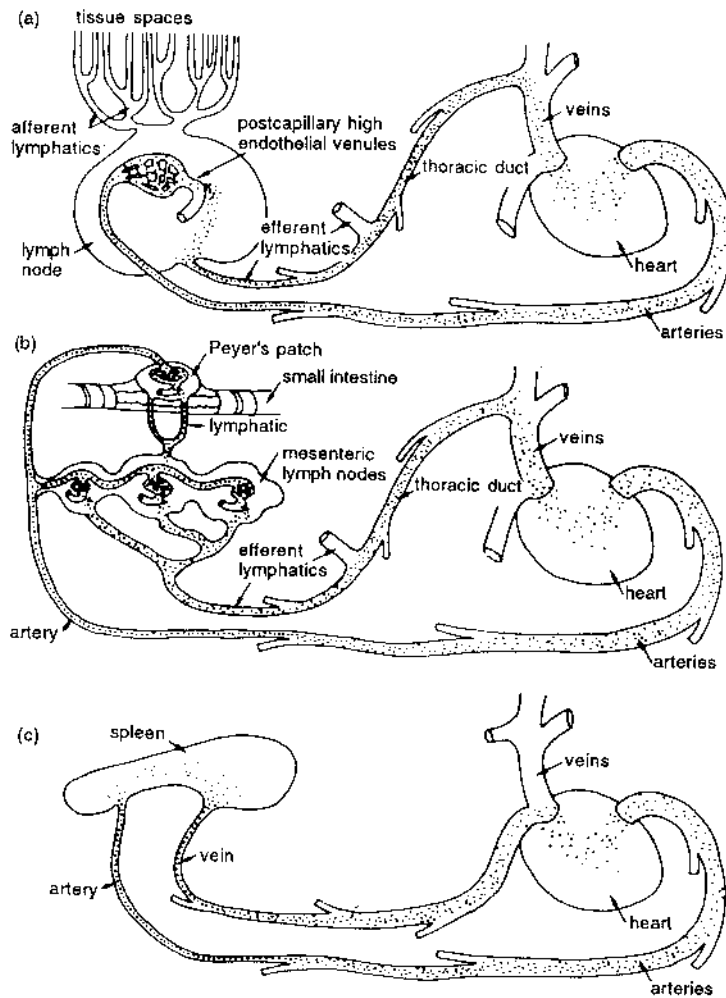

Fig. 2.9 Pathways of lymphocyte circulation: (a) blood lymphocytes enter lymph nodes, adhere to the walls of specialized postcapillary venules, and migrate to the lymph node cortex. Lymphocytes then percolate through lymphoid fields to medullary lymphatic sinuses and on to efferent lymphatics, which in turn collect in major lymphatic ducts in the thorax, which empty into the superior vena cava; (b) the gut-associated lymphoid tissues (Peyer's patches and mesenteric lymph nodes) drain into the thoracic duct, which also empties into the superior vena cava; (c) the spleen receives lymphocytes and disburses them mainly via the blood vascular system (inferior vena cava). (Reproduced with permission from Hood, L. E., Weissman, I. L., Wood, W. B., and Wilson, J. H. *Immunology*, 2nd ed. Benjamin/Cummings, Menlo Park, CA, 1984.)

The crucial step in the traffic of lymphocytes from the systemic circulation to a lymphoid tissue or to interstitial tissues is the crossing of the endothelial barrier by diapedesis at specific locations. Under physiological conditions, this seems to take place predominantly at the level of the high endothelial venules of lymphoid tissues. These specialized endothelial cells express surface molecules—cell adhesion molecules (CAMs)—which interact with ligands, including other cell adhesion molecules, expressed on the membrane of T and B lymphocytes. The interplay between endothelial and lymphocyte CAMs deter-

mines the traffic and homing of lymphocytes. Cell adhesion molecules are also upregulated during inflammatory reactions and determine the extravascular migration of lymphocytes and other white blood cells.

B. Cell Adhesion Molecules

Three main families of cell adhesion molecules have been defined (Table 2.2). The addressins or selectins are expressed on endothelial cells and leukocytes and mediate leukocyte adherence to the endothelium. The immunoglobulin superfamily of CAMs includes a variety of molecules expressed by leukocytes, endothelial cells, and other cells. The integrins are defined as molecules that interact with the cytoskeleton and tissue matrix compounds. The following CAMs have been reported to be involved in lymphocyte traffic and homing:

LAM-1, ICAM-1, and CD44 are primarily involved in controlling lymphocyte traffic and homing in peripheral lymphoid tissues.

MadCAM-1 is believed to control lymphocyte homing to the mucosal lymphoid tissues.

The interaction between adhesion molecules and their ligands takes place in several stages. First, the cells adhere to endothelial cells at the level of the high endothelium venules (HEV), and the adhering lymphocyte is able then to migrate through endothelial slits into the lymphoid organ parenchyma. Different CAMs and ligands are involved in this sequence of events.

C. Regulation of Lymphocyte Traffic and Homing

The way in which cell adhesion molecules regulate lymphocyte traffic and homing seems to be a result both of differences in the level of their expression and of differences in the nature of the CAM expressed in different segments of the microcirculation. The involvement of HEV as the primary site for lymphocyte egress from the systemic circulation is a consequence of the interaction between CD34, a specific CAM expressed in HEV, and L-selectin, expressed by naive T lymphocytes. Because CD34 is predominantly expressed by HEV, the opportunity for cell adhesion and extravascular migration is considerably higher in HEV than on segments of the venous circulation covered by flat endothelium.

It is known that the lymphocyte constitution of lymphoid organs is variable (Table 2.1). T lymphocytes predominate in the lymph nodes, but B lymphocytes and IgA-producing plasma cells predominate in the Peyer's patches and the GALT in general. This differential homing is believed to be the result of the expression of specific addressins such as MadCAM-1 on the HEV of the perimucosal lymphoid tissues, which are specifically recognized by the B cells and plasma cells resident in those tissues. Most B lymphocytes recognize specifically the GALT-associated HEV and do not interact with the lymph node-associated HEV, while most naive T lymphocytes recognize both the lymph node-associated HEV and the GALT-associated HEV.

The differentiation of T-dependent and B-dependent areas in lymphoid tissues is a poorly understood aspect of lymphocyte "homing." It appears likely that the distribution of T and B lymphocytes is determined by their interaction with nonlymphoid cells. For example, the interaction between interdigitating cells and T lymphocytes may determine the predominant location of T lymphocytes in the lymph node paracortical areas and periarteriolar

Table 2.2 Main Adhesion Molecules, Examples of Their Members, and Ligands

Family	Members	Ligand	Function
Selectins	Endothelial-leukocyte adhesion molecule (ELAM-1, E-selectin)	Sialylated/fucosylated molecules	Mediates leukocyte adherence to endothelial cells in inflammatory reactions
	Leukocyte adhesion molecule-1 (LAM-1, L-selectin)	Immunoglobulin superfamily CAMs; mucins and sialomucins	Interaction with HEV (lymphocyte homing); leukocyte adherence to endothelial cells in inflammatory reactions
Immunoglobulin superfamily	Intercellular adhesion molecule-1 (ICAM-1)	LFA-1 (CD11a/CD18), Mac-1 (CD11b)	Expressed by leukocytes, endothelial cells, dendritic cells, etc.; mediates leukocyte adherence to endothelial cells in inflammatory reactions
	ICAM-2	LFA-1	Expressed by leukocytes, endothelial cells, and dendritic cells; involved in control of lymphocyte recirculation and traffic
	Vascular CAM-1 (VCAM-1)	VLA-4	Expressed primarily by endothelial cells; mediates leukocyte adherence to activated endothelial cells in inflammatory reactions
	Mucosal addressin CAM-1 (MadCAM-1)	β_7 , β_4 , L-Selectin	Expressed by mucosal lymphoid HEV; mediates lymphocyte homing to mucosal lymphoid tissues
	Platelet/endothelial CAM-1 (PECAM-1)	PECAM-1	Expressed by platelets, leukocytes, and endothelial cells; involved in leukocyte transmigration across the endothelium in inflammation

Table 2.2 Continued.

Family	Members	Ligand	Function
Integrins			
VLA family	VLA-1 to 6	Fibronectin, laminin, collagen	Ligands mediating cell-cell and cell-substrate interaction
LEUCAM family	LFA-1	ICAM-1, ICAM-2, ICAM-3	Ligands mediating cell-cell and cell-substrate interaction
	Mac-1	ICAM-1, fibrinogen, C3bi	
Other	CD44	Leukocytes, epithelial cells, fibroblasts	Mediates cell-cell and cell-matrix interactions; involved in lymphocyte homing

sheets of the spleen, while the interaction of B lymphocytes with follicular dendritic cells may determine the organization of lymphoid follicles in the lymph node, spleen, and GALT.

The modulation of CAM at different states of cell activation explains changing patterns in lymphocyte recirculation seen during immune responses. Immediately after antigen stimulation, the recirculating lymphocyte appears to transiently lose its capacity to recirculate. This loss of recirculating ability is associated with a tendency to self-aggregate (perhaps explaining why antigen-stimulated lymphocytes are trapped at the site of maximal antigen density), due to the upregulation of CAMs involved in lymphocyte-lymphocyte and lymphocyte-accessory cell interactions.

After the antigenic stimulus ceases, a population of memory T lymphocytes carrying distinctive membrane proteins can be identified. This population seems to have a different recirculation pattern than that of the naive T lymphocyte, leaving the intravascular compartment at sites other than the HEV and reaching the lymph nodes via the lymphatic circulation. This difference in migration seems to result from the downregulation of the CAMs, which mediate the interaction with HEV selectins, and upregulation of other CAMs, which interact with selectins located in other areas of the vascular tree.

B lymphocytes also change their recirculation patterns after antigenic stimulation. Most B cells will differentiate into plasma cells after stimulation, and this differentiation is associated with marked changes in the antigenic composition of the cell membrane. Consequently, the plasma cell precursors (plasmablasts) exit the germinal centers and move into the medullary cords and, eventually, to the bone marrow, where most of the antibody production in humans takes place. Another B-cell subpopulation—the memory B cells—retain B cell markers and reenter the circulation to migrate back to specific territories of the lymphoid tissues.

All memory lymphocytes, T or B, appear to home preferentially in on the type of lymphoid tissue where the original antigen encounter took place, i.e., a lymphocyte that recognizes an antigen in a peripheral lymph node will recirculate to the same or another peripheral lymph node, while a lymphocyte that is stimulated at the GALT level will recirculate to the GALT. Memory B lymphocytes remain in the germinal centers, while memory T lymphocytes home in on T-cell areas.

Inflammatory and immune reactions often lead to the release of mediators that up-regulate the expression of CAM in venules or in other segments of the microvasculature near the area where the reaction is taking place. This results in a sequence of events that is mediated by different sets of CAMs and their respective ligands.

First the leukocytes slow down and start rolling along the endothelial surface. This stage is mediated primarily by selectins. Next, leukocytes adhere to endothelial cells expressing integrins such as VLA and CAMs of the immunoglobulin superfamily, such as ICAM and VCAM. Finally, the adherent leukocytes squeeze between two adjoining endothelial cells and move to the extravascular space.

The end result of this process is an increase in leukocyte migration to specific areas where those cells are needed to eliminate some type of noxious stimulus or to initiate an immune response. As a corollary, there is great interest in developing compounds able to block upregulated CAMs to be used as anti-inflammatory agents.

SELF-EVALUATION

Questions

Choose the one *best* answer.

- 2.1 A patient born without the human bursa equivalent would be expected to have normal:
 - A. Cellularity in the paracortical areas of the lymph nodes
 - B. Differentiation of germinal centers in the lymph nodes
 - C. Numbers of circulating lymphocytes bearing surface immunoglobulins
 - D. Numbers of plasma cells in the bone marrow
 - E. Tonsils
- 2.2 Which one of the following anatomical regions is most likely to show a predominance of T lymphocytes?
 - A. A periarteriolar sheet in the spleen
 - B. A Peyer's patch in the small intestine
 - C. A tonsillar follicle
 - D. The bone marrow
 - E. The germinal center of a lymph node follicle
- 2.3 The role of selectins in the microvasculature is to:
 - A. Attract lymphocytes to the extravascular compartment in specific tissues
 - B. Mediate the adhesion of leukocytes to endothelial cells
 - C. Promote cell-cell interaction in the lymphoid tissues
 - D. Promote trapping of antigen in the antigen-retaining reticulum
 - E. Regulate blood flow in or out of specific areas of the organism

Match the listed properties and characteristics in Questions 2.4–2.10 with the right type of lymphocytes

- A. B lymphocytes
 - B. T lymphocytes
 - C. Follicular dendritic cells
 - D. Neutrophils
 - E. Plasma cells
- 2.4 The predominant cells in the follicles and germinal centers of the lymph nodes

- 2.5 Release perforins and granzymes
- 2.6 Recirculate between different segments of the GALT
- 2.7 Circulating phagocytes that do not express MHC II
- 2.8 Concentrate antigen on their surface
- 2.9 Migrate to the bone marrow after proliferation and differentiation in the lymph node
- 2.10 Produce and secrete large amounts of immunoglobulins

Answers

- 2.1 (A) The lack of a bursal equivalent would result in virtually no differentiation of B lymphocytes and plasma cells, and this would be reflected in the peripheral blood and B-cell-rich lymphoid tissues. However, the paracortical areas of the lymph nodes are mostly populated by T cells and as such would not be affected.
- 2.2 (A)
- 2.3 (B) Selectins are surface receptors expressed in endothelial cells that are recognized by specific ligands on leukocytes. Their physiological function is to promote adhesion of circulating leukocytes to the endothelial cells, initiating a sequence of interactions that eventually results in the “homing” of the circulating cell into a given lymphatic tissue. The actual migration of lymphocytes out of the vessel wall requires firm attachment mediated by additional cell adhesion molecules and the release of chemoattractant cytokines in the extravascular compartment.
- 2.4 (A)
- 2.5 (B) Cytotoxic T lymphocytes mediate their function through several mechanisms, one of which involves the release of perforins and granzymes.
- 2.6 (A)
- 2.7 (D)
- 2.8 (C)
- 2.9 (E)
- 2.10 (E) Immunoglobulin secretion is a property of the plasma cell that, although derived from B lymphocytes, has unique functions and membrane markers.

BIBLIOGRAPHY

- Berke, G. The CTL's kiss of death. *Cell*, 81:9, 1995.
- Bevilaqua, M. P. Endothelial-leucocyte adhesion molecules. *Annu. Rev. Immunol.*, 11:767, 1993.
- Blumberg, R. S., Yockey, C. E., Gross, G. C., et al. Human intestinal intraepithelial lymphocytes are derived from a limited number of T cell clones that utilize multiple V beta T cell receptor genes. *J. Immunol.*, 150:5144, 1993.
- Bottomly, K. T cells and dendritic cells get intimate. *Science*, 283:1124, 1999.
- Camerini, V., Panwala, C., and Kronenberg, M. Regional specialization of the mucosal immune system. Intraepithelial lymphocytes of the large intestine have a different phenotype and function than those of the small intestine. *J. Immunol.*, 151:1765, 1993.
- Collins, T. Adhesion molecules and leukocyte emigration. *Science Med.*, 2(6):28–37, 1995.
- Dustin, M. L., and Springer, T. A. Role of lymphocyte adhesion receptors in transient interactions and cell locomotion. *Annu. Rev. Immunol.* 9:27, 1991.

- Fujihashi, K., Yamamoto, M., McGhee, J. R., and Kiyono, H. Function of α/β TCR⁺ and γ/δ TCR⁺ IELs for the gastrointestinal immune response. *Int. Rev. Immunol.*, 11:1, 1994.
- Garside, P., Ingulli, E., Merica, R. R., et al. Visualization of specific B and T interactions in the lymph node. *Science*, 281:96, 1998.
- JunMichl, J., Qiu, Q. Y., and Kuerer, H.M. Homing receptors and addressins. *Curr. Opin. Immunol.* 3:373, 1991.
- Klaus, G. G. B., Humphrey, J. H., Kunkl, A., and Dongworth, D. W. The follicular dendritic cell: its role in antigen presentation in the generation of immunological memory. *Immunol. Rev.* 53:3, 1980.
- MacLennan, I. C. M. Germinal centers. *Annu. Rev. Immunol.*, 12:117, 1994.
- Pellas, T. C., and Weiss, L. Migration pathways of recirculating murine B cells and CD4⁺ and CD8⁺ T lymphocytes. *Am. J. Anat.*, 187:355, 1990.
- Picker, L. J. and Butcher, E. C. Physiological and molecular mechanisms of lymphocyte homing. *Annu. Rev. Immunol.*, 10:561, 1992.

3

Major Histocompatibility Complex

Jean-Michel Goust

I. INTRODUCTION

Grafting of tissues or organs between genetically unrelated individuals is inevitably followed by rejection of the grafted tissue or organ. On the other hand, if tissues or organs are transplanted between genetically identical individuals, rejection does not take place. The understanding of the factors controlling rejection became possible after inbred strains of mice became available. Inbred strains are obtained after 20 or more generations of brother/sister mating and for all purposes are constituted by genetically identical animals. The use of these animals made it possible to prove that graft rejection is under genetic control, and that is subject to general immunological rules, i.e., specificity and memory.

The genetic control of graft rejection became obvious in experiments in which skin was transplanted among laboratory animals of the same or different inbred strains. When skin was grafted among animals of the same inbred strain, no rejection was observed. When grafting involved mice of different strains, the recipient animals rejected the graft, but the speed and intensity of the rejection reaction were clearly dependent on the degree of genetic relatedness between the strains used in the experiment.

Further understanding of the genetic regulation of graft rejection was obtained in studies involving first-generation hybrids (F1 hybrids) produced by mating animals of two genetically different strains. Such hybrids did not reject tissue from either parent, while the parents reject skin from the hybrids. The acceptance of tissues from both parental strains by F1 hybrids of two inbred strains was explained by the development of tolerance to all paternal and maternal specificities expressed by the hybrids during embryonic differentiation. On the other hand, animals of the parental strains rejected tissues from the hybrids be-

cause those tissues express histocompatibility determinants of the other nonidentical strain to which they were not tolerant. Another important conclusion from these experiments was that the histocompatibility determinants are co-dominantly expressed.

Further studies, diagrammatically summarized in Figure 3.1, showed that graft rejection shares two important characteristics with the classical immune responses: specificity and memory. Animals repeatedly grafted with skin from a donor of one given strain show accelerated rejection, but if they receive a skin graft from an unrelated strain, the rejection time is as long as that observed in a first graft.

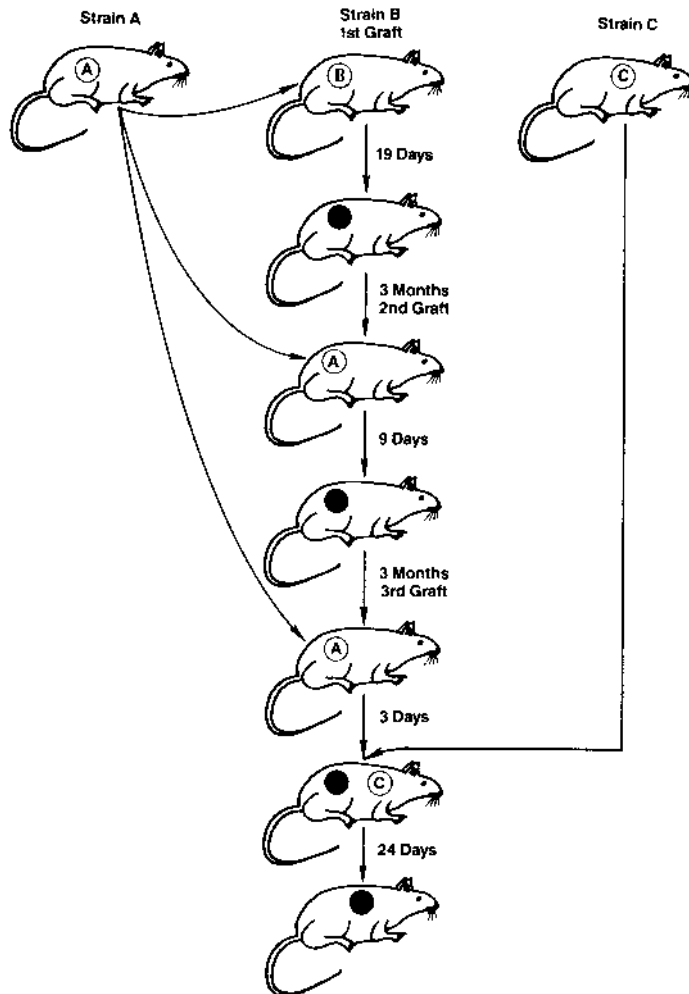

Fig. 3.1 Diagrammatic representation of an experiment designed to demonstrate the memory and specificity of graft rejection. Memory is demonstrated by the progressive shortening of the time it takes a mouse of strain B to reject consecutive skin grafts from a strain A. Specificity is demonstrated by the fact that the mouse of strain B is already able to reject a graft from strain A in an accelerated fashion, and if given a graft from a third, unrelated strain (C), rejection will take as long as the rejection of the first graft from strain A. In other words, sensitization of mouse B to strain A was strain-specific and did not extend to unrelated strains.

With time, it also became clear that the antigens responsible for graft rejection are expressed in most cells and tissues. Laboratory animals receiving skin grafts from animals of the same species but of a different strain developed antibodies that reacted specifically with skin and peripheral blood lymphocytes of the donor strain. These findings pointed to the sharing of antigens by different tissues of the donor animal. This possibility was confirmed through reverse immunizations in which mice preinjected with lymphocytes obtained from a different strain would show accelerated rejection of a skin graft taken from the animals of the same strain from which the lymphocytes were obtained. It is now well established that most nucleated cells of the organism express the antigens responsible for rejection, which are designated as histocompatibility antigens.

II. THE MAJOR HISTOCOMPATIBILITY COMPLEX

A. General Concepts

After many years of detailed genetic analysis, it became clear that the system that determines the outcome of a transplant is complex and highly polymorphic. It was also determined that this system contained antigens of variable strength. The major antigens are responsible for most graft rejection responses and trigger a stronger immune response than others, which are designated as minor. The aggregate of major histocompatibility antigens is known as the major histocompatibility complex (MHC). All mammalian species express MHC antigens on their nucleated cells.

B. The Human MHC: Human Leukocyte Antigens

Historically, the human histocompatibility antigens were defined after investigators observed that the serum of multiparous women contained antibodies agglutinating their husbands' lymphocytes. These leukoagglutinins were also found in the serum of multitransfused individuals, even when the donors were compatible with the transfused individual for all the known blood groups. The antigens responsible for the appearance of these antibodies were thus present on leukocytes and received the designation of human leukocyte antigens (HLA).

It soon became apparent that the immune response of an individual to the HLA antigens of another individual was responsible for the rejection of tissues grafted between genetically unrelated individuals (see Chapter 25). The study of HLA antigens received its initial impetus from the desire to transplant tissues with minimal risk of rejection and from their interest to geneticists as one of the most polymorphic antigenic systems in humans.

It took several decades for a wider picture of the biological significance of HLA antigens to become obvious. Today we know that these molecules are at the very core of the immune response and at the basis of the establishment of tolerance (lack of response) to self antigens, discussed later in this chapter (see also Chapters 4 and 16).

III. CLASSIFICATION, STRUCTURE, AND DETECTION OF HLA GENES AND GENE PRODUCTS

A. MHC and HLA Classes

Six different loci of the HLA system have been identified and are divided in two classes (Table 3.1). Homologous MHC classes have been defined in other mammalian species.

Table 3.1 The Main Characteristics of MHC Antigen Classes

Characteristics	Class I	Class II
Major loci (mouse)	K, D, L	I (-A, -E)
Major loci (man)	A, B, C	DP, DQ, DR
No. of alleles	>100	>20
No. of specificities	>100	>100
Distribution of gene products	All nucleated cells	Monocytes, macrophages, B lymphocytes

MHC class I includes three major loci (HLA-A, HLA-B, HLA-C) and four minor loci (HLA-E, F, G, and H). Each locus has multiple serologically defined alleles, ranging from 8 in the case of HLA-C to more than 30 in the case of HLA-B. Each allele is designated by a number (e.g., HLA-B27). MHC class II antigens are equally polymorphic and include three main loci (HLA-DP, HLA-DQ, and HLA-DR) and less well-defined loci (HLA-DM, -DN, and -DO).

B. Structure of the MHC Antigens

1. Class I MHC Molecules

The HLA or H2 molecules coded by MHC class I genes have molecular weights which may vary from 43,000 to 48,000 and are formed by two nonidentical polypeptide chains. The major chain (α chain) has a long extracellular region folded in three domains— α_1 , α_2 , and α_3 . The extracellular domains are attached to a short transmembrane, hydrophobic region of 24 amino acids and an intracytoplasmic “tail” composed of about 30–35 amino acids, which includes the carboxyl terminus attached to cytoskeletal structures. β_2 -Microglobulin, a 12,000-dalton protein coded by a gene located on chromosome 15, is postsynthetically and noncovalently associated with the major polypeptide chain.

The comparison of amino acid sequences and nucleotide sequences of the various domains of class I MHC shows that the α_1 and α_2 domains are highly variable and that most of the amino acid and nucleotide changes responsible for the differences between alleles occur in these domains. It also shows areas in these domains which are relatively constant and closely related in different alleles. This explains why polyclonal antibodies raised against MHC molecules can recognize several of them, an occurrence designated as the existence of “public” specificities, as opposed to the “private” specificities unique to each different allele.

X-ray crystallography studies have determined the tridimensional structure of the HLA class I molecules (Fig. 3.2) and clarified the relationship between the structure and the function of this molecule. The most polymorphic areas of the molecule are located within and on the edges of a groove formed at the junction of the helical α_1 and α_2 domains. This groove is usually occupied by a short peptide (10–11 residues), usually of endogenous origin. The α_3 domain shows much less genetic polymorphism and, together with β_2 -microglobulin, are like a frame supporting the deployment in space of the more polymorphic α_1 and α_2 domains. In addition, the α_3 domain has a binding site for the CD8 molecule characteristic of cytotoxic T cells (see Chapters 4, 10, and 11).

2. Class II MHC Molecules

Although a remarkable degree of tertiary structure homology seems to exist between class I and class II gene products (Fig. 3.3), there are important differences in their primary structure. First, class II gene products are not associated with β_2 -microglobulin. The MHC II molecules consist of two distinct polypeptide chains, a β chain (MW 28,000), which expresses the greatest degree of genetic polymorphism, and a less polymorphic, heavier chain (α chain, MW 33,000). Each polypeptide chain has two extracellular domains (α_1 and α_2 ; β_1 and β_2), a short transmembrane domain, and an intracytoplasmic tail. The NH_2 terminal ends of the terminal α_1 and β_1 domains contain hypervariable regions.

The three-dimensional structure of class II antigens has also been established. The β_1 domains of class II MHC antigens resemble the α_2 domain of their class I counterparts. The junction of α_1 and β_1 domains forms a groove similar to the one formed by the α_1 and α_2 domains of class I MHC antigens, which also binds antigen-derived oligopeptides (usually

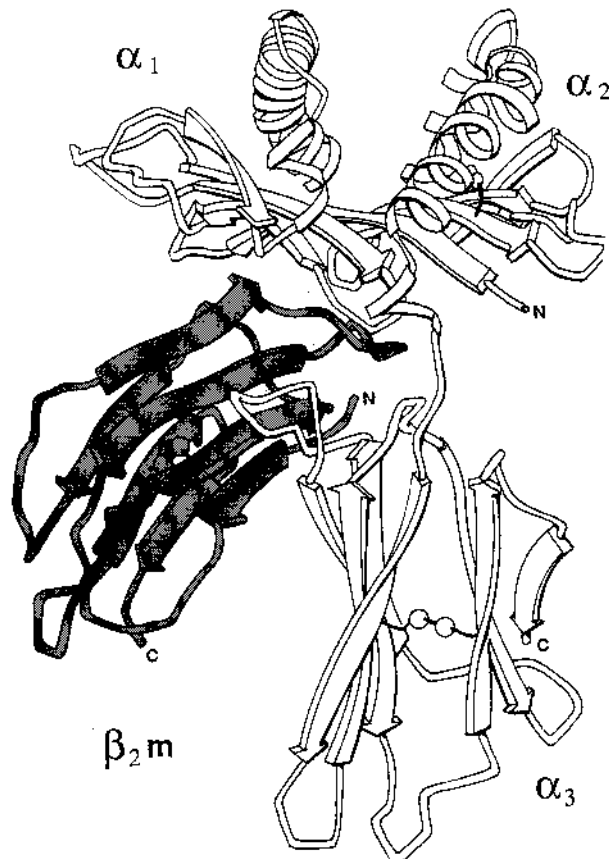

Fig. 3.2 Schematic representation of the spatial configuration of the HLA-A2 molecule, based on x-ray crystallography data. The diagram shows the immunoglobulin-like domains (α_3 , β_{2m}) at the bottom and the polymorphic domains (α_1 , α_2) at the top. The indicated C terminus corresponds to the site of papain cleavage; the native molecule has additional intramembrane and intracellular segments. The α_1 and α_2 domains form a deep groove, which is identified as the antigen recognition site. (Modified from Bjorkman, P. J., et al. *Nature*, 329:506, 1987.)

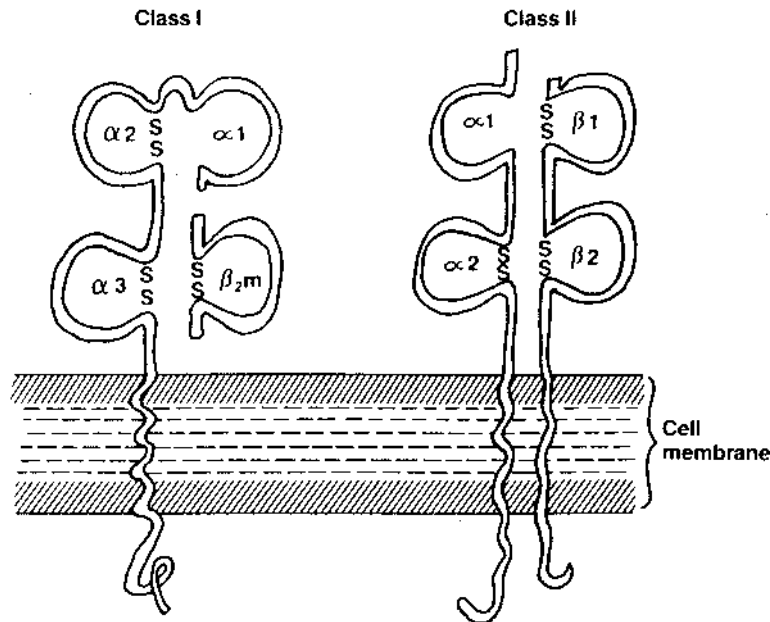

Fig. 3.3 Diagrammatic representation of the structure of human class I and class II histocompatibility antigens. (Modified from Hood, L. E., et al. *Immunology*, 2nd ed. Benjamin/Cummings, Menlo Park, CA, 1984.)

of exogenous origin), but it is longer than the groove of MHC-I, indicating that the peptides bound to it are longer.

The β_1 domain also contains two important sites located below the antigen-binding site. The first acts as a receptor for the CD4 molecule of helper T lymphocytes (see Chapters 4, 10, and 11). The second site, which overlaps the first, is a receptor for the envelope glycoprotein (gp 120) of the human immunodeficiency virus (HIV).

C. Identification of HLA Antigens

The different alleles of each locus are recognized by two major techniques. The serological technique, which is the oldest and most widely used, is based on the lymphocytotoxicity of anti-HLA antibodies of known specificity in the presence of complement. The antibodies used for HLA typing were initially obtained from multiparous females or from recipients of multiple transfusions. Such antibodies are still in use, but monoclonal antibodies (see Chapter 10) have also been raised against HLA specificities. These antibodies identify several groups of HLA that are therefore designated as serologically defined.

At this point it is important to note that not all HLA specificities have been defined. Some individuals express unknown specificities at some loci (usually class II), which the typing laboratory reports as "blank." Investigation of these "blank" specificities often leads to the discovery of new HLA antigens. To avoid unnecessary confusion, they are assigned a numerical designation by regularly held workshops of the World Health Organization. At first, the designation is preceded by a w, indicating a provisional assignment. For example, DQw3 designates an antigenic specificity of the DQ locus that has been tentatively designated as w3 by a workshop. When worldwide agreement is reached about the fact that this is a new specificity, the w is dropped.

Hybridization with sequence-specific oligonucleotides is particularly useful for typing MHC-II specificities. A very large number of complete DNA sequences of class I and class II alleles have been determined. In the case of MHC-I molecules all alleles correspond to variations in the α chains, because β_2 -microglobulin is identical in all MHC-I molecules. In the case of HLA-DR molecules the α chain is invariant but the β -chain genes are extremely polymorphic. In contrast, HLA-DP and DQ molecules have polymorphic α and β chains, thus being much more diverse than the DR molecules. As the sequences of HLA genes became known, it became possible to produce specific probes for different alleles. Typing usually involves DNA extraction, denaturation into single-stranded DNA, fragmentation with restriction enzymes, amplification by polymerase chain reaction (PCR), and finally hybridization with labeled cDNA probes specific for different alleles of the corresponding genes.

At the present time two partially overlapping sets of HLA alleles have been defined. One is serologically typed; the other is identified by nucleotide sequence. In the case of HLA-A, B, C, and DR, most nucleotide-defined alleles are subsets of the serologically defined ones. In the case of HLA-DP and DQ, half or more of the nucleotide-defined alleles do not have a known serological counterpart. The nomenclature of the nucleotide-defined alleles is somewhat confusing, although it obeys simple rules. For example, nucleotide-defined alleles of HLA-A1 are designated as HLA A*0101 and *0102, while nucleotide-defined alleles of HLA-B7 are designated as HLA-B*0702-*0706. In the case of DQ and DP the nomenclature identifies both the polypeptide chain where the nucleotide sequence has been identified and the serological corresponding marker, if defined. For example, the HLA-DQB1*0501 allele is a nucleotide-defined allele associated with the β chain of the serologically defined DQ5 allele.

IV. CELLULAR DISTRIBUTION OF THE MHC ANTIGENS

Class I MHC molecules (HLA-A, B, and C alleles in humans and H2-K, D, and L alleles in mice) are expressed on all nucleated cells with only two exceptions: neurons and striated muscle cells. They are particularly abundant on the surface of lymphocytes (1,000–10,000 molecules/cell).

Class II MHC molecules (the I-A and I-E alleles of the mouse H2 complex and the DP, DQ, and DR alleles of the human HLA system) are exclusively expressed in two groups of leukocytes: B lymphocytes and cells of the monocyte-macrophage family, which includes all antigen-presenting cells (Langerhans cells in the skin, Kupffer cells in the liver, microglial cells in the central nervous system, and dendritic cells in the spleen and lymph nodes). While resting T lymphocytes do not express MHC-II molecules, these antigens can be detected after cell activation. Several other types of cells have been shown to express MHC after activation. It must be stressed that all cells expressing class II MHC simultaneously express class I MHC.

V. CHROMOSOMAL LOCALIZATION AND ARRANGEMENT OF THE MHC GENES

The mapping of the MHC region has been established based on the study of crossover gene products and on in situ hybridization studies with DNA probes. The MHC genes are located on chromosome 6 of humans and on chromosome 17 of the mouse. In both cases, the MHC

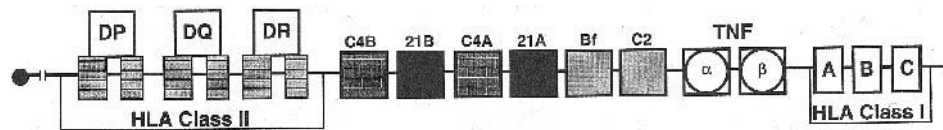

Fig. 3.4 Simplified map of the region of human chromosome 6 where the HLA locus is located. The genes for 21 α - and 21 β -hydroxylase and for tumor necrosis factors (TNF) α and β (lymphotoxin- α) have also been located to chromosome 6 but are not considered as part of the HLA complex.

genes are located between the centromere and the telomere of the short arm of the respective chromosomes. A simplified map of human chromosome 6 is shown in Fig. 3.4.

The MHC genes can be grouped in the same classes as the antigens detected in cell membranes, i.e., MHC class I and class II genes. The MHC region occupies 0.5 (mice) and 1.8 centimorgans (humans) of their respective chromosomes. The larger size of the human HLA region suggests that it includes more genes and is more polymorphic than the murine H2.

In mice, the H2-K locus and the H2-L/H2-D loci (class Ia genes) are the most polymorphic. In contrast, class Ib genes—which include H2M3 and Qa1—are much less polymorphic and devoted to the presentation of formylated peptides (H2M3) or peptides derived from the signal sequence of MHC molecules (Qa1). They are followed by the I region, which includes two loci: I-A and I-E (class II genes). One related locus (locus S) codes for the C4 molecule of the complement system and is located between the H-2K and H-2D loci.

The organization of the HLA gene complex in humans is similar. The class I genes are also divided into two groups: Ia, which includes the polymorphic HLA-A and B genes and the less polymorphic HLA-C, and group Ib, which includes HLA-E-F and G, which are almost monomorphic. Furthermore, in humans the class II genes are closer to the GLO1 locus (coding for one isoenzyme of glyoxylase) and followed by several loci coding for proteins related to the complement cascade such as Bf, C2, and C4 and by the HLA, B, and C loci (class I genes). The human MHC region includes other non-MHC genes such as those coding for tumor necrosis factor (TNF) and lymphotoxin- α (LT- α , TNF- β) (see Chapter 11), which are located near the C4 genes. The two C4 alleles are separated from each other by the genes coding for the enzyme 21 α -hydroxylase (Fig. 3.4). In addition, the MHC-II region includes genes that code for proteins involved in cleaving and loading peptides into MHC molecules (see Chapter 4). The complete sequence of the 3.6 Mb of the human MHC on chromosome 6p21.31 was published at the end of 1999. In addition to the previously identified 200 loci, sequence analysis revealed many genes of yet unknown significance in the flanking regions of class I, class II. It also stressed that the content of immune-related genes in the MHC region is 39.8%.

VI. GENETICS OF THE MHC

The key concept that needs to be stressed is that the MHC is an extremely polymorphic antigenic system. As a consequence of the multiplicity of alleles for the different MHC antigens, there is only an extremely remote chance that two unrelated humans will be found who share an identical set of MHC antigens. Therefore, the MHC antigens are alloantigens (from the Greek *allos*, different) distinguishing individuals within a given species. This is

the basis for their use as genetic markers, which found a major practical application in paternity studies before DNA analysis became commonplace, and at the same time is the major obstacle to organ and tissue transplantation.

Each antigenic specificity of any given MHC locus is determined by one structural gene. For each MHC locus, a given individual carries two structural genes: one inherited with the paternal chromosome and the other inherited with the maternal chromosome. Each chromosome, on the other hand, contains one set of structural genes coding for all the possible MHC molecules. The set of alleles that an individual carries at each locus on a single chromosome forms the haplotype, transmitted as a single unit except in very rare cases of recombination within the complex. Haplotypes can only be determined by family studies, which establish which MHC specificities are “linked,” i.e., transmitted as a bloc in a single chromosome.

For each MHC locus, a given individual may be homozygous or heterozygous. In homozygous individuals both chromosomes carry the same structural gene for that locus, and the cells of the individual express one single antigenic specificity (e.g., an individual homozygous for HLA-B27 carries two genes for the B27 specificity, one in each chromosome). Most individuals are heterozygous for any given locus and will express the two specificities inherited from each parent, encoded by the two DNA strands of the same chromosome. For example, a heterozygous B8/B27 individual will have a gene coding for B8 in one chromosome and a gene coding for a B27 in the other. Both specificities for each locus are expressed by every single cell of this heterozygous individual (although the level of expression may vary depending on the marker). Therefore, the MHC genes are co-dominant at the cellular level, and there is no allelic exclusion in their expression, contrary to what is observed in the case of immunoglobulin genes (see Chapter 7).

Because all the alleles of any individual are co-dominant, it follows that both haplotypes that form an individual genotype will be expressed in the cells of that individual. The sum of all the specificities coded by the genome of the individual is known as that individual's phenotype. An example of the notation of a given individual's phenotype is as follows: HLA-A1,2; B8,27; Dw3,-; DR23,-. The hyphen indicates that only one antigen of a particular locus can be typed; this can signify that the individual is homozygous or that he or she possesses an antigen that cannot be typed because no appropriate reagents are available. Family studies are the only way to distinguish between these two possibilities. Figure 3.5 shows an example of haplotype inheritance within the HLA complex in humans, illustrating the fact that the haplotypes are transmitted, as a rule, as single units following the rules of simple Mendelian heredity. This rule is broken in cases of recombination between the paternal and maternal chromosomes.

In an outbred population in which mating takes place at random, the frequency of finding a given allele at one HLA locus associated with a given allele at a second HLA locus should simply be the product of the frequencies of each individual allele in the population. However, certain combinations of alleles (i.e., certain haplotypes) occur with a higher frequency than expected. Thus, many HLA antigens occur together on the same chromosome more often than is expected by chance. This phenomenon is termed “linkage disequilibrium.” As an example, the HLA-A1 allele is found in the Caucasian population with a frequency of 0.158, and the HLA-B8 allele is found with a frequency of 0.092. The A1, B8 haplotype should therefore be found with a frequency of $0.158 \times 0.092 = 0.015$. In reality, it is found with a frequency of 0.072. The linkage disequilibrium is expressed as the difference (Δ) between the observed and expected frequencies of the alleles, i.e., $0.072 - 0.015 = 0.057$.

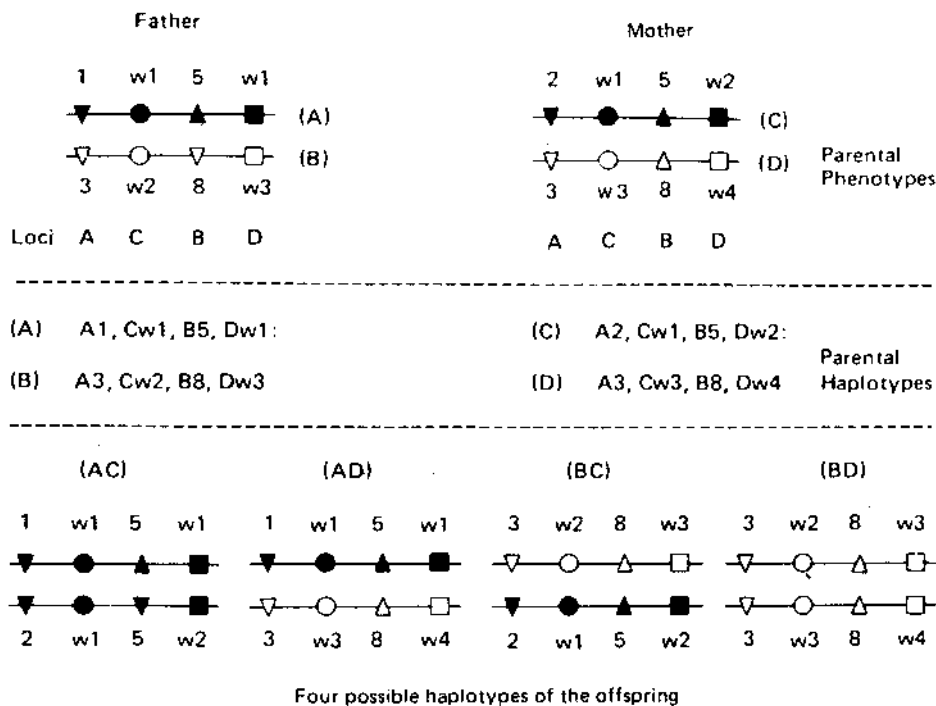

Fig. 3.5 Diagrammatic representation of the genetic transmission of HLA haplotypes. Each parent has two haplotypes (one in each chromosome). Paternal haplotypes are designated A and B and maternal haplotypes C and D. Each offspring has to receive one paternal haplotype and one maternal haplotype. In a large family, 25% of the children share both haplotypes, 50% share one haplotype, and 25% have no haplotype in common. (Reproduced with permission from Hokama, Y., and Nakamura, R. M. *Immunology and Immunopathology*, Little, Brown, Boston, 1982.)

VII. THE MHC COMPLEX AND THE IMMUNE RESPONSE

A. MHC Restriction of Cytotoxic T Lymphocytes

As detailed studies of the immune responses to viruses increased in sophistication, it became evident that the immune system relies on cytotoxic T lymphocytes to destroy viral-infected cells and in this way to curtail viral replication and spread. An unexpected observation was that CD8⁺ cytotoxic T lymphocytes would only kill viral-infected cells if both (the cytotoxic T cell and the infected cell) shared identical class I MHC antigens. The specificity of the cytotoxic reaction is directed to a specific configurational determinant formed by the association of a viral oligopeptide with an autologous MHC-I molecule. Cells infected by the same virus but expressing different MHC-I molecules will present a different MHC-I-oligopeptide complex, not recognizable by a cytotoxic T cell from an animal expressing a different set of MHC-I molecules. Thus, cytotoxicity mediated by T lymphocytes is MHC-restricted and the MHC-I molecules are the "restricting element."

The restriction of cytotoxic reactions represents an adaptation of the immune system to the need to differentiate "normal" cells from cells altered as a consequence of intracellular infections. The elimination of "nonself" material requires the recognition of nonself antigenic structures and the induction of an immune response through a set of cell-cell in-

teractions involving macrophages, T lymphocytes, and B lymphocytes. The effector mechanisms responsible for elimination of “nonself” may be mediated by antibodies or by cytotoxic T cells. Viruses and other intracellular parasites present a special problem to the immune system due to their shielding from contact with immunocompetent cells recognizing antigenic structures on the infectious agent itself. What the immune system eventually developed was the ability to recognize and destroy infected cells. This process has to involve the recognition of antigenic markers related to the infectious agent by the immune system. As discussed in greater detail in Chapter 4, this is explained by the fact that oligopeptides derived from nonself proteins coded by intracellular infectious agents become associated with MHC molecules and are transported to the cell membrane. Specific resting T cells able to recognize the MHC-oligopeptide complexes (“modified” self in the sense that part of the antigen is self and part is not) become activated and differentiate into cytotoxic cells. For the differentiated cytotoxic T cells to be able to recognize and kill a modified cell, they have to interact with cells expressing the same exact match of MHC and peptide and, hence, the restricting nature of the MHC molecule.

The loading of peptides into MHC-I molecules is an extremely complex process. To reach the cell membrane in a stable configuration, the MHC molecule must always be loaded with a peptide. In the absence of intracellular infection, peptides derived from autologous proteins occupy the peptide-binding groove, and these fail to elicit an immune response by the fact that they are self peptides. During an infection, proteins synthesized by a replicating intracellular infectious agent are first cut by a proteasome—a multisubunit proteolytic enzyme that yields fragments of 7–15 amino acids. The peptides are subsequently transported to the endoplasmic reticulum (ER) by molecules known as transporters associated with antigen processing (TAP), which are located within the MHC. Once in the ER, the transported peptides replace endogenous peptides bound to newly synthesized MHC molecules and the complex is transported to the cell membrane, allowing the immune system to recognize the self MHC-I–nonself peptide complex (see Chapters 4 and 10).

B. MHC-II and Antigen Presentation to Helper T Lymphocytes

T lymphocytes cannot respond to unmodified antigens. Their activation usually requires endocytosis and processing of the antigen by a specialized antigen-presenting cell (APC). During “processing,” soluble antigens are broken down into peptides of 12–23 amino acids, which become associated in the cytoplasm with newly synthesized MHC-II molecules (the groove of the HLA class II dimer is longer than the groove of MHC-I molecules and accommodates slightly larger oligopeptides). The peptide–MHC-II complex is then transported across the cytoplasm and inserted in the cell membrane. The MHC-II–associated peptides can be recognized by CD4⁺ helper T lymphocytes carrying a peptide-specific T-cell receptor (TcR) but are not recognized by TCR on CD8⁺ lymphocytes (see Chapters 4, 10, and 11). All cells able to synthesize and express MHC-II molecules can function as antigen-presenting cells.

C. Regulation of MHC Expression

The rules concerning MHC-I and MHC-II expression by different cell populations are mainly true for resting cells. Activated leukocytes and nonleukocytic cells may express MHC molecules at higher levels than resting cells or even express MHC molecules normally not expressed in their resting counterparts. Interferons play a crucial role in upregu-

lating MHC expression. Class I interferons (α/β) primarily increase the expression of MHC-I molecules, whereas Class II interferon (γ) upregulates the expression of MHC-II molecules.

Increased expression of MHC molecules on cell membranes requires prior peptide loading of these molecules. Interferons seem to stimulate the synthesis of the components needed to ensure the overexpression of MHC molecules, including the MHC molecules, proteasomes, and transport proteins (TAP1 and 2). The consequences of MHC molecule upregulation are multifold: on the one hand, it facilitates the inductive stages of the immune response involving helper and cytotoxic T cells. On the other hand, it may create optimal conditions for the activation of autoreactive clones (see Chapter 16).

D. Restrictive Role of MHC-CD Interactions

The interaction between MHC-expressing cells and the immune system is subjected to two levels of MHC restriction:

1. In the first level, peptides bind to MHC molecules of one class or another.
2. The CD8-binding site on class I MHC molecules, and the CD4-binding site on class II MHC molecules determine the second level, in which (CD4 or CD8) T lymphocyte subsets will be able to interact with the MHC-bound peptides.

Detailed discussions of the role of MHC restriction in the immune response, T-lymphocyte ontogeny, cell-mediated immunity, and tolerance are included in Chapters 4, 10, 11, and 16.

E. MHC-II Diversity

A theoretical stumbling block is whether or not the limited number of MHC-II antigens is sufficient to bind a vast repertoire of peptides (on the order of 10^8 - 10^{10}). The peptides presented to T lymphocytes are helical structures with two parts (Fig. 3.6). The part of the peptide that protrudes above the surface of the groove and is accessible to the T-cell receptor is known as the "epitope." The rest of the peptide interacts with the groove of the MHC molecule. This interaction is mediated by "anchoring residues," shared by many peptides. Thus a given peptide can bind to many different class I or class II HLA molecules, and a limited repertoire of these molecules can accommodate a wide diversity of peptides.

F. MHC Binding and the Immune Response

The anchoring residues determine the binding affinity of a given oligopeptide to specific MHC-II alleles, which varies over 2 or 3 orders of magnitude between different alleles. These differences in binding affinity are believed to determine the strength of the response. A peptide bound with high affinity will be presented to the T cells in optimal conformation determining a high response to this epitope. In contrast, if the binding is of low affinity the individual will be a low responder or a nonresponder. Thus, the magnitude of the immune response is determined by the close fit between peptides and MHC molecules. It has also been postulated that these differences may have a direct reflection on the type of immune response (T_H1 vs. T_H2) elicited after the interaction between APC and T helper cells (see Chapter 4).

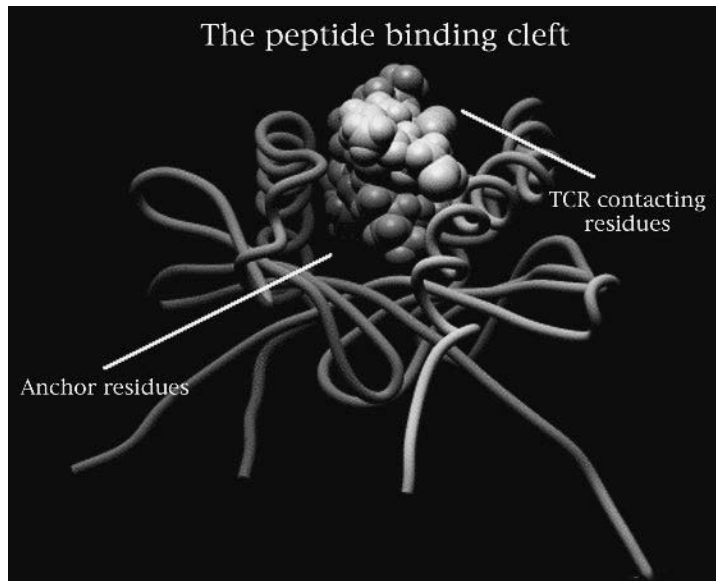

Fig. 3.6 Diagrammatic representation of the interaction between an immunogenic peptide and an MHC molecule. (Reproduced, with permission, from Lernmark, Å. *J. Clin. Invest.*, 104:1487, 1999.)

G. Importance of Antigen Complexity and MHC Heterozygosity

Even with a limited MHC-II repertoire, the probabilities of mounting a good response to a complex are high. Such antigens are likely to generate many different oligopeptides during processing, and the odds will be favorable for the emergence of some peptide(s) able to bind to the MHC-II molecules of a particular individual. These odds will increase if the individual is heterozygous, as is the case in over 95% of humans. The expression of two specificities per locus (one paternal and the other maternal) doubles their chance of finding a good fit between peptides and MHC II molecules and, therefore, of mounting an adequate immune response to that particular antigen.

H. Additional Peptide-Carrying Proteins

It is clear that the shape and charge of the MHC molecule is perfectly suited to closely surround small peptides and ensure that the outward-pointing residues are in a position to contact the TCR. However, the MHC molecules are not designed to bind strongly hydrophobic or nonpolar molecules such as lipids or carbohydrates. While the response to carbohydrates is elicited with minimal or no cooperation from helper T cells (thus circumventing the need for MHC presentation to helper T cells), the response to lipids and glycolipids seems to involve presentation by a different set of molecules, generically designated as CD1.

The CD1 molecules are structurally similar to the MHC molecules, suggesting that they arose from a primordial ancestor gene, which differentiated into at least two classes of antigen-presenting molecules. The CD1 genes are located on chromosome 1, and the CD1 molecules, similarly to MHC-I molecules, have a large polypeptide chain with three domains ($\alpha 1$, $\alpha 2$, $\alpha 3$), which is noncovalently associated with $\beta 2$ microglobulin. The $\alpha 1$ and $\alpha 2$ domains form a groove much deeper than the MHC I groove. It is formed by hy-

drophobic residues likely to bind very hydrophobic ligands such as compounds derived from *Mycobacterium tuberculosis*, including mycolic acids, lipoarabinomannan, and glucose monomycolate. Lipopolysaccharides from gram-negative bacteria and lipoteichoic acid from gram-positive bacteria are also likely to be presented by CD1. Many details must yet be determined before a complete picture of CD1-mediated presentation can emerge.

VIII. MHC-DISEASE ASSOCIATIONS

The MHC region is associated with more diseases than any other region of the human genome. In some cases, carrying specific HLA alleles may protect an individual against specific diseases. In other cases, carrying other HLA alleles may be associated with unusual frequency of diseases generally classified as “autoimmune.” A list of the most important associations between HLA antigens and specific diseases is given in Table 3.2.

A. MHC and Malaria

The association of particular MHC phenotypes with stronger responses to a given infectious agent was recently demonstrated in the case of malaria. In sub-Saharan Africa, malaria is responsible for the death of up to 2 million individuals per year. Researchers very recently found that individuals who do *not* express the class I HLA-Bw53 and the class II DQw5 alleles are at very high risk for the most severe and lethal forms of malaria. Reciprocally, since carrying the “protective” haplotype improves the chances of survival, its frequency in the population increased by natural selection. Nowadays, 40% of the natives of sub-Saharan Africa are positive for HLA-Bw53 and/or DQw5.

B. MHC and Autoimmune Diseases

Several mechanisms have been postulated to depend on the associations between MHC antigens and specific autoimmune diseases.

1. *MHC binding of exogenous peptides structurally similar to endogenous peptides.* As mentioned, MHC genes control the immune response by acting as binding sites for peptides derived from the processing of antigens from common pathogens. If the peptides in question are structurally similar to those derived from an endogenous protein and are bound with relatively high affinity to the MHC molecule, an immune response that eventually affects cells expressing the autologous peptide may ensue.

This mechanism is supported by the fact that most human diseases in which autoimmune phenomena play a pathogenic role are strongly linked with class II HLA genes, particularly with the genes of the DQ locus. This probably reflects the fact that DQ molecules are involved in the interactions of APCs with helper/inducer CD4 T lymphocytes.

One well-studied example of the association between DQ molecules and autoimmunity is diabetes mellitus (DM). The susceptibility or lack of susceptibility of humans to the autoimmune response against pancreatic islet cells that results in insulin-dependent diabetes mellitus (IDDM) is determined by allelic polymorphisms of the β 1 chain of the DQ antigen. More specifically, the charge

Table 3.2 Associations Between Particular Diseases and the MHC in Humans

Disease	Linked HLA region determinant	Relative risk of developing the disease ^a	Description of the disease
Inflammatory diseases			
Ankylosing spondylitis	B27	90–100	Inflammation of the spine, leading to stiffening of vertebral joints
Reiter's syndrome	B27	30–40	Inflammation of the spine, prostate, and parts of eye (conjunctiva, uvea)
Juvenile rheumatoid arthritis	B27	4–5	Multisystem inflammatory disease of children characterized by rapid onset of joint lesions and fever
Adult rheumatoid arthritis	DR4	6–12	Autoimmune inflammatory disease of the joints often associated with vasculitis
Psoriasis	B13, 17, 37	4–7	Acute, recurrent, localized inflammatory disease of the skin (usually scalp, elbows), associated with arthritis
Celiac disease	B8 Dw3	8–11	Chronic inflammatory disease of the small intestine; probably a food allergy to a protein in grains (gluten)
Multiple sclerosis	DR2	5	Progressive chronic inflammatory disease of brain and spinal cord that destroys the myelin sheath
Endocrine diseases			
Addison's disease	DR3	4–10	Deficiency in production of adrenal gland cortical hormones
Diabetes mellitus	DQ alleles DR3, DR4-5	≥100? ^b	Deficiency of insulin production; pancreatic islet cells usually absent or damaged
Miscellaneous diseases			
Narcolepsy	DR2	100	Condition characterized by the tendency to fall asleep unexpectedly

^a Numerical indicator of how many more times a disease is likely to occur in individuals possessing a given antigenic marker relative to those individuals that do not express the marker, determined by the following formula:

$$\text{Relative risk} = \frac{\text{no. of patients with the marker} \times \text{no. of controls without the marker}}{\text{no. of patients without the marker} \times \text{no. controls without the marker}}$$

^b Some alleles are associated with strong predisposition and others with strong resistance, but the precise relative risk for each allele has not yet been determined.

Source: Modified from Hood, L. E., Weissman, I. L., Wood, W. B., and Wilson, J. H. *Immunology*, 2nd ed. Benjamin/Cummings, Menlo Park, CA, 1984.

of the residue at position 57 of that chain seems to determine whether or not the immune system will be presented with peptides able to trigger the autoimmune response. Most IDDM patients have a noncharged valine in that position, which is usually occupied by an aspartate in nondiabetics. The binding of the anchoring residues of a diabetes-inducing peptide may be prevented by the presence of a charged aspartate residue in the groove, but it may take place with high-affinity binding when the 57 residue is occupied by a hydrophobic acid (i.e., valine). The source of the diabetes-inducing peptide remains unknown, but the fact that diabetes has been observed to follow some viral infections has led several authors to postulate that a viral protein-derived peptide may play that role.

MHC-I antigens can also present antigen-derived peptides (particularly from intracellular pathogens) to CD8⁺ cells, and this could be the basis for an autoimmune response in the case of ankylosing spondylitis and other reactive arthropathies, in which an infectious peptide presented by HLA-B27 could be cross-reactive with an endogenous collagen-derived peptide, equally associated with HLA-B27.

It must be stressed that carrying the genes associated with any given autoimmune diseases implies only an increased susceptibility to the disease. The individual may remain asymptomatic for life, but chance encounter with a pathogen can trigger an autoimmune response.

2. *MHC molecules acting as receptors for intracellular pathogens.* Such pathogens would interact with specific HLA antigens in the cell membrane and, as a result, infect the cells carrying those antigens. The infected cell would undergo long-lasting changes in cell functions, which would eventually result in disease. This could be the case in ankylosing spondylitis and related disorders (acute anterior uveitis, Reiter's syndrome). Over 90% of the individuals with ankylosing spondylitis are HLA-B27, and about 75% of the patients who develop Reiter's syndrome are HLA-B27 positive. Reiter's syndrome frequently follows an infection with *Chlamydia trachomatis*, and some evidence of persistent infection with this intracellular organism has been obtained, but the connection remains controversial.
3. *Molecular mimicry between antigenic determinants in infectious agents and HLA antigens.* This mechanism has been postulated to explain the relationship between *Yersinia pseudotuberculosis* and ankylosing spondylitis. This bacterium has been shown to contain epitopes cross-reactive with HLA-B27. Therefore, it could be speculated that an immune response directed against *Y. pseudotuberculosis* could lead to an autoimmune reaction against self. However, why this reaction would affect specific joints remains to be explained.
4. *Linkage disequilibrium between HLA genes and disease-causing genes.* A very strong association of various forms of 21-hydroxylase deficiency (the molecular basis of a disease known as congenital adrenal hyperplasia) with various HLA haplotypes (HLA -Bw 47, DR7) suggested a possible link between this disease and MHC genes. However, data obtained in classical genetic studies suggested that this disorder was determined by alleles of a single locus. These apparent contradictions were resolved when it was demonstrated that the genes coding for 21-hydroxylase are located on chromosome 6, in the segment flanked by MHC-

I and MHC-II genes (Fig. 3.3). Given this physical proximity between MHC genes and the 21-hydroxylase genes, a strong linkage disequilibrium between them is not surprising. The very strong associations between HLA-DR2 and narcolepsy, HLA-B27 and ankylosing spondylitis, and HLA-Bw35 and hemochromatosis will most likely become evident when the functions of the newly sequenced MHC genes are explained.

SELF-EVALUATION

Questions

Please choose the one *best* answer.

- 3.1 The molecular basis for the control that MHC-II genes have over the immune response is best explained by the:
 - A. Ability of MHC-II-antigen complexes to be released from antigen-processing cells and activate helper T cells
 - B. Involvement of MHC-II molecules in targeting reaction by cytotoxic T lymphocytes
 - C. Existence of genes controlling the immune response in linkage disequilibrium with MHC-II genes
 - D. Need for antigen-derived peptides to bind to an MHC-II molecule for proper presentation to the TCR of a helper T lymphocyte
 - E. Special affinity of unprocessed antigens for MHC-II molecules
- 3.2 Which of the following cellular antigens is (are) not coded by genes in the MHC region?
 - A. β_2 -Microglobulin
 - B. Class I HLA antigens
 - C. Class II HLA antigens
 - D. C4
 - E. Tumor necrosis factor (TNF)
- 3.3 The HLA phenotypes of a married couple are:
Father—A1,3; Cw1,w2; B5,8; Dw1,3
Mother—A2,3; Cw1,3; B5,8; Dw2,4
Which of the following phenotypes would definitely *not* be possible in an offspring of that couple?
 - A. A1,2; Cw1-, B5-, Dw1,w2
 - B. A2,3; Cw1,w2; B5,8; Dw2,3
 - C. A1,3; Cw1,w3; B5,8; Dw1,w4
 - D. A1,-; Cw1,w2; B5-, Dw1,w3
 - E. A3-, Cw2,w3; B8-, Dw3,w4
- 3.4 Which of the following is a unique characteristic of class I MHC proteins?
 - A. Expression on the membrane of activated T lymphocytes
 - B. Inclusion of β_2 -microglobulin as one of their constituent chains
 - C. Interaction with the CD4 molecule
 - D. Limited serological diversity
 - E. Presentation of immunogenic peptides to helper T lymphocytes

- 3.5 Which of the following groups of MHC genes include alleles closely associated with the susceptibility or resistance to develop diabetes mellitus?
- A. HLA-A
 - B. HLA-B
 - C. HLA-DP
 - D. HLA-DQ
 - E. HLA-DR
- 3.6 The frequency of the HLA-A1 and HLA-B8 alleles in the general population is 0.158 and 0.092, respectively. Assuming that these alleles are transmitted independently (without linkage disequilibrium), the expected frequency of the A1, B8 haplotype would be:
- A. 0.072
 - B. 0.057
 - C. 0.030
 - D. 0.015
 - E. 0.003
- 3.7 A relative risk of 5 for the association between DR4 and rheumatoid arthritis means that:
- A. The expression of DR4 is five times more frequent among patients with rheumatoid arthritis
 - B. DR4⁺ individuals are five times more likely to develop rheumatoid arthritis than DR4⁻ individuals
 - C. Five percent of DR4⁺ individuals will develop rheumatoid arthritis
 - D. The autoimmune reaction that causes rheumatoid arthritis is directed against DR4 epitopes in 5 of every 10 patients.
 - E. The frequency of rheumatoid arthritis is fivefold higher in DR4⁺ individuals than in DR4⁻ individuals
- 3.8 Over 80% of the patients with ankylosing spondylitis are positive for:
- A. HLA-DW3
 - B. HLA-B8
 - C. HLA-B27
 - D. HLA-B7
 - E. HLA-A5
- 3.9 Cells not expressing class I HLA antigenic products include:
- A. Monocytes
 - B. B lymphocytes
 - C. Skin cells
 - D. T lymphocytes
 - E. Striated muscle cells
- 3.10 The stimulation of cytotoxic (CD8⁺) T lymphocytes requires the association of an antigen-derived peptide with a(n):
- A. MHC-I molecule
 - B. MHC-I molecule identical to one of those expressed by the cytotoxic T lymphocyte
 - A. MHC-II molecule
 - B. MHC-II molecule identical to one of those expressed by the cytotoxic T lymphocyte
 - E. Newly synthesized MHC-II molecule in the endoplasmic reticulum

Answers

- 3.1 (D) The need for antigen-derived peptides to be presented in association with MHC-II molecules for proper stimulation of helper T cells is the limiting factor controlling the immune response. Peptides that bind with high affinity to MHC-II molecules will elicit strong responses, while no response will be elicited when the peptides cannot bind (or bind very weakly) to the available MHC-II molecules.
- 3.2 (A) β_2 -Microglobulin is coded by a gene in chromosome 15 and becomes associated to the heavy chain of HLA-I antigens postsynthetically. The gene coding for tumor necrosis factor is located in chromosome 6, between the MHC-I and MHC-II loci, in close proximity to the genes that code for several components of the complement system.
- 3.3 (D) The phenotype should include specificities 2 or 3 for locus A and W2 or W4 for locus D (one specificity being of paternal origin, the other of maternal origin).
- 3.4 (B) Class I MHC antigens are highly polymorphic and have hundreds of different serological specificities. Structurally they are constituted by one MHC-coded polypeptide and β_2 -microglobulin and are expressed in the membranes or almost all nucleated cells. They interact with the CD8 molecule, and their expression in lymphocytes is independent of the state of activation of the cell.
- 3.5 (D) Variations in the structure of the DQ β chain, at the point critically associated with peptide binding, seem to be most strongly associated with protection or sensitivity for diabetes; the structural variations are detected as DQ alleles by serological techniques and by the use of DNA probes.
- 3.6 (D) In the absence of linkage disequilibrium, the frequency of the A1, B8 haplotype should equal the product of the frequencies of each antigen in the general population.
- 3.7 (B) Relative risk is an estimate of how many more times a disease is likely to occur in individuals possessing a given marker relative to individuals not possessing the marker. The presence of the marker is not diagnostic by itself and does not necessarily imply that all positive individuals will develop the disease.
- 3.8 (C)
- 3.9 (E) Class I antigens are expressed in most nucleated cells, except nervous tissue cells and striated muscle cells.
- 3.10 (B) Cytotoxic T cells recognize peptides associated with self MHC-I molecules.

BIBLIOGRAPHY

- Braun, W. E. HLA and Disease: A Comprehensive Review. Boca Raton, FL: CRC Press, 1979.
- Careless, D. J., and Inman, R. D. Etiopathogenesis of reactive arthritis and ankylosing spondylitis. *Curr. Opin. Rheumatol.*, 7:290, 1995.
- Fremont, D. H., Hendrickson, W. A., Marrack, P., Kapler, J. Structures of an MHC class II molecule with covalently bound single peptides. *Science*, 272:1001, 1996.
- Hill, A. V. S., Alsopp, C. E. M., Kwiatkowski, D., Anstey, N. M., Twumasi, P., Rowe, P. A., Ben-

- nett, S., Brewster, D., McMichael, A. J., and Greenwood, B. M. Common West African HLA antigens are associated with protection from severe malaria. *Nature*, 352:595, 1991.
- Lopez de Castro, J. A. Structural polymorphism and function of HLA-B27. *Curr. Opin. Rheumatol.*, 7:270, 1995.
- Margulies, D. H. The major histocompatibility complex. In: *Fundamental Immunology*, 4th ed., (Paul, W. E., ed.). Lippincot-Raven, Philadelphia, 1999.
- The MHC sequencing consortium. Complete sequence and gene map of a human major histocompatibility complex. *Nature*, 401:921, 1999.
- Parham, P. Antigen processing: Transporters of delight. *Nature*, 348:674, 1990.
- Porcelli, S. A., and Modlin, R. L. The CD1 system: antigen presenting molecules for T cell recognition of lipids and glycolipids. *Ann. Rev. Immunol.*, 7:297, 1999.
- Pugliese, A., Gianani, R., Eisenbarth G. S., et al. HLA-DQB1*0602 is associated with dominant protection from diabetes even among islet cell antibody-positive first-degree relatives of patients with IDDM. *Diabetes*, 44:608, 1995.
- Sugita, M., Moody, D. B., Jackman, R. M., et al. CD1—a new paradigm for antigen presentation and T cell activation. *Clin. Immunol. Immunopath.*, 87:8, 1998.
- Weyand, C. M. and Goronzy, J. Functional domains on HLA-DR molecules: Implications for the linkage of HLA-DR genes to different autoimmune diseases. *Clin. Immunol. Immunopath.* 70:91, 1994.

4

The Induction of an Immune Response: Antigens, Lymphocytes, and Accessory Cells

Gabriel Virella and Barbara E. Bierer

I. INTRODUCTION

The immune system has evolved to ensure constant surveillance of “nonself” structures. Both T and B lymphocytes have cell surface receptors able to recognize structures not normally presented or expressed by the organism. Once that recognition takes place, a complex series of events is triggered, leading to the proliferation and differentiation of immune competent cells and to the development of immunological memory. These events will be directly or indirectly responsible for the elimination of the organism, cells, or molecules presenting nonself structures. Considerable effort has been applied to the study of in vitro and animal models allowing a detailed insight into the steps involved in the generation of an immune response.

II. ANTIGENICITY AND IMMUNOGENICITY

Antigenicity is defined as the property of a substance (antigen) that allows it to react with the products of a specific immune response (antibody or T-cell receptor). On the other hand, immunogenicity is defined as the property of a substance (immunogen) that endows it with the capacity to provoke a specific immune response. From these definitions

it follows that all immunogens are antigens; the reverse, however, is not true, as discussed later.

B-cell immunogens are usually complex, large molecules that are able to interact with B-cell surface receptors (membrane immunoglobulins) and deliver the initial activating signal leading to clonal expansion and differentiation of antibody-producing cells. T-cell immunogens can be best defined as compounds that can be processed by antigen-presenting cells into short polypeptide chains that combine with MHC molecules; the peptide-MHC complexes are able to interact with specific T-cell receptors and deliver activating signal to the T cells carrying such receptors.

Landsteiner, Pauling, and others discovered in the 1930s and 1940s that small aromatic groups, such as amino-benzene sulfonate, amino-benzene arsenate, and amino-benzene carboxylate, unable to induce antibody responses by themselves, would elicit antibody formation when chemically coupled to immunogenic proteins. The injection of these complexes into laboratory animals resulted in the production of antibodies specific for the different aromatic groups. The aromatic groups were designated as “haptens” and the immunogenic proteins as “carriers.” The immune response induced by a hapten-carrier conjugate included antibodies able to recognize the hapten and the carrier as separate entities. The hapten-specific antibodies are also able to react with soluble hapten molecules, free of carrier protein. Thus, a hapten is an antigen, but not an immunogen. In practical terms, it must be noted that the designations of antigen and immunogen are often used interchangeably.

Experiments comparing the specificity of hapten-specific antibodies induced with isomers of aromatic groups were critical for the definition of antibody specificity (see Chapter 8). Experiments comparing the effects of different hapten-carrier combinations or preimmunization with carrier proteins on hapten-specific responses helped to define T-B lymphocyte cooperation, as discussed later in this chapter. Later, the principles established with hapten-carrier conjugates were expanded to the induction of immune responses directed against many small molecular weight compounds and even poorly immunogenic polysaccharides, all of which may induce strong responses after conjugation to an immunogenic carrier protein. This knowledge helped explain the pathogenesis of some hypersensitivity disorders and was the basis for the development of improved immunization protocols (see below).

III. ANTIGENIC DETERMINANTS

As noted above, most immunogens are complex molecules (mostly proteins and polysaccharides). However, only a restricted portion of the antigen molecule—known as an antigenic determinant or epitope—is able to interact with the specific binding site of a B-lymphocyte membrane immunoglobulin, a soluble antibody, or a T-lymphocyte antigen receptor.

While B lymphocytes recognize epitopes expressed by unmodified, native molecules, T lymphocytes recognize short peptides generated by antigen processing (i.e., intracellular cleaving of large proteins into short peptides) or derived from newly synthesized proteins cleaved in the cytoplasm. These oligopeptides are newly formed and have little or no three-dimensional homology with the epitopes expressed on native proteins.

Studies with x-ray crystallography and two-dimensional nuclear magnetic resonance have resulted in the detailed characterization of B-cell epitopes presented by some small proteins, such as lysozyme, in their native configuration. From such studies the following

rules have been derived for antibody-antigen recognition:

1. Most epitopes are defined by a series of 15–22 amino acids located on discontinuous segments of the polypeptide chain, forming a roughly flat area with peaks and valleys that establish contact with the folded hypervariable regions of the antibody heavy and light chains.
2. Specific regions of the epitope constituted by a few amino acids bind with greater affinity to specific areas of the antibody binding site, and thus are primarily responsible for the specificity of antigen-antibody interaction. On the other hand, the antibody binding site has some degree of flexibility that optimizes the fit with the corresponding epitope.
3. A polypeptide with 100 amino acids may have as many as 14–20 nonoverlapping epitopes. However, a typical 100-amino-acid globular protein is folded over itself, and most of its structure is hidden from the outside. Usually only surface epitopes will be accessible for recognition by B lymphocytes and for interactions with antibodies (Fig. 4.1).

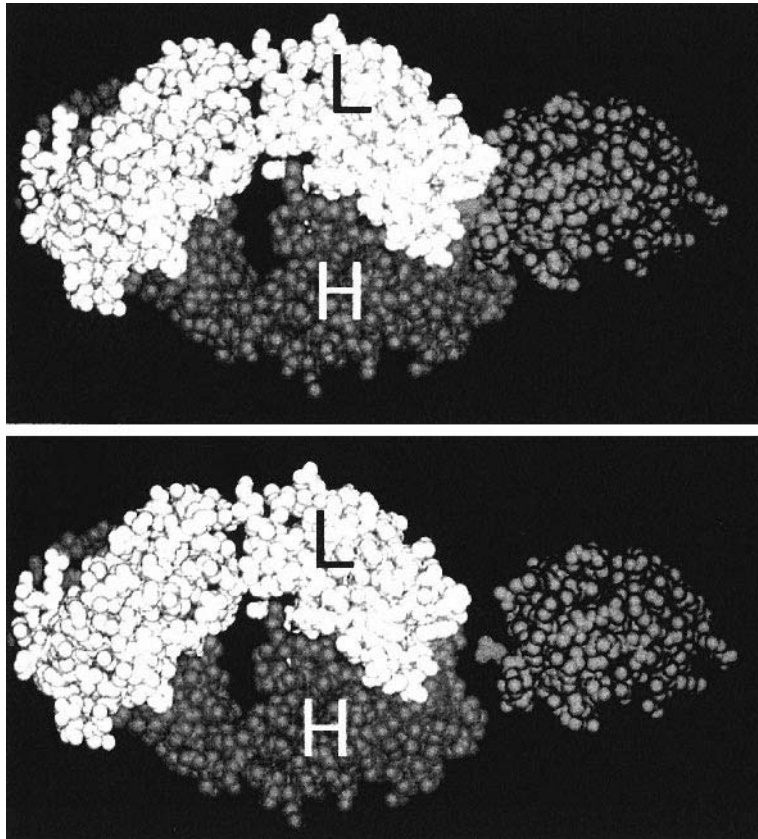

Fig. 4.1 Diagrammatic representation of a space-filling model showing the fit between an epitope of lysozyme and the antigen-binding site on an Fab fragment obtained from an anti-lysozyme antibody. (Reproduced with permission from Amit, A. G., Mariuzza, R. A., Phillips, S. E. V., and Poljack, R. J. *Science*, 233:747, 1986. Copyright 1986 American Association for the Advancement of Science.)

IV. CHARACTERISTICS OF IMMUNOGENICITY

Many different substances can induce immune responses. The following characteristics influence the ability of a substance to behave as an immunogen:

1. *Foreignness.* As a rule, only substances recognized as nonself will trigger the immune response. Microbial products and exogenous molecules are obviously nonself and may be strongly immunogenic.
2. *Molecular Size.* The most potent immunogens are macromolecular proteins [molecular weight (MW) > 100,000 daltons]. Molecules smaller than 10,000 daltons are often only weakly immunogenic, unless coupled to an immunogenic carrier protein.
3. *Chemical Structure.* Proteins and polysaccharides are among the most potent immunogens, although relatively small polypeptide chains, nucleic acids, and even lipids can, given the appropriate circumstances, be immunogenic. (a) **Proteins:** Large heterologous proteins express a wide diversity of antigenic determinants and are potent immunogens. It must be noted that the immunogenicity of a protein is strongly influenced by its chemical composition. Positively charged (basic) amino acids, such as lysine, arginine, and histidine, are repeatedly present in the antigenic sites of lysozyme and myoglobin, while aromatic amino acids (e.g., tyrosine) are found in two of six antigenic sites defined in albumin. Therefore, it appears that basic and aromatic amino acids may contribute more strongly to immunogenicity than other amino acids. Thus, basic proteins with clusters of positively charged amino acids are strongly immunogenic. (b) **Polysaccharides:** Polysaccharides are among the most important antigens because of their abundant representation in nature. Pure polysaccharides, the sugar moieties of glycoproteins, lipopolysaccharides, glycolipid-protein complexes, etc., are all immunogenic. Many microorganisms have polysaccharide-rich capsules or cell walls, and a variety of mammalian antigens, such as the erythrocyte antigens (A, B, Le, H), are short-chain polysaccharides (oligosaccharides). As noted later in this chapter, polysaccharides and oligosaccharides stimulate B cells without promoting T-cell help. This is probably a result of the lack of binding of oligosaccharides to MHC-II molecules, resulting in the inability to activate helper T cells. (c) **Nucleic acids:** Nucleic acids (RNA and DNA) usually are not immunogenic, but they can induce antibody formation if coupled to a protein to form a nucleoprotein. The autoimmune responses characteristic of some of the so-called autoimmune diseases (e.g., systemic lupus erythematosus) are often directed to DNA and RNA. (d) **Polypeptides:** Hormones such as insulin and other polypeptides, although relatively small in size (MW 1500), are usually able to induce antibody formation when isolated from one species and administered over long periods of time to an individual of a different species.
4. *Chemical complexity.* There appears to be a direct relationship between antigenicity and chemical complexity: aggregated or chemically polymerized proteins are much stronger immunogens than their soluble monomeric counterparts.

V. FACTORS ASSOCIATED WITH THE INDUCTION OF AN IMMUNE RESPONSE

In addition to the chemical nature of the immunogen, other factors strongly influence the development and potency of an immune response.

A. Genetic Background

Different animal species and different strains of one given species may show different degrees of responsiveness to a given antigen. In humans, different individuals can behave as “high responders” or “low responders” to any given antigen. The genetic control of the immune response is poorly understood, but it involves the repertoire of MHC molecules that bind antigen fragments and present them to the responding T-cell population. The affinity of the peptide for the MHC and of the peptide-MHC complex for the T-cell receptor will dictate, at least in part, the T-cell response. Other factors that promote or suppress the immune response must exist, but they are less well understood.

B. Method of Antigen Administration

The method of antigen administration has a profound effect on the immune response. A given dose of antigen may elicit no detectable response when injected intravenously, but a strong immune response is observed if injected intradermally. The presence of dendritic cells in the dermis (where they are known as Langerhans cells) may be a critical factor determining the enhanced immune responses when antigens are injected intradermally. This route of administration results in slow removal from the site of injection and in uptake and processing of the antigen by dendritic cells. The dendritic cells may present antigen to migrating T cells or may themselves migrate to the lymph node follicles, where the initial stages of the immune response take place. Thus, intradermal administration promotes prolonged antigenic stimulation and facilitates the involvement of one of the most specialized populations of antigen-presenting cells.

C. Use of Adjuvants

Adjuvants are agents that, when administered along with antigens, enhance the specific response. In contrast to carrier proteins, adjuvants are often nonimmunogenic and are never chemically coupled to the antigens. Several factors seem to contribute to the enhancement of immune responses by adjuvants, including delayed release of antigen, nonspecific inflammatory effects, and the activation of monocytes and macrophages. Several microbial and inorganic compounds have been used effectively as adjuvants both clinically and as investigational agents.

One of the most effective adjuvants is complete Freund’s adjuvant (CFA), a water-in-oil emulsion with killed mycobacteria in the oil phase. This is the adjuvant of choice for production of antisera in laboratory animals. Bacille Calmette-Guérin (BCG), an attenuated strain of *Mycobacterium bovis* used as a vaccine against tuberculosis, and muramyl dipeptide (MDP), the active moiety of *Mycobacterium tuberculosis* and of BCG, also have adjuvant properties. BCG has also been used as an immunotherapeutic agent to boost the immune system in patients with special types of cancer (e.g., superficial bladder cancer). Their use is limited, however, by side effects such as intense inflammatory reactions and discomfort. Recently, growth factors such as GM-CSF have been found to have adjuvant properties that may be clinically useful for the induction of cancer-specific immune responses (see Chapter 26).

Aluminum hydroxide, an inert compound that absorbs the immunogen, stimulates phagocytosis, and delays removal from the inoculation site, is an adjuvant frequently used with human vaccines. Aluminum hydroxide is not as effective as many of the adjuvants listed above, but it is considerably less toxic.

Finally, there is considerable interest in the development of adjuvants that may tilt the immune response in favor of T_H1 responses, a critical goal for vaccines targeting the induction of cell-mediated immune responses. One compound with such properties currently being investigated is the *Leishmania* protein known as Lel-F, a potent inducer of T_H1 responses in mice.

VI. EXOGENOUS AND ENDOGENOUS ANTIGENS

Most antigens to which we react are of exogenous origin and include microbial antigens, environmental antigens (such as pollens and pollutants), and medications. The objective of the immune response is the elimination of foreign antigens, but in some instances the immune response itself may have a deleterious effect resulting in hypersensitivity or in autoimmune disease, discussed in later chapters of this book.

Antigenic determinants that distinguish one individual from another within the same species are termed “alloantigens.” The alloantigens that elicit the strongest immune response are alleles of highly polymorphic systems, such as the erythrocyte A, B, O blood group antigens: some individuals carry the polysaccharide that defines the A specificity, while others have B positive red cells, AB positive red cells, or red cells that do not express either A or B (O). Other alloantigenic systems that elicit strong immune responses are histocompatibility (MHC or in the human, HLA) antigens of nucleated cells and tissues, the platelet (PI) antigens, and the Rh erythrocyte blood group antigens. Examples of sensitization to exogenous alloantigens include:

- Women sensitized to fetal red cell antigens during pregnancy
- Polytransfused patients who become sensitized against cellular alloantigens from the donor(s)
- Recipients of organ transplants who become sensitized against histocompatibility alloantigens expressed in the transplanted organ

Endogenous antigens, by definition, are part of self, and the immune system is usually tolerant to them. The response to self antigens may have an important role in normal catabolic processes (i.e., antibodies to denatured IgG may help in eliminating antigen-antibody complexes from circulation; antibodies to oxidized low-density lipoprotein (LDL) may help in eliminating a potentially toxic lipid). The loss of tolerance to self antigens, however, can also have pathogenic implications (autoimmune diseases).

VI. T-B CELL COOPERATION IN ANTIBODY RESPONSES

Experiments carried out with hapten-carrier complexes have contributed significantly to our understanding of T-B lymphocyte cooperation. A specific example is illustrated in Figure 4.2. Mice primed with a hapten-carrier conjugate prepared by chemically coupling the 2-dinitrophenyl (2-DNP) radical to egg albumin (ovalbumin, OVA) produced antibodies both to DNP and OVA. Antibodies to the hapten (DNP) were not observed when mice were immunized with DNP alone or with a mixture of DNP and OVA not chemically linked. Secondary challenge of mice primed with DNP-OVA with the same hapten-carrier conjugate triggered an anamnestic or “recall” response of higher magnitude against both hapten and carrier. In contrast, if the DNP-OVA-primed animals were challenged with the same

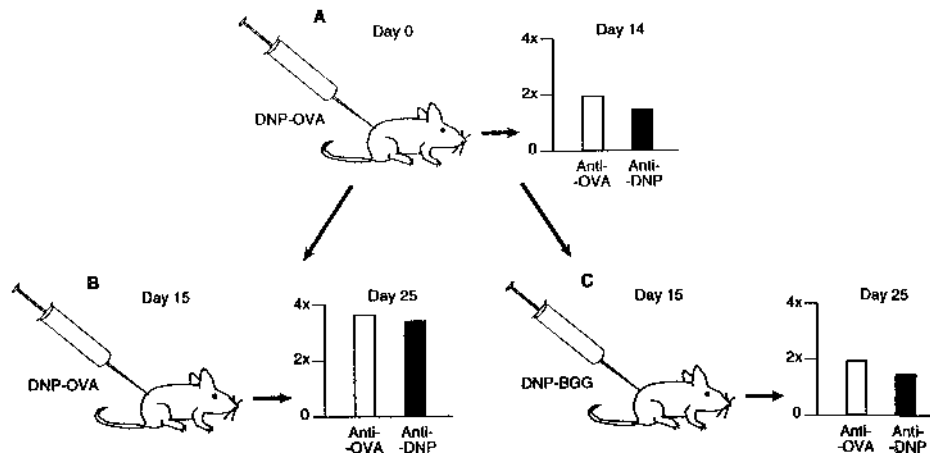

Fig. 4.2 The hapten-carrier effect: In order to obtain a secondary immune response to the hapten (DNP), the animal needs to be immunized (A) and challenged (B) with the same DNP-carrier combination. Boosting with a different DNP-carrier conjugate (C) will result in an anti-DNP response of identical magnitude to that obtained after the initial immunization. The memory response, therefore, appears to be carrier-dependent.

hapten coupled to a different carrier, such as bovine gamma globulin (DNP-BGG), the ensuing response to DNP was of identical magnitude to that observed after the first immunization with DNP-OVA (Fig. 4.2). The conclusion from these observations is that a “recall” response to the hapten can only be observed when the animal is repeatedly immunized with the same hapten-carrier conjugate.

It was further observed that if mice were primed with the carrier ovalbumin alone and then challenged with DNP-OVA, the response to DNP was as high as that observed when mice had been primed with DNP-OVA (Fig. 4.3). When OVA-primed mice were challenged with a mixture of not chemically linked DNP and OVA, the response to DNP was not observed. Thus it was concluded that immunological “memory” (defined in this case as a response of the magnitude characteristic of a secondary response) to the hapten moiety of a hapten-carrier conjugate is exclusively dependent on a previous exposure to the carrier moiety. In other words, the factors responsible for the secondary immune response were effective in enhancing the response to any hapten coupled to the immunizing carrier.

The hapten-carrier experiments were later repeated using sublethally irradiated inbred mice reconstituted with different cell subpopulations from immunocompetent animals of the same strain. Four groups of animals used as a source of reconstituting cells. Mice were immunized with DNP or with two different immunogenic proteins, such as keyhole limpet hemocyanin (KLH) and OVA; a fourth group was injected with saline (see Fig. 4.4). T and B lymphocytes were purified from the immunized animals and transferred to the sublethally irradiated mice of the same strain. Several observations were made:

1. If both DNP-primed B lymphocytes and OVA-primed T lymphocytes were transferred to sublethally irradiated recipients, the reconstituted mice produced relatively large amounts of anti-DNP antibody upon challenge with DNP-OVA.
2. If nonimmune or KLH-primed T lymphocytes were co-transferred with DNP-primed B lymphocytes, only a minimal anti-DNP antibody response was obtained after challenge with DNP-OVA.

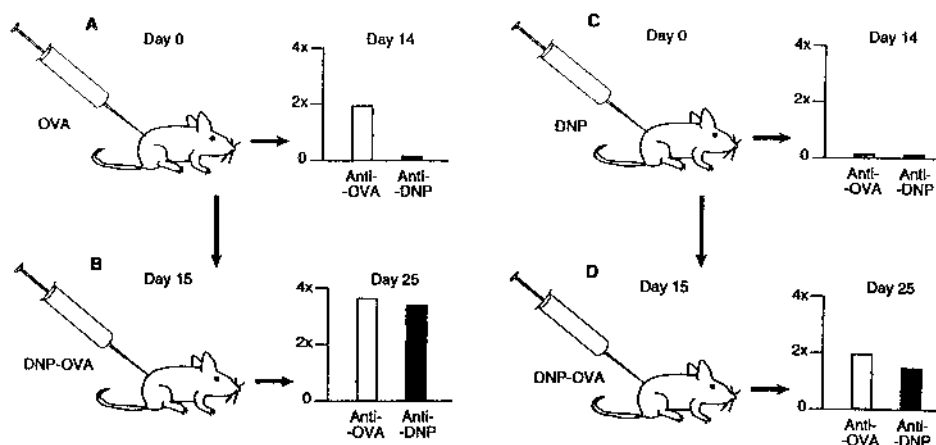

Fig. 4.3 Further proof of the carrier dependency of the memory response to a hapten-carrier conjugate was obtained by studying the effects of primary immunization with carrier (e.g., OVA) or hapten (e.g., DNP) alone on a booster response with the hapten-carrier conjugate. A primary immunization with OVA (A) was followed by a “secondary” response to both hapten and carrier when the animals were challenged with OVA-DNP (B). A primary immunization with DNP (C) did not induce anti-DNP antibodies, and the animal reacted to a challenge with OVA-DNP (D) as if it was primary immunization to either carrier or hapten.

3. If DNP-specific B lymphocytes were transferred with OVA-specific T lymphocytes, robust anti-DNP antibody responses were observed upon challenge with DNP-OVA. However, only suboptimal anti-DNP responses were observed upon challenge with DNP-KLH, and no anti-DNP antibody response was observed when the mice were challenged with an unconjugated mixture of OVA and DNP.

These experiments demonstrated that the amplification of the B-cell response required T cells. Additionally, both carrier- and hapten-specific antibody-producing cells were “helped” by carrier-specific T lymphocytes. In other words, T-lymphocyte “help” is not antigen-specific, since the T and B lymphocytes collaborating in the immune response may recognize antigenic determinants from totally unrelated compounds (hapten and carrier).

A consistent observation in all hapten-carrier observations is that the efficient collaboration between T and B lymphocytes requires that the antigenic determinants for each cell type must be on the same molecule. This suggests that the helper effect is most efficient if the collaborating B and T lymphocytes are brought into intimate, cell-to-cell contact, with each cell reacting to distinct determinants on the same molecule.

In the last two decades the hapten-carrier concept has found significant applications in medicine. Hapten-carrier systems have been developed to raise antibodies to a variety of nonimmunogenic chemicals that are the basis for a variety of drug-level assays (e.g., plasma cyclosporine levels). Lastly, the immune response to haptens coupled to autologous carriers has been demonstrated to be the pathological basis for some abnormal immune reactions, including some drug allergies. For instance, the spontaneous coupling of the penicilloyl derivative of penicillin to a host protein is believed to be the first step toward developing hypersensitivity to penicillin. Hypersensitivity reactions to a number of drugs, chemicals, and metals are believed to result from spontaneous coupling of these nonim-

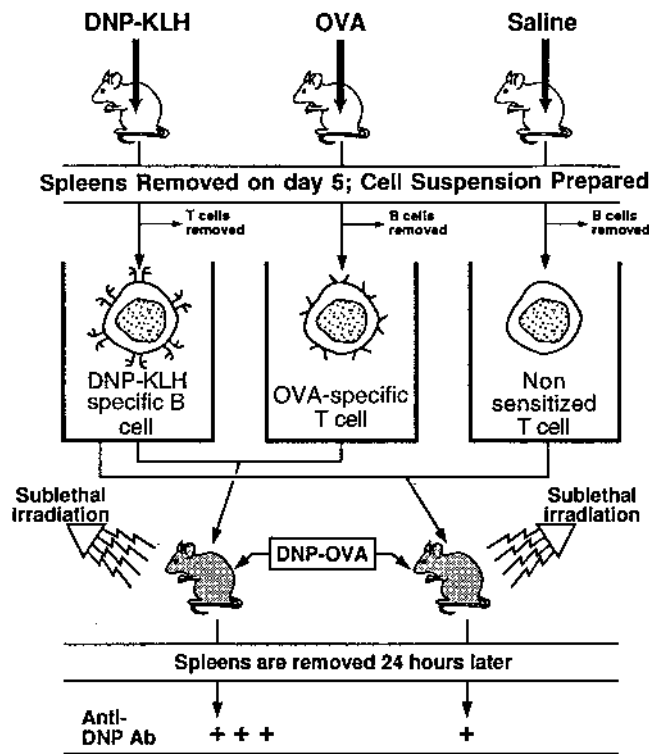

Fig. 4.4 Diagrammatic representation of an experiment designed to determine the nature of T-cell help in a classical hapten-carrier response. Sublethally irradiated mice were reconstituted with different combinations of T and B cells obtained from nonimmune mice or from mice immunized with DNP-OVA. T cells from mice preimmunized with OVA “helped” B cells from animals preimmunized with DNP-KLH to produce large amount of anti-DNP antibodies, but the same B cells did not receive noticeable help from T cells separated from nonimmune mice. Thus, T cells with “carrier” memory efficiently help B cells.

munogenic compounds to endogenous proteins, which are modified as a consequence of the chemical reaction with the hapten. As a consequence, the conditions necessary for the elicitation of immune responses to nonimmunogenic compounds are created.

VII. T-DEPENDENT AND T-INDEPENDENT ANTIGENS

The studies with hapten-carrier complexes were followed by many others in which inbred rodents were sublethally irradiated to render them immunoincompetent, and their immune systems were then reconstituted with T lymphocytes, B lymphocytes, or mixtures of T and B lymphocytes obtained from normal animals of the same strain. After reconstitution of the immune system, the animals were challenged with a variety of antigens, and their antibody responses were measured.

For most antigens, including complex proteins, heterologous cells, and viruses, a measurable antibody response was only observed in animals reconstituted with mixtures of T and B lymphocytes. In other words, for most antigens, proper differentiation of antibody-producing cells required T cell “help.” The antigens that could not induce immune re-

sponses in T-cell–deficient animals were designated as T-dependent antigens. Structurally, T-dependent antigens are usually complex proteins with large numbers of different, non-repetitive, antigenic determinants.

Other antigens, particularly polysaccharides, can induce antibody synthesis in animals depleted of T lymphocytes and are known as T-independent antigens. It should be noted that in many species there may be a continuous gradation of antigenic responses from T dependence to T independence, rather than two discrete groups of antigens. However, this differentiation is useful as a working classification.

A. Biological Basis of T Independence

The basic fact that explains the inability of polysaccharides to behave as T-dependent antigens is the fact that these compounds do not bind to MHC II molecules and, therefore, cannot be presented to T cells. Immune responses elicited by T-independent antigens are mediated by different mechanisms that bypass the need for T-cell help.

Some T-independent antigens, such as bacterial lipopolysaccharides (LPS), are mitogenic and can deliver dual signals to B cells: one by occupancy of the antigen-specific receptor (membrane immunoglobulin) and the other through a second, poorly characterized, co-stimulatory B-cell protein. The engagement of these two receptors would be sufficient to stimulate B cells and promote differentiation into antibody-producing cells.

Other T-independent antigens (such as polysaccharides) are not mitogenic but are composed of multiple sugar molecules, allowing extensive cross-linking of membrane immunoglobulins. Receptor cross-linking delivers strong activating signals that apparently overrides the need for co-stimulatory signals.

B. Special Characteristics of the Immune Response to T-Independent Antigens

The antibody produced in response to stimulation with T-independent antigens is predominantly IgM. The switch to other isotype, such as IgG and IgA, production requires the presence of cytokines and other signals (e.g., those delivered by CD40 interacting with CD40L) delivered by locally responding T cells. There is, therefore, little (if any) synthesis of IgG and IgA after exposure to T-independent antigens. These antigens also fail to elicit immunological memory, also dependent on the simultaneous activation of T cells, as demonstrated with the hapten-carrier experiments.

The use of polysaccharides as immunogens for immunoprophylaxis has always been unsatisfactory. A decade ago it was discovered that poorly immunogenic polysaccharides induce the same type of immune responses associated with T-dependent immunogens when conjugated to immunogenic proteins. These vaccines act, essentially, as hapten-carrier complexes, in which the polysaccharide plays the role of the hapten, and they are extremely effective (see Chapter 12).

III. INDUCTION OF THE IMMUNE RESPONSE

A. Immune Recognition: Clonal Restriction and Expansion

For the initiation of an immune response, an antigen or a peptide associated with a MHC molecule must be recognized as nonself by the immunocompetent cells. This phenomenon is designated immune recognition. The immune system of a normal individual may recog-

nize as many as 10^6 – 10^8 different antigenic specificities. An equal number of different small families (clones) of lymphocytes, bearing receptors for the different antigens, constitute the normal repertoire of the immune system. Each immunocompetent cell expresses on its membrane many identical copies of a receptor for one single antigen. Thus, a major characteristic of the immune response is its clonal restriction, i.e., one given epitope will be recognized by a single family of cells with identical antigen receptors, known as a clone. When stimulated by the appropriate specific antigen, each cell will proliferate, and the clone of reactive cells will become more numerous (clonal expansion).

Since most immunogens present many different epitopes to the immune system, the normal immune responses are polyclonal, i.e., multiple clones of immunocompetent cells, each one of them specific for one unique epitope, are stimulated by any complex immunogen.

B. The Antigen Receptor on T and B Lymphocytes

In B lymphocytes, the antigen receptors are membrane-inserted immunoglobulins, particularly IgD and monomeric IgM molecules (see Chapter 5). In T lymphocytes the antigen receptors are known as T-cell receptors (TcR).

As discussed in Chapters 10 and 11, two types of TcR have been identified, depending on the polypeptide chains that constitute them. In differentiated T cells, the TcR most frequently found is constituted by two polypeptide chains, designated as α and β ($\alpha\beta$ TcR), with similar molecular weights (40,000–45,000). A second type of TcR, constituted by two different polypeptide chains known as γ and δ ($\gamma\delta$ TcR), is predominantly found in the submucosal lymphoid tissues.

The two chains of the $\alpha\beta$ TcR have extracellular segments with variable and constant domains, short cytoplasmic domains, and a transmembrane segment (Fig. 4.5). A disulfide bridge joins them just outside the transmembrane segment.

The β chains are highly polymorphic and are encoded by a multigene family that includes genes for regions homologous to the V, C, D, and J regions of human immunoglob-

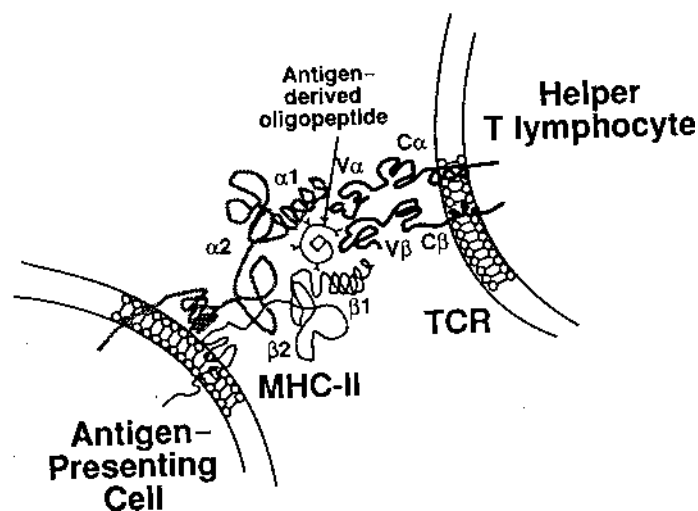

Fig. 4.5 Schematic representation of the T-lymphocyte receptor and of its interaction with a MHC II-associated peptide. (Redrawn from Sinha, A. A., Lopez, M. T., and McDevitt, H. *Science*, 248:1380, 1990.)

ulins. The α chains are encoded by a more limited multigene family with genes for regions homologous to the V, C, and J regions of human immunoglobulins (see Chapter 7). Similar polymorphisms have been defined for the $\gamma\delta$ chains. Together, the variable regions of $\alpha\beta$ and $\gamma\delta$ chains define the specific binding sites for peptide epitopes presented in association with MHC-II molecules.

C. Antigen Processing and Presentation

Most immune responses to complex, T-dependent antigens involve the participation of several cell types, including T and B lymphocytes that are directly involved in the generation of effector mechanisms and accessory cells that assist in the inductive stages of the immune response. Antigen-presenting cells (APCs) are accessory cells that express MHC-II molecules on their membrane where antigen fragments can be bound and “presented” to lymphocytes. Additionally, they often express ligands for costimulatory molecules and release cytokines that assist the proliferation and/or differentiation of T and B lymphocytes. As described in Chapter 2, several types of cells can function as APCs. The most effective are the dendritic cells found in the paracortical areas of the lymph nodes. Dendritic cells and their precursors (Langerhans cells in the dermis) as well as activated B cells serve as effective APCs in immunologically naïve hosts (see later in this chapter). Tissue macrophages and related cells are effective APCs in that they have phagocytic properties and can process proteins and present the resulting peptides on MHC-II molecules. Macrophages become particularly effective when antigen molecules are coated with IgG and complement, under which conditions their phagocytic potential is fully expressed.

Antigen processing and presentation is a complex sequence of events that involves endocytosis of antigens on membrane patches and transport to an acidic compartment (lysosome) within the cell that allows antigen degradation into small peptides. As antigens are broken down, vesicles coated with newly synthesized HLA II molecules fuse with the lysosome. Some of the peptides generated during processing have affinity for the binding site located within the MHC-II heterodimer. The resulting MHC-peptide complexes are then transported to the APC cell membrane, where they can interact with and activate T cells bearing the T-cell receptor specific for the peptide (Fig. 4.6).

D. Activation of Helper T Lymphocytes

The activation of resting T helper cells requires a complex and coordinated sequence of signals delivered from the T-cell receptor on the cell membrane to the nucleus of the cell. Of all the signals involved, the only antigen-specific interaction is the one that involves the TcR and the peptide-MHC complex. The binding of the peptide-MHC complex to the TcR is of low affinity, and other receptor-ligand interactions are required to maintain T-lymphocyte adhesion to APC and for the delivery of required secondary signals.

The TcR on a helper T lymphocyte interacts with both the antigen-derived peptide and the MHC-II molecule (Fig. 4.5). This selectivity of the TcR from helper T lymphocytes to interact with MHC-II molecules results from selection in the thymus. During thymic ontogeny, the differentiation of helper and cytotoxic T lymphocytes is based on the ability of their TCR to interact with MHC-II molecules (helper T lymphocytes) or with MHC-I molecules (cytotoxic T lymphocytes) (see Chapter 10). The interactions between T lymphocytes and MHC-expressing cells are strengthened by cell surface molecules, which also interact with constant (not peptide-loaded) regions of MHC molecules: the CD4 molecule

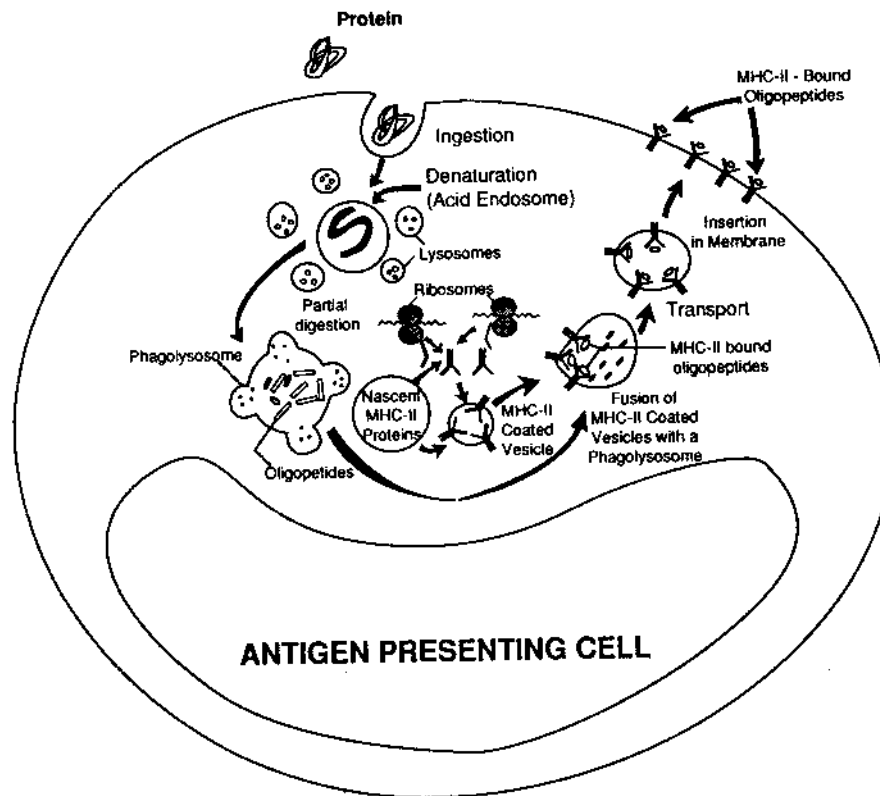

Fig. 4.6 Diagrammatic representation of the general steps in antigen processing. The antigen is ingested, partially degraded, and after vesicles coated with nascent MHC II proteins fuse with the phagolysosomes, antigen-derived polypeptides bind to the MHC II molecule. In this bound form, the oligopeptides seem protected against further denaturation and are transported together with the MHC II molecule to the cell membrane, where they will be presented to $CD4^+$ T lymphocytes in traffic through the tissue where the APC are located.

on helper T cells interacts with MHC-II molecules, while the CD8 molecule on cytotoxic lymphocytes interacts with MHC-I molecules.

Several other cell adhesion molecules (CAM) can mediate lymphocyte-AC interactions, including lymphocyte function-associated antigen (LFA)-1 interacting with the intercellular adhesion molecules (ICAM)-1, -2, and -3, CD2 interacting with CD58 (LFA-3). Unlike the interactions involving the TcR, these interactions are not antigen specific. Their role is to promote stable adhesion and signaling between T lymphocytes and APC essential for proper stimulation through the TcR. Furthermore, T-cell activation requires sustained signaling achieved through the establishment of what is known as the immunological synapse, in which peptide-MHC-II complexes form clusters on the APC membrane allowing aggregation and clustering of multiple TcR molecules on the opposing T-cell membrane. In the regions of contact the two cells are separated by a narrow gap surrounded by other interacting molecules such as (CD2/CD58, LFA-1/ICAM-1, etc.). The result is a stable and close apposition between APC and T cell, essential for sustained signaling (Fig. 4.7).

It is important to stress that accessory cells participate in the activation of helper T lymphocytes through the delivery of signals involving cell-cell contact as well as by the re-

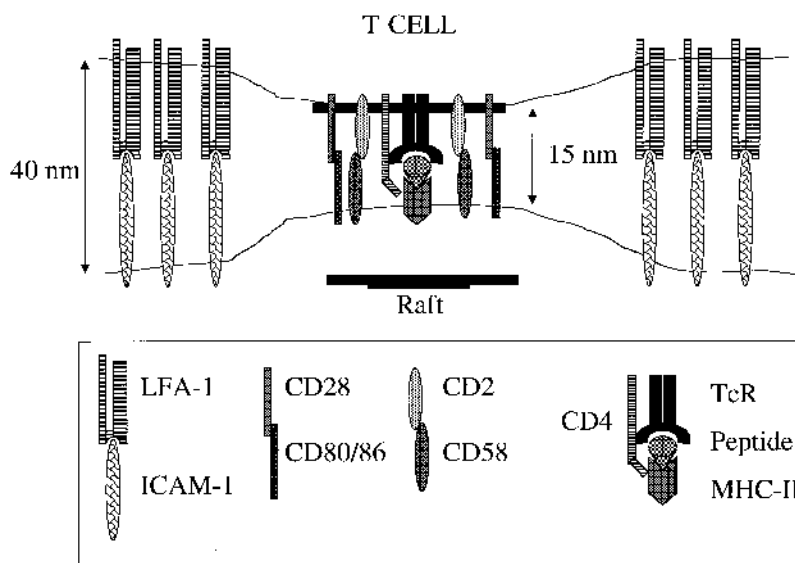

Fig. 4.7 Diagrammatic representation of the topography of T cell–APC cell interaction. In the areas where the T-cell receptors interact with peptide–MHC II complexes, the cells are in very close apposition. The rafts designate cholesterol-rich membrane domains in the T-cell membrane where the TcR, CD4, and other co-stimulating molecules interact with their respective ligands on in the APC. These interactions are primarily responsible for the close apposition of the T cell and APC membranes and for assembling the early signaling complex. Other molecules, such as LFA-1 and ICAM-1, stabilize the interaction between T cells and APCs and are present outside the rafts. (Adapted from Dustin, M. L. and Shaw, A. S. *Science*, 283:649–50, 1999.)

lease of soluble factors or cytokines (Fig. 4.8):

1. Signals mediated by CD4–MHC-II interactions
2. Signals mediated by the cell-cell interactions, which are facilitated by the up-regulation of some of the interacting molecules after initial activation, including:

CD2 (T cell): CD58 (APC)

LFA-1 (T cell): ICAM-1, ICAM-2, ICAM-3 (APC)

CD40 L (T cell): CD40 (APC)

CD28 (T cells): CD80, CD86 (APC)

3. Signals mediated by interleukins:

Interleukin-1 (IL-1), a cytokine that promotes growth and differentiation of many cell types, including T and B lymphocytes. Both membrane-bound and soluble IL-1 have been shown to be important in activating T lymphocytes *in vitro*. Membrane-bound IL-1 can only activate T lymphocytes in close contact with the APC.

Interleukin-12 (IL-12) promotes Th1 cell differentiation as discussed later in the chapter.

However, all these co-stimulatory signals are not specific for any given antigen. The specificity of the immune response is derived from the essential and first activation signal delivered through the antigen-specific TcR.

The precise sequence of intracellular events resulting in T-cell proliferation and differentiation will be discussed in greater detail in Chapter 11. The following is a summary of the major steps in the activation sequence:

1. Occupancy and cross-linking of the TcR signals the cell through a closely associated complex of molecules, known as CD3, that has signal-transducing properties. The TcR heterodimer itself has no recognizable kinase activity. The associated CD3 complex, however, has 10 intracytoplasmic motifs (immunoreceptor-tyrosine-based activation motifs, ITAMs) that play a key role in the sequence of cell activation. These ITAMs are associated with the γ , δ , ϵ , and ζ chains of the CD3 complex.
2. Co-stimulatory signals are delivered by CD4, as a consequence of the interaction with MHC-II, and by CD45, a tyrosine phosphatase, activated as a consequence of TcR occupancy.
3. The activation of CD45 initiates the sequential activation of several protein kinases closely associated with CD3 and CD4. The activation of the kinase cascade has several effects, namely:
 - a. Phospholipase C activation, leading to the mobilization of Ca^{2+} -dependent second messenger systems, such as inositol triphosphate (IP_3), which promotes an increase in intracellular free Ca^{2+} released from intracellular organelles and taken up through the cell membrane. The increase in intracellular free calcium results in activation of a serine threonine phosphatase known as calcineurin. Diacylglycerol (DAG), another product released by phospholipase C, activates another serine/threonine kinase known as protein kinase C (PKC). Multiple other enzymes and adapter molecules are activated in the ensuing cascading sequence.
 - b. The activation of second messenger systems results in the activation and translocation of transcription factors, such as the nuclear factor-kappa B (NF- κ B) and the nuclear factor of activated T cells (NF-AT). Once translocated to the nucleus, these factors induce genes controlling cytokine pro-

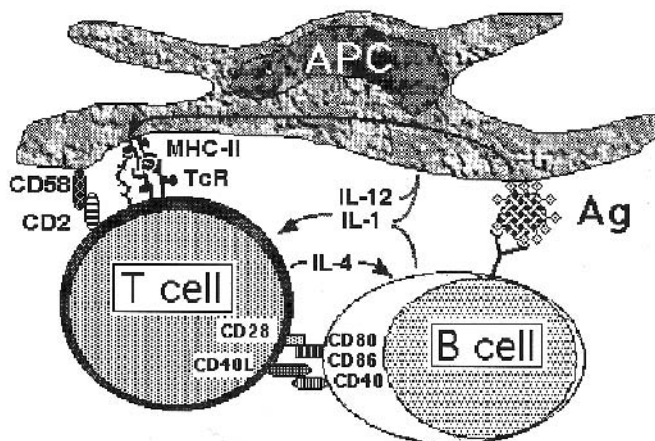

Fig. 4.8 Diagrammatic representation of the interactions between APCs, T cells, and B cells in the early stages of an immune response.

- duction and T-cell proliferation, such as those encoding interleukin-2 (IL-2), the IL-2 receptor, and c-myc.
- c. Upregulation and modification of several membrane proteins on the T-cell membrane, such as CD28 and CD40 ligand (CD40L). These molecules interact, respectively, with CD80/86 and CD40 on the APC membrane. The interactions involving this second set of molecules deliver additional signals that determine the continuing proliferation and differentiation of antigen-stimulated T cells.

E. Antigen Presentation and Activation of Cytotoxic T Lymphocytes

If an APC is infected by an intracellular organism (virus, bacteria, or parasite), the infecting agent will multiply in the cytosol. As described in Chapter 3, peptides derived from microbial proteins are loaded onto MHC-I molecules, transported to the cell surface, and presented to cytotoxic T lymphocytes (CTL). CTL are a special population of effector T cells capable of killing target cells bearing specific antigen and are largely CD8⁺.

The way in which MHC I molecules and viral peptides become associated has recently been elucidated (Fig. 4.9). Upon infection, intracellular microbes start to produce their own proteins. Some of the nascent microbial proteins diffuse into the cytoplasm, where they become associated with degradative enzymes forming a peptide-enzyme complex (proteasome). In these complexes, the protein is partially digested, and the resulting peptides bind to specialized proteins (transporters associated with antigen processing, TAP), which deliver them to the endoplasmic reticulum, the site of MHC-I synthesis and assembly. In the endoplasmic reticulum, the viral peptides bind to newly synthesized MHC class I molecules, and the resulting MHC-viral peptide complex is transported to the membrane of the infected cell.

Similar to helper T cells, the stimulation of cytotoxic T cells also requires additional signals and interactions, some of which depend upon cell-cell contact, such as those mediated by the interaction of CD8 with MHC I, CD2 with CD58, LFA-1 with ICAM family members, and CD28 with CD80 and CD86. On the other hand, the expansion of antigen-activated cytotoxic T lymphocytes requires the secretion of IL-2. Rarely, activated cytotoxic T lymphocytes can secrete sufficient quantities of IL-2 to support their proliferation and differentiation and thus proceed without help from other T-cell subpopulations. Most frequently, activated helper T lymphocytes provide the IL-2 necessary for cytotoxic T lymphocyte differentiation. The activation of helper T cells requires the presentation of antigen-derived peptides in association with MHC-II molecules. The simultaneous expression of immunogenic peptides in association with MHC-I and MHC-II molecules is likely to happen in infected APCs.

Resting, circulating cytotoxic T lymphocytes carry antigen receptors able to recognize associations of MHC-I and nonself peptides; occupancy of the binding site on the TCR by MHC-I-associated peptide provides the antigen-specific signal that drives cytotoxic T cells. In the case of antiviral responses, virus-infected macrophages are also likely to express viral peptide-MHC-II complexes on their membrane; these complexes are able to activate CD4⁺ helper T cells. Thus, an infected professional APC is likely to fulfill the conditions required to serve as the anchor for all the cells participating in the immune response against the infecting virus.

Cytotoxic T lymphocytes also differentiate and proliferate when exposed to cells from an individual of the same species but from a different genetic background, as a con-

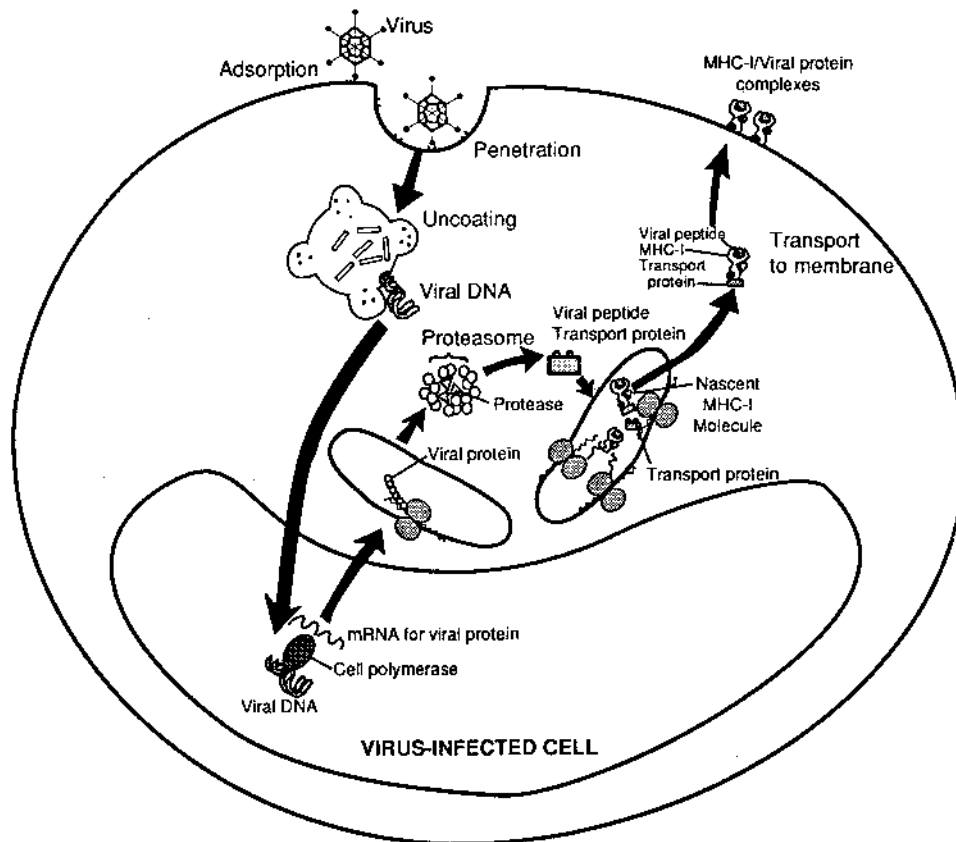

Fig. 4.9 Diagrammatic representation of the general steps involved in the presentation of viral-derived peptides on the membrane of virus-infected cells. The virus binds to membrane receptors and is endocytosed, its outer coats are digested, and the viral genome (in this case DNA) is released into the cytoplasm. Once released, the viral DNA diffuses back into the nucleus, where it is initially transcribed into mRNA by the cell's polymerases. The viral mRNA is translated into proteins that diffuse into the cytoplasm, where some will be broken down into oligopeptides. Those small peptides are transported back into the endoplasmic reticulum where they associate with newly synthesized MHC-I molecules. The MHC-I-oligopeptide complex becomes associated to a second transport protein and is eventually inserted into the cell membrane. In the cell membrane, it can be presented to $CD8^+$ T lymphocytes in traffic through the tissue where the viral infected cell is located. A similar mechanism would allow a MHC-II-synthesizing cell to present MHC-II/oligopeptide complexes to $CD4^+$ lymphocytes.

sequence of tissue or organ transplantation. In vitro, the degree of allostimulation between lymphocytes of two different individuals can be assessed by the mixed lymphocyte reaction (see Chapter 15). Two types of recognition have been analyzed:

1. Donor peptides presented by nonpolymorphic MHC molecules of donor cells appear to trigger the initial stages of the mixed lymphocyte reaction.
2. As a consequence of the release of cytokines during the initial activation of the rejection reaction, the expression of nonself MHC molecules is upregulated on donor tissues. Donor MHC molecules are shed into the circulation, taken up by

professional APCs of the recipient, and processed and presented as nonself peptides associated with self MHC molecules to the immune system of the recipient.

MHC-II-expressing cells must be present for the mixed lymphocyte reaction to take place. This requirement suggests that activation of helper T cells by recognition of MHC-II-peptide complexes is essential for the differentiation of cytotoxic CD8⁺ cells. The role of helper T cells in the mixed lymphocyte reaction is likely to be very similar to the role of helper T cells that assist B-cell responses, i.e., to provide cytokines and co-stimulatory signals essential for cytotoxic T-cell growth and differentiation.

Graft rejection is more intense with increasing MHC disparity between donor and host. This is likely a consequence of the greater structural differences between the non-shared MHC molecules. Thus, MHC differences are likely to perpetuate the rejection reaction in that self (host-derived) MHC molecules will present nonself peptides derived from the donor's MHC molecules.

Alternative pathways of antigen presentation to cytotoxic T cells involving nonpolymorphic molecules have been recently described. The best characterized of these pathways involves CD1, a family of nonpolymorphic, MHC-I-related molecules that includes five different isomeric forms (A to E). Antigen-presenting cells, including dendritic cells and B cells, express CD1A, B, and C molecules and have been shown to present mycobacterium-derived lipid and lipoglycan antigens to both $\gamma\delta$ and $\alpha\beta$ CD8⁺ cytotoxic T lymphocytes. Both $\gamma\delta$ and CD8⁺ $\alpha\beta$ T cells stimulated by mycobacterial antigens presented in association with CD1 molecules cause the death of the presenting cells.

IX. Stimulation of a B-Lymphocyte Response by a T-Dependent Antigen

In contrast to T lymphocytes, B lymphocytes recognize external epitopes of unprocessed antigens, which do not have to be associated to MHC molecules. Some special types of APC, such as the Langerhans cells of the epidermis and the follicular dendritic cells of the germinal centers, appear to adsorb complex antigens onto their membranes, where they are expressed and presented for long periods of time. Accessory cells and helper T lymphocytes provide additional signals necessary for B-cell activation, proliferation, and differentiation. A major role is believed to be played by a complex of four proteins associated non-covalently with the membrane immunoglobulin, including CD19 and CD21. These proteins appear to potentiate the signal delivered through occupancy of the binding site on membrane immunoglobulin.

Similar to the TcR, membrane immunoglobulins have short intracytoplasmic domains that do not appear to be involved in signal transmission. At least two heterodimers composed of two different polypeptide chains, termed Ig α and Ig β , with long intracytoplasmic segments are associated to each membrane immunoglobulin. These heterodimers seem to have a dual function:

1. They act as transport proteins, capturing nascent immunoglobulin molecules in the endoplasmic reticulum and transporting them to the cell membrane.
2. They are believed to be the "docking sites" for a family of protein kinases related to the src gene product, including p56^{lck} and p59^{fyn}, that also play a role in T-cell activation. In addition, the phosphatase CD45 is essential for p56^{lck} activation, thus initiating a cascade of tyrosine kinase activation. Specific to B-cell activation is the involvement of a specific protein kinase known as Bruton's tyrosine

kinase (Btk) in the kinase cascade. The critical role of this kinase was revealed when its deficiency was found to be the cause of infantile agammaglobulinemia (Bruton's disease).

The subsequent sequence of events seems to have remarkable similarities to the activation cascade of T lymphocytes. Activation and translocation of common transcription factors (e.g., NF-AT, NF- κ B) induce overlapping but distinct genetic programs. For instance, in B cells NF- κ B activates the expression of genes coding for immunoglobulin polypeptide chains. For a B cell to complete its proliferation and differentiation into antibody-producing plasma cell or memory B cell, a variety of additional signals are required.

In the case of the stimulation of a B-cell response with a T-dependent antigen, the additional signals are delivered by helper T cells in the form of both soluble factors (cytokines) and interactions between complementary ligands (costimulatory molecules) expressed by T cells and B cells. A naive B cell is initially stimulated by recognition of an epitope of the immunogen through the membrane immunoglobulin. Two other sets of membrane molecules are involved in this initial activation—the CD45 molecule and the CD19/CD21/CD81 complex. Whether the activation mediated by CD45 involves interaction with a specific ligand on the accessory cell remains to be determined. In the CD19/CD21/CD81 complex the only protein with a known ligand is CD21, a receptor for C3d (a fragment of the complement component 3, C3). It is possible that B cells interacting with bacteria coated with C3 and C3 fragments may receive a costimulatory signal through the CD19/CD21/CD81 complex.

In the same microenvironment where B lymphocytes are being activated, helper T lymphocytes are also activated. Two possible mechanisms could account for this simultaneous activation:

The same accessory cell (i.e., a macrophage) may present not only membrane-absorbed, unprocessed molecules with epitopes reflective of the native configuration of the immunogenic molecule to B lymphocytes, but also MHC II-associated peptides derived from processed antigen to the helper T lymphocytes (Fig. 4.8).

The B cell may internalize the immunoglobulin-antigen complex, process the antigen, and present MHC II-associated peptides to the helper T cells (Fig. 4.10).

The proper progression of the immune response will require complex interactions between accessory cells (macrophages or B cells), helper T lymphocytes, and B lymphocytes (Fig. 4.11). The helper T cell, as discussed earlier, receives a variety of costimulatory signals from APCs, and the activated helper T cell, in turn, delivers activating signals to APC and B cells. Some of the signals are mediated by interleukins and cytokines, such as IL-2 and IL-4, that stimulate B-cell proliferation and differentiation, and interferon- γ , which increases the efficiency of APC, particularly macrophages. Other signals are mediated by cell-cell interactions involving CD40L (on T cells) and CD40 (on B cells). As a consequence of signaling through the CD40 molecule, B cells express CD80 and CD86, which deliver differentiation signals to T cells through the CD28 family of molecules. Additional activation signals are then delivered.

The differentiation of helper T lymphocytes results in specialized functions to assist B-cell activation and differentiation (T_H2 lymphocytes) and to assist the proliferation and differentiation of cytotoxic T lymphocytes and natural killer (NK) cells (T_H1 lymphocytes). These two subpopulations cannot be defined on the basis of expression of any specific

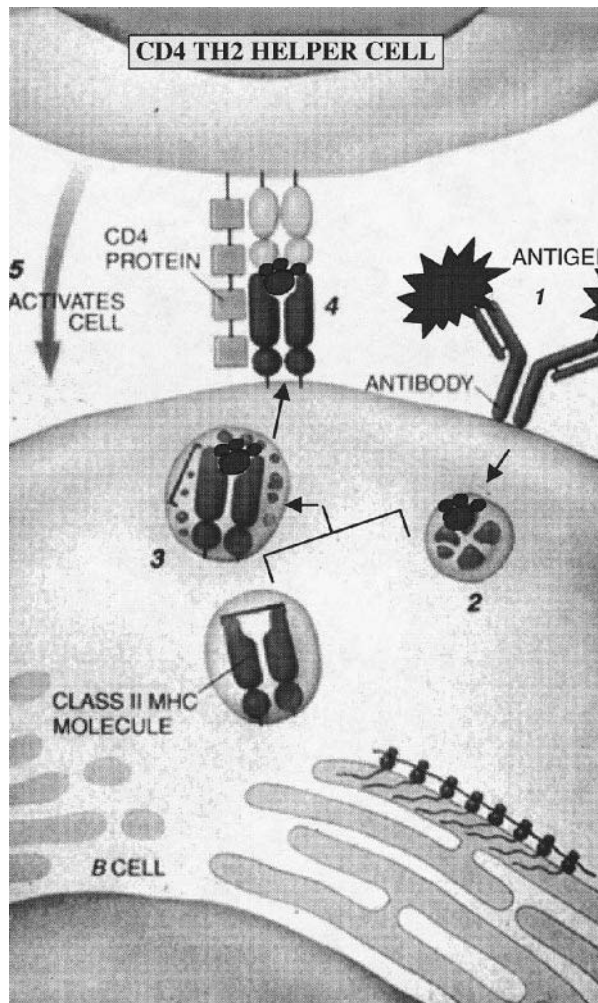

Fig. 4.10 A diagrammatic representation of the induction of a T-dependent B-cell response illustrating the role of a B cell as both an antigen-presenting cell and an effector cell. (Modified from Janeway, C. A. *Scientific American*, 269 (Sept.):73, 1993).

membrane markers. Their definition is based on the repertoire of cytokines they release: T_H1 cells predominantly release $IFN\gamma$ and $TNF\beta$, and T_H2 cells predominantly release IL-4 and IL-10 (Table 4.1).

Several factors appear to control the differentiation of T_H1 and T_H2 . The early stages of proliferation of T_H0 cells (as the common precursors are designated) are IL-2 dependent. IL-2 is the main cytokine released by activated T_H0 cells and has both autocrine and paracrine effects, thus promoting T_H0 proliferation. As the cells continue to proliferate, IL-12 promotes T_H1 differentiation while IL-4 promotes T_H2 differentiation. The cellular source of IL-12 is the APCs, and experimental work suggests that specific antigens or bacterial products with adjuvant properties may induce the release of IL-12 by those cells, thus tilting the immune response towards T_H1 differentiation. The cellular source of the IL-4 needed to initiate the differentiation of T_H2 cells is not clear. Recent research suggests that

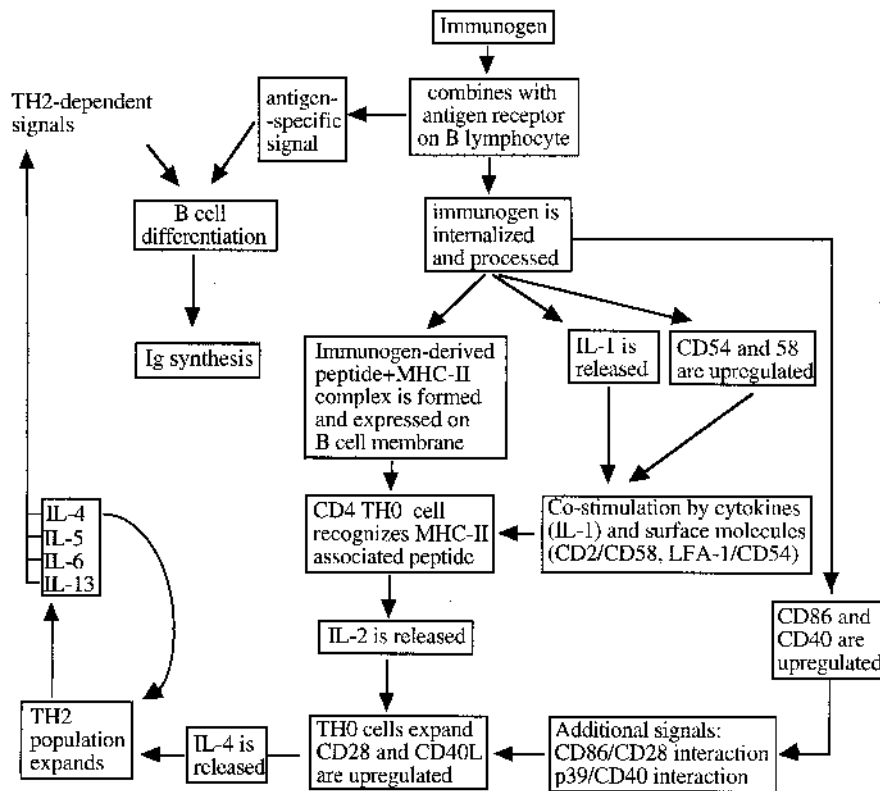

Fig. 4.11 Diagrammatic representation of the sequence of events leading to the stimulation of a T-dependent B-cell response.

Table 4.1 Interleukins and Cytokines Released by T_H1 and T_H2 T Lymphocytes

	Target cell/effect
T_H0 Interleukins/cytokines	
Interleukin-2	T_H0 , T_H1 , and T_H2 cells/expansion; B cells/expansion
T_H1 Interleukins/cytokines	
Interferon- γ	Macrophages/activation; T_H1 cells/differentiation; T_H2 cells/downregulation
Lymphotoxin- α (LT α , TNF β)	T_H1 cells/expansion; B cells/homing
T_H2 Interleukins/cytokines	
Interleukin-4	T_H2 cells/expansion; B cells/differentiation; APC/activation
Interleukin-5	Eosinophils/growth and differentiation
Interleukin-6	B cells/differentiation; plasma cells/proliferation; T_H1 , T_H2 cells/activation; CD8 $^+$ T cells/differentiation, proliferation
Interleukin-10	T_H1 , T_H2 cells/downregulation; B cells/differentiation
Interleukin-13	Monocytes, macrophages/downregulation; B cells/activation, differentiation; mast cells, basophils/activation
T_H1 - T_H2 Interleukins/cytokines	
Interleukin-3	B cells/differentiation; macrophages/activation
TNF	B cells/activation, differentiation
Granulocyte-Monocyte CSF (GM-CSF)	B cells/differentiation

the initial drive towards T_H2 differentiation may be provided by at least two specialized cell populations. One is a special population of $CD4^+$ T cells expressing a marker known as NK1.1, first defined in IL-2-activated NK cells. These T cells carry a high quantity of pre-formed IL-4 in their cytoplasm, ready to be released after proper stimulation. What factors control the activation of this specialized population are not known, but once IL-4 is released and T_H2 cells start to differentiate, these cells continue to release IL-4 and promote further T_H2 differentiation. The other is a subpopulation of dendritic cells known as DC2, which seems to promote T_H2 differentiation independently of IL-4 synthesis. The other DC population, DC1, secretes IL-12 and interferon- α and promotes the differentiation of T_H1 cells.

Several additional factors playing a role in determining T_H1 or T_H2 differentiation have been proposed, including the affinity of the interaction of the TcR with the MHC II-associated peptide, the concentration of MHC-peptide complexes on the cell membrane, and signals dependent on cell-cell interactions (Table 4.2).

Cell-cell contact also plays a significant role in promoting B-cell activation by delivering co-stimulatory signals to the B cell and/or by allowing direct traffic of unknown factors from helper T lymphocytes to B lymphocytes. Transient conjugation between T and B lymphocytes seems to occur constantly due to the expression of complementary CAMs on their membranes. For example, T cells express CD2 and CD4, and B cells express the respective ligands, CD58 (LFA-3) and MHC II; both T and B lymphocytes express ICAM-1 and LFA-1, which can reciprocally interact.

The continuing proliferation and differentiation of B cells into plasma cells is assisted by several soluble factors, including IL-4, released by T_H2 cells, and IL-6 and IL-14 (B-cell growth factor), released by T lymphocytes and accessory cells. At the end of an immune response, the total number of antigen-specific T- and B-lymphocyte clones will remain the same, but the number of cells in those clones will be increased severalfold. The increased residual population of antigen-specific T cells is long-lived and is believed to be responsible for the phenomenon known as immunological memory.

Table 4.2 Signals Involved in the Control of Differentiation of T_H1 and T_H2 Subpopulations of Helper T Lymphocytes

Signals favoring T_H1 differentiation	Signals favoring T_H2 differentiation
Interleukin-12	Interleukin-4 ^a
Interferon- γ ^b	Interleukin-1
Interferon- α ^c	Interleukin-10
CD28/CD80 interaction	CD28/CD86 interaction
High density of MHC-II-peptide complexes on the APC membrane	Low density of MHC-II-peptide complexes on the APC membrane
High affinity interaction between TcR and the MHC-II-peptide complex	Low affinity interaction between TcR and the MHC-II-peptide complex

^a Released initially by undifferentiated T_H cells (also known as T_H0) after stimulation in the absence of significant IL-12 release from APC; IL-4 becomes involved in a autocrine regulatory circuit, which results in differentiation of T_H2 cells and in paracrine regulation of B-cell differentiation.

^b Interferon- γ does not act directly on T_H1 cells but enhances the release of IL-12 by APC and as such has an indirect positive effect on T_H1 differentiation.

^c Interferon α is released by dendritic cells and their circulating precursors.

SELF-EVALUATION

Questions

Choose the one *best* answer.

- 4.1 Which one of the following cytokines, produced by accessory cells, is believed to regulate the differentiation of T_H1 cells?
- A. Interferon- γ
 - B. Interleukin-1
 - C. Interleukin-4
 - D. Interleukin-12
 - E. Tumor necrosis factor
- 4.2 Which of the following concepts is an essential element in our understanding of how a humoral immune response to a T-dependent antigen can be elicited in the absence of monocytes, macrophages, or dendritic cells?
- A. Activated B lymphocytes can process and present MHC-II-associated peptides to helper T lymphocytes
 - B. Activated B lymphocytes must release cytokines that activate helper T cells without requirement for TcR occupancy
 - C. Macrophages do not play a significant role in helper T-lymphocyte activation
 - D. Some TcR must recognize epitopes in unprocessed antigens
 - E. Undifferentiated helper T cells can provide the necessary help for antigen-stimulated B cells to differentiate into antibody-secreting cells.
- 4.3 Which of the following steps of the immune response is likely to be impaired by a deficiency of cytoplasmic transporters associated with antigen processing (TAP-1, TAP-2)?
- A. Assembly of a functional B-cell receptor
 - B. Expression of the CD3-TcR complex
 - C. Formation of stable complexes of viral-derived peptides with MHC-I proteins
 - D. Translocation of nuclear binding proteins from the cytoplasm to the nucleus
 - E. Transport of MHC II peptide complexes to the cell membrane
- 4.4 A significant number of individuals (as high as 1 in 100) fail to develop antibodies after immunization with tetanus toxoid, while other immune responses are perfectly normal. The most likely explanation for this observation is that:
- A. The accessory cells of those individuals are unable to process bacterial proteins.
 - B. The MHC-II proteins expressed on those individuals' accessory cells do not accommodate the peptides derived from processing of tetanus toxoid
 - C. The repertoire of membrane immunoglobulins lacks variable regions able to accommodate the dominant epitopes of tetanus toxoid.
 - D. Those individuals lack a critical gene that determines the ability to respond to toxoids.
 - E. Those individuals lack TcR specific for tetanus toxoid-derived peptides
- 4.5 A rabbit has been immunized with DNP-BSA. Three weeks later you want to

- induce an anamnestic response to DNP-BGG. This can be accomplished by:
- Boosting with DNP one week before immunization with DNP-BGG
 - Immunizing with BGG one week after the initial immunization with DNP-BSA
 - Passively administering anti-BGG antibodies before immunization with BGG
 - Passively administering anti-DNP antibodies prior to challenging with DNP-BGG
 - Transfusing purified lymphocytes from a rabbit primed with DNP at least 2 days before challenging with DNP-BGG
- 4.6 What do you expect when you immunize a congenitally athymic (nude) mouse with type III pneumococcal polysaccharide?
 - Development of an overwhelming pneumococcal infection
 - No evidence of specific antibody synthesis
 - No immune response, either cellular or humoral
 - Production of significant amounts of IgG antibodies
 - Production of significant amounts of IgM antibodies
 - 4.7 Alloantigens are best defined as antigens:
 - Identically distributed in *all* individuals of the same species
 - That define protein isotypes
 - That differ in distribution in individuals of the same species
 - Unique to human immunoglobulin G (IgG)
 - That do not induce an immune response in animals of the same species
 - 4.8 Which of the following sets of characteristics is most closely associated with haptens?
 - Constituted by repeating units, able to induce responses in sublethally irradiated mice reconstituted with B cells only
 - Do not induce an immune response by themselves, but induce antibody formation when coupled to an immunogenic molecule
 - Induce cellular immune responses but not antibody synthesis
 - Induce tolerance when injected intravenously in soluble form and induce an immune response when injected intradermally
 - Simple compounds able to interact directly with MHC molecules
 - 4.9 Cells obtained from the tissues of an animal infected with *Leishmania major*, an intracellular parasite, show increased transcription of mRNA for IL-4 and IL-10. The synthesis of these two cytokines can be interpreted as meaning that:
 - Antibody levels to *L. major* are likely to be elevated.
 - IL-12 mRNA is also likely to be overexpressed in the same tissues.
 - Th1 cells are actively engaged in the immune response against the parasite.
 - The ability of infected macrophages to eliminate *L. major* is enhanced.
 - The mice carry an expanded population of cytotoxic T cells able to destroy *L. major*-infected cells.
 - 4.10 Which of the following procedures is *less* likely to enhance antigenicity?
 - Chemical polymerization of the antigen
 - High-speed centrifugation to eliminate aggregates
 - Immunization on antigen obtained from a phylogenetically distant species to that of the animal immunized

- D. Injection of an antigen-adjuvant emulsion
- E. Intradermal injection

Answers

- 4.1 (D) Interleukin-12 is released by accessory cells (particularly monocytes and macrophages) and is believed to be one of the primary determinants of the differentiation of T_H1 lymphocytes. Interleukin 4, released by activated T cells in the absence of a co-stimulatory signal from IL-12, plays a similar role in the differentiation of the T_H2 population.
- 4.2 (A) B lymphocytes express MHC-II molecules, and although they are not phagocytic cells, there is evidence suggesting that the mIg-antigen complex is internalized, the antigen is broken down, and peptides derived from it are coupled with MHC-II molecules and presented to helper T cells.
- 4.3 (C) The TAP proteins transport peptides derived from newly synthesized proteins (endogenous or viral) into the endoplasmic reticulum, where the peptides form complexes with newly synthesized MHC-I molecules. Those complexes are then transported and expressed on the cell membrane.
- 4.4 (B) The differences in the level of immune response seen among different individuals of the same species is believed to depend on the repertoire of MHC-II molecules and their relative affinity towards the small peptides derived from the processing of the antigen in question. The existence of immune response genes transmitted in linkage disequilibrium with the MHC-II genes is an older theory now abandoned. The genes controlling immunoglobulin synthesis have a significant impact on the total repertoire of B-cell membrane immunoglobulins, but the lack of a given antigen-binding site is not as likely to result in a low response to a complex antigen, which presents many different epitopes to the immune system. The lack of helper T cells with specific receptors for toxoid-derived peptides is also unlikely, given the great diversity of TcR that exists in a normal individual. A general deficiency in processing would cause a general lack of responsiveness, not a specific inability to respond to one given immunogen.
- 4.5 (B) The development of a “memory” response (quantitatively amplified relative to the primary response) requires preimmunization with the carrier. Hence, the animal needs to be previously immunized either with the same hapten-carrier conjugate used to induce the secondary immune response or with the carrier alone.
- 4.6 (E) Polysaccharides are T-independent antigens and induce responses of the IgM type in mice, even if these mice lack T cells. Athymic mice obviously will lack T cells, because this population differentiates in the thymus. Infection will not occur as a consequence of injecting the isolated capsular polysaccharide of any bacteria.
- 4.7 (C) The A, B, and O antigens or the immunoglobulin allotypes are examples of alloantigens. Alloantigens can be immunogenic in individuals of a different genetic makeup.

- 4.8 (B)
- 4.9 (A) IL-4 and IL-10 synthesis are characteristic of a T_H2 response, associated with B-cell activation but with lack of differentiation of cytotoxic T cells and NK cells. IL-12 synthesis would induce a T_H1 response, with overproduction of IL-2 and TNF. The infected animals are not likely to eliminate the infection, since antibodies are not effective against intracellular organisms.
- 4.10 (B) Soluble proteins are *less* immunogenic than aggregated or polymerized proteins.

BIBLIOGRAPHY

- Bottomly K. T cells and dendritic cells get intimate. *Science*, 283:1124, 1999.
- Burn, G. J., Falls, E. L., Nilson, A. E., and Abraham, R. T. Protein tyrosine kinase-dependent activation of STAT transcription factors in interleukin-2 or interleukin-4 stimulated T lymphocytes. *J. Biol. Chem.*, 270:11628, 1995.
- Constant, S., Pfeiffer, C., Woodard, A., Pasqualini, T., and Bottomly, K. Extent of T cell receptor ligation can determine functional differentiation of naive CD4⁺ T cells. *J. Exp. Med.*, 182:1591, 1995.
- Duronio, V., Scheid, M., and Ettinger, S. Downstream signalling events regulated by phosphatidylinositol 3-kinase activity. *Cell. Signal.*, 10:233–239, 1998.
- Dustin, M. L., and Shaw, A. S. Costimulation: Building an immunological synapse. *Science*, 283:649, 1999.
- Farrar, M., Doerfler, P., and Sauer, K. Signal transduction pathways regulating the development of αβ T cells. *Biochim. Biophys. Acta*, 1377:F35–F78, 1998.
- Fruman, D., Meyers, R., and Cantley, L. Phosphoinositide kinases. *Annu. Rev. Biochem.*, 67:481, 1998.
- Garcia, K., Teyton, L., and Wilson, I. Structural basis of T cell recognition. *Annu. Rev. Immunol.*, 17:369, 1999.
- Garside, P., Ingulli, E., Merica, R. R., Johnson, J. G., Noelle, R. J., and Jenkins, M. K. Visualization of specific B and T lymphocyte interactions in the lymph node. *Science*, 281:96, 1998.
- Germain, R. N., and Stefanova, I. The dynamics of T cell receptor signaling: complex orchestration and the key roles of tempo and cooperation. *Annu. Rev. Immunol.*, 17:467, 1999.
- June, C. H., Bluestone, J. A., Nadler, L. M., and Thompson, C. B. The B7 and CD28 receptor families. *Immunol. Today*, 15:321, 1994.
- Justement, L. B., Brown, V. K., and Lin, J. Regulation of B-cell activation by CD45: a question of mechanism. *Immunol. Today*, 15:399, 1994.
- Lane, P., Flynn, S., Walker, L., et al. CD4 cytokine differentiation—Who or what decides? *Immunologist*, 6:182, 1998.
- Lesnchow, J., Walunas, T., and Bluestone, J. CD28/B7 system of T cell costimulation. *Annu. Rev. Immunol.*, 14:233–58, 1996.
- Noelle, R. J. The role of gp39 (CD40L) in immunity. *Clin. Immunol. Immunopath.*, 76:S203, 1995.
- Shanafelt, M.-C., Sondberg, C., Allsup, A., Adelman, D., Peltz, G., and Lahesmaa, R. Costimulatory signals can selectively modulate cytokine production by subsets of CD4⁺ T cells. *J. Immunol.*, 154:1684, 1995.
- Wilson, I., and Garcia, K. T-cell receptor structure and TCR complexes. *Struct. Bio.*, 7:839–848, 1997.

5

Immunoglobulin Structure

Gabriel Virella

I. INTRODUCTION

Information concerning the precise structure of the antibody molecule started to accumulate as technological developments were applied to the study of the general characteristics of antibodies. By the early 1940s antibodies had been characterized electrophoretically as gamma-globulins (Fig. 5.1) and also classified into large families by their sedimentation coefficient, determined by analytical ultracentrifugation (7S and 19S antibodies). It also became evident that plasma cells were responsible for immunoglobulin synthesis and that a malignancy known as multiple myeloma was a malignancy of immunoglobulin-producing plasma cells.

As protein fractionation techniques became available, complete immunoglobulins and their fragments were isolated in large amounts, particularly from the serum and urine of patients with multiple myeloma. These proteins were used both for studies of chemical structure and for immunological studies allowed to identify antigenic differences between proteins from different patients; this was the basis for the initial identification of the different classes and subclasses of immunoglobulins and the different types of light chains.

II. IMMUNOGLOBULIN G (IgG): THE PROTOTYPE IMMUNOGLOBULIN MOLECULE

A. General Considerations

IgG, a 7S immunoglobulin, is the most abundant immunoglobulin in human serum and in the serum of most mammalian species. It is also the immunoglobulin most frequently de-

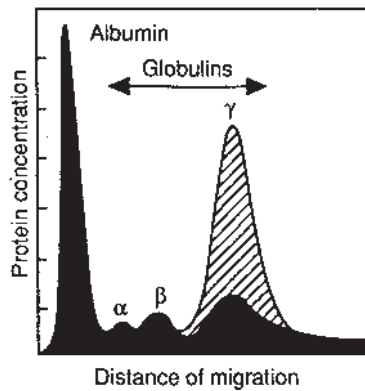

Fig. 5.1 Demonstration of the gamma globulin mobility of circulating antibodies. The serum from a rabbit hyperimmunized with ovalbumin showed a very large gamma globulin fraction (shaded area), which disappeared when the same serum was electrophoretically separated after removal of antibody molecules by specific precipitation with ovalbumin. In contrast, serum albumin and the remaining globulin fractions were not affected by the precipitation step. (Redrawn after Tiselius, A., and Kabat, E. A. *J. Exp. Med.*, 69:119, 1939.)

tected in large concentrations in multiple myeloma patients. For this reason it was the first immunoglobulin to be purified in large quantities and to be extensively studied from the structural point of view. The basic knowledge about the structure of the IgG molecule was obtained from two types of experiments:

1. *Proteolytic digestion.* The incubation of purified IgG with papain, a proteolytic enzyme extracted from the latex of *Carica papaya*, results in the splitting of the molecule in two fragments that differ both in charge and antigenicity. These fragments can be easily demonstrated by immunoelectrophoresis (Fig. 5.2), a technique that separates proteins by charge in a first step, allowing their antigenic characterization in a second step.
2. *Reduction of disulfide bonds.* If the IgG molecule is incubated with a reducing agent containing free SH groups and fractionated by gel filtration (a technique which separates proteins by size) in conditions able to dissociate noncovalent interactions, two fractions are obtained. The first fraction corresponds to polypeptide chains of MW 55,000 (heavy chains); the second corresponds to polypeptide chains of MW 23,000 (light chains) (Fig. 5.3).

The sum of data obtained by proteolysis and reduction experiments resulted in the conception of a diagrammatic two-dimensional model for the IgG molecule (Fig. 5.4). The

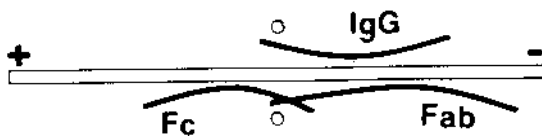

Fig. 5.2 Immunoelectrophoretic separation of the fragments resulting from papain digestion of IgG. A papain digest of IgG was first separated by electrophoresis, and the two fragments were revealed with an antiserum containing antibodies that react with different portions of the IgG molecule.

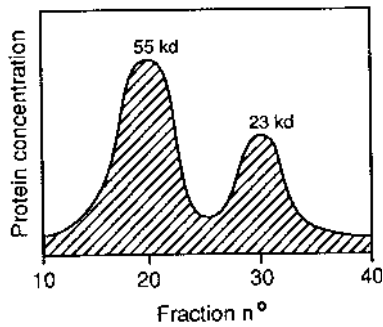

Fig. 5.3 Gel filtration of reduced and alkylated IgG (MW 150,000) on a dissociating medium. Two protein peaks are eluted, the first corresponding to a MW of 55,000 and the second corresponding to a MW of 23,000. The 2:1 ratio of protein content between the high and low molecular weight peaks is compatible with the presence of identical numbers of two polypeptide chains, one of which is about twice as large as the other.

results of proteolytic digestion experiments can be reanalyzed on the basis of this model:

1. Papain splits the heavy chains in the hinge region (so designated because this region of the molecule appears to be stereoflexible) and results in the separation of two Fab fragments and one Fc fragment per IgG molecule (Fig. 5.5). The Fab fragments are so designated because they contain the antigen-binding site, while the Fc fragment received this designation because it can be easily crystallized.

If the disulfide bond joining heavy and light chains in the Fab fragments is split, one can separate a complete light chain from a fragment that comprises about half of one of the heavy chains, the NH₂-terminal half. This portion of the heavy chain contained in each Fab fragment has been designated as Fd fragment.

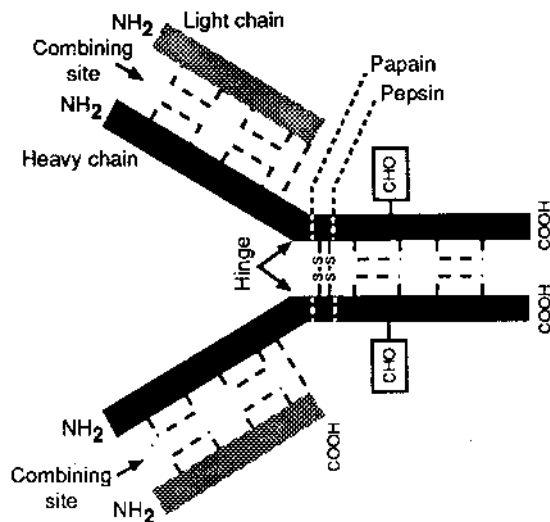

Fig. 5.4 Diagrammatic representation of the IgG molecule. (Modified from Klein, J. *Immunology*. Blackwell Scientific Publishers, Boston/Oxford, 1990.)

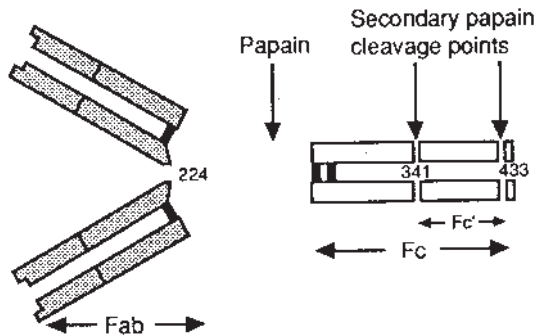

Fig. 5.5 The fragments obtained by papain digestion of the IgG molecule. (Modified from Klein, J. *Immunology*. Blackwell Scientific Publishers, Boston/Oxford, 1990.)

2. A second proteolytic enzyme, pepsin, splits the heavy chains beyond the disulfide bonds that join them at the hinge region, producing a double Fab fragment or $F(ab')_2$ (Fig. 5.6), while the Fc portion of the molecule is digested into peptides. The comparison of Fc, Fab, $F(ab')_2$, and whole IgG molecules shows both important similarities and differences between the whole molecule and its fragments.
 - a. Both Fab and $F(ab')_2$ contain antibody-binding sites, but while the intact IgG molecule and the $F(ab')_2$ are bivalent, the Fab fragment is monovalent. Therefore, a Fab fragment can bind to an antigen but cannot cross-link two antigen molecules.
 - b. An antiserum raised against the Fab fragment reacts mostly against light-chain determinants; the immunodominant antigenic markers for the heavy chain are located in the Fc fragment.
 - c. The $F(ab')_2$ fragment is identical to the intact molecule as far as antigen-binding properties, but lacks the ability to fix complement, bind to cell membranes, etc., characteristics determined by the Fc region of the molecule.

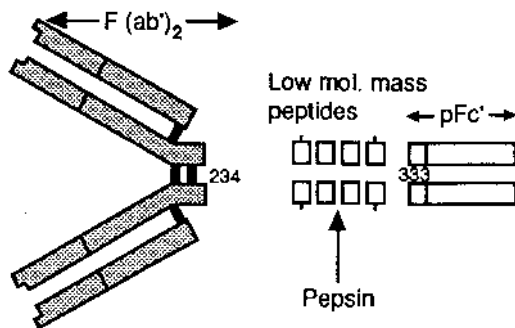

Fig. 5.6 The fragments obtained by pepsin digestion of the IgG molecule. (Modified from Klein, J. *Immunology*. Blackwell Scientific Publishers, Boston/Oxford, 1990.)

III. STRUCTURAL AND ANTIGENIC HETEROGENEITY OF HEAVY AND LIGHT CHAINS

As larger numbers of purified immunoglobulins were studied in detail, it became obvious that there was a substantial degree of structural heterogeneity, recognizable both by physicochemical methods as well as by antisera able to define different antigenic types of heavy and light chains.

Five classes of immunoglobulins were identified due to antigenic differences of the heavy chains and designated as IgG (the classical 7S immunoglobulin), IgA, IgM (the classical 19S immunoglobulin), IgD, and IgE. IgG, IgA, and IgM together constitute over 95% of the whole immunoglobulin pool in a normal human being and are designated as major immunoglobulin classes. Because they are common to all humans, the immunoglobulin classes can also be designated as isotypes. The major characteristics of the five immunoglobulin classes are summarized in Table 5.1.

The light chains also proved to be antigenically heterogeneous and two isotypes were defined: kappa and lambda. Each immunoglobulin molecule is constituted by a pair of identical heavy chains and a pair of identical light chains; hence, a given immunoglobulin molecule can have either kappa or lambda chains but not both. A normal individual will have a mixture of immunoglobulin molecules in his serum, some with kappa chains (e.g., IgG κ), and others with lambda chains (e.g., IgG λ). Normal serum IgG has a 2:1 ratio of kappa chain–over lambda chain–bearing IgG molecules. In contrast, monoclonal immunoglobulins have one single heavy-chain isotype and one single light-chain isotype. This results from the fact that monoclonal proteins are the products of large number of cells all derived from a single mutant, constituting one large clone of identical cells producing identical molecules.

Antigenic differences between the heavy chains of IgG and IgA were later characterized and, based on them, IgG and IgA subclasses were defined (Tables 5.2 and 5.3). Some interesting biological and structural differences have been demonstrated for IgG and IgA proteins of different subclasses.

In the case of IgG subclasses, IgG1 and IgG3 are more efficient in terms of complement fixation and have greater affinity for monocyte receptors. Those properties can be correlated with a greater degree of biological activity, both in normal antimicrobial responses and in pathological conditions. Physiologically, these properties result in enhanced

Table 5.1 Major Characteristics of Human Immunoglobulins

	IgG	IgA	IgM	IgD	IgE
Heavy-chain class	γ	α	μ	δ	ϵ
H-chain subclasses	γ 1,2,3,4	α 1,2	—	—	—
L-chain type	κ and λ	κ and λ	κ and λ	κ and λ	κ and λ
Sedimentation coefficient	7S	7S, 9S, 11S	19S	7–8S	8S
Polymeric forms	no	Dimers, trimers	Pentamers	no	no
Molecular weight	150,000	(160,000) n	900,000	180,000	190,000
Serum concentration (mg/dL)	600–1300	60–300	30–150	3	0.03
Intravascular distribution	45%	42%	80%	75%	51%

Table 5.2 IgG Subclasses

	IgG1	IgG2	IgG3	IgG4
% of total IgG in normal serum	60%	30%	7%	3%
Half-life (days)	21	21	7	21
Complement fixation ^a	++	+	+++	–
Segmental flexibility	+++	+	++++	++
Affinity for monocyte and PMN receptors	+++	+	++++	+
Binding to protein A ^b	++	++	–	++
Binding to protein G ^c	+++	+++	+++	+++

^a By the classical pathway.

^b A protein isolated from select strains of *Staphylococcus aureus*, which has the ability to bind IgG of different species, including human.

^c A protein similar to protein A, but isolated from Group G streptococci, which also binds IgG proteins of different species.

opsonization and bacterial killing, Pathologically, the formation of immune complexes containing IgG1 and IgG3 antibodies is more likely to cause tissue inflammation.

From the structural point of view, the IgG3 subclass has the greatest number of structural and biological differences relative to the remaining IgG subclasses. Most differences appear to result from the existence of an extended hinge region (which accounts for the greater MW) and with a large number of disulfide bonds linking the heavy chains together (estimates of their number vary between 5 and 15). This extended hinge region seems to be easily accessible to proteolytic enzymes, and this lability of the molecule is likely to account for its considerably shorter half-life.

Of the two IgA subclasses known, it is interesting to note that a subpopulation of IgA2 molecules carrying the A2m(1) allotype is the only example of a human immunoglobulin molecule lacking the disulfide bond joining heavy and light chains. The IgA2 A2m(1) molecule is held together through noncovalent interactions between heavy and light chains.

IV. IMMUNOGLOBULIN REGIONS AND DOMAINS

A. Variable and Constant Regions of the Immunoglobulin Molecule

The light chains of human immunoglobulins are composed of 211–217 amino acids. As mentioned above, there are two major antigenic types of light chains (κ and λ). When the amino acid sequences of light chains of the same type were compared, it became evident

Table 5.3 IgA Subclasses

	IgA1	IgA2
Distribution	Predominates in serum	Predominates in secretions
Proportions in serum	85%	15%
Allotypes	?	A2m(1) and A2m(2)
H-s-s-L	+	– in A2m(1); + in A2m(2)

that two regions could be distinguished in the light-chain molecules: a variable region, comprising the portion between the amino-terminal end of the chain and residues of 107–115, and a constant region, extending from the end of the variable region to the carboxyl terminus (Fig. 5.7).

The light-chain constant regions were found to be almost identical in light chains of the same type, but to differ markedly in κ and λ chains. It is assumed that the difference in antigenicity between the two types of light chains is directly correlated with the structural differences in constant regions.

In contrast, the amino acid sequence of the light-chain variable regions is different even in proteins of the same antigenic type, and early workers thought that this sequence would be totally individual for any single protein. With increasing data, it became evident that some proteins shared similarities in their variable regions, and it has been possible to classify variable regions into three groups: $V\kappa$, $V\lambda$, and VH . Each group has been further subdivided into several subgroups. The light-chain V region subgroups ($V\kappa$, $V\lambda$) are “type” specific, i.e., $V\kappa$ subgroups are only found in κ proteins and $V\lambda$ subgroups are always associated with λ chains. In contrast, the heavy-chain V region subgroups (VH) are not “class” specific. Thus, any given VH subgroup can be found in association with the heavy chains of any of the known immunoglobulin classes and subclasses.

The heavy chain of IgG is about twice as large as a light chain; it comprises approximately 450 amino acids, and a variable and a constant region can also be identified. The variable region is constituted by the first 113–121 amino acids (counted from the amino-

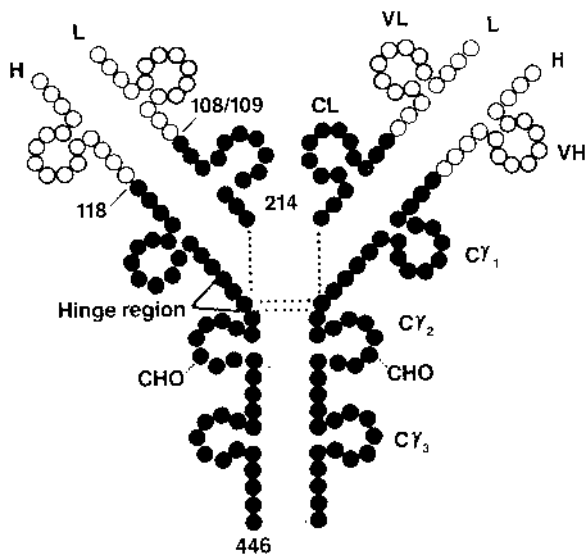

Fig. 5.7 Schematic representation of the primary and secondary structure of a human IgG. The light chains are constituted by about 214 amino acids and two regions, variable (first 108 amino acids, white beads in the diagram) and constant (remaining amino acids, black beads in the diagram). Each of these regions contains a loop formed by intrachain disulfide bonds and containing about 60 amino acids, which are designated as variable domain and constant domain (VL and CL in the diagram). The heavy chains have slightly longer variable regions (first 118 amino acids, white beads in the diagram), with one domain (VH) and a constant region that contains three loops or domains ($C\gamma_1$, $C\gamma_2$, and $C\gamma_3$), numbered from the NH_2 terminus to the $COOH$ terminus.

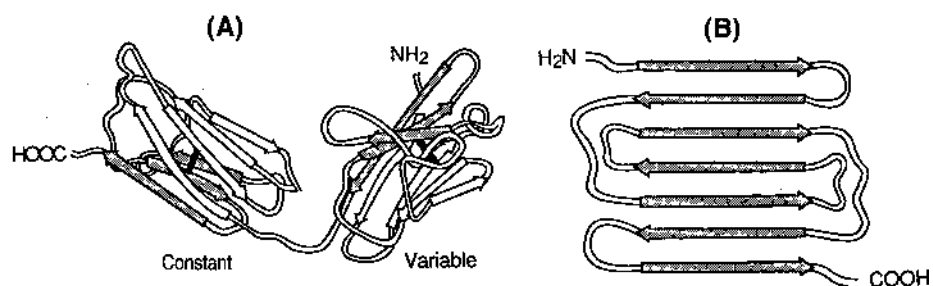

Fig. 5.8 Model for the V and C domains of a human immunoglobulin light chain. Each domain has two β -pleated sheets consisting of several antiparallel β strands of 5–10 amino acids. The interior of each domain is formed between the two β sheets by in-pointing amino acid residues, which alternate with out-pointing hydrophilic residues, as shown in (A). The antiparallelism of the β -strands is diagrammatically illustrated in (B). This β -sheet structure is believed to be the hallmark of the extracellular domains of all proteins in the immunoglobulin superfamily. [(A) modified from Edmundson, A. B., Ely, K. R., Abola, E. E., Schiffer, M., and Panagiotopoulos, N. *Biochemistry*, 14:3953, 1975; (B) modified from Amzel, L. M., and Poljak, R. J. *Ann. Rev. Biochem.*, 48:961, 1979.]

terminal end), and subgroups of these regions can also be identified. The constant region is almost three times larger; for most of the heavy chains, it starts at residue 116 and ends at the carboxyl terminus (Fig. 5.7). The maximal degree of homology is found between constant regions of IgG proteins of the same subclass.

B. Immunoglobulin Domains

The immunoglobulin molecule contains several disulfide bonds formed between contiguous residues. Some of them join two different polypeptide chains (interchain disulfide bonds), keeping the molecule together. Others (intrachain bonds) join different areas of the same polypeptide chain, leading to the formation of “loops.” These loops and adjacent amino acids constitute the immunoglobulin domains, which are folded in a characteristic β -pleated-sheet structure (Fig. 5.8).

The variable regions of both heavy and light chains have a single domain, which is involved in antigen binding. Light chains have one single constant region domain (CL), while heavy chains have several constant region domains (three in the case of IgG, IgA, and IgD; four in the case of IgM and IgE). The constant region domains are generically designated as C_{H1} , C_{H2} , and C_{H3} , or if one wishes to be more specific, they can be identified as to the class of immunoglobulins to which they belong by adding the symbol for each heavy chain class ($\gamma, \alpha, \mu, \delta, \epsilon$). For example, the constant region domains of the IgG molecule can be designated as $C\gamma1$, $C\gamma2$, and $C\gamma3$. Different functions have been assigned to the different domains and regions of the heavy chains. For instance, $C\gamma2$ is the domain involved in complement fixation, while both $C\gamma2$ and $C\gamma3$ are believed to be involved in the binding to phagocytic cell membranes.

The “hinge region” is located between $CH1$ and $CH2$, and its name is derived from the fact that studies by a variety of techniques, including fluorescence polarization, spin labeling, electron microscopy, and x-ray crystallography, have shown that the Fab fragments can rotate and waggle, coming together or moving apart. As a consequence IgG molecules can change their shape from an “Y” to a “T” and vice versa using the region intercalated between $C\gamma1$ and $C\gamma2$ as a hinge. The length and primary sequence of the hinge regions

play an important role in determining the segmental flexibility of IgG molecules. For example, IgG3 has a 12-amino-acid hinge amino-terminal segment and has the highest segmental flexibility. The hinge region is also the most frequent point of attack by proteolytic enzymes. In general, the resistance to proteolysis of the different IgG subclasses is inversely related to the length of the hinge amino-terminal segments—IgG3 proteins are the most easily digestible, while IgG2 proteins, with the shortest hinge region, are the most resistant to proteolytic enzymes.

V. THE IMMUNOGLOBULIN SUPERFAMILY OF PROTEINS

The existence of globular “domains” (Fig. 5.8) is considered as the structural hallmark of immunoglobulin structure. A variety of other proteins that exhibit amino acid sequence homology with immunoglobulins also contain Ig-like domains (Fig. 5.9). Such proteins are

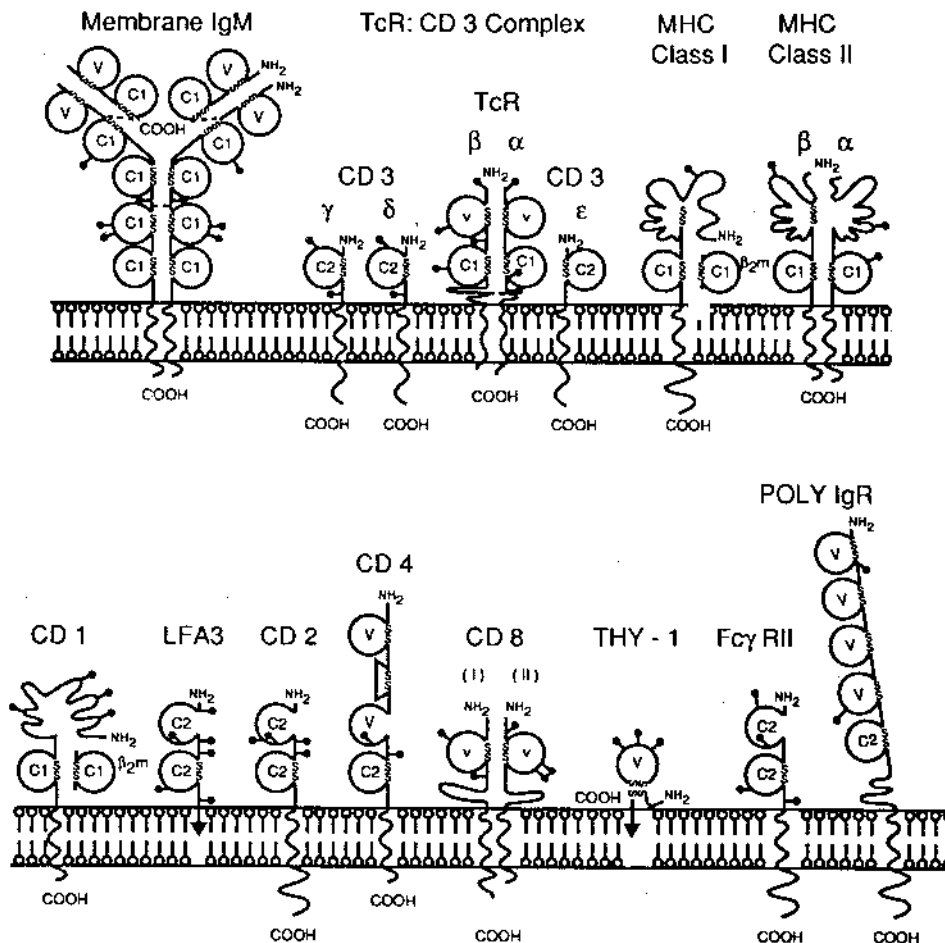

Fig. 5.9 Model representations for some proteins included in the immunoglobulin superfamily. (Modified from Williams, A. F., and Barclay, A. N. The immunoglobulin superfamily—domains for cell surface recognition. *Ann. Rev. Immunol.*, 6:381, 1988.)

Immunoglobulin Structure

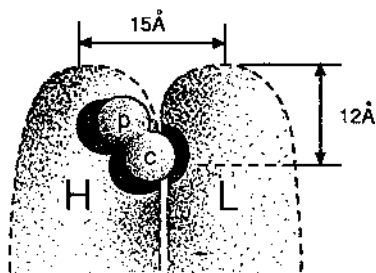

Fig. 5.10 Diagrammatic representation of the hypothetical structure of an antigen-binding site. The variable regions of the light and heavy chains of a mouse myeloma protein, which binds specifically the phosphorylcholine haptent, form a pouch in which the haptent fits. In this particular example the specificity of the binding reaction depends mostly on the structure of the heavy-chain V region. (Modified from E. Padlan et al. In: *The Immune System: Genes, Receptors, Signals* (E. Sercarz, A. Williamson, and C. Fox, eds.). Academic Press, New York, 1975, p. 7.)

considered as members of the immunoglobulin superfamily, based on the assumption that the genes that encode them must have evolved from a common ancestor gene coding for a single domain, much like the gene coding for the Thy-1 molecule found on murine lymphocytes and brain cells.

The majority of the membrane proteins of the immunoglobulin superfamily seem to be functionally involved in recognition of specific ligands, which may determine cell-cell contact phenomena and/or cell activation. The T-cell antigen receptor molecule, the major histocompatibility antigens, the polyimmunoglobulin receptor on mucosal cells (see below), and the CD2 molecule on T lymphocytes (see Chapters 10 and 11) are a few examples of proteins included in the immunoglobulin superfamily.

VI. THE ANTIBODY-COMBINING SITE

As mentioned earlier, the binding of antigens by antibody molecules takes place in the Fab region and is basically a noncovalent interaction that requires a good fit between the antigenic determinant and the antigen-binding site on the immunoglobulin molecule. The antigen-binding site appears to be formed by the variable regions of both heavy and light chains, folded in close proximity forming a pouch where an antigenic determinant or epitope will fit (Fig. 5.10).

Actually, certain sequence stretches of the variable regions vary widely from protein to protein, even among proteins sharing the same type of variable regions. For this reason, these highly variable stretches have been designated as hypervariable regions. The structure of hypervariable regions is believed to play a critical role in determining antibody specificity since these regions are believed to be folded in such a way that they form a "pouch" where a given epitope of an antigen will fit. In other words, the hypervariable regions will interact to create a binding site whose configuration is *complementary* to that of

a given epitope. Thus, these regions can be also designated as complementarity-determining regions.

VII. IMMUNOGLOBULIN M: A POLYMERIC MOLECULE

Serum IgM is basically constituted by five subunits (monomeric subunits, IgMs), each of which is constituted by two light chains (κ or λ) and two heavy chains (μ). The heavy chains are larger than those of IgG by about 20,000 daltons, corresponding to an extra domain on the constant region ($C\mu 4$). A third polypeptide chain, the J chain, can be revealed by adequate methodology in IgM molecules. This is a small polypeptide chain of 15,000 daltons, also found in polymeric IgA molecules. One single J chain is found in any polymeric IgM or IgA molecule, irrespective of how many monomeric subunits are involved in the polymerization process. It has been postulated that this chain plays some role in the polymerization process.

VIII. IMMUNOGLOBULIN A: A MOLECULARLY HETEROGENEOUS IMMUNOGLOBULIN

Serum IgA is molecularly heterogeneous, comprised of a mixture of monomeric, dimeric, and larger polymeric molecules. In a normal individual, over 70–90% of serum IgA is monomeric. Monomeric IgA is similar to IgG, consisting of two heavy chains (α) and two light chains (κ or λ). The dimeric and polymeric forms of IgA found in circulation are covalently bonded synthetic products containing J chains.

IgA is the predominant immunoglobulin in secretions. Secretory IgA molecules are most frequently dimeric, contain a J chain, as do all polymeric immunoglobulin molecules, and in addition contain a unique polypeptide chain, the secretory component (SC) (Fig. 5.11). A single polypeptide chain of approximately 70,000 daltons, with five homologous

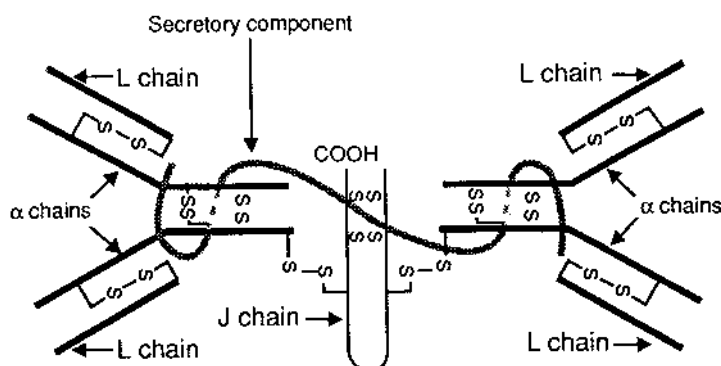

Fig. 5.11 Structural model of the secretory IgA molecule. (Modified from Turner, M. W. In: *Immunochimistry: an Advanced Textbook* (L. E. Glynn and M. W. Steward, eds.). J. Wiley & Sons, New York, 1977.)

immunoglobulin-like domains, constitutes this unique protein. It is synthesized by epithelial cells in the mucosa and by hepatocytes, initially as a larger membrane molecule known as polyimmunoglobulin receptor, from which SC is derived by proteolytic cleavage separating SC from the intramembrane and cytoplasmic segments of its membrane form (see Chapter 6).

IX. THE MINOR IMMUNOGLOBULIN CLASSES: IgD AND IgE

IgD and IgE were the last immunoglobulins to be identified, due to their low concentrations in serum and low frequency of patients with multiple myeloma producing them. Both are monomeric immunoglobulins, similar to IgG, but their heavy chains are larger than γ chains. IgE has five domains in the heavy chain (one variable and four constant); IgD has four heavy-chain domains (as most other monomeric immunoglobulins).

IgD and IgM are the predominant immunoglobulin classes in the B-lymphocyte membrane, where they are the antigen-binding molecules in the antigen-receptor complex. Membrane IgD and IgM are monomeric. The heavy chains of membrane IgD and IgM (δ_m , μ_m) differ from those of the secreted forms at their carboxyl termini, where the membrane forms have a hydrophobic transmembrane section and a short cytoplasmic tail, which are lacking in the secreted forms. In contrast, a hydrophilic section is found at the carboxyl termini of heavy chains of secreted immunoglobulins. The membrane immunoglobulins form a membrane complex with several other membrane proteins, including $Ig\alpha$ and $Ig\beta$, which have sequence motifs in their cytoplasmic portions that are required for signal transduction. No other biological role is known for IgD besides existing as a membrane immunoglobulin.

IgE has the unique property of binding to Fc_ϵ receptors on the membranes of mast cells and basophils. The binding of IgE to those receptors has an extremely high affinity ($7.7 \times 10^9 \text{ I/M}^{-1}$), about 100-fold greater than the affinity of IgG binding to monocyte receptors. The high-affinity binding of IgE to basophil membrane receptors depends on the configuration of $C\epsilon_3$ and $C\epsilon_4$ domains and is the basis for the designation of IgE as homocytotropic antibody. In allergic individuals, if those IgE molecules have a given antibody specificity and react with the antigen while attached to the basophil or mast cell membranes, they will trigger the release of histamine and other substances, which cause the symptoms of allergic reactions (see Chapter 21).

SELF-EVALUATION

Questions

Choose the one *best* answer.

- 5.1 Which of the following antibodies would be most useful to assay human secretory IgA in secretions?
 - A. Anti-IgA1
 - B. Anti-IgA2
 - C. Anti-J chain
 - D. Anti-kappa light chains
 - E. Anti-secretory component

- 5.2 Which of the following is a likely event resulting from the mixture of an F(ab')₂ fragment of a given antibody with the corresponding antigen?
- A. Formation of a precipitate if the antigen is multivalent
 - B. Formation of a precipitate with both univalent and monovalent antigens
 - C. Formation of soluble complexes containing one single molecule of F(ab')₂ and one single molecule of divalent antigen
 - D. Inhibition of the ability of a multivalent antigen to react with a complete antibody
 - E. Lack of precipitation with any type of antigen
- 5.3 The antigen-binding sites of an antibody molecule are determined by the structure of the:
- A. Constant region of heavy chains
 - B. Constant region of light chains
 - C. Variable region of heavy chains
 - D. Variable region of light chains
 - E. Variable regions of both heavy and light chains
- 5.4 The immunoglobulin class that binds with very high affinity to membrane receptors on basophils and mast cells is:
- A. IgG₁
 - B. IgA
 - C. IgM
 - D. IgD
 - E. IgE
- 5.5 A preparation of pooled normal human IgG injected into rabbits will *not* induce the production of antibodies against:
- A. Gamma heavy chains
 - B. Gamma 3 heavy chains
 - C. J chain
 - D. Kappa light chains
 - E. Lambda light chains
- 5.6 Which feature of IgG₃ molecules is believed to be related to their increased sensitivity to proteolytic enzymes?
- A. Extended, rigid hinge region
 - B. Extra constant region domain
 - C. High affinity for Fc receptors
 - D. High carbohydrate content
 - E. Tendency to form aggregates
- 5.7 The basic characteristic which defines a protein as belonging to the immunoglobulin superfamily is the:
- A. Ability to combine specifically with antigenic substances
 - B. Existence of β -pleated-sheet regions in the polypeptide chains
 - C. Homology of the NH-terminal regions
 - D. Identification of variable and constant regions
 - E. Sharing of common antigenic determinants

Match in Figure 5.12 the regions of an IgG molecule indicated by letters with the corresponding descriptions in Questions 5.8–5.10.

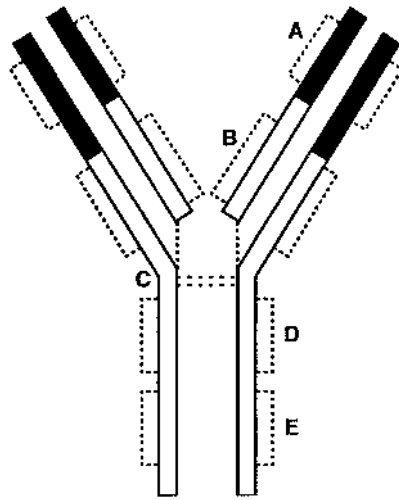

- 5.8 The region involved in binding to antigen epitopes
 5.9 The region containing the binding sites for complement
 5.10 The region that determines the light-chain isotype

Answers

- 5.1 (E) The only specific characteristic of secretory IgA is the secretory component, which is not found in circulating dimeric IgA. Secretory IgA is predominantly of the IgA2 subclass and structurally polymeric, but IgA2 and dimerized IgA (with associated J chains) can also be found in circulation.
- 5.2 (A) The F(ab')₂ fragments obtained with pepsin are divalent and, therefore, can cross-link a multivalent antigen and lead to the formation of a precipitate.
- 5.3 (E) The variable regions of both light and heavy chains are believed to contribute to the formation of the “pouch” where the epitope of an immunogen will fit.
- 5.4 (E) The FcγRI binds IgG1 with high affinity but is not expressed on basophils. Basophils express the FcεRI, which binds IgE with very high affinity.
- 5.5 (C) J chain is only found in polymeric immunoglobulins (IgM and IgA); thus, immunization with polyclonal IgG is not likely to result in the formation of antibodies directed against this polypeptide chain.
- 5.6 (A) Proteolytic enzymes attack the hinge regions. IgG3 has an extended hinge region, which in addition is rigid (due to a large number of disulfide bonds) and exposed to the enzymes.
- 5.7 (B) The β-pleated-sheet regions or “domains” are the structural hallmark common to all members of the Ig superfamily, which otherwise differ significantly among themselves.
- 5.8 (A) The variable regions of L and H chains form the antigen-binding site.
- 5.9 (D) The Cγ2 domain
- 5.10 (B) The CL domain

BIBLIOGRAPHY

- Atassi, M. A., Van Oss, J. and Absolom, D. R. (eds.). *Molecular Immunology*. Marcel Dekker, Inc., New York, 1984. (A comprehensive textbook with excellent chapters on immunoglobulin isolation and characterization and on immunoglobulin structure and function.)
- Ban, N., Escobar, C., Garcia, R., Hasel, K., Day, J., Greenwood, A., and McPherson, A. Crystal structure of an idiotype-anti-idiotype Fab complex. *Proc. Natl. Acad. Sci. USA* 91:1604, 1994.
- Clark, W. R. *The Experimental Foundations of Modern Immunology*. John Wiley & Sons, New York, 1980. (A good discussion on how knowledge about immunoglobulin structure evolved.)
- Day, E. D. *Advanced Immunochemistry*, 2nd ed. Wiley-Liss, New York, 1990. (The first five chapters are entirely devoted to the structure of antibodies.)
- Edmundson, A. B., Guddat, L. W., Rosauer, R. A., Anderson, K. N., Shan, L., and Rosauer, R. A. Three-dimensional aspects of IgG structure and function. In: *The Antibodies*, Vol. 1 (Zanetti, M., and Capra, D. J., eds.). Harwood Acad. Pub., Luxembourg, p. 41, 1995.
- Nezlin, R. Internal movements in immunoglobulin molecules. *Adv. Immunol.*, 48:1, 1990.
- Nisonoff, A. *Introduction of Molecular Immunology*. Sinauer Ad. Inc., Sunderland, MA., 1982. (Includes excellent discussions of immunoglobulin structure and antibody diversity.)
- Underdown, B. J., and Schiff, J. M. Immunoglobulin A: Strategic defense initiative at the mucosal surface. *Ann. Rev. Immunol.*, 4:389, 1986.
- Van Oss, C. J., and van Regenmortel, M. H. V. *Immunochemistry*. Marcel Dekker, New York, 1994.
- Williams, A. F., and Barclay, A. N. The immunoglobulin superfamily—domains for cell surface recognition. *Ann. Rev. Immunol.*, 6:381, 1988.

6

Biosynthesis, Metabolism, and Biological Properties of Immunoglobulins

Gabriel Virella

I. IMMUNOGLOBULIN BIOSYNTHESIS

Immunoglobulin synthesis is the defining property of B lymphocytes and plasma cells. Resting B lymphocytes synthesize only small amounts of immunoglobulins, which are mainly inserted into the cell membrane. Plasma cells, considered as end-stage cells arrested at the late G1 phase with very limited mitotic activity, are specialized to produce and secrete large amounts of immunoglobulins. The synthetic capacity of the plasma cell is reflected by its abundant cytoplasm, which is extremely rich in endoplasmic reticulum (Fig. 6.1).

Normally, heavy (H) and light (L) chains are synthesized in separate polyribosomes of the plasma cell. The amounts of H and L chains synthesized on the polyribosomes are usually balanced so that both types of chain will be combined into complete IgG molecules, without surpluses of any given chain. The assembly of a complete IgG molecule can be achieved by 1) associating one H and one L chain to form an HL hemi-molecule, joining in the next step two HL hemi-molecules to form the complete molecule (H_2L_2), or 2) forming H_2 and L_2 dimers that later associate to form the complete molecule.

The synthesis of heavy and light chains is slightly unbalanced in favor of light chains. Free light chains can be effectively secreted from plasma cells and are eliminated in the urine in very small concentrations. When plasma cells undergo malignant transformation, this unbalanced synthesis of light chains may be grossly aberrant, which is reflected by the elimination of the excessively produced light chains of a single isotype in the urine (Bence Jones proteinuria). In contrast, free heavy chains are generally not secreted. The heavy

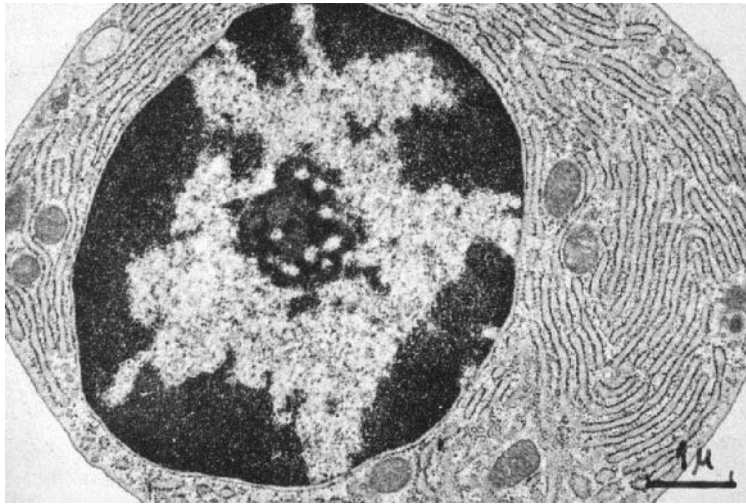

Fig. 6.1 Ultrastructure of a mature plasma cell. Note the eccentric nucleus with clumped chromatin, the large cytoplasm containing abundant, distended, endoplasmic reticulum. (Electron microphotograph courtesy of Professor P. Groscurth, M. D., Institute of Anatomy, University of Zurich, Switzerland.)

chains are synthesized, transported to the endoplasmic reticulum, where they are glycosylated, but secretion requires association to light chains to form a complete immunoglobulin molecule. If light chains are not synthesized or heavy chains are synthesized in excess, the free heavy chains associate via their C_{H1} domain with a heavy-chain binding protein, which is believed to be responsible for their intracytoplasmic retention. In rare cases, the free heavy chains are structurally abnormal and are secreted. Free heavy chains are usually retained in circulation because of their molecular weight—about twice that of light chains.

Polymeric immunoglobulins (IgM, IgA) have one additional polypeptide chain, the J chain. This chain is synthesized by all plasma cells, including those that produce IgG. However, it is only incorporated to polymeric forms of IgM and IgA. It is thought that the J chain has some role in initiating polymerization, as shown in Figure 6.2. IgM proteins are assembled in two steps. First, the monomeric units are assembled. Then, five monomers and one J chain will be combined via covalent bonds to result in the final pentameric molecule. This assembly seems to coincide with secretion in some cells in which only monomeric subunits are found intracellularly. However, in other cells the pentameric forms can be found intracellularly and secretion seems linked to glycosylation.

Secretory IgA is also assembled in two stages, but each one takes place in a different cell. Dimeric IgA, containing two monomeric subunits and a J chain joined together by disulfide bridges, is predominantly synthesized by submucosal plasma cells, although a minor portion may also be synthesized in the bone marrow. Secretory component (SC), on the other hand, is synthesized in the epithelial cells, where the final assembly of secretory IgA takes place. Two different biological functions have been postulated for the secretory component.

First, SC is responsible for secretion of IgA by mucosal membranes. The process involves uptake of dimeric IgA, assembly of IgA-SC complexes, and secretion by the mucosal cells.

The uptake of dimeric IgA by mucosal cells is mediated by a glycoprotein related to SC, the polyimmunoglobulin receptor (Poly-IgR). Poly-IgR is constituted by a single

polypeptide chain of approximately 95,000 daltons, composed of an extracellular portion with five immunoglobulin-like domains, a transmembrane domain, and an intracytoplasmic domain. It is expressed on the internal surface of mucosal cells and binds J-chain-containing polymeric immunoglobulins.

The binding of dimeric IgA to poly-IgR seems to be the first step in the final assembly and transport process of secretory IgA. Surface-bound IgA is internalized and poly-IgR is covalently bound to the molecule, probably by means of a disulfide-interchanging enzyme that will break intrachain disulfide bonds in both IgA and poly-IgR and promote their rearrangement to form interchain disulfide bonds joining poly-IgR to an α chain.

After this takes place, the transmembrane and intracytoplasmic domains of the receptor are removed by proteolytic cleavage, and the remaining five domains remain bound to IgA, as SC, and the complete secretory IgA molecule is secreted (Fig. 6.3).

Basically the same transport mechanisms are believed to operate at the hepatocyte level. The hepatocytes produce poly-IgR, bind and internalize dimeric IgA reaching the liver through the portal circulation, assemble complete secretory IgA, and secrete it to the bile. Secretory IgA must also flow back to the bloodstream, because small amounts are found in the blood of normal individuals. Higher levels of secretory IgA in blood are found in some forms of liver disease, when the uptake of dimeric IgA backflowing from the gut through the mesenteric lymph vessels takes place, but its secretion into the biliary system is compromised. Under those circumstances, secretory IgA assembled in the hepatocyte backflows into the systemic circulation.

Among all J-chain-containing immunoglobulins, the poly-IgR has higher binding affinity for dimeric IgA. In IgA-deficient individuals IgM coupled with SC can be present in external secretions. It is believed that the same basic transport mechanisms are involved, starting by the binding of pentameric IgM to the poly-IgR on a mucosal cell and proceeding along the same lines outlined for the assembly and secretion of dimeric IgA. The fact that secretory IgM, with covalently bound SC, is detected exclusively in secretions of IgA-deficient individuals is believed to reflect the lower affinity of the interaction between poly-IgR and IgM-associated J chains (perhaps this as a consequence of steric hindrance of the binding sites of the J chain). Therefore, the interaction between IgM and poly-IgR would only take place in the absence of competition from dimeric IgA molecules.

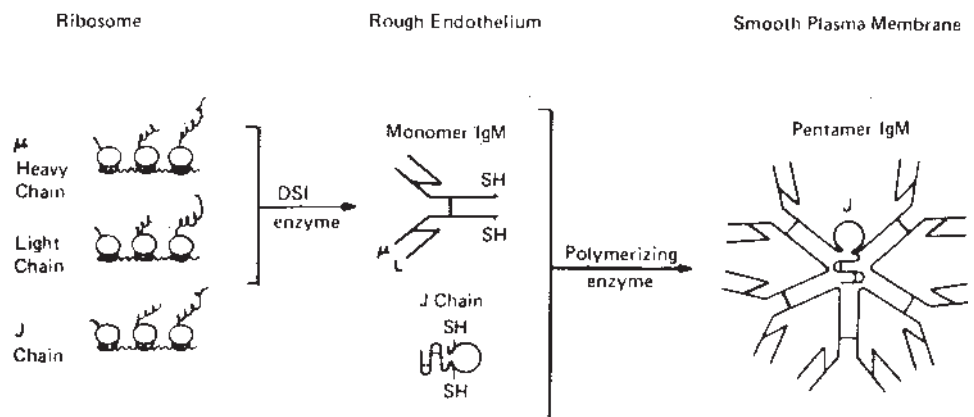

Fig. 6.2 Schematic representation of IgM synthesis in a pentamer IgM-secreting cell. DSI, disulfide interchanging enzyme. (Reproduced with permission from Koshland, M. E. Molecular aspects of B cell differentiation. *J. Immunol*, 131:(6)j, 1983.)

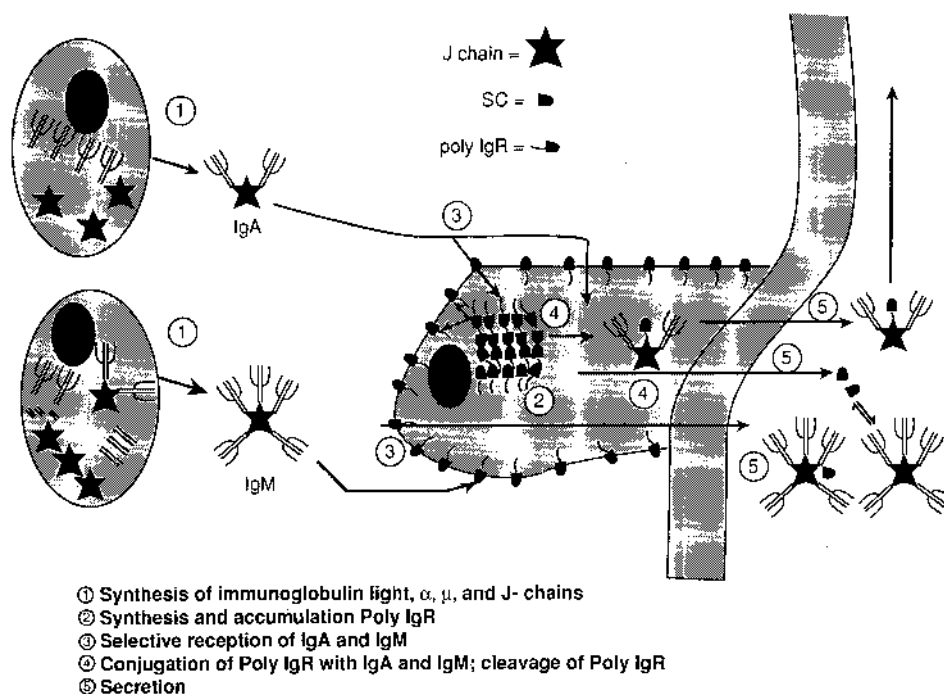

Fig. 6.3 Schematic representation of the mechanisms involved in the synthesis and external transfer of dimeric IgA. According to this model, a polyimmunoglobulin receptor is located at the membrane of mucosal cells and binds polymeric immunoglobulins in general and dimeric IgA with the greatest specificity. The Poly-IgR-IgA complexes are internalized, and in the presence of a disulfide interchanging enzyme, covalent bonds are established between the receptor protein and the immunoglobulin. The transmembrane and intracytoplasmic bonds of the Poly IgR are cleaved by proteolytic enzymes, and the extracellular portion remains bound to IgA, constituting the secretory component. The IgA-SC complex is then secreted to the gland lumen. If the individual is IgA deficient, IgM may become involved in a similar process. (Modified from Brandzaeg, P., and Baklien, K. *Intestinal secretion of IgA and IgM: A hypothetical model*. In: *Immunology of the Gut*. Elsevier/Excerpta Medica/North-Holland, New York, 1977, p. 77.)

The second function proposed for SC is as a stabilizer of the IgA molecule. This concept is based on experimental observations showing that secretory IgA or dimeric IgA to which SC has been noncovalently associated *in vitro* are more resistant to the effects of proteolytic enzymes than monomeric or dimeric IgA molecules devoid of SC. One way to explain these observations would be to suggest that the association of SC with dimeric IgA molecules renders the hinge region of the IgA monomeric subunits less accessible to proteolytic enzymes. From a biological point of view, it would be advantageous for antibodies secreted into fluids rich in proteolytic enzymes (both of bacterial and host origin) to be resistant to proteolysis.

II. IMMUNOGLOBULIN METABOLISM

All proteins produced by an organism will eventually be degraded or lost through the excreta. However, the speed of the metabolic elimination and the fractional turnover rate (the fraction of the plasma pool catabolized and cleared into urine in a day) and the synthetic

rate vary considerably from protein to protein. Within the immunoglobulin group, different immunoglobulin isotypes have different synthetic rates and different catabolic rates.

One of the most commonly used parameters to assess the catabolic rate of immunoglobulins is the half-life ($t_{1/2}$), which corresponds to the time elapsed for a reduction to half of the IgG concentration after equilibrium has been reached. This is usually determined by injecting an immunoglobulin labeled with a radio-isotope (^{131}I is preferred for the labeling of proteins to be used for metabolic studies due to its fast decay rate) and following the plasma activity curve. Figure 6.4 shows an example of a metabolic turnover study. After an initial phase of equilibration, the decay of circulating radioactivity follows a straight line in a semi-logarithmic scale. From this graph it is easy to derive the time elapsed between concentration n and $n/2$, i.e., the half-life.

The metabolic properties of immunoglobulins are as follows:

1. IgG is the immunoglobulin class with the longest half-life (21 days) and lowest fractional turnover rate (4–10%/12 hr) with the exception of IgG3, which has a considerably shorter half-life (7 days), close to that of IgA (5–6 days) and IgM (5 days).
2. IgG catabolism is uniquely influenced by its circulating concentration of this immunoglobulin. At high protein concentrations the catabolism will be faster, and at low IgG concentrations catabolism will be slowed down. These differences are explained, according to Brambell's theory, by the protection of IgG bound to IgG-specific Fc receptors (Fc γ R) in the internal aspect of endopinocytotic vesicles from proteolytic enzymes. IgG is constantly pinocytosed by cells able to degrade it, but at low IgG concentrations most molecules are bound to the Fc receptors on the endopinocytotic vesicles and the fraction of total IgG degraded will be small. The undegraded molecules are eventually released back into the extracellular fluids. At high IgG concentrations, the majority of IgG molecules remain unbound in the endopinocytotic vesicle and are degraded, resulting in a high catabolic rate (Fig. 6.5).
3. While most immunoglobulin classes and subclasses are evenly distributed among the intra- and extravascular compartments, IgM, IgD, and, to a lesser ex-

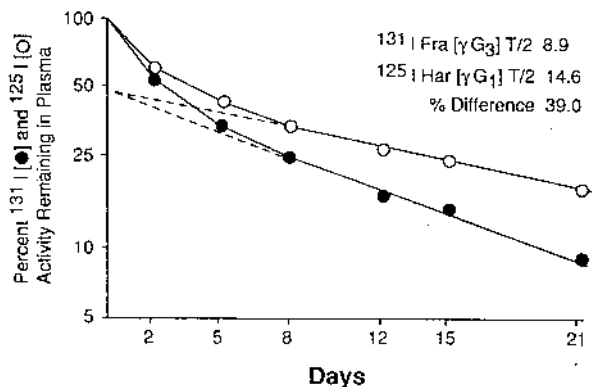

Fig. 6.4 Plasma elimination curves of two IgG proteins, one typed as IgG1 (Har) and the other as IgG3 (Fra). The $t_{1/2}$ can be determined from the stable part of the curve and its extrapolation (dotted line) as the time necessary for a 50% reduction of the circulating concentration of labeled protein. (Reproduced with permission from Spiegelberg, H. L., Fishkin, B. G., and Grey, H. M. Catabolism of human G immunoglobulins of different heavy chain subclass. *J. Clin. Invest.*, 47:2323, 1968.)

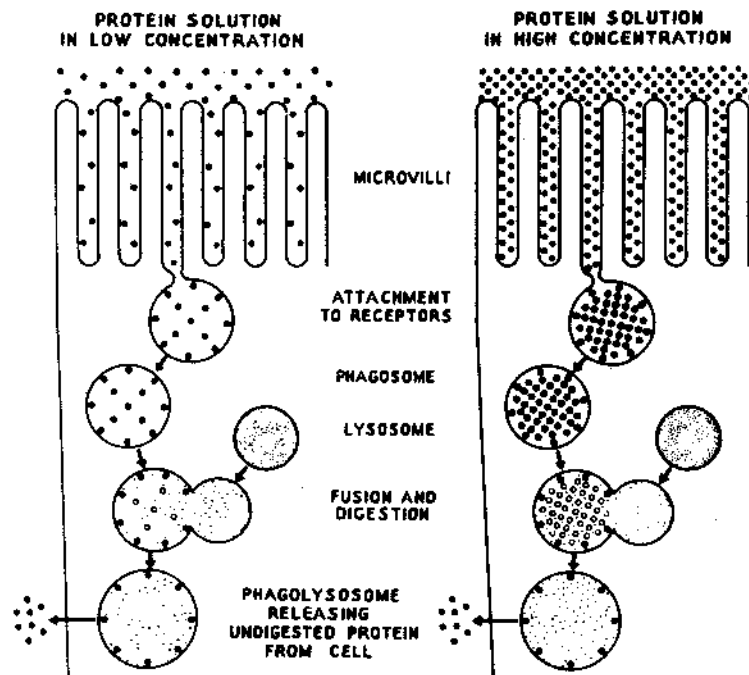

Fig. 6.5 Schematic representation of Brambell's theory concerning the placental transfer of IgG and the relationship between concentration and catabolism of IgG. The diagram at the left shows that pinocytotic IgG will be partially bound to phagosome wall receptors and protected from proteolysis, being later released undigested. This mechanism would account for transplacental transfer. The diagram on the right side of the figure shows that if the concentration of IgG is very high, the number of IgG molecules bound to phagosome receptors will remain the same as when the concentration is low, while the number of unbound molecules will be much greater, and those will be eventually digested, resulting in a higher catabolic rate. (Reproduced with permission from Brambell, F. W. R. The transmission of immunity from mother to young and the catabolism of immunoglobulins. *Lancet*, ii:1089, 1966.)

tent, IgG3 are predominantly concentrated in the intravascular space, and IgA2 is predominantly concentrated in secretions.

4. The synthetic rate of IgA1 (24 mg/kg/day) is not very different from that of IgG1 (25 mg/kg/day), but the serum concentration of IgA1 is about 1/3 of the IgG1 concentration. This is explained by a fractional turnover rate three times greater for IgA1 (24%/day).
5. The highest fractional turnover rate and shorter half-life are those of IgE (74%/day and 2.4 days, respectively).
6. The lowest synthetic rate is that of IgE (0.002 mg/kg/day vs. 20–60 mg/kg/day for IgG).

III. BIOLOGICAL PROPERTIES OF IMMUNOGLOBULINS

The antibody molecules have two major functions: binding to the antigen, a function that basically depends on the variable regions located on the Fab region of the molecule, and

several other extremely important functions, listed in Table 6.1, which depend on the Fc region. Of particular physiological interest are placental transfer, complement fixation, and binding to Fc receptors.

A. Placental Transfer

In humans, the only major immunoglobulin transferred from mother to fetus across the placenta is IgG. The placental transfer of IgG is an active process; the concentration of IgG in the fetal circulation is often higher than the concentration in matched maternal blood. It is also known that a normal fetus synthesizes only trace amounts of IgG, depending on placental transfer for acquisition of passive immunity against common pathogens.

The selectivity of IgG transport has been explained by Brambell's receptor theory for IgG catabolism. The trophoblastic cells on the maternal side of the placenta would endocytose plasma containing all types of proteins but would have receptors in the endocytotic vesicles for the Fc region of IgG, and not for any other immunoglobulin. IgG bound to Fc γ receptors would be protected from catabolism and through active reverse pinocytosis would be released into the fetal circulation.

B. Complement Activation

Three pathways (see Chapter 9) can activate the complement system, and different structural areas of the immunoglobulin molecule are involved in complement fixation by two of them. At the present time, all immunoglobulins have been found able to fix complement by one or the other pathway. IgG1, IgG3, and IgM molecules are the most efficient in fixing complement, all of them through the classical pathway.

Complement activation is an extremely important amplification mechanism, which mediates antibody-dependent neutralization and elimination of infectious agents. These ef-

Table 6.1 Biological Properties of Immunoglobulins

	IgG1	IgG2	IgG3	IgG4	IgA1	IgA2	IgM	IgD	IgE
Serum concentration (mg/dL) ^a	460–1140	80–390	28–194	2.5–16	50–200	0–20	50–200	0–40	0–0.2
Presence in normal secretions	–	–	–	–	+	+++	+	–	+
Placental transfer	+	+	+	+	–	–	–	–	–
Complement fixation									
Classic pathway	+++	+	+++	–	–	–	+++	–	–
Alternative pathway ^b	+	+	+	+	+	+	?	+	+
Reaction with Fc receptors on									
Macrophages	+	–	++	–	+	+	–	–	–
Neutrophils	+	–	++	–	–	–	–	–	–
Basophils/Mast cells	–	–	–	–	–	–	–	–	+++ ^c
Platelets	+	+	+	+	–	–	–	–	–
Lymphocytes	++	?	++	?	–	–	+	–	–

^a IgG subclass values after Shakib et al., *J. Immunol. Methods*, 8: 17, 1975.

^b After aggregation.

^c High-affinity receptors.

fects depend on two basic mechanisms discussed in greater detail in Chapter 9:

Generation of C3b, which, when deposited on the membrane of a microorganism, facilitates phagocytosis by cells with C3b receptors. For this reason, C3b is known as an opsonin.

Disruption of lipid bilayers that depends on the generation of the late complement components (C6–C9). When those components are properly assembled on a cell membrane, they induce the formation of transmembrane channels, which results in cell lysis.

C. Binding to Fc Receptors

Virtually every type of cell involved in the immune response has been found to be able to bind one or more immunoglobulin isotypes through Fc receptors (Table 6.2). These receptors have been classified according to the isotype of immunoglobulin they preferentially bind as Fc γ R (receptors for IgG), Fc α R (receptors for IgA), Fc ϵ R (receptors for IgE), and

Table 6.2 Different Types of Fc Receptors Described in Immune System Cells

Fc receptor	Characteristics	Cellular distribution	Function
Fc γ RI (CD64) ^a	Transmembrane and intracytoplasmic domains; high affinity; binds both monomeric and aggregated IgG	Monocytes, macrophages	ADCC (monocytes)
Fc γ RII (CD32)	Transmembrane and intracytoplasmic domains; low affinity	Monocytes/macrophages; Langerhans cells; granulocytes; platelets; B cells	IC binding; phagocytosis; degranulation; ADCC (monocytes)
Fc γ RIII (CD16)	Glycosyl-phosphatidyl inositol anchor in neutrophils; transmembrane segment in NK cells; low affinity	Macrophages; granulocytes; NK cells	IC binding and clearance; “priming signal” for phagocytosis and degranulation; ADCC (NK cells)
Fc α R	Transmembrane and intracytoplasmic segments; low affinity	Granulocytes, monocytes/macrophages, platelets, T and B lymphocytes	Phagocytosis, degranulation
Fc ϵ RI	High affinity	Basophils, mast cells	Basophil/mast cell degranulation
Fc ϵ RII (CD23)	Low affinity	T and B lymphocytes; monocytes/macrophages; eosinophils; platelets	Mediate parasite killing by eosinophils
Fc μ R		T lymphocytes	

^a CD designates the monoclonal antibodies raised against the different receptors (see Chapter 10).

Fc μ R (receptors for IgM):

Fc γ RI (CD64), a high-affinity receptor, able to bind monomeric IgG, expressed exclusively by monocytes and macrophages

Fc γ RII (CD32), a low-affinity receptor for IgG expressed by phagocytic cells, platelets, and B lymphocytes

Fc γ RIII (CD16), a second low-affinity IgG receptor expressed by phagocytic and NK cells

Fc receptors are constituted by one or several polypeptide chains. The extracellular domains responsible for interaction with the Fc region are located on the α chain, represented in all Fc receptors. While Fc γ RII is constituted exclusively by an α chain, Fc α and Fc γ RI and Fc γ RIII receptors have an additional polypeptide chain (γ), and Fc ϵ RI has a third chain, β .

The binding of free or complexed immunoglobulins to their corresponding Fc receptors has significant biological implications:

1. As discussed above, the catabolic rate of IgG and the selective placental transfer of IgG depend on the interaction with Fc γ R on pinocytotic vesicles.
2. IgG mediates phagocytosis by all cells expressing Fc γ R on their membranes (granulocytes, monocytes, macrophages, and other cells of the same lineage). Thus, IgG is also considered an opsonin. IgA (particularly its dimeric form) has also been shown to mediate phagocytosis. However, IgA by itself seems to be a weak opsonin, and complement activation by the alternative pathway seems to significantly enhance this activity. In reality, IgG and C3b have synergistic opsonizing effects, and their joint binding and deposition on the membrane of an infectious agent is a most effective way to promote its elimination.
3. A common characteristic of Fc receptors (with the exception of Fc μ and Fc δ receptors) is their ability to transduce activating signals to the cells where they are inserted. Activation is mediated by immunoreceptor tyrosine-based activation motifs (ITAMs) located either in the α polypeptide chain (Fc γ RII) in one or both of the associated chains (γ and β). The activation of ITAMs requires cross-linking of Fc receptors by Ag-Ab complexes containing at least two antibody molecules.
4. Granulocytes, monocytes/macrophages, and NK cells can destroy target cells coated with IgG antibody (antibody-dependent cellular cytotoxicity, ADCC). In this case the destruction of the target cell does not depend on opsonization, but rather on the release of toxic mediators.

The specific elimination of target cells by opsonization and ADCC depends on the binding of IgG antibodies to those targets. The antibody molecule tags the target for destruction; phagocytic or NK cells mediate the destruction. Not all antibody molecules are able to react equally with the Fc γ receptors of these cells.

The highest binding affinities for any of the three types of Fc γ receptor known to date are observed with IgG1 and IgG3 molecules.

Two types of Fc ϵ receptors specific for IgE have been defined. One is a low-affinity receptor (Fc ϵ RII) present in most types of granulocytes. It mediates ADCC reactions directed against helminths, which typically elicit IgE antibody synthesis (see Chapter 14). The other is a high-affinity Fc ϵ receptor (Fc ϵ RI) expressed by basophils and mast cells. The basophil/mast cell-bound IgE functions as a true cell receptor. When an IgE molecule

bound to a high-affinity FcεRI membrane receptor interacts with the specific antigen against which it is directed, the cell is activated and, as a consequence, histamine and other mediators are released from the cell. The release of histamine and a variety of other biologically active compounds is the basis of the immediate hypersensitivity reaction, which is discussed in detail in Chapter 21.

SELF-EVALUATION

Questions

Choose the one *best* answer.

- 6.1 A newborn's repertoire of antibodies is shown to include all those listed below. Which one is most likely to have been synthesized by the newborn?
 - A. IgG1 anti-Rh
 - B. IgG2 anti-human immunodeficiency virus (HIV)
 - C. IgG3 anti-tetanus toxoid
 - D. IgG4 anti-*Haemophilus influenzae* type b
 - E. IgM anti-toxoplasma
- 6.2 The Fab fragment of an IgG immunoglobulin includes the domain(s) responsible for:
 - A. Antigen binding
 - B. Binding to macrophage receptors
 - C. Complement fixation
 - D. Fixation to heterologous skin
 - E. Placental transfer
- 6.3 Which of the following would be a major problem for the therapeutic administration of IgA antibodies to individuals congenitally unable to synthesize them?
 - A. Affinity to mucosal cells
 - B. Lack of complement-fixing capacity
 - C. Low concentration in serum
 - D. Molecular heterogeneity
 - E. Short half-life
- 6.4 According to Brambell's theory, the key to the placental transfer of IgG is the:
 - A. High diffusibility of monomeric antibodies
 - B. Protection against proteolysis of IgG bound to receptors in the walls of pinocytic vesicles that transport proteins across the trophoblast
 - C. Local synthesis by subendothelial plasma cells on the maternal side of the placenta
 - D. Existence of an uptake mechanism in trophoblast similar to that responsible for the transfer of IgA across mucosae
 - E. Long half-life of maternal IgG
- 6.5 The relatively greater resistance of secretory IgA to proteolytic enzymes is assumed to be a consequence of the:
 - A. Antiprotease activity of secretory component
 - B. High-affinity binding to IgA2 molecules
 - C. Predominantly dimeric nature of secretory IgA
 - D. Presence of J chain
 - E. "Wrapping" of secretory component around hinge region

- 6.6 Which immunoglobulin has a catabolic rate dependent on its circulating concentration?
- A. IgG
 - B. IgA
 - C. IgM
 - D. IgD
 - E. IgE

Match the characteristic indicated below with the immunoglobulin to which it is most specifically associated in Questions 6.7–6.10.

- A. Half-life of 7 days
 - B. Greatest fractional catabolic rate
 - C. Binding to Fc γ RI in its monomeric form
 - D. Predominantly B-cell bound
 - E. Two-step synthesis
- 6.7 IgG1
6.8 IgG3
6.9 Secretory IgA
6.10 IgE

Answers

- 6.1 (E) IgM antibodies are not transmitted across the placenta, while all IgG subclasses are. Thus, the finding of specific IgM antibodies to any infectious agent in cord blood is considered as evidence of intrauterine infection.
- 6.2 (A) All biological properties of antibodies other than antigen binding are Fc mediated.
- 6.3 (E) Although IgA is relatively low in the serum, it could be obtained in larger amounts from milk or colostrum. The main problem with replacing IgA in a deficient individual would be the short half-life (5–6 days), probably requiring weekly administrations of a product made expensive by the need of special isolation protocols.
- 6.4 (B) Endocytosed and receptor-bound IgG will be protected from proteolysis.
- 6.5 (E) It is believed that SC sterically protects the hinge region by blocking access to proteolytic enzymes.
- 6.6 (A) Brambell's theory postulates that there is an inverse correlation between the circulating concentration of IgG and the fraction of IgG bound on the phagolysosome membranes and spared from degradation; hence, the fractional turnover rate will be directly proportional to circulating IgG concentrations.
- 6.7 (C) IgG1 binds with high affinity to the Fc γ RI in its native state.
- 6.8 (A) IgG3 is more susceptible to proteolytic enzymes than other IgG protein of subclasses 1, 2, and 4. This could explain its faster catabolic rate and shorter half-life.
- 6.9 (E) Secretory IgA is synthesized in two steps: dimeric IgA with J chain is produced by submucosal plasma cells. Once dimeric IgA is internalized into mucosal epithelial cells, the secretory component is added to the molecule, which is then secreted.

- 6.10 (B) Both IgE and IgD exist predominantly as cell-bound immunoglobulins; IgD is found on the membrane of B lymphocytes, while IgE binds to FcεRI in mast cells and eosinophils. Of the listed isotypes, IgE has the greatest fractional catabolic rate.

BIBLIOGRAPHY

- Brandtzaeg, P. Molecular and cellular aspects of the secretory immunoglobulin system. *APMIS*, 103:1, 1995.
- Daëron, M. Fc Receptor Biology. *Annu. Rev. Immunol.*, 15:203, 1997.
- Gergely, J., and Sarmay, G. The two binding-site models of human IgG binding Fcγ receptor. *FASEB J.*, 4:3275, 1990.
- Hendershot, L., and Kearney, J. F. A role for human heavy chain binding protein in the developmental regulation of protein transport. *Mol. Immunol.*, 25:585, 1988.
- Janoff, E. N., Fasching, C., Orenstein, J. M., Rubins, J. B., Opstad, N. L., and Dalmasso, A. P. Killing of *Streptococcus pneumoniae* by capsular polysaccharide-specific polymeric IgA, complement, and phagocytes. *J. Clin. Invest.*, 104:1139, 1999.
- Metzer, H. Fc receptors and membrane immunoglobulins. *Curr. Opin. Immunol.*, 3:40, 1991.
- Nezlin, R. Immunoglobulin structure and function. In *Immunochemistry* (van Oss, C. J., and van Regenmortel, M. H. V., eds.). Marcel Dekker, New York, 1994, p. 3.
- Parkhouse, R. M. E. Biosynthesis of immunoglobulins. In *Immunochemistry: An Advanced Textbook* (L. E. Glynn and M. W. Steward, eds.). J. Wiley & Sons, New York, 1977.
- Sitia, R., and Cattaneo, A. Synthesis and assembly of antibodies in nature and artificial environments. In *The Antibodies*, Vol. 1 (M. Zanetti and J. D. Capra, eds.). Harwood Acad. Pub., Luxembourg, 1995, p. 127.
- Underdown, B. J., and Schiff, J. M. Immunoglobulin A: Strategic defense initiative at the mucosal surface. *Ann. Rev. Immunol.*, 4:389, 1986.
- Waldmann, T. A., and Strober, W. Metabolism of immunoglobulins. *Prog. Allergy*, 13:1, 1969.

7

Genetics of Immunoglobulins

Janardan P. Pandey

Human immunoglobulin (Ig) molecules are coded by three unlinked gene families: two for light (L) chains located on chromosomes 2 (κ chains) and 22 (λ chains), and one for heavy (H) chains located on chromosome 14. As mentioned in the preceding chapters, each individual is able to produce several million antibody molecules with different antigenic specificities, and this diversity corresponds to the extreme heterogeneity of the variable (V) regions in those antibody molecules, implying that each individual must possess a large number of structural genes for Ig chains. The allotypic determinants on the constant (C) region (see following discussion), on the other hand, segregate as a single Mendelian trait, suggesting that there may be only one gene for each of the several Ig chain C regions. To reconcile these seemingly contradictory observations, Dreyer and Bennet in 1965 proposed that two separate genes that are brought together by a translocation event during lymphocyte development encode the V and C regions. Employing recombinant DNA technology, Hozumi and Tonegawa in 1976 obtained conclusive proof of this hypothesis (for his seminal studies, Tonegawa was awarded the 1987 Nobel Prize in Medicine and Physiology).

I. IMMUNOGLOBULIN GENE REARRANGEMENT

It is well established that an immunoglobulin polypeptide chain is coded by multiple genes scattered along a chromosome of the germline genome. These widely separated gene segments are brought together (recombined) during B-lymphocyte differentiation to form a complete immunoglobulin gene.

The V regions of the immunoglobulin light chains are coded by two gene segments, designated as V and J (J for joining, because it joins V and C region genes). Three gene segments are required for the synthesis of the V region of the heavy chains: V, J, and D (D for diversity, corresponds to the most diverse region of the H chain). To form a functional light- or heavy-chain gene, one or two gene rearrangements are needed. On chromosome 2 (where the κ chain genes are located) or 22 (where the λ chain genes are located), a V gene moves next to a J gene. On chromosome 14 (where the heavy-chain genes are located), first the D and J regions are joined, and next one of the V genes is joined to the DJ complex. The VJ or VDJ segments, one of the C-gene complexes (C_κ or C_λ on chromosomes 2 or 22), and C_{μ} , C_δ , $C_{\gamma 3}$, $C_{\gamma 1}$, $C_{\gamma 2}$, $C_{\gamma 4}$, C_ϵ , or $C_{\alpha 2}$ on chromosome 14 are then transcribed into nuclear RNA containing VJ- or VDJ-coding sequences, the interconnecting noncoding sequences, and the coding sequence of one of the C genes. The intervening noncoding sequences are then excised making a contiguous VJC mRNA for an L chain and a contiguous VDJC mRNA for an H chain (Figs. 7.1 and 7.2). Gene rearrangements occur in a sequential order: usually heavy chain genes rearrange first, followed by κ chain genes and lastly by λ genes.

It has been shown that the VDJ joining is regulated by two proteins encoded by two closely linked recombination-activating genes, RAG-1 and RAG-2, localized on the short

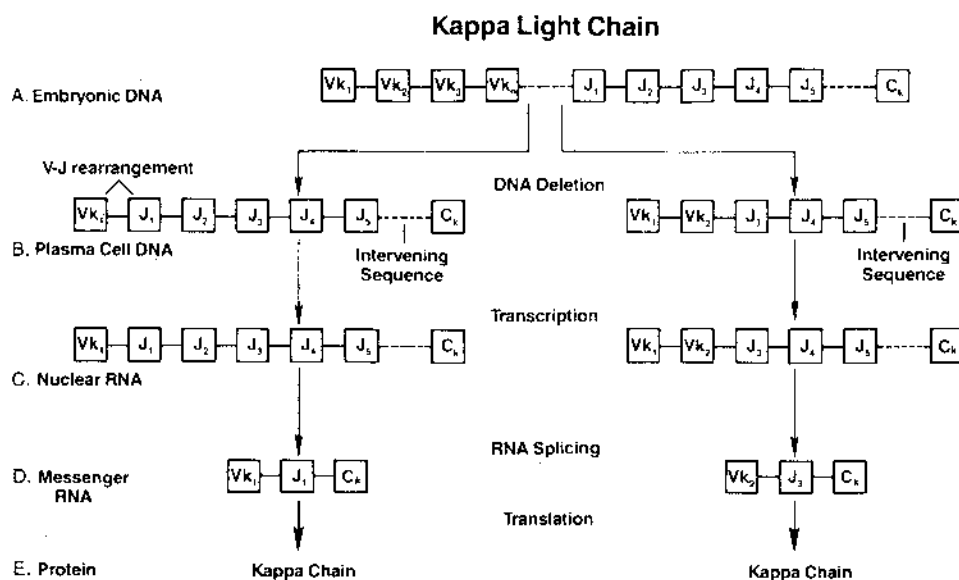

Fig. 7.1 The embryonic DNA of chromosome 2 contains over 300 V genes, five J (joining) genes, and a C (constant) gene (A). The V and J genes code for the kappa chain's variable region, C for its constant region. In the left pathway, differentiation of the embryonic cell to a plasma cell results in deletion of the intervening V genes so that V_{k_1} is joined with the J_1 gene (B). The linked $V_{k_1}J_1$ segment codes for one of over 1500 possible kappa light-chain variable regions. The plasma cell DNA is transcribed into nuclear RNA (C). Splicing of the nuclear RNA produces messenger RNAs with the V_{k_1} , J_1 , and C genes linked together (D), ready for translation of a kappa light-chain protein (E). The alternate pathway at right (B–D) shows another of the many possible pathways leading to a different kappa light chain with a different variable region specificity. (Modified from David, J. R. *Antibodies: Structure and function*. In: *Scientific American Medicine*. Scientific American Inc., New York, 1980.)

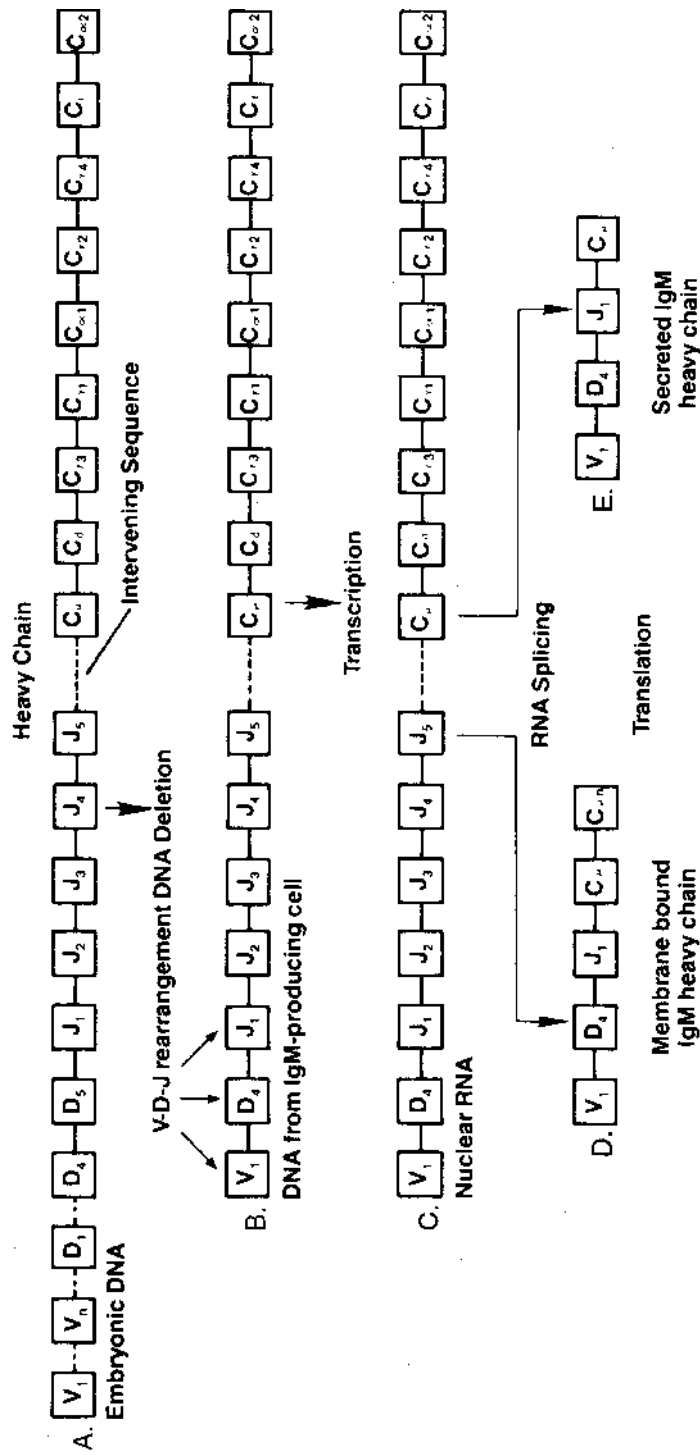

Fig. 7.2 A stretch of embryonic DNA in chromosome 14 contains a section coding for the heavy-chain variable region; this DNA is made up of at least 100 V genes, 50 D genes, and 4–6 J genes. The section coding for the constant region is formed by 9 C genes (A). In the pathway shown, when the embryonic cell differentiates into a plasma cell, some V and D genes are deleted so that V₁, D₄, and J₁ are joined to form one of many possible heavy-chain genes (B). The plasma cell DNA is then transcribed into nuclear RNA (C). RNA splicing selects the C gene and joins it to the V₁, D₄, and J₁ genes (D). The resulting messenger RNAs will code for IgM heavy chains (E). If RNA splicing removes the C_μ piece from the C_μ gene, the IgM will be secreted. If the piece remains, the IgM will be membrane-bound. (Modified from David, J. R. Antibodies: Structure and function. In: *Scientific American Medicine*. Scientific American Inc., New York, 1980.)

arm of human chromosome 11. These genes have at least two unusual characteristics not shared by most eukaryotic genes: they are devoid of introns and, although adjacent in location and synergistic in function, they have no sequence homology. The latter implies that, unlike the immunoglobulin and MHC genes, RAG-1 and RAG-2 did not arise by gene duplication. Recent studies suggest that these genes may be evolutionarily related to transposons, genetic elements that can be transposed in the genome from one location to the other. Conserved recombination signal sequences (RSS) serve as substrate for the enzymes coded by the RAG genes. These enzymes introduce a break between the RSS and the coding sequence. Mechanisms involved in subsequent rejoining to form a mature coding segment are not completely understood.

The transcription of Ig genes, like other eukaryotic genes, is regulated by promoters and enhancers. Promoters, located 5' of the V segment, are necessary for transcription initiation. Enhancers, located in the introns between J and C segments, increase the rate of transcription. For this reason, immunoglobulin synthesis (H or L chains) is only detected after the VDJ or VJ rearrangements, which bring the promoter in close proximity to the enhancer.

During ontogeny and functional differentiation, the H chain genes may undergo further gene rearrangements that result in immunoglobulin class switching. As the B lymphocytes differentiate into plasma cells, one heavy-chain C-gene segment can be substituted for another without alteration of the VDJ combination (Fig. 7.3). In other words, a given variable region gene can be expressed in association with more than one heavy-chain class

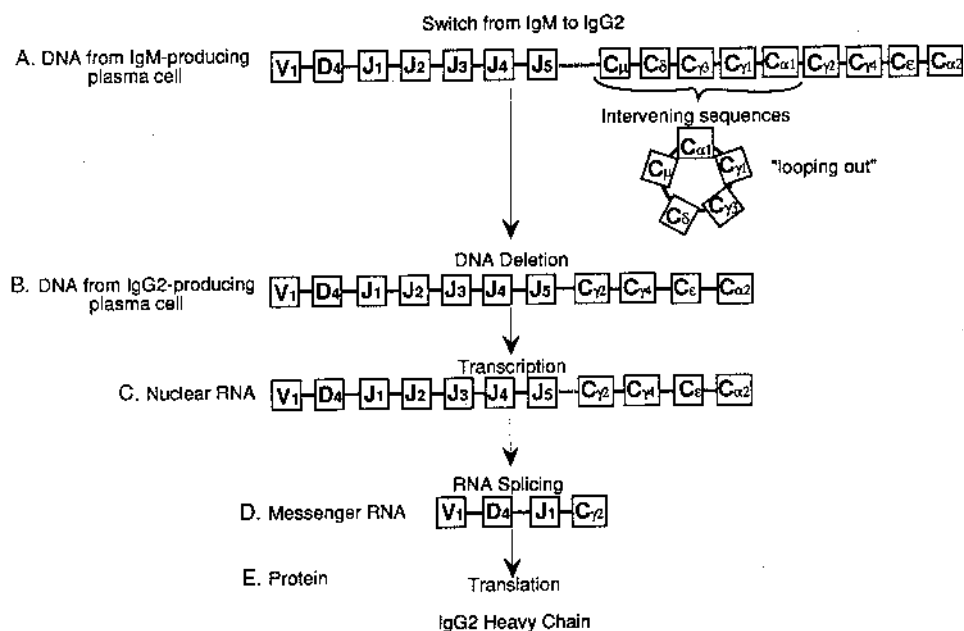

Fig. 7.3 In the secondary response, a plasma cell switches from IgM production (A) to IgG2 production by deleting a DNA loop containing the constant-region genes C_μ, C_δ, C_{γ3}, C_{γ1}, and C_{μ1} from the IgM heavy-chain gene (B). This DNA is now transcribed into nuclear RNA (C). RNA splicing links the C_{γ2} gene with the J₁ gene (D), and then the mRNA is translated into an IgG2 heavy chain (E). (Modified from David, J. R. *Antibodies: Structure and function*. In: *Scientific American Medicine*. Scientific American Inc., New York, 1980.)

or subclass, so that at the cellular level the same antibody specificity can be associated with the synthesis of an IgM immunoglobulin (characteristic of the early stages of ontogeny and of the primary response) or with an IgG immunoglobulin (characteristic of the mature individual and of the secondary response). Three mechanisms have been proposed to explain the heavy-chain class switch: intrachromosomal DNA recombination (recombination between sister chromatids, which constitute a chromosome), interchromosomal recombination (recombination between nonsister chromatids of the two homologous chromosomes), and looping-out and deletion of intervening DNA sequences within a single chromosome. The mechanism that contributes most substantially to isotype switching is probably a looping-out and deletion mechanism, in which the switched Ig sequences, C_{μ} and other intervening C_H genes, loop out and are subsequently deleted. This mechanism would predict the formation of circular DNA molecules containing the sequences deleted by isotype switching. Such DNA circles have now been isolated.

II. GENETIC BASIS OF ANTIBODY DIVERSITY

It has been estimated that an individual is capable of producing up to 10^9 different antibody molecules. How this vast diversity is generated from a limited number of germline elements has long been one of the most intriguing problems in immunology. There are two possible mechanisms for this variability: either the information is transmitted from generation to generation in the germline, or it is generated somatically during B-lymphocyte differentiation. The following genetic mechanisms have been shown to contribute to the generation of antibody diversity:

1. The existence of a large number of V genes and of a smaller set of D and J segments in the germline DNA, which has probably been generated during evolution as a consequence of environmental pressure. The human V_H locus comprises approximately 100 V, 30 D, and 6 J segments.
2. Combinatorial association: as aforementioned, there are at least 100 V-region genes for the heavy chain, and this is probably a conservative estimate. The total number of possible V genes is increased by the fact that any V segment can combine, in principle, with any J and D segments. Imprecise joining of various V-gene segments, creating sequence variation at the points of recombination, augments diversity significantly. In the case of the light chain, the number of V-region genes is estimated as 300, and they can also recombine with different J-region genes. Last, random association of L and H chains plays an important role in increasing diversity. For example, random association of 1000 H chains and 1000 L chains would produce 10^6 unique antibodies.
3. Somatic mutations were proposed to be a source of antibody diversity in the 1950s. Experimental support for this hypothesis, however, was only obtained three decades later. Comparison of nucleotide sequences from murine embryonic DNA and DNA obtained from plasmacytomas revealed several base changes, suggesting occurrence of mutations during lymphocyte differentiation. There appear to be some special mutational mechanisms involved in immunoglobulin genes since the mutation sites are clustered around the V genes and not around the C genes. In addition to these point mutations, certain enzymes can randomly insert and/or delete DNA bases. Such changes can shift

the reading frame for translation (frameshift mutations) so that all codons distal to the mutation are read out of phase and may result in different amino acids, thus adding to the antibody diversity. A large-scale sequencing of H and L chain genes found a much higher proportion of somatically introduced insertions and deletions than previously recognized. These insertions and deletions were clustered around the antigen-binding site, thus constituting a major mechanism of antibody diversity.

Somatic mutations (sometimes termed hypermutations) play a very important role in affinity maturation—production of antibodies with better antigen-binding ability. During the initial exposure to an antigen, rearranged antibodies with appropriate specificity bind to the antigen. Late in the response, random somatic mutations in the rearranged V genes result in the production of antibodies of varying affinities. By a process analogous to natural selection, B cells expressing higher-affinity antibodies are selected to proliferate and those with the lower-affinity antibodies are eliminated.

Additionally, gene conversion, a nonreciprocal exchange of genetic information between genes, has also been shown to contribute to the antibody diversity. It is interesting to note that one of the two recombination-activating genes described earlier, RAG-2, in addition to its synergistic role with RAG-1 in activating VDJ recombination, appears to be involved in gene conversion events.

After years of controversy over which mechanism, germline or somatic, is responsible for antibody diversity, it is clear that the involvement of both is necessary.

III. ANTIGENIC DETERMINANTS OF IMMUNOGLOBULIN MOLECULES

A. Isotypes

These determinants are present on all molecules of each class and subclass of immunoglobulin heavy chains and on each type of light chains; they are defined serologically by antisera directed against the constant regions of H and L chains. The antisera are produced in animals, which, upon injection of purified human immunoglobulins, recognize the structural differences between constant regions of H and L chains. Isotypic determinants are common to all members of a given species, hence they cannot be used as genetic markers. Their practical importance results from the fact that they allow the identification of classes and subclasses of immunoglobulins through the heavy-chain isotypes and types of light chains (κ , λ). All classes and subclasses of normal immunoglobulins share the two light-chain isotypes.

B. Idiotypes

The antigen-combining site in the V region of the immunoglobulin molecule, in addition to determining specificity for antigen binding, can also act as an antigen and induce production of antibodies against it. Such antigenic determinants, usually associated with hypervariable regions, are known as idiotypes.

C. Allotypes

These are hereditary antigenic determinants of Ig polypeptide chains that may differ between individuals of the same species. The loci controlling allotypic determinants are codominant (i.e., both are expressed phenotypically in a heterozygote) autosomal genes

that follow Mendelian laws of heredity. All allotypic markers that have so far been identified on human immunoglobulin molecules, with one exception (see later), are present in the C regions of H chains of IgG, IgA, IgE, and on κ -type L chains. Since different individuals of the same species may have different allotypes, these determinants can be used as genetic markers.

The most common technique used for allotype determination is hemagglutination-inhibition. For this purpose, ORh⁺ red cells are coated with IgG immunoglobulins of known allotypes. The coated cells will agglutinate when exposed to specific antibody. The agglutination, however, will be inhibited if the antiserum recognizing the allotype of the immunoglobulin coating the red cell is preincubated with soluble IgG carrying the same allotype. Thus, in a first step, the anti-allotypic antiserum and an unknown serum to be typed are mixed. In a second step, red cells coated with the relevant allotype are added to dilutions of the mixture. If agglutination is inhibited, it can be concluded that the allotype was present in the unknown serum.

1. IgG Heavy-Chain Allotypes (GM Allotypes)

Allotypes have been found on γ 1, γ 2, and γ 3 heavy chains but not as yet on γ 4 chains. They are denoted as G1M, G2M, and G3M, respectively (G for IgG, the numerals 1, 2, and 3 identify the subclass, the letter M for marker). At present, 18 GM specificities can be defined (Table 7.1): 4 associated with IgG1 (G1M), 1 associated with IgG2 (G2M), and 13 associated with IgG3 (G3M). G1M 3 and G1M 17 are localized in the Fd portion of the IgG molecule, while the rest are in the Fc portion. In some cases it has been shown that the antigenic differences recognized as allotypic are a consequence of single amino acid substitution on the heavy chains. For instance, G1M 3 heavy chains have arginine at position 214 and G1M 17 heavy chains have lysine at this position. A single heavy chain may possess more than one GM determinant; G1M 17 and G1M 1 are frequently present on the Fd and Fc portions of the same H chain in Caucasians.

Table 7.1 Currently Testable GM Allotypes

Heavy-chain subclass	Numeric	Alphameric
γ 1	G1M 1	a
	2	x
	3	f
	17	z
γ 2	G2M 23	n
γ 3	G3M 5	b1
	6	c3
	10	b5
	11	b0
	13	b3
	14	b4
	15	s
	16	t
	21	gl
	24	c5
	26	u
27	v	
28	g5	

The four C-region genes on human chromosome 14 that encode the four IgG subclasses are very closely linked. Because of this close linkage, GM allotypes of various subclasses are transmitted as a group called a haplotype. Also, because of almost absolute linkage disequilibrium between the alleles of various IgG C-region genes, certain allotypes of one subclass are always associated with certain others of another subclass. For example, the IgG1 gene controls G1M 3, whereas the IgG3 gene controls G3M 5 and G3M 21. We should expect to find G1M 3 associated with G3M 5 as often as with G3M 21; in fact, in Caucasians, a haplotype carrying G1M 3 is almost always associated with G3M 5 and not with G3M 21. Every major ethnic group has a distinct array of GM haplotypes. GM* 3 23 5,10,11,13,14,26 and GM* 1,17 5,10,11,13,14,17,26 are examples of common Caucasian and Negroid haplotypes, respectively. In accordance with the international system for human gene nomenclature, haplotypes and phenotypes are written by grouping together the markers that belong to each subclass, by the numerical order of the marker and of the subclass; markers belonging to different subclasses are separated by a space, while allotypes within a subclass are separated by commas. An asterisk is used to distinguish alleles and haplotypes from phenotypes.

2. *IgA Heavy-Chain Allotypes (AM Allotypes)*

Two allotypes have been defined on human IgA2 molecules: A2M 1 and A2M 2. They behave as alleles of one another. No allotypes have been found on IgA1 molecules as yet. Individuals lacking IgA (or a particular IgA allotype) have in some instances been found to possess anti-IgA antibodies directed either against one of the allotypic markers or against the isotypic determinant. In some patients these antibodies can cause severe anaphylactic reactions following blood transfusion containing incompatible IgA.

3. *IgE Heavy-Chain Allotypes (EM Allotypes)*

Only one allotype, designated as EM 1, has been described for the IgE molecule. Because of a very low concentration of IgE in the serum, EM 1 cannot be measured by hemagglutination-inhibition, the method most commonly used for typing all other allotypes. This marker is measured by radioimmunoassay using a monoclonal anti-EM 1 antibody.

4. *κ-Type Light-Chain Allotypes (KM Allotypes)*

Three KM allotypes have been described so far: KM 1, KM 2, and KM 3. (About 98% of the subjects positive for KM 1 are also positive for KM 2.) They are inherited via three alleles—KM* 1, KM* 1,2, and KM* 3—on human chromosome 2. No allotypes have yet been found on the λ-type light chains.

5. *Heavy-Chain V-Region Allotype (HV 1)*

So far, HV 1 is the only allotypic determinant described in the V region of human immunoglobulins. It is located in the V region of H chains of IgG, IgM, IgA, and possibly also on IgD and IgE.

IV. DNA POLYMORPHISMS: RFLPS

Several new genetic polymorphisms, detected directly at the DNA level, have been described in the Ig region. These are known as restriction fragment length polymorphisms (RFLPs) because they result from variation in DNA base sequences that modify cleavage

sites for restriction enzymes. RFLPs have been described in both the V and C regions. Their significance is under active investigation.

As aforementioned, the most widely used method for determining immunoglobulin allotypes is hemagglutination-inhibition, using antisera derived from fortuitously immunized human donors. Because of the scarcity of such antisera, investigations to examine the role of allotypes in immune responsiveness and disease susceptibility have been hampered. Recently, molecular methods that allow the detection of allotypes at the genomic level have been developed, thus circumventing the problems arising from the paucity of antisera.

V. ALLELIC EXCLUSION

One of the most fascinating observations in immunology is that immunoglobulin heavy-chain genes from only one of the two homologous chromosomes 14 (one paternal and one maternal) are expressed in a given B lymphocyte. Recombination of VDJC genes described earlier usually takes place on one of the homologs. Only if this rearrangement is unproductive (i.e., it does not result in the secretion of an antibody molecule) does the other homolog undergo rearrangement. Consequently, of the two H-chain alleles in a B cell, one is productively rearranged and the other is either in the germline pattern or is aberrantly rearranged (in other words, excluded). Involvement of the chromosomes is random; in one B cell the paternal allele may be active, and in another it may be a maternal allele. (Allelic exclusion is reminiscent of the X-chromosome inactivation in mammals, although it is genetically more complex.)

Two models have been proposed to explain allelic exclusion: *stochastic* and *regulated*. The main impetus for proposing the stochastic model was the finding that a high proportion of VDJ or VJ rearrangements are nonproductive, i.e., they do not result in transcription of mRNA. Therefore, according to this model, allelic exclusion is achieved because of the very low likelihood of a productive rearrangement on both chromosomes. According to the regulated model, a productive H- or L-chain gene arrangement signals the cessation of further gene rearrangements (feedback inhibition).

Results from experiments with transgenic mice (mice in which foreign genes have been introduced in the germline) favor the regulated model. It appears that a correctly rearranged H-chain gene not only inhibits further H-chain gene rearrangements but also gives a positive signal for the κ -chain gene rearrangement. The rearrangement of the λ gene takes place only if both alleles of the κ gene are aberrantly rearranged. (Although in some cases, it appears that the λ gene rearrangement is autonomous, that is, it does not depend on the prior deletion and/or nonproductive rearrangement of both κ alleles.) This mutually exclusive nature of a productive L-gene rearrangement results in *isotypic exclusion*, i.e., a given plasma cell contains either κ or λ chains, but not both.

Allelic exclusion is evident at the level of the GM system. A given plasma cell from an individual heterozygous for G1M* 17/G1M* 3 will secrete IgG carrying either G1M 17 or G1M 3, but not both. Since this is a random exclusion process, serum samples from such an individual will have both G1M 17 and G1M 3 secreted by different immunoglobulin-producing cells.

The process of allelic exclusion results in the synthesis of molecules with identical V regions in each single plasma cell because all expressed mRNA will have been derived from a single rearranged chromosome 14 and from a single rearranged chromosome 2 or 22. Therefore, the antibodies produced by each B lymphocyte will be of a single specificity.

VI. GM ALLOTYPES AND IGG SUBCLASS CONCENTRATIONS

Studies from several laboratories have found a correlation between certain GM allotypes or phenotypes and the concentration of the four subclasses of IgG. The results vary; however, virtually all studies report a significant association between the GM 3 5,13 phenotype and a high IgG3 concentration and the G2M 23 allotype and an increased concentration of IgG2. These associations imply that a determination of whether a person's IgG subclass level is in the "normal" range should be made in the context of the individual's GM phenotype.

VII. IMMUNOGLOBULIN ALLOTYPES, IMMUNE RESPONSE, AND DISEASES

Numerous studies have shown that immune responsiveness to certain antigens and susceptibility/resistance to particular diseases are influenced by GM and KM allotypes. How can C-region allotypes influence immune responsiveness thought to be exclusively associated with the V-region genes? The most likely mechanism involves the possible influence of C-region allotypes on antibody affinity. Contrary to the previously held views that the C domains do not play any role in antibody-binding affinity, the contribution of CH2 and CH3 domains—where the majority of the GM markers are located—on IgG binding strength is now firmly established. The CH1 domain—where allelic determinants G1M3 and 17 are located—has also been shown to modulate the kinetic competence of antigen-binding sites. Whether the structural differences in the CH domains caused by GM alleles also play a role in antibody affinity needs to be investigated.

Occasionally, particular alleles of the HLA, GM, and KM loci interact to influence immune responsiveness and disease susceptibility. The mechanisms underlying the interaction of these unlinked genetic systems are not understood.

The biological role and reasons for the extensive polymorphism of Ig allotypes remain unknown. The marked differences in the frequencies of Ig allotypes among races, strong linkage disequilibrium within a race, and racially restricted occurrence of GM haplotypes all suggest that differential selection over many generations may have played an important role in the maintenance of polymorphism at these loci. One mechanism could be the possible association of these markers with immunity to certain lethal infectious pathogens implicated in major epidemics, and different races may have been subjected to different epidemics throughout our evolutionary history. After a major epidemic, only individuals with allotypic combinations conferring immunity to the pathogen would survive. In this context, it is interesting to note that GM and HLA genes have been shown to influence the chance for survival in typhoid and yellow fever epidemics in Surinam.

SELF-EVALUATION

A. Questions

Choose the one *best* answer.

- 7.1 If we estimate that chromosome 14 has 100 V genes, 6 J segments, and 30 D segments and that chromosome 2 has 300 V genes and 5 J segments, the num-

ber of possible different specificities that can be generated by random combinatorial associations of these genes and random associations of heavy and k light chains with different variable regions is:

- A. 4.15×10^3
 B. 33×10^3
 C. 2.7×10^6
 D. 4.5×10^6
 E. 27×10^6
- 7.2 The antibody specificity of the immunoglobulins synthesized by a particular B cell is:
- A. Constantly changing due to somatic mutations
 B. Determined by the V region genes of the light chains
 C. Induced by interaction with antigen
 D. Not affected by the switch from one *idiotype* to another during B-cell differentiation
 E. Not affected by the switch from one *isotype* to another during B-cell differentiation
- 7.3 The class-specific antigenic determinants of immunoglobulins are associated with the:
- A. J chain
 B. T chain
 C. H chain
 D. L chain
 E. Secretory component
- 7.4 A human myeloma protein (IgM κ) is used to immunize a rabbit. The resulting antiserum is then absorbed with a large pool of IgM purified from normal human serum. Following this absorption, the antiserum is found to react only with the particular IgM myeloma protein used for immunization; it is now defined as an anti-idiotypic antiserum. With what specific portion(s) of the IgM myeloma protein would this antiserum react?
- A. Constant region of the μ chain
 B. Constant region of the κ chain
 C. Variable regions of μ and κ chains
 D. J chain
 E. None of the above
- 7.5 The following data is presented at a paternity suit:

	G1M	KM
Mother	f (f,f)	1,3 (1,3)
Mr. X	z,f (z,f)	1 (1,1)
Child (3 years old)	f	1

Which of the following conclusions is correct?

- A. Mr. X is the child's father.
 B. Mr. X is not the child's father.
 C. No conclusion about paternity is possible.
 D. There was a mix-up in the samples.

- 7.6 Somatic mutations can account for some degree of antibody diversity. These mutations:
- A. Occur at random in the different loci that control Ig synthesis
 - B. Predominantly affect the κ genes
 - C. Tend to involve the V genes only
 - D. Scramble the order of genes and gene fragments
 - E. Account for the C-gene switch during differentiation
- 7.7 A haplotype is defined as:
- A. The sum of different allospecificities detected in a given individual
 - B. Half of the allospecificities particular to a given individual
 - C. A cluster of allospecificities transmitted with one of the parental chromosomes
 - D. The order of genes coding for allotypic specificities in chromosome 6
 - E. The sum of different genes involved in coding for an immunoglobulin polypeptide chain
- 7.8 The GM phenotype of a given individual is GM 1, 3, 17 5. A single IgG1 molecule of this individual may express the following specificities:
- A. GM 1,3,17 5
 - B. GM 5
 - C. GM 1,3,17
 - D. GM 1,17
 - E. GM 3,17
- 7.9 The generation of antibody diversity is best explained by:
- A. Somatic mutation
 - B. Germline diversity
 - C. Combinatorial association
 - D. A combination of germline diversity, recombination events, and somatic mutations
 - E. Adaptation to the environment
- 7.10 The immunoglobulin G of an individual heterozygous for his GM markers will:
- A. Express only half of the specificities that the genome can code for
 - B. Carry all allotypic specificities for the corresponding isotype in all molecules since the allotypic loci are codominant
 - C. Carry half of the GM specificities in some molecules and the other half in the remaining molecules
 - D. Carry a random distribution of isotype-associated allotypes, with variable expression from molecule to molecule, due to recombination events during differentiation
 - E. Carry light chains with different allotypic specificities and identical isotypes

Answers

- 7.1 (E) Assuming that there are 300 V segments and 5 J segments coding for the VL region and 100 V segments, 30 D segments, and 6 J segments coding for the VH region, and considering that both VH and VL play a role in determining antibody specificity and that the association of VH and VL regions is a random error, the total number of antibody specificities gener-

ated from this random association of different regions and segments can be calculated as 27×10^6 . However, this is a conservative calculation, well below the estimated number of B-cell receptors (10^{11}). Additional diversity is likely to be generated by variability in the recombination of the different genes and during somatic hypermutation.

- 7.2 (E) One particular B cell may switch from one C_H to another, keeping the V_H region constant.
- 7.3 (C) The heavy chain isotypes define immunoglobulin classes and subclasses.
- 7.4 (C) The idiotypic determinants are closely associated to the antigen-binding site, which is defined by the V_H and V_L regions.
- 7.5 (C) The child is apparently homozygous for G1M f and KM 1. Since both the mother and Mr. X carried the G1M f and KM 1 markers, the child could belong to Mr. X but could also belong to any other male carrying the same markers. In actuality, paternity can be excluded with certainty but only proved to a probability of about 95% by examining the traditional genetic markers: immunoglobulin allotypes, blood groups, and HLA antigens. By employing the modern DNA “fingerprinting” methods, however, paternity can be proven with 100% likelihood.
- 7.6 (C) Rather than being randomly distributed across the genome, somatic mutations concentrate in the V region genes.
- 7.7 (C) Each child receives two haplotypes: one maternal and one paternal. His genotype will be the sum of the two haplotypes.
- 7.8 (D) GM 5 is a G3M allotype (present on IgG3 molecules rather than in IgG1 molecules); GM3 and 17 are alleles of a single locus and normally are not present on the same molecule (allelic exclusion). GM1 and 17 correspond to amino acid substitutions at two different sites for IgG1 and can be expressed simultaneously at different regions of one single $\gamma 1$ chain.
- 7.9 (D)
- 7.10 (C) As a consequence of allelic exclusion, each plasma cell only expresses one set of the alleles in the genome, but different cells will express both sets of alleles.

BIBLIOGRAPHY

- Agrawal, A., Eastman, Q. M., and Schatz, D. G. Transposition mediated by RAG1 and RAG2 and its implications for the evolution of the immune system. *Nature*, 394:744, 1998.
- Cedar, H., and Bergman, Y. Developmental regulation of immune system gene rearrangement. *Curr. Opin. Immunol.*, 11:64, 1999.
- Cooper, G. S., Miller, F. W., and Pandey, J. P. The role of genetic factors in autoimmune disease: Implications for environmental research. *Environ. Health Perspect.*, 107:693, 1999.
- de Vries, R. R. P., Meera, K. P., Bernini, L. F., van Loghem, E., and van Rood, J. J. Genetic control of survival in epidemics. *J. Immunogenet.*, 6:271, 1979.
- Kameda, H., Pandey, J. P., Kaburaki, J., Inoko, H., and Kuwana, M. Immunoglobulin allotype gene polymorphisms in systemic sclerosis: Interactive effect of MHC class II and KM genes on antinuclear antibody production. *Ann. Rheum. Dis.*, 57:366, 1998.
- Oettinger, M. A. V(D)J recombination: on the cutting edge. *Curr. Opin. Cell Biol.*, 11:325, 1999.
- Pandey, J. P., Zamani, M., and Cassiman, J.-J. Epistatic effects of genes encoding tumor necrosis factor- α , immunoglobulin allotypes, and HLA antigens on susceptibility to non-insulin dependent (type 2) diabetes mellitus. *Immunogenetics*, 49:860, 1999.

- Pritsch, O., Hudry-Clergeon, G., Buckle, M., et al. Can immunoglobulin C_H1 constant region domain modulate antigen binding affinity of antibodies? *J. Clin Invest.*, 98:2235, 1996.
- Rider, L. G., Shamim, E., Okada, S., Pandey, J. P., Targoff, I. N., O'Hanlon, T. P., Kim, H.-A., Lim, Y. S., Han, H., Song, Y. W., and Miller, F. W. Genetic risk and protective factors for idiopathic inflammatory myopathy in Koreans and American whites: A tale of two loci. *Arthr. Rheum.*, 42:1285, 1999.
- Tracy, R. B., Hsieh, C.-L., and Lieber, M. R. Stable RNA/DNA hybrids in the mammalian genome: Inducible intermediates in immunoglobulin class switch recombination. *Science*, 288:1058, 2000.
- Wabl, M., Cascalho, M., and Steinberg, C. Hypermutation in antibody affinity maturation. *Curr. Opin. Immunol.*, 11:186, 1999.

8

Antigen-Antibody Reactions

Gabriel Virella

I. GENERAL CHARACTERISTICS OF THE ANTIGEN-ANTIBODY REACTION

The reaction between antigens and antibodies involves complementary binding sites on the antibody and on the antigen molecules. The sites on the antigen molecule that combine with the binding site of an antibody are known as *epitopes*. In the same way that the binding site is determined by different segments on the variable regions of heavy and light chains that come in close proximity due to the folding of those regions, the epitopes are also formed by discontinuous segments of an antigen molecule. Crystallographic studies have defined protein epitopes as large areas, usually involving 15–22 amino acids located on several surface loops. Some subsets of amino acids within the epitope are likely to contribute most of the binding energy with the antibody, while the surrounding residues provide structural complementarity, which may play a stabilizing role when antigens and antibodies interact. The significance of critical amino acids in an epitope is illustrated by the fact that antibodies can distinguish immunoglobulin allotypes structurally determined by one or two amino acid substitutions in the constant regions of heavy or light chains (see Chapter 7).

The interaction between the antibody-binding site and the antigen epitope involves exclusively noncovalent bonds, in a manner similar to that in which proteins bind to their cellular receptors or enzymes bind to their substrates. The binding is reversible and can be prevented or dissociated by high ionic strength or extreme pH. The following intermolecular forces are involved in antigen-antibody binding:

Electrostatic Bonds. Electrostatic bonds result from the attraction between oppositely charged ionic groups of two protein side chains, for example, an ionized amino

group (NH^{4+}) on a lysine in the antibody and an ionized carboxyl group (COO^-) on an aspartate residue in the antigen.

Hydrogen Bonding. When the antigen and antibody are in very close proximity, relatively weak hydrogen bonds can be formed between hydrophilic groups (e.g., OH and C=O, NH and C=O, and NH and OH groups).

Hydrophobic Interactions. Hydrophobic groups, such as the side chains of valine, leucine, and phenylalanine, tend to associate due to van der Waals bonding and coalesce in an aqueous environment, excluding water molecules from their surroundings. As a consequence, the distance between them decreases, enhancing the energies of attraction involved. This type of interaction is estimated to contribute up to 50% of the total strength of the antigen-antibody bond.

Van der Waals Bonds. These forces depend upon interactions between the “electron clouds” that surround the antigen and antibody molecules. The interaction has been compared to that which might exist between alternating dipoles in two molecules, alternating in such a way that at any given moment oppositely oriented dipoles will be present in closely apposed areas of the antigen and antibody molecules.

All these types of interactions depend on the close proximity of the antigen and antibody molecules. For that reason, the “good fit” between an antigenic determinant and an antibody combining site determines the stability of the antigen-antibody reaction.

A. Antibody Specificity

Most of the data concerning this topic was generated in studies of the immune response to closely related haptens. Using a conjugate of *m*-aminobenzene sulfonate (haptenic group) with an immunogenic carrier protein, it was noticed that an animal inoculated with it would produce antibody that recognized this simple chemical group. When the antibody to *m*-aminobenzene sulfonate was tested for its ability to bind to the *ortho*, *meta*, and *para* isomers of aminobenzene sulfonate and to related molecules in which the sulfonate group was substituted by arsonate or carboxylate, it was noted (as shown in Table 8.1) that best reactivity occurred with the hapten used for immunization (*m*-aminobenzene sulfonate). Of the related haptens, *o*-aminobenzene sulfonate reacted reasonably while *m*-aminobenzene arsonate and *m*-aminobenzene carboxylate reacted very poorly or not at all.

These and other experiments of the same type led to the conclusion that specificity is mainly determined by the overall degree of complementarity between antigenic determi-

Table 8.1 Antigens Tested with Immune Serum for *Meta*-Aminobenzene Sulfonic Acid (Metanilic Acid)

	Antigens		
	<i>ortho</i> -	<i>meta</i> -	<i>para</i> -
Aminobenzene sulfonic acid	++	+++	+
Aminobenzene arsenic acid	0	+	0
Aminobenzoic acid	0	±	0

Source: Reproduced with permission from Landsteiner, K. *The Specificity of Serological Reactions*. Dover, New York, 1962.

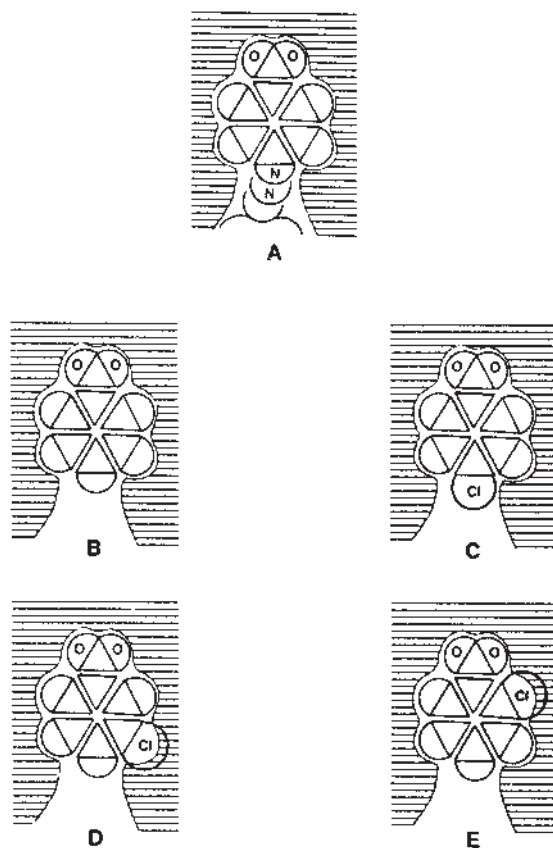

Fig. 8.1 Diagrammatic representation of the “closeness of fit” between antigenic determinants and antibody binding sites. Antibodies were raised against the *p*-azobenzoate group of a protein-*p*-benzoate conjugate. The resulting anti-*p*-benzoate groups react well with the original protein-*p*-benzoate conjugate (A) and with *p*-benzoate itself (B). If a chlorine atom (Cl) is substituted for a hydrogen atom at the *p* position, the substituted hapten will react strongly with the original antibody (C). However, if chlorine atoms are substituted for hydrogen atoms at the *o* or *m* positions (D,E), the reaction with the antibody is disturbed, since the chlorine atoms at those positions cause a significant change in the configuration of the benzoate group. (Redrawn from Van Oss, C. J. In: *Principles of Immunology*, 2nd ed. (N. Rose, F. Milgrom, and C. Van Oss, eds.). McMillan, New York, 1979.)

nant and antibody-binding site (Fig. 8.1); differences in the degree of complementarity determine the affinity of the antigen-antibody reaction.

B. Affinity

Antibody affinity can be defined as the attractive force between the complementary conformations of the antigenic determinant and the antibody-combining site. Experimentally, the reaction is best studied with antibodies directed against monovalent haptens. The reaction, as we know, is reversible and can be defined by the following equation:



where k_1 is the association constant and k_2 the dissociation constant.

In simple terms, The k_1/k_2 ratio is the *intrinsic association constant* or *equilibrium constant* (K). This equilibrium constant represents the intrinsic affinity of the antibody-binding sites for the hapten. High values for K will reflect a predominance of k_1 over k_2 , or, in other words, a tendency for the antigen-antibody complex to be stable and not to dissociate. The equilibrium constant (K) can be defined by the equation below:

$$k_1[\text{Ab}][\text{Hp}] = k_2[\text{AbHp}] \quad (2)$$

that can be converted into:

$$K = \frac{k_1}{k_2} = \frac{[\text{Ab}\cdot\text{Hp}]}{[\text{Ab}][\text{Hp}]} \quad (3)$$

where $[\text{Ab}]$ corresponds to the concentration of free antibody-binding sites, $[\text{Hp}]$ to the concentration of free hapten, and $[\text{Ab}\cdot\text{Hp}]$ to the concentration of saturated antibody-binding sites.

K , also designated as *affinity constant*, is usually determined by equilibrium dialysis experiments in which antibody is enclosed in a semi-permeable membrane and dialyzed against a solution containing known amounts of free hapten. Free hapten diffuses across the membrane into the dialysis bag, where it will bind to antibody. Part of the hapten inside the bag will be free, part will be bound, and the ratio of free and bound haptens depends on the antibody affinity. When equilibrium is reached, the amounts of free hapten will be identical inside and outside the bag. The difference between the amount of hapten inside the bag minus the concentration of free hapten outside the bag is equal to the amount of bound hapten. If the molar concentration of antibody in the system is known, it becomes possible to determine the values of r (number of hapten molecules bound per antibody molecule) and c (concentration of free hapten).

Taking Eq. (3) as a starting point, if $[\text{Ab}\cdot\text{Hp}]$ is divided by the total concentration of antibody, the quotient equals the number of hapten molecules bound per antibody molecule $[r]$, and the quotient between the number of vacant antibody sites $[\text{Ab}]$ divided by the total concentration of antibody equals the difference between the maximum number of antibody molecules that can be bound by antibody molecule $[n$ or valency], and the number of hapten molecules bound per Ab molecule $[r]$ at a given hapten concentration $[c]$. Eq. (3) can be rewritten as

$$K = \frac{r}{(n - r)c} \quad (4)$$

Equation (4), in turn can be rewritten as the Scatchard equation:

$$\frac{r}{c} = Kn - Kr \quad (5)$$

By determining r and c concentrations in a series of experiments with dialysis membranes carried out at different total hapten concentrations, it becomes possible, using Eq. (5), to construct what is known as a *Scatchard plot*, in which r/c is plotted vs. r (Fig. 8.2). It is also possible to determine the slope of the plot of r/c vs. r values that corresponds to K . The correlation between the slope and the affinity constant is also illustrated in Figure 8.2. With high-affinity antibodies, r will reach saturation ($r = n$) at relatively low concentrations of hapten, and the plot will have a steep slope, as shown at the left. With low-affinity antibodies, the stable occupancy of the antibody binding sites will require higher concentrations of free hapten, so the r/c quotients will be considerably lower and the slope

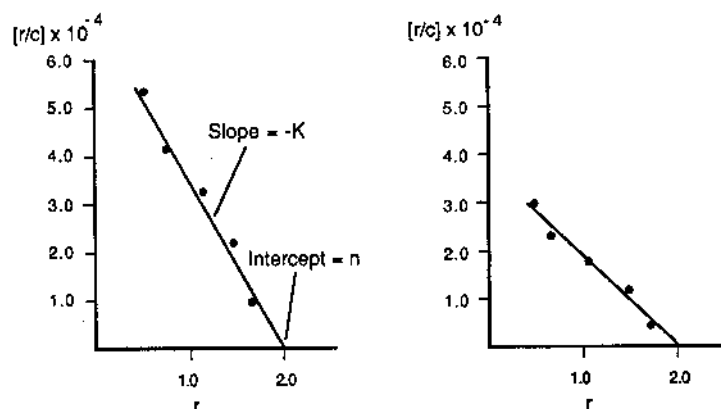

Fig. 8.2 Schematic representation of the Scatchard plots correlating the quotient between moles of hapten bound per moles of antibody (r) and the concentration of free hapten (c) with the concentration of hapten bound per mole of antibody (r). The slopes of the plots correspond to the affinity constants, and the intercept with the horizontal axis correspond to the number of hapten molecules bound per mole of antibody at a theoretically infinite hapten concentration (n or valency of the antibody molecule). The plot on the left panel corresponds to a high-affinity antibody, and the slope is very steep; the plot on the right panel corresponds to a low-affinity antibody, and its slope is considerably less steep.

considerably less steep, as shown on the right. Since the reactants (antibodies and haptens) are expressed as moles liter⁻¹, the affinity constant is expressed as liters mole⁻¹ (L·mol⁻¹).

From the Scatchard plot it is obvious that at extremely high concentrations of unbound hapten (c), r/c becomes close to 0, and the plot of r/c vs. r will intercept r on the horizontal axis (the interception corresponds to n , the antibody valency). For an IgG antibody and all other monomeric antibodies, the value of n is 2; for IgM antibodies, the theoretical valency is 10, but the functional valency is usually 5, suggesting that steric hindrance effects prevent simultaneous occupation of the binding sites of each subunit.

In most experimental conditions, an antiserum raised against one given hapten is composed of a restricted number of antibody populations with slightly different affinity constants. Under those conditions, it may be of practical value to calculate an *average intrinsic association constant* or *average affinity* (K_0), which is defined as the free hapten concentration required to occupy half of the available antibody-binding sites ($r = n/2$). Substitution of $r = n/2$ for r in Eq. (4) leads to the formula $K_0 = 1/c$. In other words, the average affinity constant equals the reciprocal of the free antigen concentration when antigens occupy half of the antibody-binding sites.

High-affinity antibodies have K_0 values as high as 10¹⁰ L·mol⁻¹. High-affinity binding is believed to result from a very close fit between the antigen-binding sites and the corresponding antigenic determinants, which favor the establishment of strong noncovalent interactions between antigen and antibody.

C. Avidity

Antibody avidity can be defined as the strength of the binding of the several different antibodies produced in response to an immunogen, which presents several different epitopes to the immune system. The strength of the Ag-Ab reaction is enhanced when several differ-

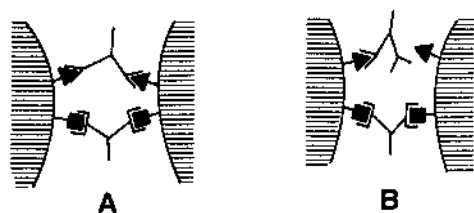

Fig. 8.3 Diagrammatic representation of the avidity concept. The binding of antigen molecules by several antibodies of different specificities (A) stabilizes the immune complex, since it is highly unlikely that all Ag·Ab reactions dissociate simultaneously at any given point of time (B). (Redrawn from Roitt, I. *Essential Immunology*, 4th ed. Blackwell, Oxford, 1980.)

ent antibodies bind simultaneously to different epitopes on the antigen molecule, cross-linking antigen molecules very tightly. Thus, a more stable bonding between antigen and antibody will be established due to the “bonus effect” of multiple antigen-antibody bonds (Fig. 8.3); the increased stability of the overall antigen-antibody reaction corresponds to an increased avidity.

D. Cross-reactions

When an animal is immunized with an immunogen, its serum will contain several different antibodies directed to the various epitopes presented by the immunizing molecule, reflecting the polyclonal nature of the response. Such serum from an immune animal is known as an *antiserum* directed against the immunogen.

Antisera containing polyclonal antibodies can often be found to cross-react with immunogens partially related to that used for immunization, due to the existence of common epitopes or of epitopes with similar configurations. Less frequently a cross-reaction may be totally unexpected, involving totally unrelated antigens which happen to present epitopes whose whole spatial configuration may be similar enough to allow the cross-reaction.

The avidity of a cross-reaction depends on the degree of structural similarity between the shared epitopes; when the avidity reaches a very low point, the cross-reaction will no longer be detectable (Fig. 8.4). The differential avidity of given antiserum for the original

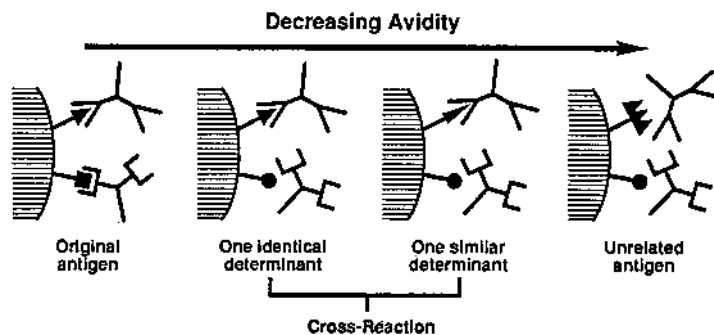

Fig. 8.4 Diagrammatic representation of the concept of cross-reaction between complex antigens. An antiserum containing several antibody populations to the determinants of a given antigen will react with other antigens sharing common or closely related determinants. The avidity of the reaction will decrease with decreasing structural closeness, until it will no longer be detectable. The reactivity of the same antiserum with several related antigens is designated as cross-reaction. (Redrawn from Roitt, I. *Essential Immunology*, 4th ed. Blackwell, Oxford, 1980.)

immunogen and for other immunogens sharing epitopes of similar structure is responsible for the “specificity” of the antiserum, i.e., its ability to recognize only one single immunogen or a few very closely related immunogens.

II. SPECIFIC TYPES OF ANTIGEN-ANTIBODY REACTIONS

Antigen-antibody reactions may be revealed by a variety of physical expressions, depending on the nature of the antigen and on the conditions surrounding the reaction.

A. Precipitation

When antigen and antibody are mixed in a test tube in their soluble forms, one of two things may happen: both components will remain soluble or variable amounts of Ag·Ab precipitate will be formed. If progressively increasing amounts of antigen are mixed with a fixed amount of antibody, a *precipitin curve* can be constructed (Fig. 8.5). There are three areas

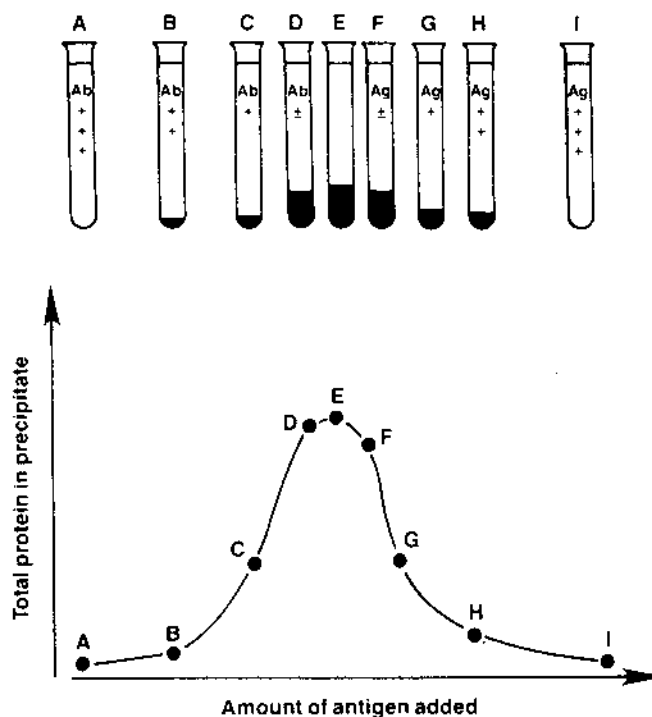

Fig. 8.5 The precipitin curve. When increasing amounts of antigen are added to a fixed concentration of antibody, increasing amounts of precipitate appear as a consequence of the antigen-antibody interaction. After a maximum precipitation is reached, the amounts of precipitate begin to decrease. Analysis of the supernatants reveals that at low antigen concentrations there is free antibody left in solution (antibody excess); at the point of maximal precipitation, neither antigen nor antibody are detected in the supernatant (equivalence zone); with greater antigen concentrations, antigen becomes detectable in the supernatant (antigen excess).

to consider in a precipitin curve:

- Antibody excess—free antibody remains in solution after centrifugation of Ag·Ab complexes.
- Equivalence—no free antigen or antibody remains in solution. The amount of precipitated Ag·Ab complexes reaches its peak at this point.
- Antigen excess—free antigen is detected in the supernatant after centrifugation of Ag·Ab complexes.

The “lattice theory” was created to explain why different amounts of precipitation are observed at different antigen-antibody ratios. At great antibody excess, each antigen will tend to have its binding sites saturated, with antibody molecules bound to all its exposed determinants. Extensive cross-linking of antigen and antibody is not possible. On the other hand, if one can determine the number of antibody molecules bound to one single antigen molecule, a rough indication of the valency (i.e., number of epitopes) of the antigen will be obtained. At great antigen excess, single antigen molecules will saturate the binding sites of the antibody molecule and not much cross-linking will take place either. If the antigen is very small and has no repeating epitopes, calculation of the number of antigen molecules bound by each antibody molecule will indicate the antibody valency, as discussed earlier in this chapter. When the concentrations of antigen and antibody reach the equivalence point, maximum cross-linking between Ag and Ab will take place, resulting in formation of a large precipitate that contains all antigen and antibody present in the mixture (Fig. 8.6).

Semi-solid supports, such as agar gel, in which a carbohydrate matrix functions as a container for buffer that fills the interstitial spaces left by the matrix, have been widely used

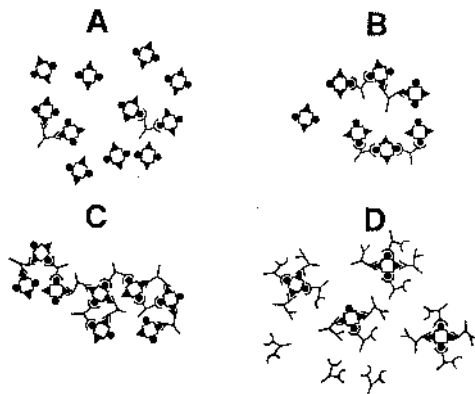

Fig. 8.6 The lattice theory explaining precipitation reactions in fluid media. At great antigen excess (A), each antibody molecule has all its binding sites occupied. There is free antigen in solution, and the antigen-antibody complexes are very small ($Ag_2 \cdot Ab_1$, $Ag_1 \cdot Ab_1$). The number of epitopes bound per antibody molecule at great antigen excess corresponds to the antibody valency. With increasing amounts of antibody (B), larger Ag·Ab complexes are formed ($Ag_3 \cdot Ab_2$, etc.), but there is still incomplete precipitation and free antigen in solution. At equivalence, large Ag·Ab complexes are formed, in which virtually all Ab and Ag molecules in the system are cross-linked (C). Precipitation is maximal, and no free antigen or antibody is left in the supernatant. With increasing amounts of antibody (D), all antigen-binding sites are saturated, but there is free antibody left without binding sites available for it to react. The Ag·Ab complexes are larger than at antigen excess [$Ag_1 \cdot Ab_{4,5,6} (n)$] but are usually soluble. The number of antibody molecules bound per antigen molecule at great antibody excess allows an estimate of the antigen valency.

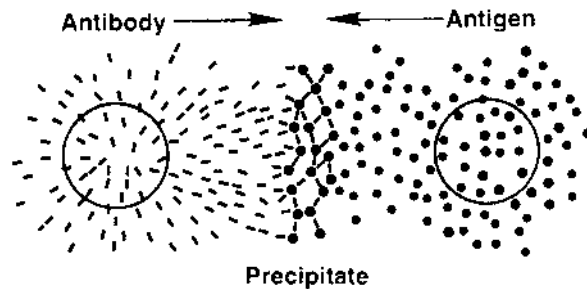

Fig. 8.7 Diagrammatic representation of a reaction of double immunodiffusion. Antigen and antibody are placed in opposite wells carved in a semi-solid medium (e.g., agarose gel). Both antigen and antibody diffuse in all directions and towards each other, reacting and eventually reaching equivalence, at which point a linear precipitate appears between the antigen and antibody wells.

for the study of antigen-antibody reactions. Antigen and antibody are placed in wells carved in the semi-solid agar and allowed to passively diffuse. The diffusion of antigen and antibody is unrestricted, and in the area that separates antigen from antibody the two reactants will mix in a gradient of concentrations. When the optimal proportions for Ag-Ab binding are reached, a precipitate will be formed, appearing as a sharp, linear opacity (Fig. 8.7).

B. Agglutination

When bacteria, cells, or large particles in suspension are mixed with antibodies directed to their surface determinants, one will observe the formation of large clumps; this is known as an *agglutination reaction*.

Agglutination reactions result from the cross-linking of cells and insoluble particles by specific antibodies. Due to the relatively short distance between the two Fab fragments, 7S antibodies (such as IgG) are usually unable to bridge the gap between two cells, each of them surrounded by an electronic “cloud” of identical charge that will tend to keep them apart. IgM antibodies, on the other hand, are considerably more efficient in inducing cellular agglutination (Fig. 8.8).

The visualization of agglutination reactions differs according to the technique used for their study. In slide tests, the nonagglutinated cell or particulate antigen appears as a homogeneous suspension, while the agglutinated antigen will appear irregularly clumped. If antibodies and cells are mixed in a test tube, the cross-linking of cells and antibodies will result in the diffuse deposition of cell clumps in the bottom and walls of the test tube, while the nonagglutinated red cells will precipitate in a very regular fashion, forming a compact red button on the bottom of the tube.

Agglutination reactions follow the same basic rules of the precipitation reaction. When cells and antibody are mixed at very high antibody concentrations (low dilutions of antisera), antibody excess may result, no significant cross-linking of the cells is seen, and, therefore, the agglutination reaction may appear to be negative. Dilutions in which antibody excess prevents agglutination constitute the *prozone*. With increasing antibody dilutions, more favorable ratios for cross-linking are reached, and very fine clumps cover the walls of the test tube or microtitration wells. When equivalence is approached, larger clumps of cells can be distinguished. At still higher dilutions, when the concentration of antibody is very low, the zone of antigen excess is reached and agglutination is no longer seen (Fig. 8.9).

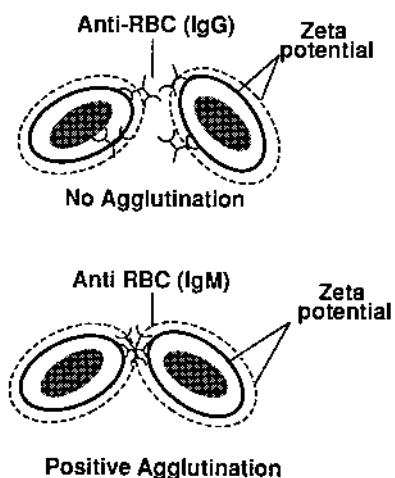

Fig. 8.8 IgM antibodies are more efficient in inducing red cell agglutination. Red cells remain at the same distance from each other due to their identical electrical charge (zeta potential). IgG antibodies are not large enough to bridge the space between two red cells, but IgM antibodies, due to their polymeric nature and size, can induce red blood cell agglutination with considerable ease.

III. BIOLOGICAL CONSEQUENCES OF THE ANTIGEN-ANTIBODY REACTION

A. Opsonization

After binding to particulate antigens or after forming large molecular aggregates, antibodies unfold and may interact with Fc receptors on phagocytic cells (see Chapter 6). Such interaction is followed by ingestion by the phagocytic cell (phagocytosis). Substances that promote phagocytosis are known as opsonins.

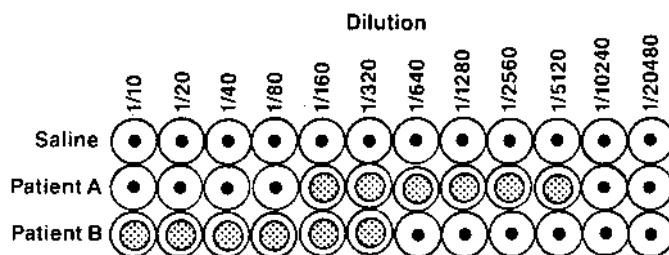

Fig. 8.9 Diagrammatic representation of a hemagglutination reaction performed in a microtiter plate. The objective of the study is to determine the existence and titer of hemagglutinating antibodies in three different samples. In the first step, each sample is sequentially diluted from 1/10 to 1/20480 in a separate row of wells (A,B,C). In a second step, a fixed amount of red cells is added to each serum dilution. In row A, no agglutination can be seen, and the sample is considered negative. In row B, the first three dilutions do not show agglutination (prozone), but of the next dilutions, up to 1/5120 are positive; this sample is positive, and the titer is 5120. In row C, the agglutination is positive until the 1/320 dilution; the titer of the sample is 320.

B. Fc-receptor-mediated Cell Activation

The interaction of antigen-antibody complexes with phagocytic cells through their Fc receptors results in the delivery of activating signals to the ingesting cell. When the Fc-receptor-bearing cell is a phagocyte, the activation is usually associated with enhancement of its microbicidal activity. A less favorable outcome of phagocytic cell activation is an inflammatory reaction, often triggered by spillage of the toxic mediators generated in the phagocytic cell after engagement of its Fc receptors. This outcome is more likely when the antigen-antibody complex is immobilized along a basement membrane or a cellular surface (see Chapters 13 and 23).

Another adverse reaction results from the engagement of Fc receptor-bound IgE on basophils and mast cells with their corresponding antigen. The result of this reaction is the release of the potent mediators that trigger an allergic reaction (see Chapter 21).

C. Complement Activation

One of the most important consequences of antigen-antibody interactions is the activation (or “fixation”) of the complement system (see Chapter 9).

The activation sequence induced by antigen-antibody reactions is known as the “classical” pathway. This pathway is initiated by the binding of C1q to the CH₂ domain of the Fc region of IgG and equivalent regions of IgM. It must be noted that the complement-binding sequences in IgG and IgM are usually not exposed in free antibody molecules, thus avoiding unnecessary and potentially deleterious activation of the complement system. The antigen-antibody interaction causes configurational changes in the antibody molecule, and the complement-binding regions become exposed.

The activation of C1q requires simultaneous interaction with two complement-binding immunoglobulin domains. This means that when IgG antibodies are involved, relatively large concentrations are required, so that antibody molecules coat the antigen in very close apposition, allowing C1q to be fixed by IgG duplets. On the other hand, IgM molecules, by containing five closely spaced monomeric subunits, can fix complement at much lower concentrations. One IgM molecule bound by two subunits to a given antigen will constitute a complement-binding duplet.

After binding of C1q, a cascade reaction takes place, resulting in the successive activation of eight additional complement components. Some of the components generated during complement activation are recognized by receptors on phagocytic cells and promote phagocytosis. C3b is the complement fragment with greater opsonizing capacity. Phagocytic cells (see Chapters 9 and 13) take up an antigen coated with opsonizing antibodies and C3b with maximal efficiency. Others, particularly the terminal complement components, induce cell lysis. These reactions have great biological significance and have been adapted to a variety of serological tests for diagnosis of infectious diseases, as will be discussed in Chapter 15.

The activation of the complement system may also have adverse effects, if it results in the destruction of host cells or if it promotes inflammation, which is beneficial with regard to the elimination of infectious organisms but always has the potential of causing tissue damage and becoming noxious to the host.

D. Neutralization

The binding of antibodies to bacteria, toxins, and viruses has protective effects because it prevents the interaction of the microbial agents or their products with the receptors that me-

diate their infectiveness or toxic effects. As a consequence, the infectious agent or the toxin become harmless, or, in other words, are neutralized.

SELF-EVALUATION

Questions

Choose the one *best* answer.

- 8.1 The following precipitation curve is prepared by adding variable amounts of tetanus toxoid to a series of tubes containing 0.7 mg of antibody each:

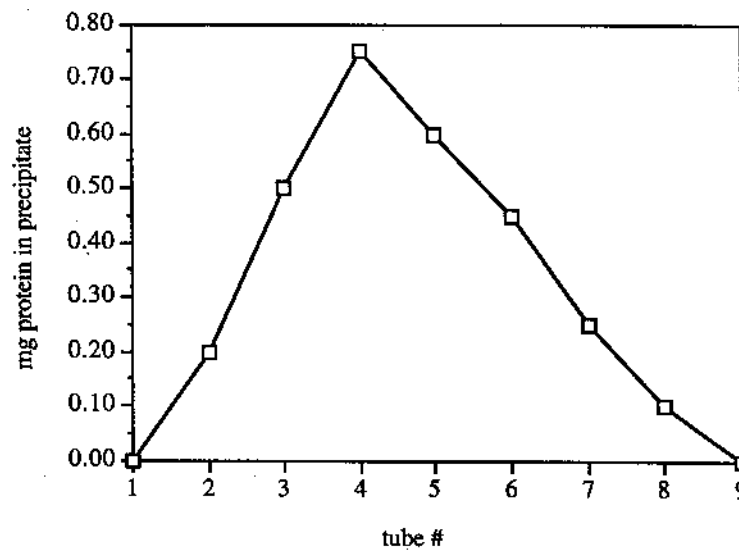

Precipitation observed in supernatant after addition of	Supernatant from tube #								
	1	2	3	4	5	6	7	8	9
Antibody	-	-	-	-	+	+	+	+	+
Antigen	+	+	±	-	-	-	-	-	-

(+ means visible precipitation; - means no visible precipitation)

Which tube(s) correspond to the antigen excess zone?

- A. 1 to 3
 B. 1 to 4
 C. 4
 D. 4 to 9
 E. 5 to 9
- 8.2 Using the data shown in Question 8.1, what was the concentration of antigen added to the tube corresponding to the equivalence point?
- A. 0.005 mg
 B. 0.01 mg
 C. 0.05 mg
 D. 0.1 mg
 E. 0.5 mg

- 8.3 The affinity of an antigen-antibody reaction depends primarily on the:
- Activation of the complement system
 - Antibody isotype
 - Closeness of fit between antibody-binding site and antigen epitope
 - Nature of the antigen
 - Valency of the antibody
- 8.4 Dr. I. M. Smart immunized a rabbit with sheep red cells and managed to separate anti-sheep red cell antibodies of several different isotypes. He then proceeded to mix 1 mL of saline containing 5×10^9 red cells and guinea pig complement with equimolecular concentrations of antibodies to sheep red cells of each different isotype. After incubating the mixture of red cells and anti-red cell antibodies for 5 minutes, he measured the amount of free hemoglobin in each tube. Which antibody was he likely to have added to the tube in which the concentration of free hemoglobin was highest?
- IgA
 - IgD
 - IgG1
 - IgG4
 - IgM
- 8.5 Dr. Smart then proceeded to perform another experiment in which he incubated 1 mL of saline containing 5×10^9 red cells with equimolecular concentrations of antibodies to sheep red cells of each different isotype in the complete absence of complement. After incubating the mixture of red cells and anti-red cell antibodies for one hour, he washed the red cells, added them to human monocytes, incubated for another hour, and then examined the monocytes microscopically to determine whether they had ingested the sheep red cells. Which antibody was most likely to have been added to the red cells that were more efficiently ingested?
- IgA
 - IgD
 - IgE
 - IgG1
 - IgM
- 8.6 The protective effect of preformed antiviral antibodies is related to their ability to:
- Agglutinate circulating viral particles
 - Form soluble immune complexes with viral antigens
 - Induce phagocytosis of the virus
 - Lyse the virus
 - Prevent the virus from infecting its target cell(s)
- 8.7 Which of the following hypotheses would sufficiently explain the non-precipitation of an antigen-antibody system?
- The antigen has only two determinants
 - The antigen has multiple, closely repeated determinants
 - The antibody has been cleaved with papain
 - The antibody has been cleaved with pepsin
 - Both C and D are correct

For Questions 8.8–8.10, find the one lettered sentence most closely related to it.

An animal is immunized with DNP-ovalbumin. Two weeks later the animal is bled, and the serum, containing antibodies to DNP-ovalbumin, is mixed with the hapten and two different hapten-carrier conjugates. What do you expect to observe with each mixture?

- A. Moderate precipitation (+)
 - B. Heavy precipitation (+++)
 - C. No precipitation
- 8.8 Anti-DNP-ovalbumin + DNP
 8.9 Anti-DNP-ovalbumin + DNP-ovalbumin
 8.10 Anti-DNP-ovalbumin + DNP-gammaglobulin

Answers

- 8.1 (E) If the tubes contain an excess of antigen, the supernatants will contain free antigen and visible precipitation will result from the addition of antibody to those supernatants.
- 8.2 (C) The amount of antibody in every tube was 0.7 mg, and the amount of protein in the equivalence point (defined as the tube with maximal precipitation, whose supernatant contains neither free antigen nor free antibody) was 0.75 mg. Therefore, the difference between antibody concentration and total protein concentration was the antigen concentration, i.e., 0.05 mg.
- 8.3 (C)
- 8.4 (E) Molecule by molecule, IgM antibodies are more efficient complement fixators than IgG antibodies and would cause more red cells to lyse.
- 8.5 (D) IgG1 and IgG3 antibodies are the most efficient in inducing Fc-receptor-mediated phagocytosis.
- 8.6 (E) Preformed antiviral antibodies may have a neutralizing effect if they block the infection of the virus target cell(s). Phagocytosis of virus-antibody complexes often results in infection of the phagocytic cells.
- 8.7 (C) Papain digestion breaks the IgG molecule (which can cross-link multivalent antigen molecules to produce precipitation reactions) into one Fc and two Fab fragments. The Fab fragments have one single binding site and cannot cross-link antigens and cause precipitation. The F(ab')₂ fragment obtained with pepsin, on the contrary, is bivalent, able to cross-link multivalent antigens, forming large lattices and precipitants.
- 8.8 (C) The soluble DNP hapten, although able to bind to bivalent anti-DNP, will do so without forming a precipitate because DNP has one single binding site in its soluble form and cannot bind to more than one antibody molecule to cross-link and form a precipitate.
- 8.9 (B) The papain Fab fragments are monovalent, cannot cross-link, and precipitate antigen molecules; in contrast, the F(ab')₂ fragments obtained with pepsin are bivalent, can cross-link, and precipitate antigen molecules.
- 8.10 (A) It is expected that some precipitation will occur if anti-DNP is mixed with a different DNP-carrier combination than the one used for immunization, since each carrier molecule will express several DNP groups and cross-linking of the hapten-carrier conjugate can occur through anti-DNP anti-

bodies. However, the amount of precipitate observed should be smaller than when anti-DNP-OVA is mixed with DNP-OVA, in which case both anti-DNP and anti-OVA antibodies will participate in precipitate formation.

BIBLIOGRAPHY

- Atassi, M.-Z., van Oss, C. J., and Absolom, D. R. *Molecular Immunology*. Marcel Dekker, New York, 1984.
- Day, E. D. *Advanced Immunochemistry*, 2nd ed. Wiley-Liss, New York, 1990.
- Eisen, H. N. Antibody-antigen reactions. In: *Microbiology* (Davis, B. D., Dulbecco, R., Eisen, H. N., and Ginsberg, H. S., eds.). Lippincott, Philadelphia, 1990.
- Glynn, L. E., and Steward, M. W. (eds.). *Immunochemistry: An Advanced Textbook*. John Wiley & Sons, New York, 1977.
- Landsteiner, K. *The Specificity of Serological Reactions*. Dover Publications, New York, 1962.
- Laver, W. G., Air, G. M., Webster, R. G. and Smith-Gill, S. J. Epitopes on protein antigens: Misconceptions and realities. *Cell*, 61:663, 1990.
- Steward, M. W. Introduction to methods used to study antibody-antigen reactions. In: *Handbook of Experimental Immunology*, Vol. 1, 3rd ed. (D. M. Weir, ed.). Blackwell Scientific Publications, Oxford, 1978, p. 16.1.
- Van Oss, C. J., and van Regenmortel, M. H. V. *Immunochemistry*. Marcel Dekker, New York, 1994.

9

The Complement System

Robert Boackle

I. INTRODUCTION

As a consequence of antigen-antibody reactions, important changes occur in the physical state of the antibodies. As antigen and antibody react and form aggregates, the antibody molecule undergoes conformational changes. These events are responsible for changes in the spatial orientation and exposure of biologically active domains or segments located on the Fc region of those antibodies. For example, the Fc region of antigen-bound molecules of IgM, IgG3, IgG1, and to a lesser degree IgG2 are able to bind and activate the first component of a series of rapidly acting plasma proteins, known as the complement system.

II. THE COMPLEMENT SYSTEM

The complement system includes several components that exist in a nonactive state in the serum. When these complement components are converted to their active form, a sequential, rapid, cascading sequence ensues.

A. Synthesis and Metabolism of Complement Components

Most of the complement glycoproteins are synthesized predominantly by the liver, but macrophages and many other cell types are also sources of various complement components, especially at sites of infection and/or inflammation. All normal individuals always have complement components in their blood. The synthetic rates for the various comple-

ment glycoproteins increase when complement is activated and consumed during an infection. The increased rates appear to be under several regulatory mechanisms, such as the presence of cytokines generated at the site of the infection and the increase of various complement fragments or subcomponents that are released due to complement activation.

B. Activation of the Complement System

In addition to antigen-antibody complexes, which play a critical role in the activation of the classical complement pathway (see below), several other substances activate the complement system, but to lesser degrees. Nonspecific direct activators include proteolytic enzymes, released either from microbes or from host cells (e.g., neutrophils) at the sites of infection or dying cells at sites of tissue necrosis/damage. In addition, membranes and cell walls of microbial organisms are potential complement activators; they activate the complement system starting at the third complement component via the alternative pathway, which will be discussed in the second half of this chapter. A third, newly discovered mechanism for activating complement is the lectin pathway, which utilizes mannan-binding lectin (MBL) present in human serum. Mannan is a capsular substance of pathogenic fungi (e.g., *Cryptococcus neoformans* and *Candida albicans*) and is only one of several foreign polysaccharide substances to which human MBL binds via Ca^{2+} -dependant interactions.

At this point, the following important concepts should be stressed:

Complement exists in a stable and nonactivated form, and the classical pathway is activated by antigen-antibody complexes.

Complement is a biologically potent system. Once it is activated, it may promote local reactions characterized by edema and smooth muscle contraction.

Complement is a fast-acting, cascading (amplifying) system, with most effects occurring within a few minutes.

Each step in the complement sequence is tightly regulated and controlled to maximize the damage to any foreign substance. Such controls (a) prevent unnecessary consumption of complement components after sufficient complement has deposited on the antigens and (b) spare the nearby cells of the host from inadvertent complement attack.

C. Primary Function of the Complement System

The primary function of the complement system is to bind and neutralize any foreign substance that activates it and then to effectively cause those neutralized complement-coated substances to tightly adhere to phagocytes thereby enhancing phagocytosis. In this regard, the third complement component (C3) is a major factor due to its position in the classical, alternative, and lectin pathways and because of its relatively high concentration in serum.

III. THE CLASSICAL COMPLEMENT PATHWAY

A. Activation of the Classical Complement Pathway By Antigen-Antibody Complexes

Immunoglobulins and native complement components are normally found in the serum and in the lymph, but these molecules do not interact with each other until the antibodies inter-

act with their corresponding antigens and undergo the necessary conformational changes. These immunoglobulin conformational changes are the basis for specific activation of the very powerful classical complement pathway.

1. *The Initiation of the Cascade: C1 Activation*

Native, free immunoglobulin does not activate the complement system. A single native IgG molecule will not bind and activate the first component (C1) in the complement pathway. However, if IgG antibodies are aggregated by antigen binding, wherein their Fab arms move about the hinge region in order to bind to antigenic determinants and therein expose the C_H2_γ region on their Fc, this will result in C1 binding (fixation) and activation.

The IgG subclasses vary with regard to their efficiency in activating C1, which is directly related to the length of the IgG hinge region. A longer hinge region allows movement of the Fab arms further away from the Fc so as to more fully expose the C_H2 region. Thus IgG3, upon binding antigen, is by far the most efficient subclass of IgG in activating C1, followed by IgG1 and weakly by IgG2. IgG4 does not effectively activate the classical complement pathway.

For C1 to be activated, it must bind to at least two adjacent IgG antibodies that are bound to antigens. This usually means that the concentration of antibody must be relatively high and that the specific antigenic determinants recognized by the IgG antibody must be in close proximity. When antigens are in close proximity on a bacterial or viral surface, C1 is very effectively activated, especially when specific IgG3 or IgG1 antibodies are deposited. For IgM, a pentamer, these logistical problems are less critical. Indeed, IgM-immune complexes are very potent activators of C1. IgA antibodies, in contrast, have relatively weak classical pathway activating properties.

2. *The Early Stages: C1 to C3*

The aggregated Fc regions of the deposited IgG molecules have binding sites, located on the C_H2 domain, for an umbrella-like subcomponent of the C1 molecule, known as C1q. Detailed chemical studies have revealed that C1 is actually a complex of three different types of molecules (one C1q molecule, two C1r molecules, and two C1s molecules) held loosely together through non covalent bonds and requiring a physiological Ca²⁺ concentration for their proper association.

Under physiological conditions, the subcomponents of C1 (C1q, C1r₂, and C1s₂) associate but exist in conformations that partially limit the “tightness” of that association. Physiological levels of calcium ions and ionic strength are essential to maintain these slightly weaker associations within the C1 macromolecular complex. These conditions prevent spontaneous C1 activation that would otherwise readily occur upon a tighter association.

C1q contains several distinct portions; a collagen-like stem region, which branches into a six-branched umbrella-shape. Within the umbrella portion of the stem an association with the two C1r and two C1s molecules occur. Each of the six collagen-like branches terminates in a single globular head region. It is these globular head regions that have the potential to associate with the exposed Fc regions of the antibodies present on immune complexes (Fig. 9.1). As a consequence of the C1q globular head regions interacting with the exposed C_H2 of adjacently deposited IgG3 antibodies, C1q undergoes significant conformational changes. This dramatic C1q conformational change spontaneously facilitates a tightened C1q-C1r₂-C1s₂ association, resulting in the movement and self-activation of the

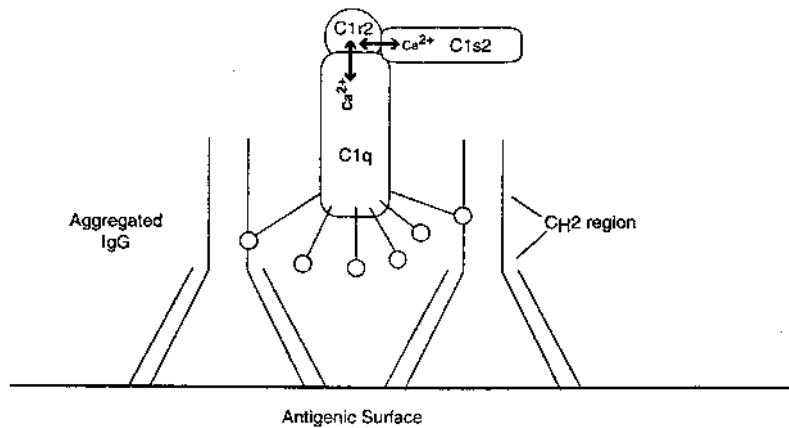

Fig. 9.1 C1 activation by an antibody duplet formed by binding to the corresponding antigen.

two C1r pro-enzymes by one another to form two activated C1r enzymes within the macromolecular C1 complex. The activated C1r₂ enzymes have a protease activity that cleaves a peptide bond within the two adjacent C1s molecules, which in turn become activated enzymes. Activated C1s₂ enzymes (within the C1 macromolecular complex) are then able to cleave and activate the next component in the series, C4.

It is important to realize that at this step active host C1s enzymes are present on the antigenic surface via the association of the immune complexes with activated C1. The deposition of complement enzymes on the antigenic surface is the major reason for the rapid, amplifying effect of the classical complement pathway, because C1s enzymes will continue to activate C4 and C2 until the C1s enzymes are inhibited.

As native C4 molecules come into contact with the C1-immune complex, they bind and are cleaved by activated C1s into a small fragment, which remains soluble (C4a), and a larger fragment, C4b. As a helpful rule remember that fragments released into the fluid phase are often designated by the letter a, while those fragments that remain bound to membranes are designated by the letter b. However, the nomenclature of C2 fragments is reversed, i.e., the bound fragment is designated as C2a, and the soluble fragment as C2b. Each activated C1 is able to cleave and convert many C4 molecules to C4a and C4b. The second fragment derived from C4, C4b, has a very short-lived and highly reactive binding site. This active binding site (an acylating group) allows C4b to bind covalently to the nearest hydroxy or amino group, which is usually located on the antigenic surface (Fig. 9.2). Antibody-coated viral envelopes or antibody-coated bacterial membranes serve as excellent sites for C4b deposition.

Any activated C4b molecules that do not reach the nearby antigenic surface within a few nanoseconds (unable to bind covalently to the antigen) will lose their short-lived active binding site and undergo conformational changes that facilitate binding to a serum factor termed C4-binding protein. Binding of C4 to C4-binding protein causes rapid loss of C4b function and is a very important control mechanism to protect the host's tissues from "by-stander attack" by the C4b molecules being formed in areas of infection.

The activated C1s within the bound C1 macromolecular complex is also responsible for the activation of C2, the next complement component to be activated in the classical pathway. In the presence of magnesium ions (Mg²⁺), C2 interacts with antigen-bound C4b and is, in turn, split by C1s into two fragments, termed C2b and C2a. C2b fragments are re-

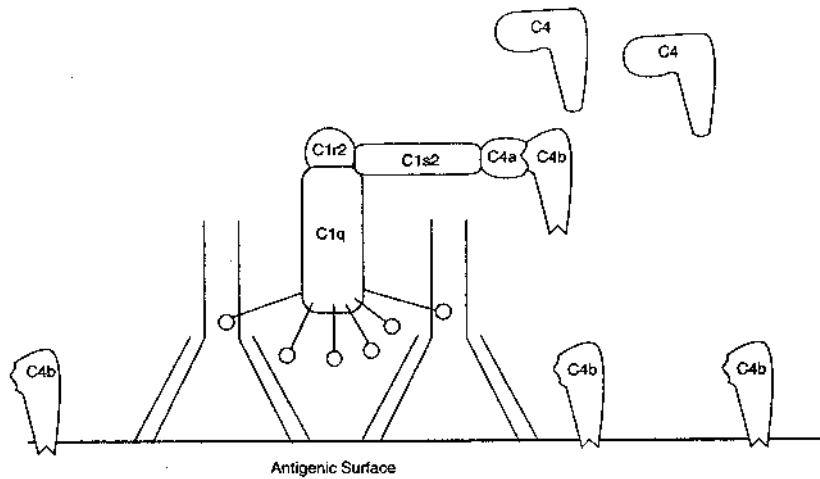

Fig. 9.2 Binding of C4b to the cell membrane, released into the fluid phase, while C3d will remain cell-associated.

leased into the fluid phase, and C2a binds to C4b (Fig. 9.3). Thus, proper concentrations of Ca^{2+} ions are needed for optimal C1q-C1r₂-C1s₂ interactions, and Mg^{2+} ions are required for proper C4b-C2a formation. In the absence of Ca^{2+} and/or Mg^{2+} (due to the addition of metal chelators such as EDTA), the classical activation pathway is interrupted. An excessive level of Ca^{2+} also tends to disrupt the association of C1q-C1r₂-C1s₂.

The biological role of the soluble C2b fragments is controversial. Some scientists postulate that the soluble C2b fragments induce increased capillary permeability, causing leakage of fluid into the interstitial spaces (edema). Thus, the generation of large amounts of C2b is speculated to be one of several pathogenic events in hereditary angioneurotic edema (see below).

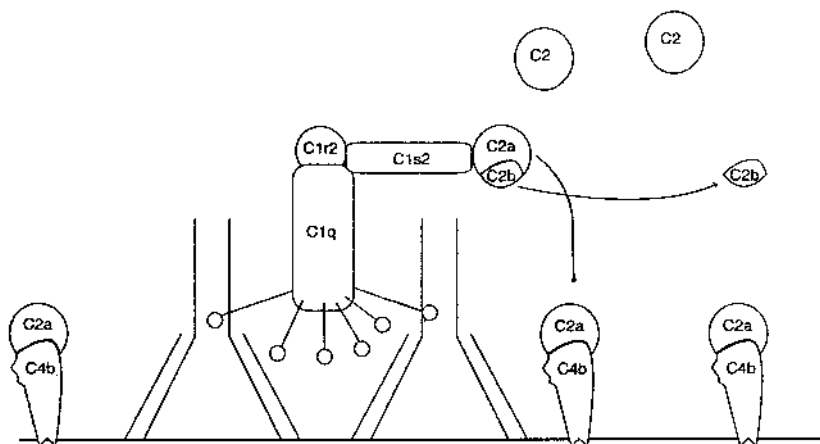

Fig. 9.3 Formation of C4b2a complexes on cell membranes. Although activated C1s (within the bound C1 macromolecular complex) can cleave any C2 molecule that it encounters, the cleavage of a C2 molecule adjacent to membrane-bound C4b increases the probability of generating bound C4b2a complexes on the cell membrane.

However, the C2 fragment with the best-defined role is C2a, which, when bound to C4b, has the active enzyme site necessary for the activation of C3. For C3 to be activated, C2a must remain as a stable complex associated with the membrane-bound C4b molecule. The active C4b2a complex is also known as C3 convertase because it enzymatically converts the next component in the series, C3 to C3b and C3a (Fig. 9.4). Once active C4b2a complexes are deposited on the antigenic membrane surface surrounding each of the immune complexes, each bound C4b2a complex is capable of rapidly activating many C3 molecules, until the C4b2a complex is disrupted or the enzymatic activity of C2a decays. When deposited C3b associates with the bound C4b2a to form C4b2a3b the complex acquires the capability of binding to C5, wherein C2a (within the C4b2a3b complex) cleaves C5 into C5b and C5a. The newly formed C3b must bind to an amino group or hydroxyl group on the antigen (via its very short-lived active binding site) to remain active. If this fails to happen, the fluid phase C3b associates with Factor H in the serum and is quickly digested by a serum protease, Factor I.

Thus, a general rule emerges. As each additional component is added to the antigen-antibody-complement complex, the growing complexes acquire the information needed for binding and activating the next component in the series. The activities expressed at each stage of the sequence are regulated by several mechanisms, including the spontaneous decay of C2a activity with time, the short-lived active binding sites on activated complement fragments and the effects of the normally occurring serum complement inhibitors. In gen-

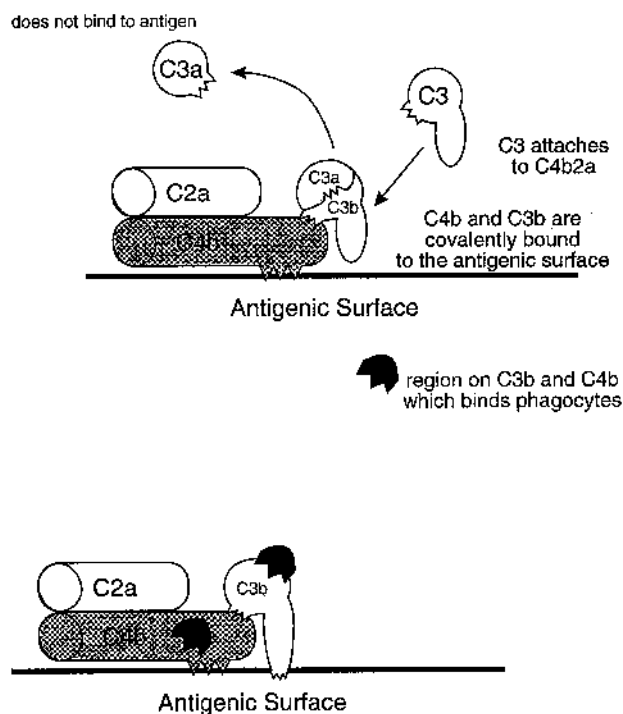

Fig. 9.4 C3 activation by C4b2a results in the split of C3b into two fragments. While C3b remains associated with C4b2a, C3a is released into the fluid phase (top). Sites recognized by phagocytic cell receptors become expressed on the cell-associated C4b and C3b fragments (bottom).

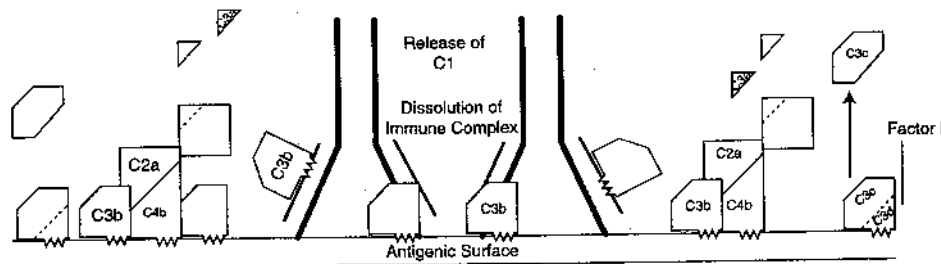

Fig. 9.5 Binding of C3 fragments to antigen-antibody complexes on cell membranes results in the dissolution of the immune complex. In addition, Factor I will split C3b into (1) C3c and C3d and (2) C3c.

eral, the roles of the serum complement inhibitors are to:

1. Restrict the complement cascade to the surface of the foreign material
2. Prevent bystander damage to the host
3. Limit unnecessary consumption of complement components

3. Regulatory Mechanisms of the Early Stages

Soon after antigen and antibody react, C4b and especially C3b accumulate on the antigenic surface at such high levels that they begin to deposit onto the specific antigenic determinants recognized by the antibody molecules. C4b and C3b molecules also bind to the Fab region of the bound antibodies. Both of these phenomena interfere with the ability of antibodies to remain associated with specific epitopes in the antigen. This partial dissolution of the immune complex results in the loosening of the C1 macromolecule from the immune complex as the antibody molecule recovers its native configuration and the complement binding sites on the CH2 region become less accessible. As C1 begins to separate from the immune complex, the C1q-C1r₂-C1s₂ macromolecular complex tends to return to its loosely associated form. At that point, the activated C1r₂ and C1s₂ enzymes are extremely susceptible to irreversible inhibition by a normal serum glycoprotein termed C1 inhibitor (C1 INH). C1 INH forms C1-INH-C1r and C1-INH-C1s complexes, most of which are separated from the bound C1q (Fig. 9.5). Activated C1, once having performed its function while bound to the immune complex, is now irreversibly inhibited from unnecessarily consuming more native C4 and C2. The proper function of C1-INH represents a very important regulatory mechanism that restricts the range of activated C1 action to the surface of the antigen and prevents useless consumption of C4 and C2.

4. Immune Adherence and Phagocytosis

Prior to its decay or its inactivation, each of the activated membrane-bound activated C4b2a enzyme complexes activates many C3 molecules. The normal concentration of serum C3 is about 130 mg/dL, which is relatively high and indicates the importance of C3 in the complement activation pathways. C3 is converted through a process that involves its proteolytic cleavage and release of a small biologically active peptide, termed C3a. The larger C3b fragment upon activation behaves very much like the C4b fragment, in that it also has a short-lived, highly reactive binding site, which binds irreversibly to the nearest membrane surface, which is usually the complement-activating antigen.

C3b associates with the bound C4b2a complexes. However, many other C3b molecules bind independently to the antigenic membrane. The deposited C3b molecules also participate in a tremendous amplification of additional C3b deposition via a mechanism termed the amplification loop (to be discussed later in this chapter). It is important to understand that the irreversible (covalent) binding of C4b and of C3b molecules to the antigen actually changes the nature of the antigen. In the case of endotoxin, C4b and C3b deposition abrogates the toxicity of the molecule. Similarly, C4b and C3b contribute to antibody-mediated neutralization of viruses, rendered incapable of properly binding and infecting host cells.

Of great biological significance is the fact that after C4b and C3b bind to the antigenic surface, they undergo conformational changes that result in the exposure of regions of these two molecules that extend away from the antigenic membrane. These exposed parts of C4b and C3b are biologically important because they contain molecular segments which are able to bind to C3b/C4b receptors (currently designated as CR1, complement receptor 1) located on host phagocytic cells (Fig. 9.6). Additional types of receptors for other regions on bound C3b play also a significant role in enhancing phagocytosis. Some of those receptors recognize interior (cryptic) regions of C3b exposed as this component is further catabolized (with time) to form inactivated C3b (iC3b), then C3dg, and finally C3d (Fig. 9.7).

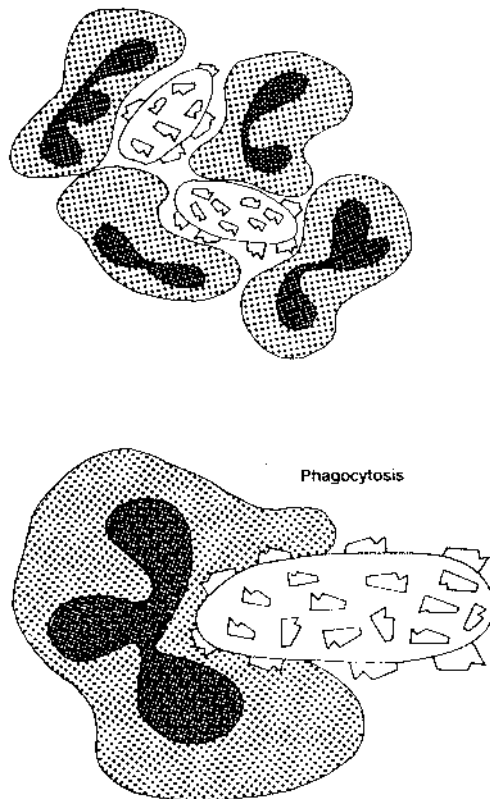

Fig. 9.6 Opsonization and phagocytosis. The top panel shows immune adherence of phagocytic cells to antigenic cells coated with antibody and complement, and the bottom panel illustrates the ingestion (phagocytosis) of an opsonized cell.

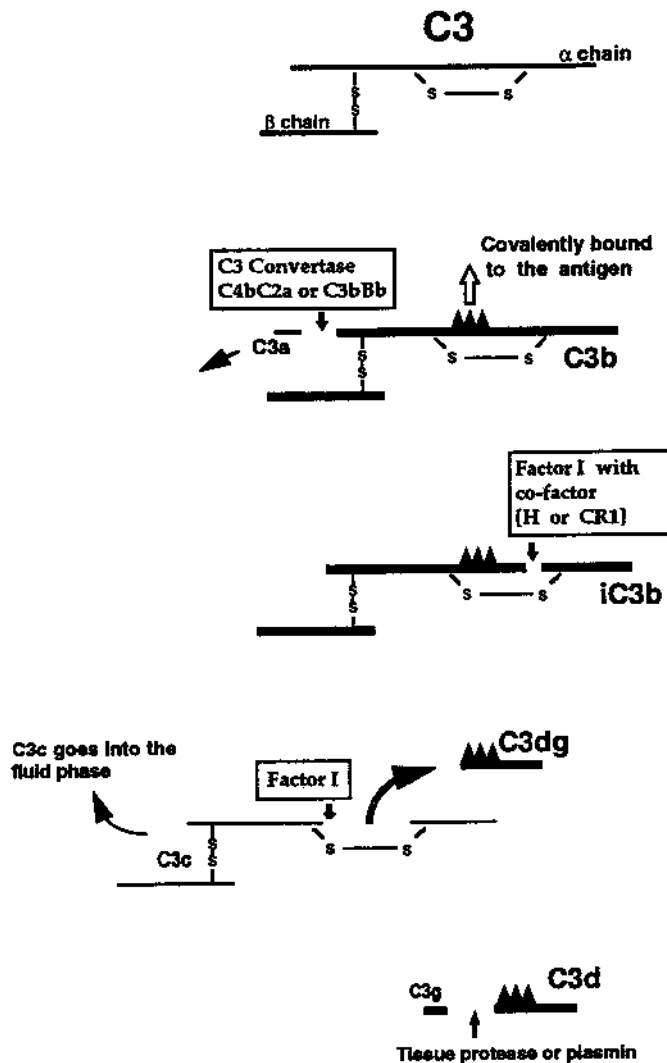

Fig. 9.7 Diagrammatic summary of the different steps involved in C3 inactivation.

Polymorphonuclear leukocytes, like other phagocytic host cells, have thousands of complement receptors on their membranes allowing them to bind, with high avidity, particles coated with C3b (and C4b) and/or with breakdown products of bound C3b (i.e., iC3b). This increased avidity of phagocytic cells for complement-coated particles is known as enhanced immune adherence, and its main consequence is a significant potentiation of the phagocytosis process. In this process, the phagocyte is stimulated to engulf the complement-coated particle because of the interactions with complement receptors on the phagocytic cell membrane. Once engulfed, antigens are digested in phagolysosomes, vesicles that result from the fusion of phagosomes, containing phagocytosed particles, and lysosomes, which contain a large variety of degradative enzymes. The phagocytic process is one of the most important fundamental defense mechanisms because it provides a direct way for the host to digest foreign substances (see Chapter 13).

5. The Late Stages: C5 to C9

The full effect of the activation of the later complement components is evident when the activated complement components are deposited on a cell membrane. C5 molecules can be activated by antigen-bound (membrane-associated) C4b2a3b_n complexes or by alternative pathway/amplification loop enzymes, to be discussed later. As expected, activation of C5 is mediated by the specific proteolytic cleavage of C5 molecules by activated C4b2a3b_n deposited on the antigen (e.g., foreign cell membrane). Each C5 molecule first binds to an activated C4b2a3b_n complex and then is split into a small fragment (C5a), which is released into the fluid phase, and a large fragment (C5b). Unlike other complement fragments previously discussed, C5b does not bind immediately to the nearest cell membrane. A complex of C5b, C6, and C7 is first formed, and then the C5b67 complex attaches to the cell membrane through hydrophobic amino acid groups of C7, which become exposed as a consequence of the binding of C7 to the C5b-C6 complex (Figs. 9.8 and 9.9). The membrane-bound C5b-6-7 complex acts as a receptor for C8 and then C9. C8, on binding to the complex, will stabilize the attachment of the complex to the foreign cell membrane through the transmembrane insertion of its alpha and beta chains and attracts C9.

The entire C5b-9 complex is also known as the membrane attack complex (MAC). This designation is due to the fact that on binding to C5b-8, C9 molecules undergo polymerization, forming a transmembrane channel of 100 Å diameter, whose external wall is believed to be hydrophobic, while the interior wall is believed to be hydrophilic. This transmembrane channel will allow the free exchange of ions between the cell and the surrounding medium. Due to the rapid influx of ions into the cell and their association with cytoplasmic proteins, the osmotic pressure rapidly increases inside the cell. This results in an influx of water, swelling of the cell, and, for certain cell types, rupture of the cell membrane and lysis.

Less than 20 seconds is required for lysis of 1 million sheep erythrocytes coated with excess IgG antibody when they are mixed with 1 mL of fresh undiluted human serum as a source of complement. In contrast, many gram-positive bacteria are not susceptible to damage by the MAC as long as their membrane is covered by an intact cell wall. For these organisms, complement-mediated, enhanced phagocytosis is of prime importance.

Normal human cells are somewhat resistant to lysis by human complement. Human cells express substances on their membranes that effectively inhibit the human complement sequence (but not the complement of other species). In addition, phagocytes quickly endocytose and destroy inadvertently deposited membrane-bound complement components.

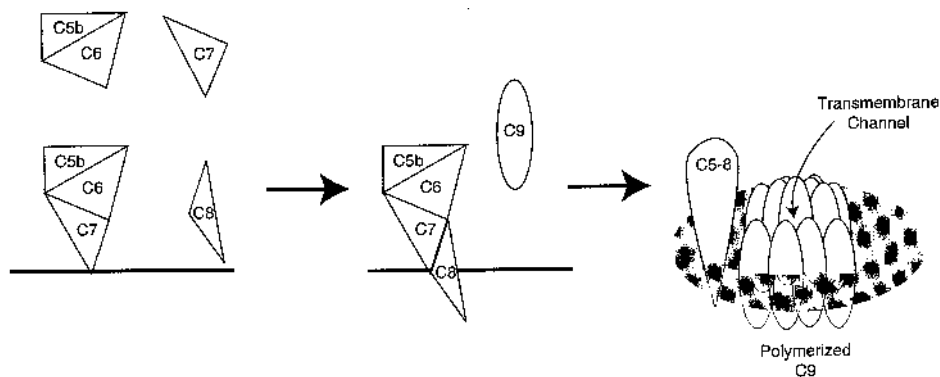

Fig. 9.8 Formation of the “membrane attack complex.”

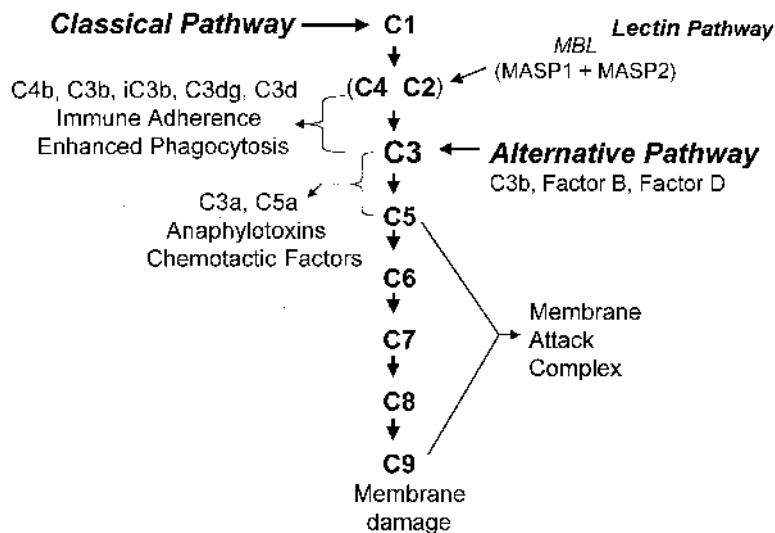

Fig. 9.9 The sequence of complement activation.

One of the important inhibitory substances on most types of host cells is the CR1 receptor glycoprotein, which in binding to activated C3b, blocks C3b function in the complement sequence by causing C3b to be rapidly cleaved to inactivated C3b (iC3b), by a serum enzyme known as Factor I. Obviously, once the phagocyte is actively engulfing the complement-coated particle there is no reason to continue consuming additional complement or risk inadvertently damaging the phagocyte by depositing C3b and/or MAC complexes on its surface. Therefore cell surface CR1 molecules after binding to C3b have two independent functions:

- Enhanced phagocytosis of C3b/C4b coated particles by phagocytes
- Inactivation of any C3b/C4b that may become inadvertently deposited on host cells

Decay-accelerating factor (DAF, CD55) is another important complement-inhibitory substance located on a large variety of host cell membranes. The name of this factor derives from the fact that it can accelerate the dissociation of active C4b2a complexes, turning off their ability to continue activating native C3. In addition, DAF attaches to membrane-bound C4b and C3b and prevents the subsequent interaction of C4b with C2a and of C3b with Factor B, respectively. The role of Factor B in the alternative pathway/amplification loop will be explained later in this chapter. As a consequence, the two types of C3 convertases, C4b2a and C3bBb, will not be formed or will become dissociated, and the rate of additional C3 activation will be limited. Thus the host cell will be spared from complement-mediated membrane damage.

Several other important complement inhibitory substances are also located on almost all host cell surfaces. These substances are protectin (CD59, which restricts formation of the membrane attack complex by binding to C8 and C9) and membrane cofactor protein (CD49, which serves as a cofactor for Factor I enzymatic degradation of C3b).

The existence of these multiple protective mechanisms on host cell membranes explains how a phagocyte approaching a complement-activating immune complex is itself resistant to bystander damage initiated by complement inadvertently deposited on its surface. On the other hand, overexpression of complement inhibitors on malignant breast cancer

cell membranes and malignant endometrial tissues suggests that avoidance of complement-mediated damage allows better survival of these cancers.

6. *Important Biologically Active Fragments: C5a and C3a (Anaphylatoxins and Chemotactic Factors).*

The small complement fragments, C5a and C3a, released into the fluid phase are recognized by neutrophils and cause these phagocytes to migrate in the direction from which these small fragments originated. The term for this chemical attraction is chemotaxis, and its main biological function is to attract phagocytes into a tissue in which a complement-activating antigen-antibody reaction is taking place. Once the PMNs reach the area, by moving towards the highest concentration of chemoattractants, they will bind to the C4b and C3b coated antigenic substance via their CR1 receptors (and to iC3b via their CR3 receptors) and proceed to phagocytize the foreign material.

Besides their role as chemokines, C5a and C3a activate the phagocytic cells that carry C5a and C3a receptors. In the case of neutrophils, such activation leads to the expression of CAMs and facilitates extravascular migration. In the case of circulating basophils and mast cells located in subepithelial and submucosal tissues, C5a and C3a stimulate the release of biologically active mediators such as heparin and vasoactive amines (e.g., histamine). The release of histamine into the tissues results in increased capillary permeability and smooth muscle contraction. Fluid is released into the tissue, causing edema and swelling. There is some evidence that the complement fragments C3a and C5a may also act directly on endothelial cells, causing increased vascular permeability. The end result is very similar to the classical anaphylactic reaction that takes place when IgE antibodies bound to the membranes of mast cells and basophils react with the corresponding antigens (see Chapter 21). For this reason, C3a and C5a are known as anaphylatoxins.

IV. THE ALTERNATIVE COMPLEMENT PATHWAY

Another group of activators of the complement system includes many types of aggregated (hydrophobic) proteins, artificially aggregated immunoglobulins of all classes and subclasses (including IgG4, IgA, and IgE), microbial membranes, and cell walls (see Table 9.1). These activators affect the complement sequence via a mechanism termed the “alternative pathway.” The alternative pathway received this designation because its activation

Table 9.1 Activators of the Alternative Pathway

Bacterial membranes (endotoxic lipopolysaccharides) and viral envelopes
Bacterial and yeast cell walls
Classical pathway (via C3b generation)
Proteases (i.e., via enhanced C3b generation), released by:
Polymorphonuclear leukocytes
Bacteria
Organ failure (pancreatitis)
Damaged tissue (burns, necrosis, trauma)
Fibrinolytic system (plasmin)
Aggregated immunoglobulins (including IgA, IgC4, and IgE)
Virus-transformed host cells (limited effects)

Table 9.2 Alternative Pathway Sequence

-
1. C3 fragmentation (C3 cleavage via classical pathway or via natural turnover, tissue proteases or bacterial proteases)
 2. Deposition of C3b via its labile binding site on a surface which retards its rapid inactivation by Factor I and its cofactors (Factor H or CR1)
 3. Binding of Factor B to C3b leading to C3bB
 4. Activation of the bound B by D leading to C3bBb
 5. C3bBb activation of more C3, leading to formation of C3bnBb (and liberation of more C3a)
 6. Binding of properdin to C3b and stabilization of the association of Bb on C3b
 7. C3bnBb activation of C5 (with liberation of C5a); activation of the terminal sequence (i.e., membrane attack complex)
-

does not absolutely require antibody and can proceed in the absence of C1, C4, and C2, all essential for the classical pathway of complement activation.

Once complement is activated by the alternative pathway, it can induce the activation of C5-C9, a property shared with the classical pathway. It must be stressed that activation of the classical pathway is always associated with activation of the alternative pathway, which, in that case, functions as an “amplification loop” for the classical pathway, generating more deposited C3b. In fact, the classical pathway is a powerful activator of this pathway/loop.

Some of the most significant activators of the alternative pathway are the bacterial membrane lipopolysaccharides characteristic of gram-negative bacteria and the peptidoglycans and teichoic acids from the cell walls of certain gram-positive bacteria. These substances fix to their surfaces a group of several plasma glycoproteins, including C3b, Factor B, Factor D, and properdin, which constitute the initial portion of the alternative pathway sequence. The generation of a “protected” (i.e., nondegraded and stable) bound form of C3b must first occur in order for the alternative complement pathway/amplification loop to be initiated. So the alternative pathway begins with at least one stable C3b covalently bound to the activator/antigen and ends with the cleavage of many additional C3 molecules to form more bound C3b and fluid phase C3a. It is important to understand that as a part of the classical pathway, the amplification loop rapidly utilizes the abundant levels of C3 to completely coat the foreign surface and change its very nature due to the covalent binding of C3b.

A. Sequence of Activation of the Alternative Pathway/Amplification Loop

C3b fragments are formed slowly during normal C3 turnover in blood but faster whenever complement is activated by any of the known pathways. Once formed, C3b has an opportunity to bind via its short-lived labile binding site to the nearest surface. By definition, if the surface is an activator of the alternative pathway, then C3b upon binding to the substance will not be rapidly inactivated by natural inhibitory systems and will survive on the activating surface long enough to bind to serum Factor B forming a C3bB complex.

The interaction between deposited C3b and Factor B is stabilized by Mg^{2+} , which is the only ion required for functional activation of the alternative pathway (Table 9.2). Therefore, tests to discriminate between the two complement activation pathways are often based on the selective chelation of Ca^{2+} (to disrupt C1q, C1r₂, and C1s₂) and the addition of sufficient Mg^{2+} to allow activation of the alternative pathway.

Factor B, within the C3bB complex, is specifically activated by a circulating active plasma enzyme, Factor D, to yield activated C3bBb. C3bBb is an important C3 convertase, which (like C4b2a) activates C3, leading to the formation C3b_nBb, which in turn is capable of activating more C3 as well as C5 and the membrane attack complex. C3b_nBb is stabilized by properdin, a plasma glycoprotein that binds to C3b. Since Factor D has never been isolated in its proenzyme form, it is generally believed to be activated immediately upon leaving the adipose tissues where it is synthesized. The most important point is the tremendous C3 amplification step that occurs in regard to C3b deposition and C3a formation. Every time a new C3b is deposited on the activating substance, there is a chance to form a new C3bBb enzyme capable of activating more C3, causing more C3b deposition. Likewise, amplified C3a and C5a production leads to enhanced neutrophil chemotaxis and edema.

It must be kept in mind that the nature of the surface to which the C3b binds regulates to a great extent C3b survival time. It is the absence of a C3b degradation system on the surface to which C3b is bound that “allows” bound C3b to remain intact, and, consequently, the alternative pathway is activated. If C3b binds to a surface or a molecule that does not support activation of the alternative pathway, then C3b is rapidly inactivated by Factor I acting in concert with several cofactors, such as CR1 and membrane cofactor protein on host cell membranes or Factor H in plasma.

CR1 and/or membrane cofactor protein are found on the surface of most host cells. These cofactors are most effective in binding and regulating C3b, which inadvertently binds to bystander host cells. Factor H appears to be primarily responsible for inactivating fluid phase C3b. However, Factor H binds to C3b molecules accidentally deposited on host sialic acid-rich tissue surfaces and therein serves as a cofactor for Factor I.

B. Biological Significance of the Alternative Complement Pathway

The biological significance of the alternative pathway can be understood if we consider, as an example, an infection with a hypothetical bacterium. Since all normal individuals have low levels of antibody to most bacteria, some limited classical pathway activation occurs. Theoretically, in the presence of large numbers of bacteria, the relatively low levels of specific antibody may be effectively absorbed by antigens present on the proliferating bacteria, allowing uncoated bacteria to escape destruction by the more effective classical pathway.

While optimal classical pathway function is awaiting production of large amounts of specific antibody, C3b molecules (produced via normal C3 turnover) are slowly deposited on the bacteria, initiating the alternative complement sequence. Most bacteria, fungi, and viruses will activate the alternative pathway, but with varying efficiencies. That is, there is a large variability in the avidity and degree of the interaction with this pathway, depending on the species and strain of microorganism. Perhaps aiding the activation of the alternative pathway are the proteolytic enzymes being produced by microorganisms, which directly activate components like C3. If a higher rate of C3 conversion to C3b and C3a occurs near the membrane of the organism, C3b molecules will more rapidly deposit on the foreign surface via their highly reactive C3b-binding site, and the alternative complement pathway will be more effectively initiated. On the other hand, large levels of powerful broad-spectrum proteases located on bacterial surfaces could protect the bacteria from the effects of complement by simply degrading the complement components as they deposit.

In summary, the alternative pathway of complement activation is important, especially during the early phase of the infection, when the concentrations of specific antibody

are very low. After the antibody response is fully developed, the classical and alternative pathways work synergistically, with the alternative pathway functioning as an amplification loop of the classical pathway.

V. ACTIVATION AND INACTIVATION OF C3

When C3b is inadvertently deposited on host cells containing cofactors for Factor I, C3b is rapidly cleaved into small products, which will not activate additional complement components. On the other hand, C3b molecules deposited on antigen are very slowly degraded by Factor I, allowing time for activation of the amplification loop and the MAC. Also, a prolonged presence of iC3b is observed on antigens. While iC3b has irreversibly lost the ability to participate in the complement activation sequence iC3b remains bound to the foreign substance and enhances its phagocytosis.

Therefore, very important reactive sites become exposed when Factor I cleaves bound C3b. The newly exposed regions react with other cell receptors, CR2 and CR3. CR3, which avidly binds to iC3b, is not a ubiquitous complement receptor (like CR1), rather it is expressed on phagocytes and is very important in enhancing phagocytosis. However, even the site that reacts with CR3 is eventually lost as iC3b continues to be degraded by Factor I, which causes the iC3b to break into two major fragments: C3dg and soluble C3c. The C3dg fragment remains bound to the antigen and retains the site that interacts with CR2 (expressed by B cells and on follicular dendritic cells). With time, C3dg is further degraded into C3d by the continued action of plasma or tissue proteases; this fragment remains bound to the antigen and, like C3dg, continues to express the site for interaction with CR2.

VI. OTHER COMPLEMENT-ACTIVATION PATHWAYS

A. Proteolytic Enzymes as Nonspecific Activators of Individual Complement Components

A variety of proteolytic enzymes, some released by microbes at the site of an infection and others released from host cells in areas of inflammation or necrosis, are capable of activating the complement system. For example, polymorphonuclear leukocytes (PMN) leak oxidative products and lysosomal proteolytic enzymes into the extracellular fluids during the phagocytosis process. Oxidation of native C5 increases its susceptibility to conversion by proteases and increases C5a formation. Also, within inflamed or traumatized tissue, damaged host cells release lysosomal proteases during their degeneration. Plasmin, a fibrinolytic enzyme activated during the clotting process, also activates certain complement components. These bacterial and/or host proteases are able to directly cleave and thereby activate C1, C3, and C5. As a consequence of direct cleavage and activation of C3 and C5, biologically active peptides (C3a and C5a) are generated, contributing to a local inflammatory reaction by their direct action and by attracting and activating additional PMNs to the area of tissue damage.

B. The Lectin Pathway of Complement Activation

A newly discovered pathway for activating the second and fourth complement components is the lectin complement pathway, which involves the serum mannan-binding lectin

(MBL), sometimes termed mannose-binding lectin. MBL is an acute phase reactant, meaning that its concentration increases during infection/inflammation. Structurally, MBL is a member of the collectin family (C-type lectin) characterized by having a collagen-like sequence that resembles the structure of C1q and several Ca^{2+} -dependent carbohydrate recognition domains. Mannan, a constituent of the polysaccharide capsules of pathogenic fungi and yeasts (e.g., *Cryptococcus neoformans* and *Candida albicans*) is one of several polysaccharide substances to which human MBL binds via Ca^{2+} -dependent interactions. The activation of the lectin pathway does not require antigen-antibody interactions.

The initiation of the lectin pathway has several features that parallel C1 of the classical complement pathway. The first step in the lectin pathway requires the direct binding of serum mannan-binding lectin to polysaccharides (e.g., mannan) on the surface of microorganisms. In addition to carbohydrate motifs of microorganisms, MBL can bind to glycoproteins on the envelope of certain viruses such as influenza A. MBL inhibits infectivity by three different mechanisms:

1. Direct neutralization and agglutination
2. Deposition of complement through the lectin pathway
3. Opsonization via collectin receptors on phagocytes (receptors for the collagen-like region of MBL and of C1q).

The lectin complement pathway is initiated by microorganism-bound MBL as it associates with two human MBL-associated serine proteases (MASP-1 and -2) that cleave and activate C4 and C2. Similar to the action of C1, the MBL complex generates deposition of C4b2a with subsequent C3b deposition and terminal component activation. It is important to realize that classical pathway activation by immune complexes is much more efficient and powerful than activation by the lectin pathway.

VII. COMPLEMENT RECEPTORS IN HUMAN CELL MEMBRANES

CR1 (complement receptor 1) is a common membrane glycoprotein that can be detected on almost all types of human cells including erythrocytes and cells from various tissues and organs (Table 9.3). CR1 reacts with C3b until C3b becomes cleaved by Factor I. In phagocytic cell membranes, the main biological role of CR1 is to enhance the phagocytosis of those antigenic substances to which C3b is covalently bound. Also, cell surface CR1 molecules protect the cells on which they are expressed from complement-mediated bystander damage. CR1 molecules move on the cell surface to quickly bind any nearby C3b inadvertently deposited on host cells and act as a cofactor for the serum Factor I enzyme, which cleaves C3b to form inactive C3b (iC3b), and thereby prevent further activation of the complement sequence.

CR1 on erythrocytes effectively removes inflammatory complement-coated particles from the fluid phase of the blood. This removal reduces the probability that the inflammatory complement-coated immune complexes will disturb vital organs and tissues. The ubiquitous presence of CR1 not only protects most host cells from inadvertent complement-mediated membrane attack but also sequesters the complement-coated antigens, preventing deeper penetration of these inflammatory complexes into those tissues and vital organs while awaiting the arrival of phagocytes. It is important to understand that the site on C3b, which binds to the CR1 receptor on erythrocytes and other host cells, is lost as iC3b is formed. Therefore, a selective binding to phagocytes increases. Thus erythrocytes provide

Table 9.3 Receptors on Human Peripheral Blood Cells

Complement receptor	Most notably expressed on	Primary binding specificity
CR1 (CD35)	Phagocytes—all types Erythrocytes	C3b, C4b
CR2 (CD21)	Almost all human cell types B lymphocytes Follicular dendritic cells Epithelial cells of the nasopharynx and cervix	C3d, C3dg, and iC3b
CR3 (CD11b/CD18) (Mac-1)	Neutrophils Macrophages—all types Monocytes Follicular dendritic cells	iC3b
CR4 (CD11c/CD18) (p 150,95)	Neutrophils Monocytes Macrophages—all types B lymphocytes—activated natural killer cells	iC3b

an important transporting function by “presenting” complement-coated immune complexes to the various phagocytic systems present in the host (e.g., spleen and liver).

CR2 (complement receptor 2) is another important cell surface glycoprotein that has primary binding specificity for a molecular site on the alpha chain of C3, exposed on C3d, C3dg, and on iC3b. B lymphocytes have both CR2 and CR1 molecules on their surface. Follicular dendritic cells (important in antigen presentation) have CR2, CR3, and CR1 on their surface. Antibody production is greatly enhanced by complement-coated antigens, which stimulate B cells via their CR2 and CR1. In animal models, when C3d was chemically linked to an antigen and added to specific B cells *in vivo*, a thousandfold enhancement of antibody production occurred. The CR2 not only stimulates the B cell directly but also associates with CD19 (another B-cell membrane protein that is known to greatly stimulate antibody production). Of course, the complement synergistic effect on B cells occurs only in the presence of specific antigen (and with helper T cells).

CR3 (Complement Receptor 3) is a cell surface glycoprotein which, via Ca^{2+} -dependent interactions, binds to site(s) exposed predominantly on iC3b; this CR3 receptor is expressed on neutrophils, monocytes/macrophages, certain natural killer (NK) cells, and on a low proportion of B and T lymphocytes.

CR4 (Complement Receptor 4) is expressed mainly in neutrophils, monocytes, and tissue macrophages. Like CR3, it binds to iC3b that remains irreversibly bound to the antigenic surface.

In addition to the CR1, CR2, CR3, and CR4 glycoproteins, certain host cells also have receptors for C3a and C5a. For example, neutrophils, mast cells, basophils, and certain lymphocyte populations have receptors for C3a and C5a. The binding of C3a and/or C5a to these receptors stimulates several cellular functions, such as release of active mediators, upregulation of CR1 and CR2 receptors, leading to enhanced phagocytosis, upregulation of CAMs that contributes to their extravascular migration, etc.

Besides the role in B-cell activation mentioned above, complement receptors mediate the stimulation of many cell types that express them. Antigens coated with antibody and

complement (i.e., C4b, C3b, iC3b, and C3dg) adhere strongly to macrophages, neutrophils, and lymphocytes (B lymphocytes and activated T lymphocytes) and cause them to release many biologically active factors, including a variety of soluble mediators (such as cytokines, interleukins, prostaglandins, and leukotrienes), which influence immune responses and cause inflammation.

VIII. PATHOLOGICAL SITUATIONS ASSOCIATED WITH EXAGGERATED COMPLEMENT ACTIVATION

Once the complement cascade is activated, the complement components are under very tight regulation and control. An important aspect of this regulation is the constant presence of plasma inhibitors for the activated complement components. For each type of activated fragment there is at least one inhibitor or inhibitory mechanism. The tight regulation and rapid neutralization of the active fragments limit their range of action.

In the case of C3a and C5a, there are several serum inhibitors, one of which is believed to be a serum protease that removes the carboxy-terminal arginine residue of the peptides and limits their ability to stimulate PMNs, leukocytes, basophils, and mast cells.

The inhibitor for C3b, as described in detail in previous sections of this chapter, is Factor I, which only works in conjunction with appropriate cofactors (Factor H, CR1, or MCP). C4b is also inhibited by Factor I and a cofactor termed C4-binding protein (C4BP). Factor I cleaves C4b and C3b and prevents their capacity to be involved in binding downstream components of the complement pathways.

The serum inhibitor for C1 is a serum protein, termed C1 inhibitor (C1-INH), which tends to stabilize the nonactivated C1 macromolecular complex, preventing spontaneous activation. More importantly, C1-INH has the ability to bind irreversibly to the activated form of C1r and C1s, at or near their active site. If a deficiency of any of these complement inhibitors or cofactors exists within an individual, an imbalance in complement regulation occurs and disease may ensue.

A. Hereditary Angioedema

This is a rare genetic disorder due to a genetically inherited C1-INH deficiency, of which two main variants are known. In the most common, the genetic inheritance of a silent gene results in a very low level of C1-INH. The second variant is characterized by normal levels of C1-INH protein, but 75% of the molecules are dysfunctional, i.e., will not inhibit activated C1r or C1s because of an aberrant amino acid substitution. While the lack of C1-INH can be easily detected by a quantitative assay, the synthesis of dysfunctional C1-INH can only be revealed by a combination of quantitative and functional tests. An acquired form of C1 INH deficiency can be detected in certain malignant diseases. Individuals with congenital C1-INH deficiency may present clinically with a disease known as hereditary angioedema, characterized by spontaneous swelling of the face, neck, genitalia, and extremities, often associated with abdominal cramps and vomiting. The disease can be life threatening if the airway is compromised by laryngeal edema, and tracheotomy may be a life-saving measure. This anaphylactoid reaction is due not to IgE-mediated reactions, but rather to spontaneous uncontrolled activation of the complement system by C1. The reaction is usually self-limiting and will cease after all C4 and C2 have been consumed. However, in vivo there is not a substantial consumption of the remaining complement sequence

(C3-9) due to the action of several other regulatory mechanisms, which are especially effective against the unbound (free) forms of C4b and C3b (i.e., C4b and C3b are not bound to any antigen).

Attacks in patients with C1-INH deficiency occur after surgical trauma, particularly after dental surgery or after severe stress. It is notable that activated Hageman factor, kallikrein, and plasmin are also controlled (in part) by binding to C1-INH. Such binding further depletes the available C1-INH in deficient patients. In the absence of sufficient C1-INH, spontaneous activation of a limited number of C1 molecules will gradually accentuate the depletion of C1-INH to the point that activated unbound C1 is in the circulation. Meanwhile the other blood enzymes controlled by C1-INH become less restricted. The continued presence of activated, uninhibited fluid phase C1s will cause spontaneous and continuous activation of the next two components in the sequence, C4 and C2, until their complete consumption. Low C4 levels are considered diagnostic of C1-INH deficiency, and they remain low even when the patients are not experiencing an attack, probably due to a continuously exaggerated C4 catabolism by activated C1. The angioedema-producing peptide has been suggested to be a fragment of C2 (C2a) liberated by the action of C1 on C2 followed by the cleavage of C2 by plasmin. This theory has developed because it is generally accepted that serum C3 levels are not significantly altered during attacks of angioedema. However, *in vitro* evidence has shown that if appropriate levels of antibody to human C1-INH are added to whole human serum, 100% C3 conversion occurs. This complete C3 conversion can only be achieved when the function of C1-INH is blocked. Thus, the participation of low levels of C3a in angioedema cannot be ruled out when local C1-INH levels approach zero. As mentioned previously, C1 INH also controls several other blood system enzymes. Therefore during attacks of HAE, when C1 INH is being consumed, activation of the kallikrein-kinin system fibrinolysis occurs and this may also contribute to the edema scenario.

B. Paroxysmal Nocturnal Hemoglobinuria

Paroxysmal nocturnal hemoglobinuria (PNH) is an acquired disorder on the surface of selected hemopoietic stem cell lines and their erythrocyte progeny. The patients develop hemolytic anemia associated with the intermittent passage of dark urine (due to hemoglobinuria), which usually is more accentuated at night. The spontaneous hemolysis is due to an increased susceptibility of the abnormal population of erythrocytes to complement-mediated lysis. The erythrocytes are not responsible for the activation of the complement system; rather, they are lysed as innocent bystanders when complement is activated.

Detailed studies of the circulating erythrocytes in PNH patients have demonstrated the existence of three erythrocyte subpopulations with varying degrees of sensitivity to complement. The reason for the existence of these subpopulations was elucidated when the molecular basis of PNH was established. Several membrane proteins are attached to cell membranes through phosphatidylinositol "anchors." The red cell membrane contains two such proteins: the decay-accelerating factor (DAF), which prevents or disrupts the formation of C4b2a and C3bBb, and protectin (CD59), which prevents the proper assembly of the membrane attack complex by binding to C8 and or C9. These two proteins (together with CR1 and MCP) have an important protective role for "bystander" erythrocytes by controlling the rate of complement activation on the erythrocyte membrane. The deficiency of the phosphatidylinositol anchoring system is reflected by deficiencies of DAF and protectin. Type I PNH red cells have normal or slightly lowered levels of these two proteins

and usually show normal resistance to complement-mediated hemolysis; type III PNH red cells lack both proteins and are very sensitive to hemolysis; type II PNH red cells lack DAF and have intermediate sensitivity to hemolysis.

Phosphatidylinositol is involved in the membrane binding of other proteins, such as the predominant type of Fc receptor in the neutrophil (Fc γ RIII). Therefore, in these patients neutrophils, platelets, and other cells are deficient both in DAF and in Fc receptors. These deficiencies seem to be the basis of other abnormalities seen in PNH patients: thrombotic complications, attributed to increased complement-induced platelet aggregation, and bacterial infections and persistence of immune complexes in the circulation, both attributed to a lack of Fc-mediated phagocytosis.

C. Pulmonary Vascular Leukostasis as a Side Effect of Hemodialysis

Passage of heparinized blood over a variety of filter materials (i.e., artificial hemodialysis membranes and nylon fiber substances used in the heart-lung machine) causes varying degrees of complement activation. The classical pathway may be activated by interfacially (solid-liquid or air-liquid) aggregated immunoglobulins or by direct binding of C1q. Also, membrane (filter)-bound C3b (via C3 turnover and C3b deposition) mediates activation of the alternative pathway. Rapid generation of C5a causes a transient leukopenia with a short-term, reversible accumulation and aggregation of granulocytes in the blood capillaries of the lungs, where they release superoxide that damages the tissues surrounding the areas of PMN accumulation. As a result, repeated hemodialyses may lead to chronic fibrosis of the lung.

D. Pancreatitis, Severe Trauma, and Pulmonary Distress Syndrome

Any mechanism that causes a rapid release of high levels of C5a into the blood may cause massive PMN aggregation and consequent pulmonary distress syndrome. For example, when large amounts of proteases are released into the blood (i.e., pancreatitis or severe tissue trauma), pulmonary distress syndrome and sometimes temporary blindness occur due to blockage of small blood vessels with aggregated granulocytes. Similarly, in myocardial infarction, blockage of critical heart capillaries with leukocyte aggregates may extend cardiac damage. Steroids that prevent and reverse leukocyte aggregation have been used to retard such damage in experimental animals. Cardiolipin released from the damaged heart tissues may directly activate C1 and therein exaggerate the complement activation being induced by the tissue proteases.

E. Septic Shock and C1-INH Depletion

The classical complement pathway, the contact activation system, and the coagulation cascade are activated during severe sepsis and septic shock. Activation of these cascades in severe sepsis contributes to the development of multiple organ failure (which may or may not be reversible), associated with high mortality rates. This is, at least in part, a consequence of the depletion of C1-INH, as a consequence of the activation of these systems and of degradation by bacterial and host proteases (e.g., leukocyte elastase). Depletion of C1-INH to less than about 10% of its normal serum level allows many bacterial substances and charged host cellular substances to directly activate C1 (which otherwise would be prevented from activating complement by C1-INH). In experimental animals, C1-INH substitution reduces the mortality by severe sepsis or septic shock.

IX. COMPLEMENT LEVELS IN DISEASE

The complement proteins have some of the highest turnover rates of any of the plasma components. At any one time, the level of a complement component is a direct function of its catabolic and synthetic rates. There are many factors that cause the increased production of complement components by the liver and from cells present at local sites of inflammation. In tissue culture models, the addition of cytokines, such as interleukin-1 α , interferon- γ , and especially tumor necrosis factor- α , upregulate C3 synthesis. Interleukin-1 α , interleukin-6, and especially interferon- γ upregulate factor B synthesis. Interestingly, tumor necrosis factor- α and interferon- γ concomitantly increase DAF expression on host cells (e.g., vascular endothelial cells) in order to protect the host from bystander complement attack, especially in areas where the membrane attack complex is inadvertently being deposited (e.g., on the vascular endothelium) during localized inflammation.

The catabolic rates of the complement system are primarily a function of the extent of complement activation by all the pathways involved. Therefore, the levels of complement proteins are influenced by the levels of complement activators (i.e., immune complexes), the class and subclass of immunoglobulin within the immune complexes, the release of direct complement-activating bacterial products, and, in certain chronic inflammatory diseases, the presence of autoantibody to complement components (immunoconglutinins).

The synthetic rates of complement glycoproteins vary widely in disease states and during the course of a given disease. In the end, the level of a complement component is a function of its metabolic rate (synthesis versus catabolism) and the type and course of the inflammatory reaction. Elevated levels of a given complement component in a disease state probably means that there is both a rapid synthetic and catabolic rate. Lower overall complement levels indicate that consumption is greater than synthesis at that particular time, usually in association with acute inflammation or an exacerbation of a chronic inflammatory process. Severe complement depletion, on the other hand, is usually associated with impaired hepatic synthesis (e.g., as in liver failure).

A. Hypocomplementemia and Clearance of Immune Complexes

The development of immune complex diseases is believed to be a consequence of the inability to properly eliminate immune complexes from the kidney and/or from the basement membrane of dermal tissues. As previously mentioned in our discussion of the classical pathway, activation of a normal complement system by immune complexes will eventually lead to partial dissolution of the immune complex. This phenomenon is due to the deposition of large complement fragments such as C4b and C3b on the antigen and on the Fab region of the antibody, which interferes with the antigen-antibody binding reaction. If a deficiency in the early complement components exists, there will likely be a corresponding defect in the production and binding of C4b and C3b to the immune complex. As a result, the rate of formation of new immune complexes surpasses the inefficient rate of immune complex dissolution and/or phagocytic clearance, and the generation of pro-inflammatory complement fragments will be possible for a longer period of time. The reasons for the lower levels of early complement components (i.e., C1q, C4, and/or C2) are multiple and include not only genetic factors but also a variety of metabolic control mechanisms mentioned above.

In patients with systemic lupus erythematosus (SLE), a reduction in the levels of CR1 on erythrocytes has been reported. As previously discussed, the binding of complement-coated immune complexes to erythrocytes is an important physiological mechanism of im-

immune complex removal from the circulation. Small- to medium-sized immune complexes are not taken up as efficiently by CR1 and tend to persist longer in circulation. However, when the number of CR1 receptors on erythrocyte membranes is decreased, even large-sized (complement-coated) immune complexes may persist for longer periods in circulation and may have a greater opportunity to be deposited in organs and tissues thereby causing inflammation. The depleted number of CR1 per erythrocyte may be due in part to the overwhelming utilization of the erythrocyte CR1 in SLE and subsequent CR1 catabolism as the complement-coated immune complexes are presented to phagocytic cells in the liver and spleen.

B. Complement Deficiencies

Deficiencies of several of the components of the complement system are associated with two types of clinical situations: chronic bacterial infections, caused by capsulated organisms such as *Neisseria* species, and autoimmune disease, mimicking systemic lupus erythematosus (see Chapter 29).

X. MICROBIAL ANTICOMPLEMENTARY MECHANISMS

In general, complement-mediated phagocytosis is the most effective mechanism for elimination of infectious microorganisms. However, pathogenic organisms have evolved several mechanisms to circumvent either effective complement activation or effective complement deposition on their outer surface. These evasion strategies are most efficient during the early stages of an infection, when the levels of specific antibody are low.

In some cases, microorganisms (e.g., *Candida*) have on their surface a structural protein that mimics the protective effect of DAF or other complement regulators. Interestingly, HIV appears to adsorb Factor H from serum and also acquires membrane DAF upon leaving the infected host cell. In these situations, a reduced deposition of complement components on the surface of the microorganism leads to a less effective neutralization/elimination. However, the role of the complement system in immunity to HIV has not been established.

Other less sophisticated complement-restrictive mechanisms that different microorganisms have acquired include the shedding of MAC-coated pili, destruction of C3b by proteases on the bacterial surface, and protection of the cytoplasmic membrane from the dissolving effect of the MAC by slime layers, peptidoglycan layers, polysaccharide capsules, etc. In the presence of sufficient antibody levels, these protective mechanisms are usually overridden, and the microorganisms are properly phagocytosed, although some bacteria have acquired antiphagocytic capsules that further complicate the job of the immune system (see Chapter 14).

SELF-EVALUATION

Questions

Choose the one *best* answer.

- 9.1 Which of the following is a function of the complement system?
 - A. Agglutination of incompatible red cells
 - B. Antibody-dependent cell-mediated cytotoxicity (ADCC)

- C. Attraction of lymphocytes to inflammation sites
 - D. Cross-linking polysaccharide antigens
 - E. Enhanced phagocytosis of infectious agents
- 9.2 Which of the following is observed *only* when complement is activated by the classical complement pathway?
- A. Activation of C1s
 - B. Activation of C2
 - C. Activation of the membrane attack complex
 - D. Breakdown of C3 into C3a and C3b
 - E. Generation of anaphylatoxins
- 9.3 The mechanism leading to red cell lysis in severe cases of paroxysmal nocturnal hemoglobinuria involves:
- A. Complement activation induced by anti-red cell antibodies
 - B. Deficiency of Factor I, limiting the ability to inactivate C3b bound to erythrocyte CR1 receptors
 - C. Opsonization and phagocytosis of red cells
 - D. Shedding of DAF into the circulation
 - E. Unchecked deposition of C3b on the red cell followed by activation of C5 to C9
- 9.4 Histamine is released from mast cells stimulated by:
- A. C1q
 - B. C2a
 - C. C4b
 - D. C5a
 - E. C3b
- 9.5 The amplification loop can be efficiently activated by:
- A. Antigen-antibody complexes
 - B. C5-9
 - C. Chemically cross-linked Fc fragments of IgG
 - D. Ca^{2+}
 - E. Properdin
- 9.6 CR1 receptors on phagocytic cells have the greatest affinity for:
- A. C3a
 - B. C3b
 - C. C3d
 - D. C3dg
 - E. iC3b
- 9.7 Which of the following is a major characteristic of hereditary angioneurotic edema?
- A. A quantitative or functional deficiency of C1-INH
 - B. Induction by inhalation of complement-activating compounds
 - C. Normal levels of C2 and C4
 - D. Spontaneous breakdown of C3 and C5
 - E. Very high levels of IgE
- 9.8 Neutrophil aggregation as a consequence of hemodialysis is believed to result from:
- A. Direct activation of the alternative pathway by trace levels of heparin
 - B. Excessive amounts of calcium

- C. Generation of C5a
 - D. Production of C3b
 - E. Retention of antigen-antibody complexes in the dialysis membrane and activation of the classical pathway
- 9.9 A deficiency of erythrocyte CR1 receptors is associated with:
- A. Accumulation of C3dg and C3d in circulation
 - B. Increased deposition of antigen-antibody complexes in tissues
 - C. Increased incidence of angioneurotic edema
 - D. Paroxysmal nocturnal hemoglobinuria
 - E. Release of massive amounts of histamine
- 9.10 The “membrane attack complex” is formed by:
- A. C3bBb
 - B. C4b2a
 - C. C4b2a3bn
 - D. C4bC3b
 - E. C56789

Answers

- 9.1 (E) Complement and IgG antibodies are the major opsonins that enhance the uptake of infectious agents by phagocytic cells. The chemotactic effects of C5a and C3a are limited to phagocytic cells, particularly granulocytes.
- 9.2 (A) C1s is only activated through the classical pathway. Both the lectin pathway and the classical pathway activate C4 and C2.
- 9.3 (E) In paroxysmal nocturnal hemoglobinuria the red cells lack DAF and protectin (CD59). Therefore, the deposition of C3b on the red cells (as a consequence of complement activation by factors totally unrelated to the red cells) can result in red cell lysis because the progression of the activation pathway from C3 to C9 can proceed unimpaired.
- 9.4 (D) C3a and C5a (and perhaps C2b) are the biologically active complement components able to trigger the release of histamine from mast cells (anaphylatoxins).
- 9.5 (A) Immune complexes, by activating the complement system by the classical pathway, will also activate the alternative pathway (amplification loop). Properdin is a stabilizer of the C3bBb complex but by itself cannot activate the alternative pathway. Mg^{2+} is required for the activation of the alternative pathway (classical pathway activation, in contrast requires both Ca^{2+} and Mg^{2+}). The Fc fragment of IgG is involved in activation of the classical pathway.
- 9.6 (B)
- 9.7 (A) The symptoms of hereditary angioneurotic edema are believed to be caused by C2 fragments. Limited breakdown of C3, leading to the generation of C3a, may take place, but only in response to the activation of C4 and C2. C4 and C2 levels are usually low since they are consumed as a consequence of the excessive activity of C1, while C3 levels tend to be less affected because the activated C4b and C2a are unbound (not stabilized by binding to an antigen).

- 9.8 (C) Cellophane membranes used for hemodialysis are able to activate the alternative pathway, leading to the generation of C5a, which causes neutrophil aggregation.
- 9.9 (B) Soluble antigen-antibody complexes with attached C3b can be removed from the circulation through adsorption to the CR1 receptor on red cells. If those receptors are reduced in numbers, soluble antigen-antibody complexes will persist in circulation for longer periods and will more likely be trapped eventually in tissues and cause inflammation.
- 9.10 (E)

REFERENCES

- Chen, C.-H., Boackle, R. J. A newly discovered function for C1 inhibitor, removal of the entire C1q₂S₂ complex from immobilized human IgG subclasses. *Clin. Immunol.* 87:68, 1998.
- Da Costa, X. J., Brockman, M. A., Alicot, E., et al. Humoral response to herpes simplex virus is complement-dependent. *Proc. Natl. Acad. Sci. USA* 96:12708, 1999.
- Discipio, R. G., Daffern, P. J., Kawahara M., et al. Cleavage of human complement component C5 by cysteine proteinases from *Porphyromonas (Bacteroides) gingivalis*. Prior oxidation of C5 augments proteinase digestion of C5. *Immunology* 87:660, 1996.
- Kirschfink, M., Nurnberger, W. C1 inhibitor in anti-inflammatory therapy: from animal experiment to clinical application. *Mol. Immunol.* 36:225, 1999.
- Kishore, U., Reid, K. B., Modular organization of proteins containing C1q-like globular domain. *Immunopharmacology* 42:15, 1999.
- Mason, J. C., Yarwood, H., Sugars, K., et al. Induction of decay-accelerating factor by cytokines or the membrane-attack complex protects vascular endothelial cells against complement deposition. *Blood* 94:1673, 1999.
- Nielsen, E. W., Johansen, H. T., Hogasen, K., et al. Activation of the complement, coagulation, fibrinolytic and kallikrein-kinin systems during attacks of hereditary angioedema. *Scand. J. Immunol.* 44:185, 1996.
- Pasch, M. C., Van Den Bosch, N. H., Daha, M. R., et al. Synthesis of complement components C3 and factor B in human keratinocytes is differentially regulated by cytokines. *Invest. Dermatol.* 114:78, 2000.
- Tomita, M. Biochemical background of paroxysmal nocturnal hemoglobinuria. *Biochim. Biophys. Acta* 1455:286, 1999.
- Volanakis, J. E., and Frank, M. M., eds. The Human Complement System in Health and Disease. New York: Marcel Dekker, 1998.
- Zeerleder, S., Caliezi, C., Redondo, M., et al. Activation of plasma cascade systems in sepsis: role of C1 inhibitor. *Med. Wochenschr.* 129:1410, 1999.
- Zhang, Y., Suankratay, C., Zhang, X. H., Lint, T. F., Gewurz, H. Lysis via the lectin pathway of complement activation: minireview and lectin pathway enhancement of endotoxin-initiated hemolysis. *Immunopharmacology* 42:81, 1999.

10

Lymphocyte Ontogeny and Membrane Markers

Virginia M. Litwin and Jean-Michel Goust

I. INTRODUCTION

A. Stem Cell Differentiation

All blood cell types, including lymphocytes, are derived from hematopoietic stem cells (HSC). By definition a stem cell must be capable of both self-renewal and differentiation. Self-renewal is the ability to give rise to at least two daughter cells at the same stage of development as the parent. Differentiation is the orderly sequence of events that leads to cell maturation, resulting in the progressive loss of self-renewal capacity and an increasingly restricted lineage potential. This is associated with the silencing or activation of given genes such as cytokine receptors, signal transduction molecules, or transcription factors. Hematopoietic stem cells give rise to a common lymphoid progenitor cell, which expresses upregulated interleukin-7 (IL-7) receptor and a variety of membrane markers (CD34 is the most characteristic marker of the common lymphoid progenitor cell). This progenitor cell gives rise to all lymphoid lineages—T lymphocytes, B lymphocytes, natural killer (NK) cells, and dendritic cells (DC).

B. Cytokines in Lymphocyte Ontogeny

The self-renewal capacity of the stem cells is dependent on growth factors such as GM-CSF, G-CSF, IL-3, and IL-5. Expression of CD132, the IL-2R common γ (γ_c) subunit

(shared by the membrane bound receptors for IL-2, IL-4, IL-7, IL-9, and IL-15, as discussed in Chapter 11), is a phenotypic marker for the common lymphoid progenitor cells. Progenitor cells that express both γc and the IL-7 receptor (IL-7R) have lost the capacity for myeloid differentiation and are restricted to the lymphoid lineage.

These receptors, however, are not just differentiation markers; they are required for lymphoid cell differentiation. This was made clear by the study of patients with γc -gene deficiency (see Chapter 11). These patients had defects in T-, B-, and NK-cell development and suffered from X-linked severe combined immunodeficiency.

The lack of differentiation of lymphocytes in patients with γc -gene deficiency is explained by the fact that IL-7, produced by bone marrow stromal cells and by thymic epithelial cells, delivers a signal needed for the differentiation of pre-B cells and for the proliferation of double negative thymocytes. Not surprisingly, disruption of the IL-7R eliminates all lymphoid development. NK-cell development is also affected because it is critically dependent on IL-15, one of the many cytokines that shares common structural units with the IL-2 receptor, in this case both the common γc subunit and the β chain (CD122).

C. Regulation of Ontogeny and Immune Responses by Opposing Signaling Events

A balance of activating and inhibitory signals mediated by lymphocyte membrane markers controls the immune system. Signals transmitted by the ligation of antigen receptors on T and B cells may induce cellular migration, proliferation, differentiation, anergy, or apoptosis. Several factors that influence the outcome include antigen concentration, binding avidity, duration of antigen recognition, association with costimulatory molecules or cytokines, and the developmental stage of the lymphocyte. In addition to the antigen receptors, other lymphocyte membrane markers also serve as receptors capable of delivering activation or inhibition signals to the cell. While the presence of inhibitory receptors was first recognized in NK cells and subsets of T cells (see Sec. VII.B), inhibitory receptors are also found on subsets of B cells, monocytes, macrophages, and dendritic cells.

D. Lymphoid Development During Fetal Life

Lymphocytes start to differentiate into separate lineages early in fetal life (Fig. 10.1). In humans, the embryonic yolk sac of the developing embryo is the first hematopoietic structure that forms stem cells, which develop into leukocytes, erythrocytes, and thrombocytes. The fetal liver receives stem cells from the yolk sac at the 6th week of gestation and begins hematopoietic activity at that point in time, reflected by the finding of NK cells in the fetal liver prior to formation of the thymic rudiment. In the 12th week a minor contribution is made to the production of blood cells by the spleen.

At 20 weeks of gestation, the thymus, lymph node, and bone marrow begin hematopoietic activity. The bone marrow becomes the sole hematopoietic center after 38 weeks. At that time, differentiated T and B lymphocytes are present in the circulation. In the adult, T cells represent 55–84% of the circulating peripheral blood lymphocytes, B cells 6–25%, and NK cells 5–27%.

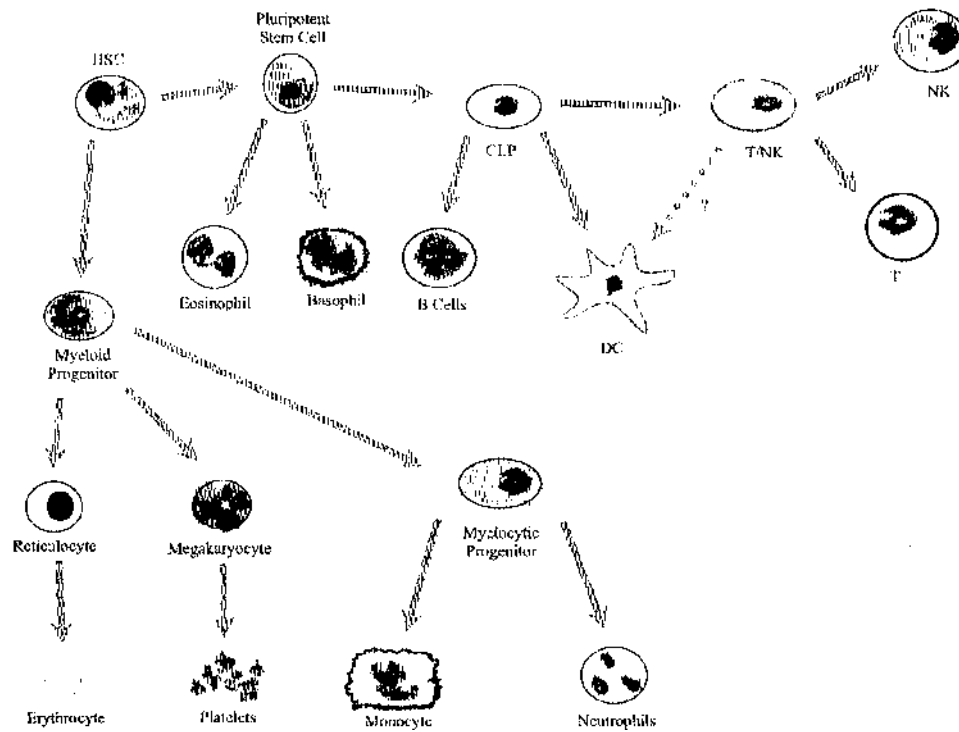

Fig. 10.1 Hypothetical model of hematopoietic stem cell differentiation. Multipotential hematopoietic stem cells (HSC) give rise to more restricted progenitor cells with self-renewal capacity. The common lymphoid progenitor cells (CLP) give rise to T, B, NK, and DC lymphocytes. Another group of hematopoietic cells, for which the immediate progenitor is a more differentiated myeloid progenitor (MP), includes erythrocytes, megakaryocytes, and platelets as well as the granulocyte, monocyte/macrophage series. (The assistance of Christopher J. Lada in the preparation of this figure is gratefully acknowledged.)

II. APPROACHES TO THE STUDY OF LYMPHOCYTE DIVERSITY AND ONTOGENY

A. Lymphocyte Membrane Markers

Lymphocyte type, maturation stage, and activation state are now routinely identified by the presence or absence of certain markers expressed on the cell membrane. Approximately half of the membrane markers on leukocytes are members of the immunoglobulin gene superfamily (see Chapter 5). The functions of the proteins included in this superfamily are diverse: immune recognition, embryonic development, cell adhesion, signal transduction, and receptors for growth factors. The notable feature of these proteins is the presence of one or more immunoglobulin-like domains. These domains—approximately 100 amino acids in length—are characterized by a common fold formed between two antiparallel β sheets stabilized by a disulfide bond. The result is a conserved structural platform that allows for the display of unique determinants required for specific ligand-binding.

The identification of cell surface markers is accomplished through the use of monoclonal antibodies. The development of this innovative technology resulted in a Nobel Prize

and has been invaluable in the study of immunology as well as many other areas of biology.

1. The Production of Monoclonal Antibodies

In the 1970s Kohler and Milstein conceived the groundbreaking procedure for the production of monoclonal antibodies. They fused malignant plasma cells with antibody producing B lymphocytes. This fusion produced hybrid cells or hybridomas that could proliferate like transformed cells and produce the specific antibody from the parental B cell. The process, summarized in Fig. 10.2, involves two cell populations and three major steps: fusion, selection, and screening.

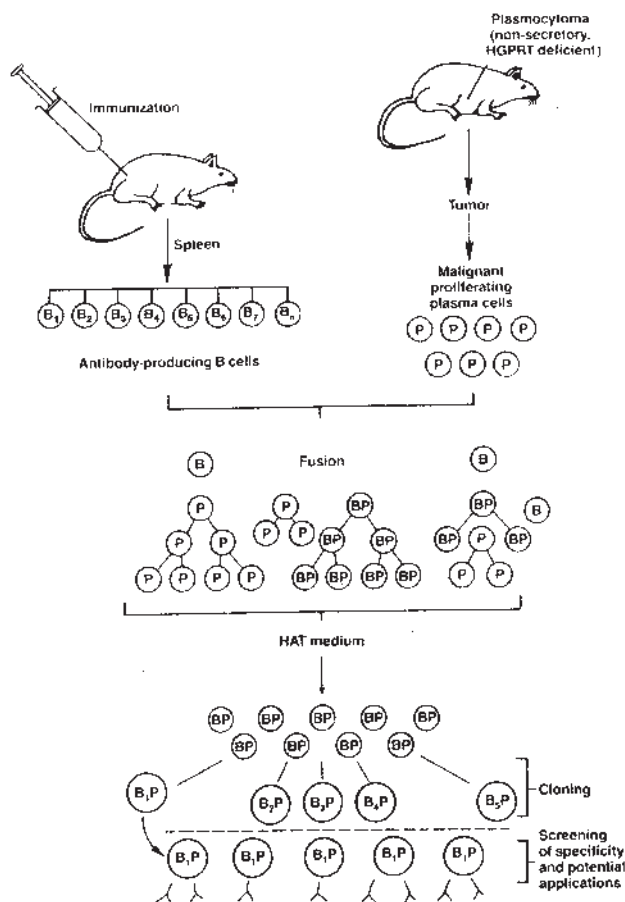

Fig. 10.2 Schematic representation of the major steps involved in hybridoma production. First, antibody-producing lymphocytes are fused with nonsecretory malignant plasma cells, deficient in hypoxanthine guanine phosphoribosyl transferase (HGPRT). Nonfused lymphocytes will not proliferate, and nonfused plasma cells will die in a hypoxanthine-rich medium (HAT). The HGPRT-deficient plasma cells cannot detoxify hypoxanthine, while the hybrid cells have HGPRT provided by the antibody-producing B lymphocytes. The surviving hybrids are cloned by limiting dilution, and the resulting clones are tested for the specificity and potential value of the antibodies produced.

Fusion involves two cell types:

- A malignant plasma cell line of mouse or rat origin, unable to secrete immunoglobulins and deficient in a critical enzyme that allows cells to synthesize purines from hypoxanthine (hypoxanthine guanine phosphoribosyl transferase, HGPRT).
- A suspension of spleen cells obtained from a normal mouse or rat harvested at the peak of an induced immune response. The spleen cell suspension will contain a large number of B-lymphocyte clones, each clone producing a single antibody against one given epitope.

The two cell populations are fused, usually by incubation in the presence of polyethylene glycol. The fused B lymphocyte will provide the resulting hybridoma with the capacity to produce a specific antibody and the capacity to produce HGPRT; the fused plasmocytoma cell will provide the hybridoma with the capacity to proliferate indefinitely. In contrast, nonfused B cells will die after a few rounds of replication. To eliminate nonfused, HGPRT-deficient, malignant plasmocytoma cells, the mixture of fused and nonfused cells is grown in a medium (HAT) containing hypoxanthine and aminopterin (which blocks the remaining intracellular pathways for the synthesis of purines). Under those conditions, only fused cells able to utilize hypoxanthine for the synthesis of purines will survive.

A lengthy screening process follows, the aim of which is to select from the large number of hybrids produced by fusion those clones that produce antibody against antigens of interest. This "cloning" process involves the preparation of limiting dilutions or cell sorting of the hybridomas. Single cells are seeded into individual receptacles containing tissue culture medium and allowed to grow into clones producing antibody of a single specificity (monoclonal antibody). Monoclonal antibodies generated in this process have a wide range of uses, including basic research, diagnostic purposes, and therapeutic protocols.

2. *CD Nomenclature*

Hundreds of monoclonal antibodies identifying different membrane markers on lymphocytes and other cell types have been generated. These cell surface antigens are complex molecules expressing many different epitopes. Accordingly, monoclonal antibodies raised in different laboratories often recognize slightly different parts of the same molecule. Historically each laboratory would identify a molecule by a unique name, often the name of the monoclonal antibody recognizing the molecule or antigen. Soon the field became rather complicated, as each cell surface molecule was known in the literature by several different names. As a consequence, the World Health Organization (WHO) sponsored workshops in order to establish a standardized nomenclature for the molecules found on the surface of leukocytes.

The participants of the workshops, held periodically, evaluate newly developed monoclonal antibodies, verify which cellular antigen they recognize, and assign uniform designations to these molecules. A given cellular antigen recognized by novel monoclonal antibodies is designated by the initials CD, for clusters of differentiation (a designation that recognizes the fact that each marker has multiple antigenic determinants), followed by a number. The numerical designations are assigned based partly on the order of discovery, and partly on the ontogenic order of appearance. For instance, the monoclonal antibody recognizing what, at the time, was considered ontogenetically as the most primitive T lym-

phocyte membrane marker, was designated as CD1, and the T lymphocytes expressing it are known as CD1⁺.

B. Genetic Approaches

Technical progress in molecular genetics has resulted in the cloning and sequencing of immunoglobulin genes, TcR genes, as well as genes coding for other cellular antigens. Often the genes are cloned and sequenced before the function of the molecule they code is defined. The role of various cellular antigens and cytokines in the development of an immune response and lymphocyte ontogeny has been greatly enhanced by the genetic manipulation of experimental animals. Transgenic animals express the genes of another species (most commonly human genes are inserted into the germline of mice), whereas “knockout” mice have a specific gene disrupted or deleted. The cross breeding of transgenic and knockout mice has generated animals that express only the human form of a given gene. Sophisticated experimental systems have been developed using these animals to dissect the complexities of the immune system such as ontogeny, education, and tolerance.

III. MAJOR STEPS IN THE DIFFERENTIATION OF T AND B LYMPHOCYTES

The differentiation of T and B lymphocytes proceeds in major three stages.

A. Gene Rearrangement

The tremendous diversity and specificity of the immune system is mediated by antigen specific receptors expressed on the surface of the T and B cells, the T-cell receptor (TcR), and surface-bound immunoglobulins, which constitute the B-cell receptor (BcR), respectively. Diversity is accomplished by the combining of rearranged genes encoding variable (V), diversity (D), joining (J), and constant (C) regions (see Chapter 7).

B. Association with Co-receptors

The TcR and BcR are members of the immunoglobulin gene superfamily, display similar macromolecular structures, and associate with homologous co-receptors. The antigen-specific binding site of each receptor resides within its immunoglobulin-like domains. The short intracytoplasmic regions of these antigen recognition receptors are not capable signal transduction. The TcR and BcR associate in the cytoplasm with other molecules, forming receptor complexes, which are then transported to the cell membrane. The co-receptor molecules lend signal transduction capacity to the mature receptor complex. Events that precipitate gene rearrangement, synthesis of antigen receptors, and co-receptor association proceed in a sequential manner and are dependent on activating signals received from the environment.

C. Selection of the Right Receptors

Because of its random nature, the rearrangements of receptor genes, which become expressed on the surface of differentiating lymphocytes, may include autoreactive receptors.

A selection process exists to eliminate autoreactive lymphocytes, which would react against self-antigens.

IV. B LYMPHOCYTE ONTOGENY

B lymphocytes are identified by the presence of surface immunoglobulin (sIg). After antigenic stimulation, B cells differentiate into plasma cells that secrete large quantities of immunoglobulins. Within a single cell or a clone of identical cells, the antibody-binding sites of membrane and secreted immunoglobulins are identical. Many steps are involved in the genetic control of immunoglobulin synthesis and the generation of binding site diversity (Fig. 10.3).

A. Developmental Order of B-Lineage Subpopulations

As B-cell differentiation proceeds, discrete populations of B-lymphocyte precursor cells can be identified based on (1) the expression of specific gene products on the cell membrane or in the cytoplasm, in particular, recombinase-activating genes (*RAG1*, *RAG2*) and terminal deoxynucleotidyl transferase (*Tdt*) (2) the status of immunoglobulin gene rearrangement, (3) the cell cycle status and expression of pre-B-cell receptor and BcR complexes. For the most part, B-cell development in the mouse and the human follow similar pathways.

	Pre-B-I	Pre-B-II		Immature B Lymphocytes	Mature B Lymphocytes
Phenotype	CD34 ⁺ CD19 ⁺ CD10 ⁺ CD117 ⁺	CD19 ⁺ CD10 ⁺ CD25 ⁺		CD19 ⁺ CD10 ⁺ CD25 ⁺	CD19 ⁺ CD25 ⁺
Gene Expression	RAG-1 RAG-2 Tdt	- - -	- - -	+ + -	- - -
Ig Gene Rearrangement	D _H	V _H D _H	V _H D _H V _H J _H	V _H D _H V _H J _H	V _H D _H V _H J _H
Cell Cycle Status	large cycling	large cycling	large cycling	small resting	small resting
Membrane BCR Expression	V _{pre-B} ⁺ H _μ	V _{pre-B} ⁺ H _μ ⁺ pre-BCR ⁺	V _{pre-B} ⁺ H _μ ⁺ pre-BCR ⁺	V _{pre-B} ⁻ H _μ ⁺ pre-BCR ⁺ sIgM ⁻	BCR ⁺ sIgM ⁺ sIgD ⁺

Fig. 10.3 B-lymphocyte differentiation: developmental order of B-lymphocyte subpopulations. (The assistance of Christopher J. Lada in the preparation of this figure is gratefully acknowledged.)

Pre-B-I cells in the human bone marrow express CD34, CD19, CD10, and CD117 (stem cell growth factor receptor) on the membrane and express *Tdt*, *RAG1*, and *RAG2* in the nucleus. These cells do not express sIg or markers present on fully differentiated B cells, such as CD25. Rearrangement of the V-region gene segments has been initiated, but the immunoglobulin heavy chain (μ chain) is not yet expressed in the cytoplasm. A surrogate light chain formed by the association of the *Vpre-B* and $\lambda 5$ gene products, alone or in association with a surrogate μ chain, is expressed on the cell surface.

Pre-B-II cells downregulate CD117 and Tdt and upregulate CD25. Productive VHDJH rearrangement results in high levels of cytoplasmic μ chains that may associate with surrogate light chain to form a pre-B receptor. A second wave of RAG1 and RAG2 expression is associated with rearrangement of the immunoglobulin light chain (VLJL) and in the resulting synthesis of kappa (κ) or lambda (λ) light chains. The majority of the pre-B-II cells are of the small phenotype (VLJL-rearranged, sIg⁺). In the mouse and the human, about 80% of the sIg⁺, CD19⁺ cells in the bone marrow are pre-B-II cells.

The physiological role of surrogate light chain seems to be that of a stabilizer, protecting nascent μ chains from degradation until light chain synthesis is turned on. The significance of this phenomenon in B-cell development has yet to be defined, but expression of *Vpre-B* and $\lambda 5$ genes is critical to normal B-cell development. The $\lambda 5$ gene knockout mice do not form a pre-BcR and are B-cell deficient. In cases of human common variable immunodeficiency associated with defective $\lambda 5$ genes, the B-cell deficiency is even more pronounced than that observed in the knockout mouse. The absence of the RAG gene products is also associated with a differentiation block but in this case affects both T and B cells and results in severe combined immunodeficiency (see Chapter 29).

Immature B cells are characterized as resting cells (not cycling), which express CD19, CD10, sIgM, and CD79 α/β (α, β chains of the BcR) but are sIgD⁻. RAG2 expression is as high in the immature B cell as in the small pre-B-II cell, indicating that additional light-chain gene rearrangement can still occur. Final differentiation occurs when RAG expression is terminated. The phenotype CD19⁺, CD10⁻ sIgM⁺, sIgD⁺ typifies the mature B cell.

The relative proportion of precursor B cells in the bone marrow remains constant though out the life span of the organism. Pre-B-I cells comprise about 5–10% of the total. Pre-B-II cells represent 60–70%, while the remaining 20–25% are immature B cells.

B. B-Cell Maturation

1. Isotype Switching

Around birth, mature, resting B cells co-express sIgM and sIgD on their membranes. The sIgM and sIgD expressed on individual B-cell clones have the same antigenic specificity. These “virgin” B lymphocytes home to secondary lymphoid organs where, upon antigenic challenge, they downmodulate sIgD and, less constantly, sIgM. Activated B cells undergo subsequent heavy-chain constant region gene rearrangements or isotype switching. Thus the same variable region is now associated with a different heavy-chain isotype (IgG, IgE, or IgA). The resultant sIg of different isotypes are expressed on nonoverlapping B-cell subsets, sometimes in association with sIgM. In addition to isotype switching, activated B cells undergo antibody affinity maturation, which results in the emergence and selection of B-cell clones producing antibodies of similar specificity but higher affinity (see Chapter 12).

2. Ontogenic Development of Immunoglobulin Synthesis

A normal newborn infant, though having differentiated B lymphocytes, produces very small amounts of immunoglobulins for the first two to three months of life. During that period of time, the newborn is protected by placentally-transferred maternal IgG, which starts to cross the placenta at the 12th week of gestation. By the 3rd month of age, IgM antibodies produced by the newborn are usually detectable. The concentration of circulating IgM reaches adult levels by 1 year of age. It must be noted, however, that in cases of intra-uterine infection, IgM antibodies are synthesized in relatively large amounts by the fetus and detected in cord blood by conventional assays. The onset of the synthesis of IgG and IgA occurs later and the concentration of these reaches adult levels at 6 to 7 years of age.

C. Surface Molecules Involved in B-Cell Activation and Regulation

Many molecules have been identified on the membrane of B cells. Most are involved in cell-to-cell interactions and participate in the delivery of activating signals or inhibitory signals to the cells (Fig. 10.4). Each B-cell receptor includes molecules responsible for positive signaling—Ig α (CD79 α), Ig β (CD79 β), and CD19—as well as downregulatory molecules—CD22, a tyrosine kinase known as lyn and CD32 (Fc γ RII). A subtle balance between their relative strength is essential for the maintenance of homeostasis after the response, but the details about their control in vivo remain unclear.

1. Surface Molecules Involved in B-Cell Activation

BcR is formed by the covalent association of sIg with the above-mentioned signaling proteins, Ig α and Ig β (Fig. 10.5). Antigen recognition occurs through the sIg moiety of the BcR, whereas Ig α and Ig β mediate signal transduction. After antigen binding, the recruitment of

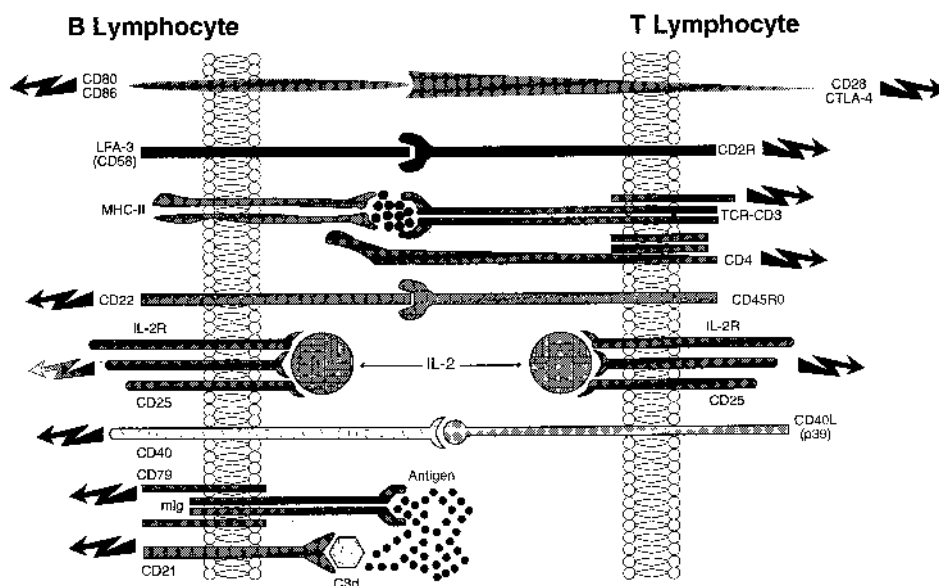

Fig. 10.4 B- and T-lymphocyte membrane molecules involved in the delivery of activating signals. The role of IL-2 in B-cell signaling is not fully defined.

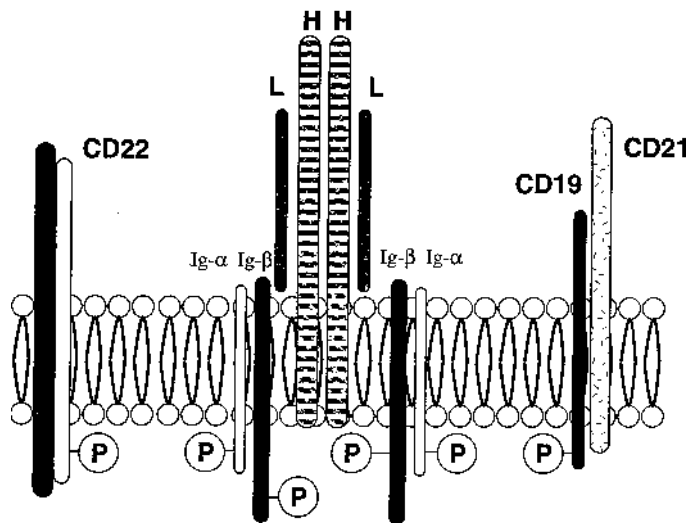

Fig. 10.5 Diagrammatic representation of the B-lymphocyte antigen-receptor complex (BcR), constituted by a membrane immunoglobulin molecule closely associated with Ig α and Ig β molecules. Three additional molecules, CD19, CD21, and CD22, are associated with the BcR complex and play a role in B-cell signaling.

tyrosine kinase to the cytoplasmic domains of the CD79 α and CD79 β initiates the activation cascade. The major kinase that is recruited to the BcR complex is known as Bruton's tyrosine kinase (Btk). Congenital Btk deficiency is associated with a block in B-cell differentiation, demonstrating that signals delivered through the fully assembled BcR and associated kinases are necessary for B-cell development during ontogeny.

CD19 is expressed on B-cell lineage cells with the exception of plasma cells. It is also found on most malignancies of B-lymphocyte origin (see Chapter 27) and follicular dendritic cells. CD19 contains potential phosphorylation sites in the cytoplasmic domain, modulates Ca²⁺ influx into the cell, and associates with CD21 and other molecules. The formation of this molecular complex lowers the activation threshold for the BcR.

CD21 is expressed with high density on mature, resting B cells but is lost upon activation. CD21 is also known as CR2, because this molecule functions as a receptor for the iC3b and C3d fragments of complement (see Chapter 9). CD21 is also the receptor used by Epstein-Barr virus to infect B lymphocytes, its only target cell.

The cytoplasmic domain of CD21 contains potential phosphorylation sites. In the right circumstances the interaction between antigen-bound C3d and CD21 can deliver a costimulating signal to the B cell, which results in significant amplification of the humoral immune response. Mice deficient in CD21 show an impaired response to T-dependent antigens. Moreover, CD21 and CD23 (Fc ϵ R2) interact on the cell surface, and this interaction may play a regulatory role in IgE production.

CD20 is an antigenic cluster associated with the first membrane marker to be found on a developing B lymphocyte, originally designated as B1. It is detectable on pre-B lymphocytes expressing cytoplasmic μ chains and remains expressed during maturation on the mature B lymphocyte, but is not expressed on plasma cells. It is an unusual molecule in that it crosses the membrane several times, has only 42 amino acid residues exposed on the outside, and both the amino and the carboxyl terminal ends are in the cytoplasm. The carboxyl

terminal end has 15 serine and threonine residues, the hallmark of a protein susceptible to phosphorylation by protein kinases, which occurs after mitogenic stimulation. This suggests that CD20 may play an important role in the activation and proliferation of mature B lymphocytes (see Chapter 11).

CD45, initially known as the leukocyte common antigen (LCA), is expressed by all leukocytes and their precursors. It is a major cell surface component of normal leukocytes where it occupies up to 10% of the surface and exists in multiple isoforms generated by alternate splicing of nuclear RNA. B lymphocytes express only the highest molecular weight isoform of CD45. The most remarkable feature of CD45 is its cytoplasmic domain which comprises 705 amino acids and is the largest intracytoplasmic domain of all known membrane proteins. This intracytoplasmic domain has intrinsic tyrosine phosphatase activity and plays an essential role in lymphocyte activation.

CD38 is expressed on immature B and T cells, activated T cells, and terminally differentiated B cells, but not on resting lymphocytes. CD38 disappears from the membrane of memory B cells differentiated in the mantle zone of the lymph nodes, which subsequently leave the nodes as CD20⁺, CD38⁻ memory B cells and migrate to different lymphoid organs. Antibodies to CD38 induce T- and B-cell proliferation.

CD58 (leukocyte function-associated 3, LFA3) is expressed on most hematopoietic cells including erythrocytes, as well as various nonhematopoietic cells such as fibroblasts and endothelial and epithelial cells. It is found on about half of the circulating T and B cells. In lymphoid tissues CD58 is expressed on all dendritic cells, macrophages, germinal center B cells, medullary thymocytes, and medullary thymic epithelial cells. Expression is high on monocytes, memory T cells, and dendritic cells. CD58 on antigen-presenting cells (APC) binds to its coreceptor, CD2, on T cells. This interaction results in increased intercell adhesion and in the delivery of co-stimulatory signals to the T cell.

CD80 (B7.1) and CD86 (B7.2) are membrane glycoproteins expressed at low levels on resting B cells and other APC, which are upregulated upon activation. They bind CD28 and CTLA-4, expressed on T lymphocytes (see Chapter 11).

CD40 interacts with CD154, also known as CD40 ligand (CD40L) or gp39. CD40 is expressed on all mature B cells but is absent from plasma cells. It is also present on some epithelial, endothelial, DC, and activated monocytes. The interaction of CD40 and its coreceptor expressed on helper T cells is required for B-lymphocyte maturation and isotype switching.

2. *Inhibitory or Downregulatory Molecules on B Cells*

CD22, an integral part of the B-cell receptor complex, is first detected in the cytoplasm of pre-B-II cells containing cytoplasmic μ chains. Later it is found on the surface of 75% of sIgM⁺ immature B cells and on 90% of sIgM⁺, sIgD⁺ mature, resting cells. In the adult, CD22 is expressed at relatively high levels in tissue B cells (e.g., in the tonsils and lymph nodes), but not in circulating B cells. CD22 is upregulated during activation, but is lost in the terminally differentiated plasma cells. CD22 binds to sialylated carbohydrate ligands (e.g., CD45RO) and plays an important regulatory role in B-cell activation by raising the B-cell activation threshold. CD22-deficient mice produce excessive antibody response to antigen stimulation, as well as increased levels of auto-antibodies. In contrast, cross-linking of CD22 suppresses the response of B cells to antigenic stimulation because the intracytoplasmic segment has numerous immunoreceptor tyrosine-based inhibitory motifs (ITIM) that function as docking sites for a tyrosine phosphatase known as SHP-1. The bind-

ing of SHP-1 to CD22 prevents phosphorylation of the kinases needed for further B-cell activation. In this way, CD19 and CD22 cross-regulate each other because activation through CD22 inhibits the CD19 pathway.

CD32 (Fc γ RII) is expressed on a range of leukocytes, including monocytes, macrophages, Langerhans cells, granulocytes, B cells, and platelets. CD32, one of two low-affinity IgG Fc receptors, only binds aggregated IgG. The cytoplasmic domains associate with SHP-1 and other downregulatory kinases. Co-ligation of CD32 with membrane Ig (a situation that emerges during the immune response due to the formation of antigen-antibody complexes in antigen excess, as described in Chapter 12) leads to the binding and activation of SHIP. This is followed by inhibition of inositol-1,4,5-triphosphate (IP3), thus blocking the activation pathways activated after BcR occupation.

3. *Other B-Cell Membrane Markers*

CD10, also known as cALLA (common acute lymphoblastic leukemia antigen), is expressed on precursor and immature B cells, pre-T cells, neutrophils, and bone marrow stromal cells. CD10 is a commonly used marker for pre-B acute lymphocytic leukemias and some lymphomas. This molecule is a member of the type II membrane metalloproteinases and has neutral endopeptidase activity. CD10 knockout mice exhibit enhanced lethality to endotoxin, suggesting a role for CD10 in septic shock modulation. CD10 on bone marrow stromal cells appears to regulate B-cell development, since inhibition of CD10 *in vivo* enhances B-cell maturation.

CD5 is expressed on most T lymphocytes and on a small subpopulation of B lymphocytes. CD5 is found on most chronic lymphocytic leukemias. In nonleukemic individuals, B lymphocytes expressing CD5 appear to be activated and committed to the synthesis of IgM auto-antibodies. However, there is no apparent correlation between disease activity and the numbers of circulating CD5⁺ cells; thus, the precise role of these cells remains speculative. The cytoplasmic domain of CD5 contains the immunoreceptor tyrosine-based activation (ITAM) motifs and is phosphorylated during T-cell activation. CD5 is thought to be involved in thymic selection and in T-B cell recognition.

CD11a combines with another integrin, CD18, to form leukocyte function-associated molecule 1 (LFA-1). The three ligands for LFA-1 are CD54 (intercellular adhesion molecule-1, ICAM-1), CD102 (ICAM-2) and CD50 (ICAM-3). LFA-1 and the ICAM are expressed by T, B, and NK cells and are responsible for homotypic interactions: The LFA-1 expressed on the T cell can interact with its counterreceptor, ICAM-1, on the B cell and vice versa.

Major histocompatibility complex (MHC) antigens in humans are referred to as the human leukocyte antigen or HLA. B lymphocytes express high levels of both HLA classes I and II. The presence of HLA class II enables B lymphocytes to serve as antigen-presenting cells. Thus, B lymphocytes are unique in that they have both antigen-specific effector properties (i.e., antibody synthesis) as well as antigen-presenting capabilities.

D. Elimination or Downregulation of Autoreactive B Cells

The membrane immunoglobulins of B-cell precursors include those able to combine with epitopes expressed on self antigens. As discussed in detail in Chapter 16, these autoreactive cells are either deleted or rendered nonreactive by means of the inactivation of the signal transduction part of their B-cell receptor.

V. T-LYMPHOCYTE ONTOGENY

The thymus is the primary organ for T-cell differentiation. When the thymus is congenitally absent or surgically removed before immunological maturity is reached, a profound T lymphocyte deficiency is observed. The T-lymphocyte deficiency in athymic and thymectomized mice is usually associated with severe immunodeficiency and is incompatible with prolonged survival.

A. Pre-T-Lymphocyte Markers

T lymphocytes differentiate intrathymically from the common lymphoid progenitor originating in the bone marrow as early as the seventh week of gestation. The most primitive thymic immigrants express CD34, CD45RA, and CD7 but do not express some of the adult T-cell markers, such as CD2 and CD3. These cells are tripotential precursors, which have the ability to differentiate into T, NK, or DC cells. The next most primitive cell has the same phenotype, except that it has become CD2⁺ and CD5⁺. The thymocytes then acquire CD1a and are restricted to the T-cell lineage. Expression of CD1a parallels TcR gene rearrangements. Although expressed at high levels on thymocytes, CD1 is barely detectable on mature T lymphocytes.

B. Enzymatic Activity in Pre-T Lymphocytes

Once they reach the thymus, the T-lymphocyte precursor cells proliferate rapidly. Maturing thymocytes express several enzymes of the purine salvage pathway, such as adenosine deaminase (ADA), purine nucleoside phosphorylase (PNP), and terminal deoxynucleotidyl transferase (Tdt). The expression level of these enzymes changes as ontogenic development proceeds (Fig. 10.6).

C. Rearrangement of the TcR Genes

The TcR genes undergo rearrangements during T-cell differentiation. These rearrangements involve the deletion of noncoding sequences and the joining, or transposition, of noncontiguous segments of DNA. Transposition is mediated by the products of the *RAG*

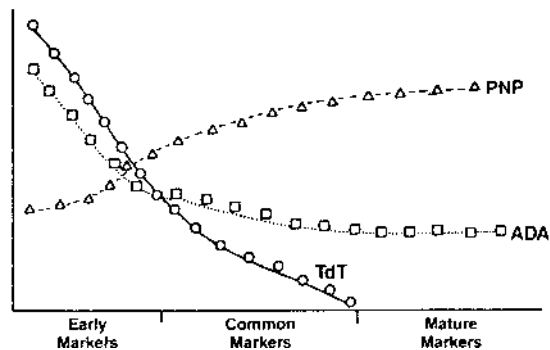

Fig. 10.6 Longitudinal changes in the concentrations of purine nucleoside phosphorylase (PNP), adenosine deaminase (ADA), and terminal deoxynucleotidyl transferase (Tdt).

genes, which act as transposases. *RAG*-deficient mice cannot rearrange B- or T-cell receptor genes.

Strategies similar to those used in the studies of the molecular genetics of immunoglobulin genes allowed the identification of the genes coding for the α , β , γ , and δ chains of the TcR. The β and γ chain genes are located in distant regions of chromosome 7, while the α and δ chain genes are located on chromosome 14 (Fig. 10.7). The rearrangement of these genes will generate two types of receptors: $\gamma\delta$ or TcR1, and $\alpha\beta$ or TcR2.

Due to the chromosomal organization of the TcR genes, the TcR1 genes are rearranged first. The δ gene is located in the middle of the α -chain gene, between the $V\alpha$ and $J\alpha$ regions. When *RAG* transposes the elements of the δ genes to form a VDJ complex, it eliminates the V and J regions of the α gene. The rearranged δ chain will pair with the γ chain. T cells expressing TcR1 ($\gamma\delta$ TcR) will leave the thymus to migrate to the skin and mucosae. Rearrangements of the TcR2 genes occur during the second wave. The appearance of a DJ rearrangement of the β chain is followed by the addition of V- and C-region genes. The productively rearranged β chain will be present in the cytoplasm for several days before the α chain is expressed. During that period the, β chain will associate with a “protective” polypeptide, known as the pre-T α . This pre-T-cell receptor (pre-TcR) is expressed on the surface of T-cell precursors and has signaling capacity.

Rearrangement of the α -chain genes results in the deletion of the δ gene, which will appear as extrachromosomal circular DNA in germline configuration. When the α -chain gene rearrangement is completed, the translated α chain combines with a β chain and a full receptor is expressed on the cell membrane. Coinciding with the synthesis of a complete $\alpha\beta$, the recombinases involved in the processes become inactive, so that rearrangements on the second allele do not take place. Thus, the phenomenon of allelic exclusion, originally described for immunoglobulin synthesis (see Chapter 7), also exists for TcR synthesis.

The generation of the extensive diversity needed for a complete TcR repertoire relies almost exclusively on the D regions. These regions are the targets of extensive nucleotide

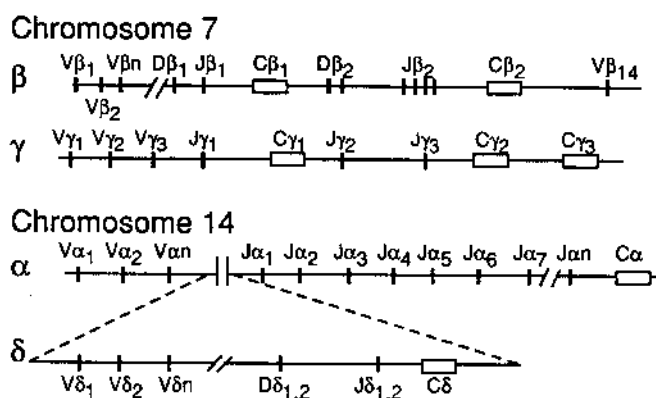

Fig. 10.7 Genomic organization of the T-cell receptor genes. The genes for the β and γ chains rearrange independently at their own end of chromosome 7. The δ genes are in the middle of the α -gene locus on chromosome 14. Rearrangement of the α genes leads to removal of the δ genes, which are found as extrachromosomal DNA in cells that have productive rearrangements of the α and β genes yielding a TcR2⁺ T cell. In TcR1⁺ ($\gamma\delta$) T lymphocytes, the genes are deleted.

addition, particularly at the DJ junction, resulting in configurational diversity. Of the four genes available for TcR synthesis, only the β and δ genes that have a D region will be hypervariable; by contrast, the α and γ genes are less polymorphic. A major difference between T and B cells is that once the rearrangements are completed in the thymus, the TcR will never change again, whereas BcR will undergo class switching and affinity maturation in the secondary lymphoid organs. The estimated diversity of $\alpha\beta$ and $\gamma\delta$ TcR (10^{15} – 10^{18}) exceeds the potential diversity of immunoglobulins (10^9 – 10^{11}) by several orders of magnitude.

D. Association with Coreceptors

Prior to TcR gene rearrangements, early thymocytes do not express CD4 or CD8 and are known as double negative thymocytes. Following productive β -chain rearrangement, the β chain/pre-T α (pre-TcR) associates with CD3 molecules and is transported to the cell membrane. This event generates activation signals, which lead to the co-expression of CD4 and CD8. These cells are then known as double positive thymocytes. As the cell continues to differentiate, one of these two markers will be retained and the other will be lost, so that the cells will be either CD4⁺ or CD8⁺.

CD3 is a complex of 5 unique subunits designated γ , δ , ϵ , ζ , and η (note that the γ and δ chains of the CD3 unit are distinct from the $\gamma\delta$ chains of the TcR1). The CD3 $\gamma\delta\epsilon$ trimolecular complex is synthesized first and remains intracytoplasmic, where it becomes associated with pre-T α molecules. Soon thereafter, the CD3 ζ chains are synthesized and become associated to the CD3 complex. Once the ζ chain has been added to the CD3 complex, the whole CD3–pre-T α complex is transported from the Golgi apparatus to the cell membrane. A critical characteristic of the ζ chain is its long intracytoplasmic tail, which has affinity for the zeta-associated protein kinase (ZAP70). The association of ZAP70 to the ζ chain is critical for further differentiation of the T cell. The congenital absence of ZAP70 is associated with a block at the DN stage of T-cell development.

Once the CD3–pre-T α complex is expressed on the cell membrane, *RAG* genes are reexpressed. Subsequently, α -gene rearrangements occur, followed by the replacement of the pre-T α chain of the pre-T-cell receptor by the newly synthesized α chain. The $\alpha\beta$ complex, with a full complement of CD3 molecules, is then inserted in the T-cell membrane (Fig. 10.8).

E. Selecting the Right Receptors

Positive and negative selection of differentiating T cells also occurs in the thymus. Coinciding with the expression of complete TcR, double-positive pre-T cells move from cortical area of the thymus to the medullary area. Thymic epithelial cells in the medulla, which express both MHC class I and class II, interact with the pre-TcR cells. At this time, autoreactive and useless T cells are eliminated (Fig. 10.9). Only 2–3% of the differentiating T cells survive this process.

1. Negative Selection

Many newly formed pre-T cells are negatively selected because the TcR is abnormal (the recombination process produced out of frame rearrangements) or because the resulting TcR is unable to interact with any HLA molecule. A smaller percentage is thought to die from

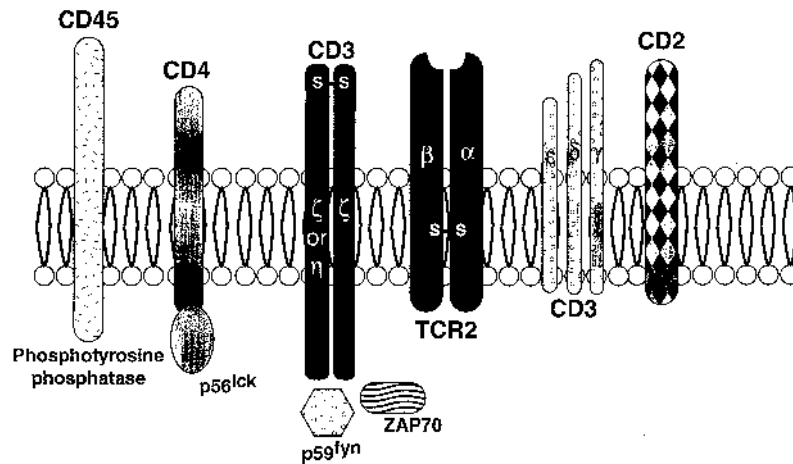

Fig. 10.8 Diagrammatic representation of the TcR2 and its co-receptors on a mature CD4⁺ T lymphocyte. The $\alpha\beta$ heterodimer is associated in the membrane to the CD3 complex constituted of the trimolecular complex CD3 $\gamma\delta\epsilon$ and either a CD3 $\zeta\zeta$ dimer or a CD3 $\zeta\eta$ dimer. It is believed that activating signals are transmitted by the ζ chain, but occupation of the TcR is not a very effective activator by itself. Other co-receptors play a role in the initial T-cell activation, such as CD45, which has intrinsic phosphatase activity, and CD4, which is associated to a p56lck tyrosine kinase. At least two more tyrosine kinases—p59fyn and ZAP70—appear to play a role in the initial signaling cascade (see Chapter 11).

apoptosis because their interaction with the HLA peptide complexes is too strong. This last mechanism is a consequence of the fact that during the time T cells are differentiating, extensive development of most other tissues is taking place, hence, large numbers of cells are undergoing apoptotic death. This results in the extensive release of self antigens, which are eventually captured by the thymic epithelial cells and presented to the pre-T cells in the context of self MHC. The pre-T cells whose TcR interacts strongly with a MHC-peptide complex receive an apoptotic signal and are eliminated. This negative selection process is responsible, in part, for the development of tolerance to self during embryonic differentiation (see Chapter 16).

2. Positive Selection

The few double positive pre-T cells that survive are those that have TcR molecules able to interact at the same time with MHC molecules and with either the CD4 or the CD8 molecule. If the TcR is MHC class I restricted, it must associate with CD8. The CD8-TcR MHC class I interaction results in the activation of repressor genes that turn off CD4 expression. Conversely, double positive T cells that have MHC class II restricted TcR engage CD4 and the expression of CD8 is turned off. The single positive CD4 or CD8 T cells emerging from the medulla leave the thymus and colonize the peripheral lymphoid organs.

The positive signal delivered to the double positive thymocytes through these TcR-MHC interactions involves CD45 and the lymphocyte-specific tyrosine kinase p56lck. These molecules are utilized by both CD4 and CD8 T cells. As the TcR interacts with MHC, the phosphatase activity of CD45 is upregulated and ZAP70 is activated. Both activities contribute to the dephosphorylation of p56lck, which becomes activated. The activation of p56lck is critical for further T-cell differentiation, because mice deficient in ei-

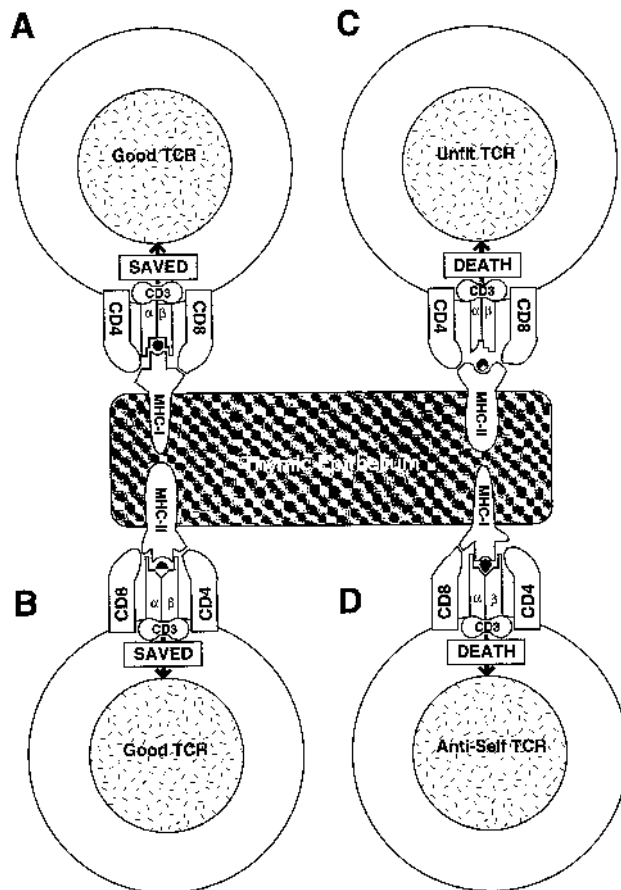

Fig. 10.9 Diagrammatic representation of the role played by MHC in clonal selection during intrathymic lymphocyte differentiation. TcR2⁺ pre-T lymphocytes, which co-express CD4 and CD8, interact with self-MHC class I and class II expressed on the thymic epithelium. (A) In this example, the TcR2⁺ has a good fit with self-MHC class I, the CD8 molecule also interacts with the MHC-I, but the TcR does not interact with a self peptide associated with the MHC-I molecule. The dual interaction between CD8 and TcR with MHC-I will deliver a positive signal, transduced by the CD3, which will rescue the lymphocyte from programmed death. At the same time, the gene coding for the CD4 molecule, which did not interact with the MHC-I, will be repressed. Thus, a CD8⁺ T lymphocyte clone will emerge from this positive selection process. (B) In this second example, the TcR2⁺ has a good fit with self-MHC class II, the CD4 molecule also interacts with MHC-II, but the TcR does not interact with a self peptide associated with the MHC-II molecule. This lymphocyte will be rescued from programmed death by a positive signal transmitted by the CD3, and since the CD8 molecule did not interact with the MHC, its expression will be repressed. Thus, a CD4⁺ T lymphocyte clone will emerge from the selection process. (C) If the TcR2 does not interact either with class I or class II MHC, that T cell does not receive any positive signal from CD3 and dies as programmed. (D) In this final example, a self-reactive pre-T cell is depicted. Its TcR interacts with MHC-I and with the self peptide associated with it. This results in a high-affinity interaction between the lymphocyte and the thymic epithelium that accelerates the process of apoptosis, thus eliminating the autoreactive lymphocyte. This process of negative selection can eliminate both CD8⁺ and CD4⁺ autoreactive cells.

ther CD45 or p56lck cannot proceed beyond the double positive stage. Also critical is the proper expression of MHC molecules: MHC class I-deficient mice do not develop normal numbers of CD8⁺ T cells, while class II-deficient mice and humans do not differentiate normal numbers of CD4⁺ T cells.

F. T-Cell Differentiation After Birth

The thymus remains active as the site of T-cell differentiation until early adulthood. Later in adult life the thymus becomes atrophic. An adequate supply of T cells may be due to the fact that memory T cells survive for decades. Alternatively, extrathymic differentiation of T cells may occur in adult life.

$\gamma\delta$ T cells expressing TcR1 abound in the mucosal immune system and the skin, where they represent the dominant T-cell population. The precise biological role of TcR1⁺ T lymphocytes is a matter of considerable debate. The $\alpha\beta$ T cells, expressing TcR2, represent more than 95% of mature circulating T lymphocytes.

G. TcR Structure

Although the structure of TcR2 ($\alpha\beta$) has been more extensively characterized than the structure of TcR1 ($\gamma\delta$), both heterodimers are believed to have a similar structure. The comparison of the general characteristics of TcR and surface immunoglobulin in B lymphocytes (BcR) reveals many similarities, as well as notable differences. A comparison between the two is summarized in Table 10.1

The α (acidic) chain is about 40–50 kDa, whereas, the β (basic) chain is slightly smaller, 40–45 kDa. Each chain is comprised of an extracellular, a transmembrane, and an intracytoplasmic domain. Like the BcR, the TcR has a small intracytoplasmic region. In the extracellular domain, the constant region contains about 120–140 amino acids and the variable domains 100–120 amino acids. The variable regions are located on the amino-terminal end of each chain. Their length is similar to that of the immunoglobulin variable regions.

The hypervariable regions within the variable domain form the antigen-binding site, unique for each TcR. Monoclonal antibodies generated against the antigen-binding site of

Table 10.1 Comparison of the Similarities and Differences Between T- and B-Lymphocyte Receptors

	mIg (BcR)	TcR2
During ontogeny		
1st expressed chain	μ	β
2nd chain expressed later	κ or λ	α
Allelic exclusion	Yes	Yes
Short cytoplasmic domain	Yes	Yes
Association w/coreceptors	Yes	Yes
Positive selection	No	Yes
After differentiation		
Generation of new cells expressing the receptors	Continuous	Limited
Receptor rearrangements	Yes	No
Life span of memory cells	Weeks	Years

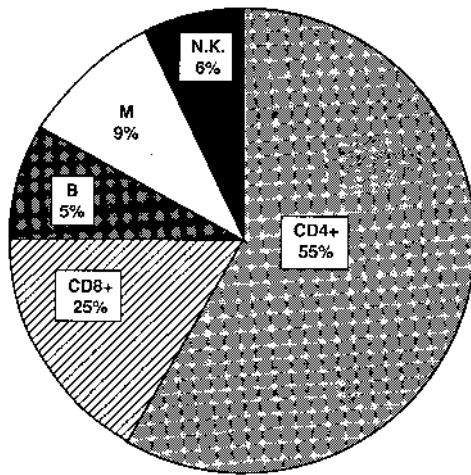

Fig. 10.10 Graphic representation of the distribution of cell populations among peripheral blood mononuclear cells.

the TcR detect an idiotypic specificity unique to that particular TcR or T-cell clone. The surface area of the antigen-binding site on the TcR2 is similar to that of the BcR, yet the degree of genetic diversity for TcR2 is more extensive.

The crystallographic structure of an HLA A2 molecule complexed to a viral peptide interacting with a specific T-cell receptor has been examined. The TcR is positioned in diagonal orientation over the face of the peptide-MHC complex, two loops (CDR1 and CDR2) of the TcR α chain overlie the N terminus of the peptide, and the corresponding area of the β chain interacts with the peptide C terminus. At the same time, both TcR α -chain loops also interact with the MHC molecule. The most variable region of both α and β chains, designated as CDR3, is in the center of the molecule and has the best access to the most variable region of the MHC-associated peptide. It is likely that the same structural relationships are operative in the interaction between TcR and MHC class II-peptide complexes.

H. Membrane Markers on Mature T Cells

The list of membrane markers present on T cells (and other hematopoietic cells) continues to grow. Generally, markers can be divided into two categories: pan-specific or subset-specific. Pan-specific markers are common to all cells of a given type, whereas subset-specific markers are present on only a subpopulation of cells of a given lineage. CD2 and CD3 are considered to be pan-T-cell markers; however, their specificity is not absolute because CD2 is also expressed by NK cells in general and CD3 is expressed by a special subpopulation of NK cells known as T/NK (CD3), highlighting the lineage relationship between T and NK cells. CD4 and CD8 represent subset-specific T-cell markers. As shown in Figure 10.10, about three quarters of peripheral blood mononuclear cells are T lymphocytes, and among T lymphocytes CD4⁺ cells predominate over CD8⁺ cells by a 2:1 ratio.

CD3 is first expressed during thymic differentiation and continues to be expressed all mature T cells in the periphery. CD3 is a complex of five unique, invariant chains ($\gamma\delta\epsilon\zeta\eta$). The cytoplasmic domains of the CD3 ζ chain contain ITAM motifs and are responsible for signaling. The ζ chain also associates with CD16 and functions as the signaling domain of

that receptor expressed on NK cells. Phosphorylated ITAM motifs of the CD3 ζ chain bind to SH2 domains of the intracellular signaling molecules, e.g., phosphorylated ζ chains bind ZAP70.

CD2 is expressed on all thymocytes, T cells, and NK cells. The heterotypic interaction between CD2 and its major ligand CD58 (LFA-3) enhances T-cell antigen recognition. CD2:CD58 interaction can also stimulate T-cell proliferation and differentiation (see Chapter 11).

CD4 is expressed on most thymocytes and approximately two thirds of the peripheral blood T cells. CD4 is also expressed on monocytes and macrophages. CD4 defines the T-helper cell population and binds to MHC class II antigens during antigen-specific TcR binding. CD4 is also the receptor for HIV-1.

CD8 is expressed on most thymocytes, a third of the peripheral blood T cells, and some NK cells. CD8 can be expressed as a CD8 $\alpha\beta$ heterodimer or CD8 $\alpha\alpha$ homodimer. CD8 $\alpha\beta$ is only found on TcR2 ($\alpha\beta$) T cells. In contrast, CD8 $\alpha\alpha$ can be found on NK cells, $\gamma\delta$ T cells, or $\alpha\beta$ T cells. CD8 $\alpha\beta$ T cells represent the cytotoxic subpopulation of T lymphocytes. CD8 binds to MHC class I antigens during antigen-specific TcR binding. The function of CD8 on NK cells is not known.

1. *Markers Associated with T-Cell Activation*

CD25, the low-affinity IL-2 receptor (IL-2R), is expressed at low levels by about 30% of circulating (resting) lymphocytes, particularly on the memory T-cell population that expresses CD45RO or CD45RA and is CD62L⁻. Expression is upregulated upon T-cell activation; thus, CD25 expression can be used as an indicator of the number of activated T cells. Activated B lymphocytes also express CD25.

CD2R is an epitope of CD2 expressed by activated T lymphocytes and is probably the most specific of the activation markers. Its expression is likely to be associated with cell-cell interactions involving CD2 and LFA-3, which are believed to deliver additional activation signals to the T lymphocyte.

CD45 expression and function has been characterized more extensively in T lymphocytes than in other leukocyte populations. CD45 plays an important role in T-lymphocyte activation, due to the fact that its intracytoplasmic domain has tyrosine phosphatase activity. Three isoforms (CD45RA, CD45RB, CD45RO) have been identified on T cells. These isoforms share the intracellular domains but vary in their extracellular domains. CD45RA is the largest (220 kDa), CD45RB is of intermediate size (205 kDa), and CD45RO the smallest (180 kDa). The ontogenic development of the CD45 isoforms is not clear, but in mature lymphocytes their expression becomes restricted (as indicated by the letter R in the designation of these isoforms).

CD45RA is expressed both by naive and memory CD4⁺ T cells. In the case of naive populations, CD45 is co-expressed with CD62L, while memory T cells either express CD45RA only or switch from CD45RA to CD45RO.

CD45RO⁺ T cells are considered as either as primed T lymphocytes or as memory T lymphocytes (the expression of this marker seems to be maintained long after the primary response has waned). CD45RO⁺, CD4⁺ T cells are thought to provide B-cell help during humoral immune responses.

CD28 is a disulfide-linked homodimer expressed on most T-lineage cells and plasma cells. All CD4⁺ cells and half of the CD8⁺ circulating lymphocytes express CD28. The dominant costimulatory pathway in T-cell immune responses results from the interaction

of CD28 and a related molecule, CD152 (CTLA-4), with the B-lymphocyte antigens CD80 (B7.1) and CD86 (B7.2) (see Chapter 11).

CD71, the transferrin receptor, is a type II membrane glycoprotein that is upregulated during leukocyte activation. The CD71 homodimer associates with CD3 ζ , suggesting a role in signal transduction. The CD71-controlled supply of iron to the cell is important during proliferative responses.

CD69 is a lectin receptor encoded in a region of chromosome 12 known as the “NK gene complex.” CD69 is expressed on a variety of hematopoietic cells. Although absent on resting lymphocytes, CD69 is rapidly upregulated during activation of T, B, and NK cells. Because monoclonal antibodies directed against CD69 can activate lymphocytes, a role for CD69 in signal transduction has been suggested.

CD49b, an α 2 integrin, is the α subunit of VLA-2; the β subunit is the integrin CD29. CD49b is expressed on monocytes, platelets, T, B, and NK cells. It is upregulated upon stimulation with phytohemagglutinin. VLA-2 (CD49b/CD29) binds collagen and laminin.

CD154 [CD40 ligand (CD40L)] is expressed on activated CD4⁺ cells and a small population of CD8⁺ cells and $\gamma\delta$ T cells. CD154 interacts with CD40, expressed on B cells. This interaction is required for the development and maturation of T-dependent B-lymphocyte responses. As discussed in Chapter 29, the lack of expression of the CD154 is the molecular basis of most cases of a unique immunodeficiency disease known as hyper-IgM syndrome.

CD26 is expressed by both hematopoietic and nonhematopoietic cell types. In leukocytes, it is upregulated during T-cell activation but primarily expressed on memory T cells. CD26 is a type II membrane dipeptidylpeptidase. CD26 has many proposed functions, mainly that of a membrane-bound protease that facilitates diapedesis and extravascular migration. In addition, there is evidence suggesting that CD26 may function as a cell adhesion molecule and as a T-cell co-stimulatory molecule.

CD54 or ICAM-1 is expressed by both hematopoietic and nonhematopoietic cell types. The expression on leukocytes is upregulated during activation. Similarly, the expression on the endothelium is upregulated during inflammation. ICAM-1, ICAM-2 (CD102), and ICAM-3 (CD53) are all coreceptors for the integrin LFA-1 (CD11a/CD18) expressed on antigen-presenting cells (APC) and other leukocytes. ICAM-1 also binds to other related integrins such as CD11b/CD18 (MAC-1) and CD11c/CD18 (p150, 95). On T cells CD54 binding increases antigen-specific interactions with the APC.

2. *Markers That Inhibit T-Cell Activation*

As discussed below, inhibitory receptors first identified on NK cells (KIR) are also found on subsets of T cells.

III. NATURAL KILLER CELLS

A. Ontogeny

Compared to T- and B-cell development, much less is known about the biological and biochemical events that drive NK-cell development. The observation that T and NK cells share many surface markers as well as functional activities led to the identification of a common T/NK precursor. This precursor population is believed to be the source of a subpopulation of dendritic cells, which expresses other lymphoid phenotypic markers, in contrast with the predominant population of dendritic cells that are of myeloid lineage.

Unlike T and B cells, no marker is exclusively expressed by NK cells. Phenotypically mature NK cells are defined as CD3⁻, CD16^{+/-}, CD56⁺ lymphocytes. NK cells can account for 5–27% of circulating lymphocytes. Also in contrast to T and B lymphocytes, NK cells do not rearrange their TcR or Ig genes; they develop normally in *scid* mice or RAG-1^{-/-} or RAG-2^{-/-} knockout mice. Although committed NK progenitors can be found in the thymus, NK cells can develop in athymic nude mice; therefore, the thymus is not required for NK development. It is believed that NK cells can develop in a variety of organs; however, the major site of NK-cell development has yet to be discerned. Functionally active NK cells can be isolated from the fetal thymus at 6 weeks of gestation, prior to formation of the thymic rudiment. Thus NK cells are probably the first functionally active lymphocyte in the developing fetus.

NK cells do not express an antigen-specific receptor homologous to the TcR and BcR and thus are considered part of the *innate immune system* as opposed to the *adaptive immune system*. NK cells are active in the naive or nonimmunized host and are considered one of the first lines of defense against infection. They are important early producers of IFN- γ . NK cells secrete other cytokines and chemokines such as TNF, GM-CSF, MIP-1 α , MIP-1 β , and RANTES. Traditionally, NK cells have been functionally defined by the ability to mediate spontaneous or “natural” killing of virus-infected, tumor, and allogeneic target cells. This cell-mediated lysis is perforin-dependent. The CD16⁺ NK cells also mediate antibody-dependent cellular cytotoxicity (ADCC).

B. NK Cell Receptors

The study of NK-cell receptors has made significant strides in the past few years. Signals generated from activation and inhibitory receptors on the surface of the NK cells compete to influence the cellular response. Positive stimuli are required to activate NK-cell effector function, while inhibitory receptors and cytokines control specificity and regulation. NK-cell inhibitory signals are mediated by receptor for MHC class I antigens. However, the signals that activate NK cells are less well defined.

1. NK-cell Inhibitory Molecules

Traditionally NK cells were defined as mediators of MHC nonrestricted cytolysis because of their ability to lyse autologous and allogeneic tumor or virally infected targets. The observation that NK cells preferentially lysed target cells that expressed low levels or no MHC class I antigens precipitated the study of MHC class I receptors on NK cells. Three distinct MHC class I receptor families have recently been identified: LY49, CD94/NKG2, and KIR. Although structurally distinct, each of these receptor families uses a similar mechanism to mediate inhibitory signaling—the inhibitory sequences (ITIM) in the cytoplasmic domains of the receptors. Tyrosine phosphorylation of these sequences is induced by interaction with a MHC-I molecule. The subsequent recruitment of the tyrosine phosphatases SHP-1 and, possibly, SHP-2 results in NK-cell inhibition. NK-cell proliferation, cytotoxicity, and cytokine production are all downregulated as a consequence of MHC-I–NK receptor interaction.

In humans, the best characterized receptors are those of the KIR (killer cell–inhibitory receptor) family that are expressed on overlapping subsets of human NK cells and a subset of T cells. The 12 members of the KIR family are structurally different from each other. Some of the members of this family have short cytoplasmic tails that do not contain

ITIM sequences and therefore may not be functionally identical to the members of the family with long intracytoplasmic tails that include ITIM sequences.

Human NK cells also express CD94/NKG2 receptors, which are also expressed on the surface of a subset of T cells. The LY49 receptors, in contrast, are only expressed in murine NK cells.

2. *NK Cell Activation*

NK cells can be activated by a variety of ligands, involving a variety of different receptors.

NKR-P1 receptors are membrane receptors of the C-type lectin superfamily, which are expressed on most NK and a subset of T cells. These receptors interact with glycoproteins, such as those expressed in mammalian cells, and are believed to deliver activating signals to the NK cells. However, the response to NKR-P1 triggering in human NK cells is variable. This may be due to the presence of additional, functionally distinct NKR-P1 isoforms. Rodent NKR-P1 molecules contain the CXCP motif also found in CD4 and CD8 that interacts with phosphorylated p56lck, and this is strong evidence of their ability to be involved in cell stimulation. This sequence is not found in human NKR-P1.

CD16 is a low-affinity IgG Fc receptor (FcγRIII) expressed on most NK cells, activated monocytes, and a subset of T cells. The transmembrane-anchored CD16 isoform is complexed with the CD3ζ chain or the FcεRγ chain. Receptor ligation results in the phosphorylation of tyrosine residues within the ITAM motif in the cytoplasmic domains of the CD3ζ chain or the FcεRγ chain. This is followed by the recruitment and phosphorylation of ZAP70, activation of phospholipase C, stimulation of PI 3-kinase and MAP kinase, p21 ras activation, and translocation of NFAT. CD16 engagement on NK cells results in ADCC and cytokine secretion.

CD2 is expressed on NK and T cells. CD2 activation by monoclonal antibody or its counterreceptor, CD58 (LFA-3), induces a similar cascade of intracellular signaling events as CD16 ligation and induces NK cell-mediated cytotoxicity. CD2 is thought not to be a primary activation receptor on NK cells, but rather a costimulatory receptor that augments NK-cell activation.

IV. DENDRITIC CELLS

Dendritic cells are highly specialized, highly efficient, antigen-presenting cells. The precise lineage and membrane markers that identify DC is presently an area of active research and much debate. Although dendritic cells were originally thought to be of myeloid lineage, recent evidence indicates that a subset of dendritic cells is of lymphoid lineage. Given the correct culture and cytokine conditions, early thymic precursors can develop into DC. DC are believed to express high levels of HLA-DR and several other markers, including CD11c, CD123, CD40, CD54, CD58, CD86, and CD83. Interest in APC has been increased by their use in cancer therapy. DC-based cancer immunotherapy involves isolating DC, loading them with antigen *ex vivo*, and reinfusing them into patients. CD4⁺ CD8⁺ T-cell responses and NK-based antitumor responses were generated. Preliminary clinical trials using this strategy to treat B-cell lymphomas and prostate cancer have been successful.

SELF-EVALUATION**Questions**

Choose the one *best* answer.

- 10.1 Which of the following characteristics does a pre-B lymphocyte first express?
- A. Cytoplasmic μ chains
 - B. Cytoplasmic light chains
 - C. Membrane IgD
 - D. Membrane IgM
 - E. Rearranged V-D-J DNA regions
- 10.2 Which one of the following steps is used for the selection of hybridoma clones producing specific antibodies?
- A. Culture of the mixture of fused and nonfused cells in HAT medium
 - B. Fusion of splenocytes and plasmacytoma cells with polyethylene glycol
 - C. Harvesting of splenocytes from a mouse immunized with the relevant antigen
 - D. Limiting dilution of fused cells
 - E. Selection of a malignant plasma cell line producing antibodies of the desired specificity
- 10.3 Which of the following blocking monoclonal antibodies is likely to prevent the differentiation of IgG-producing cells in a mitogenically stimulated mononuclear cell culture?
- A. Anti-CD19
 - B. Anti-CD2
 - C. Anti-CD3
 - D. Anti-CD40
 - E. Anti-CD8
- 10.4 Which of the following characteristics of a thymic epithelial cell interacting with an autoreactive $CD4^+/CD8^+$ pre-T lymphocyte will result in the elimination of the autoreactive cell?
- A. Expression of autologous MHC-I or MHC-II molecules
 - B. Expression of the autologous protein recognized by the TcR on the cell membrane
 - C. Presentation of the autologous peptide recognized by the TcR in association with either MHC-I or MHC-II molecules
 - D. Presentation of the autologous peptide recognized by the TcR in association with MHC-I molecules
 - E. Presentation of the autologous peptide recognized by the TcR in association with MHC-II molecules
- 10.5 Which of the following is a characteristic of the $\alpha\beta$ T-lymphocyte receptor?
- A. Association with the CD3 molecular complex on T lymphocyte membranes
 - B. Early expression on pre-T lymphocytes lacking specific CD markers
 - C. High-affinity interaction with class I MHC molecules
 - D. Homodimeric structure
 - E. Upregulation after T-lymphocyte activation

- 10.6 Which of the following lymphocyte markers is *not* likely to be detected on an activated B lymphocyte?
- A. CD25 (IL-2 receptor)
 - B. CD2R
 - C. Class I MHC
 - D. Class II MHC
 - E. CR2
- 10.7 Which one of the following properties better defines CD4⁺ T lymphocytes?
- A. Ability to deliver co-stimulatory signals to other T and B lymphocytes
 - B. Expression of the $\gamma\delta$ T-cell receptor
 - C. Function predominantly as antigen-specific cytotoxic T lymphocytes
 - D. High-affinity interaction with cells expressing class I MHC molecules
 - E. Susceptibility to infection by the Epstein-Barr virus
- 10.8 The first synthetic product of a B lymphocyte is (are):
- A. μ chains
 - B. Surface IgD
 - C. Surface IgM
 - D. Surrogate heavy chains
 - E. Surrogate light chains
- 10.9 After birth, human B-lymphocyte differentiation takes place in the:
- A. Bone marrow
 - B. Liver
 - C. Gut-associated lymphoid tissue
 - D. Spleen germinal centers
 - E. Peyer's patches
- 10.10 Which of the following genes rearrange during the immune response?
- A. Immunoglobulin heavy-chain C-region genes
 - B. Immunoglobulin light- and heavy-chain C-region genes
 - C. TcR α chain constant-region genes
 - D. TcR β chain constant-region genes
 - E. Variable-region genes of immunoglobulins and TcRs

Answers

- 10.1 (E) The first evidence for differentiation of a lymphocyte of the B-lymphocyte lineage is a DNA rearrangement that brings together the VDJ regions of chromosome 14. Soon thereafter, intracytoplasmic μ chains can be detected, preceding the rearrangement of chromosome 2 or 22 needed for light-chain synthesis and expression of membrane IgM.
- 10.2 (D) Although the antibody-producing cells are obtained from the spleen of mice immunized with the relevant antigen, the resulting hybrids contain a mixture of clones producing antibodies of different specificities. To obtain clones of cells, producing antibodies of one single specificity is necessary to separate individual fused (hybrid) cells and allow them to proliferate into discrete clones. Such separation can be obtained by limiting dilutions or by cell sorting.
- 10.3 (D) A monoclonal antibody to CD40 will block the interaction between

- CD40 and its ligand. This interaction is essential for the switch from IgM to IgG synthesis
- 10.4 (C) The differentiation of CD4⁺/CD8⁺ T pre-T lymphocytes into CD4⁺ or CD8⁺ pre-T lymphocytes depends on the ability of T lymphocytes to interact with either MHC-I or MHC-II molecules expressed by the thymic epithelium. The cells not interacting with MHC are lost; those interacting with MHC and simultaneously recognizing a MHC-associated self peptide are deleted. This elimination of autoreactive T lymphocytes will be mediated by the recognition by the TcR of peptides associated with either MHC-I or MHC-II molecules.
- 10.5 (A) The $\alpha\beta$ TcR is a heterodimer constituted by one α and one β chain, which interacts both with MHC-I and MHC-II molecules. Its expression on the differentiating T-lymphocyte membrane is a relatively late event, since CD markers characteristic of the T-cell lineage are expressed at earlier stages of differentiation. The expression of TcR remains is not altered after T cell stimulation. The transport of the $\alpha\beta$ TcR receptor to the cell membrane of a differentiating T lymphocyte is believed to depend on its association with the CD3 complex, which also provides the TcR with a transducing unit required for cell signaling after antigen recognition.
- 10.6 (B) B lymphocytes express MHC-I, MHC-II and CR2 irrespectively of their state of activation. Both activated T and B lymphocytes express the IL-2 receptor (CD25). In contrast, CD2 and its epitope associated with cell activation (CD2R) are expressed by T lymphocytes but not by B lymphocytes.
- 10.7 (A) The CD4 molecule identifies the helper T lymphocyte subpopulation, which delivers co-stimulatory signals to other T and B lymphocyte subpopulations.
- 10.8 (E) Before a productive VDJC rearrangement emerges, surrogate light chains are detectable on the cell surface of pre-B-I lymphocytes. The surrogate light chains are non-covalent associations of the product of two genes, Vpre-B and $\lambda 5$. These genes are turned off as the B cell develops productive rearrangements of H and L chain genes.
- 10.9 (A) Plasma cells apparently can differentiate both in the germinal centers of lymphoid organs and in the bone marrow, but resting B lymphocytes differentiate in the bone marrow.
- 10.10 (A) Gene rearrangement during the immune response are responsible for the "switch" between IgM and other isotypes during the immune response and are exclusive of the C region genes of the immunoglobulin heavy chains. The variable genes of L and H chains, on the other hand, undergo somatic hypermutations, responsible for the increasing affinity of antibodies during a sustained immune response.

APPENDIX: MAJOR LEUKOCYTE MARKERS

CD designation	Tissue distribution	Other names, function	Structural information
CD1	Cortical thymocytes, monocytes, DC	Evidence for a role in presentation of lipids and peptide antigen to T cells Homology to MHC antigens	IGSF
CD2	All T cells; NK cells	Coreceptor for LFA-3 adhesion, and signaling	IGSF
CD3	All T cells	Transducing unit for TCR	IGSF
CD4	Helper T cells, monocytes	Interaction with MHC-II	IGSF
CD5	All T cells; activated autoreactive B cells	B-lymphocyte autoreactivity	ITAM motif in cytoplasmic domain
CD7	Most T cells; NK cells; platelets	Function unknown; earliest antigen expressed in the T-cell lineage; expressed on pluripotent hematopoietic cells; marker for stem cell leukemias and T-cell acute lymphocytic leukemia	IGSF
CD8	Cytotoxic T cells; NK subset	Interaction with MHC-I	IGSF
CD10	Pre-B cells, early B and T precursors, granulocytes, bone marrow stromal cells, various epithelial cells	CALLA, neutral endopeptidase (NEP); marker of pre-B acute lymphocytic leukemia and certain lymphomas	Type II metalloprotease family
CD11a	Leukocytes	Cell adhesion molecule (LFA-1 α chain); CD54 coreceptor	Integrin
CD11b	Monocytes, granulocytes, NK cells	Mac1 cell adhesion molecule; complement receptor 3	Integrin
CD11c	Monocytes, granulocytes, NK cells, activated T cells	Cell adhesion molecule, p150/95, expressed on lymphoid cell lines and hairy cell leukemias	Integrin
CD16	Neutrophils, monocytes, most NK cells	Fc γ RIII (low affinity)	IGSF
CD18	Leukocytes	Cell adhesion molecule (LFA-1 β chain)	Integrin

continues

APPENDIX: Continued

CD designation	Tissue distribution	Other names, function	Structural information
CD19	All B cells	B lymphocyte signaling	IGSF, phosphorylation sites in cytoplasmic domain
CD20	Mature B cells; dendritic cells	Members of the FcεRIβ superfamily	Phosphorylation sites in cytoplasmic domain
CD21	Mature B cells; dendritic cells, T lymphocyte subset	Complement receptor 2; Epstein-Barr virus receptor; B-lymphocyte activation	Phosphorylation sites in cytoplasmic domain
CD22	B cells	Modulator of B lymphocyte activity	IGSF, ITIM motif in cytoplasmic domain
CD23	Activated B cells, eosinophils, platelets, and macrophages	FcεRII (low affinity)	
CD25	Activated T, B and NK cells, monocytes, subset of thymocytes	IL-2 receptor α chain, low-affinity chain	
CD26	Activated T cells and medullary thymocytes	Dipeptidylpeptidase IV	Type II membrane glycoprotein
CD28	T cells, plasma cells	T-B interactions and activation	IGSF
CD29	Leukocytes	β1-integrin, associates with CD49a-f to form VLA-1-VLA-6	Integrin
CD30	Activated T and B cells	T-cell co-stimulation, presence of Reed-Sternberg cells of Hodgkin's lymphoma; soluble CD30 found in serum of T-cell leukemias and associated with disease	TNF receptor superfamily
CD32	B cells, monocytes, granulocytes, platelets, placental endothelium	FcγRII (p40)	IGSF
CD33	Myeloid lineages, thymic immigrants, tripotential—T, NK, DC precursor	Absent on pluripotent stem cells; distinguished myeloid and lymphoid leukemias	
CD34	Hematopoietic stem cells	Binds L- and E-selectins; role in leukocyte endothelial interactions, lost upon lineage differentiation	

APPENDIX: Continued

CD designation	Tissue distribution	Other names, function	Structural information
CD35	Granulocytes, monocytes, dendritic cells, erythrocytes, B cells, T-cell subset	Complement receptor 1	Complement control proteins
CD38	Immature and activated mature T, B, NK, and monocytes	ADP-ribosyl cyclase, signaling induces proliferation on T and B cells and Tyr phosphorylation	Type II membrane glycoprotein
CD40	B cells	Binds to gp39 (CD40L) on activated helper T cell	TNF receptor superfamily
CD44	All leukocytes, epithelial, endothelial, and mesothelial, mesenchymal cells	Pgp-1, adhesion molecule mediates adhesion of lymphocytes to endothelium, stroma, and extracellularmatrix	
CD45	All leukocytes	Leukocyte common antigen	Cytoplasmic domain has tyrosine phosphatase activity
CD45RA	T lymphocyte subset, B and NK cells	Naive CD4 ⁺ cells	
CD45RB	T-cell subsets, B cells, granulocytes	Memory CD4 ⁺ cells	
CD45RO	Memory CD4 ⁺ cells	Binds to CD22 on B cells	
CD49a-f	T, B, NK cells, monocytes, platelets	α Integrin, associates with CD29 to form VLA-1-6	Integrin
CD53	T, B, monocytes, granulocytes, DC, osteoblasts, and osteoclasts	ICAM-3	IGSF
CD54	Leukocytes, epithelial cells	ICAM-1; upregulated during activation or inflammation; ligand for CD11a/18; rhinovirus receptor	IGSF
CD55	Hematopoietic cells, vascular endothelium, epithelia	Complement decay-accelerating factor (DAF)	Complement control proteins
CD56	NK cells, neural cells	Neural cell adhesion molecule (N-CAM); homotypic adhesion	IGSF
CD57	NK and T-cell subset	Binds P- and L-selectins, function not known	
CD58	Most hematopoietic cells including erythrocytes, fibroblasts, and epithelia endothelium,	Intercellular adhesion molecule (LFA-3), ligand for CD2	IGSF

continues

APPENDIX: Continued

CD designation	Tissue distribution	Other names, function	Structural information
CD62L	Expressed by most hematopoietic cells at some stage of differentiation, memory T and NK cell subset	L-selectin, LECAM-1, LAM-1	C-type lectin
CD64	Monocytes, macrophages, and dendritic cells; induced on neutrophils and eosinophils	Fc γ RI (high affinity)	IGSF
CD69	Activated lymphocytes	Activation-induced molecule	C-type lectin type II membrane superfamily
CD71	Activated lymphocytes and macrophages; proliferating cells	Transferrin receptor	Type II membrane glycoprotein
CD79 α, β	B cells	Ig $\alpha\beta$ part of the BCR	IGSF
CD80	Activated B cells; other APC	B7-1, interacts with CD28 and CTLA-4	IGSF
CD81	T, B, NK, DC macrophages eosinophils	TAPA-1, role in early T-cell development, induced B-cell adhesion	
CD86	Activated B cells; other APC	B7-2, interacts with CD28 and CTLA-4	IGSF
CD94	NK cells and a subset of T cells	Kp43, associated with NKG2 to form inhibitory receptor	C-type lectin type II membrane superfamily
CD95	Activated lymphocytes, monocytes, neutrophils, fibroblasts, and cell lines	Fas antigen; Apo-1, interacts with the Fas ligand (FasL); apoptosis signaling	TNF receptor superfamily
CD102	Broadly expressed on leukocytes and vascular endothelium	ICAM-2, major LFA-1 receptor of endothelium, T-cell co-stimulation	IGSF
CD117	Hematopoietic stem cells, mast cells	c-kit, stem cell growth factor receptor, steel factor receptor; expressed on myeloid leukemic cells	
CD122 CD132	NK and resting T cells Thymocytes, common lymphoid progenitor, T, B, NK, monocytes	IL-2 receptor β chain IL-2 receptor γ c chain; also a component of IL-4R, IL-7R, IL-9R, IL-15R; mutation causes X-linked severe combined immunodeficiency	
CD135	Hematopoietic stem cells	FLT3, binds FLT3 ligand	IGSF

APPENDIX: Continued

CD designation	Tissue distribution	Other names, function	Structural information
CD152	Activated T cells	CTLA-4, binds CD80 and CD86, homology with CD28	IGSF
CD153	Activated T cells and macrophages	CD30L, T-cell co-stimulation	TNF superfamily
CD154	Activated CD4 ⁺ T cells and a small population of CD8 ⁺ and $\gamma\delta$ T cells	CD40L; mutations cause hyper-IgM syndrome	TNF superfamily

BIBLIOGRAPHY

- Agrawal, A., Eastman, Q. M., Schatz, D. G. Transposition mediated by RAG1 and RAG2 and its implication for the evolution of the immune system. *Nature* 394:744, 1998.
- Arstila, T. P., Casrouge, A., Baron, V., et al. A direct estimate of the human ab T cell receptor diversity. *Science* 286:958, 1999.
- Banchereau, J., Bazan, F., Blanchard, D., et al. The CD40 antigen and its ligand. *Annu. Rev. Immunol.* 12:881, 1994.
- Barclay, A. N., et al. *The Leucocyte Antigen Facts Book*. New York: Academic Press, 1997.
- Blackman, M., Kapler, J., Marrack, P. The role of the T lymphocyte receptor in positive and negative selection of developing T lymphocytes. *Science* 248:1335, 1990.
- Colaco, C. *DC-Based Cancer Immunotherapy: The Sequel*. Cambridge, England: Quadrant Healthcare, 1999.
- Cornall, R. J., Cyster, J. G., Hibb, M. L., Dunn, A. R., Otipoby, K. L., Clark, G. C., Goodnow, C. C. Polygenic autoimmune traits: lyn, CD22 and SHP-1 are limiting elements of a biochemical pathway regulating BcR signaling and selection. *Immunity* 8:497–508, 1998.
- Garboczi, D. N., Ghosh, P., Utz, U., Qing, R. F., Biddison, W. E., Wiley, D. C. Structure of the complex between human T cell receptor, viral peptide and HLA-A2. *Nature* 384:134–141, 1996.
- Germain, R. N., Stefanova, I. The dynamics of T cell receptor signaling: complex orchestration and the key roles of tempo and cooperation. *Annu. Rev. Immunol.* 17:467, 1999.
- Ghia, P., Teb Boekel, E., Rolink, A. G., Melchers, F. B-cell development: A comparison between mouse and man. *Immunol. Today*. 19:480, 1998.
- Goldrath, A. W., Bevan, M. Selecting and maintaining a diverse T cell repertoire. *Nature* 402:255–262, 1999.
- Healy, J. I., and Goodnow, C. C. Positive versus negative signaling by lymphocyte antigen receptors. *Annu. Rev. Immunol.* 16:645, 1998.
- Jameson, S. C., Hogquist, K. A., Bevan, M. J. Positive selection of thymocytes. *Annu. Rev. Immunol.*, 13:93, 1995.
- Lanier, L. L. NK cell receptor. *Annu. Rev. Immunol.* 16:359, 1998.
- Long, E. O. Regulation of immune responses through inhibitory receptors. *Annu. Rev. Immunol.* 17:875, 1999.
- Palucka, K., and Banchereau, J. Linking innate and adaptive immunity. *Nature Med.* 5:868, 1999.
- Sbezda, E., Mariathasan, S., Ohteki, T., et al. Selection of the T cell repertoire. *Annu. Rev. Immunol.* 17:829, 1999.
- Spits, H., Blom, B., Jaleco, A., Weijer, K., Verschuren, M., van Dongen, J., Heemskerk, M., Res, P. Early stages in the development of human T, natural killer and thymic dendritic cells. *Immunol. Rev.* 165:75; 1998.

11

Cell-Mediated Immunity

Barbara E. Bierer, Jean-Michel Goust, and Gabriel Virella

I. INTRODUCTION

Immune responses have been traditionally subdivided into humoral (antibody-mediated) and cellular (cell-mediated) immune responses. As a rule, humoral (B-cell) immune responses function predominantly in the elimination of soluble antigens and the destruction of extracellular microorganisms, while cell-mediated (T-cell) immunity is more important for the elimination of intracellular organisms (such as viruses). This compartmentalization of the immune response is an oversimplification, and it is now clear that there is significant interplay between humoral and cellular arms of the immune response. The humoral response depends on lymphokine production (“help”) by T lymphocytes, while some types of cell-mediated effector mechanisms depend on antibodies for target selection. Nevertheless, this subdivision of the immune responses is useful because of its practical application.

II. T-CELL ACTIVATION

A. Initial Recognition of Antigen-Derived Peptides by T-Cell Receptors

Early observations showed that T lymphocytes couldn't respond to soluble, unmodified antigens to which B lymphocytes obviously respond with antibody synthesis. T cells recognize antigen-derived peptides associated to self MHC molecules (see Chapters 3 and 4). The tertiary structure of the oligopeptides generated as a consequence of processing by antigen-presenting cells (APCs) has no resemblance to the tertiary structure of the native antigen. In other words, T and B cells respond to very different structures of one given antigen.

The antigen-derived oligopeptides that fit into the binding sites of MHC-I or MHC-II molecules interact with T-cell receptors of different T-cell subpopulations. MHC-II-peptide complexes expressed on the surface of APC are recognized by the T-cell receptor of CD4⁺ lymphocytes, while MHC-I-peptide complexes expressed by a variety of cells are recognized by the T-cell receptor of CD8⁺ lymphocytes. The recognition of MHC-associated oligopeptides is the first step in T-cell activation. Other signals are required for efficient and complete T-cell activation. While the following discussion applies mostly to CD4⁺ cells, the general principles also apply to CD8⁺ cells, which have been less well studied.

B. Co-stimulatory Signals Essential for T-Cell Activation

Each T cell carries a unique TcR that recognizes only one MHC-antigen complex. This interaction delivers an antigen-specific signal, essential but not sufficient, for T-cell activation. Co-stimulatory signals are delivered by the APCs with which CD4 T cells establish strong adhesion interactions (Fig. 11.1). In the absence of co-stimulatory signals, TcR occupancy, by itself, induces T-cell unresponsiveness or anergy (see Chapter 18).

The delivery of co-stimulatory signals requires close interactions between helper and effector cells. Two sets of adhesion molecules (CD2/CD58 and LFA-1/ICAM-1) play a primary role in T lymphocyte-APC adhesion, allowing the proper delivery of co-stimulatory signals.

CD2 molecules expressed by essentially all T lymphocytes bind to CD58 (LFA-3) molecules expressed by most nucleated cells as well as by erythrocytes. The initial interaction between the MHC-peptide complex and the TcR causes a conformational change on the CD2 molecule that increases the affinity of CD2 for the CD58 molecule expressed by the APC. In addition to its role in stabilizing cell-cell contact, the interaction between CD2 and CD58 delivers an activating signal to the T lymphocyte.

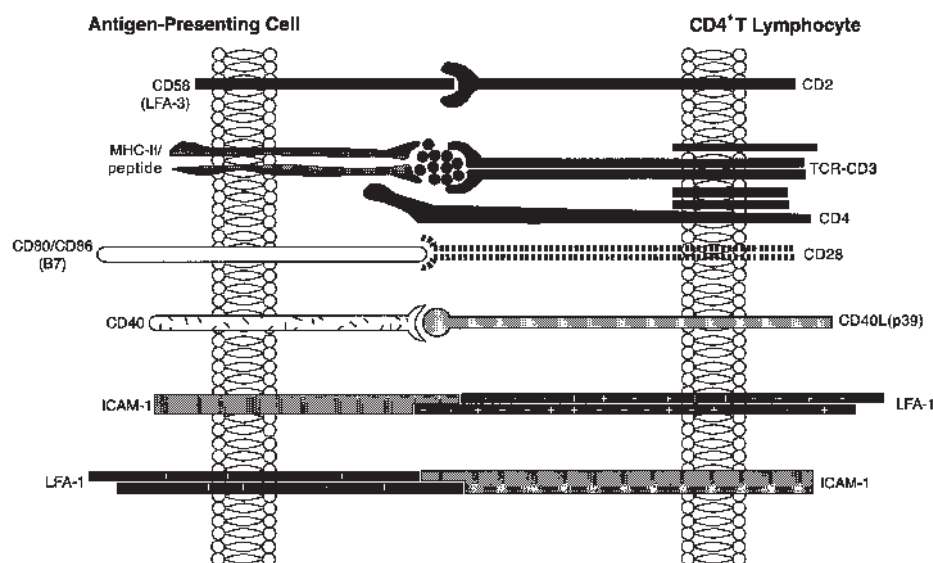

Fig. 11.1 Membrane proteins involved in the interaction between a CD4⁺ T lymphocyte and an antigen-presenting cell (APC).

The leukocyte function antigen-1 (LFA-1) molecule that interacts with the intercellular adhesion molecule 1 (ICAM-1) also undergoes conformational changes in the early stages of T-cell activation. Both APC and T cells express LFA-1 and ICAM-1, and the heterotypic interaction between pairs of these molecules results in the formation of strong intercellular bonds.

The CD4 molecule on the lymphocyte membrane interacts with nonpolymorphic areas of the class II MHC molecules on the APC. This interaction may not only help stabilize the contact between MHC-II and TcR but is also involved in signal transduction in the early stages of T-lymphocyte activation, as discussed later in this chapter.

The establishment of APC–T-lymphocyte interactions brings the membranes of the two cells into close proximity. Such close contact is critical for the delivery of additional activating signals to the T cell and allows for high local concentrations and maximal effects of the interleukins and cytokines released by APC and T lymphocytes. Some of the most significant costimulatory signals result from cell-cell interactions mediated by membrane proteins, such as those involving the interactions between CD28 and B7 family members and between CD40L and CD40. Others involve cytokines, such as interleukin-1 (IL-1), interleukin-6 (IL-6), interleukin-12, and tumor necrosis factor- α (TNF- α), released by APCs activated as a consequence of ingestion and processing of immunogenic substances. These interleukins provide essential signals necessary for the proliferation of antigen-primed T lymphocytes, acting as cofactors in early T-cell activation.

C. Intracellular Events Associated with the Activation of CD4⁺ T Lymphocytes

When the adequate complement of activating signals is delivered to a CD4⁺ T lymphocyte, a cascade of intracellular signals is triggered. The activation sequence can be divided into two distinct phases.

1. From TcR Occupancy to Interleukin-2 Gene Expression

As discussed in Chapters 4 and 10, the TcR heterodimer itself has no recognizable kinase activity. The associated CD3 complex, however, has at least 10 intracytoplasmic motifs (ITAMs) that are believed to play a key role in the activation sequence, particularly the ζ -chain-associated ITAMs. Several tyrosine and serine/threonine kinases have been proposed to play a role in T-lymphocyte activation (Fig. 11.2).

The src-related tyrosine kinase p56^{lck}, which is noncovalently associated with the cytoplasmic domains of CD4 and of CD8, is apparently activated by dephosphorylation mediated by CD45, a tyrosine phosphatase constitutively expressed on all hematopoietic cells. Although the molecular details are not well understood, it is known that CD45 is linked to the TcR and any signal leading to TcR clustering after interaction with several MHC-peptide complexes activates CD45 phosphatase activity.

In addition to p56^{lck} activation, a second src-related tyrosine kinase, p59^{fyn}, is activated by CD45. p59^{fyn} is associated with the ϵ chain of the CD3 molecule after TcR occupancy.

The activation of p56^{lck} and of p59^{fyn} is followed by phosphorylation of tyrosine residues in the ITAMs of the CD3 ζ chains. The phosphorylation of CD3 ζ ITAMs is followed by recruitment and activation of a third tyrosine kinase, the ZAP70 kinase.

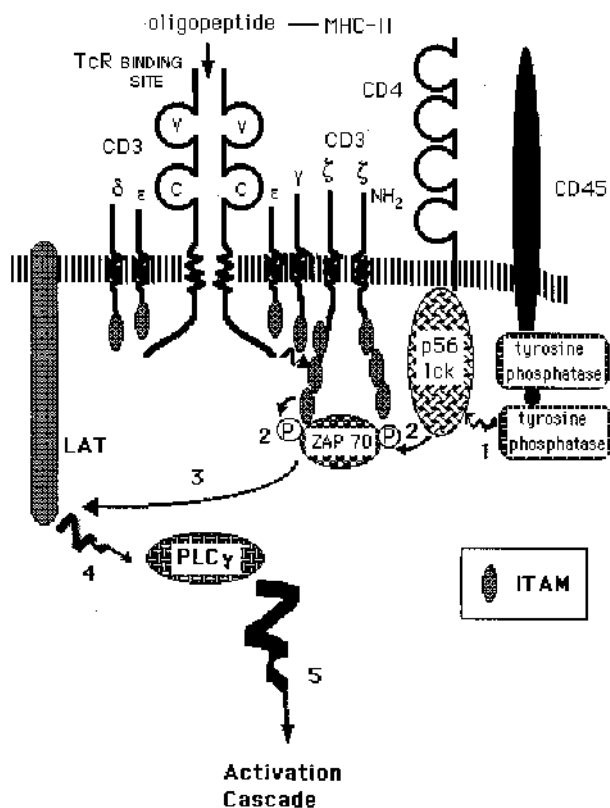

Fig. 11.2 Sequence of events during the initial stages of T-cell activation. Antigen occupancy of the TcR induces modifications of the CD45 transmembrane protein. These modifications result in activation of its tyrosine phosphatase activity; one of the substrates of CD45 is a p56^{lck} tyrosine kinase. Dephosphorylation of p56^{lck} results in its enzymatic activation. Activated p56^{lck} as well as the activated ITAMs of the ζ chain of the TcR complex contribute to the phosphorylation of ZAP70. This is followed by phosphorylation of the linker of activator T cells (LAT), which in turn will activate phospholipase C and other substrates involved in cell activation. The phosphorylation of phospholipase C is followed by activation and translocation to the cell membrane, resulting in rapid membrane inositol turnover and generation of inositol-1,4,5-triphosphate (IP3) and diacylglycerol (DAG). Other steps in the activation cascade that regulates cellular gene expression follow these events.

The activation of ZAP70 leads to subsequent phosphorylation and activation of additional substrates, including MAP kinase and phospholipase C γ (PLC- γ). Apparently as a consequence of PLC- γ activation, membrane phosphoinositols are hydrolyzed yielding two potential intracellular second messengers. One of these messengers is inositol-1,4,5-triphosphate (IP3), responsible for a sharp rise in intracellular ionized calcium concentration by mobilizing Ca^{2+} from intracytoplasmic stores. The rise in Ca^{2+} allows activation of the calcium- and calmodulin-dependent serine/threonine phosphatase calcineurin. The second is diacylglycerol (DAG), responsible for the activation of protein kinase C (PKC).

Other pathways of phosphoinositol hydrolysis resulting from the engagement of co-stimulatory molecules are being intensively studied. One that has received considerable attention involves the activation of a PI3 kinase, triggered as a consequence of the engagement of the CD28 molecule on the T-cell membrane by its ligand (CD80), constitutively expressed on the membrane of APCs.

Once these kinases are activated, transcription factors need to be activated in order to induce the expression of a large number of molecules that control T-cell proliferation. These molecules are not expressed by resting T cells, and their genes must be transcribed *de novo*. Over 70 genes are expressed in a characterizable sequence starting minutes after activation of a helper cell and continuing for the next several days. Those genes encode critical transcription factors, enzymes, and substrates involved in proliferation, differentiation, and effector function.

If the signaling cascade is interrupted or the synthesis of new genes is halted, the immune response will be perturbed. If no IL-2 is produced, T cells cannot proliferate and the immune response fails to develop. In some instances the lack of IL-2 synthesis results in T-lymphocyte anergy, i.e., inability to mount an active immune response after proper stimulation. In other cases, improperly activated T lymphocytes undergo apoptotic cell death consequent to the expression of alternate sets of apoptosis-inducing genes.

A major determinant of the ultimate fate of an activated T cell is believed to be the level of expression of anti-apoptotic genes, such as Bcl-2. When the cells are productively activated, these genes are upregulated and the cells proliferate. If, however, Bcl-2 and related genes remain downregulated, apoptotic stimuli will proceed unchecked.

Among the well-characterized transcription factors involved in T-cell activation, the following deserve special mention:

Nuclear factor κ B (NF- κ B) is a DNA-binding protein found complexed with a specific inhibitor (I κ B) in the cytoplasm of resting T lymphocytes. After phosphorylation by a I κ B kinase, I κ B is destroyed and the untethered NF- κ B moves into the nucleus, where it binds to the promoters of many genes, including the IL-2 receptor gene and the *c-myc* gene, mediating their transcriptional activation (Fig. 11.3). Additionally, NF- κ B activation is essential for the prevention of apoptotic cell death.

Nuclear factor of activated T cells (NF-AT1) is almost exclusively found in hematopoietic cells. NF-AT1 binds to regions of specific DNA sequences, found in the 5' promoter region of most cytokine genes. Two components are required to form a complex capable of transcriptional activation: NFAT-1 and AP-1.

An inactive phosphorylated form of NF-AT1 is located in the cytoplasm of resting T cells. This form is activated by dephosphorylation catalyzed by a calcium-dependent serine/threonine phosphatase known as calcineurin. Upon activation, NFAT-1 translocates into the nucleus, where it becomes associated with AP-1.

AP-1 is a nuclear protein induced when T cells are stimulated via the TcR plus ancillary signals mediated by IL-1 or by CD28 cross-linking. It is formed by the association of two proto-oncogene products, c-Fos and c-Jun, whose synthesis is activated by PKC. The cytoplasmic form of c-Jun is activated by a specific kinase (c-Jun N terminal kinase). c-Fos is activated by substrates of the MAP kinase pathway, including Elk. c-Fos and c-Jun form a complex known as the

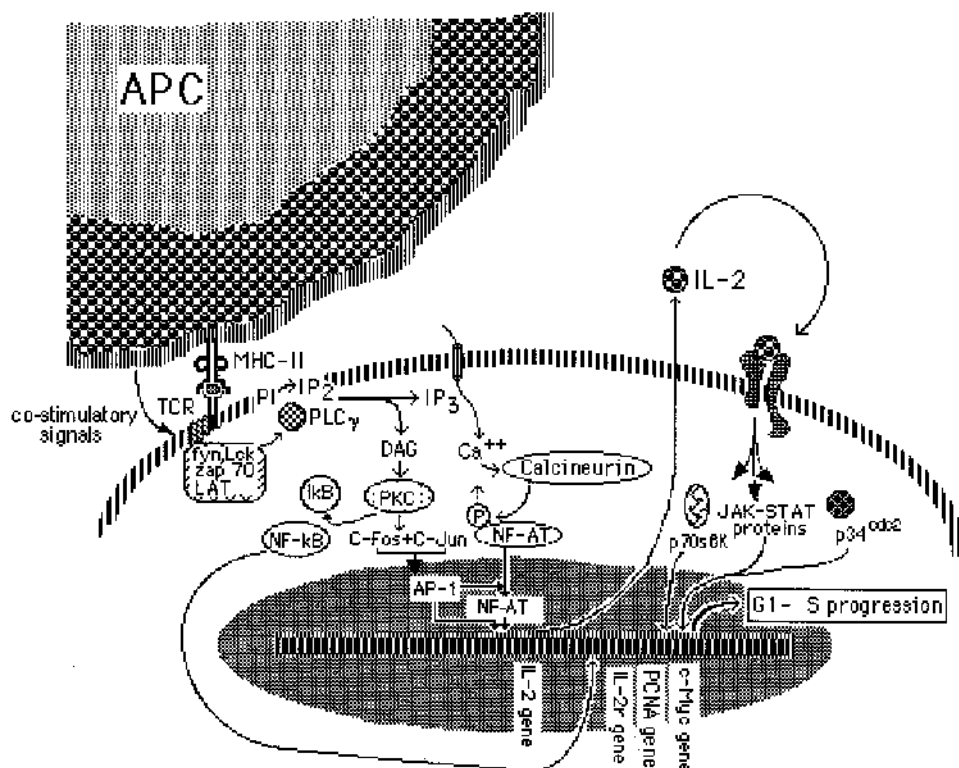

Fig. 11.3 Diagrammatic representation of a simplified second messenger cascade involved in T-lymphocyte activation. After the sequence of events illustrated in Figure 11.2 takes place, two important enzymes are activated. Calcineurin, a serine/threonine phosphatase, dephosphorylates and activates the cytoplasmic component of the nuclear factor of activated T cells (NF-AT). A complex of NF-AT and calcineurin translocates to the nucleus, where it forms a complex with AP-1, and this complex activates the expression of the IL-2 gene. Protein kinase C is also activated and the active form has at least two critical effects: (1) It promotes the association of c-Fos and c-Jun into AP-1, which translocates to the nucleus. In the nucleus AP-1 binds directly to the IL-2 gene enhancer region and combines with NF-AT to form the active form of NF-AT that synergizes with AP-1, enhancing the expression of the IL-2 gene. (2) PKC activates a kinase that causes the dissociation of the complex formed between the nuclear factor kB (NF-kB) and its inhibitory protein (IkB). The activated NF-kB then translocates to the nucleus where it enhances the expression of several genes, including the one encoding the IL-2 receptor. The phosphorylated adaptor protein LAT triggers additional signaling pathways, including the Ras pathway, which results in Raf, Mek, and ERK activation. The activation of these pathways results in transcriptional activation of cytokine and other genes and other activation genes leading to progression from G0 to G1. Additional signals are required for progression to S1. Synthesis and release of IL-2 associated with increased expression of the IL-2 receptor creates the conditions necessary for such progression. The occupancy of the IL-2 receptor is followed by activation of protein kinases and diacylglycerol kinase, followed by the activation of several transcription factors of the JAK-STAT (signal transducers and activators of transcription) family, and increased transcription of proteins controlling cell proliferation, such as the proliferating-cell nuclear antigen (PCNA), an obligate cofactor of DNA polymerase delta, an enzyme that itself plays a significant role in DNA replication, and c-Myc, which controls cell proliferation.

AP-1 transcription factor, which diffuses into the nucleus, where it binds to many DNA sequences including those close to the NF-AT-1-binding site. The full expression of cytokine and cytokine receptor genes is controlled by promoter sequences recognized by NF- κ B and/or by the complex of NFAT-1 and AP-1. Their occupancy by these transcription factors is essential for control of their expression during T-cell activation.

2. *IL-2 Synthesis and T-Lymphocyte Proliferation*

Two critical early events in T-cell activation are the appearance of mRNAs for interleukin-2 (IL-2) and for the IL-2 receptor (IL-2R) in the cytoplasm. The upregulation of the IL-2 gene, an essential step for T-cell proliferation at the onset of the immune response, requires occupancy of the promoter region by NF-AT/AP-1/NF- κ B complexes. The expression of the IL-2 receptor, on the other hand, seems to be primarily controlled by NF- κ B. The release of IL-2 into the cellular environment of activated T cells expressing IL-2 receptors has significant biological consequences.

Autocrine and Paracrine Effects of IL-2. IL-2 stimulates lymphocyte proliferation in both autocrine and paracrine loops. Autocrine stimulation involves release of IL-2 from an activated T cell and binding and activation of IL-2 receptors expressed by the same T cell. Paracrine stimulation is likely a consequence of IL-2 overproduction after persistent stimulation of CD4⁺ T cells. The released IL-2 exceeds the binding capacity of the IL-2 receptors expressed by the producing cell and can stimulate other nearby cells expressing those receptors. The targets of the paracrine effects of IL-2 are helper T lymphocytes, cytotoxic T lymphocytes, B lymphocytes, and NK cells, all of which express IL-2 receptors of varying affinities.

The IL-2 Receptor. The IL-2R expressed by T and B lymphocytes is composed of three different polypeptide chains.

1. CD25, a 55 kDa polypeptide chain (IL-2R α chain), is expressed at very low levels in about 30% of the circulating (nonactivated) T cells but is sharply upregulated a few hours after activation. CD25 binds IL-2 with low affinity and has a short intracytoplasmic domain unable to transduce growth signals upon binding to its ligand.
2. The IL2R β chain is a 70–75 kDa polypeptide chain expressed by resting T lymphocytes. The IL-2R α/β heterodimer has an increased affinity for IL-2. The β chain appears capable of signal transduction, as its intracytoplasmic domain is 286 amino acids long. In addition, engagement of α/β dimers results in the recruitment of γ chains, forming the high-affinity IL-2R.
3. The IL2R γ chain, or γ_c , is the third polypeptide chain that constitutes the trimeric IL-2 receptor and is expressed after T-cell activation. This chain has also a long intracytoplasmic segment and is therefore structurally suited to transmit activation signals. The γ_c chain is shared by a number of cytokine receptors, including those for IL-2, IL-4, IL-7, IL-9, and IL-15.

Consequences of the Binding of IL-2 to the IL-2 Receptor on an Activated T Cell. The binding of IL-2 to the trimeric high-affinity IL-2 receptor induces the association of the IL-2R to the src-related p56^{lck} tyrosine kinase and to other specific tyrosine kinases of the JAK family. The end result is the phosphorylation of transcription factors of the STAT family, which dimerize after phosphorylation and then translocate to the nucleus.

In the nucleus, activated STAT factors upregulate the expression of genes coding for cytokine receptors and induce the appearance of cyclins. As a consequence, the cell enters into S phase (see Fig. 11.3).

Progression to Mitosis: Requirement for Co-stimulatory Signals. IL-2 synthesis and IL-2R expression are sustained for about 48 hours and subsequently downregulated. Persistent IL-2 gene expression, however, is required to sustain the proliferation drive. This requires additional signals delivered by other molecules, particularly those resulting from CD86-CD28 interactions. Twelve hours after effective T-cell stimulation by APC, CD86 (B7-2)—a molecule related to CD80 (B7-1)—becomes expressed on the APCs, probably as a consequence of autocrine cytokine stimulation. CD86 activates T cells through interaction with a membrane protein known as CD28. The interaction between CD86 and CD28 results in the synthesis of a set of DNA-binding proteins that appear to block the rapid decay of the IL-2 mRNA and induce members of the anti-apoptotic Bcl-2 gene family. If the CD80/86-CD28 interaction is inhibited, T cells will become anergic, i.e., unresponsive to subsequent stimulation.

T lymphocyte Proliferation and Differentiation. Even when co-stimulatory signals are delivered, IL-2 synthesis and IL-2R expression are sustained for about 48 hours and are subsequently downregulated. However, the T cell is committed to cell division within 8 hours of IL-2 interacting with IL-2R. After commitment, even if all triggering signals are withdrawn, the T cell will divide. Clonal expansion of antigen-specific CD4⁺ T lymphocytes takes place as a consequence of sustained activation through the IL-2 receptor.

It is estimated that the initial helper T-lymphocyte population is capable of expanding 100-fold in 6 days, reaching more than 1000-fold its starting number by day 10, the time that it takes to elicit a detectable primary immune response to most infectious agents. This expansion results in the differentiation not only of the short-lived effector cells needed for the ongoing immune response but also of long-lived memory cells. Following such rapid and robust T-cell expansion, many of the activated effector cells will undergo apoptosis. However, when the immune response subsides, an expanded population of memory T cells will remain and will be able to assist the onset of subsequent responses to the same antigen with greater efficiency and speed, which is characteristic of an anamnestic (memory) response.

D. Cytokines and Chemokines

One of the most remarkable consequences of the activation of CD4⁺ T cells is the synthesis of cytokines, soluble molecules that deliver activating or inhibitory signals to other leukocyte populations. A special subset of cytokines is the interleukins, of which 23 different ones have been characterized. Although activated CD8⁺ cells may produce some cytokines, and APCs themselves produce others, CD4⁺ T cells are their major source. The biological effects of cytokines and chemokines are extremely diverse: they influence not only the immune response but also inflammatory processes and hematopoiesis (Table 11.1).

1. Pro-inflammatory Cytokines

The group of soluble factors that influence inflammatory reactions includes interleukin-1 (IL-1), tumor necrosis factor (TNF, also known as cachectin), interferon- γ , interleukin-6 and -8, and migration inhibition factor (MIF). IL-1 and TNF have membrane-associated

Table 11.1 Major Interleukins and Cytokines

Interleukin/ cytokine	Predominant source	Main targets	Biological activity
IL-1 α , β	Macrophages, monocytes, & other cell types	T & B lymphocytes	Stimulates T cells; activates several types of cells; pro-inflammatory mediator; pyrogen
IL-2	T _H 0, T _H 1 lymphocytes	T & B lymphocytes	Activates T cells and B cells
IL-3	T lymphocytes, mast cells	Hemopoietic stem cells; basophils	Hematopoietic growth factor; chemotactic for basophils
IL-4	T _H 2 lymphocytes, macrophages	B lymphocytes, T _H 1 lymphocytes, macrophages	Growth and differentiation factor for B lymphocytes; promotes IgE synthesis
IL-5	T _H 2 lymphocytes, macrophages	Eosinophils, lymphocytes	Chemotactic and activating factor for eosinophils; lymphocyte activation
IL-6	B & T lymphocytes, macrophages	B & T lymphocytes, others	B-cell differentiation factor; polyclonal B-cell activator; pro-inflammatory mediator; pyrogen
IL-7	Bone marrow, thymic epithelium	Pro-lymphocytes (B and T)	Lymphoid cell growth factor; promotes T-cell differentiation (thymic and extrathymic)
IL-8	Macrophages	Neutrophils, T lymphocytes	Neutrophil and T-lymphocyte chemotactic factor
IL-9	Thymocytes, T lymphocytes	Hematopoietic stem cells	Hemopoietic growth factor
IL-10	T _H 2 lymphocytes	B lymphocytes, T lymphocytes	Inhibits cytokine synthesis; activates B lymphocytes
IL-11	Mesenchymal cells	Hematopoietic stem cells	Induces megakaryocyte proliferation
IL-12	Macrophages, B lymphocytes	T _H 1 lymphocytes, NK cells	Natural killer cell stimulating factor; T _H 1 lymphocyte activation and proliferation; enhances the activity of cytotoxic cells
IL-13	Activated T lymphocytes	B lymphocytes, monocytes	Promotes immunoglobulin synthesis; induces the release of mediators from basophils and mast cells; suppresses monocyte/ macrophage functions
IL-14	T lymphocytes	B lymphocytes	B-cell growth factor
IL-15	Monocytes/ macrophages	T lymphocytes, NK cells, B lymphocytes	Lymphocyte and NK cell growth factor; chemotactant for T lymphocytes

Table 11.1 Continued.

Interleukin/ cytokine	Predominant source	Main targets	Biological activity
IL-16	CD8 ⁺ T lymphocytes	CD4 ⁺ T lymphocytes	Chemotactic factor; T-cell growth factor; activates CD4 ⁺ T lymphocytes
IL-17	Activated T lymphocytes	Multiple	Pro-inflammatory; promotes osteoclast activation and PMN recruitment
IL-18	Dendritic cells, macrophages	Multiple	Pro-inflammatory; induces interferon- γ
GM-CSF	T _H 2 lymphocytes	Hematopoietic stem cells	Promotes proliferation and maturation of granulocytes and monocytes
IFN α/β	Leukocyte, fibroblast	Lymphocytes	NK activator; pro-inflammatory
IFN γ	T _H 1 lymphocytes	Multiple	Macrophage and NK activator
TNF (cachectin, TNF α)	APCs, CD4 ⁺ T cells	Multiple	Cytotoxic for some cells; cachexia; septic shock mediator; B-lymphocyte activator
LT- α (lymphotoxin, TNF β)	T & B lymphocytes	Restricted	Cytotoxic for some cells; PMN and NK activation

and secreted forms and seem to be directly or indirectly responsible for the systemic metabolic abnormalities and circulatory collapse characteristic of shock associated with severe infections. The main biological functions of these two cytokines are listed in Table 11.2.

IL-1 exists in two molecular forms, IL-1 α and IL-1 β , encoded by two separate genes and displaying only 20% homology to one another. In spite of this structural difference, both forms of IL-1 bind to the same receptor and share identical biological properties. IL-1 α tends to remain associated to cell membranes, while IL-1 β , synthesized as an inactive precursor, is released from the cell after being processed posttranslationally by a cysteine-asparagin protease (caspase-1 or interleukin-converting enzyme, ICE).

IL-1 and TNF (Table 11.2) have effects at three different levels:

1. *Metabolic effects:* IL-1 and TNF induce the synthesis of many proteins such as α_1 -antitrypsin, fibrinogen, and C-reactive protein in the liver. These proteins are known generically as acute phase reactants, because of their increase in situations associated with inflammatory reactions. In cases of prolonged and severe infections, protracted TNF production may result in negative protein balance, loss of muscle mass, and progressive wasting (cachexia).
2. *Vascular effects:* IL-1 β and TNF cause the upregulation of cell adhesion molecules, particularly P-selectin and E-selectin, in vascular endothelial cells. This upregulation promotes the adherence of inflammatory cells, which eventually egress to the extravascular space, where they form tissue inflammatory infiltrates. One of the possible consequences of the adherence of activated en-

endothelial cells and inflammatory cells is endothelial cell damage. This is a major component of gram-negative septic shock and of toxic shock syndrome, both dramatic examples of the adverse effects of massive stimulation of cells capable of releasing excessive amounts of interleukins (see Chapter 13).

3. *Central nervous system effects:* IL-1 does not cross the blood-brain barrier but acts on the periventricular organs where the blood-brain barrier is interrupted. It interacts with a group of nuclei in the anterior hypothalamus, causing fever (secondarily to stimulation of prostaglandin synthesis) and sleep, and increases the production of ACTH.

Interleukin-6 (IL-6), synthesized primarily by monocytes, macrophages, and other antigen-presenting cells, has pro-inflammatory and hematopoietic activities. Its role as a pro-inflammatory cytokine is similar to those of IL-1 and TNF, particularly in the induction of the synthesis of acute phase response proteins by the liver.

2. Cytokines with Predominant Immunoregulatory Functions

Interferon- γ (IFN- γ), produced by CD4⁺ cells and NK cells, has a wide range of effects. In concert with IL-1 β , it induces an increase in the expression of ICAM-1 on the cytoplasmic membrane of endothelial cells, enhancing T-lymphocyte adherence to the vascular endothelium, an essential first step for T-lymphocyte egress from the vascular bed. Large numbers of T lymphocytes will thus exit the vascular bed in areas near the tissues where activated T cells are releasing interleukins and will form perivenular infiltrates characteristic of delayed hypersensitivity reactions.

The most important effect of IFN- γ seems to be the activation of monocytes. After exposure to IFN- γ , monocytes undergo a series of changes typical of their differentiation into phagocytic effector cells:

1. The cell membrane becomes ruffled; the number of cytoplasmic microvilli increases by a factor of 10. This change reflects a considerable increase in phagocytic capacities.
2. The expression of MHC class II antigens and Fc γ receptors increases. The in-

Table 11.2 Cellular Sources and Biological Effects of IL-1 and TNF

	IL-1	TNF
Cellular source	Monocytes, macrophages, and related cells	Monocytes, macrophages, and related cells; CD4 ⁺ T lymphocytes
Biological property		
Pyrogen	+	+
Sleep inducer	+	+
Shock	+	+
Synthesis of reactive proteins	+	+
T-cell activation	+	+
B-cell activation	+	+
Stem cell proliferation and differentiation	+	-

crease in the expression of MHC-II enhances the efficiency of monocytes as antigen-presenting cells, and the increased expression of Fc receptors further enhances their efficiency as phagocytic cells.

3. The production of cytokines (TNF, IL-12) and of several antimicrobial proteins and compounds [including defensins, cathepsins, collagenases, superoxide radicals, and inducible nitric oxide synthase (iNOS)] is upregulated. As a consequence, engulfed organisms are rapidly killed and ingested proteins are efficiently digested in the phagolysosomes. It must be noted that excessive and protracted production of IFN- γ may have adverse effects. Hyperstimulated monocytes may become exceedingly cytotoxic and may mediate tissue damage in inflammatory reactions and autoimmune diseases.

Interleukin 12 is produced by APCs after endocytosis of particulate materials or microbes and plays a crucial role in linking innate and adaptive immunity. IL-12 induces the production of IFN- γ by CD4⁺ T cells and NK cells at the early stages of the immune response, before the differentiation of effector T cells.

Interleukin 18, a recently discovered interleukin, was initially named interferon- γ -inducing factor, reflecting its major biological role. In many respects it is similar to IL-1 and IL-12. IL-18 is produced and released by APCs, and its main targets are T_H0/T_H1 CD4⁺ T cells and NK cells.

3. Chemokines

This designation is given to a group of cytokines with chemotactic properties. They are divided into two major groups, α and β , depending on their tertiary structure. In the α chemokines one amino acid separates the first two cysteine residues (Cys-X amino acid-Cys) and for that reason are also known as CXC chemokines. In β chemokines the first two cysteine residues are adjacent to each other and for that reason are also known as CC chemokines.

Interleukin-8 (Neutrophil-Activating Factor) is the most important of the α chemokines. It is released by T lymphocytes and monocytes stimulated with TNF or IL-1. It functions as a chemotactic and activating factor for granulocytes, the cell population with the highest level of IL-8 receptor expression. IL-8 recruits granulocytes to areas of inflammation and increasing their phagocytic and pro-inflammatory abilities. It has also been demonstrated to be chemotactic for T lymphocytes.

β Chemokines include four major cytokines, which act predominantly on mononuclear cells, the cells that predominantly express the receptors for this group of cytokines:

1. RANTES (regulated on activation, normal T-cell expressed and secreted), released by T cells, attracts T cells with memory phenotype, NK cells, eosinophils, and mast cells.
2. Macrophage inflammatory proteins (MIP), released by monocytes and macrophages, attract eosinophils, lymphocytes, and NK and LAK cells.
3. Macrophage chemotactic proteins (MCP), produced by monocytes, macrophages, and related cells, attract monocytes, eosinophils, and NK and LAK cells.
4. Eotaxin, a chemokine induced by IL-4 that recruits eosinophils and TH2 CD41 T cells to the sites of allergic inflammation.

Other cytokines and peptides with chemotactic activity, but structurally different from classical chemokines, have also been characterized. Migration-inhibition factor (MIF), the

structure of which is not fully known, is released by T cells, monocytes, and macrophages and keeps macrophages in the area where the reaction is taking place and contributes to their activation, promoting the release of TNF. Recently it has been found that endotoxin stimulates the release of MIF by the pituitary gland, and its release seems associated with increased mortality in the post-acute phase of septic shock. β -Defensins, released primarily by granulocytes, have also been characterized as chemotactic for T lymphocytes.

4. *Interleukins and Hematopoiesis*

Several different interleukins and cytokines have significant hematopoietic effects, promoting the proliferation and differentiation of various cell types.

Interleukin-1 (IL-1), acting as a growth factor on the bone marrow, is a major factor leading to the general mobilization of leukocytes, objectively reflected by peripheral blood leukocytosis, characteristic of bacterial infections.

Granulocyte-macrophage colony-stimulating factor (GM-CSF), released by activated T lymphocytes, stimulates granulocyte and monocyte production and release from the bone marrow. It also stimulates monocyte cytotoxic activity and expression of MHC-II molecules, dendritic cell proliferation and differentiation, and B-cell proliferation and differentiation (at least in vitro).

Interleukin-3 (IL-3) and stem cell factor, both released principally by activated T lymphocytes, are important growth factors for early bone marrow progenitors, inducing production of a wide variety of leukocytes.

Interleukin-6 (IL-6) promotes the differentiation of B-lymphocyte precursors as well as the differentiation of T-lymphocyte precursors into cytotoxic T lymphocytes.

Interleukin-7 (IL-7) is produced in the bone marrow, thymus, and spleen. Its main role seems to be to induce the proliferation of B- and T-lymphocyte precursors. In the thymus, IL-7 drives pre-T-cell differentiation into double positive CD4/CD8⁺ T-cell precursors. In the periphery, IL-7 seems to play a key role promoting the expansion of antigen-stimulated T cells. The molecular mechanisms for this effect on T-cell expansion seems linked to the upregulation of the expression of bcl-2 and related genes, whose products protect the cell against apoptotic death.

5. *Cytokine Genes and Structure*

The precise role of individual cytokines in the immune and inflammatory responses is difficult to determine because the same cells produce so many cytokines, and each cytokine can exert different and overlapping effects on multiple targets. Shared biological effects cannot be explained by structural similarities between molecules. However, many cytokine receptors activate different but overlapping sets of protein kinases and other signaling molecules. In addition, several interleukin genes appear to be regulated by the same set of nuclear binding proteins, and several interleukin receptors are structurally similar. These may be keys to understanding the plurality of interleukin responses and apparent redundancy of effects among structurally different interleukins.

While interleukin genes differ from each other in their coding sequence, they have >70% homology in their untranslated 5' region, suggesting the use of common transcription factors, such as NF-AT. In addition, the mRNA transcripts have many AUUUA repeats near the 3' end that, in part, determine the rapid rate of mRNA decay. The expression of interleukin genes, therefore, is generally very transient but may be more prolonged de-

pending on the activating signals received by the cell. Increased stability of interleukin mRNAs is observed after calcineurin phosphorylation and after CD28 engagement.

In spite of the diversity of interleukin genes, all monomeric interleukins have similar tertiary structure: at least four α helices arranged in pairs of parallel symmetry, each pair being anti-parallel relative to the other. The α helices are joined by connecting loops that contain β helical sheets of variable length. The helix located near the aminoterminal end is the one that interacts with the cytokine receptor.

6. Cytokine Receptors

Cytokine receptors can be grouped into several families depending on structural characteristics (Fig. 11.4). Upregulation of a given subunit of these receptors is often a consequence of cellular activation and usually results in the expression of a high-affinity receptor able to transduce activation signals. The activation pathways triggered after receptor occupancy tend to be similar for receptors of the same family but differ for receptors of different families. The fact that several cytokines may share a given receptor explains why some biological properties are common to several interleukins.

The most common type of receptor is the lymphokine receptor family, formerly known as the hemopoietin-receptor family, because it was initially characterized as the erythropoietin receptor. The receptors of this family are heterodimers or heterotrimers and always include an α and a β chain, the latter with a longer intracytoplasmic segment and signaling functions. The receptors for IL-2, IL-3, IL-4, IL-5, IL-6, IL-7, IL-9, IL-15, and GM-CSF are included in this family. Some of them share subunits:

1. Receptors for IL-2, IL-4, IL-7, IL-9, and IL-15 share a third chain (γ_c), which plays a significant role in signal transduction. One of the forms of severe combined immunodeficiency is secondary to abnormalities in the γ -chain gene (see Chapter 29).
2. Receptors for IL-3, IL-5, and GM-CSF share a common β chain. A different β chain is shared by the receptors for IL-6 and IL-11.

Other receptor families include:

1. The tumor necrosis factor receptor family, including receptors for TNF, lymphotoxin- α (LT- α , TNF β), CD40, tumor necrosis factor-related activation-induced cytokine (TRANCE), and Fas. There are two types of TNF receptor: TNFR-1 and TNFR-2. TNFR-1 and CD40 both have "death domains" associated with the induction of apoptosis (see below) in their intracytoplasmic tails. Engagement of TNFR-1, however, does not necessarily trigger cell death, because an anti-apoptotic pathway leading to NF- κ B synthesis is simultaneously triggered; the balance between pro-apoptotic and anti-apoptotic signals dictates the choice between proliferation and apoptosis. In contrast, the engagement of TNFR-2 usually results in cell activation.
2. The immunoglobulin superfamily receptors, which include the IL-1 (α and β) and IL-18 receptors, a receptor for colony-stimulating factor 1, and, as a special subfamily, the interferon receptors.

The interferon receptors are constituted by two different chains. In the resting state the two chains are loosely associated with kinases, including members of the JAK family. After occupancy with interferon, one or two members of the STAT family of transcription factors undergo phosphorylation and translocation

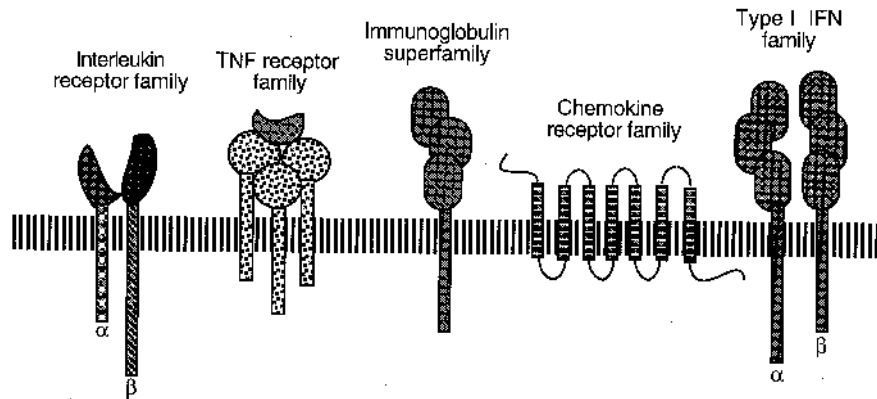

Fig. 11.4 The main families of cytokine receptors.

into the nucleus. The JAK-STAT system is polymorphic. There are three known JAK kinases and seven STAT transcription factors. The STAT-1 transcription factor is predominantly involved in signaling after occupancy of interferon receptors. Its biological significance is underlined by the results of inactivating the encoding gene in mice. The STAT-1-deficient mice do not respond to interferons and are highly susceptible to bacterial and viral infections.

3. The chemokine receptor family, whose common feature is seven transmembrane domains and include receptors for IL-8, platelet factor-4 (PF-4), RANTES, and macrophage chemotactic and activating proteins.

III. INACTIVATION OF T-CELL RESPONSES

Normal immune responses are tightly regulated. As the goal of the immune response (elimination of nonself) is achieved, downregulatory systems become operative and turn off the response. Two main downregulating systems able to turn off T cells have been described.

The best known of the two involves an alternative ligand for CD80/CD86, CTLA-4. In vitro this ligand is expressed 48–72 hours after exposure of T cells to activating signals. The interaction of CD80/CD86 with CTLA-4 results in inhibition of early TcR signaling events. This blocking seems associated with direct binding of CTLA-4 to the TcR ξ chain, which results in recruitment of a tyrosine phosphatase known as SHP-1. SHP-1 appears to dephosphorylate the protein kinases (particularly ZAP-70) involved in the activation pathway controlling the assembly of functional NF-AT/AP-1 complexes. In the absence of those complexes, the IL-2 gene will cease to be expressed. The importance of downregulating immune responses is underlined by the fact that laboratory mice deficient in CTLA-4 develop lethal lymphoproliferative disorders.

A second downregulating system has been recently identified. It involves molecules that inactivate or block the activation of STAT transcription factors. It is not clear whether these molecules dephosphorylate JAK and other kinases, or whether they dephosphorylate STAT factors directly.

Finally, Fas-FasL interactions, described in detail later in this chapter, also play significant downregulating roles by eliminating activated cells expressing high levels of Fas.

IV. T-HELPER-CELL SUBSETS AND THEIR REGULATORY ROLES

Studies in experimental animals (particularly in mice) suggest that the release of cytokines may obey specific patterns that determine the type of effect observed on target cells. Murine antigen-specific T-helper lymphocyte clones can be divided into three groups according to the type of cytokines they release after repetitive stimulation.

1. T_H0 cells produce predominantly IL-2 and assist the initial proliferation of $CD4^+$ cells.
2. T_H1 cells also produce IL-2 but, in addition, produce IL-3, IFN- γ , and LT- α and assist the onset of delayed hypersensitivity, inflammatory, and cytotoxic reactions.
3. T_H2 cells produce predominantly IL-4, IL-5, IL-6, and IL-10 and provide help to B lymphocytes.

An analogous subclassification of T-helper lymphocytes has been more difficult to establish in humans, but recent work suggests that human antigen-specific $CD4^+$ T-cell clones exhibit similar differences after long-term exposure to a stimulating antigen (Fig. 11.5).

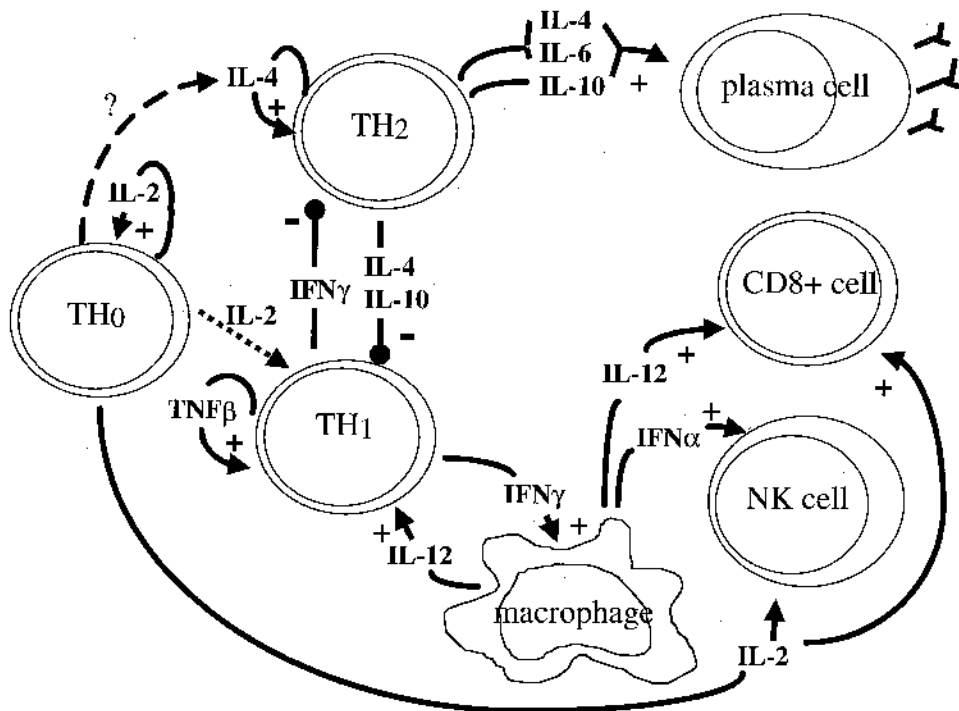

Fig. 11.5 Diagrammatic representation of the cytokine repertoire and functions of T_H1 and T_H2 helper lymphocyte subpopulations.

There is considerable interest in understanding what factor(s) control T_H1 and T_H2 differentiation and activity (see Chapter 4). Interleukin 12, produced by antigen-presenting cells, seems to play an important role in the differentiation and activation of T_H1 helper lymphocytes. The activated T_H1 cells release IFN- γ which activates macrophages inducing additional release of IL-12 and a more efficient antimicrobial response, particularly against intracellular organisms. On the other hand, IL-4 appears to play a critical role in the differentiation and activation of T_H2 lymphocytes. The activation of T_H2 cells involves the activation of specific STAT transcription factors and is associated with lack of expression of the gene encoding the β chain of the IL-12 receptor. Thus, the IL-12R of T_H2 cells lacks the β chain. The activation of T_H1 cells involves a different set of STAT transcription factors, and the gene encoding for the β chain of the IL-12R continues to be expressed. Thus, the IL-12R β chain is a marker of activated T_H1 cells.

There is reciprocal counterregulation of the differentiation and activation of T_H1 and T_H2 lymphocytes. Sustained production of high levels of IFN- γ suppresses IL-4 production, downregulating T_H2 activity. In contrast, during a strong T_H2 response, high levels of IL-4 and IL-10 have inhibitory effects on cytokine release, affecting both IFN- γ and IL-12. As a consequence, the expansion of T_H1 cells is downregulated.

V. THE ROLE OF HELPER T CELLS IN INFLAMMATORY RESPONSES

The understanding of the role of T lymphocytes in inflammation emerged with the study of a phenomenon known as delayed hypersensitivity (see Chapter 20). This abnormal immune reaction is manifest as a cutaneous reaction, often when a sensitized individual is challenged by the introduction of a specific antigen into the skin. For example, the tuberculin test is a skin test designed to determine if an individual has been exposed to and has developed hypersensitivity to antigenic products of *Mycobacterium tuberculosis*. A positive reaction to tuberculin is seen usually 24–48 hours after intradermal inoculation of the antigen and classified as a delayed hypersensitivity reaction. In contrast, patients allergic to pollens show a positive reaction to intradermally injected pollen extracts after a few minutes, a reaction termed immediate hypersensitivity (see Chapters 20 and 21).

A. Role of T Lymphocytes in Delayed Hypersensitivity

Studies with experimental animals showed that it was possible to transfer cutaneous delayed hypersensitivity reactions by transferring spleen cells from a sensitized animal to an MHC-identical nonimmune recipient. In this system, the cells primarily involved were $CD4^+$ helper lymphocytes. Through the release of lymphokines active on lymphoid and nonlymphoid cells, the activated $CD4^+$ cells led to the formation of a cellular infiltrate around the reactive area. The cellular infiltrate is usually rich in lymphocytes and monocytes reflecting the proliferation of activated $CD4^+$ lymphocytes and the release of chemotactic factors that attracted monocytes to the area.

B. Other Pathological Consequences of T-Cell Hypersensitivity

Granulomatous reactions are the expression of protracted T-cell activation in tissues, often caused by intracellular pathogens that have developed mechanisms of resistance to antimi-

crobial defenses. The granulomas contain T lymphocytes, macrophages, histiocytes, and other cell types, often forming a barrier circumscribing a focus of infection. The formation of granulomas is due to the release of cytokines that attract and immobilize other mononuclear cells. The activation of these cells in situ results in the release of enzymes that cause tissue destruction and cytokines that attract and activate additional inflammatory cells.

Graft rejection is also believed to be primarily mediated by activated CD4⁺ cells through the attraction and activation of inflammatory cells to the grafted organ (see Chapter 25).

VI. T-CELL HELP AND THE HUMORAL IMMUNE RESPONSE

As discussed in Chapter 4, antigens can be broadly classified as T-dependent or T-independent according to the need for T-cell help in the induction of a humoral immune response. Most complex proteins are T-dependent antigens, while most polysaccharides can elicit antibody synthesis without T-cell help.

It is also clear that T and B lymphocytes cooperating in the inductive stages of an immune response do not recognize the same epitopes in a complex immunogen. The membrane immunoglobulin of the B cell reacts with surface epitopes expressed on the native antigen, whereas the cooperating T cell recognizes MHC-II-associated peptides derived from the processing of the antigen by accessory cells (a role that can be played both by monocytes/macrophages and by B lymphocytes).

A. Initial Activation of the Helper Cell

When an immunogen is introduced for the first time into a immunocompetent animal, the antigen is internalized, processed, and presented to helper T cells. Two types of cells can carry out this function:

1. Monocytes, macrophages, and specialized cells such as the dendritic cells found in the lymph node cortex (see Chapter 2) are most effective as antigen-processing cells. Their role in the induction of a primary immune response must involve the ingestion and processing of small quantities of antigen opsonized as a consequence of complement activation by the alternative pathway or to the binding of C-reactive protein (see Chapters 13 and 14).
2. Activated B lymphocytes may also play the role of APC. Although B cells are uniquely suited for antigen recognition due to the expression of membrane immunoglobulins able to recognize configurational epitopes in unprocessed antigens, their role as APC is believed to require previous activation. B-cell activation induces the expression of co-stimulatory molecules essential for the proper activation of CD4⁺ T lymphocytes.

B. Antigen Processing and Presentation by B Lymphocytes

Once the membrane immunoglobulin of a B lymphocyte interacts with an epitope of a given immunogen, the complex of surface immunoglobulin-immunogen is internalized, and surface immunoglobulin ceases to be expressed. Although B cells have considerably fewer cytoplasmic enzymes than professional phagocytes (dendritic cells, monocytes, macrophages, and related cells), they are able (at least in vitro) to process the immunogen

in an endosomal compartment, where it is degraded into short peptides that become associated to MHC class II antigens. The MHC-II–oligopeptide complex is then transported to the membrane and presented to $CD4^+$ T cells.

C. Delivery of Co-stimulatory Signals

In addition, these same activated B lymphocytes release IL-1 and IL-6 and can engage in co-stimulatory interactions with helper T cells mediated by upregulated membrane molecules (see below). There is a need for high lymphocyte density and intense recirculation to fulfill the optimal conditions for T-B cell cooperation, and those are most likely achieved in lymphoid tissues, such as the lymph nodes. The cooperative interaction between T and B lymphocytes is believed to start outside of the primary follicles in the paracortical area. The subsequent interactions unfold in consecutive phases:

1. Early interaction. At this early phase, T and B cells are not tightly adherent. The initial contact involves molecules used by T cells in their nonspecific interac-

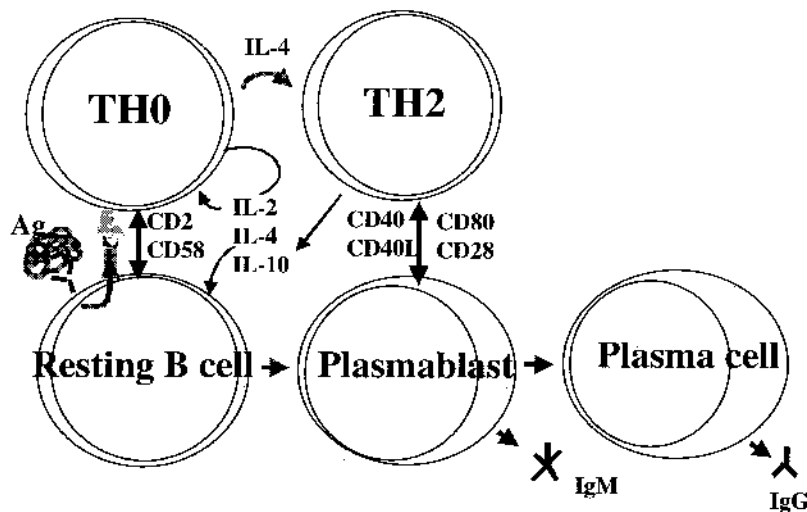

Fig. 11.6 Diagrammatic representation of the sequence of signals and interactions between T_H cells and B cells taking place at the onset of an immune response. The B lymphocyte receives activating signals from the occupancy of the binding sites of membrane immunoglobulin and by the interaction of antigen-associated C3d with CD21. Other models could involve initial B-cell interaction with a professional APC presenting membrane-associated antigen in the context of co-stimulation. The B lymphocyte, having ingested and processed the antigen that was bound to the surface immunoglobulin, later presents MHC-I-associated peptides to a T_H0 lymphocyte. This triggers the initial activation sequence of the T_H0 cells that involves synthesis of IL-2 and IL-4 (the latter becoming predominant) and upregulation of CD40 and of the “active” form of CD2 (CD2R). The upregulation of these membrane molecules allows mutual activation of the interacting cells. The nature of earlier co-signals that determine the initial shift towards IL-4 synthesis has not been defined, but once IL-4 starts to predominate it determines differentiation of $CD4^+$ T lymphocytes with T_H2 activity. At that later stage both cells express a full complement of membrane proteins, cytokines, and cytokine receptors, involved in the delivery of co-stimulating signals that will cause the proliferation and differentiation of both types of cells. Interactions involving CD40 and CD80/86 on B lymphocytes and CD40L and CD28 on T lymphocytes is essential for further progression of the response.

tions with APC, such as CD2, CD4, LFA-1, and ICAM-1. In addition, CD5 molecules on the T cell that bind CD72 molecules on the B cell may also be involved at that stage.

2. Firm attachment. Some time after this initial interaction, T and B cells become firmly attached due to the upregulation of several sets of membrane molecules. Some molecules play a predominant role in promoting the stable interaction between the cooperating cells, while others deliver activating signals. As a consequence of these multiple interactions, the cells come to close apposition (the intercellular distance is reduced to less than 12 nm), and activating signals can be transmitted both to T lymphocytes and B lymphocytes.

D. Delivery of Activation Signals

Several sets of interacting molecules play significant roles in the signaling of cooperating helper T cells and B cells.

1. Activated CD4⁺ lymphocytes express increased levels of CD40L able to interact with CD40 expressed by B cells. The interaction of CD40 with CD40L induces two protein kinase pathways on B lymphocytes. One of the pathways involves JAK kinases and STAT transcription factors, while the other pathway involves the MAP kinase and results in the activation of NFκB. Once activated, B cells increase their expression of CD80 (B7-1), expressed at low or undetectable levels on resting B lymphocytes, and CD86 (B7-2), constitutively expressed at low levels on resting B cells.
2. As CD80 (B7-1) and CD86 (B7-2) are upregulated, the interaction with their ligand, the CD28 molecule expressed by T cells, delivers additional activating signals.
3. CD45RO molecules expressed exclusively by memory helper T lymphocytes may interact with CD22 molecules expressed by activated B lymphocytes.

E. B-Cell Proliferation and Differentiation

Following activation, B cells undergo mitosis and proliferate and differentiate into antibody-producing plasma cells. This evolution is associated with migration through different areas of the lymph node.

First the activated B cells separate from the helper T cell and migrate to the denser areas of the follicle, around the germinal centers, where they proliferate with a rapid cycling time of about 7 hours. In 5 days, the antigen-stimulated B-lymphocyte population in a given germinal center increases about 1000-fold. Most resting B cells express IgM and IgD on the cell membrane, and in the initial stages of cell differentiation many cells will produce and secrete IgM antibody, characteristic of the early stages of the primary immune response.

As B cells continue to proliferate and differentiate, recombination genes will be activated (apparently as a consequence of cytokine-mediated signaling) and class switch takes place. The constant region genes for μ and δ chains are looped out and one of the constant region genes for IgG, IgA, or IgE moves into the proximity of the rearranged V-D-J genes (see Chapter 6). Subsequently, the synthesis of IgM antibody declines, replaced by antibody of the other classes, predominantly IgG. The isotype class switch seems to depend on signals delivered both by cytokines (e.g., IL-4) and by cell-cell interactions involving CD40 and CD40L. The signaling pathways that lead to the activation of the recombination genes and, subsequently, to isotype switch, have yet to be defined.

The functional differentiation of B lymphocytes coincides with migration of the differentiating B cells and plasmablasts to different territories. First, the dividing B cells migrate into the clear areas of the germinal centers and into the mantle zone. Those areas are rich in CD4⁺, CD40L⁺ T cells, which apparently deliver a critical signal to B cells, mediated by CD40-CD40L interaction. Once committed to differentiation into antibody production, the activated B cells differentiate into plasmablasts, which exit the lymph nodes through the medullary cords and migrate to the bone marrow, where they become fully differentiated, antibody-secreting plasma cells.

In murine models, activated B cells receiving a CD40-mediated signal differentiate either into memory B cells or antibody-producing plasma cells. What determines that B cells differentiate into antibody-producing plasma cells or memory cells is not known. It has been suggested that co-stimulatory signals delivered by IL-2 and IL-10 promote the differentiation of B memory cells, but this remains to be confirmed. In humans, CD40-mediated activating signals must be involved both in the differentiation of IgG-producing plasma cells and of memory B cells. Children born with a defective CD40L gene suffer from an immunodeficiency known as the hyper-IgM syndrome in which B cells cannot switch from IgM to IgG production and no immunological memory is generated (see Chapter 29).

VII. ACTIVATION AND DIFFERENTIATION OF CD8⁺ CYTOTOXIC T CELLS

An essential function of cell-mediated immunity is the defense against intracellular infectious agents, particularly viruses. For example, circulating T lymphocytes isolated from individuals who are recovering from measles infection destroy MHC-identical fibroblasts infected with this virus in 2–3 hours. A number of experimental models have provided insights into the mechanisms of lymphocyte-mediated cytotoxicity against virus-infected cells.

A. Simulation, Activation, and Differentiation of Cytotoxic T Lymphocytes

The first signal leading to the differentiation of cytotoxic T lymphocytes involves recognition of a viral peptide associated with an MHC-I molecule. As pointed out in Chapters 3 and 4, such recognition is only possible if the TcR and MHC-I molecules are able to interact weakly in the absence of the viral-derived oligopeptide, and this is only possible when the two interacting cells are MHC-identical, because only T lymphocytes able to interact with self MHC molecules are selected during differentiation (see Chapter 10).

Strongly activated CD8⁺ cells have been shown to release cytokines, including IL-2, but simple contact with a virus-infected target cell does not induce this level of activation and does not trigger the proliferation of CD8⁺ T lymphocytes. Under these conditions, proliferation and differentiation of CD8⁺ cells appears to require IL-2 and other cytokines released by activated helper CD4⁺ T lymphocytes. Thus, the responding T-lymphocyte population contains a mixture of CD4⁺ and CD8⁺ cells, and the stimulating population of viral-infected cells must present viral antigens in association with both MHC class I and MHC class II molecules. The CD4⁺ T lymphocytes will recognize viral antigens associated with class II MHC molecules, while the CD8⁺ T lymphocytes recognize viral antigens complexed to class I MHC molecules.

The initial proliferation of helper and cytotoxic T cells takes place mostly during the prodromal stages, when symptoms are minimal. After a few days, the number of differen-

tiated helper and cytotoxic T cells expands and clinical manifestations of the disease appear. These symptoms are believed to result in part from the release of a variety of cytokines from infected cells and helper T cells and from the destruction of viral-infected cells by the fully differentiated cytotoxic T cells.

B. Characteristics of Cytotoxic T Lymphocytes

Most cytotoxic T cells express the CD8 marker, but some CD4⁺ lymphocytes may also have cytotoxic properties. All cytotoxic T cells express the CD56 marker. In addition, cytotoxic T cells contain increased levels of perforins and esterases in cytoplasmic granules and have increased expression of the membrane-associated Fas ligand, essential for their cytotoxic activity.

C. Target Cell Killing

The cytotoxic reaction takes place in a series of successive steps (see Fig. 11.7):

1. Conjugation

The first step in the cytotoxic reaction involves the conjugation of cytotoxic T cells with their respective targets. This conjugation involves, in the first place, the recognition by the TCR of a peptide–MHC-I complex. However, additional interactions are required to achieve the strong adhesion of the T cell to the target cell required for effective killing:

The CD8⁺ molecule itself interacts with the nonpolymorphic domain of the MHC class I molecule, specifically with its $\alpha 3$ domain. The avidity of this interaction increases after TcR occupancy.

The CD2 molecule, present on all T cells, interacts with the CD58 molecules expressed by the target cells. Any resting T cell can interact with CD58⁺ cells,

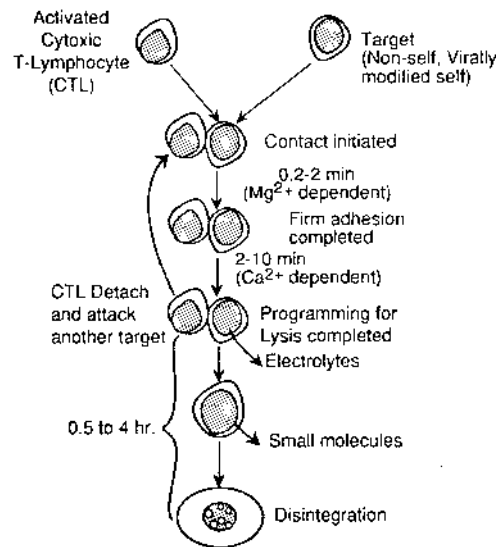

Fig. 11.7 Diagrammatic representation of the sequence of events in a cytotoxic reaction. Notice that an activated cytotoxic (CD8⁺) T cell is able to kill several targets.

but this interaction by itself is weak and does not lead to cell activation. The modification of the CD2 molecule after TcR engagement increases the affinity of the interaction between CD2 and CD58.

In addition, the interaction between LFA-1 and ICAM-1 provides additional stabilizing bonds between the interacting cells. LFA-1 avidity for its ligand(s) is also upregulated by T-cell activation.

The conjugation of CD8⁺ T cell to its target cell is firm but transient, and after about 30 minutes the affinity of ICAM-1 for LFA-1 and of CD58 for CD2 reverts to resting levels. The cytotoxic T cell can then move on to another antigen-bearing target with which it will develop the same interaction.

2. Target Cell Destruction

During the short period of intimate contact with its target, a series of reactions takes place, eventually resulting in the killing of the target cell.

First, the cytoskeleton of the cytotoxic cell reorganizes. The microtubule-organizing center and the Golgi apparatus reorganize in the direction of the area of contact with the target cell. This is associated with transport of cytoplasmic granules towards the target. When the cytoplasmic granules reach the membrane, their contents are emptied into the virtual space that separates the cytotoxic T cells and target cells. These granules contain a mixture of proteins, including perforins and granzymes.

Perforins polymerize as soon as they are released, forming polyperforins. These are inserted in the target cell membrane, where they form transmembrane channels. The formation of these channels may lead to influx of water into the cell and may cause cell death in a manner analogous to the effects of the assembly of the terminal complement components on a cell membrane. On the other hand, the perforin channels are believed to facilitate the penetration of granzymes A and B into the target cell. Once in the cytoplasm of the target cell, granzymes activate proteolytic enzymes (caspases), which initiate a cascade of events leading to apoptotic death of the target.

3. Apoptosis

Apoptosis, or programmed cell death, is characterized by nuclear and cytoplasmic changes. At the nuclear level, DNA is degraded and fragmented. The cytoplasm shows condensation and there is an abnormal increase of membrane permeability, especially significant at the mitochondrial level.

The nuclear alterations involve the activation of a series of caspases, cysteine proteases that cleave after aspartic acid residues, which includes 13 different enzymes. Of those, some are considered as initiators of the sequence that leads to apoptosis (e.g., caspase 8 and 9), while others are considered as effector caspases involved in the final steps of the cycle (e.g., caspase 3 and 7). All caspases exist as inactive proenzymes that need to be cleaved by proteases, and granzymes appear to be able to activate the effector caspases, either directly or through a pathway mediated by increased mitochondrial membrane permeability and release of cytochrome *c* and other caspase activators. This leads to the activation of initiator caspases, particularly caspase 9. Once activated, the effector caspases such as caspase 3 cleave an endonuclease-inactivating protein that forms an inactive complex with a cytoplasmic DNase. As that protein is digested, the endonuclease becomes active, translocates to the nucleus, causing the DNA breakdown that is characteristic of apoptotic cell death (Fig. 11.8).

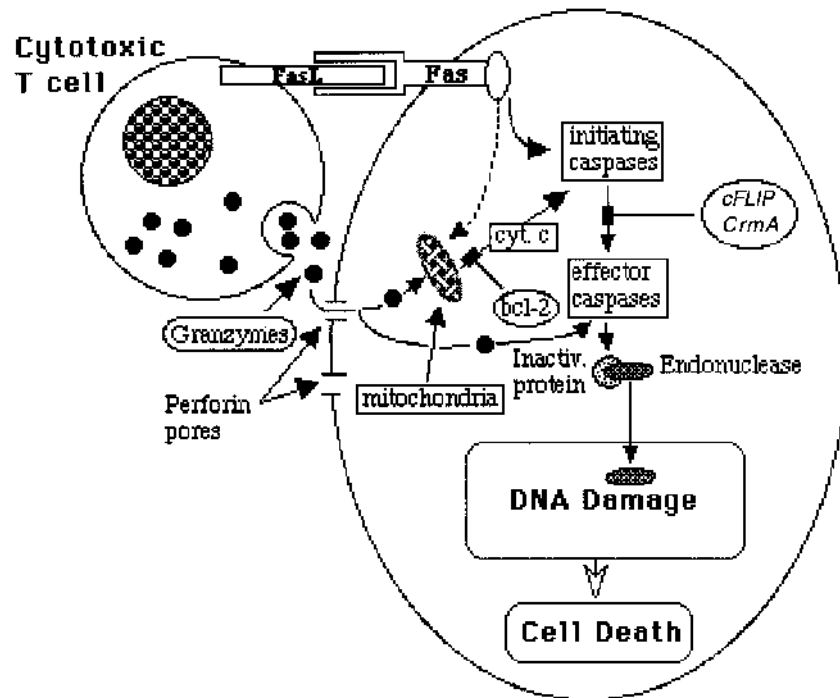

Fig. 11.8 Diagrammatic representation of the sequence of events leading to apoptosis of a target cell after interaction with an activated cytotoxic T lymphocyte. Two pathways leading to activation of a critical initiator caspases have been described: one involves the interaction between Fas and FasL, an interaction that activates caspase 8. The other involves granzymes, released by the T lymphocyte and diffused into the cytoplasm through polyperforin clusters. Granzymes can trigger apoptosis either by activating directly terminal caspases or by inducing increased mitochondrial permeability, followed by release of cytochrome *c* and other caspase activators. The activation of terminal caspases is followed by denaturation of an inactivating protein complexed with a cytoplasmic endonuclease. The activated endonuclease translocates to the nucleus, where it causes DNA breakdown, the hallmark of apoptosis. Two levels of control appear to exist: One, controlling mitochondrial permeability, is regulated by a member of the Bcl-2 proto-oncogene family. The other, blocking the pathway between initiator and effector caspases, involves *Crma*, the product of a cytokine response modifier gene, and *cFLIP*.

A second pathway to apoptosis is primarily mediated by Fas (CD95)–FasL interactions that induce a death-inducing signaling complex in the Fas-bearing cell. The activation of this pathway is associated with activation of caspase 8, which in turn will trigger the cascade that leads to activation of effector caspases and apoptosis. However, the two pathways are not mutually exclusive, and Fas-FasL interactions often result in direct activation of caspase 8 as well as in increased mitochondrial permeability, release of cytochrome *c*, and activation of caspase 9.

Experiments carried out with animals transgenic for the hepatitis B virus (HBV) suggest that activation of both pathways seems to be a requirement for efficient cytotoxicity *in vivo*. These animals were injected with cytotoxic T-cell clones from three different groups of mice:

1. Fas-deficient mice
2. Mice lacking the perforin genes
3. Normal mice expressing both FasL and perforins

Although the clones from all animals could kill HBV-infected cells in vitro, only clones expressing both the FasL and the perforin genes caused cytotoxicity in vivo.

Because the expression of Fas and FasL is very widespread, even in resting cells, there are negative control mechanisms to avoid unnecessary triggering of the pathway. Two proteins seem to play major roles blocking the caspase 8 apoptosis pathway induced by Fas-FasL interactions (*cFLIP* and *Crma*, the product of a cytokine response modifier gene). On the other hand, a protein encoded by the proto-oncogene *Bcl-2*, blocks the mitochondrial pathway to apoptosis.

VIII. ACTIVATION AND FUNCTION OF NATURAL KILLER CELLS

The mobilization of a T-lymphocyte-mediated cytotoxic response following an intracellular infection is a relatively ineffective process. In a resting immune system, the cytotoxic T-cell precursors exist in relatively low numbers ($<1/10^5$). Proliferation and differentiation are required to generate a sufficient number of fully activated effector $CD8^+$ T cells. Even the response of a primed individual takes a few days. Thus, an effective primary cytotoxic T-cell primary response is seldom deployed in less than a few days and may take as long as 2 weeks. During this time the host depends on defenses that can be deployed much more rapidly, such as the production of type I interferons (α and β), initiated as soon as the virus starts replicating, and the activity of natural killer (NK) cells. These two effector systems are closely related: type I interferons activate NK cell functions; both are particularly effective as defenses against viral infections.

A. NK Cell Activation

NK cells receive activation signals both from T lymphocytes and from monocytes/macrophages. Those signals are mediated by cytokines released from those cells, particularly IL-2, interferon- α , and IL-12.

1. NK cells constitutively express a functional IL-2 receptor that is predominantly constituted by the β chain (p75 subunit), and for this reason NK cells are, for the most part, $CD25^-$. This variant of the IL-2 receptor enables NK cells to be effectively activated by IL-2 produced by activated helper T cells early in the immune response, without the need for any additional co-stimulating factors or signals. IL-2-activated NK cells are also known as lymphokine-activated killer cells (LAK cells).
2. Interferons α and β enhance the cytotoxic activity of NK cells. Thus, the release of these interferons from infected cells mobilizes nonspecific defenses before the differentiation of MHC restricted cytotoxic T lymphocytes is completed.
3. IL-12, produced at the same time as interferons α and β , is believed to play a crucial role in the early activation of NK cells.

B. Target Recognition by NK Cells

The mechanism of recognition of target cells by NK cells has not been as clearly defined as the mechanisms of antigen recognition for B and T lymphocytes. A major difference is

that NK cells can recognize virus-infected cells and many different types of malignant cells without clonal restriction. In other words, their recognition mechanisms are relatively non-specific and common to all NK cells. At this time, it is believed that two broadly reactive receptors are involved, one of which delivers activating signals, and the other which delivers inhibitory signals (Fig. 11.9).

1. The triggering or activating receptor (NKAR, NKR-P1) recognizes membrane glycoproteins, probably with greater affinity when modified as a consequence of malignant transformation or viral infection.
2. The inhibitory receptor (NKIR, p58,70) prevents NK cells from killing normal host cells. It has a molecular weight of 54 kDa and interacts with the complex formed by class I MHC molecules (particularly HLA-C and HLA-B) and their associated self peptides. Most NK cells express a variety of NKIR molecules with different MHC specificities.

C. Activation of NK Cells as a Result of Viral Infection and Malignant Transformation

Viral infection and malignant transformation not only can change the constitution of membrane glycoproteins but can also interfere with the interaction of HLA molecules with the inhibitory receptor. This interference may be due to replacement of a self peptide on HLA-C by a nonself peptide or to downregulation of the expression of MHC-I molecules on the infected cell membrane, a phenomenon frequently associated with viral infection. In either case, the end result will be that the triggering receptor will deliver a signal that is not counteracted by a signal from the inhibitory receptor. Consequently the NK cell will be able to proceed with the destruction of the target cell by mechanisms similar to those described for T-lymphocyte-mediated cytotoxicity.

D. NK Cells and ADCC

NK cells express the Fc γ RIII, a low-affinity Fc receptor that binds IgG-coated cells. IgG binding results in the activation of the NK cell and lysis of the target, a process known as antibody-dependent cellular cytotoxicity (ADCC). ADCC-dependent activation and killing is not inhibited by the NKIR (p58,70) inhibitory receptor.

IX. REGULATORY CELLS AND THE IMMUNE RESPONSE

T lymphocytes can specifically downregulate B-cell responses. This concept was demonstrated by experiments performed in mice immunized with keyhole limpet hemocyanin (KLH). If mice are primed and later boosted with KLH, a population of T lymphocytes can be isolated 2 weeks after the boost that markedly suppress the IgG anti-DNP response of genetically identical mice primed with DNP-KLH. However, this T-cell population will not suppress anti-DNP antibody production in animals immunized with DNP conjugated with a different carrier, such as bovine gammaglobulin (BGG). Other studies in mice have confirmed the existence of antigen-specific T cells that downregulate the activity of other T-cell subpopulations. Suppression appears to be a negative feedback exerted by activated regulatory T lymphocytes on other T lymphocytes. This negative

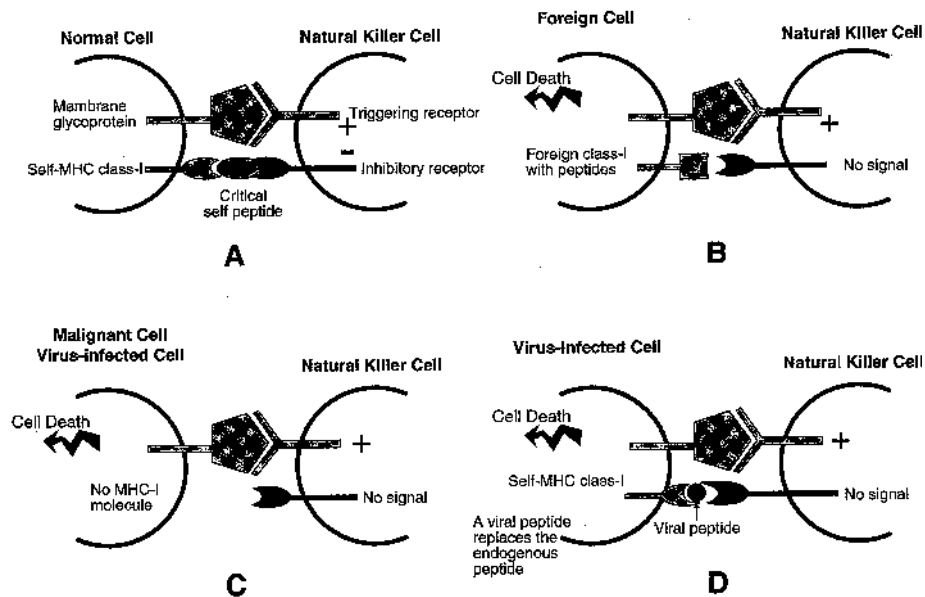

Fig. 11.9 Diagrammatic representation of the mechanism of target cell recognition by NK cells. The activation or lack of activation of cytotoxic pathways depends on the balance between stimulatory and inhibitory receptors. If the inhibitory receptor is not triggered (due to either presentation of a nonself peptide, lack of interaction of the inhibitory receptor with a nonself MHC-I-peptide complex, or downregulation of expression of MHC-I molecules on the cell membrane), stimulatory activity prevails and the target cell is killed.

feedback results in the inability of effector lymphocytes to respond adequately to stimulation.

A. The Nature of Regulatory Cells

In most experimental systems, regulatory activity is carried out by a subset of $CD8^+$ lymphocytes (known as suppressor T cells), but a role for regulatory $CD4^+$ lymphocytes has also been demonstrated.

B. Mechanism of Suppression

The mechanism of suppression by regulatory T lymphocytes remains uncertain. Two main possibilities have been considered:

1. Cross-regulation of T helper subsets may explain nonspecific suppression. Strongly activated T_H1 cells may release soluble factors (such as interferon- γ) that inhibit T_H2 activity and, consequently, interfere with B-cell activation. Conversely, T_H2 -produced IL-4 and IL-10 suppress T_H1 responses by downregulating IL-12 synthesis. Other cytokines, such as transforming growth factor β (TGF- β), which inhibits T-lymphocyte proliferation by blocking IL-2 transcrip-

tion, and macrophage inflammatory proteins (e.g., MIP-1 α) may also play a role in the downregulation of immune responses.

2. Direct cell-to-cell signaling between regulatory cells and antigen-stimulated cells may be the key factor when the downregulation affects a specific immune response. For example, upregulation of CTLA-4 is known to result in the delivery of downregulatory signals, including the synthesis and release of TGF- β . However, our knowledge about downregulatory interactions and their control is extremely sketchy.

SELF-EVALUATION

Questions

Choose the one *best* answer.

- 11.1 Which one of the following T_H0 cytokines is able to enhance the activity of both T_H1 lymphocytes and NK cells?
 - A. Interferon- α
 - B. Interleukin-2
 - C. Interleukin-4
 - D. Interleukin-10
 - E. Migration inhibition factor (MIF)
- 11.2 Which of the following ligand-receptor interactions plays a major role in the effector stages of CD8-mediated cytotoxicity?
 - A. CD2:CD58 (LFA-3)
 - B. CD8:MHC-I
 - C. CD95 (Fas):Fas ligand
 - D. IL-2:IL-2R
 - E. Interferon- γ (IFN γ):IFN γ -R
- 11.3 The development of antigen-specific anergy is believed to result from:
 - A. Apoptosis of the antigen-stimulated T lymphocytes
 - B. Lack of delivery of co-stimulating signals to antigen-binding cells
 - C. Lack of transport of antigen-derived peptides to the endoplasmic reticulum
 - D. Predominant stimulation of T_H2 helper cells
 - E. Release of large concentrations of IL-10
- 11.4 Mice from strain A, expressing antigen H2-K on their lymphocytes, were immunized with influenza virus. Seven days later, T lymphocytes from these animals were mixed with ⁵¹Cr-labeled, influenza virus-infected T lymphocytes from H2-d mice, and [³H] thymidine was simultaneously added to the system. Four hours later you would expect:
 - A. Significant ⁵¹Cr release into the supernatant
 - B. Significant incorporation of [³H] thymidine by the immune lymphocytes
 - C. Significant incorporation of [³H] thymidine by the target lymphocytes
 - D. Transfer of ⁵¹Cr from target cells into cytotoxic cells
 - E. No significant release of ⁵¹Cr
- 11.5 Which of the following mechanisms is responsible for the sparing of normal cells by NK cells?

- A. Differential specificity of the NK cell Fas ligand for altered Fas molecules on malignant and virus-infected cells
- B. Downregulation of HLA-C molecules on normal cells
- C. Lack of expression of Fas by normal cells
- D. Lack of expression of the abnormal glycoproteins recognized by the NK-triggering receptor
- E. Recognition of self peptides associated with HLA-C molecules by the NK cell
- 11.6 Which of the following gene products is upregulated in proliferating activated CD8⁺ T lymphocytes?
- A. Bcl-2
- B. Caspase 8
- C. CD40
- D. Interleukin-10 (IL-10)
- E. Tumor necrosis factor (TNF)
- 11.7 Which of the following is a major characteristic of natural killer cells?
- A. Constitutive expression of an IL-2 receptor
- B. Inducible expression of class II MHC antigens on their surface
- C. Lack of expression of Fc receptors
- D. Phenotypic identity to small T lymphocytes
- E. Recognition of target cells expressing MHC-I molecules modified by viral oligopeptides
- 11.8 Which of the following factors is believed to determine the differentiation of B lymphocytes into plasma cells producing antibody of one isotype or another?
- A. Cytokines released by T_H2 helper T cells and macrophages
- B. Feedback mechanisms involving soluble antigen-antibody complexes
- C. Random rearrangements of germ line heavy- and light-chain genes
- D. Somatic hypermutation of V-region genes
- E. The interaction between CD28 and CD80
- 11.9 Normal mononuclear cells were cultured in the presence of pokeweed mitogen (PWM) and blocking monoclonal antibodies (MoAb) to IL-2 and the IL-2 receptor (IL-2R). The cultures were harvested after 6 days of culture and the concentrations of IgM measured by enzyme immunoassay. The following results were obtained:

Culture conditions	IgM ($\mu\text{g/mL}$)
Mononuclear cells alone	0.01 \pm 0.02
Mononuclear cells + PWM	5.5 \pm 1.5
Mononuclear cells + PWM + anti-IL-2 MoAb	6.5 \pm 2.0
Mononuclear cells + PWM + anti-IL-2R MoAb	5.0 \pm 2.2
Mononuclear cells + anti-IL-2 MoAb	0.02 \pm 0.015
Mononuclear cells + anti-IL-2R MoAb	0.01 \pm 0.01

Which of the following conclusions is supported by the data?

- A. B lymphocytes do not express a transducing IL-2 receptor.
- B. IL-2 has a potentiating effect on B cell stimulation by PWM.
- C. The differentiation of IgM producing B cells is T-cell independent.

- D. The response of B cells to PWM stimulation is T-cell dependent.
 - E. The stimulation of IgM synthesis by PWM is IL-2 independent.
- 11.10 Which of the following is a well-known effect of interleukin-8?
- A. Chemotaxis and activation of neutrophils
 - B. Induction of B-cell proliferation
 - C. Induction of the switch from IgM to IgG synthesis
 - D. Induction of B-cell differentiation
 - E. Suppression of interleukin release by helper T cells

Answers

- 11.1 (B) Among the listed interleukins, IL-2 is the only one released by activated T_H0 cells, which activates both T_H1 lymphocytes and NK cells.
- 11.2 (C) The interaction between CD95 (Fas) and its ligand delivers a signal that induces the apoptotic death of target cells. The other listed interactions are either involved in the activation stages of cytotoxic T cells or mediate the cell-cell interactions that precede the delivery of signals leading to cell death.
- 11.3 (B) The lack of co-stimulation of a T lymphocyte that has received initial activating signals through the TcR may lead to anergy (lack of responsiveness) or to cell death (apoptosis). The release of large concentrations of IL-10 by activated T_H2 cells could downregulate an ongoing immune response, but the effects of IL-10 are not antigen-specific.
- 11.4 (E) The T lymphocytes from H2-K mice are programmed to kill cells expressing viral antigens in association with their own MHC molecules and will not kill infected cells from mice carrying different MHC antigens. On the other hand, lymphocytes from two different mouse strains are likely to interact and participate in a mixed lymphocyte reaction, but significant incorporation of [3H] thymidine will only be observed after more than 3 days of co-culture.
- 11.5 (E) The cytotoxic reaction mediated by NK cells depends on the recognition of cellular membrane glycoproteins by an NK cell-triggering receptor. However, if there is a simultaneous interaction between an inhibitory receptor and an HLA-C/endogenous peptide complex expressed by normal cells, cytotoxicity is inhibited. Malignant and virus-infected cells either have downregulated expression of MHC molecules or express a modified peptide in association with HLA-C. As a result, the NK cell does not receive the inhibitory signal and the target cell is killed.
- 11.6 (A) Bcl-2 designates members of a complex family of genes whose gene products have anti-apoptotic proteins. The overexpression of Bcl-2 is a hallmark of the stimulated cell that undergoes proliferation and differentiation. Caspase 8 is an apoptotic enzyme upregulated in target cells as a consequence of Fas-FasL interactions. Activated B cells express CD40. IL-10 is released by activated T_H2 cells. TNF is mainly released by APCs and activated $CD4^+$ T cells.
- 11.7 (A) The constitutive expression of an IL-2 receptor able to transduce activating signals upon occupancy by IL-2 is responsible for the transformation of NK cells into LAK cells upon incubation with IL-2.

- 11.8 (A) The major factors controlling the differentiation of plasma cells synthesizing IgG or other immunoglobulins are believed to be cytokines released predominantly by T_H2 cells (e.g., IL-4) and signals resulting from the interaction between B lymphocytes expressing CD40 and activated T_H2 cells expressing the corresponding ligand.
- 11.9 (E) The results show that both immunoneutralization of IL-2 and blocking of the IL-2 receptor had no detectable effect on the stimulation of IgM synthesis on a mononuclear cell culture with PWM. Issues such as the T-cell dependence or independence of this response were not addressed by the experiment, since cytokines other than IL-2 may be involved in T-B cooperation, and no effort was made to study the response of T-cell-depleted preparations. The experiment also was not designed to answer any questions about the IL-2 receptor of B cells, other than the fact that its block had no effect on the response to PWM.
- 11.10 (A) IL-8 is one of the pro-inflammatory cytokines and has chemotactic effects of neutrophils and T lymphocytes.

BIBLIOGRAPHY

- Abbas, A. K. and Sharpe, A. H. T cell stimulation: An abundance of B7s. *Nature Med.* 5:1345, 1999.
- Aringer, M., Frucht, D., and O'Shea, J. Interleukin/interferon signaling—a 1999 perspective. *Immunologist* 7:139, 1999.
- Berridge, M. Lymphocyte activation in health and disease. *Crit. Rev. Immunol.* 17:155, 1997.
- Daëron, M. ITIM-Bearing negative coreceptors. *Immunologist* 5:79, 1997.
- Dbaiibo, G. S., and Hannun, Y. A. Cytokine response modifier A (CrmA): A t-strategically deployed viral weapon. *Clin. Immunol. Immunopath.* 86:134, 1998.
- Germain, R. T-cell signaling: The importance of receptor clustering. *Curr. Biol.* 7:R640, 1997.
- Hansen, G., McIntire, J. J., Yeung, V. P., et al. CD4⁺ T helper cells engineered to produce latent TGF-β1 reverse allergen-induced airway hyperreactivity and inflammation. *J. Clin. Invest.* 105:61, 2000.
- Ju, S., Matsui, K., and Ozdemirli, M., Molecular and cellular mechanisms regulating T and B cell apoptosis through Fas/FasL interaction. *Int. Rev. Immunol.* 18(5–6):485, 1999.
- Kuo, C., and Leiden, J. Transcriptional regulation of T lymphocyte development and function. *Annu. Rev. Immunol.* 17:149, 1999.
- Lee, K.-M., Chuang, E., Griffin, M., Khattri, R, et al. Molecular basis of T cell inactivation by CTLA-4. *Science* 282:2263, 1998.
- Leeuwen, J., and Samelson, L. T cell antigen-receptor signal transduction. *Curr. Opin. Immunol.* 11:242, 1999.
- Lenardo, M., Chan, F., Homung, F., et al. Mature T lymphocyte apoptosis—immune regulation in a dynamic and unpredictable antigenic environment. *Annu. Rev. Immunol.* 17:221, 1999.
- Lin, J., and Leonard, W. Signaling from the IL-2 receptor to the nucleus. *Cytokine Growth Factor Rev.* 8(4):313, 1997.
- Lindhout, E., Vissers, J., Figdor, C., and Adema, G. Chemokines and lymphocyte migration. *Immunologist* 7:147, 1999.
- Ling, C.-C., Walsh, C. M., Young J. D-E. Perforin: Structure and function. *Immunol. Today* 16:194, 1995.
- Luster, A. D. Chemokines—chemotactic cytokines that mediate inflammation. *N. Engl. J. Med.* 338:436, 1998.

- Myung, P. S., Boerthe, N. J., and Goretzy, G. A. Adapter proteins in lymphocyte antigen-receptor signaling. *Curr. Opin. Immunol.* 12:256, 2000.
- Pimentel-Muñoz, F. X., and Seed, B. Regulated commitment of TNF receptor signaling: a molecular switch to death or activation. *Immunology* 11:783, 1999.
- Rathmell, J. C., and Thompson, C. B. The central effectors of cell death in the immune system. *Annu. Rev. Immunol.* 17:781, 1999.
- Rogge, L., Ppai, A., Presky, D. H., Biffi, M., Minetti, L. J., et al. Antibodies to the IL-12 receptor beta 2 chain mark human T_H1 but not T_H2 cells in vitro and in vivo. *J. Immunol.* 162:3926, 1999.
- Salmon, M., Pilling, D., Borthwick, N., and Akbar, A. Inhibition of T-cell apoptosis—a mechanism for persistence in chronic inflammation. *Immunologist* 5:87, 1997.
- Scaffidi, C., Schmitz, I., Krammer, P. H., and Peter, M. E. The role of c-FLIP in modulation of CD95-induced apoptosis. *J. Biol. Chem.* 274:1541, 1999.
- Slavik, J., Hutchcroft, J., and Bierer, B. CD28/CTLA-4 and CD80/CD86 families: Signaling and function. *Immunol. Res.* 19(1):1, 1999.
- Smyth, M. J., and Trapani J. A. Granzymes: Exogenous proteinases that induce target cell apoptosis. *Immunol. Today* 16:202, 1995.
- Tran, P. B., and Miller, R. J. Apoptosis: Death and transfiguration. *Sci. Med.* 6:18, 1999.

12

The Humoral Immune Response and Its Induction by Active Immunization

Gabriel Virella

I. INTRODUCTION

The recognition of a foreign cell or substance triggers a complex set of events that result in the acquisition of specific immunity against the corresponding antigen(s). The elimination of “nonself” depends on effector mechanisms able to neutralize or eliminate the source of antigenic stimulation. While the inductive stages of most immune responses require T- and B-cell cooperation, the effector mechanisms can be clearly subdivided into cell-dependent and antibody-dependent (or humoral) mechanisms. The sequence of events that culminates in the production of antibodies specifically directed against exogenous antigen(s) constitutes the humoral immune response.

II. OVERVIEW OF THE INDUCTION OF A HUMORAL IMMUNE RESPONSE TO AN IMMUNOGEN

A. Exposure to Natural Immunogens

Infectious agents penetrate the organism via the skin, upper respiratory mucosa, and intestinal mucosa. In most cases the immune system is stimulated in the absence of clinical symptoms suggestive of infection (subclinical infection). The constant exposure to immunogenic materials penetrating the organism through those routes is responsible for continuous stimulation of the immune system and explains why relatively large concentrations

of immunoglobulins can be measured in the serum of normal animals. In contrast, animals reared in germ-free conditions synthesize very limited amounts of antibodies, and their sera have very low immunoglobulin concentrations.

B. Deliberate Immunization

Many infectious diseases can be prevented through active immunization. When live attenuated organisms are used for immunization, they are usually delivered to the natural portal of entry of the organism. For example, a vaccine against the common cold using attenuated rhinoviruses would be most effective if applied as a nasal aerosol. On the other hand, if inert compounds (such as inactivated infectious agents, polysaccharides, or toxoids) are used as immunogens, they have to be introduced in the organism by injection, usually intramuscularly, subcutaneously, or intradermally.

In humans, immunization is usually carried out by injecting the antigen intradermally, subcutaneously, or intramuscularly or by administering it by the oral route (e.g., attenuated viruses, such as poliovirus). As a rule, injected immunogens are mixed or emulsified with adjuvants, compounds that enhance the immune response.

The most potent adjuvant is complete Freund's adjuvant (CFA), a water-in-oil emulsion containing killed mycobacteria. This adjuvant is widely used for the production of antisera in laboratory animals, but it tends to cause an intense inflammatory reaction in humans and for that reason is not used in human vaccines. In humans, the most commonly used adjuvants are inorganic gels such as alum and aluminum hydroxide.

The mechanism of action of all adjuvants is similar and involves two important factors:

1. Adjuvants slow down the diffusion of the immunogen from the injected spot, so that antigenic stimulation will persist over a longer period of time.
2. Adjuvants induce a state of activation of antigen-presenting cells in the site of inoculation. This activation can be more or less specific: CFA causes a very intense local inflammation, while some bacterial compounds with adjuvant properties have a more targeted effect on macrophages and other APC and have strong adjuvant properties without causing a very intense inflammatory reaction. Alum and aluminum hydroxide share both types of effects, but they do not induce an inflammatory reaction as intense as CFA, and this is the reason for their use in human immunization.

C. B-Cell Activation

As discussed in greater detail in Chapter 4 and 11, B-cell activation requires multiple signals. The only specific signal is the one provided by the interaction between the antigen-binding site of membrane immunoglobulins with a given epitope of an immunogen. The additional signals, provided by T_H2 helper cells and APC, are nonspecific with regards to the antigen.

The recognition of an antigen by a resting B cell seems to be optimal when the immunogen is adsorbed to a follicular dendritic cell or to a macrophage. B lymphocytes recognize either unprocessed antigen or antigen fragments that conserve the configuration of the native antigen. All techniques used for measurement of specific antibodies use antigens in their original configuration as their basis and succeed in detecting antibodies reacting with them. Whether or not some B cells may have membrane immunoglobulins reactive with immunogen-derived peptides associated with MHC-II molecules is not known.

Helper T_H2 lymphocytes provide other signals essential for B-cell proliferation and differentiation. The activation of this CD4 subpopulation is favored by a low-affinity interaction between an immunogen-derived oligopeptide associated with an MHC-II molecule and the T-cell receptor, as well as by additional signals, some derived from cell-cell interactions, such as the CD28/CD86 interaction, and others from cytokines, such as IL-4 and IL-1. Activated T_H2 cells, in turn, provide several co-stimulatory signals that promote B-cell proliferation and differentiation. Some of these signals derive from the interaction between cell membrane molecules upregulated during the early stages of T_H2 and B-cell activation, e.g., CD40L (CD159) on T cells and CD40 on B cells, while others are mediated by cytokines, such as IL-4, IL-6, and IL-10.

When the proper sum of specific signals and co-stimulatory signals is received by the B cell, clonal proliferation and differentiation ensues. Since each immunogen presents a multitude of epitopes, a normal immune response is polyclonal, i.e., it involves many different clones recognizing different epitopes of an immunogen. The induction of an immune response requires some time for activation of all the relevant cells and for proliferation and differentiation of B cells into plasma cells. Thus, there is always a lag phase between the time of immunization and the time when antibodies become detectable. It must be noted that while most activated B cells will become antibody-producing plasma cells, a few will become memory cells (see below).

Experimental animals immunized with a given immunogen (e.g., tobacco mosaic virus) often show marked postimmunization hypergammaglobulinemia, but only a very small fraction of the circulating immunoglobulins reacts with the immunogen. In humans, the initial burst of IgE production, after first exposure to an allergen, seems to be mainly constituted by nonspecific antibodies. This apparent lack of specificity of the immune response is more obvious after the first exposure to an immunogen. Most likely is a consequence of the fact that the antibodies produced early in the immune response are of low affinity and may not be detectable in assays that favor the detection of high-affinity antibodies. It is also possible that the co-stimulatory signals provided by T_H2 cells may enhance the immune response of neighboring B cells engaged in unrelated immune responses. This may result in the enhanced synthesis of antibodies reacting with other immunogens that the immune system is simultaneously recognizing. While the synthesis of unrelated antibodies is usually beneficial or inconsequential (see Chapter 14), it can also be the basis for at least some autoimmune reactions if strong help is provided to autoreactive B cells, which otherwise would remain quiescent (see Chapter 16)

III. THE PRIMARY IMMUNE RESPONSE

The first contact with an antigen evokes a primary response, which has the following characteristics:

1. There is a relatively long lag between the stimulus and the detection of antibodies by current methods (varying between 3–4 days after the injection of heterologous erythrocytes and 10–14 days after the injection of killed bacterial cells). Part of this variation depends on the sensitivity of antibody-detection methods, but it is also a reflection of the potency of the immunogen.
2. The first antibody class to be synthesized is usually IgM. Later in the response, IgG antibodies will predominate over IgM antibodies. This phenomenon, known as IgM-IgG switch, is controlled by different interleukins released by activated

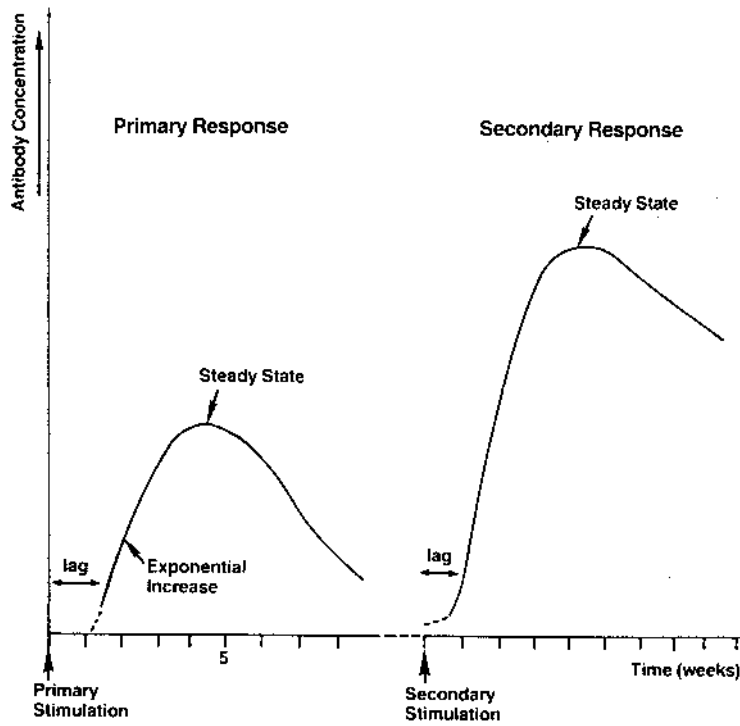

Fig. 12.1 Diagrammatic representation of the sequence of events during a primary and a secondary immune response. (Modified from Eisen, H. N. *Immunology*, 2nd ed. Harper & Row, Cambridge, 1980.)

helper T lymphocytes and by specific co-stimulatory signals mediated by CD28/CD80, CD40/CD40L, and CD21/CD23.

3. After rising exponentially for some time, antibody levels reach a steady state and then decline (Fig. 12.1). Adjuvant administration will keep the antibody levels high for months.

Several regulatory mechanisms will operate in order to turn off antibody production after the infectious agent (or any other type of immunogen) has been eliminated.

1. The elimination of the antigen will remove the most important positive signal. This is believed to be the most important factor determining the decline of a humoral immune response.
2. The increase in IgG concentration during the later stages of the primary response may lead to a general depression of IgG synthesis as a consequence of negative feedback regulation (see Chapter 6).
3. Suppressor cell activity increases as the immune response evolves and predominates after elimination of the antigen. The regulation of suppressor cells and the mechanisms of suppression are poorly understood aspects of the immune response. Several possibilities have been considered: (a) As the T_H2 activity predominates, several down regulatory cytokines are produced. IL-4 downregulates T_H1 cells, and IL-10 downregulates both T_H1 and T_H2 cells. T cells with suppressor activity persist after the antigen is eliminated, either as a consequence of

their late activation or of a longer life span. (b) As the immune response proceeds and IgG antibodies are synthesized, IgG-containing antigen-antibody complexes have been proposed to have a direct downregulating effect on B cells consequent to their binding through type II Fc γ receptors. (c) Anti-idiotypic antibodies develop during normal immune responses, reacting with variable-region epitopes or idiotypes presented by the antibodies produced against the antigen that elicited the immune response. The easiest way to understand this response is to accept that a normal state of low zone tolerance to the millions of idiotypes that are presented by antigen receptors can be broken when one or a few specific antibodies are produced in large concentrations, suddenly exposing the immune system to large concentrations of molecules with unique idiotypes. These antibodies are believed to participate in negative regulation of the immune response probably by binding to membrane immunoglobulins from antigen-specific B cells expressing variable regions of the same specificity as the antibody molecules that triggered the anti-idiotypic antibody. The binding of an antibody to a membrane immunoglobulin induces B-lymphocyte proliferation, but the proliferating B cells fail to differentiate into antibody-producing cells. At the same time, the occupancy of the membrane immunoglobulin binding sites by the anti-idiotypic antibodies prevents the proper antigenic stimulation of the B lymphocyte (Fig. 12.2).

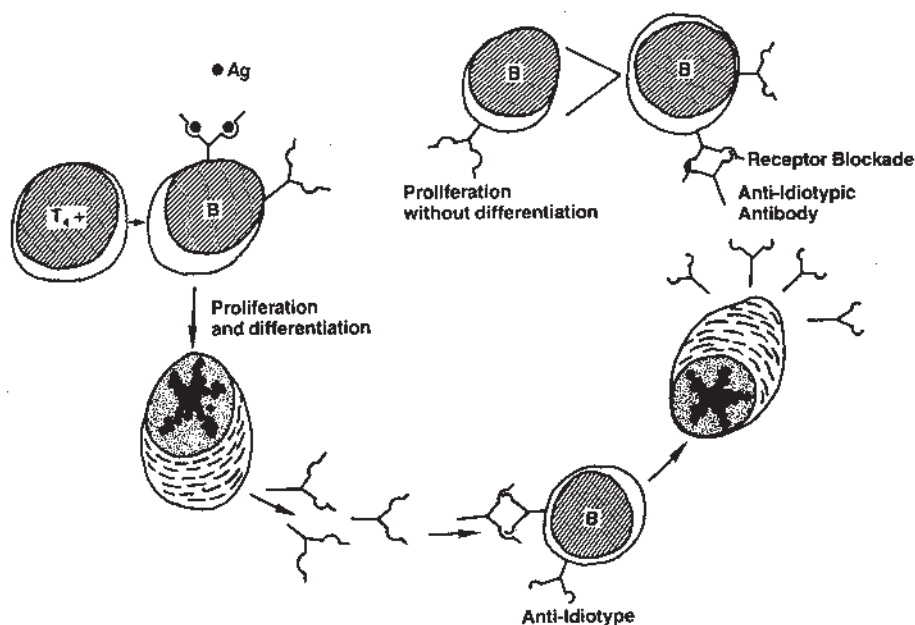

Fig. 12.2 The role of anti-idiotypic antibodies in downregulating the humoral immune response. From left to right, an antigen-stimulated B cell differentiates into a clone of plasma cells producing specific antibody. A second population of B cells, carrying a membrane immunoglobulin with specificity for the binding site of this first antibody (anti-idiotypic antibody), will be stimulated to proliferate and differentiate into a clone of plasma cells producing anti-idiotypic antibody. This second antibody will be able to bind to the antigen receptor of the cells involved in the initial responses, which will be stimulated to divide but not to differentiate into plasma cells; the antigen receptor will also be blocked from further reaction with the real antigen.

IV. THE SECONDARY OR ANAMNESTIC RESPONSE

Reexposure of immune animals or human beings to an immunizing antigen to which they have been previously exposed induces a secondary, recall, or anamnestic response. The capacity to mount a secondary immune response can persist for many years, providing long-lasting protection against reinfection.

The secondary response has some important characteristics—some dependent on the existence of an expanded population of memory cells, ready to be stimulated, and others dependent on the prolonged retention of antigen in the lymph nodes with continuous stimulation of B cells over long periods of time.

A. Differentiation of B Memory Cells.

During the peak of a primary response, there is a duality in the fate of activated B cells: while most will evolve into antibody-producing plasma cells, others will differentiate into memory B cells.

The differentiation of memory cells is believed to take place in the germinal centers of secondary lymphoid tissues. As a prememory B cell enters a follicle, it migrates into the germinal center, where it undergoes active proliferation. At this stage, the “switch” from IgM to IgG or other isotype synthesis is taking place and the V-region genes undergo somatic hypermutation. After completing this round of proliferation, the resulting memory B cells need additional signals for full differentiation:

1. Clones with high-affinity mlg in the membrane will be able to interact with antigen molecules immobilized by follicular dendritic cells. As a consequence, these clones will receive strong activation and differentiation signals. In contrast, clones with low-affinity mIg will not be able to compete with preformed antibody for binding to the immobilized antigen epitopes, will not receive adequate signals, and will undergo apoptosis.
2. The evolution of this antigen-stimulated memory B-cell precursor into a memory B cell requires a second signal provided by a helper T cell, in the form of the CD40/CD40L interaction. Other signals, such as the one delivered by the CD21/CD23 interaction, may result into direct evolution of the prememory B cell into an antibody-producing plasma cell.

B. Consequences of the Existence of an Expanded Population of Memory Cells

Four major features of a secondary immune response (Fig. 12.1) result from the existence of expanded populations of memory cells:

1. Lower threshold dose of immunogen, i.e., the dose of antigen necessary to induce a secondary response is lower than the dose required to induce a primary response.
2. Shorter lag phase, i.e., it takes a shorter time for antibody to be detected in circulation after immunization.
3. Faster increase in antibody concentrations and higher titers of antibody at the peak of the response.
4. Predominance of IgG antibody is characteristic of the secondary immune response, probably a consequence of the fact that memory B cells express IgG on their membranes and will produce IgG after stimulation.

C. Consequences of Prolonged Retention of Antigen and Persistent B-Cell Stimulation

Antigen-antibody complexes will form early in a secondary immune response and are taken up by follicular dendritic cells that express Fc γ receptors on their membrane. They remain associated with these cells for a long period of time, with the following consequences:

1. Longer persistence of antibody synthesis
2. Affinity maturation. It is known that the affinity of antibodies increases during the primary immune response and even more so in the secondary and subsequent responses. This maturation is a result of the selection of memory B cells with progressively higher affinity mIg antibodies during a persistent immune response. This selection is a direct consequence of the retention of antigen-antibody complexes by the follicular dendritic cells. The antigen moieties of the retained immune complexes are effectively presented to the immune system for as long as the complexes remain associated to the dendritic cells. As free antibodies and mIg compete for binding to the immobilized antigen, only B cells with mIg of higher affinity than the previously synthesized antibodies will be able to compete effectively and receive activation signals. Consequently, the affinity of the synthesized antibodies will show a steady increase.
3. Increased avidity and increased cross-reactivity. During a long-lasting secondary response to a complex immunogen, clones responding to minor determinants emerge. Cryptic epitopes that are not recognized in the primary immune response may also be recognized as a consequence of repeated stimulation. Therefore, a wider range of antibodies is produced in the secondary immune response. This results in increased avidity (as discussed in Chapter 8, avidity is the sum of binding forces mediated by different antibody molecules binding simultaneously to the same antigen). On the other hand, as the repertoire of antibodies recognizing different epitopes of a given immunogen increases, so do increase the probabilities for the emergence of cross-reactive antibodies recognizing antigenic determinants common to other immunogens.

V. THE FATE OF ANTIGENS ON THE PRIMARY AND SECONDARY RESPONSES

Following intravenous injection of a soluble antigen, its concentration in serum tends to decrease in three phases (Fig. 12.3):

1. Equilibration phase. This phase is characterized by a sharp decrease of brief duration corresponding to the equilibration of the antigen between intra- and extravascular spaces.
2. Metabolic decay. During this phase the antigen slowly decays due to its catabolic processing by the host.
3. Immune elimination. When antibodies start to be formed, there will be a phase of rapid immune elimination in which soluble antigen-antibody complexes will be formed and taken up by macrophages. The onset of this phase of immune elimination is shorter in the secondary immune response and virtually immediate if circulating antibody exists previously to the introduction of the antigen.

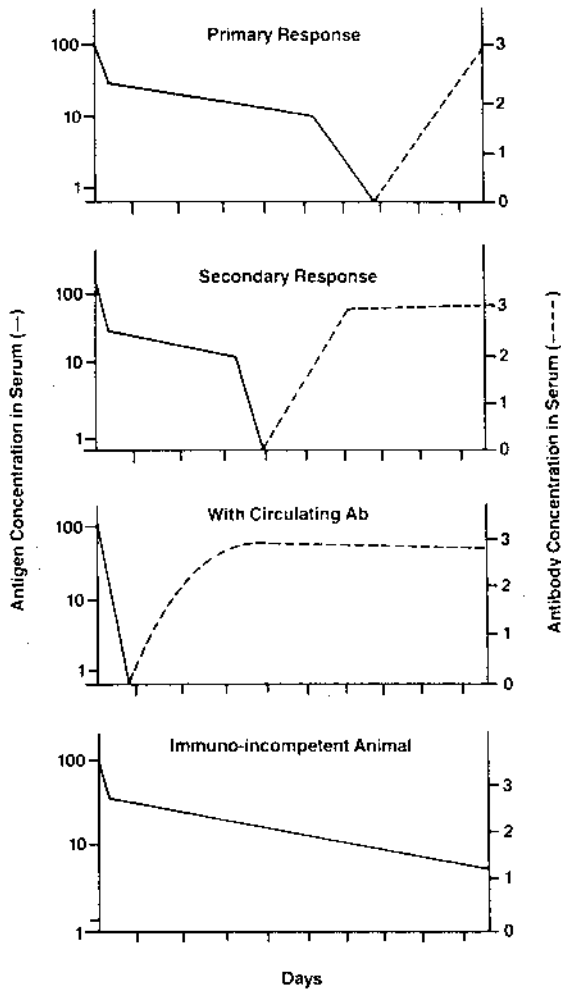

Fig. 12.3 Diagrammatic representation of the fate of injected antigen in a nonimmune animal, which will undergo primary immune response; an immune animal, which will show an accelerated, secondary response; an animal with circulating antibodies, which will very rapidly eliminate the corresponding antigen from circulation; and an immunocompetent animal, which will slowly metabolize the antigen. (Modified from Talmage, D. F., Dixon, F. J., Bukantz, S. C., and Damin, G. J. *J. Immunol.* 67:243, 1951.)

A similar sequence of events, with less distinct equilibration and metabolic decay phases, occurs in the case of particulate antigens. If the antigen is a live, multiplying organism, there might be an initial increase in the number of circulating or tissue-colonizing organisms, until the immune response promotes the elimination of the antigen by a variety of mechanisms (see Chapter 14).

VI. THE MUCOSAL HUMORAL IMMUNE RESPONSE

The gastrointestinal and respiratory mucosae are among the most common portals of entry used by infectious agents. Since this constant exposure only rarely results in clinical dis-

ease, it seems obvious that strongly protective mechanisms must exist at the mucosal level. Some of those protective mechanisms are nonspecific and of a physicochemical nature, including the integrity of mucosal surfaces, gastric pH, gastrointestinal traffic, proteases, and bile present in the intestinal lumen, as well as the flow of bronchial secretions, glucosidases, and bactericidal enzymes (e.g., lysozyme) found in respiratory secretions. At the same time, cell-mediated and humoral immune mechanisms are also operative in mucosal membranes.

A. Cell-Mediated Immune Mechanisms at the Mucosal Levels

Most evidence suggests that innate cell-mediated mechanisms predominate, including phagocytic cells and $\gamma\delta$ T lymphocytes.

1. Phagocytic cells (particularly macrophages) abound in the submucosa and represent an important mechanism for nonspecific elimination of particulate matter and microbial agents of limited virulence.
2. $\gamma\delta$ T lymphocytes are also present in large numbers in the submucosal tissues. It has been proposed that these cells seem able to cause the lysis of infected cells by MHC-independent recognition of altered glycosylation patterns of cell membrane glycoproteins or by recognition of cell-associated microbial superantigens.

B. Humoral Immunity at the Mucosal Level

A large volume of data has been compiled concerning the induction and physiological significance of humoral immunity at the mucosal level. A major established fact, supported by several lines of experimental work, is that the induction of secretory antibodies requires direct mucosal stimulation. Ogra and coworkers demonstrated that the systemic administration of an attenuated vaccine results in a systemic humoral response, while no secretory antibodies are detected. In contrast, topical immunization with live, attenuated poliovirus results in both a secretory IgA response and a systemic IgM-IgG response (Fig. 12.4).

In addition, it has been demonstrated that the stimulation of a given sector of the mucosal system (GI tract) may result in detectable responses on nonstimulated areas (upper respiratory tract). This protection of distant areas is compatible with the unitarian concept of a mucosal immunological network with constant traffic of immune cells from one sector to another (Fig. 12.5). For example, antigen-sensitized cells from the gut-associated lymphoid tissue (GALT), or from the peribronchial lymphoid tissues, enter the general circulation via the draining lymphatic vessels. Their systemic recirculation results in their migration towards the remaining secretory-associated lymphoid tissues including the gastrointestinal tract, the airways, the urinary tract, and the mammary, salivary, and cervical glands of the uterus.

C. Passive Transfer of Mucosal Immunity

In some mammalian species, milk-secreted antibodies are actively absorbed in the newborn's gut and constitute the main source of adoptive immunity in the neonate. This usually is observed in species in which there is limited or no placental transfer of antibodies. In mammals in which placental transfer of immunoglobulins is very effective (such as humans), the antibodies ingested with maternal milk are not absorbed. However, milk antibodies seem to provide passive immunity at the gastrointestinal level, which may be a

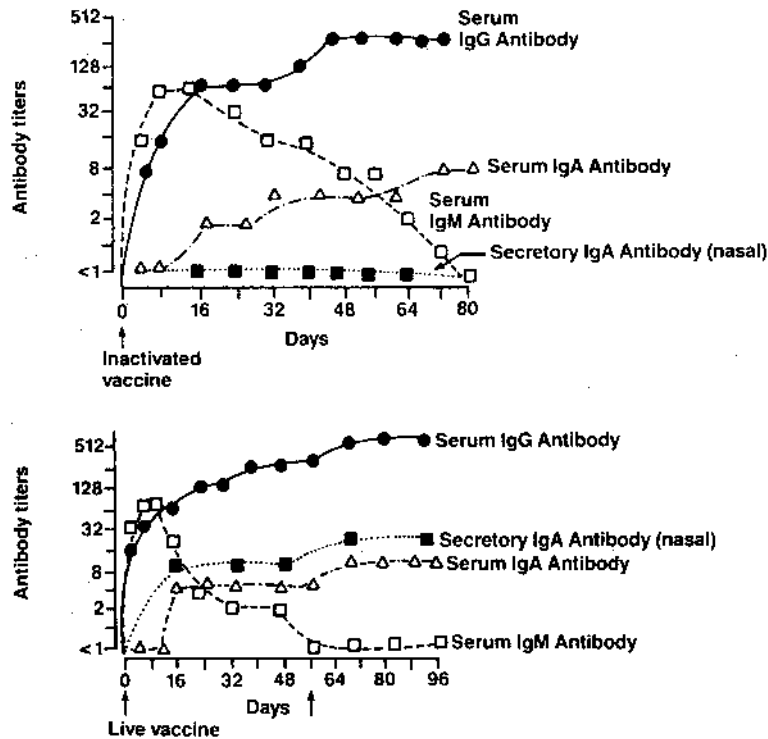

Fig. 12.4 Comparison of the systemic and mucosal immune responses in human volunteers given killed polio vaccine (top) and live, attenuated polio vaccine (bottom). Note that secretory antibody was only detected in children immunized with live, attenuated vaccine. (Modified from Ogra, P. L., Karzon, D. T., Roghthand, F., and MacGillivray, M. N. *Engl. J. Med.* 279:893, 1968.)

very important factor in preventing infectious gastroenteritis in the newborn, whose mucosal immune system is not fully developed.

D. Physiological Significance of Mucosal Immunity

The main immunological function of secretory IgA is believed to be to prevent microbial adherence to the mucosal epithelia, which usually precedes colonization and systemic invasion. However, in several experimental models it has been demonstrated that disease can be prevented without interference with infection, so there are unresolved questions concerning the anti-infectious mechanism(s) of secretory antibodies.

The relative importance of cellular versus humoral mucosal defense mechanism has not been properly established. However, many IgA-deficient individuals, with very low or absent circulating and secretory IgA, are totally asymptomatic, suggesting that cell-mediated mechanisms may play a significant protective role.

VII. IMMUNIZATION

A. Historical Background

The concept of active immunization as a way to prevent infectious diseases is about two centuries old, if we consider the introduction of cowpox vaccination by Jenner in 1796 as

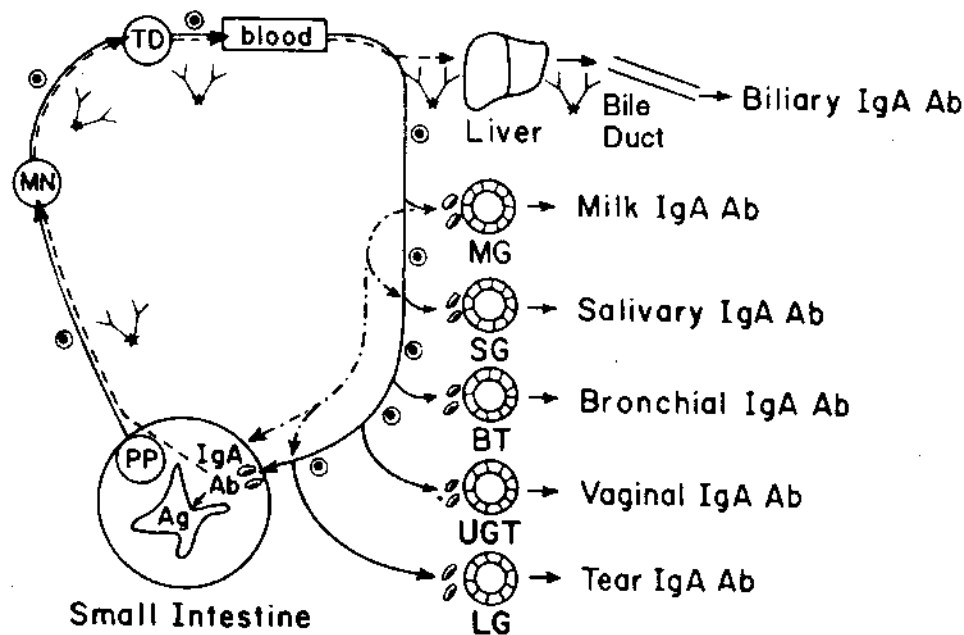

Fig. 12.5 Diagrammatic representation of the pathways leading to the expression of IgA antibodies after antigenic stimulation of the GALT. IgA immunocytes (*) originating in Peyer's patches (PP) migrate to mesenteric lymph nodes (MN). Cells leave MN via the thoracic duct (TD) and enter circulation with subsequent homing to the mammary gland (MG), salivary gland (SG), lacrimal gland (LG), and the lamina propria of the bronchial tree (BT), intestinal or urogenital tract (UGT) (*). The IgA antibodies are then expressed in milk, saliva, tears, and other secretions. IgA antibodies (---) entering circulation (---) are selectively removed by the liver and subsequently expressed in bile. Cell traffic between peripheral mucosal sites (- • - MG to SG, LG, and small intestine) is included in this scheme. (Reproduced with permission from Montgomery, P. C., Stander, C. A., and Majumdar, A. S. Evidence for migration of IgA bearing lymphocytes between peripheral mucosal sites. In *Protides of the Biological Fluids*, H. Peeters, ed. Pergamon, New York, 1985, p. 43.)

the starting point. Jenner observed that milkmaids that had contracted cowpox were protected from smallpox and developed an immunization procedure based on the intradermal scarification of material from cowpox lesions. Empirically, he had discovered the principle of vaccine with live, attenuated microbes, which was later picked up by Louis Pasteur when he developed several of his vaccines. As infectious agents became better characterized, new vaccines were developed, some with inactivated organisms, others with microbial components, others still with attenuated infectious agents. Mass vaccination has had some remarkable successes, such as the eradication of smallpox and the significant declines in some of the most common or most serious infectious diseases of childhood, such as measles and polio. At the present time we are witnessing a new burst of progress in vaccine development, reflecting the application of molecular genetics techniques to the rational development of immunizing agents.

B. Types of Vaccines

A wide variety of immunizing agents has been developed. The following are some examples of the types of immunizing agents that are used for immunoprophylaxis in humans.

1. Killed Vaccines

Killed vaccines are generally safe, but they are not as effective as attenuated vaccines.

1. Killed bacteria include the traditional pertussis vaccine prepared with killed *Bordetella pertussis*, the etiological agent of whooping cough, the typhoid vaccine prepared with acetone-inactivated *Salmonella typhi*, and the cholera vaccine, prepared with killed *Vibrio cholerae*. The killed *B. pertussis* vaccine was reported to cause neurological reactions similar to autoallergic encephalitis, particularly in children with a history of neonatal or postnatal seizures. However, these reactions are extremely rare and were mostly observed in Great Britain.
2. Inactivated viruses include the influenza vaccine, the hepatitis A vaccine, and Salk's polio vaccine. The inactivated poliovaccine contains a mixture of the three known types of poliovirus, after inactivation with formalin. This vaccine has been as successful in the eradication of poliomyelitis as Sabin's attenuated oral vaccine. Its main advantage is safety, but it is not as effective or amenable to mass immunizations as the oral vaccine (see below). However, safety concerns have resulted in its wider use in countries where poliomyelitis has been virtually eradicated, and there is greater risk of contracting polio from the attenuated vaccine than from a wild virus strain.

2. Component Vaccines

Component vaccines are even safer than killed vaccines, but their efficacy can be problematic.

Bacterial Polysaccharides. Bacterial polysaccharides, such as those used for *Streptococcus pneumoniae*, *Neisseria meningitidis*, and *Haemophilus influenzae* type b, and for a typhoid fever vaccine made of the Vi capsular polysaccharide. Because of their T-independent nature, polysaccharide vaccines are not very potent (especially in young children) and do not elicit long-lasting memory (see below).

Inactivated Toxins. Inactivated toxins (toxoids), such as tetanus and diphtheria toxoids, which are basically formalin-inactivated toxins, have lost their active site but maintained their immunogenic determinants. Toxoids are strongly immunogenic proteins and induce antibodies able to neutralize the toxins. The response to toxoids is associated with long-lasting memory.

Recombinant Bacterial Antigens. Recently, a recombinant *Rickettsia rickettsii* antigen produced in *E. coli* has been proposed as a candidate vaccine for Rocky Mountain spotted fever. Recombinant toxoids (e.g., recombinant pertussis toxin) have also been introduced in human vaccines. These differ from classical toxoids in that they are produced by genetically engineered organisms to which an altered gene coding for an inactive toxin (toxoid) has been introduced.

Mixed Component Vaccines. The interest in developing safer vaccines for whooping cough led to the introduction of acellular vaccines. These are constituted by a mixture of inactivated pertussis toxin or recombinant pertussis toxin (nontoxic due to the deletion of critical domains), a major determinant of the clinical disease, and one or several adhesion factors, which mediate attachment to mucosal epithelial cells. These vaccines have replaced the old vaccine prepared with killed *Bordetella pertussis*.

Conjugate Vaccines. Most polysaccharide vaccines have shown poor immunogenicity, particularly in infants. This lack of effectiveness is a consequence of the fact that polysaccharides tend to induce T-independent responses with little immunological mem-

ory. This problem appears to be eliminated if the polysaccharide is conjugated to an immunogenic protein, very much like a hapten-carrier conjugate.

The first conjugate vaccines to be developed involved the polyribositolribophosphate (PRP) of *Haemophilus influenzae* type b (Hib). Four conjugate vaccines have been successfully tested, the first three being currently approved by FDA:

1. PRP-OMPC, in which the carrier is an outer membrane protein complex of *Neisseria meningitidis*
2. Hib-OC, in which the carrier (OC) is a nontoxic mutant of diphtheria toxin
3. PRP-T, in which the carrier is diphtheria toxoid

The introduction of these vaccines was followed by a 95% decrease in the incidence of *H. influenzae* type b infections affecting children younger than 5 years of age.

A conjugate vaccine prepared with the capsular polysaccharides of the seven most common types of *Streptococcus pneumoniae* has received FDA approval for use in the pediatric population, and a conjugate vaccine for *Neisseria meningitidis* is currently being evaluated.

Viral Component Vaccines. Viral component vaccines are based on the immunogenicity of isolated viral constituents. The best example is the hepatitis B vaccine, produced by recombinant yeast cells. The gene coding for the hepatitis B surface antigen (HBsAg) was isolated from the hepatitis B virus and inserted into a vector, flanked by promoter and terminator sequences. That vector was used to transform yeast cells, from which HBsAg was purified. All the available hepatitis B vaccines are obtained by this procedure.

Some of the proposed HIV vaccines are component vaccines, constituted by envelope glycoproteins (gp160 or its fragment, gp120) or peptides derived from these glycoproteins, produced in genetically engineered *E. coli*, insect cells, and mammalian cell lines. These vaccines have not been proven to induce protective immunity (see Chapter 30).

Synthetic Peptide Vaccines. The use of synthetic peptides for vaccination has the advantages of easy manufacture and safety. The goal is to synthesize the peptide sequences corresponding to known epitopes recognized by neutralizing antibodies and use them as vaccines. This theoretically appealing concept meets with two basic problems. First, it is highly questionable that a synthetic oligopeptide has the same tertiary configuration as the epitope expressed by the native antigen and that protective antibodies can be elicited in this manner. However, if the objective is to induce cell-mediated immunity, this may not be an insurmountable obstacle. Second, small synthetic peptides are poorly immunogenic. The use of peptide-protein (e.g., tetanus toxoid) conjugates can minimize this problem.

The most promising work with synthetic peptide vaccines has been carried out with *Plasmodium* peptides. In a murine malaria model, immunization with a tetanus toxoid-*Plasmodium berghei* peptide conjugate resulted in rates of protection ranging from 75 to 87%, identical to those observed with a killed vaccine made of the whole parasite. In humans, efforts have been concentrated on the development of a vaccine against *Plasmodium falciparum*. A multirepeat region (approximately 40 repeats of the sequence Asn-Ala-Asn-Pro) of the circumsporozoite protein was identified as the immunodominant B-cell epitope and used as a model for a peptide-based vaccine. However, the rate of protection obtained in the first trials with this vaccine was too low (two out of nine subjects immunized were protected), probably because of differences in tertiary structure between the synthetic peptide and the *Plasmodium* epitope.

DNA Vaccines. The observation that intramuscular injection of nonreplicating plasmid DNA encoding the hemagglutinin (HA) or nucleoprotein (NP) of influenza virus elicited

humoral and cellular protective reactions attracted enormous interest from the scientific community. The recombinant DNA is taken up and expressed by APCs at the site of injection and is presented to T-helper cells in a way that both humoral and cell-mediated immune responses are elicited. The safety and easy storage of candidate DNA vaccines are extremely appealing and several different trials are ongoing. However, the initial impression from human trials is that DNA vaccines are far less potent in humans than they appear to be in experimental animals. At this point is too early to pass judgment on the practical value of DNA vaccines.

C. Attenuated Vaccines

Attenuated vaccines are generally very efficient but in rare cases can cause the very disease they are designed to prevent, particularly in immunocompromised individuals. Most antiviral vaccines are made of viral strains attenuated in the laboratory, including the classical smallpox vaccine, the oral polio vaccine (a mixture of attenuated strains of the three known types of poliovirus), the mumps-rubella-measles vaccine, and the varicella-zoster vaccine, recently approved by FDA. Attenuated viral vaccines tend to be very potent, probably because of the infective nature of the immunizing agent. In the case of poliovaccines, the attenuated virus can be transmitted by the fecal-oral route to nonimmunized individuals, thus increasing the proportion of immunized individuals in any given population. Another advantage of attenuated vaccines administered topically (by mouth or aerosol) is the simplicity of the immunization procedure. Thus, topically administered vaccines are ideally suited to mass immunization.

The bacillus of Calmette-Guérin (BCG), an attenuated strain of *Mycobacterium bovis*, has been used for decades as a vaccine for tuberculosis. Unfortunately the rates of protection obtained with this vaccine are rather variable, from 80% to 0%. The trials conducted in the United States were particularly disappointing and resulted in the lack of interest in BCG as an immunoprophylactic agent.

The application of molecular genetics techniques has resulted in the development of attenuated bacteria, which are finding applications in immunoprophylaxis. An attenuated strain of *Salmonella typhi* that grows poorly and is virtually nonpathogenic but induces protective immunity in 90% of the individuals is the recommended vaccine for typhoid fever. Mutant *Bordetella* strains that code for an immunogenic toxin lacking their binding sites (thus devoid of pathogenic effects) are being field-tested as whooping cough vaccines.

4. Recombinant Organisms

Recombinant technology has also been used to delete the genes coding for virulence factors from bacteria, creating genetically attenuated strains, as well as to add genetic information to attenuated viruses or attenuated bacteria, creating recombinant organisms to be used as immunizing agents. Recombinant vaccinia viruses, in which the genetic information coding for relevant antigens of unrelated viruses has been added to the vaccinia virus genome, have been developed and used successfully. Since the genome of vaccinia virus is rather large, multiple recombinant constructs carrying simultaneously the genes for the HBsAg, glycoprotein D for herpes virus, and influenza virus hemagglutinin, have been successfully generated. The potential value of these constructs is obvious, since they could induce protection against multiple diseases after a single immunization. In less ambitious animal trials, a recombinant vaccinia virus, carrying a retroviral *env* gene, protected mice against Friend leukemia virus. Another type of recombinant vaccinia virus expressing an immunodominant region of streptococcal M protein has been shown to reduce streptococcal colonization in mice after intranasal immunization.

Experimental vaccines for acquired immunodeficiency syndrome (AIDS) were developed by incorporating parts of the *env* gene of human immunodeficiency virus (HIV) into the vaccinia virus genome. Initial data suggested that recombinant HIV coding for the gp 120 vaccines of this type were more efficient in inducing cell-mediated immunity than component vaccines containing the same viral glycoprotein. A major concern, however, is the possibility of causing severe infections with this virus if it administered to individuals whose immune system is debilitated.

Recently there has been interest in generating recombinant BCG organisms as potentially more effective vaccines for tuberculosis. One of the earlier concepts was to add to the BCG genome the genes coding for IL-2, IL-4, IL-6, GM-CSF, and IFN- γ . This recombinant BCG was shown to induce strong protective immunity in an animal model. If this approach could be safely translated to the human vaccine, it would constitute a major medical breakthrough.

C. Recommended Immunizations

At the present time, a wide variety of vaccines are available for protection of the general population or of individuals at risk for a specific disease due to their occupation or to other factors. Fig. 12.6 summarizes the recommended schedule for active immunization of normal infants and children. Additional information concerning recommended immunizations for adults, travelers, special professions, etc., can be obtained in a variety of specialized

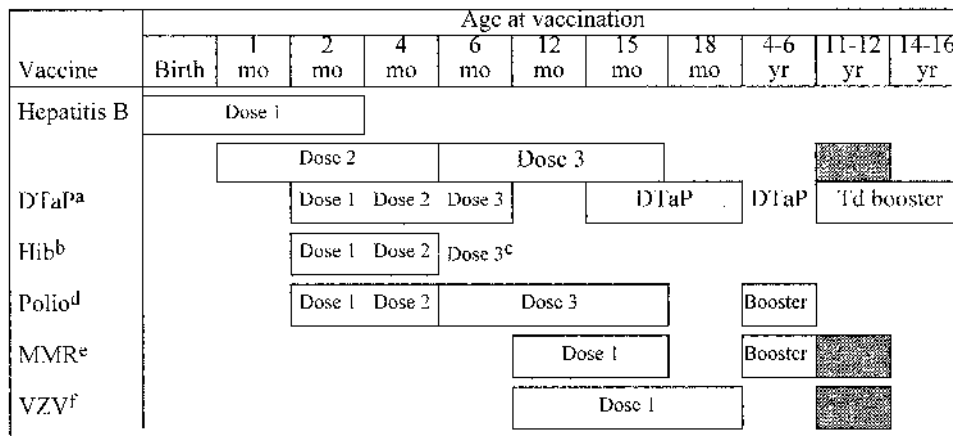

^a Diphtheria, tetanus, and acellular pertussis.
^b Haemophilus influenzae type b PRP-conjugate vaccine.
^c Third dose not needed if PRP-OMP is used.
^d Inactivated polio vaccine is recommended for routine vaccination in the U.S.
^e Measles, mumps, rubella.
^f Varicella-zoster virus vaccine.

Shaded boxes represent recommended schedules for vaccination of nonimmune or improperly immunized individuals.

Fig. 12.6 Childhood immunization schedule for the United States, January 1996—recommendations approved by the Advisory Committee on Immunization Practices, the American Academy of Pediatrics, and the American Academy of Family Physicians. (Modified from *Pediatrics* 105:148, 2000.)

publications, including the *Report of the Committee on Infectious Diseases*, published annually by the American Academy of Pediatrics, the booklet *Health Information of International Travel*, also published annually by the U.S. Public Health Service, and the *Morbidity and Mortality Weekly Report* published by the Centers for Disease Control in Atlanta.

D. Vaccines as Immunotherapeutic Agents

The use of vaccines to stimulate the immune system as therapy for chronic or latent infections is receiving considerable interest. Four areas of application have emerged:

1. Herpesvirus infections, in which vaccination seems to reduce the rate of recurrence
2. Leprosy, in which administration of BCG seems to potentiate the effects of chemotherapy
3. Tuberculosis, in which a new vaccine made of killed *Mycobacterium vaccae* seems also to potentiate the effects of antituberculosis drugs, even in patients resistant to therapy
4. HIV infection, in which vaccination with killed or recombinant HIV may alter the T_H1/T_H2 balance in favor of T_H1 , more effective mediators of anti-HIV responses. This approach is being actively pursued as part of immune reconstitution regimens for HIV-positive patients (see Chapter 30).

SELF-EVALUATION

Questions

Choose the one *best* answer.

- 12.1 Which one of the following most closely describes the biological basis of immunological memory?
 - A. Structural changes in the hypervariable region of IgG antibodies
 - B. Increased numbers of antigen-sensitive T and B cells
 - C. Increased synthesis of IL-2 by antigen-sensitive T cells
 - D. Predominant synthesis of IgG antibodies
 - E. Selection of B-cell clones producing high-affinity antibodies
- 12.2 In comparison with primary humoral immune responses, secondary humoral immune responses are characterized by:
 - A. A faster decline in antibody concentration after the steady state has been reached
 - B. Increased probability of detecting cross-reactive antibodies
 - C. Longer lag phases
 - D. Longer persistence of antigen in circulation
 - E. The need for greater doses of stimulating antigen
- 12.3 The half-life of an injected antigen is shortest when:
 - A. Preformed antibodies exist in circulation
 - B. T cells are not necessary to induce the immune response
 - C. The antigen is T-dependent
 - D. The synthesized antibody is of the IgM isotype
 - E. The injected animal has been previously immunized with the same antigen

- 12.4 Which of the following is a significant characteristic of the mucosal humoral immune response?
- A. It is characterized by predominant synthesis of IgG antibodies.
 - B. It is essential for the maintenance of an infection-free state.
 - C. It is localized to the mucosal segment that is directly challenged.
 - D. It leads to complement-dependent killing of many infectious agents.
 - E. It to be elicited by requires direct antigenic challenge of the mucosa.
- 12.5 The main difference between killed polio vaccine (Salk) and attenuated polio vaccine (Sabin) is that only the latter induces:
- A. Circulating complement-fixing antibodies
 - B. Circulating neutralizing antibodies
 - C. Memory
 - D. Protection against viral dissemination through the bloodstream
 - E. Secretory IgA antibodies
- 12.6 Which of the following is the main advantage derived from the coupling of poorly immunogenic peptides or polysaccharides to immunogenic proteins?
- A. Adjuvanticity of bacterial toxoids, eliminating the need for the use of inorganic adjuvants
 - B. Conversion of poorly immunogenic compounds into integral components of an immunogenic "haptent"-carrier conjugate
 - C. Lesser toxicity of the toxoid-peptide or toxic-polysaccharide conjugates
 - D. More efficient elicitation of cell-mediated immunity
 - E. Simultaneous immunization against more than one antigen
- 12.7 Which one of the following events is *less* likely to have a negative feedback effect on an ongoing humoral immune response?
- A. Activation of T_H1 lymphocytes
 - B. Elimination of the antigen
 - C. Formation of immune complexes
 - D. Production of cross-reactive antibodies directed against related antigens
 - E. Reaction of anti-idiotypic antibodies with mIg on the B-cell membrane
- 12.8 The initial activation of a primary anti-infectious response is likely to be dependent on the:
- A. Existence of cross-reactive antibodies
 - B. Nonimmunological uptake of the infectious agent by APC
 - C. Nonspecific activation of macrophages by microbial products
 - D. T-independent stimulation of B cells
- 12.9 Which one of the following is a unique consequence of the antigenic stimulation of the peri-intestinal immune system?
- A. A systemic response with characteristics identical to those obtained when the antigen is injected by the intramuscular route
 - B. Diffusion of secretory IgA synthesized in the Peyer's patches into the systemic circulation
 - C. Increased differentiation of B cells with mIgA in the bone marrow
 - D. Migration of sensitized B cells from the peri-intestinal tissues to other peri-mucosal lymphoid areas
 - E. Production of secretory antibody limited to the intestine

- 12.10 Which one of the following is the most likely consequence of injecting human albumin intravenously into a previously immunized rabbit with anti-human albumin antibodies in circulation?
- A new burst of IgM antibody synthesis
 - Formation of circulating immune complexes
 - Immediate increase in the levels of circulating anti-albumin antibody
 - Immediate release of histamine from circulating neutrophils
 - Massive activation of T_H2 cells

Answers

- 12.1 (B) Memory cells include both T and B lymphocytes that will be able to respond faster and more energetically to a second antigenic challenge.
- 12.2 (B) In a secondary immune response, the antibody repertoire increases, and as a result, the probability of a cross-reaction also increases.
- 12.3 (A) The immune elimination phase is immediately evident when the injected animal has preformed antibodies, which will immediately combine with the antigen and promote its elimination from circulation.
- 12.4 (E) Systemic administration of antigen never stimulates mucosal responses. Many individuals with severely depressed levels of mucosal IgA live free of infections, which raises questions concerning whether IgA is the only, or the main, exponent of mucosal immunity.
- 12.5 (E) Only the attenuated vaccine, given orally, can induce mucosal immunity. However, both vaccines induce systemic immunity and elicit immunological memory.
- 12.6 (B) The toxoid-polysaccharide and toxoid-peptide vaccines are comparable to hapten-carrier conjugates. Toxoids, acting as carriers, are recognized by T cells and effectively recruit T-cell help, thus enhancing the immune response and ensuring the development of immunological memory.
- 12.7 (D) Cross-reactive antibodies against related antigens have not been implicated in any theory concerning the downregulation of the immune response. Activation of T_H1 lymphocytes, on the other hand, would result in the synthesis of interferon- γ , which downregulates T_H2 cells, which are those primarily assisting the humoral immune response.
- 12.8 (B) The most potent APC are the dendritic cells found in the paracortical area and macrophages. Those cells have receptors that allow phagocytosis in the absence of antibody, and although the efficiency of nonimmunological phagocytosis is rather limited, it is likely to be sufficient to allow ingestion, processing, and presentation of microbial-derived peptides to the immune system.
- 12.9 (D) Mucosal stimulation is always associated with a local response. Systemic responses are only observed when a replicating organism is used as the immunizing agent. The local response propagates to areas not directly stimulated by traffic of sensitized B lymphocytes.
- 12.10 (B) Given the fact that circulating antibodies are already present, the injection of albumin will be associated with almost immediate formation of immune complexes, which will be quickly taken up by phagocytic cells. The concentration of albumin will fall rapidly, and the concentration of

anti-albumin antibody will show a transient decrease. Histamine could be released if the animal had produced IgE antibodies; however, the cells that release histamine are basophils, not neutrophils.

BIBLIOGRAPHY

- Ahmed, R., and Gray, D. Immunological memory and protective immunity: Understanding their relation. *Science* 272:54, 1996.
- Bektimirov, T., Lambert, P. H., and Torrigiani, G. Vaccine development: Perspectives of the World Health Organization. *J. Med. Virol.* 31:62, 1990.
- Boismenu, R., and Havran, W. $\gamma\delta$ T cells in host defense and epithelial cell biology. *Clin. Immunol. Immunopath.* 86:121, 1998.
- Churchill, R. B., and Pickering, L. K. The pros (many) and cons (few) of breastfeeding. *Contemporary Pediatrics* 15:108, 1998.
- Källberg, E., Jainandunsing, S., Gray, D., and Leanderson, T. Somatic mutation of immunoglobulin V genes in vitro. *Science* 271:1285, 1996.
- Klaus, G. G. B., Humphrey, J. H., Kunkel, A., and Dongworth, D. W. The follicular dendritic cell: Its role in antigen presentation in the generation of immunological memory. *Immunol. Rev.* 53:3, 1980.
- Kniskern, P. J., Marburg S., and Ellis, R. W. Haemophilus influenzae type b conjugate vaccines. *Pharm. Biotechnol.* 6:673, 1995.
- Levine, M. M., Woodrow, G. C., Kaper, J. B., and Cobon, G. S., eds. New Generation Vaccines. 2nd ed. Marcel Dekker, New York, 1997.
- Liu, M. A. Overview of DNA vaccines. *Ann. NY Acad. Sci. USA* 772:15, 1995.
- Mestecky, J., Lue, C., and Russell, M. W. Selective transport of IgA. Cellular and molecular aspects. *Gastroenterol. Clin. North Am.* 20:441, 1991.
- Moffat, A. S. Exploring transgenic plants as a new vaccine source. *Science* 268:658, 1995.
- Prevots, D. R., and Strebel, P. M. Poliomyelitis prevention in the United States: New recommendations for routine childhood vaccination place greater reliance on inactivated poliovirus vaccine. *Pediatr. Ann.* 26:378, 1997.
- Sabin, A. B. Oral poliovirus vaccine: History of its development and use and current challenge to eliminate poliomyelitis from the world. *J. Infect. Dis.* 151:420, 1985.
- Wong, S. Y., Ho, K. S., Mason, H. S., and Arntzen, C. J. Edible vaccines. *Sci. Am. Sci. Med.* 5:36, 1998.

13

Phagocytic Cells

Gabriel Virella

I. INTRODUCTION

The failure or success of an antibody response directed against an infectious agent depends entirely on their ability to trigger the complement system and/or to induce phagocytosis. Most mammals, including humans, have developed two well-defined systems of phagocytic cells: the polymorphonuclear leukocyte system (particularly the neutrophil population) and the monocyte/macrophage system. Both types of cells can engulf microorganisms and cause their intracellular death through a variety of enzymatic systems, but they differ considerably in their biological characteristics.

II. PHYSIOLOGY OF THE POLYMORPHONUCLEAR LEUKOCYTES

Neutrophils and other polymorphonuclear (PMN) leukocytes are “wandering” cells, constantly circulating around the vascular network, able to recognize foreign matter by a wide variety of immunological and nonimmunological mechanisms. Their main biological characteristics are summarized in Table 13.1. Their effective participation in an anti-infectious response depends on the ability to respond to chemotactic signals, ingest the pathogenic agent, and kill the ingested microbes.

A. Chemotaxis and Migration to the Extravascular Compartment

In normal conditions, the interaction between leukocytes and endothelial cells is rather loose and involves a family of molecules known as selectins, which are constitutively ex-

Table 13.1 Comparison of the Characteristics of PMN Leukocytes and Monocytes/Macrophages

Characteristic	PMN leukocytes	Monocyte/Macrophage
Numbers in peripheral blood	$3-6 \times 10^3/\mu\text{L}$	285-500/ μL
Resident forms in tissues	-	+ (macrophage)
Nonimmunological phagocytosis	++	+
Fc receptors	Fc γ RII, III	Fc γ RI, II, III
C3b receptors	++	++
Enzymatic granules	++	++
Bactericidal enzymes	++	++
Ability to generate superoxide and H ₂ O ₂	+++	++
Synthesis and release of leukotrienes	+ (B ₄)	++ (B ₄ , C ₄ , D ₄)
Synthesis and release of prostaglandins	-	++
PAF release/response	++	±
Response to nonimmunological chemotactic factors	+	-
Response to C5a/C3a	+	-
Response to cytokines	+ (IL-8)	++ (IFN- γ)
Release of cytokines	+	++
Antigen processing	-	++
Expression of HLA class II antigens	-	++
Phagocytosis-independent enzyme release	++	-

pressed on endothelial cells and glycoproteins expressed on the leukocyte cell membrane. These interactions cause the slowing down (“rolling”) of leukocytes along the vessel wall but do not lead to firm adhesion of leukocytes to endothelial cells.

A variety of chemotactic stimuli can be involved in the recruitment of leukocytes to the extravascular space. In most cases those chemotactic factors are of bacterial origin, but they can also be released as a consequence of tissue necrosis, as a result of monocyte and lymphocyte activation, or as a by-product of complement activation. Among bacterial products, formyl-methionyl peptides, such as f-methionine-leucine-phenylalanine (f-met-leu-phe), are extremely potent chemotactic agents.

Complement-derived chemotactic factors can be generated in several ways. Tissue damage may result in the activation of the plasmin system, which may in turn initiate complement activation with generation of C5a. After the inflammatory process has been established, proteases released by activated neutrophils and macrophages can also split C5, and the same cells may release leukotriene B₄, another potent chemotactic factor, attracting more neutrophils to the site. On the other hand, many microorganisms can generate C5a by activation of the complement system through the alternative pathway. Finally, activated T cells and monocytes can also release chemokines such as IL-8, monocyte chemotactic protein-1, and RANTES, which have neutrophils and/or monocytes as targets.

After receiving a chemotactic stimulus, the neutrophil undergoes changes in the cell membrane, which is smooth in the resting cell, and becomes “ruffled” after the cell receives the chemotactic signal. The activated PMN leukocyte has a marked increase in cell adhesiveness, associated with increased expression of adherence molecules, namely integrins of the CD11/CD18 complex, which include:

- CD11a [the α chain of LFA (leukocyte function antigen)-1]
- CD11b (the C3b receptor or CR3, also known as Mac-1)

CD11c (also known as protein p150,95)
CD18 [the β chain of LFA (leukocyte function antigen)-1]

These cell adhesion molecules (CAM) are common to the majority of leukocytes, but their individual density and frequency may vary in the two main groups of phagocytic cells. While CD11a and CD18 are expressed virtually by all monocytes and granulocytes, CD11b is more prevalent among granulocytes and CD11c is more frequent among monocytes.

The expression of these CAM mediates a variety of cell-cell interactions, such as those that lead to neutrophil aggregation and, most importantly, those that mediate firm adhesion of neutrophils to endothelial cells. For example, CD11a (LFA-1) and CD11b interact with molecules of the immunoglobulin gene family, such as ICAM-1, ICAM-2, and VCAM-1, expressed on the endothelial cell membrane. The expression of VCAM-1 and, to a lesser degree, of ICAM-1 and -2 is also upregulated by cytokines released by activated monocytes and lymphocytes, such as IL-1 and TNF. Consequently, the adhesion of leukocytes to endothelial cells is further enhanced.

After adhering to endothelial cells, leukocytes migrate to the extravascular compartment. The transmigration involves interaction with a fourth member of the immunoglobulin gene family—platelet endothelial cell adhesion molecule 1 (PECAM-1)—which is expressed at the intercellular junctions between endothelial cells. The interaction of leukocytes with PECAM-1 mediates the process of diapedesis, by which leukocytes squeeze through the endothelial cell junctions into the extravascular compartment.

The diapedesis process involves the locomotor apparatus of the neutrophils, a contractile actin-myosin system stabilized by polymerized microtubules. Its activation is essential for the neutrophil to move into the extravascular space, and an intact CD11b protein seems essential for the proper modulation of microtubule assembly, which will not take place in CD11b-deficient patients.

B. Phagocytosis

At the area of infection, PMN leukocytes recognize the infectious agents, which are ingested and killed intracellularly. The sequence of events leading to opsonization and intracellular killing is summarized in Figure 13.1.

Several recognition systems appear to be involved in the phagocytosis step. The most important recognition systems are those that mediate the ingestion of opsonized particles. Two major types of receptors expressed by phagocytic cells are involved in this process:

1. Fc γ receptors are predominantly involved in promoting ingestion of antibody-coated particles. Neutrophils express two types of Fc γ receptors, Fc γ RII and Fc γ RIII, both of which are involved in phagocytosis. In experimental conditions, Fc α receptors may also be involved in phagocytosis, but their efficiency seems to be much lower than that of Fc γ receptors.
2. The CR1 (C3b) receptor is also able to mediate phagocytosis with high efficiency. This receptor is expressed by all phagocytic cells, including polymorphonuclear leukocytes, monocytes, and macrophages. The binding and ingestion of microorganisms through this receptor has been well established.

Opsonization with both IgG antibodies and C3b seems associated with maximal efficiency in ingestion.

Opsonization is not an absolute requirement for ingestion by neutrophils. A variety of receptors may be involved in nonimmune phagocytosis, as described in greater detail in

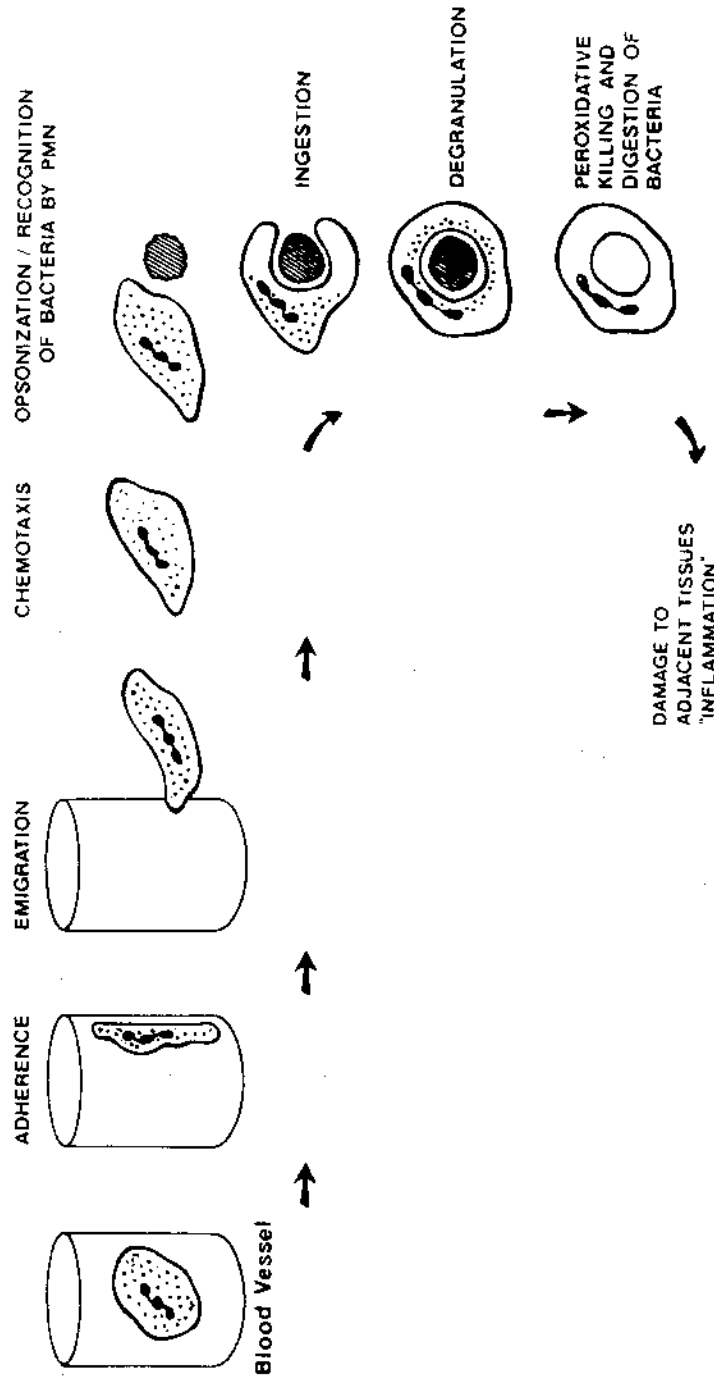

Fig. 13.1 Diagrammatic representation of the sequence of events that takes place during PMN leukocyte phagocytosis. (Reproduced with permission from Wolach, B., Baehner, R. L., and Boxer, L. A. *Israel J. Med. Sci.* 18:897, 1982.)

Chapter 14. These nonimmune mechanisms are particularly effective in promoting the ingestion of microorganisms with polysaccharide-rich outer layers. In addition, neutrophils are also able to ingest a variety of particulate matter, such as latex beads, silicone, asbestos fibers, etc., in the absence of opsonizing antibodies or complement.

C. Intracellular Killing

No matter the nature of the receptors that may mediate it, ingestion is achieved through formation of pseudopodia that surround the particle or bacteria, eventually fusing at the distal pole to form a phagosome. The cytoplasmic granules of the neutrophil (lysosomes) then fuse with the phagosomes, and their contents empty inside the phagosomes (degranulation). This degranulation process is very rapid and delivers a variety of antimicrobial substances to the phagosome:

The azurophilic or primary granules contain, among other substances, myeloperoxidase, lysozyme, acid hydrolases (such as β -glucuronidase), cationic proteins, defensins, metalloproteinases (including proteases and collagenases), elastase, and cathepsin C2.

The secondary granules or lysosomes contain lysozyme and lactoferrin.

Killing of ingested organisms depends on the effects of cationic proteins from the primary granules, lysosomal enzymes, such as lysozyme and lactoferrin, defensins, nitric oxide, and by-products of the respiratory burst, activated as a consequence of phagocytosis.

Cationic proteins bind to negatively charged cell surfaces (such as the bacterial outer membrane) and interfere with microbial growth. Lactoferrin has antimicrobial activity by chelating iron and preventing its use by bacteria that need it as an essential nutrient.

Lysozyme splits the β -1,4 linkage between the *N*-acetylmuramic acid peptide and *N*-acetylglucosamine on the bacterial peptidoglycan. Some bacteria are exquisitely sensitive to the effects of this enzyme, which causes almost immediate lysis. However, the importance of this enzyme as a primary killing mechanism has been questioned due to the relative inaccessibility of the peptidoglycan layer in many microorganisms, which may be surrounded by capsules or by the lipopolysaccharide-rich outer membrane (gram-negative bacteria).

Defensins are antimicrobial peptides released by almost all eukaryotic species, including plants, invertebrate animals, and vertebrate animals. Structurally, defensins are cationic molecules with spatially separated hydrophobic and charges regions, which insert themselves into phospholipid membranes, causing their disruption. In mammals, defensins are produced by specialized mucosal cells (i.e., the Paneth cells in the gut) and by phagocytic cells. The mucosal defensins are believed to play an important role protecting mucosal cells from pathogenic bacteria. The neutrophil defensins are packaged on the azurophilic granules and are delivered to the phagosomes and also spilled into the extracellular environment.

From a bactericidal point of view, the activation of the superoxide generating system (respiratory burst) appears considerably more significant. This system is activated primarily by opsonization, but also by a variety of PMN leukocyte-activating stimuli, ranging from f-met-leu-phe to C5a. The activating stimuli are responsible for the induction of a key enzymatic activity (NADPH oxidase), a molecular complex located on the cell membrane responsible for the transfer of a single electron from NADPH to oxygen, generating superoxide (O_2^-).

The molecules responsible for NADPH oxidase activity are:

Cytochrome B244, which is a heterodimer formed by two polypeptide chains (91 and 22 kDa, respectively), believed to play the key role in the reduction of oxygen to superoxide, possibly by being the terminal electron donor

Two cytosolic proteins—p47 and p67—one of which (p47) is a substrate for protein kinase C

p21^{rac}, an ubiquitous ras-related GTPase

In a resting cell the complex is inactive and its components are not associated. After the cell is activated, p47 is phosphorylated and becomes associated with p67 and with p21^{rac}. The phosphorylated complex binds to cytochrome B244 in the lysosomal membranes, forming what is considered to be the active oxidase.

The electron transfer from NADPH to oxygen is believed to involve at least three steps:

1. Reduction of a flavin adenine dinucleotide (FAD), bound to the high molecular weight subunit of cytochrome B
2. Transfer of an electron from FADH₂ to ferric iron in a heme molecule associated to the low molecular weight subunit of cytochrome B
3. Transfer of an electron from reduced iron to oxygen, generating superoxide

The formation of the active molecular complex with oxidase activity coincides with phagolysosome fusion. Thus, most of the active oxygen radicals generated by this system are delivered to the phagolysosome (Fig. 13.2).

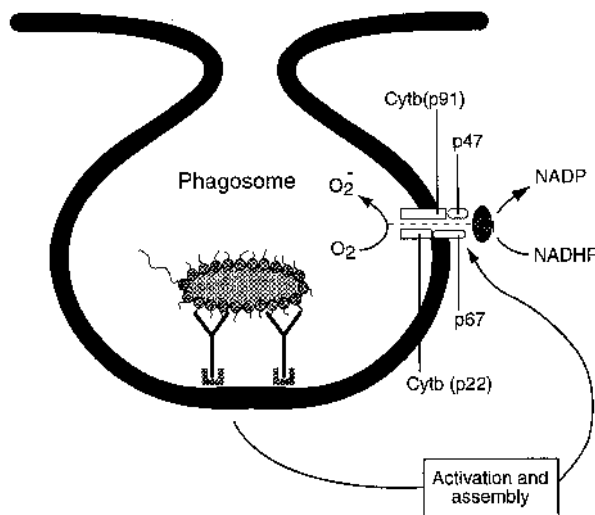

Fig. 13.2 Diagrammatic representation of the major events involved in the respiratory burst of phagocytic cells. The occupancy of Fc and/or CR1 receptors triggers the activation sequence, which involves protein kinase activation, enzyme activation, and phosphorylation of at least one cytosolic protein (p47). As a result, a molecular complex, constituted by cytochrome B (Cytb), p47, and p67, is assembled on the cell membrane, which is folding to constitute a phagosome. This complex has NADPH oxidase activity, oxidizes NADPH, and transfers the resulting electron to an oxygen molecule, resulting in the formation of superoxide (O₂⁻).

The respiratory burst generates two toxic compounds essential for intracellular killing of bacteria: superoxide and H_2O_2 . Through myeloperoxidase, H_2O_2 can be peroxidated and led to form hypochlorite and other halide ion derivatives, which are also potent bactericidal agents. These compounds are also toxic to the cell, particularly superoxide, which can diffuse into the cytoplasm. The cell has several detoxifying systems, including superoxide dismutase, which converts superoxide into H_2O_2 , and in turn, H_2O_2 is detoxified by catalase and by the oxidation of reduced glutathione, which requires activation of the hexose monophosphate shunt.

Activated phagocytic cells also express an inducible form of nitric oxide synthase (iNOS), which generates nitric oxide (NO) from arginine and molecular oxygen, using a variety of cofactors that include NADPH. Nitric oxide is a short-lived, highly cytotoxic free radical gas, which is believed to contribute significantly to intracellular killing. It can also participate in the induction of inflammatory reactions when spilled into the extracellular space.

III. PHYSIOLOGY OF THE MONOCYTE/MACROPHAGE

A. Comparison of PMN Leukocytes and Monocyte/Macrophages

The two populations of phagocytic cells share many common characteristics, such as

- Presence of $Fc\gamma$ and C3b receptors on their membranes
- Ability to engulf bacteria and particles
- Metabolic and enzymatic killing mechanisms and pathways

In contrast, other functions and metabolic pathways differ considerably between these two types of cells (see Table 13.1). One important distinguishing feature is the involvement of the monocyte/macrophage series of cells in the inductive stages of the immune response, due to their ability to process antigens and present antigen-derived peptides to the immune system. The monocyte/macrophage is also involved in immunoregulatory signals, providing both activating signals (in the form of IL-1, IL-6, and IL-12) and downregulating signals (in the form of PGE_2) to T lymphocytes.

These two types of phagocytic cells have different preferences as far as phagocytosis is concerned. For example, PMN leukocytes are able to ingest inert particles such as latex but have very little ability to engulf antibody-coated homologous erythrocytes, while the reverse is true for the monocyte/macrophage. On the other hand, while neutrophils seem to be constitutively ready to ingest particulate matter, the circulating monocytes and the tissue-fixed (resident) macrophages are usually resting cells that need to be activated by several types of stimuli before they can fully express their phagocytic and killing properties. The activating factors include microorganisms or their products and cytokines. The main activating cytokine is interferon- γ , released by activated T_H1 cells.

B. The Activated Macrophage

This cell type has unique morphological and functional characteristics. Morphologically, the activated macrophage is larger, and its cytoplasm tends to spread and attach to surfaces. The composition of the plasma membrane is changed, and the rates of pinocytosis and engulfment are increased (phagocytosis through C3b receptors is only seen after activation). Intracellularly, there is a marked increase in enzymatic contents, particularly of plasmino-

gen activator, collagenase, and elastase, and the oxidative metabolism (leading to generation of superoxide and H_2O_2) as well as the activity of iNOS are greatly enhanced.

C. Phagocytosis of Dead Cells

As cells die, either by apoptosis or by necrosis, they express cell membrane markers that allow ingestion by macrophages, dendritic cells, and related cells. This results in the presentation of peptides derived from the dead cells on MHC-I molecules, which in turn may be involved in the induction of autoimmune responses. In physiological conditions the ingestion of dead cells by tissue macrophages is associated with the release of anti-inflammatory cytokines such as TGF- β and IL-10, and the immune system remains ignorant of the presented self peptides. However, upon presentation of peptides derived from ingested dead cells in association with MHC-I molecules by dendritic cells, a CD8⁺ immune response against those peptides is elicited. It can be theorized that if the dead cells are ingested in non-physiological conditions, e.g., as a consequence of the reaction against an infective agent, the likelihood for uptake and presentation in conditions favorable to the induction of an immune response increases. Such immune responses have been postulated to play a significant role in the emergence of autoimmune diseases (see Chapters 16 and 17).

III. LABORATORY EVALUATION OF PHAGOCYtic FUNCTION

The evaluation of phagocytic function is usually centered on the study of neutrophils, which are considerably easier to isolate than monocytes or macrophages. Phagocytosis by neutrophils can be depressed as a result of reduction in cell numbers or as a result of a functional defect. Functional defects affecting every single stage of the phagocytic response have been reported and are evaluated by different tests. The following is a summary of the most important tests used to evaluate phagocytic function.

A. Neutrophil Count

This is the simplest and one of the most important tests to perform since phagocytic defects due to neutropenia are, by far, more common than the primary, congenital defects of phagocytic function. As a rule, it is believed that a neutrophil count below 1000/ μ L represents an increased risk of infection, and when neutrophil counts are lower than 200/ μ L, the patient will invariably be infected.

B. Adherence

The increased adherence of activated phagocytic cells to endothelial surfaces is critical for the migration of these cells to infectious foci. Although specialized tests have been developed to measure aggregation and adherence of neutrophils in response to stimuli such as C5a_{desarg} (a nonchemotactic derivative of C5a), presently this property is evaluated indirectly by determining the expression of the different components of CD11/CD18 complex, which mediate adhesion by flow cytometry.

C. Chemotaxis and Migration

The migration of phagocytes in response to chemotactic stimuli can be studied *in vitro* using the Boyden chamber. The basic principle of all versions of the Boyden chamber is to

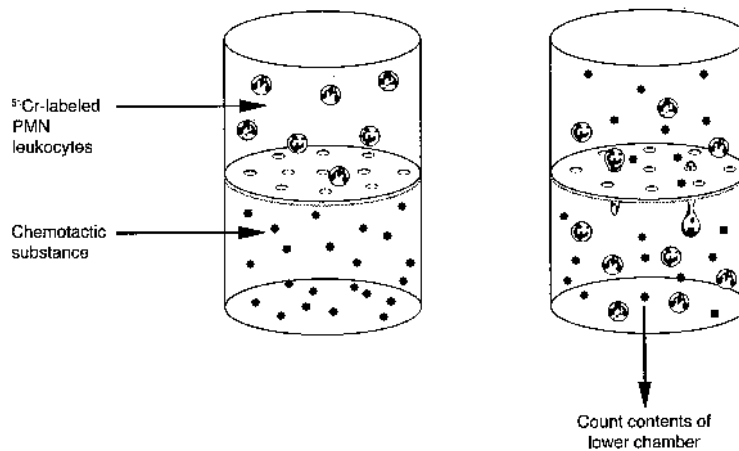

Fig. 13.3 Schematic representation of the principle of chemotaxis assays using the Boyden chamber and ^{51}Cr -labeled PMN leukocytes.

have two compartments separated by a membrane with pores too tight to allow PMN leukocytes to passively diffuse from one chamber to the other but large enough to allow the active movement of these cells from the upper chamber, where they are placed, to the lower chamber.

The movement of the cells is stimulated by adding to the lower chamber a chemotactic factor such as C5a, the bacterial tetrapeptide f-met-leu-phe, IL-8, leukotriene B4, or platelet-activating factor (PAF). The results are usually based on either counting the number of cells that reached the bottom side of the membrane or on the indirect determination of the number of cells reaching the bottom chamber using ^{51}Cr -labeled PMN leukocytes (as illustrated in Fig. 13.3).

It must be noted that all versions of this technique are difficult to reproduce and standardize and are not used in routine laboratory diagnosis.

D. Ingestion

Ingestion tests are relatively simple to perform and reproduce. They are usually based on incubating PMN with opsonized particles and, after an adequate incubation, determining either the number of ingested particles or a phagocytic index:

$$\text{Phagocytic index} = \frac{\text{No. of cells with ingested particles}}{\text{Total no. of cells}} \times 100$$

Several types of particles have been used, including latex, zymosan (fragments of fungal capsular polysaccharidic material), killed *Candida albicans*, and IgG-coated beads (Immunobeads). All these particles will activate complement by one of the pathways and become coated with C3, although opsonization with complement is not the major determinant of phagocytosis. The easiest particles to visualize once ingested are fluorescent latex beads; their use considerably simplifies the assay (Fig. 13.4), particularly if performed in a flow cytometer.

Ingestion tests are also not used routinely because other tests are available (e.g., the nitroblue tetrazolium reduction test; see below) that test both for ingestion and for the ability to mount a respiratory burst.

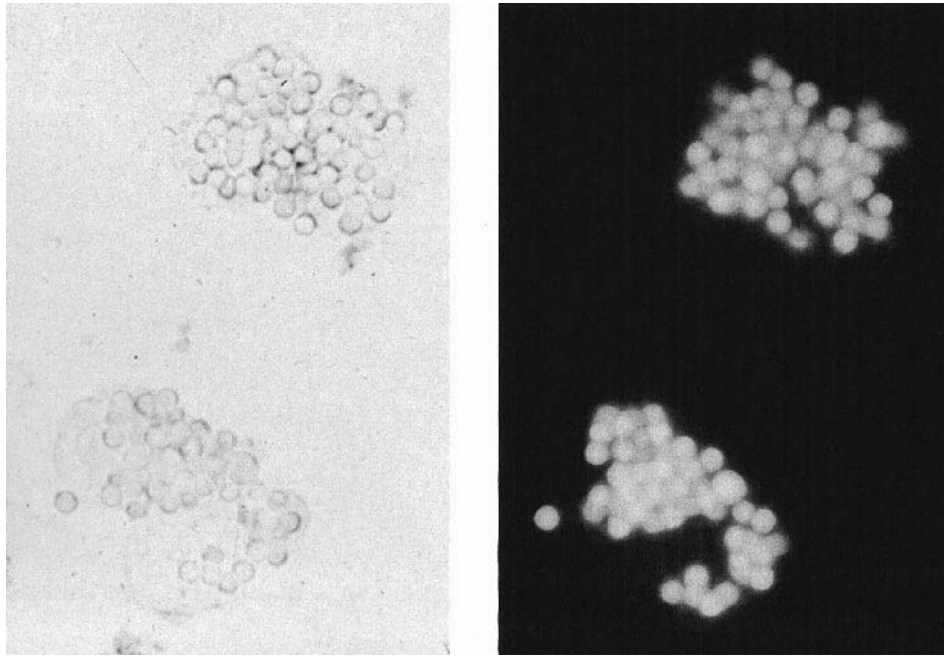

Fig. 13.4 Use of fluorescent latex beads for evaluation of phagocytosis. The panel on the left reproduces a photograph of microscopic field showing the phagocytic cells that have ingested latex beads under visible light. The panel on the right shows the same field under UV light.

E. Degranulation

When the contents of cytoplasmic granules are released into a phagosome, there is always some leakage of their contents into the extracellular fluid. The tests to study degranulation involve ingestion of particulate matter as mentioned above, but in this case the supernatants are analyzed for their contents of substances released by the PMN leukocyte granules such as myeloperoxidase, lysozyme, β -glucuronidase, and lactoferrin.

F. Measurement of the Oxidative Burst

Most diagnostic laboratories that test for neutrophil function run a variant or another of a test to measure the oxidative burst. Several different assays are available, using different parameters and methodologies. Tests based on the reduction of nitroblue tetrazolium (NBT reduction tests) are the most commonly used for the evaluation of neutrophil function.

The principle of the NBT assays is relatively simple. Oxidized NBT, colorless to pale yellow in solution, is transformed by reduction into blue formazan. The test usually involves incubation of purified neutrophils, NBT, and a stimulus known to activate the respiratory burst. Two types of stimuli can be used:

1. Opsonized particles, which need to be ingested to stimulate the burst. In this way the test examines both the ability to ingest and the ability to produce a respiratory burst.

2. Diffusible activators, such as phorbol esters. Those compounds diffuse into the cell and activate protein kinase C, which in turn activates the NADPH-cytochrome B system and induce the respiratory burst directly, bypassing the ingestion step. A patient whose neutrophils respond to stimulation with phorbol ester but not to stimulation with opsonized beads is likely to have an ingestion defect. In contrast, neutrophils from a patient with a primary defect in the ability to generate the respiratory burst will not respond to any kind of stimulus.

The assessment of the ability of phagocytic cells to reduce NBT can be done microscopically or colorimetrically. The simplest NBT reduction assays rely on conventional microscopy to count the number of PMN leukocytes with blue-stained cytoplasm after incubation with opsonized particles. However, the microscopic assay is difficult to standardize, and its interpretation can be affected by subjectivity.

The classical quantitative technique involves the extraction of intracellular NBT with pyrimidine and measure its absorbance at 515 nm (which corresponds to the absorbance peak of reduced NBT). This modality of the NBT test is extremely sensitive and accurate but is difficult to perform because the reagents used to extract the dye from the cells are highly toxic. An alternative are tests in which the PMN leukocytes are simultaneously exposed to opsonized particles and NBT and the change of color of the supernatant from pale yellow to gray or purple (as a result of the spillage of oxidizing products during phagocytosis) is measured. This assay was rendered practical and convenient by the introduction of kinetic colorimeters. Using this type of equipment the color change of NBT can be measured without the need to extract the dye from the cells or to separate the cells from the supernatant (Fig. 13. 5).

The other techniques that are used in diagnostic laboratories are based on the oxidation of 2',7'-dichlorofluorescein diacetate (nonfluorescent), which results in the formation of 2',7'-dichlorofluorescein (highly fluorescent). The numbers of fluorescent cells and fluorescence intensity of activated and nonactivated PMN suspensions from patients and suitable controls can be determined by flow cytometry. In patients with primary defects of the enzymes responsible for the respiratory burst, both the mean fluorescence intensity and the numbers of fluorescent cells after stimulation are considerably lower than those determined in normal, healthy volunteers.

G. Killing Assays

The main protective function of the neutrophil is the ingestion and killing of microorganisms. This ability can be tested using a variety of bacteria and fungi that are mixed with PMN leukocytes in the presence of normal human plasma (a source of opsonins), and after a given time the cells are harvested and lysed, and the number of intracytoplasmic viable bacteria is determined.

Killing assays are difficult and cumbersome and require close support from a microbiology laboratory, and for this reason have been less used than the indirect killing assays based on detection of the oxidative burst of the PMN leukocytes mentioned in the previous section. Alternative and simpler approaches to the evaluation of intracellular killing are based on the differential uptake of dyes (e.g., acridine orange) between live and dead bacteria.

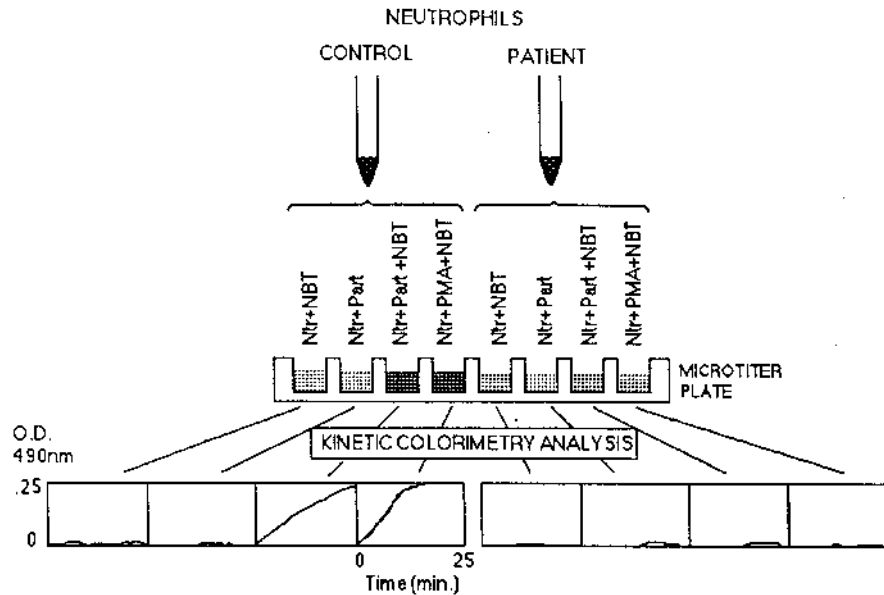

Fig. 13.5 Diagrammatic representation of a quantitative NBT assay carried out by kinetic colorimetry. Neutrophils are isolated from a patient and a normal control and incubated separately in a microtiter plate with NBT (to check for spontaneous activation of neutrophils), with opsonized particles (to check for interference of cells and particles with the colorimetric assay), and with opsonized particles and phorbol myristate acetate (PMA) in the presence of NBT (to check for the induction of the respiratory burst). A kinetic colorimeter is used to monitor changes in O.D. due to the reduction of NBT over a 25-minute period, and the results are expressed diagrammatically and as an average of the variation of the O.D./unit of time. The graphic depiction of the results obtained with neutrophils from a normal control and from a patient with chronic granulomatous disease is reproduced in the lower part of the diagram.

SELF-EVALUATION

Questions

Choose the one *best* answer.

- 13.1 An 11-month-old boy is seen at the emergency room because he had developed a large suppurative abscess in the scalp. There was a previous history of suppurative abscesses after 3 months of age. Which of the following laboratory results would help you establish a diagnosis in this child?
 - A. A CD4 count of $800/\mu\text{L}$
 - B. A neutrophil count of $180/\mu\text{L}$
 - C. An IgG level of 800 mg/dL
 - D. Undetectable NBT reduction
 - E. Undetectable serum IgA
- 13.2 The identifiable cells in the purulent exudate of the child in Question 17.1 are exclusively neutrophils. Which of the following chemotactic compounds is most likely to have been involved in their recruitment?
 - A. C5a
 - B. IL-8

- C. Monocyte chemotactic protein 1 (MCP-1)
D. RANTES

13.3 Which of the following combination of results would you expect for the NBT reduction assay performed with neutrophils obtained from the peripheral blood of the child in question 13.1?

	Cells alone	Cells + opsonized zymosan + NBT	Cells + phorbol myristate acetate + NBT
A	Pale yellow	Pale yellow	Pale yellow
B	Pale yellow	Pale yellow	Dark blue
C	Pale yellow	Dark blue	Dark blue
D	Pale yellow	Dark blue	Pale yellow
E	Dark blue	Dark blue	Dark blue

13.4 Which of these compounds is a potent monocyte/macrophage activator?

- A. ascorbic acid
B. C5a
C. interferon- γ
D. interleukin-2
E. Monocyte chemotactic protein 1 (MCP-1)

13.5 The significance of the expression of CD11/CD18 markers on phagocytic cells is related to the involvement of these molecules on:

- A. Adhesion to endothelial cells
B. Antigen-presentation to helper T lymphocytes
C. Recognition of chemotactic substances
D. Recognition of opsonized particles and microbes
E. Signal transduction after occupancy of Fc and CR1 receptors

13.6 Why is the NBT test considered an indirect measurement of killing capacity?

- A. NBT is oxidized in the presence of lactoperoxidase, and this enzyme is the major killing mechanism in PMN leukocytes.
B. The reduction of NBT is a major step in the bactericidal pathways.
C. The reduction of NBT reflects the adequacy of the oxidative metabolic pathways.
D. The test determines the viability of intracellular bacteria previously incubated with PMN leukocytes and NBT.
E. This test reflects the ability to form phagolysosomes.

For Questions 13.7 through 13.10, select the one lettered heading that is most closely related to it. The same heading may be used once, more than once, or not at all.

- A. Boyden chambers
B. Chemiluminescence
C. Flow cytometry
D. Latex particles
E. Myeloperoxidase assay

13.7 What is used for in vitro measurement of chemotaxis?

13.8 What is used to measure the generation of superoxide?

13.9 What is used to assess ingestion?

13.10 What is used to detect cell adhesion molecules (CD11/CD18 complex) on peripheral blood monocytes and neutrophils?

Answers

- 13.1 (D) Suppurative lymphadenopathies are likely to be associated either with antibody deficiency (specially when IgG is affected) or with phagocytic cell defects. In severely neutropenic patients (neutrophil counts below 200/ μ L) one does not expect to see a suppurative infection, but rather a functional defect, such as the lack of development of a respiratory burst, detected by the NBT assay.
- 13.2 (A) All the chemotactic factors listed could attract neutrophils, but IL-8, MCP-1 and RANTES are released predominantly by activated T cells and/or monocytes that were not present in the exudate. C5a, generated as a consequence of complement activation by any one of the three possible pathways, is a more likely candidate.
- 13.3 (A) In chronic granulomatous disease there is a deficiency of the NADPH oxidase system that cannot be overridden with phorbol myristate acetate. Thus, the patient's cells will not reduce NBT under any conditions.
- 13.4 (C) Interferon- γ is the main activator factor for monocytes and macrophages.
- 13.5 (A) The CD11/CD18 family of proteins are considered as cell adhesion molecules (CAMs); in the case of phagocytic cells, these CAMs are particularly significant because they mediate their attachment to endothelial cells, which is the step that precedes migration of circulating phagocytes to inflamed tissues.
- 13.6 (C) NBT is used as a visible substrate for reduction; hence, the reduction of NBT is considered as an indirect verification of the adequacy of the oxidative metabolism in a phagocytic cell.
- 13.7 (A)
- 13.8 (B) Chemiluminescence, cytochrome *c* reduction, and NBT reduction assays are the most frequently used assays for the respiratory burst of phagocytic cells.
- 13.9 (D)
- 13.10 (C) Flow cytometry is the method of choice for detection of any membrane-associated molecules on peripheral blood leukocytes.

BIBLIOGRAPHY

- Aderem, A., and Unerhill, D. M. Mechanisms of phagocytosis in macrophages. *Annu. Rev. Immunol.* 17:593, 1999.
- Boxer, L. A., and Blackwood, R. A. Leukocyte disorders: quantitative and qualitative disorders of the neutrophil. *Pediatr. Rev.* 17:19 (part 1), 47 (part 2), 1996.
- Ottonello, L., Dapino, P., Pastorino, G., et al. Neutrophil dysfunction and increased susceptibility to infection. *Eur. J. Clin. Invest.* 25:687, 1995.
- Pallister, C. J., and Hancock, J. T. Phagocytic NADPH oxidase and its role in chronic granulomatous disease. *Br. J. Biomed. Sci.* 52:149, 1995.
- Umeki, S. Mechanisms for the activation/electron transfer of neutrophil NADPH-oxidase complex and molecular pathology of chronic granulomatous disease. *Ann. Hematol.* 68:267, 1994.
- Virella, G. Diagnostic evaluation of neutrophil function. In: *The Neutrophils: New Outlook for Old Cells* (Gabrilovich, D. I., ed.). Imperial College Press, London, 1999, p. 275.

14

Infections and Immunity

Gabriel Virella

I. INTRODUCTION

During evolution, an extremely complex system of anti-infectious defenses has emerged. But at the same time that vertebrates and mammals developed their defenses, microbes continued evolving as well, and many became adept at avoiding the consequences of the anti-infectious defense mechanisms. The interplay between host defenses, microbial virulence, and microbial evasion mechanisms determines the outcome of the constant encounters between humans and pathogenic organisms.

II. NONSPECIFIC ANTI-INFECTIOUS DEFENSE MECHANISMS

A. Constitutive Nonspecific Defense Mechanisms

Constitutive nonspecific defense mechanisms play a most important role as a first line of defense, preventing penetration of microorganisms beyond the outer exposed surfaces of the body. Physical and chemical barrier mechanisms that play a significant role in protecting the organism from infectious agents include:

- The integrity of the epithelial and mucosal surfaces
- The flow of mucosal secretions in the respiratory tract
- The acidity of the gastric contents
- The secretion of lysozyme in tears, saliva, and most other secretions
- The production of defensins by mucosal and phagocytic cells

All these are examples of innate anti-infectious defense mechanisms. The importance of these barriers is apparent from the prevalence of infections when their integrity is compromised.

The existence of natural antibacterial compounds, such as lysozyme and defensins, has been the object of considerable attention. Lysozyme breaks the β ,1–4 linkages of peptidoglycan, but its effectiveness is somewhat limited by the fact that bacterial capsules often limit the access of the enzyme to its substrate. Defensins, discussed in detail in the previous chapter, are antimicrobial peptides released by specialized mucosal cells (the Paneth cells in the gut) and by phagocytic cells. The mucosal defensins are believed to play an important role in protecting mucosal cells from pathogenic bacteria. The neutrophil defensins are packaged on the azurophilic granules and are delivered to the phagosomes and also spilled into the extracellular environment. Mammalian defensins are grouped into two families: α and β . β Defensins have been shown to have chemotactic properties for immature dendritic cells and T lymphocytes and in this way may play a significant role in promoting the onset of the immune response.

B. Inducible Nonspecific Responses

These responses, including fever and release of class I interferons (α and β), are activated when infectious agents manage to invade, and they are particularly effective in preventing viral replication. The main cells that produce and release interferon- α have been identified as precursors of dendritic cells, which, as noted in previous chapters, play a key role in the inducing stages of the immune response.

C. Phagocytosis

As a microbe penetrates beyond the skin or mucosal surface, it will encounter cells able to ingest it. Two types of cells are particularly adept at nonimmune phagocytosis: granulocytes (particularly neutrophils) and tissue macrophages. This nonimmune phagocytosis involves a variety of recognition systems (Fig. 14.1):

1. CR1 and CR3 receptors, able to interact with C3b and iC3b on the microbial membrane, generated as a consequence of complement activation by the alternative pathway, a property common to many bacteria (see below).
2. Mannose receptors, able to mediate ingestion of organisms with mannose-rich polysaccharides, such as *Candida albicans*. Mannose-mediated phagocytosis is amplified by a mannose-binding protein that promotes phagocytosis through complement activation and direct interaction with the C1q (collectin) receptor on phagocytic cells.
3. C-reactive protein binds to certain bacterial polysaccharides and has effects very similar to those of the mannose-binding protein—activating complement and promoting phagocytosis, both through CR1 and CR3, as well as by other receptors, including the Fc γ RI and the C1q receptor, both of which bind this protein.

D. Activation of the Complement System Via the Alternative Pathway

A variety of microorganisms (bacteria, fungi, viruses, and parasites; see Table 14.1) can activate complement by the alternative pathway. In most cases where adequate studies have been carried out, polysaccharidic structures have been proven to be responsible for com-

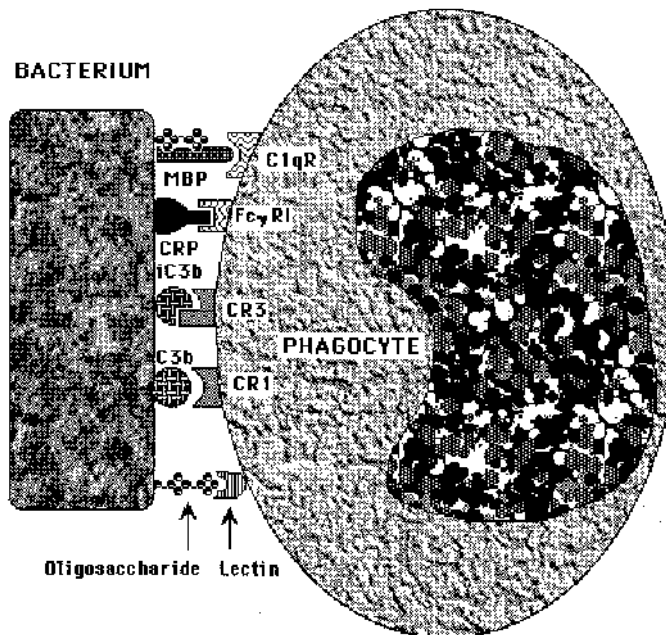

Fig. 14.1 Diagrammatic representation of the different receptors that may mediate nonimmune phagocytosis (MBP = mannose-binding protein; CRP = C-reactive protein).

plement activation of the alternative pathway. This activation will lead to phagocytosis through the generation of C3b and to chemotaxis through the release of C3a.

E. Acute Phase Reaction and Leukocyte Chemotaxis

The initial recognition by phagocytes and the activation of the complement system by the alternative pathway by themselves may not be sufficient to eradicate the invading microorganism. However, the antimicrobial response is significantly amplified by a multitude of cytokines released by macrophages activated as a consequence of phagocytosis, including IL-1, IL-6, IL-8, IL-12, and TNF.

- IL-1 and TNF cause an increase body temperature, mobilize neutrophils from the bone marrow, and upregulate the synthesis of a variety of proteins known as acute phase reactants, including C-reactive protein and the mannose-binding protein mentioned above.
- IL-1 and TNF also upregulate the expression of cell adhesion molecules in the endothelial cells of neighboring endothelial cells, thus promoting adherence of leukocytes, and increase vascular permeability. Both factors facilitate the migration of leukocytes off the vessels, towards the focus of infection.
- IL-8 has chemotactic properties. Together with other chemotactic factors, such as C5a and bacterial peptides, it attracts neutrophils towards the focus of infection.
- IL-12, in conjunction with nitric oxide, stimulates the cytotoxic activity of natural killer cells, enhancing their release of interferon- γ . Interferon- γ and IL-12 have also an important role in promoting T_H1 lymphocyte differentiation.

Table 14.1 Examples of Infectious Agents Able to Activate the Alternative Pathway of Complement Without Apparent Participation of Specific Antibody

Bacteria
<i>Haemophilus influenzae</i> type b
<i>Streptococcus pneumoniae</i>
<i>Staphylococcus aureus</i>
<i>Staphylococcus epidermidis</i>
Fungi
<i>Candida albicans</i>
Parasites
<i>Trypanosoma cyclops</i>
<i>Schistosoma mansoni</i>
<i>Babesia rodhaini</i>
Viruses
Vesicular stomatitis virus

F. Natural Killer Cells

Natural killer (NK) cells are able to destroy virus infected cells as a consequence of the delivery of an activating signal in the absence of an inhibitory signal (see Chapter 11). The inhibiting signal is usually delivered as a consequence of the interaction between a membrane protein in the NK cell membrane and MHC-I molecules on the membrane of normal cells. Virus-infected cells often have a reduced expression of MHC-I molecules due either to a downregulation of cellular protein synthesis or a specific inhibition of MHC-I transport to the cell membrane (discussed later in this chapter). This renders these cells more susceptible to attack by NK cells.

G. $\gamma\delta$ T Lymphocytes

These are predominantly found in the mucosal epithelia and appear to recognize infected epithelial cells by a nonimmunological mechanism (i.e., not involving the T-cell receptors), resulting in their elimination.

III. NATURAL ANTIBODIES

Preexisting antibodies may play a very important anti-infectious protecting role. Natural antibodies may arise as a consequence of cross-reactions, as exemplified in the classical studies concerning the isoagglutinins of the ABO blood group system. Circulating ABO isoagglutinins exist in individuals of blood groups O, A, or B and agglutinate erythrocytes carrying alloantigens of the ABO system different from those of the individual himself.

The origin of natural antibodies in most cases appears to be unsuspected cross-reactions. Experimentally, this seems to be the explanation for the production of agglutinins recognizing the human AB alloantigens by chickens. Interestingly, the isoagglutinins are

produced only by chicks fed conventional diets; chicks fed sterile diets don't develop them. Furthermore, anti-A and anti-B agglutinins develop as soon as chicks fed sterile diets after birth are placed on conventional diets later in life. These observations pointed to some dietary component as a source of immunization. It was eventually demonstrated that the cell-wall polysaccharides of several strains of Enterobacteriaceae and the AB oligosaccharides of human erythrocytes are structurally similar. Thus, cross-reactive antibodies to Enterobacteriaceae are responsible for the "spontaneous" development of antibodies to human red cell antigens in chickens.

Newborn babies of blood groups A, B, or O do not have either anti-A or anti-B isoagglutinins in their cord blood, but develop them during the first months of life, as they are exposed to common bacteria with polysaccharide capsules. However, newborns are tolerant to their own blood group substance, so they will make antibodies only against the blood group substance that they do not express. Blood group AB individuals never produce AB isoagglutinins.

Other mechanisms, such as the mitogenic effects of T-independent antigens and the nonspecific activation of B cells by lymphokines released by antigen-stimulated T lymphocytes, could explain the rise of "nonspecific" immunoglobulins that is observed in the early stages of the humoral response to many different antigens. It is only a matter of random probability that some of those "nonspecific" immunoglobulins may play the role of "natural antibodies" relative to an unrelated antigen.

Irrespective of their origin, "natural" antibodies may play an important protective role, as shown by the experiments summarized in Fig. 14.2. Antibodies elicited to *E. coli*

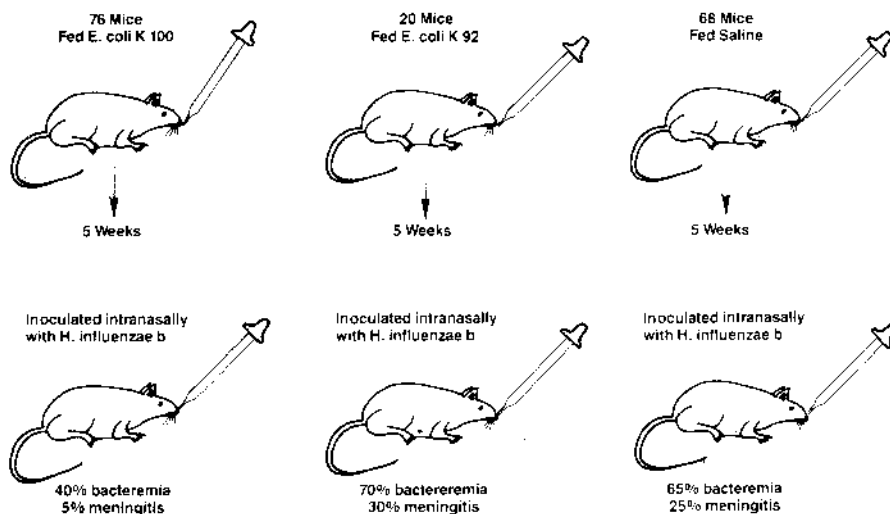

Fig. 14.2 Diagrammatic representation of an experiment proving the anti-infectious protective role of cross-reactive "natural" antibodies. Three groups of mice were orally immunized with *E. coli* K100, *E. coli* K92, and saline, as a control. Five weeks later all animals were challenged with *H. influenzae* type b by the intranasal route. *E. coli* K100 has cross-reactivity with *H. influenzae* type b, but the same is not true for *E. coli* K92. The animals immunized with *E. coli* K100 showed significantly lower rates of bacteremia and meningeal infection than the animals immunized with *E. coli* K92 or controls fed with saline. (Based on Moxon, E. R., and Anderson, P. J. *Infect. Dis.* 140:471, 1979.)

K100 cross-react with the polyribophosphate of *Haemophilus influenzae* and can protect experimental animals against infection with the latter organism. It is logical to assume that such cross-immunizations may be rather common and play an important protective role against a variety of infectious agents.

IV. THE PROTECTIVE ROLE OF ANTIBODIES

A. The Humoral Immune Response

If a pathogen is not eliminated by nonimmunological means and continues to replicate, it will eventually spread through the blood and lymph will usually be trapped by macrophages and dendritic cells in the lymph nodes and spleen. Those cells are able to internalize antigens interacting with receptors, such as the mannose receptor (see above), process the antigen in the endosomal compartment, and express MHC-II-associated antigen-derived peptides. This creates the ideal conditions for the onset of an immune response: B lymphocytes can interact with membrane-bound antigen, while helper T cells recognize MHC-II with antigen-derived peptides presented by the same APC. The antigen-recognizing cells will interact and co-stimulate each other, and after a time lag necessary for proliferation and differentiation of B cells into antibody-producing cells, circulating antibody will become detectable.

As described in Chapter 12, a primary immune response will take 5–7 days (sometimes as long as 2–3 weeks) to be detected. The predominating isotype of the antibodies made early in a primary immune response is IgM, and the antibodies are of relatively low affinity. In contrast, a secondary immune response has a shorter lag phase (as short as 3–4 days), the predominant isotype of the antibodies is IgG, and the antibodies have higher affinity. These different characteristics can be exploited for diagnostic purposes. The predominance of IgM or of low-affinity antibodies indicates that a given immune response has been elicited recently and that the infection is recent or ongoing.

B. Antibody-Dependent Anti-infectious Effector Mechanisms

As soon as specific antibodies become available, they can protect the organism against infection by several different mechanisms.

1. Complement-mediated lysis. This results from the activation of the complete sequence of complement. However, as discussed below, both mammalian cells and most pathogenic microorganisms have developed mechanisms that allow them to resist complement-mediated lysis.
2. Opsonization and phagocytosis. Several proteins can opsonize and promote phagocytosis, as discussed above, but IgG antibodies are the most efficient opsonins among the immunoglobulins. Opsonization becomes super-efficient when complement is activated as a consequence of the antigen-antibody reaction occurring on the surface of the infectious agent and C3b (the most efficient opsonin within the complement system) joins IgG on the microbial cell membrane. This synergism is explained by the fact that Fc γ and CR1 receptors, expressed on the membranes of all phagocytic cells, mediate phagocytosis. Killing through opsonization has been demonstrated for bacteria, fungi, and viruses, while phagocytosis of antibody/complement-coated unicellular parasites has not been clearly demonstrated.

The biological significance of phagocytic cells as ultimate mediators of the effects of opsonizing antibodies is obvious; the protective effects of antibodies are lost in patients with severe neutropenia or with severe functional defects of their phagocytic cells. Those patients have increased incidence of infections with a variety of opportunistic organisms.

3. Antibody-dependent cell-mediated cytotoxicity (ADCC). Cells with Fc receptors may be able to participate in killing reactions that target antibody-coated cells. IgG1, IgG3, and IgE antibodies and cells with Fc γ R or Fc ϵ R are usually involved. Large granular lymphocytes or monocytes are the most common effector cells in ADCC, but in the case of parasitic infections, eosinophils play the principal role in cytotoxic reactions (Fig. 14.3). Different effector mechanisms are responsible for killing by different types of cells. Large granular lymphocytes kill through the release of granzymes and signaling for apoptosis; monocytes kill by releasing oxygen active radicals and nitric oxide; eosinophil killing is mostly mediated by the release of a “major basic protein,” which is toxic for parasites.
4. Toxin neutralization. Many bacteria release toxins, which are often the major virulence factors responsible for severe clinical symptoms. Antibodies to these toxins prevent their binding to cellular receptors and promote their elimination by phagocytosis.
5. Virus neutralization. Most viruses spread from an initial focus of infection to a target tissue via the blood stream. Antibodies binding to the circulating virus change its external configuration and prevent either its binding to cell receptors or its ability to release nucleic acid into the cell.

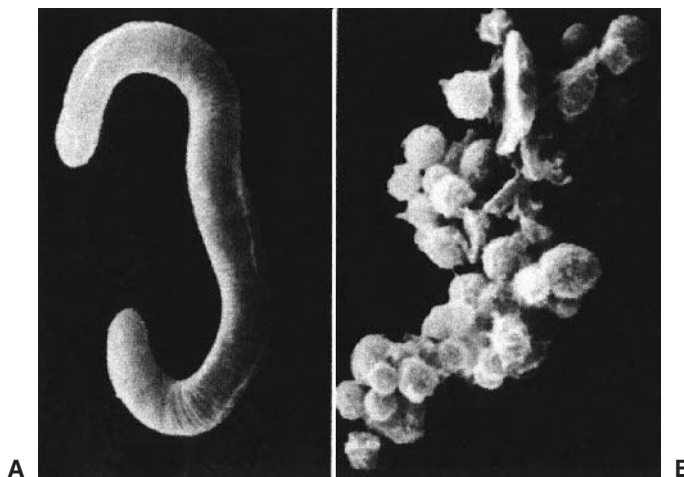

Fig. 14.3 (A) Scanning electron microphotograph of a *Trichinella spiralis* larva incubated with eosinophils and complement-depleted normal (nonimmune) mouse serum for 4 hours. (B) Scanning electron microphotograph of a *Trichinella spiralis* larva incubated with eosinophils and complement-depleted immune serum for 4 hours. Notice that the attachment of eosinophils happened only when eosinophils were added to *T. spiralis* larvae in the presence of immune sera containing antibodies directed against the parasite. (Reproduced with permission from Kazura, J. W., and Aikawa, M. *J. Immunol.* 124:355, 1980.)

6. Mucosal protection. Secretory antibodies seem to play their protective role by preventing the attachment and penetration of microbial agents through mucosal surfaces.

C. Factors Influencing the Effectiveness of an Anti-infectious Humoral Response

The effectiveness of the humoral immune response in preventing an infectious disease depends on the time differential between the incubation period of the disease and the time needed to mount the immune response. If antibodies can be synthesized before the organism proliferates or before it secretes its exotoxins, then the humoral response will prevent the infection's clinical manifestations.

If the relevant antibodies are present in circulation as a result of vaccination, previous infection, or cross-reaction between different microorganisms, protection is most effective; the microorganism or its toxin(s) will be almost immediately neutralized, and the infection will remain subclinical.

If preformed antibodies are not available, protection will depend on whether antibody synthesis can take place before the "incubation period" (period of time during which the infectious agent is multiplying but has not yet reached sufficient mass to cause clinical disease) is over. Some infectious agents, such as the influenza virus, have very short incubation periods (about 2–3 days), and in such cases not even a secondary immune response can be protective. But in most infections, the duration of the incubation period is long enough to allow a secondary immune response to provide protective antibodies. Thus, for many infections, particularly the common viral diseases of childhood, previous exposure and acquisition of memory ensure that antibody will be produced in time to maintain subsequent exposures, which play the role of natural "booster" doses, explaining the "immunity for life" associated with them.

The goal of prophylactic immunization may vary from case to case. In diseases with very short incubation periods it is essential to maintain the levels of neutralizing antibody in circulation necessary to immediately abort infection. In most other diseases it may be sufficient to induce immunological memory, since once memory has been induced, the immune system will be able to respond in time to prevent the development of clinical infection.

Finally, it must be noted that protection by humoral immunity is only possible if the infectious agent is easily available to the antibodies produced against it. Thus, intracellular pathogens are not easy to eliminate by antibodies. In addition, as discussed in detail later in this chapter, organisms able to change their antigenic make-up during the course of an infection can persist in spite of a vigorous humoral response.

IV. THE PROTECTIVE ROLE OF CELL-MEDIATED IMMUNITY

Many organisms have the ability to grow and replicate intracellularly, some as an absolute requirement, others as an option that allows them to survive after phagocytosis. Antibodies are largely ineffective against such organisms, and T lymphocytes play a major role in their elimination, as reflected by the finding of lymphocytic infiltrates in tissues infected by intracellular infectious agents, such as viruses. The immune system has two basic options to eliminate those organisms: to kill the infected cell or to enhance the infected cell's ability

to kill intracellular organisms. Either option requires the persistent activation of the T_H1 subpopulation of helper cells.

A. Lymphocyte-Mediated Cytotoxicity

This process is particularly significant for the elimination of virus-infected cells. It can be easily demonstrated that virus-infected cells are lysed as a consequence of their incubation with “immune” lymphocytes obtained from an animal previously exposed to the same virus. The sequence of events involves recognition of virus-derived peptides expressed in association with MHC-I molecules by $CD8^+$ lymphocytes followed by differentiation into cytotoxic T cells specific for the same MHC-I/peptide complex that they recognized when initially activated. The differentiation may be TH-independent if large amounts of IL-2 are released by $CD8^+$ cells, which can induce autocrine differentiation, but it usually requires T_H1 help. The activation of T_H1 cells usually requires recognition of MHC-II/peptide complexes. Considering that macrophages are common targets for most viral infections, they are likely to present viral peptides associated with both MHC-I and MHC-II molecules. This duality should allow the simultaneous activation of $CD4^+$ and $CD8^+$ T cells in close proximity, an ideal set-up for delivery of “help” to activated precursors of cytotoxic T cells.

B. Lymphocyte-Mediated Activation of Macrophages and Other Inflammatory Cells

Most intracellular bacteria and parasites infect tissue macrophages and fail to induce efficient cytotoxic reactivity. The persistence of the infection depends on a delicate balance between a state of relative inactivity by the macrophage and mechanisms that allow the infectious agent to escape proteolytic digestion once inside the cytoplasm (see below). The immune system can react through a humoral response, which is largely ineffective, or through a T_H1 -mediated inflammatory response, which may actually induce the elimination of the pathogen.

The effective response involves activation of $CD4^+$ T_H1 lymphocytes as a consequence of their interaction with infected macrophages expressing MHC-II-associated peptides and releasing IL-12. The role of IL-12 appears to be critical, because IL-12 receptor deficiency is associated with the predisposition to develop tuberculosis, a classical example of intracellular infection. When properly activated by IL-12, T_H1 lymphocytes release a variety of lymphokines, particularly interferon- γ , which activates macrophages, enhancing their ability to kill intracellular organisms (see Chapter 13), and GM-CSF, which promotes differentiation and release of granulocytes and monocytes from the bone marrow. As a consequence of the delivery of activation signals, macrophages and lymphocytes enter a complex cycle of self and mutual activation involving a variety of cytokines. In addition, several of these cytokines may activate other types of cells known as chemotactic cytokines or chemokines (see Chapter 11). This group of cytokines includes interleukin-8 (IL-8), RANTES, macrophage inflammatory proteins (MIP), macrophage chemotactic proteins (MCP), migration-inhibition factor (MIF), and β -defensins. Collectively the chemokines attract and activate leukocytes and keep them in the area where a cell-mediated immune reaction is taking place.

In concert with the release of chemotactic cytokines, the expression of CAMs in neighboring microvasculature is upregulated, favoring adherence and migration of mono-

cytes and granulocytes to the extravascular space. Inflammatory cells accumulate in the area of infection, and as a consequence of cross-activation circuits involving phagocytes and T_H1 lymphocytes, the localized macrophages and granulocytes become activated. As a consequence, the enzymatic contents and respiratory burst of the cells become more intense, making them better suited for killing intracellular organisms, phagocytosis is enhanced, and the activated macrophages release higher levels of cytokines. The cytokines released by activated macrophages include IL-12, which continues to promote the differentiation of T_H1 cells, as well as IL-1, IL-6, and TNF, which in association with IL-8 play a major role in inducing the metabolic effects characteristic of the inflammatory reaction (see Chapter 11).

V. IMMUNE DEFICIENCY SYNDROMES AS MODELS FOR STUDY OF IMMUNE DEFENSES AGAINST INFECTIONS IN HUMANS

Most of our information about the immune system in humans has been learned from the study of patients with immunodeficiency diseases (see Chapter 30). The most characteristic clinical feature of immunocompromised patients are the repeated or chronic infections, often caused by opportunistic agents. Some characteristic associations between specific types of infections and generic types of immune deficiency provide the best glimpse of the physiological role of the different components of the immune system:

- Patients with antibody deficiencies and conserved cell-mediated immunity suffer from repeated and chronic infections with pyogenic bacteria.
- Patients with primary deficiencies of cell-mediated immunity usually suffer from chronic or recurrent fungal, parasitic, and viral infections.
- Neutrophil deficiencies are usually associated with bacterial infections caused by common organisms of low virulence, usually kept in check through nonimmune phagocytosis.
- Isolated complement component deficiencies are also associated with bacterial infections, most frequently involving *Neisseria gonorrhoeae* and *Neisseria meningitidis*, whose elimination appears to require the activation of the membrane attack complex.

VI. ESCAPE FROM THE IMMUNE RESPONSE

Many infectious agents have developed the capacity to avoid the immune response. Several mechanisms are involved:

1. Anticomplementary activity has been characterized for bacterial capsules and outer proteins of some bacteria. The anticomplementary activity of bacterial outer components has as a net result a decreased level of opsonization by C3b and other complement fragments.
2. Resistance to phagocytosis, either mediated by polysaccharide capsules, which repel and inhibit the function of phagocytic cells, or by the ability to survive after ingestion, is characteristic of the group of bacteria known as facultative intracellular (*Mycobacteria*, *Brucella*, *Listeria*, and *Salmonella*), as well as of

some fungi and protozoa (*Toxoplasma*, *Trypanosoma cruzi*, and *Leishmania*). Infectious agents have developed many different strategies to survive intracellularly, including:

- a. Secretion of molecules that prevent the formation of phagolysosomes allowing the infectious agent to survive inside phagosomes, relatively devoid of toxic compounds (e.g., *Mycobacterium tuberculosis*, *Legionella pneumophila*, and *Toxoplasma gondii*)
- b. Synthesis of outer coats that protect the bacteria against proteolytic enzymes and free toxic radicals (such as the superoxide radical)
- c. Depression of the response of the infected phagocytic cells to cytokines that usually activate their killing functions, such as interferon- γ
- d. Exit from the phagosome into the cytoplasm, where the bacteria can live and multiply unharmed (e.g., *T. cruzi*)

Some organisms combine several of different mechanisms to survive intracellularly. For example, *Mycobacterium leprae* is coated with a phenolic glycolipid layer, which scavenges free radicals and releases a compound that inhibits the effects of interferon- γ . In addition, the release of IL-4 and IL-10 by infected macrophages is enhanced, contributing to the downregulation of T_H1 lymphocytes.

Ineffective Immune Responses

Some infectious agents appear to have acquired evolutionary advantage by not inducing effective immune responses. For example, well-developed polysaccharide capsules protect many bacteria and fungi. Polysaccharides are immunogenic but are not presented to helper CD4 T cells. In the absence of adequate T-cell help, the response to polysaccharides involves predominantly IgM and IgG2 antibodies, which are inefficient as opsonins (the Fc γ R of phagocytic cells recognize preferentially IgG1 and IgG3 antibodies). Another example is *N. meningitidis*, which often induces the synthesis of IgA antibodies. In vitro data suggests that IgA can act as a weak opsonin or induce ADCC (monocytes/macrophages and other leukocytes express Fc α receptors on their membranes), but the physiological protective role of IgA antibodies is questionable. Patient sera with high titers of IgA antibodies to *N. meningitidis* fail to show bactericidal activity until IgA-specific anti-*N. meningitidis* antibodies are removed. This observation suggests that IgA antibodies may act as “blocking factors,” preventing opsonizing IgG antibodies from binding to the same epitopes.

Release of soluble antigens from infected cells able to bind and block antibodies before they can reach the cells has been demonstrated in the case of the hepatitis B virus. The circulating antigens act as a deflector shield, which protects the infected tissues from antibody aggression.

Loss and masking of antigens with absorbed host proteins have been demonstrated with several worms, particularly schistosomes (the larval forms of *Schistosoma*). The ability of parasitic worms to survive in the host is well known and is certainly derived from the ability to evade the immune system.

Antigenic variation has been characterized in bacteria (*Borrelia recurrentis*), protozoan parasites (trypanosomes, the agents of African sleeping sickness, *Giardia lamblia*), and viruses (human immunodeficiency virus, or HIV).

One of the best-studied examples is African trypanosomes. These protozoa have a surface coat constituted mainly of a single glycoprotein (variant-specific surface glycoprotein, or VSG), for which there are about 10³ genes in the chromosome. At any given time,

only one of those genes is expressed, the others remaining silent. For every 10^6 or 10^7 trypanosome divisions, a mutation occurs, which replaces the active VSG gene on the expression site by a previously silent VSG gene. The previously expressed gene is destroyed and a new VSG protein is coded, which is antigenically different. The emergence of a new antigenic coat allows the parasite to multiply unchecked. As antibodies to the newly expressed VSG protein emerge, parasitemia will decline, only to increase as soon as a new mutation occurs and a different VSG protein is synthesized. *Giardia lamblia* has a similar mechanism of variation, but the rate of surface antigen replacement is even faster (once every 10^3 divisions).

Borrelia recurrentis, the agent of relapsing fever, carries genes for at least 26 different variable major proteins (VMP), which are sequentially activated by duplicative transposition to an expression site. The successive waves of bacteremia and fever correspond to the emergence of new mutants, which, for a while, can proliferate unchecked until antibodies are formed.

HIV exhibits a high degree of antigenic variation that seems to be the result of errors introduced by the reverse transcriptase when synthesizing viral DNA from the RNA template. The mutation rate is relatively high (one in every 10^3 progeny particles), and the immune response selects the mutant strains, which present new configurations in the outer envelope proteins, allowing viable mutants to proliferate unchecked by preexisting neutralizing antibodies.

Cell-to-cell spread allows infectious agents to propagate without being exposed to specific antibodies or phagocytic cells. This strategy is commonplace for viruses, especially for herpesviruses, retroviruses, and paramyxoviruses, which cause the fusion of infected cells with noninfected cells allowing viral particles to pass from cell to cell without exposure to the extracellular environment.

Some intracellular bacteria have also developed the ability to spread from cell to cell. The best known example is *Listeria monocytogenes*, which after becoming intracellular can travel along the cytoskeleton and promote the fusion of the membrane of an infected cell with the membrane of a neighboring noninfected cell, which is subsequently invaded.

Immunosuppressive Effects of Infection

Although immunosuppressive effects have been described in association with bacteria and parasitic infections, the best-documented examples of infection-associated immunosuppression are those described in viral infections. The effects of HIV on the immune system will be described in detail in Chapter 30, but many other viruses have the ability to depress the immune system, such as the following:

Measles. Patients in the acute phase of measles are more susceptible to bacterial infections, such as pneumonia. Both delayed hypersensitivity responses and the in vitro lymphocyte proliferation in response to mitogens and antigens are significantly depressed during the acute phase of measles and the immediate convalescence period, usually returning to normal after 4 weeks. Recent investigations suggest that infection of monocytes/macrophages with the measles virus is associated with a downregulation of interleukin-12 synthesis, which can explain the depression of cell-mediated immunity associated with measles.

Cytomegalovirus. Mothers and infants infected with cytomegalovirus show depressed responses to CMV virus but normal responses to T-cell mitogens, sug-

gesting that in some cases the immunosuppression may be antigen-specific, while in measles it is obviously nonspecific.

Influenza virus. This virus has been found to depress cell-mediated immunity in mice, apparently due to an increase in the suppressor activity of T lymphocytes.

Epstein-Barr virus. This virus releases a specific protein that has extensive sequence homology with interleukin-10. The biological properties of this viral protein are also analogous to those of interleukin-10; both are able to inhibit lymphokine synthesis by T-cell clones.

X. ABNORMAL CONSEQUENCES OF THE IMMUNE RESPONSE

In the vast majority of situations the immune response has a protective effect that allows the organism to recover from infection without major illness and without long-term sequelae. However, there are well-known examples of deleterious effects triggered by an exaggerated or misdirected immune response.

The Activation of T Lymphocytes by Bacterial “Superantigens”

A variety of bacterial exotoxins, such as staphylococcal enterotoxins-A and -B (SE-A and SE-B), staphylococcal toxic shock syndrome toxin-1 (TSST-1), exfoliating toxin, and streptococcal exotoxin A, as well as other unrelated bacterial proteins (such as streptococcal M proteins), have been characterized as “superantigens.”

Superantigens are defined by their ability to stimulate T cells without being processed. The stimulation of T cells is polyclonal; thus the designation of superantigen is a misnomer, but it has gained popularity and is widely used in the literature. The better studied superantigens are the staphylococcal enterotoxins, which are potent polyclonal activators of murine and human T lymphocytes, inducing T-cell proliferation and cytokine release. TSST-1 also appears to activate monocytes and is a potent B-cell mitogen, inducing B-cell proliferation and differentiation.

The stimulatory effects of superantigens are a consequence of the direct and simultaneous binding to the nonpolymorphic area of class II MHC on professional accessory cells (macrophages and related cells) and to the V β chain of the α/β TcR (Fig. 14.4). For example, staphylococcal enterotoxins bind exclusively to specific subfamilies of V β chains that are expressed only by certain individuals. When expressed, these V β chain regions can be found on 2–20% of a positive individual’s T cells, and the cross-linking of the TcR2 and of the APC by the enterotoxin activates all T cells (both CD4 and CD8⁺) expressing the specific V β region recognized by the enterotoxin. The massive T-cell activation induced by superantigens results in the release of large amounts of IL-2, interferon- γ , lymphotoxin- α (LT α), and TNF. After the initial burst of cytokine release, the stimulated T cells either undergo apoptosis or become anergic. This effect could severely disturb the ability of the immune system to adequately respond to bacteria releasing superantigens.

Patients infected by bacteria able to release large amounts of superantigens (e.g., *S. aureus* releasing enterotoxins or TSST-1 and group A *Streptococcus* releasing exotoxin A) may develop septic shock as a consequence of the systemic effects of these cytokines. These systemic effects include fever, endothelial damage, profound hypotension, disseminated intravascular coagulation, multiorgan failure, and death.

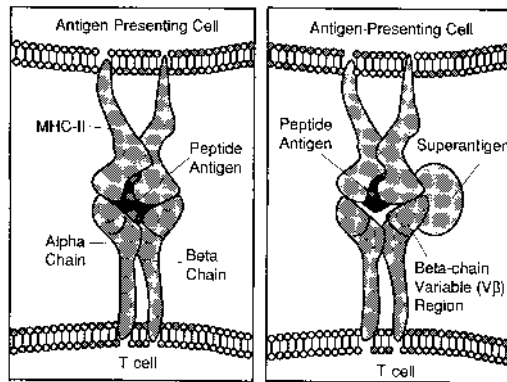

Fig. 14.4 Diagrammatic comparison of the mechanisms of T-cell stimulation by conventional antigens and staphylococcal enterotoxins. While conventional antigens are processed into oligopeptides, which bind to MHC-II molecules and then bind specifically to a TcR binding site (left panel), bacterial “superantigens” interact with nonpolymorphic areas of the V chain of the TcR and of the MHC-II molecule on an APC (right panel). Notice that “superantigen” binding overrides the need for TcR recognition of the MHC-II-associated oligopeptide, and thus T cells of many different specificities can be activated. It is also important to note that both APC and T cells can be stimulated as a consequence of the extensive cross-linking of membrane proteins. (Modified from Johnson, H. M., Russell, J. K., and Pontzer, C. H. *Sci. Am.* 266(4):92, 1992.)

Infection as a Consequence of the Uptake of Antigen-Antibody Complexes

The immune response, in some cases, facilitates the access of infectious agents to cells in which they will be able to proliferate. For example, macrophages are often infected by intracellular organisms that are ingested as a consequence of opsonization. *Babesia rodhaini*, a bovine intraerythrocytic parasite, penetrates the host's cells after it has bound complement, particularly C3. Absorption of C3b-containing circulating antigen-antibody complexes to the CR1 expressed by red cells allows the parasite to gain access to the red cell, which becomes its permanent location. Epstein-Barr virus (EBV) normally infects B cells through a CR-2-related protein. However, if dimeric IgA reactive with the virus is produced and released into the mucosal secretions, the resulting IgA-EBV complex is able to infect mucosal cells through the poly-Ig receptor, which binds dimeric IgA (see Chapter 6). Mucosal infection in the nasopharynx can eventually acquire malignant characteristics.

Postinfectious Tissue Damage

Several examples of the pathogenic role of an anti-infectious immune response have been characterized. The following are some of the best known examples:

Immune complex-induced inflammation. Antigen-antibody complexes, if formed in large amounts, can cause disease by being trapped in different capillary networks and leading to inflammation. The clinical expression of immune complex-related inflammation depends on the localization of the trapped complexes: vasculitis and purpura, when the skin is predominantly affected, glomerulonephritis if trapping takes place on the glomerular capillaries, or

arthritis when the joints are affected (see Chapter 23). Viruses are often involved in the formation of circulating antigen-antibody complexes.

Immune destruction of infected cells and tissues. An immune response directed against an infectious agent may be the main cause of damage to the infected tissue. For example, in subacute sclerosing panencephalitis, a degenerative disease of the nervous system associated with persistent infection with the measles virus, the response against viral epitopes expressed in infected neurons is believed to be the primary mechanism of disease. Also, in some forms of chronic active hepatitis (see Chapter 17) the immune response directed against viral epitopes expressed by infected hepatocytes seems to cause more tissue damage than the infection itself.

Cross-reactions with tissue antigens. These have been proposed as the basis for the association of streptococcal infections with rheumatic carditis and glomerulonephritis. Antibodies to type 1 streptococcal M protein cross-react with epitopes of myocardium and kidney mesangial cells and cause inflammatory changes in the heart and glomeruli, respectively.

Autoimmunity

The role of infectious agents as triggers of autoimmune reactions is discussed in detail in Chapters 3 and 16.

X. EPILOGUE

The outcome of an infectious process depends on a very complex set of interactions with the immune system. A successful pathogen is usually one that has developed mechanisms that avoid fast elimination by an immunocompetent host. These mechanisms allow the infectious agent to replicate, cause disease, and spread to other individuals before the immune response is induced. The immune response, on the other hand, is a powerful weapon that, once set in motion, may destroy friendly targets. Thus, the therapeutic strategies in infectious disease have to consider all these questions, such as the particular survival strategy of the infectious agents, the effects of the infection on the immune system, and the possibility that the immune response may be more of a problem than the infection itself.

SELF-EVALUATION

Questions

Choose the one *best* answer.

- 14.1 Which of the following variables is most important as a determinant of the possible use of active immunization to protect an individual from an infectious disease after a known exposure?
- A. Existence of memory cells stimulated in a previous immunization
 - B. Immunogenicity of the antigen used for vaccination
 - C. Length of the incubation time of the disease
 - D. Preexisting levels of protective antibody
 - E. Resistance of the infectious agent to nonimmune phagocytosis

- 14.2 The elimination of an intracellular organism from an infected human macrophage is most likely to depend on which of the following?
- A. Formation of syncytia by fusion of infected and noninfected cells
 - B. Intracellular diffusion of complement-fixing antibodies
 - C. Phagocytosis of the infected cells by noninfected macrophages
 - D. Release of enzymes and superoxide radicals directly into the cytoplasm
 - E. Sensitization of T cells against microbial-derived peptides presented in association with MHC-II molecules on the membrane of the infected cell
- 14.3 Which of the following mechanisms is the basis for the massive activation of the immune system caused by staphylococcal enterotoxins?
- A. Ability to interact nonspecifically with MHC-II molecules and α/β TcR
 - B. Activation of APC, followed by release of massive amounts of lymphocyte-activating cytokines
 - C. Binding to APC, followed by activation of all T cells expressing TcR with specific V β regions
 - D. Mitogenic activation of the T_H2 helper subpopulation
 - E. Promiscuous binding to the peptide-binding grooves of MHC-II molecules
- 14.4 The finding of a generalized depression of cellular immunity during the acute phase of measles should be considered as:
- A. A poor prognosis indicator
 - B. Evidence of a primary immune deficiency syndrome
 - C. Reflecting a transient state of immunosuppression
 - D. The result of a concurrent bacterial infection
 - E. The result of a laboratory error
- 14.5 Which of the following approaches would be useful to treat an intracellular infection such as the one caused by *Mycobacterium tuberculosis*?
- A. Administration of a mixture of interleukins-4, -5, and -6 to activate a B-cell response
 - B. Administration of in vitro activated NK cells
 - C. Administration of interferon- γ to activate macrophages
 - D. Administration of interleukin-2 to induce a predominant response of T_H1 cells
 - E. Transfusion of T lymphocytes from patients who have survived *M. tuberculosis* infections
- 14.6 An antibody to tetanus toxoid will prevent the clinical manifestations of tetanus by:
- A. Binding to the antigenic portion of the toxin molecule and inhibiting the interaction between the toxin and its receptor
 - B. Causing the destruction of *Clostridium tetani* before it releases significant amounts of toxin
 - C. Facilitating the onset of a recall response to the toxin
 - D. Inhibiting the binding of the toxin to its receptor by blocking the toxin's active site
 - E. Promoting ADCC reactions against *C. tetani*

- 14.7 Herpes simplex virus escapes immune defenses by:
- A. Being a very weak immunogen
 - B. Causing immunosuppression
 - C. Infecting immunocompetent cells
 - D. Producing an excess of soluble antigen that “blocks” the corresponding antibody
 - E. Spreading from cell to cell with minimal exposure to the extracellular environment
- 14.8 The ABO isohemagglutinins are synthesized as a result of:
- A. Blood transfusions with incompatible blood
 - B. Cross-immunization with polysaccharide-rich Enterobacteriaceae
 - C. Genetic predisposition
 - D. Mixing of placental and fetal blood at the time of birth
 - E. Repeated pregnancies
- 14.9 In a newborn baby with blood typed as A, Rh positive, the lack of anti-B isoagglutinins is:
- A. A reflection of the lack of exposure to intestinal flora during intrauterine life
 - B. A very exceptional finding, identifying the baby as a nonresponder to blood group B substance
 - C. Evidence of maternal immunoincompetence
 - D. Evidence suggestive of fetal immunoincompetence
 - E. Unlikely; the test should be repeated
- 14.10 The parasite-killing properties of eosinophils are linked to the production and secretion of:
- A. Histamine
 - B. Leukotrienes
 - C. Major basic protein
 - D. Perforin
 - E. Prostaglandins

Answers

- 14.1 (C) If the incubation period exceeds that of the time necessary for eliciting an immune response (primary or secondary), then active immunization can be used to prevent the development of the disease after a known exposure.
- 14.2 (E) Sensitized T cells will become activated and release interferon- γ , which can enhance the killing properties of macrophages and related cells.
- 14.3 (C) After binding to MHC-II molecules, staphylococcal enterotoxins are able to interact and activate T cells expressing TcR with specific V β regions.
- 14.4 (C) Measles is characteristically associated with a transient depression of cellular immunity during the acute phase; a patient with such immune depression should not be considered as having a primary immune deficiency or as necessarily having a poor prognosis.

- 14.5 (C) Administration of interferon- γ , the natural macrophage activator, would be the most promising of the listed approaches. For activation of T_H1 cells, IL-12 would be the indicated cytokine. Activated NK cells have not been proven to be important in the elimination of cells infected by intracellular bacteria. Transfusion of T cells from recovering patients has the disadvantage of potential reactions due to donor-recipient histoincompatibility.
- 14.6 (A) An antitetanus toxoid antibody is neither cytotoxic to *Clostridium tetani*, since it reacts with the toxin, which is an exotoxin, nor able to bind to the active site of the toxin, since the toxoid used for immunization has lost (as a consequence of detoxification) the active site. Memory responses depend on an increased number of memory cells, and not on the presence of circulating antibody.
- 14.7 (E) Herpes simplex viruses are immunogenic, do not infect immunocompetent cells, do not cause immunosuppression, and do not induce the release of large amounts of soluble antigens from infected cells. However, they can cause fusion of infected and noninfected cells, and this allows them to spread from cell to cell without being exposed to humoral defense mechanisms.
- 14.8 (B) Mixing of maternal and fetal blood at birth may cause maternal sensitization to Rh blood groups but does not appear to cause sensitization of the newborn, probably due a combination of factors such as the immaturity of the immune system. The fact that the maternal red cells directly enter the fetal circulation, which is not a very immunogenic route of presentation for any given antigen, may also contribute to this lack of sensitization of the newborn.
- 14.9 (A) Since the newborn's intestine has not been colonized by Enterobacteriaceae, the antigenic stimulation for production of isoagglutinins has not taken place before birth and negative titers of isohemagglutinins are normal. Maternal isoagglutinins, being in a large majority of cases of the IgM class, do not cross the placenta.
- 14.10 (C) Major basic protein is the main parasitocidal compound released by eosinophils recognizing IgE-coated parasites.

BIBLIOGRAPHY

- Altare, F., Durandy, A., Lammas, D., et al. Impairment of mycobacterial immunity in human interleukin 12 receptor deficiency. *Science* 280:1432, 1998.
- Borst, P., and Graves, D. R. Programmed gene rearrangements altering gene expression. *Science* 235:658, 1987.
- Cook, D. N., Beck, M., Coffman, T. M., et al. Requirement of MIP-1 α for an inflammatory response to viral infection. *Science* 269:1583, 1995.
- Eze, M. O. Avoidance and inactivation of reactive oxygen species: Novel microbial immune evasion strategies. *Med. Hypotheses* 34:252, 1991.
- Friedland, J. Chemokines in viral disease. *Res. Virol.* 147(2-3):131, 1996.
- Ganz, T. Defensins and host defense. *Science* 286:420-421, 1999.

- Karp, C. L., Wysocka, M., Wahl, L. M., Ahearn, J. M., Cuomo, P. J., Sherry, B., Tirnchieri, G., and Griffin, D. Mechanism of suppression of cell-mediated immunity by measles virus. *Science* 273:228, 1996.
- Kim, J., Urban, R. G., Strominger, J. L., and Wiley, D. C. Toxic shock syndrome toxin-1 complexed with a class II major histocompatibility molecule HLA-DR1. *Science* 266:1870, 1994.
- Kraus, W., Dale, J. B., and Beachey, E. H. Identification of an epitope of type 1 streptococcal M protein that is shared with a 43-kDa protein of human myocardium and renal glomeruli. *J. Immunol.* 145:4089, 1990.
- Li, H., Llera, A., Malchiodi, E. L., and Mariuzza, R. A. The structural basis of T cell activation by superantigens. *Annu. Rev. Immunol.* 17:435, 1999.
- Louzir, H., Ternynck, T., Gorgi, Y., Tahar, S., Ayed, K., and Avrameas, S. Autoantibodies and circulating immune complexes in sera from patients with hepatitis B virus-related chronic liver disease. *Clin. Immunol. Immunopath.* 62:160, 1992.
- Luster, A. D. Chemokines—chemotactic cytokines that mediate inflammation. *N. Engl. J. Med.* 338:436, 1998.
- Manuel, J. Macrophage-parasite interactions in *Leishmania* infections. *J. Leukoc. Biol.* 47:187, 1990.
- Research brief. Disarming the immune system: HIV uses multiple strategies. *J. NIH Res.* 8:33, 1996.

15

Diagnostic Immunology

Gabriel Virella and Virginia M. Litwin

I. IMMUNOSEROLOGY

The exquisite sensitivity and specificity of antigen-antibody reactions has been utilized as the basis for many diagnostic procedures. Depending on the test design, one can detect or assay either specific antigens or specific antibodies. Because serum is most often used in these assays, they are also known by the generic designation of immunoserological tests.

A. General Principles

Immunoserological assays can be developed for antigen or antibody detection or quantitative assay. For antibody detection or measurement, a purified preparation of antigen must be available. For instance, when human serum is tested for antibody to diphtheria toxoid, a purified preparation of the toxoid must be available. Second, a method for detecting the specific antigen-antibody reaction must be developed. Conversely, to detect antigens in biological fluids, specific antibody must be available. In both types of assays positive and negative controls are required for proper interpretation of the results.

Antigen-detection tests have been applied to the diagnosis of infectious diseases, the detection of previous infection, the monitoring of neoplasms and vaccine efficacy, the assay of hormones and drugs, and pregnancy diagnosis. Measurement of specific antibodies has found wide application in the diagnosis of infectious, allergic, autoimmune, and immunodeficiency diseases. A variety of different techniques have been developed over the years for these purposes. Some of the assays for antigen/antibody detection described be-

low, such as the diffusion-based and electrophoresis-based assays, are no longer commonly used. These procedures have, for the most part, been replaced by commercial assay kits, which are faster, easier to perform and more quantitative than the original assays. Because the scientific principles of the original assays and the newer technologies are the same, the description of these “historical” methods is included herein.

B. Precipitation Assays

Several of the commonly used serological assays are based on the detection of antigen-antibody aggregates, either through visualization of precipitates or by measuring the light dispersed by antigen-antibody complexes in suspension.

1. Double Diffusion Method (*Ouchterlony Technique*)

This venerable and simple technique requires very little in terms of equipment and supplies other than antigens, antibodies, and a properly buffered agar gel. Wells are punched in an agar gel; antigen and antibody are placed in separate wells diffuse toward each other and precipitate at the point of antigen-antibody equivalence.

The main advantages of this technique are simplicity, minimal equipment requirements, and specificity. If properly carried out, double immunodiffusion assays are 100% specific, as far as detecting an antigen-antibody reaction. The main limitations are lack of sensitivity and the time required for full development of visible precipitation (up to 72–96 hours of diffusion in systems when either reactant is present in small quantities).

In general, double diffusion assays are useful for determining the presence or absence of a given antigen or antibody in any kind of biological fluid. Some serological assays used in parasitology and mycology are based on double immunodiffusion.

2. Counterimmunoelectrophoresis

This technique is a variation of double immunodiffusion, in which antigen and antibody are forced to move towards each other with an electric current (antibodies move to the cathode, while most antigens have a strong negative charge and move towards the anode). Precipitin lines can be visualized between the antigen and antibody wells.

This method is faster and more sensitive than double immunodiffusion. Visible precipitation can be usually observed after 1–2 hours, although for maximal sensitivity it is necessary to wash, dry, and stain the agar gel in which the reaction took place, a process that extends the time to final reading of the results to several days.

Counterimmunoelectrophoresis has been used for detection of fungal or bacterial antigens in cerebrospinal fluid (in patients with suspected meningitis) and for the detection of antibodies to *Candida albicans* (Fig. 15.1), DNA, and other antigens.

3. Radial Immunodiffusion

Radial immunodiffusion represents a hallmark in the evolution of immunoserology because it represents the first successful attempt to develop a precise quantitative assay suitable for routine use in the diagnostic laboratories. Radial immunodiffusion received its designation from the fact that a given antigen is forced to diffuse concentrically on a support medium in which antiserum has been incorporated (Fig. 15.2).

A polyclonal antiserum known to precipitate the antigen is added to molten agar, and an agar plate containing the antibody is then prepared. Identical wells are cut in the anti-

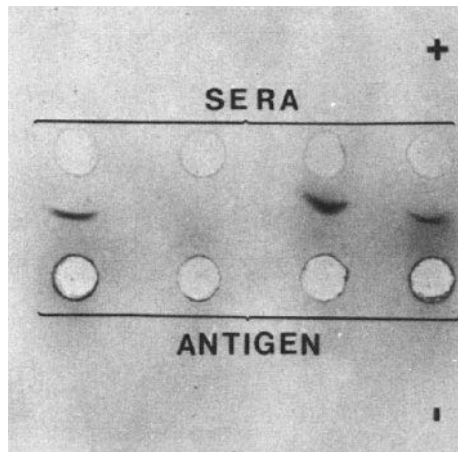

Fig. 15.1 An example of the use of counterimmunoelectrophoresis for the detection of antibodies to microbial antigens. In this case the test was designed to detect *C. albicans* antibodies. The wells on the cathodal side were filled with an antigenic extract of *C. albicans*, and the wells on the anodal side were filled with patient's sera. The appearance of a precipitation line between a given serum well and the antigen well directly opposed to it identifies the patient as positive.

serum-containing agar, and those wells are filled with identical volumes of samples containing known amounts of the antigen (calibrators) and unknown samples in which the antigen needs to be assayed. After 24–48 hours it is possible to measure the diameters of circular precipitates formed around the wells where antigens were placed. Those diameters are directly proportional to antigen concentration. A plot of precipitation ring diameters versus concentrations is made for the samples with known antigen concentrations. This plot, known as a calibration curve, is used to extrapolate the concentrations of antigen in the unknown samples based on the diameter of the corresponding precipitin rings.

Radial immunodiffusion, while not as sensitive as some newer techniques and relatively slow, is nonetheless reliable for routine assay of many serum proteins. It has been widely applied to the assay of immunoglobulins, complement components, and, in general,

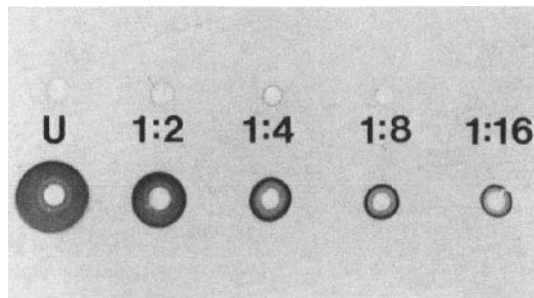

Fig. 15.2 The principle of radial immunodiffusion. Five wells carved into antibody-containing agar were filled with serial dilutions of the corresponding antigen. The antigen diffused, reacted with antibody in the agar, and eventually precipitated in a circular pattern. The diameters or areas of these circular precipitates are directly proportional to the concentration of antigen in each well.

any antigenic protein that exists in concentrations greater than 0.5 mg/L in any biological fluid.

4. *Quantitative Immunoelectrophoresis*

Quantitative immunoelectrophoresis (rocket electrophoresis) is an adaptation of radial immunodiffusion in which the antigen is actively driven through an antibody-containing matrix by an electric potential. As the equivalence zone of antigen-antibody reaction is reached, the reaction ceases and elongated precipitin arcs (rockets) become visible (Fig. 15.3). The lengths of those rockets are proportional to the antigen concentrations in the wells. Rocket electrophoresis can be used for the quantitative assay of many proteins, including immunoglobulins. The reverse modality with antigen incorporated in the agar can be used for the measurement of specific antibodies. This technique is faster and more sensitive than radial immunodiffusion.

5. *Immunonephelometry*

This quantitative technique has replaced radial immunodiffusion, particularly when large numbers of samples are to be assayed. The principle of the assay lies in the fact that when dilute solutions of antigen and antibody are mixed under antibody excess conditions, solu-

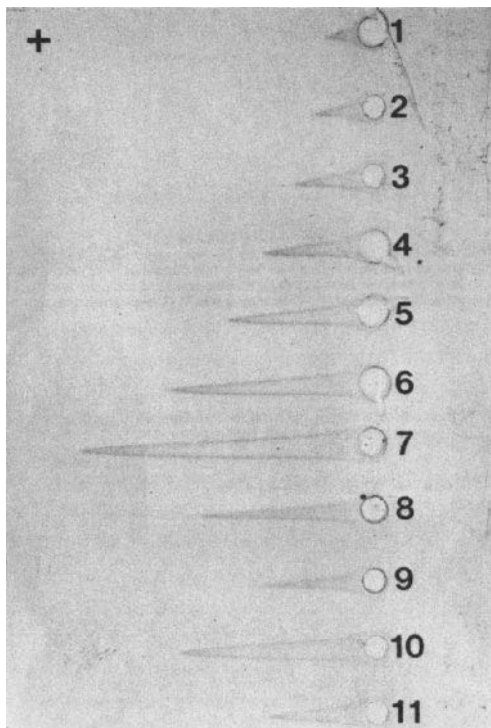

Fig. 15.3 Quantitative electrophoresis. In this assay, antibody to apolipoprotein B was incorporated into the agar. Reference standards with known concentrations of apolipoprotein B were used to fill wells 1–7; the remaining wells were filled with patient's sera. (Courtesy of Dr. Maria F. Lopes-Virella, VAMC, Charleston, SC.)

ble antigen-antibody complexes are formed that remain in suspension. The relative amount of soluble aggregates can be assayed by measuring nephelometrically the amount of light dispersed by the mixture. This is most frequently done by passing a beam of light through tubes containing mixtures of fixed amounts of antibody and variable concentrations of antigen. The scattered light is measured at angles varying from near 0° to 45° relative to the incident light. If the antibody concentration is kept constant, the amount of dispersed light will be directly proportional to the antigen concentration. The principles of calibration and extrapolation of unknown values are identical to those of radial immunodiffusion.

Immunonephelometry is superior to radial immunodiffusion in terms of sensitivity, speed, and automation. However, the preparation of samples and cost of equipment and reagents make it mostly suitable for large-volume assays. In the right set-up, it is the technique of choice for the measurement of immunogenic proteins (e.g., immunoglobulins or complement components) in concentrations greater than 5–10 mg/L when the volume of samples to be analyzed is large.

6. *Immuno-electrophoresis*

Immuno-electrophoresis (IEP) is a two-step technique that combines electrophoretic separation and double immunodiffusion. In the first step a protein mixture (such as serum) is electrophoresed through a support medium, usually agarose. After electrophoresis is completed, specific antisera are deposited in a trough cut into the agarose, parallel to the axis of the electrophoretic separation. The electrophoretically separated proteins and the antisera diffuse toward one another, and at the zone of antigen-antibody equivalence, precipitin patterns in the form of arcs appear. This technique was widely used for analytical studies in patients suspected of plasma cell malignancies. It has been largely replaced by immunoblotting methods, the interpretation of which is much simpler.

7. *Immunofixation (Immunoblotting)*

The principle of immunofixation is diagrammatically represented in Figure 15.4. In the first step, several aliquots of the patient's serum are simultaneously separated by electrophoresis. One of the separation lanes is stained as a reference for the position of the different serum proteins, while paper strips embedded with different antibodies are laid over the remaining separation lanes. The antibodies diffuse into the agar and react with the corresponding immunoglobulins. After washing off unbound immunoglobulins and antibodies, the lanes where immunofixation takes place are stained, revealing whether the antisera recognized the proteins they are directed against.

The main application of immunoblotting is the detection of monoclonal proteins. In the case illustrated in Figure 15.5, a patient's serum was being tested for the presence of an IgG monoclonal protein. Such protein, by definition, must be homogeneous in mobility and must react with anti-IgG antibodies and either antikappa or antilambda antibodies. The diagram shows stained precipitates corresponding to the lanes overlaid with anti-IgG and with anti- κ light chains. This result proved that an IgG κ monoclonal protein existed in this patient's serum.

8. *Western Blot*

The Western blot (Fig. 15.6) is a variation of immunoblotting that has been popularized by its use in the diagnosis of HIV infection. The first step in the preparation of an immunoblot

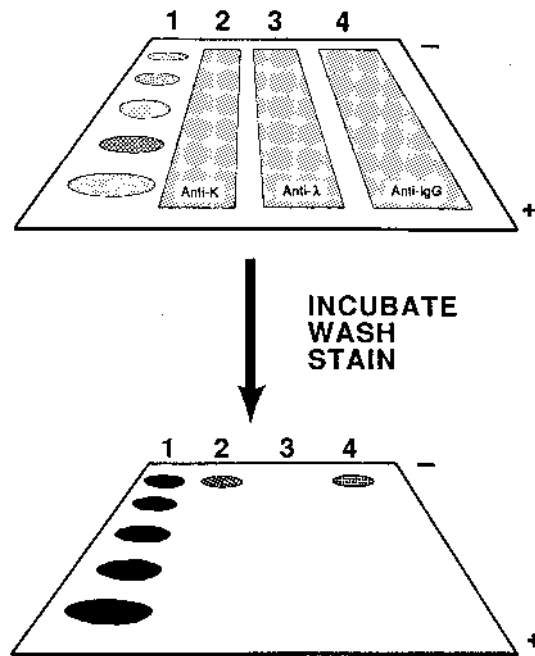

Fig. 15.4 Diagrammatic representation of the typing of a monoclonal IgG protein by immunofixation. The top panel illustrates the electrophoretic separation of serum proteins, revealed by staining in lane 1, and the overlay with three different antisera (anti- κ , anti- λ , and anti-IgG) of lanes 2, 3, and 4, where the same proteins were separated. After incubation to allow antigens and antibodies to react, the unreacted proteins and antibodies are washed off and the precipitates formed with the different antibodies are stained. In the example illustrated, precipitates were formed in the cathodal region (where immunoglobulins are separated by electrophoresis) with anti-IgG and anti- κ , confirming that the serum contained a monoclonal protein typed as IgG κ .

(also known as a Western blot) is to separate the different viral antigens (gp160 to p16) according to their molecular size (the numbers preceding “gp” or “p” refer to the protein mass in kilodaltons). This is achieved by performing electrophoresis in the presence of a negatively charged detergent (such as sodium dodecyl sulfate), which becomes associated with the proteins and obliterates their charge differences, using as support for the separation a medium with sieving properties. The result is the separation of a protein mixture into components of different sizes.

After the separation of the viral proteins is completed, it is necessary to transfer the separated proteins to another support in order to proceed with the remaining steps. This transfer or “blotting” is easily achieved by forcing the proteins to migrate into a nitrocellulose membrane by a second electrophoresis step (electroblotting). The nitrocellulose membrane, to which the viral antigens have been transferred, is then impregnated with patient’s serum. If antibodies to any or several of these antigens are contained in the serum, they will combine with the antigen at the point where it is blotted.

The following steps are designed to detect the antigen-antibody complexes formed in the cellulose membrane. First, all the nonprecipitated antigens and antibodies are washed off; then the protein binding sites still available on the membrane are blocked to prevent

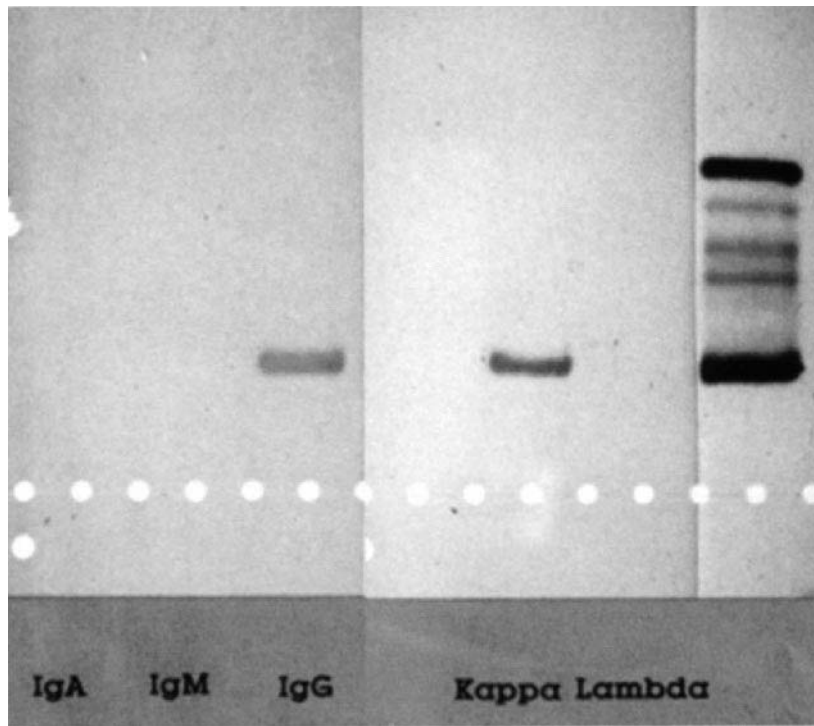

Fig. 15.5 Use of the immunoblotting technique for typing a monoclonal protein. From right to left, the pictures show a reference lane in which the serum proteins were electrophoresed and stained, showing an homogeneous protein of gamma mobility, near the bottom of the separation. The next five lanes were blotted with the indicated antisera, washed, and then stained to reveal which antisera reacted with the homogeneous protein visualized in the reference lane. The results indicate that the homogeneous protein is a monoclonal protein of the IgG heavy-chain isotype, with kappa light chains.

false-positive reactions; finally, the membrane is overlaid with a labeled antibody to human immunoglobulins. This antibody will react with the complexes formed by viral antigens and human antibodies and can later be revealed either by adding a color- or chemiluminescence-developing substrate (if the anti-human immunoglobulin is labeled with an enzyme) or by autoradiography (if the anti-human immunoglobulin is labeled with ^{125}I iodine). The retention of the labeled antibody in site(s) known to correspond to the separation of viral proteins indicates that the patient's serum contained antibodies reacting with those antigens.

This technique has the advantage over other screening assays of not only detecting antibodies, but identifying the antigens against which the antibodies are directed. This results in increased specificity. The downside is the time consumed running the assay, which requires very careful quality control and needs to be carried out by specialized personnel in certified laboratories. To circumvent this problem, prepared Western blot membranes can be purchased commercially. These specific blots (e.g., for HIV) need only be probed with the patient serum and developed. Generally, positive and negative controls are included with the blots. Using these commercially available kits, the performance of sophisticated technology is accomplished with less time and training.

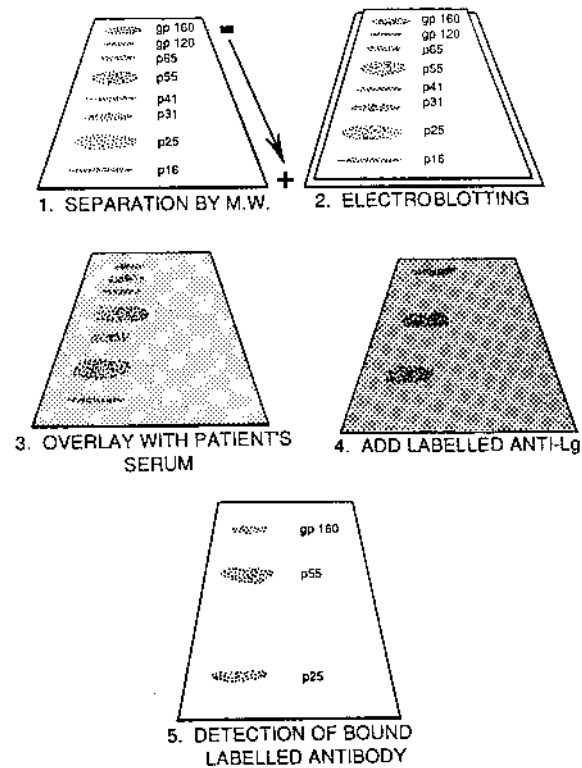

Fig. 15.6 Diagrammatic representation of a Western blot study to confirm the existence of anti-HIV antibodies. In the first step, a mixture of HIV antigens is separated by size (large antigens remain close to the origin where the sample is applied, smaller antigens move deep into the acrylamide gel used for the separation). In the second step, the separated antigens are electrophoresed into a permeable nitrocellulose membrane (electroblotting). Next, the patient's serum is spread over the cellulose membrane to which the antigens have been transferred. If antibodies to any of these antigens are present in the serum, a precipitate will be formed at the site where the antigen has been transferred. After washing excess of unreacted antigens and serum proteins, a labeled second antibody is overlaid on the membrane; if human antibodies precipitate by reacting with blotted antigens, the second antibody (labeled anti-human immunoglobulin) will react with the immunoglobulins contained in the precipitate. After washing off the excess of unreacted second antibody, its binding to an antigen-antibody precipitate can be detected either by adding a color-developing substrate (if the second antibody is labeled with an enzyme) or by autoradiography (if the second antibody is labeled with an adequate isotope, such as ^{125}I).

C. Assay Methods Based on Agglutination

1. Bacterial Agglutination

When a bacterial suspension is mixed with antibody directed to its surface determinants, the antigen-antibody reaction leads to the clumping (agglutination) of bacterial cells.

Agglutination is rapid (taking a matter of minutes) and, by being visible to the naked eye, does not require any special instrumentation other than a light box. Its disadvantages are the need for isolated organisms and poor sensitivity, requiring relatively large concentrations of antibody.

In spite of its limitations, agglutination of whole microorganisms is commonly used for serotyping isolated organisms and, less commonly, for the diagnosis of some infectious diseases, e.g., the Weil-Felix test for the diagnosis of typhus (based on the fact that certain strains of *Proteus* share antigens with several *Rickettsia* species). Methods based on the agglutination of antigen or antibody-coated particles are more widely used in diagnostic immunology.

2. Agglutination of Inert Particles Coated with Antigen or Antibody

Latex particles and other inert particles can be coated with purified antigen and will agglutinate in the presence of specific antibody. Conversely, specific antibodies can be easily adsorbed by latex particles and will agglutinate in the presence of the corresponding antigen. Quantitative analysis to determine the agglutinating antibody content of an antiserum involves dilution of the serum and determination of an endpoint, which is the last dilution at which agglutination can be observed. The reciprocal of this last agglutinating dilution is the antibody titer.

This methodology has found a variety of applications:

IgG-coated, latex particles are used for the detection of anti-immunoglobulin factors (such as the rheumatoid factor) in the rheumatoid arthritis (RA) test (Fig. 15.7).

Latex particles coated with thyroglobulin are used in a thyroglobulin antibody test.

Several diagnostic tests for infectious diseases have been developed based on latex agglutination. In some cases, the antigen is bound to latex, and the test detects specific antibodies (e.g., tests for histoplasmosis, cryptococcosis, and trichinosis). Rapid diagnosis tests for bacterial and fungal meningitis have been developed by adsorbing the relevant specific antibodies to latex particles. The antibody-coated particles will agglutinate if mixed with CSF containing the relevant antigen. This procedure allows a rapid etiological diagnosis of meningitis that is essential for proper therapy to be initiated.

The main advantages of these tests are simplicity and the quick turnaround of results. The main disadvantages are the need for large amounts of reagents, cost, and relatively low sensitivity, particularly in the case of the tests for diagnosis of infectious diseases.

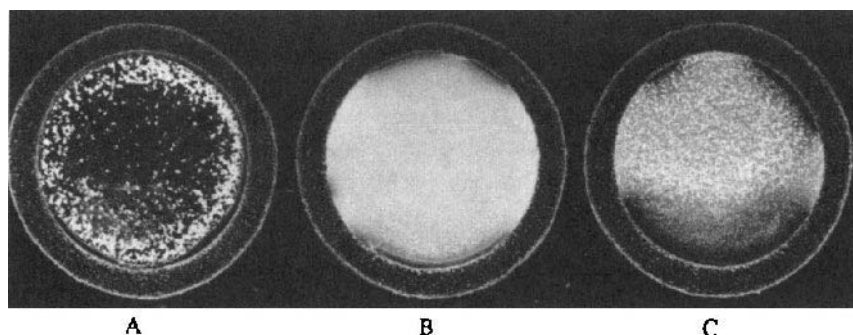

Fig. 15.7 Detection of rheumatoid factor by the latex agglutination technique. A suspension of IgG-coated latex particles is mixed with a 1:20 dilution of three sera. Obvious clumping is seen in A, corresponding to a strongly positive serum; no clumping is seen in B, corresponding to a negative serum; very fine clumping is seen in C, corresponding to a weakly positive serum.

3. Hemagglutination

Hemagglutination, i.e., red cell agglutination, is the basis of a wide array of serological tests that can be subclassified depending on whether they detect antibodies against red cell determinants (direct and indirect hemagglutination) or against compounds artificially coupled to red cells (passive hemagglutination).

Direct hemagglutination tests are carried out with washed red cells that are agglutinated when mixed with IgM antibodies recognizing membrane epitopes. For example, direct agglutination tests have been used for the determination of the ABO blood group and titration of isohemagglutinins (anti-A and anti-B antibodies); for the titration of cold hemagglutinins (IgM antibodies, which agglutinate red blood cells at temperatures below that of the body), as illustrated in Figure 15.8; and for the Paul-Bunnell test, useful for the diagnosis of infectious mononucleosis. This last test detects circulating heterophile antibodies (cross-reactive antibodies that combine with antigens of an animal of a different species) that induce the agglutination of sheep or horse erythrocytes.

Hemagglutination is simple to execute and requires very simple materials. However, the tests for cold agglutinins associated with infectious diseases (see Chapter 22) and the Paul-Bunnell test lack specificity.

Indirect hemagglutination is used to detect antibodies that react with antigens present in the erythrocytes but which by themselves cannot induce agglutination. Usually these are IgG antibodies that are not as efficient agglutinators of red cells as polymeric IgM antibodies. A second antibody directed to human Immunoglobulins is used to induce agglutination by reacting with the red cell-bound IgG molecules and, consequently, cross-linking the red cells.

The technique is simple to perform. Poor sensitivity is the main limitation. The best known example of indirect agglutination is the antiglobulin or Coomb's test, which is used in the diagnosis of autoimmune hemolytic anemia (see Chapter 22).

Passive hemagglutination techniques use red blood cells as a substrate, much as latex is used in tests involving inert particles. Antigen can be coated onto the red cells by a variety of methods, and the coated cells will agglutinate when exposed to specific antibody. This system was used as the basis for a variety of diagnostic procedures, such as a test to

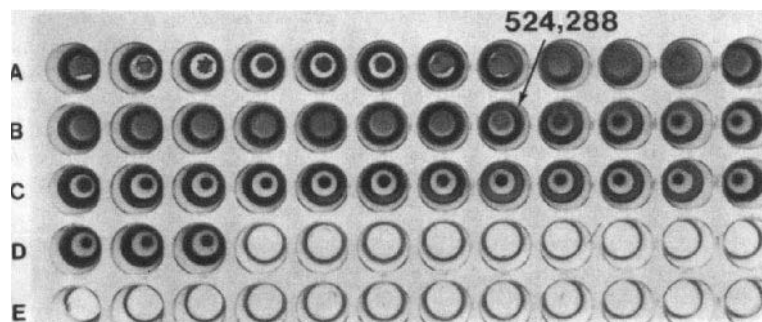

Fig. 15.8 Detection of cold agglutinins by direct hemagglutination. The wells in the microtiter plate were first filled with serial dilutions of a patient's serum (rows A and B), serial dilutions of a control serum (row C) and saline (row D), and then with 0^+ red cells, incubated at 4°C and examined for agglutination. The normal control and saline control do not show agglutination. The patient's serum shows a prozone followed by agglutination up to a dilution of 1:512,000.

detect antithyroid antibodies, the Rose-Waaler test for anti-Ig factors present in the serum of patients with rheumatoid arthritis, and many tests to detect anti-infectious antibodies. However, it has been progressively replaced by more sensitive and less time-consuming techniques.

Hemagglutination inhibition was used in a variety of ways for antigen and antibody assays, but the only clinical application that remains is the semi-quantitative assay of antibodies to influenza viruses. The influenza virus has envelope glycoproteins that agglutinate avian red blood cells (viral hemagglutinins). The immune response against the virus included antibodies that combine with these hemagglutinins and prevent red cell agglutination. A semi-quantitative assay of viral antibodies can be performed by determining the maximal dilution of serum that can inhibit viral hemagglutination. A fourfold or greater increase in titer observed in two samples collected from the same patient in an interval of 2–3 weeks is considered indicative of a recent infection. The assay is not very useful clinically but is essential to confirm the diagnosis of viral influenza and for the epidemiological surveillance of this infection.

D. Tests Based on Complement Fixation

When antigen and antibodies of the IgM or the IgG classes are mixed, complement is “fixed” to the antigen-antibody aggregate. If this occurs on the surface of a red blood cell, the complement cascade will be activated and hemolysis will occur. The method actually involves two antigen-antibody-complement systems: a test system and an indicator system (Fig. 15.9).

The indicator system consists of red blood cells that have been preincubated with a specific anti-red cell antibody in concentrations that do not cause agglutination and in the absence of complement to avoid hemolysis; these are designated as “sensitized” red cells.

In the test system, patient’s serum is first heated to 56°C to inactivate the native complement and adsorbed with washed sheep red blood cells (RBC) to eliminate broadly cross-reactive anti-red cell antibodies (also known as Forssman antibodies), which could interfere with the assay. Then the serum is mixed with purified antigen and with a dilution of fresh guinea pig serum used as a controlled source of complement. The mixture is incubated for 30 minutes at 37°C to allow any antibody in the patient’s serum to form complexes with the antigen and fix complement. Sensitized red cells are then added to the mixture.

If the red cells are lysed, it indicates that there were no antigen-specific antibodies in the serum of the patient, so complement was not consumed in the test system and was available to be used by the anti-RBC antibodies, resulting in hemolysis. This reaction is considered negative. If the red cells are not lysed, it indicates that antibodies specific to the antigen were present in the test system, “fixed” complement, but none were available to be activated by the indicator system. This reaction is considered positive.

Complement-fixation tests are widely applicable to the detection of antibodies to almost any antigen. Thus, complement-fixation reactions have been widely used in a large number of tests designed to assist in the diagnosis of specific infections, such as the Wassermann test for syphilis and tests for antibodies to *Mycoplasma pneumoniae*, *Bordetella pertussis*, many different viruses, and fungi such as *Cryptococcus*, *Histoplasma*, and *Coccidioides immitis*. However, the methodology is riddled with technical difficulties, and complement-fixation tests have been progressively replaced by other methods.

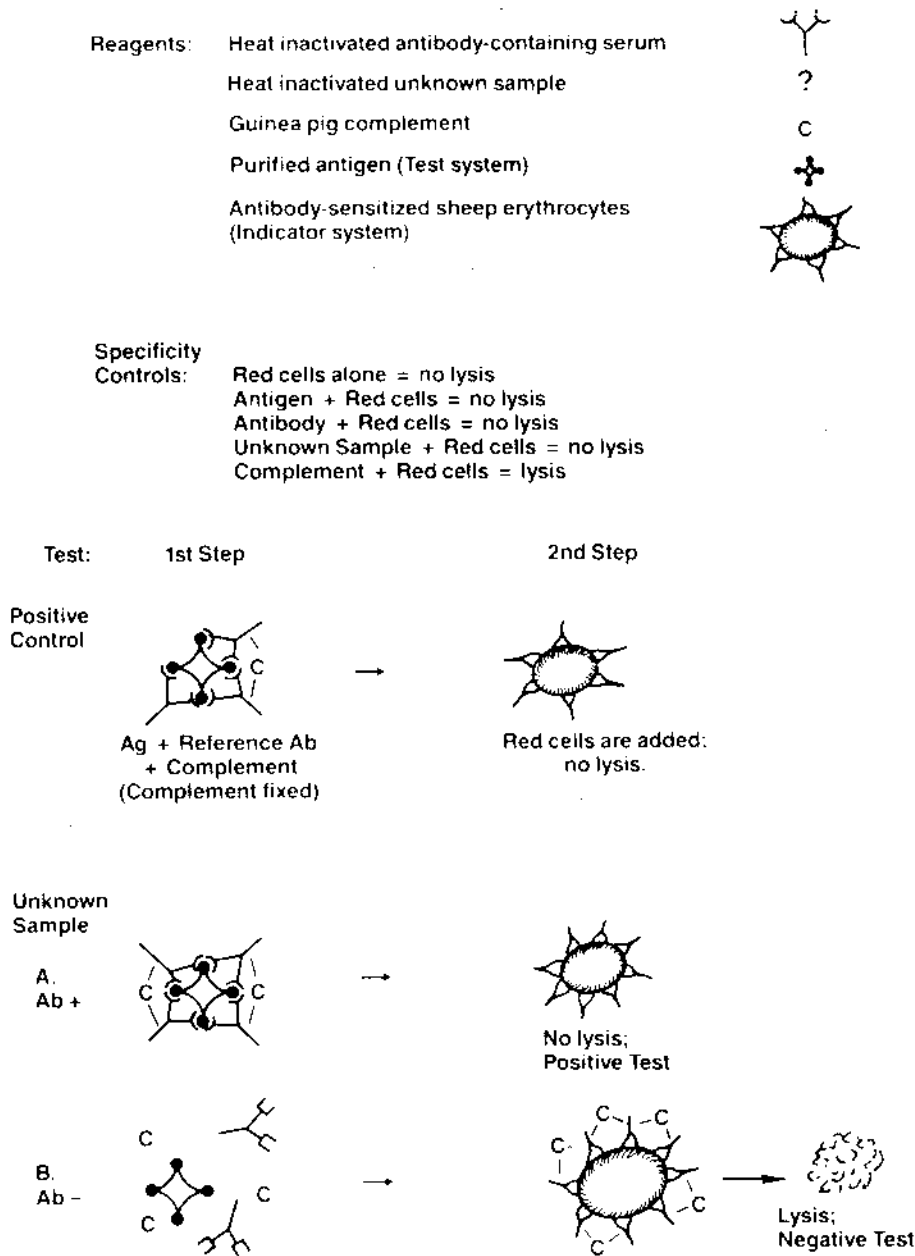

Fig. 15.9 Diagrammatic representation of the general principles of a complement fixation test.

E. Tests Based on Immunofluorescence

The primary reaction between antibodies chemically combined with fluorescent dyes and cell or tissue-fixed antigens can be visualized in a suitable microscope. Several variations of immunofluorescence can be used to detect the presence of unknown antigen in cells or tissues and the presence of unknown antibodies in patient's serum (Fig. 15.10).

1. Direct immunofluorescence visualizes antigen in a cell or tissue involves direct labeling with fluorescent antibody. Similarly, tissue-deposited antigen-antibody complexes can be revealed by reaction with a fluorescent anti-immunoglobulin antibody.
2. Indirect immunofluorescence (as all indirect tests) involves two steps: (1) incubation of a substrate containing a fixed antigen (e.g., in a cell or tissue) with unlabeled antibody, which becomes associated with the antigen, and (2) after careful washing, a fluorescent antibody (e.g., fluorescent-labeled anti-IgG) is added to the substrate. This second antibody will become associated with the first, and the complex antigen-antibody 1-antibody 2 can be visualized on the fluorescence microscope. The indirect method has the advantage of using a single labeled antibody to detect many different specific antigen-antibody reactions.

1. Immunofluorescence Tests In Microbiology

Immunofluorescence has been widely applied in diagnostic tests. In microbiology it can be used to identify isolated organisms, to visualize infectious organisms in tissue biopsies or

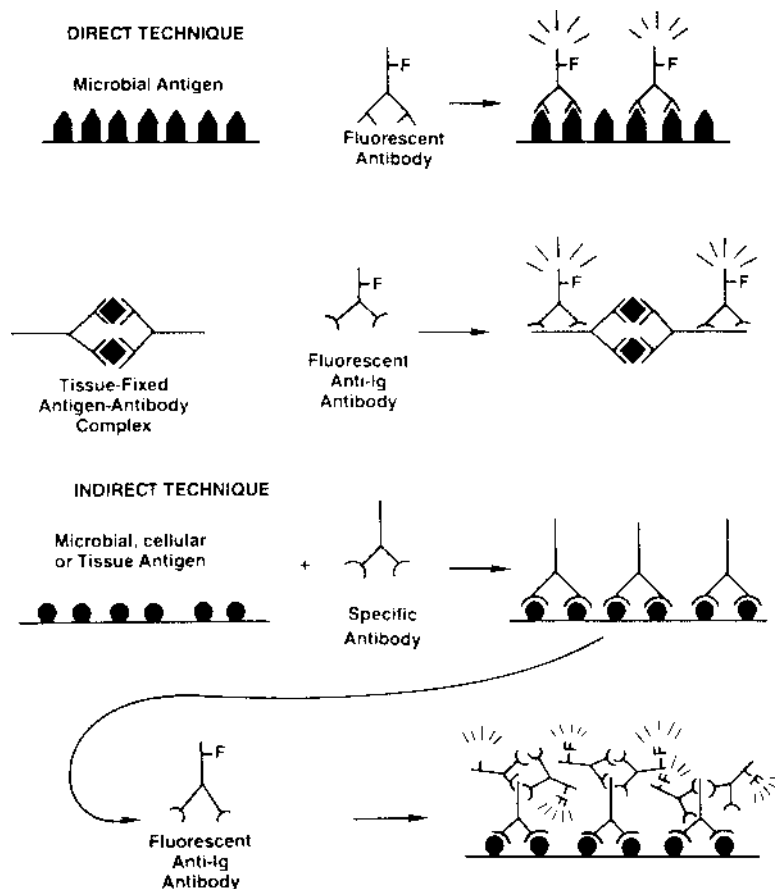

Fig. 15.10 Diagrammatic representation of the general principles of direct and indirect immunofluorescence.

exudates, and to diagnose an infection through the demonstration of the corresponding antibodies. A classical example is the use of the indirect fluorescence test for the diagnosis of syphilis. In a first step, the patient's serum is incubated with killed *Treponema pallidum*; in the second step, a fluorescence-labeled anti-human antibody is used to determine if antibodies from the patient's serum become bound to *Treponema*. Similar techniques have been used for the diagnosis of some viral diseases using virus-infected cells as a substrate.

Using fluorescent antibodies specific for different immunoglobulin isotypes, it is possible to identify the class of a given antibody after it has been captured on an antigen-coated solid phase. While IgG antibodies can be present in circulation for extended periods of time, IgM antibodies are characteristic of the early stages of the primary immune response. Thus, tests specifically designed to detect IgM antibodies are particularly useful for the diagnosis of ongoing infections.

2. *Quantitative Immunofluorescence Assays*

Quantitative immunofluorescence assays have been developed as a result of the introduction of fluorometers. The principles are similar to those just mentioned: antigen is bound to a solid phase, exposed to a serum sample containing specific antibody, unbound immunoglobulins are rinsed off, and a fluorescein-labeled antibody is added to reveal the antibody that reacted specifically with the immobilized antigen. A fluorometer is used to assay the amount of fluorescence emitted by the second antibody. Since the amount of fluorescent antibody added to the system is fixed, the amount that remains bound is directly proportional to the concentration of antibody present in the sample. Thus, a quantitative correlation can be drawn between the intensity of fluorescence and the concentration of antibody added in the first step. These quantitative tests have been adapted to microbiological assays because they can combine quantitative and analytical properties (e.g., distinguishing IgG from IgM antibodies).

3. *Immunofluorescence Tests for the Detection of Autoantibodies*

Immunofluorescence is also the technique of choice for the detection of autoantibodies such as antinuclear antibodies. Classically, the suspect serum is incubated with an adequate tissue (rat kidney, HeLa cells), and indirect immunofluorescence is performed in a second step to detect antibodies fixed to the substrate. In a positive test, the nuclei of the cells used as substrate will be fluorescent. The pattern of nuclear fluorescence is variable and has diagnostic implications (see Chapter 18). Autoantibodies directed to a variety of tissue antigens can be detected by immunofluorescence, and this is the basis for a variety of tests used in the evaluation of a variety of organ-specific autoimmune diseases (see Chapter 17).

Anti-double-stranded (ds) DNA antibodies can also be detected by immunofluorescence using a parasite (*Chritidia lucilliae*), which has a kinetoplast composed of pure ds DNA. Fixed parasites are incubated with patient's serum in the first step. Anti-ds DNA antibodies, if present, will bind to the kinetoplast and will be revealed with fluorescein-labeled anti-IgG antibody (Fig. 15.11).

4. *Immunofluorescence Tests to Detect Tissue-Fixed Antigen-Antibody Complexes*

Immunofluorescence assays have been extensively used by immunopathologists to detect immune complexes deposited in a variety of tissues. The technique usually involves per-

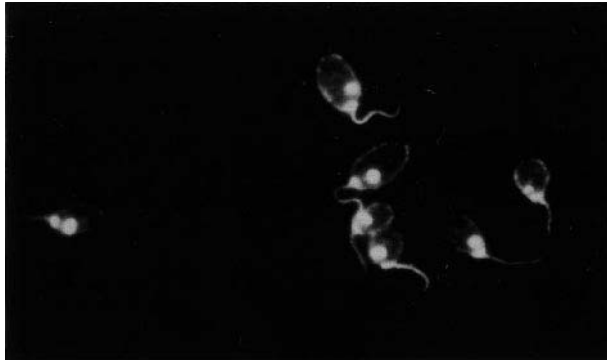

Fig. 15.11 Positive immunofluorescence test for dsDNA antibodies using *Crithidia lucilliae* as a substrate. This noninfectious flagellate has a kinetoplast packed with double-stranded DNA. The test is done by incubating the flagellate with patient's serum in the first step and, after careful washing, with a fluorescent labeled anti-human IgG antibody. After washing the excess of fluorescent-labeled antibody, the test is read on the fluorescence microscope. Visualization of the kinetoplast reflects the binding of anti-dsDNA.

forming a biopsy to obtain a tissue fragment that is then frozen and sectioned. The frozen sections are then incubated with fluorescence-labeled antibodies to immunoglobulins, C3, and fibrinogen (usually deposited in inflamed lesions).

5. Flow Cytometry

The development of murine hybridomas producing monoclonal antibodies to different cell markers has resulted in the development of reagents able to detect about 200 different cell membrane-associated antigenic systems. Many of those are expressed by lymphocytes, and a select few are known to identify subpopulations with different functions or on different stages of activation (see Chapter 10). A variety of lymphocyte populations and subsets can be identified and enumerated by flow cytometry using fluorescent-labeled monoclonal antibodies.

The principle of flow cytometry, as illustrated in Figure 15.12, is relatively simple. A diluted blood sample is incubated with one or several fluorescent-labeled monoclonal antibodies (if more than one antibody is used, each one is labeled with a different fluorochrome). The samples are further diluted so that they flow into a cell as a unicellular stream and are analyzed through light scattering and fluorescence. Light scattering measurements allow sizing of the cells (forward light scattering) and determination of their granularity (lateral light scattering, usually measured at 90°). Fluorescence measurements allow the determination of the number of cells expressing markers recognized by specific, fluorescent-labeled, monoclonal antibodies. By means of computer-assisted analysis, cell populations of homogeneous size can be segregated from cross-reactive cell types, which may express identical markers but be of a totally different nature, and analyzed for the expression of one or several markers. Using monoclonal antibodies labeled with different fluorochromes able to measure fluorescence at different wavelengths, it is possible to analyze cells for the simultaneous expression of three to five different markers (Fig. 15.13).

Surface Staining. The staining of membrane markers has found extensive applications in the study of quantitative and qualitative leukocyte abnormalities. The

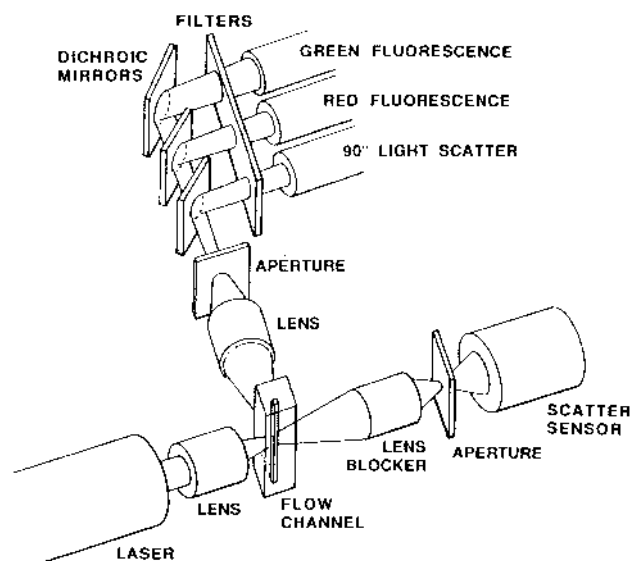

Fig. 15.12 Diagrammatic representation of the principle of flow cytometry. A cell suspension is premixed with one or two different monoclonal antibodies to cell surface markers, and as it flows on an optic channel, several parameters are analyzed: light scattered (forward and at a 90° angle) and emission of fluorescence light at two different wavelengths. The light scattering data is processed by a microcomputer and used to discriminate different cell populations according to size. The ability to analyze fluorescence at two different wavelengths makes possible simultaneous analysis with two different antibodies, providing each one is labeled with a different fluorochrome emitting fluorescence at different wavelengths. The simultaneous consideration of fluorescence data and size data makes possible discrimination of cell populations by size and presence or absence of markers (as shown in Fig. 16.2).

main CD markers used to define T lymphocytes, B lymphocytes, and NK cells, and their subpopulations are listed in Tables 15.1 to 15.3. The study of T-lymphocyte subsets has found its main clinical application in the characterization of T-lymphocyte development abnormalities (e.g., primary immune deficiencies), acquired T-lymphocyte subpopulation deficiencies (e.g., AIDS), abnormalities in the quantitative distribution of T-lymphocyte subpopulations (e.g., certain autoimmune diseases), and expression of markers not usually detected in normal peripheral blood lymphocytes (as in many types of leukemia).

CD19 and CD20 monoclonal antibodies are used to enumerate B cells. The fact that dendritic cells also express CD20 is inconsequential when phenotyping peripheral blood B lymphocytes. It should be noted that CD19, CD20, and MHC-II are not expressed by plasma cells; these cells express specific antigens, such as PCA-1.

Monocytes are usually identified by conventional staining on peripheral blood smears. When needed, these cells can be phenotyped on the basis of a combination of antigens, such as CD16 (common to all granulocytes and neutrophils), CD64 (high-affinity Fc receptor, unique to monocytes), and markers associated with the conserved regions of MHC-II (common to all antigen-presenting cells).

Phenotyping of NK cells with monoclonal antibodies is the most popular parameter to assess this cell subpopulation in a clinical context. However, the precise phenotype as-

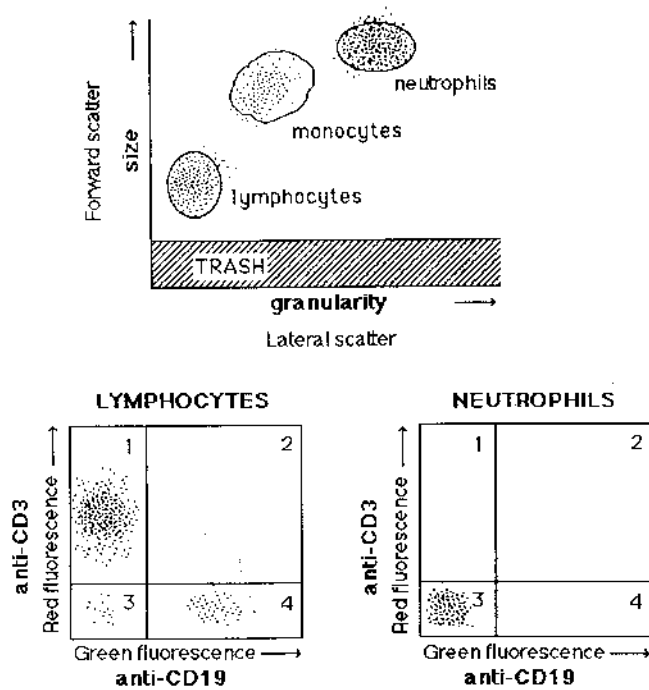

Fig. 15.13 Diagrammatic representation of the data processing sequence in flow cytometry. The top drawing illustrates a plot of forward vs. lateral light scattering of peripheral blood mononuclear cells. Three leukocyte populations can be segregated by their size and granularity: neutrophils (the largest and most granular), monocytes, and lymphocytes (the smallest and less granular). The lines surrounding these populations correspond to “gating,” i.e., instructing the computer to process separated data from these three populations. The two lower graphs represent analysis of fluorescence for two of the leukocyte populations. The lymphocytes can be separated into two different subpopulations: those reacting with rhodamine-labeled anti-CD3 antibodies, which emit red fluorescence and correspond to T lymphocytes, and those that treat with fluorescein-labeled anti-CD19, which emits green fluorescence and corresponds to B lymphocytes. The analysis of neutrophils shows lack of reactivity with both antisera.

Table 15.1 Major T-Lymphocyte Markers Recognized by Monoclonal Antibodies

CD marker	Cell distribution	Functional association(s)
CD2	All T lymphocytes	Interaction with CD58
CD3	All T lymphocytes	Transducing unit for TcR
CD4	Helper T cells, monocytes	Interaction with MHC-II
CD5	All T cells; activated autoreactive B cells	B-cell autoreactivity
CD8	Cytotoxic T lymphocytes; NK cells	Interaction with MHC-I
CD25	Activated T and B lymphocytes; monocytes and macrophages ^a	Low-affinity IL-2 receptor (β chain)
CD26	Activated T lymphocytes	Dipeptidylpeptidase IV
CD45RA	T and B lymphocytes; monocytes	“Naive” CD4 ⁺ lymphocytes
CD45RO	T-lymphocyte subset; granulocytes; monocytes	Activated helper/memory CD4 ⁺ lymphocytes
CD71	Activated lymphocytes; macrophages	Transferrin receptor

^a Expression is maximal on mitogenically stimulated T lymphocytes.

Table 15.2 Major B-Lymphocytes Markers Recognized by Monoclonal Antibodies

CD marker	Cell distribution	Functional association(s)
CD5	All T cells; activated autoreactive B cells	B-cell autoreactivity
CD10 (CALLA)	Pre-B cells, granulocytes	B-cell leukemia marker
CD19	All B cells	B-cell activation
CD20	All B cells; dendritic cells	
CD21	All B cells; dendritic cells	CR2; Epstein-Barr virus receptor
CD22	All B cells	Interaction with CD45RO on T cells
CD23	Activated B cells, eosinophils, macrophages	FcεRII (low affinity)
CD25	Activated T and B cells	Low-affinity IL-2 receptor (β chain)

sociated with a fully activated NK cell has not been established, and the enumeration of the resting NK cell population may not be very informative.

Cytoplasmic Staining. Flow cytometry can also be used to detect cytoplasmic proteins. A common example is the determination of cells containing terminal deoxynucleotidyl transferase (Tdt), a nuclear enzyme present in immature blood cells. It catalyzes the polymerization of deoxynucleotide triphosphates in the absence of a template. Its presence, usually detected by immunofluorescence, is characteristic of immature T and B lymphocytes and of the differentiated lymphocytes in leukemias and lymphomas. Its importance is therefore related to the investigation of lymphocyte ontogeny and to the classification of lymphocytic malignancies.

Flow cytometry is also now commonly used for the detection of intracellular cytokine production. In addition to the cytokine measurement, with flow cytometric analysis the phenotype of the cytokine-producing cells can be evaluated.

DNA Analysis. Flow cytometric analysis of DNA index and cell cycle distribution has clinical utility in the diagnosis and evaluation of cancers. The wide array of DNA-binding fluorescent dyes, such as acridine orange (AO), propidium iodide (PI), Hoechst 33342, and 7-amino-actinomycin D (7-AAD), makes flow cytometry a powerful tool for nucleic acid analysis. Furthermore, flow cytometry is one of the preferred methods in the analysis of apoptosis. Flow cytometry is less labor intensive than other procedures for DNA analysis, and it allows for the simultaneous detection of cell surface phenotype and DNA content.

Sorting. Some flow cytometers have the ability to collect populations of cells (sort) or individual cells (clone) expressing a given phenotype, based on the expression of surface antigens. This powerful combination of analysis and isolation has been invaluable to the

Table 15.3 Major NK-Cell Markers Recognized by Monoclonal Antibodies

CD marker	Cell distribution	Functional association(s)
CD7	All T cells, NK cells	Unknown
CD8	T cytotoxic/suppressor cells, NK cells	Interaction with MHC-I
CD16	Neutrophils, monocytes, NK cells	FcγRIII (low affinity)
CD56 (N-CAM)	NK cells, neural cells	Intercellular adhesion molecule
CD57	NK cells	Unknown

field of immunology research. In particular, the study of hematopoiesis and lymphopoiesis has benefited from this technology. Researchers have been able to assess the differentiation potential of individual cloned progenitor cells in response to a variety of stimuli. Because the progenitor cells were sorted at the single-cell level (cloned), questions regarding contaminating cell populations could not be raised. This approach has limitations, including time consumption, cost, sharing of markers by different cell populations, and relatively low yields.

A second approach that has become progressively more popular is magnetic sorting. This technique utilizes “magnetic” monoclonal antibodies, i.e., monoclonal antibodies to which magnetic microparticles have been chemically attached. After batch incubation of mononuclear cells with the magnetic monoclonal antibodies, the tube containing the mixture is placed in a magnetic field that attracts those cells with the marker recognized by the monoclonal antibody to the wall of the tube. Cells not recognized by the monoclonal antibody remain in suspension and can be aspirated and further fractionated or discarded. To separate the cells retained on the tubes, the tubes are carefully rinsed while under the influence of the magnetic field and then moved away from the magnetic field. The antibody-coated cells precipitate to the bottom of the tube, and the precipitated cells are then incubated at 37°C to dissociate them from the magnetized monoclonal antibody.

F. Radioimmunoassay

The introduction of radiolabeled components into immunoassays was a very significant development, because it made it possible to develop assays combining high specificity and high sensitivity.

The first radioimmunoassays (RIAs) were based on the principle of competitive binding: unlabeled antigen competes with radiolabeled antigen for binding to antibody with the appropriate specificity. Thus, when mixtures of constant amounts of radiolabeled and variable amounts of unlabeled antigen are incubated with fixed concentrations of the corresponding antibody, the amount of radiolabeled antigen that remains unbound is directly proportional to the quantity of unlabeled antigen in the mixture. One of the problems with the early assays was the separation of free antigen from antigen-antibody complexes. Usually that was achieved by either cross-linking the antigen-antibody complexes with a second antibody or by means of the addition of reagents that promoted the precipitation of antigen-antibody complexes, such as ammonium sulfate or polyethylene glycol. Counting radioactivity in the precipitates allowed the determination of the amount of radiolabeled antigen co-precipitated with the antibody and a calibration curve was constructed by plotting the percentage of antibody-bound radiolabeled antigen against known concentrations of a standardized unlabeled antigen (Fig. 15.14). The concentrations of antigen in patient samples were extrapolated from that curve.

The introduction of solid-phase RIA simplified considerably the separation of free and antibody-bound radiolabeled antigen (Fig. 15.15). Depending on the objective of the assay, antigen or antibodies are immobilized by coupling or absorption to a solid surface (test tube wall, polystyrene beads, etc.). Competitive solid phase RIA for antigens are carried out by adding mixtures of labeled and unlabeled antigen to the solid phase containing immobilized antibody. Unbound reagents are washed off from the solid phase and radioactivity is counted to determine the amount of labeled antibody retained in each one of the different mixtures tested. A calibration curve is constructed based on the binding of labeled antigen in mixtures with a known amount of unlabeled antigen used as calibrator.

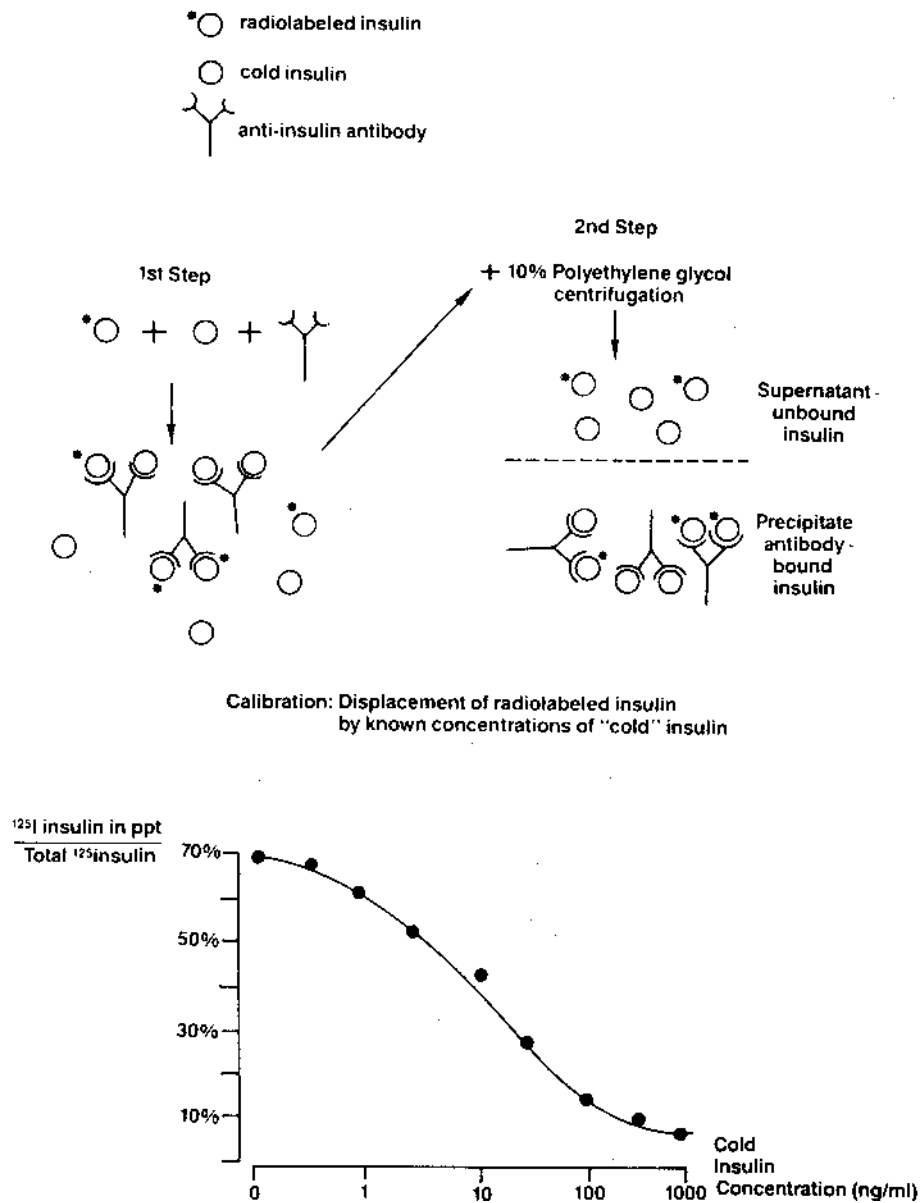

Fig. 15.14 Diagrammatic representation of the general principles of competitive radioimmunoassay in fluid phase. In this type of assay (e.g., insulin level assay), the free and antibody-bound antigens are separated either by physicochemical techniques, as shown in the diagram, or by using a second antibody (anti-immunoglobulin) to precipitate the insulin-antibody complexes formed in the first step of the assay.

From that curve the concentrations of the same antigen in biological samples can be determined, based on how much radiolabeled antigen from the mixtures with unknown samples became associated with the immobilized antibody.

Noncompetitive solid phase RIA for the detection of specific antibodies has also been described. The antigen is bound to the solid phase, the antigen-coated solid phase is ex-

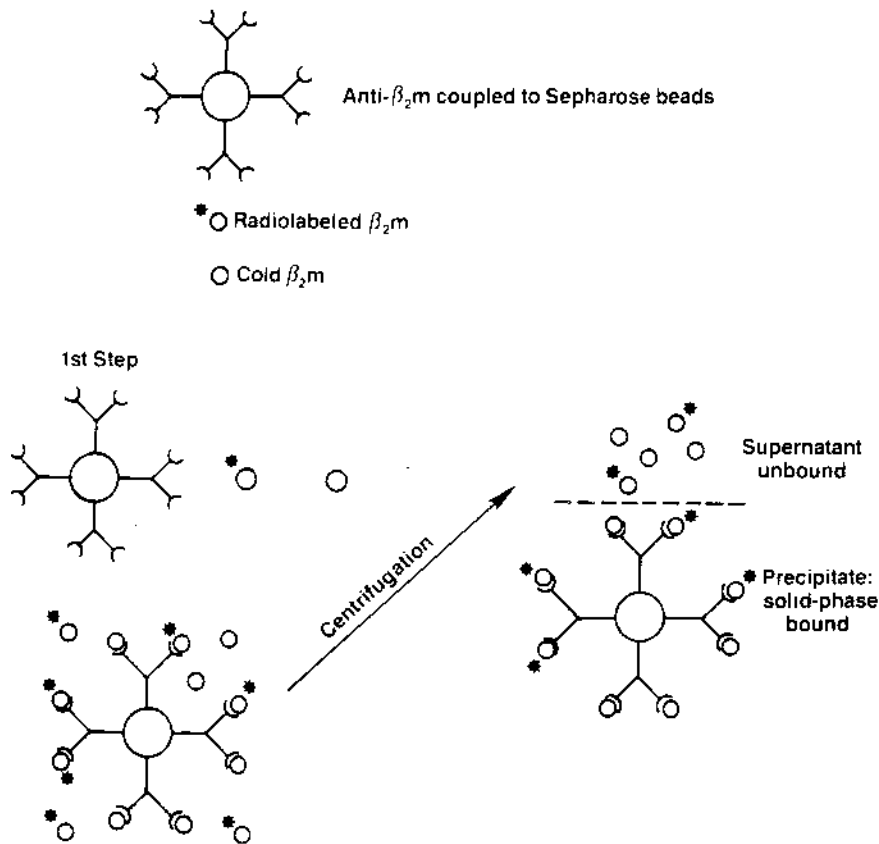

Fig. 15.15 Diagrammatic representation of the general principles of competitive radioimmunoassays in solid phase. In this example (an assay for β_2 -microglobulin), since the antibody is bound to an insoluble matrix, the separation of free antigen from antibody-bound antigen is achieved by simple centrifugation. The calibration of the assay follows the simple principles shown in Figure 15.14.

posed to a sample containing antibody, and a radiolabeled anti-human immunoglobulin is used to assay the antibody that becomes bound to the immobilized antigen.

Radioimmunoassays have been used with extremely good results in the assay of many different hormones (insulin, aldosterone, human follicle-stimulating hormone, progesterone, testosterone, thyroxin, vasopressin, etc.), proteins (α -fetoprotein, carcinoembryonic antigen, IgE, hepatitis B surface antigen), nucleic acids [DNA, vitamins (vitamin B₁₂), drugs (digoxin, LSD, barbiturate derivatives), enzymes (pepsin, trypsin), etc.

The extremely high sensitivity of RIA, which can easily determine concentrations in ng/mL range or even lower, is the reason why so many applications were developed. The main drawbacks of RIA are the cost of equipment and reagents, the short shelf life of radiolabeled compounds, and the problems associated with the disposal of radiolabeled substances. In recent years, RIA have been virtually replaced by quantitative fluorescence assays, chemiluminescence assays, and enzyme immunoassays.

G. Enzyme Immunoassay

Conceptually, the enzyme immunoassay (EIA) is very close to solid phase RIA; one of the components of the reaction (antigen if the purpose is to assay antibodies; antibody if the

purpose is to assay antigens) is adsorbed onto a solid phase (e.g., polystyrene tubes, plastic microtiter plates, plastic or metal beads, plastic discs, absorbent pads, etc.). The second step varies, depending on the type of assay.

In a competitive EIA for antigen, a mixture of enzyme-labeled and unlabeled antigen is added to immobilized antibody. As in competitive RIA the concentrations of labeled antigen and antibody are kept constant, and the concentration of unlabeled antigen is variable. After incubation and washing, a substrate for the enzyme used to label the antigen is added to the system. The substrate, upon reaction with the enzyme (usually peroxidase or alkaline phosphatase), develops a color, the intensity of which can be measured by spectrophotometry. Color intensity is directly proportional to the amount of bound labeled antigen, which in turn is inversely proportional to the concentration of unlabeled antigen added to the mixture.

In a “sandwich” assay for antigen, the second step consists of adding the antigen-containing sample to immobilized antibody. In a direct antibody assay, the second step is adding the antibody-containing sample to immobilized antigen (Fig. 15.16). In these two types of assays, the next step is basically the same: labeled antibody needs to be added. In

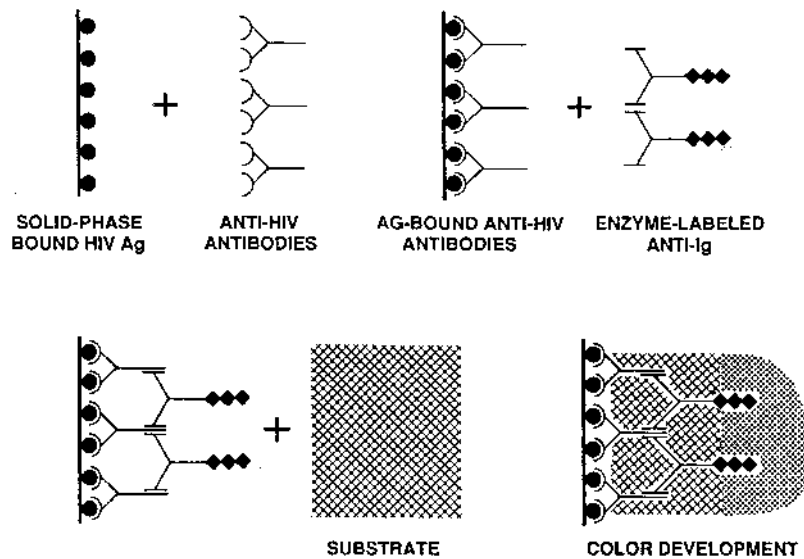

Fig. 15.16 Diagrammatic representation of an enzymeimmunoassay test for the diagnosis of HIV infection. HIV antigens, obtained from cell cultures infected with the virus, are adsorbed to the solid phase, then incubated with patient’s sera and calibrated positive sera. After washing unbound proteins, a second enzyme-labeled, antihuman immunoglobulin antibody is added to the reactants. This second antibody will bind to the patient’s immunoglobulins that had reacted with the immobilized antigen in the first step. After washing the unbound second antibody, a substrate is added; the substrate is usually colorless, but in the presence of the enzyme-labeled second antibody it will develop a color. The development of color indicates positivity, and it allows quantitative measurements, since its intensity is proportional to the amount of bound enzyme-conjugated antibody, which, in turn, is proportional to the concentration of anti-HIV antibodies bound to the immobilized antigen. The reactivity of calibrator samples with known antibody concentration is used to draw a calibration curve of color intensity versus antibody concentration. From this calibration the antibody concentrations in unknown samples are calculated.

the sandwich assay, the labeled antibody is of similar specificity to the antibody bound to the solid phase (antibodies reacting to different epitopes of the same antigen are preferred). In the direct antibody assay, the labeled antibody is an anti-immunoglobulin antibody. Finally, an enzyme-labeled component (antigen or antibody) is added, and after incubation and washing a color or chemiluminescence-generating substrate is added. In either case the color intensity is directly proportional to the concentration of the reactant being measured.

As a result of its relative simplicity and versatility, and because the shelf life of reagents is longer and there are no special problems with their storage and disposition, EIA has become perhaps the most widely used immunological assay method. Its sensitivity allows the assay of nanogram and picogram amounts without great difficulty and can be further increased by modifications of the technique. Enzymeimmunoassays for antimicrobial antibodies, antigen detection, and hormone and drug assay have been successfully developed and commercialized. The most important limitations of EIA are related to cross-reactions and nonspecific reactions, both of which can lead to false-positive results, which is a greater problem in assays of enhanced sensitivity.

Among the most interesting developments in the last decade are the rapid diagnosis EIA kits that have been developed for pregnancy and for a variety of infections, including streptococcal sore throat, respiratory syncytial virus infections, viral influenza, and HIV infection. These kits are extremely simple to use and can be used at home by the patients or at any doctor's office with minimal training and instrumentation.

The original rapid tests for pregnancy were sandwich assays that used two monoclonal antibodies recognizing two different, noncompeting epitopes in human chorionic gonadotrophin. One antibody was immobilized onto a solid phase, and its function is to capture the antigen (hCG). The second was labeled with an enzyme and would be retained on the solid surface only if antigen had been captured by the first antibody. The retention of labeled antibody was detected by a color reaction secondary to the breakdown of an adequate substrate. These tests usually involved two or more steps. One-step tests were later developed, but the manufacturers have not divulged details about their exact design.

II. LABORATORY TESTS FOR ASSESSMENT OF PHAGOCYtic CELL FUNCTION

Phagocytic cell function tests are usually performed with isolated peripheral blood neutrophils. Killing defects are the most frequent primary abnormalities of these cells and can be tested in a variety of ways. Bacterial killing tests are not routinely available in diagnostic laboratories. Instead, tests based on the induction and measurement of the respiratory burst (such as the NBT reduction test) are used to investigate those defects. These tests are discussed in detail in Chapter 13.

III. LABORATORY TESTS FOR ASSESSMENT OF LYMPHOCYTE FUNCTION

The evaluation of cell-mediated immunity presents considerable more difficulties than the evaluation of the humoral immune responses. In vivo tests, such as skin tests with common antigens known to induce delayed hypersensitive reactions, are difficult to standardize. In vitro functional tests are difficult to execute, time-consuming, and require specialized personnel and sophisticated equipment.

A. Isolation of Mononuclear Cells

All lymphocyte functional assays require at least partial isolation of a lymphocyte-enriched mononuclear cell population (mononuclear cells include lymphocytes, NK cells, and monocytes). This is usually achieved by density gradient centrifugation, usually in Ficoll-Hypaque. This separation medium has a specific gravity of 1.077, which lies between the density of human erythrocytes (1.092) and the density of human lymphocytes (1.070). By carefully centrifuging blood in Ficoll-Hypaque, a gradient is formed with erythrocytes and polymorphonuclear leukocytes sedimented at the bottom of the tube, a thin layer containing lymphocytes and monocytes appears in the interface between Ficoll-Hypaque and plasma, and platelet-rich plasma fills the rest of the tube from the mononuclear cell layer to the top. Approximately 80% of the cells recovered in the mononuclear cell layer are lymphocytes and 20% are monocytes. Of the lymphocytes, approximately 80% are T cells, 4–10% are B cells, and the remaining are NK cells and other non-T, non-B lymphocytes.

B. Mitogenic Stimulation Assays

Human lymphocytes can be stimulated *in vitro* by specific antigens or by mitogenic substances. Although testing the response to specific antigens should be the preferred approach to the study of lymphocyte function, the likelihood of success in such studies is limited by the fact that very few T cells (and even fewer B cells) in the peripheral blood will carry specific receptors for any antigen, even if the individual has already developed a memory response to that particular antigen. In contrast, mitogenic responses are easier to elicit because the mitogenic substances are able to stimulate nonspecifically large numbers of peripheral blood lymphocytes, and therefore lymphocyte proliferation becomes much easier to detect. The most widely used mitogens are plant glycoproteins (lectins), such as phytohemagglutinin (PHA), concanavalin A (ConA), and pokeweed mitogen (PWM). PWM stimulates both B cells and T cells, while PHA and ConA stimulate T cells only. Immobilized anti-CD3 monoclonal antibodies also have mitogenic properties. When immobilized on a tissue culture plate, for example, these antibodies cross-link multiple TcR complexes on the T-lymphocyte membrane and deliver a mitogenic signal to CD3⁺ T lymphocytes. The immobilization of the monoclonal antibody can be easily achieved by spontaneous adsorption to the walls of the microculture plates used in proliferation assays or by binding to monocytes present in the mononuclear cell culture through Fc receptors. The use of anti-CD3 as a mitogen has the advantage of probing the function of the transducing component of the T-cell receptor.

These mitogenic stimulation assays are performed with mononuclear cell suspensions, usually adjusted at 1×10^6 lymphocytes/mL, to which a stimulating compound is then added, usually in two or three different concentrations. Upon stimulation, T lymphocytes are activated and eventually undergo differentiation. Several endpoints are used to detect lymphocyte activation:

1. Incorporation of tritiated thymidine into dividing cells is the most common endpoint used to measure lymphocyte proliferation. In the stage of blastogenic transformation there is intense lymphocyte proliferation with active DNA synthesis. Tritiated thymidine [³H-Tdr] is added to the culture after 72 hours of incubation with the mitogen, and the dividing cells remain exposed to ³H-Tdr for 6–8 hours. The lymphocytes are then harvested, washed, and the amount of radioactivity in-

incorporated into DNA by the dividing cells is determined with a scintillation counter. A stimulation index (SI) can be calculated as follows:

$$SI = \frac{\text{cpm in mitogen-stimulated lymphocytes}}{\text{cpm in unstimulated control lymphocytes}}$$

2. Immunoglobulin synthesis can be easily measured by determining the concentrations of IgG and IgM in supernatants harvested 5–6 days after PWM stimulation using RIA or EIA. This is the best endpoint when B-cell function is to be evaluated.
3. The identification of cytokines was quickly followed by the development of monoclonal antibodies, which became the basis for of enzymeimmunoassays that have rapidly replaced most functional assays. The availability of these assays has provided a physiological endpoint for studies of T-lymphocyte activation. (a) The assay of IL-2 by EIA is probably the method of choice for the evaluation of the initial stages of activation of the T helper cell population. The most common approach to this assay consists of incubating mononuclear cells with several concentrations of mitogenic substances for 24 hours and measuring IL-2 concentrations in the supernatants. Low or absent release of IL-2 has been observed in a variety of immunodeficiency states, particularly in patients with AIDS. (b) Expression of IL-2 receptors can be detected 24 hours after mitogenic stimulation. The expression of IL-2 receptors can be measured by flow cytometry, using fluorescent-labeled anti-CD25 (TAC) antibodies. Both T cells and B cells overexpress CD25 after activation, but with the proper combination of monoclonals, flow cytometry allows the separate determination of activated B cells and activated T cells. (c) Enzymeimmunoassays for IL-4, IL-5, IL-6, IL-10, IL-12, GM-CSF, TNF, LT α , and interferon- γ are also available, and their judicious use allows us to obtain a more complete picture of the functional response of T lymphocytes. For example, predominant release of IL-4, IL-5, and IL-10 is characteristic of T_H2 responses, while predominant release of IL-2, GM-CSF, and interferon- γ is characteristic of T_H1 responses.
4. Cytokine mRNA assays are gaining popularity particularly in the analysis of T_H1 vs. T_H2 responses. Several techniques are available, all requiring suitable cDNA probes, which can be isotopically or nonisotopically labeled. Some techniques are based on hybridization of PCR-amplified mRNA obtained from nonstimulated T-lymphocyte clones; others are based on in situ hybridization performed on slides of stimulated cells. The current techniques are semi-quantitative at best, but progress in this area has been very rapid. Cytokine production by defined cell populations can also be evaluated by flow cytometry (see Sec. I.E.). This method has several advantages over mRNA analysis; it is rapid, quantitative, and allows for the simultaneous measurement of several cytokines and surface markers.

Mitogenic responses are relatively simple to study, but the assays have a variety of problems, such as poor reproducibility and individual variations among normal individuals. In addition, these assays only measure the proliferative capacity of lymphocytes and are not very informative about their functional activity. Nevertheless, the finding of a very low mitogenic index after stimulation with a T-lymphocyte mitogen suggests a deficiency of T-cell function.

C. Response to Antigenic Stimulation

The study of the response of lymphocytes to antigenic stimulation *in vitro* is functionally more relevant than the study of mitogenic responses. However, even in the best possible circumstances, i.e., when the antigen can be recognized by T lymphocytes, which predominate in peripheral blood, and the lymphocyte donor has developed memory to the antigen in question, the proportion of cells responding to stimulation is likely not to exceed 0.1%, and the proportion of responding B lymphocytes is even lower. The probabilities of obtaining a measurable response may be increased when the lymphocytes are stimulated with antigens to which the lymphocyte donor has been previously exposed and the cultures are incubated with the antigen for 5–7 days prior to addition of ^3H -Tdr. However, this eliminates the possibility of determining whether the patient can mount a primary response.

The elicitation of B lymphocyte responses *in vitro* is considerably more difficult. Most studies in which positive results have been reported have used heterologous red cells or tetanus toxoids as antigens. The *in vitro* response to tetanus toxoid is easier to elicit using peripheral blood mononuclear cells separated from donors who had received a booster 1–3 weeks earlier. Usually, the incubation periods in studies of B-cell activation have to be increased even further, up to 9–11 days.

The antigens most commonly used in these studies are purified protein derivative (PPD), *Candida albicans* antigens, keyhole limpet hemocyanin, and tetanus toxoid (which stimulates both T and B cells), none of which has been properly standardized. In addition, some of these antigens seem to have mitogenic properties, and when ^3H Tdr incorporation is the endpoint measured, it is not possible to determine whether the response is due to antigenic or mitogenic stimulation.

D. Tetramer Assays

One of the developments with greater potential significance in the last few years has been the development of MHC/peptide tetramers. Both MHC-I and MHC-II tetramers able to bind specific peptides have been constructed, and once loaded with a peptide, they interact specifically with CD8^+ or CD4^+ T cells with TcR able to recognize the peptide-MHC combination in question. For example, MHC-I-peptide complexes loaded with peptides derived from melanoma-associated antigens have been shown to be able to bind specifically to CD8^+ lymphocytes from melanoma patients, which can be then purified and shown to be able to lyse melanoma tumor cells *in vitro*. On the other hand, MHC-II tetramers loaded with an influenza hemagglutinin (HA) peptide have been shown to bind and activate HA-specific CD4^+ T cells. The potential for application of this technique to characterize normal and abnormal aspects of cell-mediated immune responses appears almost unlimited.

E. Assay of Cytokines and Cytokine Receptors in Plasma and Urine

While antigenic and mitogenic stimulation assays test lymphocyte reactions under more or less physiological conditions, the target cells are those present in circulation, and it can be argued that the sampling does not adequately reflect the state of activation of their tissue counterparts. This is particularly problematic when the objective is to assess role of the T-cell system in a patient with a hypersensitivity disease. Several groups have proposed that the assay of circulating cytokines or cytokine receptors (shed as a consequence of cell activation) is more reflective of the state of activation of T cells *in vivo*. It must be noted that these assays have not proven to be as useful as expected. A major limiting factor is their

lack of disease specificity, which makes their correlation with specific clinical conditions rather difficult. In addition, the high cost of reagents is a significant limiting factor that has prevented their widespread use and proper evaluation of their usefulness.

1. Serum IL-2 levels have been measured as a way to evaluate the state of T-lymphocyte activation in vivo. Increased levels of circulating IL-2 have been reported in multiple sclerosis, rheumatoid arthritis, and patients undergoing graft rejection, situations in which T-cell hyperactivity would fit with the clinical picture. However, a significant problem with these assays is the existence of a serum factor that interferes with the assay of IL-2 by EIA, and the results are often very imprecise.
2. Urinary levels of IL-2 can also be measured by enzymeimmunoassay and are not affected by inhibitory substances. Increased urinary levels of IL-2 have been reported in association with kidney allograft rejection and proposed as a parameter, which may help differentiate acute rejection from cyclosporin A toxicity (see Chapters 26 and 27). However, this approach has not gained widespread acceptance.
3. Activated T cells shed many of their membrane receptors, including the IL-2 receptor. Elevated levels of circulating soluble receptors (shed by activated T lymphocytes) have been found in patients with hairy cell leukemia, AIDS, rheumatoid arthritis, graft rejection, etc. In general, the results of assays for IL-2 receptor parallel the results of assays for IL-2.
4. The measurement of serum IL-6 correlates with B lymphocyte activity and inflammation. High levels of IL-6 have been detected in patients with AIDS, systemic lupus erythematosus, and systemic inflammatory reactions.

F. Assays for Cytotoxic Effector Cells

The functional evaluation of cytotoxic effector cells, which include cytotoxic T lymphocytes, natural killer (NK) cells, and cells mediating antibody-dependent cell cytotoxicity (ADCC) reactions, is based on cytotoxicity assays. The functional interest of cytotoxicity assays is evident. In the case of T cells, cytotoxicity assays measure the functional adequacy of one of the major effector T-cell subpopulations. As for NK and ADCC effector cells, their functional definition requires functional assays.

The cellular targets for cytotoxic cells vary according to cytotoxic cell population to be evaluated:

The evaluation of T-cell-mediated cytotoxicity requires mixing sensitized cytotoxic T cells with targets expressing the sensitizing antigen.

NK-cell activity is usually measured with tumor cell lines known to be susceptible to NK-cell killing.

ADCC is measured using antibody-coated target cells.

Two main methods are used to assay cytotoxicity:

Counting of dead cells—dead target cells are differentiated from live target cells by the uptake of vital dyes, such as trypan blue. This technique, however, is mostly used for the study of antibody-mediated cytotoxicity.

Release of radiolabeled chromium (^{51}Cr) from previously labeled target cells is preferred when evaluating T-lymphocyte or NK-cell cytotoxicity.

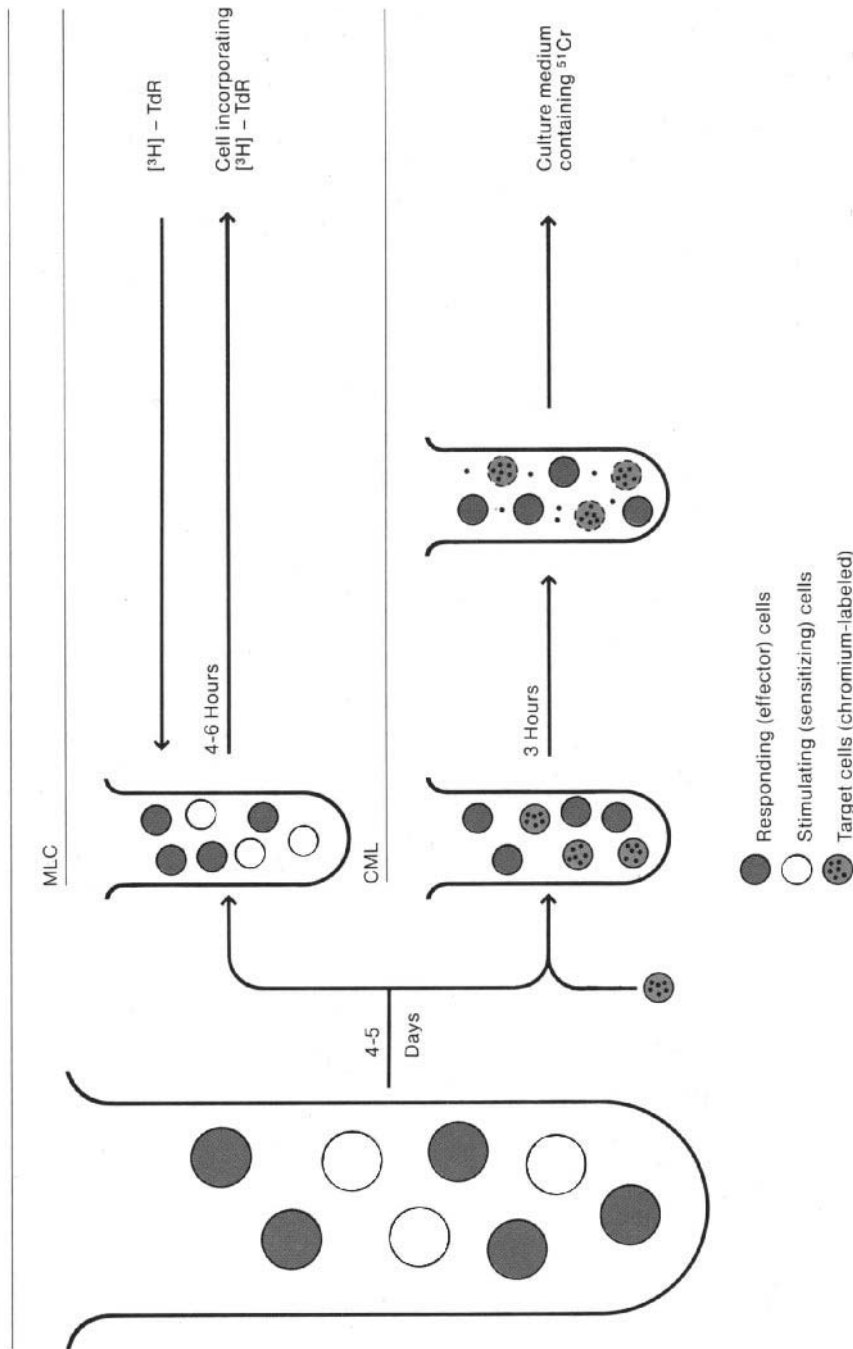

Fig. 15.17 (Top) Diagrammatic representation of a one-way mixed lymphocyte culture reaction. A mixture of viable (responder) lymphocytes and heterologous mitomycin-treated lymphocytes (stimulator cells) is incubated, and as a result the viable T lymphocytes will proliferate. At the end of 4-5 days the proliferating lymphocytes will incorporate measurable amounts of tritiated thymidine ($^3\text{H-Tdr}$). (Bottom) Diagrammatic representation of a cytotoxicity assay. The initial steps are identical to those of a mixed lymphocyte culture, but after 4-5 days of incubation viable target cells labeled with chromium (^{51}Cr) are added to the culture. The ^{51}Cr -labeled target cells are genetically identical to the stimulator cells. If the culture contains differentiated cytotoxic T lymphocytes, those will lyse the target cells and cause the release of ^{51}Cr . (Reproduced with permission from *Immunology—A Scope Publication*, R. D. Guthmann, ed. Upjohn Co., Kalamazoo, MI, 1981.)

G. Mixed Lymphocyte Reaction

One of the most informative tests for the evaluation of T-lymphocyte function in vitro is the mixed lymphocyte reaction (MLR). The basis of the MLR is the recognition of antigenic differences mostly related to the expression of class II MHC antigens on the membrane of mononuclear cells. The endpoint of the test may be $^3\text{HTdr}$ incorporation or ^{51}Cr release from target cells. It must be stressed that MLR tests are difficult and time consuming and have very limited, if any, clinical use.

One-way MLR reactions are tests in which one of the cell populations is treated with a DNA synthesis blocker so that it acts as a stimulator of non-HLA identical cells, while the other population is untreated and acts as the responder population. These reactions were used for many years to type HLA-D locus specificities, the first class II HLA specificities described. This was usually accomplished by mixing mitomycin-treated mononuclear cells from a donor of known HLA-D specificity with untreated mononuclear cells of an untyped individual (Fig. 15.17). A response in this system, measured by $^3\text{HTdr}$ incorporation, was considered as indicating lack of identity of the D locus. This cumbersome approach has been made obsolete by the development of antibodies and DNA probes to type MHC-II specificities (see Chapter 3).

The one-way MLR can also be used to evaluate cytotoxic T-cell function. In this case mitomycin-treated mononuclear cells from a genetically unrelated donor are used both as stimulators and as targets of a patient's lymphocytes. The MLR is set as a mixed culture of inactivated stimulator cells and responder T cell. The presence of MHC-II⁺ cells in the mixture is essential, because the responding CD4⁺ cells can only be activated by nonself peptides presented by nonpolymorphic MHC-II molecules shared by most individuals of the species. After incubating the culture for five days, ^{51}Cr -labeled viable "target" lymphocytes, obtained from the same individual who provided the cells used as stimulators, are added to the culture. If cytotoxic T cells were generated during the previous 5 days of culture, the viable cells added in the second step will become their targets and will be killed in a few hours, releasing significant amounts of ^{51}Cr (Fig. 15.17).

Two-way MLRs are set by mixing untreated mononuclear cells from genetically unrelated individuals. This approach is usually used to determine the compatibility of two unrelated individuals, such as when donors for a bone marrow graft are to be screened. $^3\text{HTdr}$ is added after 4–5 days to the culture to determine whether the cells are proliferating. The lack of significant $^3\text{HTdr}$ incorporation indicates that the donor and recipient are compatible.

SELF-EVALUATION

Questions

Choose the one *best* answer.

- 15.1 Which of the following tests gives more significant information concerning T-lymphocyte function?
- A. Number of CD4/CD25 (IL-2 receptor)⁺ cells
 - B. Number of CD3⁺ cells
 - C. Release of IL-2 after mitogenic stimulation
 - D. Tritiated thymidine incorporation by anti-CD3–stimulated mononuclear cells.
 - E. Tritiated thymidine incorporation by PHA-stimulated mononuclear cells.

- 15.2 In an enzymeimmunoassay for antitetanus antibodies, the intensity of color measured after adding the substrate in the final step is:
- A. Directly proportional to the concentration of antibody in the patient's serum
 - B. Directly proportional to the concentration of antigen in the solid phase
 - C. Directly proportional to the concentration of enzyme-labeled antibody
 - D. Inversely proportional to the concentration of antibody in the patient's serum
 - E. Inversely proportional to the concentration of substrate
- 15.3 In a competitive radioimmunoassay:
- A. Radiolabeled antibody is immobilized in a solid phase
 - B. Free antigen is preferentially precipitated with polyethylene glycol
 - C. The radiolabeled antigen is first incubated with immobilized antibody
 - D. The calibration curve is established by measuring the amount of labeled antigen bound to the antibody in the presence of increasing concentrations of cold antigen
 - E. The amount of radiolabeled antigen complexed with the antibody is directly proportional to the concentration of antigen in the unknown sample.
- 15.4 The serum of a patient is sent to the laboratory for a complement fixation test. The serum is heated at 56°C for 30 minutes, adsorbed with washed sheep red cells, mixed with the corresponding antigen and later mixed with a dilution of fresh guinea pig serum. The final mixture is incubated for 30 minutes at 37°C, after which "sensitized" sheep red cells are added to the mixture. After 15 minutes you can see obvious hemolysis in the test tube. All controls reacted adequately. This constitutes a:
- A. Negative reaction; there was no complement fixation.
 - B. Negative reaction; the antibodies did not react with the antigen.
 - C. Positive reaction; complement was fixed by antigen-antibody complexes.
 - D. Positive reaction; the red cells fixed complement.
 - E. Positive reaction; there was antigen in the patient's serum.
- 15.5 Which of the following steps is an essential part of a solid-phase competitive enzymeimmunoassay for insulin?
- A. Calibration based on the binding of different concentrations of cold insulin by immobilized antibody
 - B. Coupling of cold insulin to the solid phase
 - C. Coupling of enzyme-labeled insulin to the solid phase
 - D. Preparation of mixtures containing identical concentrations of enzyme-labeled insulin and variable concentrations of cold insulin
 - E. Separation of insulin-antibody complexes from free insulin by precipitation with polyethylene glycol
- 15.6 To develop a test to screen circulating anti-treponemal antibodies by immunofluorescence, you need all of the following except:
- A. A fluorescence microscope
 - B. A positive serum control, known to contain antitreponemal antibodies
 - C. A suspension of formalin-killed *Treponema pallidum*
 - D. Fluorescein-labeled anti-human IgG
 - E. Isolated patient's IgG labeled with a fluorescent compound

- 15.7 A positive EIA for HIV is routinely repeated and confirmed by Western blot before any given individual is considered HIV infected. Which one of the following problems most likely necessitates such a careful approach to the diagnosis of HIV infection?
- A. Daily variations in antibody titer
 - B. Frequent technical errors
 - C. Possible false-positive reactions
 - D. Subjectivity in the interpretation of EIA results
 - E. Variability of the results obtained by different techniques
- 15.8 Which of the following monoclonal antibodies should be coupled to magnetic microbeads to remove activated T cells from a PHA-stimulated mononuclear cell preparation?
- A. CD3
 - B. CD4
 - C. CD5
 - D. CD19
 - E. CD25
- 15.9 Which of the following manipulations is likely to inhibit a mixed lymphocyte reaction between lymphocytes of two genetically unrelated individuals?
- A. Adding anti-CD8 antibodies to the culture
 - B. Adding anti-MHC-I antibodies to the culture
 - C. Eliminating all MHC-II-positive cells
 - D. Eliminating CD25⁺ cells prior to the culture
 - E. Treating one set of lymphocytes with mitomycin
- 15.10 When the MLC is followed by a cytotoxicity assay, the target cells must be:
- A. Labeled with ¹²⁵I
 - B. Stained with trypan blue
 - C. Syngeneic with the responding cells
 - D. Syngeneic with the stimulating cells
 - E. Virus-infected

Answers

- 15.1 (C) A CD3 count is informative about the total number of T lymphocytes but is not informative about their functional status. The co-expression of CD25 (IL-2 receptor) by CD4⁺ cells is typical of activated helper T lymphocytes but does not prove whether the labeled cells are functionally competent. The mitogenic responses to PHA and anti-CD3 only give an indication about the general ability of T cells to proliferate in response of different types of stimulation. IL-2 release is probably the major determinant of the initial expansion of T cells (particularly of the T_H0 subpopulation) during an immune response and, therefore, is a better index of the functional status of T lymphocytes than any other of the listed alternatives.

- 15.2 (A) In EIA assays, the concentrations of immobilized antigen, enzyme-labeled second antibody, and substrate are kept constant; therefore, the intensity of color developed when the reaction is completed is directly proportional to the concentration of antibody in the unknown sample (patient's sera) and in the samples with known antibody concentrations used to calibrate the assay.
- 15.3 (D)
- 15.4 (A) The mixture of serum with antigen obviously did not consume complement, since complement was available to cause the lysis of "sensitized" red cells.
- 15.5 (D) Such mixtures are used for calibration of the system; when incubated with immobilized antibody, the amount of labeled insulin that is bound is inversely proportional to the concentration of free insulin in the mixture. Linear regression analysis of the correlation between bound labeled insulin and unlabeled insulin present in the mixtures prepared with known amounts of unlabeled insulin allows the extrapolation of concentrations of insulin in unknown samples to which the same concentration of labeled insulin was added.
- 15.6 (E) Although it could be possible to design an assay using patient's IgG, the steps involved in isolation of IgG from patient's serum and labeling of the isolated IgG would render the test too costly and cumbersome. In addition, it would be very difficult to ensure that the yield of antibody at the end was an accurate reflection of the serum concentration of antibody.
- 15.7 (C) False-positive reactions are one of the major limitations of some EIA procedures, and in the case of a diagnosis with such serious consequences as HIV infection, it is essential to carefully confirm a result before notifying a patient.
- 15.8 (E) Although CD25 (IL-2 receptor α chain) is expressed by both activated T and B lymphocytes, only T lymphocytes respond to PHA stimulation. Thus, a magnetic CD25 monoclonal antibody added to a PHA-stimulated mononuclear cell culture would remove activated T cells only.
- 15.9 (C) Cells expressing MHC-II are absolutely essential for the induction of a MLR. Adding MHC-I or anti-CD8 antibodies to the culture could only interfere with the cytotoxicity reaction, but not with the proliferative stage that characterizes the MLR. Few CD25⁺ cells are likely to be present prior to stimulation, and their elimination is unlikely to have a measurable effect. Treatment with mitomycin of one set of cells would not prevent the proliferation of the other set.
- 15.10 (D) The responding cells in MLR proliferate and differentiate after specifically recognizing heterologous MHC antigens. The effector cells generated in the MLR can only destroy target cells genetically identical (syngeneic) to those used to stimulate them. Trypan blue staining is not used for assessment of target cell death in MLR because of the subjectivity inherent to techniques based on microscopic observation, which are also extremely time consuming and require experienced personnel.

BIBLIOGRAPHY

- Bogulaski, R. C., Maggio, E. T., and Nakamura, R. M., eds. *Clinical Immunochemistry: Principles of Methods and Applications*. Little, Brown & Co., Boston, 1984.
- Bryant, N. J. *Laboratory Immunology and Serology*. 3rd ed. W.B. Saunders, Philadelphia, 1992.
- Collins, W. P., ed. *Alternative Immunoassays*. J. Wiley & Sons, New York, 1985.
- Collins, W. P., ed. *Complementary Immunoassays*. J. Wiley & Sons, New York, 1988.
- Cronenberg, J. H., and Jennette, J. C., eds. *Immunology. Basic Concepts, Diseases, and Laboratory Methods*. Appleton & Lange, Norwalk, CT, 1988.
- Grieco, M. H., and Meriney, D. K., eds. *Immunodiagnosis for Clinicians*. Year Book Medical Publishers, Chicago, 1983.
- Novak, E. J., Liu, A. J., Nepom, G. T. and Kwok, W. W. MHC class II tetramers identify peptide-specific human CD4+ T cells proliferating in response to influenza A antigen. *J. Clin. Invest.* 104:R63–R67, 1999.
- Phillips, T. M. *Analytical Techniques in Immunochemistry*. Marcel Dekker, New York, 1992.
- Turgeon, M. L. *Immunology and Serology in Laboratory Medicine*. 2nd ed. Mosby, St. Louis, 1996.
- Wreghitt, T. J., and Morgan-Capner, P. *ELISA in the Clinical Microbiology Laboratory*. Public Health Lab. Serv., Whaddon, England, 1990.
- Yee, C., Savage, P., Lee, P., Davis, M. M., and Greenberg, P. Isolation of high avidity melanoma-reactive CTL from heterogeneous populations using peptide-MHC tetramers. *J. Immunol.* 162:2227–2234, 1999.

16

Tolerance and Autoimmunity

George C. Tsokos, Jean-Michel Goust, and Gabriel Virella

I. HISTORICAL INTRODUCTION

In 1901 Ehrlich postulated that “organisms possess certain contrivances by means of which the immune reaction.[. . .] is prevented from acting against (its) own elements.” Such “contrivances” constitute what in modern terms is designated as “tolerance” and, still in Ehrlich’s words “are of the highest importance for the individual.” Several decades later, when autoimmune diseases were described, they were interpreted as the result of a breakdown or failure of the normal tolerance to self, resulting in the development of an autoimmune response. Ehrlich’s hypothesis was apparently supported by the definition of pathogenic mechanisms for different diseases considered as autoimmune in which the abnormal antiseif immune reaction played the main role.

The modern understanding of tolerance can be dated to the observations reported by Owen in the 1940s. Owen, a British biologist, was involved in ontogeny studies using bovine dizygotic twins, which share the same placenta. Under these circumstances each animal is exposed to cells expressing the genetic markers of the nonidentical twin during ontogenic development. When the animals are born, they often carry two sets of antigenically distinct red cells in circulation—one of the best examples of natural *chimerism*. With time, the red cell set acquired from the twin calf will disappear, but the “chimeric” calves will remain tolerant to each other’s tissues for the rest of their lives. Thus, these experiment seem to prove that there is a critical period during development during which the immune system becomes tolerant to any antigen it encounters.

Two decades later, Brunt, Medawar, and coworkers developed the first mouse models for the study of tolerance. Mice are born with an incompletely developed immune sys-

tem, and these investigators discovered that mice can be rendered tolerant to neonatally injected antigens, corroborating and expanding Owen's observation with chimeric animals.

The first theory concerning tolerance, subscribed to by Burnet, Fenner, and Medawar, is known as the clonal deletion theory of tolerance. In simple terms, this theory stated that self tolerance is achieved by the elimination of autoreactive clones during the differentiation of the immune system. However, the development of autoimmune diseases proved that deletion of these clones was not absolute. The remaining autoreactive clones must be silenced or anergized, but none of these mechanisms is foolproof for all individuals.

II. DEFINITION AND GENERAL CHARACTERISTICS OF TOLERANCE

Tolerance is best defined as a state of antigen-specific immunological unresponsiveness. This definition has several important implications.

- A. When tolerance is experimentally induced, it does not affect the immune response to antigens other than the one used to induce tolerance. This is a very important feature that differentiates tolerance from generalized immunosuppression, in which there is a depression of the immune response to a wide array of different antigens. Tolerance may be transient or permanent, while immunosuppression is usually transient.
- B. Tolerance must be established at the clonal level. In other words, if tolerance is antigen-specific, it must involve the T- and/or B-lymphocyte clone(s) specific for the antigen in question and not affect any other clones.
- C. Tolerance can result from clonal deletion or clonal anergy. Clonal deletion involves different processes for T and B lymphocytes:
 1. T lymphocytes are massively produced in the thymus and, once generated, will not rearrange their receptors. Memory T cells are long-lived, and there is no clear evidence that new ones are generated after the thymus ceases to function in early adulthood. Therefore, elimination of autoreactive T cells has been postulated to occur at the production site (thymus) at the time the cells are differentiating their TcR repertoire.
 2. B-cell clonal deletion involves different mechanisms than T-cell clonal deletion. B cells are continuously produced by the bone marrow through life and initially express low-affinity IgM on their membranes. In most instances interaction of these resting B cells with circulating self molecules neither activates them nor causes their elimination. Selection and deletion of autoreactive clones seem to take place in the peripheral lymphoid organs during the onset of the immune response. At that time, activated B cells can modify the structure of their membrane immunoglobulin as a consequence of somatic mutations in their germline immunoglobulin genes. B cells expressing self-reactive immunoglobulins of high affinity can emerge from this process, and their elimination takes place in the germinal centers of the peripheral lymphoid tissues.

Both T-cell and B-cell clonal deletion fail to eliminate all autoreactive cells. In the case of T cells, clonal deletion on the thymus will not affect clones that recognize self antigens not expressed in the thymus. Furthermore, as the thymic function declines with age, alternative mechanisms have to be in place to ensure the inactivation of autoreactive clones emerging from the differentiation of lymphoid stem cells. The causes of B-cell escape from

clonal deletion are not as well defined, but they exist nonetheless. Thus, peripheral tolerance mechanisms must exist to ensure that autoreactive clones of T and B cells are neutralized after their migration to the peripheral lymphoid tissues.

One of the postulated peripheral tolerance mechanisms is known as clonal anergy, a process that incapacitates or disables autoreactive clones that escape selection by clonal deletion. Thus, anergy can be experimentally induced after the ontogenic differentiation of immunocompetent cells has reached a stage in which clonal deletion is no longer possible.

By definition, anergic clones lack the ability to respond to stimulation with the corresponding antigen. Thus, the most obvious manifestation of clonal anergy is the inability to respond to proper stimulation. Anergic B cells carry IgM autoreactive antibody in their membrane but are not activated as a result of an antigenic encounter. Anergic T cells express TcR for the tolerizing antigen, but fail to properly express the IL-2 and IL-2 receptor genes in response to antigenic stimulation.

The mechanisms responsible for anergy have been the object of considerable interest. In a simplistic way it can be stated that anergy results from either an internal block of the intracellular signaling pathways or from down-regulating effects exerted by other cells. One major mechanism that is involved in anergy is the incomplete signaling of an immunocompetent cell. This may result in either a block of the intracellular activation pathways or in the developmental arrest of autoreactive clones, which fail to fully differentiate into mature clones of effector cells. As for immunoregulatory cells, emphasis has been placed on those that release IL-10 and or TGF- β . Both mechanisms are discussed in detail later in this chapter.

As is often the case, when several mechanisms leading to a similar end result are defined, they end up not being mutually exclusive. Indeed there is ample evidence suggesting that tolerance results from a combination of clonal deletion and clonal anergy. Both processes must coexist and complement each other under normal conditions so that autoreactive clones, which escape deletion during embryonic development, may be downregulated and become anergic. The failure of either one of these mechanisms may result in the development of an autoimmune disease.

III. ACQUIRED TOLERANCE; TOLEROGENIC CONDITIONS

Acquired tolerance can be induced in experimental animals under the right conditions, known as tolerogenic conditions (Table 16.1). The main factors that influence the development of tolerance are as follows:

1. *Immune competence of the host.* Newborn inbred mice of strain A injected with lymphoid cells from mice of a different genetic strain (strain B) prior to reaching adult life and immunological maturity can tolerate a skin graft from mice of

Table 16.1 Factors Influencing the Development of Tolerance

Host
Genetic predisposition
Soluble, small-sized antigen
Antigen structurally similar to self protein
Intravenous administration of antigen
High- or low-dose antigen

the donor strain (strain B). Therefore, exposure to a given antigen very early in life results in acquisition of long-lasting tolerance.

2. *Pharmacological Immunosuppression.* An extension of the concept that an immunoincompetent host is predisposed to develop tolerance led to experiments that demonstrated that tolerance can be achieved in animals whose degree of immune competence is artificially lowered (e.g., by drug-induced immunosuppression). This is the basic rationale for the use of immunosuppressive drugs in organ transplantation.
3. *General structure and configuration of the antigen.* An antigen that induces tolerance is termed a tolerogen. Size and molecular complexity are among the most important factors determining whether a substance is antigenic or tolerogenic. For example, the response of the immune system to the injection of aggregates versus soluble monomers of a given protein is drastically different. When the aggregated protein is injected, an active immune response is elicited. If, instead, all protein aggregates are removed from the suspension by high-speed centrifugation and only soluble protein monomers are injected, it is easier to achieve a state of tolerance.

Large or complex antigens are usually not tolerogenic because they are phagocytosed and processed by macrophages, creating optimal conditions for stimulation of an immune response. In contrast, small, soluble antigens may not be taken up by the macrophages and thus fail to be adequately presented to helper T cells. The resulting lack of co-stimulation signals will favor the development of tolerance.

Exceptions to these rules have been noted. Some autoantigen-derived peptides have been used to induce tolerance in laboratory animals. It is possible that such peptides are able to bind directly to MHC-II molecules and may deliver tolerogenic signals to T lymphocytes with the corresponding autoreactive TcR.

4. *Degree of structural homology.* Antigens with a high degree of structural homology with endogenous proteins of the animal into whom they are injected are more likely to induce tolerance. For example, tolerance to human immunoglobulins should be easier to induce in primates than in rodents, since the primary structure of human and primate immunoglobulins is considerably more similar than the primary structure of human and rodent immunoglobulins.
5. *Degree of immunogenicity.* The immunogenicity of a given antigen is the result of several factors, some antigen-related (such as the degree of structural homology with host proteins and the chemical complexity of the antigen, discussed above), and some related to the genetic constitution of the animal. Some antigens are strongly immunogenic in a given species or strain and not in another. It is extremely difficult or impossible to induce tolerance against a strong immunogen.
6. *Route of antigen administration.* Tolerance is achieved more easily when antigens are injected intravenously rather than intramuscularly or subcutaneously, probably as a result of dilution in the systemic circulation.
7. *Antigen dosage.* Experiments designed to determine the relationship between dosage, and the induction of tolerance showed that tolerance can be induced with antigen doses well below or well above those that are optimal for the induction of a response. Thus, tolerance can be classified into two major types: high zone and low zone (Table 16.2). Physiological tolerance is, in most cases, low-zone tolerance, primarily affecting T lymphocytes.

Table 16.2 A Comparison of the Characteristics of High-Zone and Low-Zone Tolerance

	High-zone tolerance	Low-zone tolerance
Antigen dose	High	Low
Cells involved	T and B cells	T cells only
Onset	Slow	Quick
Duration	Short	Long-lasting
Physiological significance	Questionable	Important

Weigle and coworkers induced tolerance with a single dose of aggregate-free human gamma globulin (HAGG) and followed longitudinally the ability of various combinations of T and B lymphocytes of the tolerized animals and normal controls to reconstitute the immune response in sublethally irradiated mice (Fig. 16.1). T-cell unresponsiveness developed after 1–2 days and lasted over 49 days, while B-cell unresponsiveness was obvious only after more than a week from the time of injection of HAGG and was of shorter duration, since by day 49 the B cells of the injected animals had recovered their ability to respond to an HAGG challenge. These studies are the basis for the concept that the physiological state of tolerance of nondeleted self-reactive clones results from the establishment of low-zone, long-lasting T-cell tolerance.

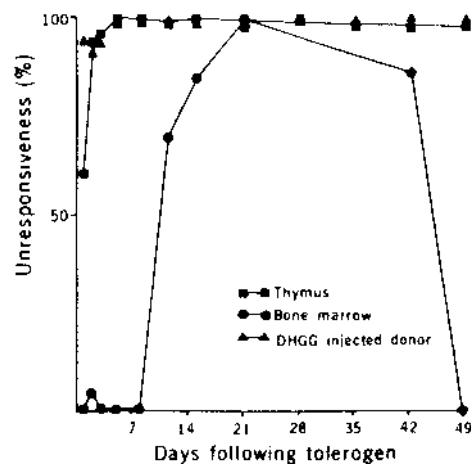

Fig. 16.1 Induction and persistence of tolerance in B- and T-cell populations. Thymus (T) and bone marrow (B) lymphocytes were removed at various times from mice rendered tolerant with 2.5 mg of aggregate-free human gamma globulin (HGG), mixed with complementary lymphocytes from normal donors, and transferred to irradiated syngeneic mice, which were subsequently challenged with 0.4 mg of aggregated HGG to test the ability of the transferred cells to cooperate in Ab formation. Results are given as percent of antibody levels obtained in controls using B and T cells obtained from untreated donors. Tolerance appeared sooner and lasted longer in T lymphocytes than in B lymphocytes. (Reproduced with permission from Chiller, J. M., Habicht, A. S., and Weigle, W. O. *Science* 171:813, 1971.)

IV. EXPERIMENTAL APPROACHES TO THE DEFINITION OF THE MECHANISMS OF LYMPHOCYTE TOLERANCE

A. Transgenic Mice

The understanding of the mechanisms involved in tolerance has received a significant boost through the use of transgenic mice. These mice are obtained by introducing a gene in the genome of a fertilized egg that is subsequently implanted in a pseudo-pregnant female in which it develops. The new gene introduced in the germline is passed on, allowing the study of the acquisition of tolerance to a defined antigen under physiological conditions. Double transgenic mice, expressing a given antigen and an antibody with predetermined specificity, have been constructed by breeding transgenic mice. The tissue expression of the transgene can be manipulated by coupling a tissue-specific promoter to the gene in question.

B. Lymphocyte Tolerance Models

The main characteristics of B-cell tolerance are summarized in Table 16.3. Experimental evidence supporting both anergy and clonal deletion as mechanisms leading to B-cell tolerance has been obtained in transgenic mouse models.

1. Models for B-Cell Anergy

A most informative model for the understanding of B-cell tolerance was obtained by breeding double transgenic mice from animals transgenic for hen egg lysozyme, which develop tolerance to this protein during development, and animals of the same strain carrying the gene coding for IgM egg lysozyme antibody. The double transgenic F1 hybrids express the gene coding for egg lysozyme in nonlymphoid cells, and B lymphocytes of these mice also express IgM anti-egg lysozyme antibody. These antibody-positive B lymphocytes are present in large numbers in the spleen. The predominance of B cells with membrane IgM specific for lysozyme is a consequence allelic exclusion: the insertion of a completely rearranged immunoglobulin transgene blocks rearrangement of the normal immunoglobulin genes.

Table 16.3 B-Cell Tolerance

B-cell anergy	Antigen is soluble Reactivation may occur Direct proof: 1. Double transgenic animals (soluble egg lysozyme and anti-egg lysozyme Ab genes): B cells synthesize egg lysozyme but do not secrete antilysozyme Ab 2. Transgenic animals (anti-DNA Ab gene on B cells): B cells do not secrete anti-DNA Ab
B-cell deletion	Antigen is surface bound Direct proof: 1. Double transgenic mice (genes coding for surface bound lysozyme and antilysozyme Ab): B cells do not produce lysozyme nor antilysozyme Ab 2. Transgenic mice with B cells with genes coding for anti-H2-K ^k antibody mated with H2-K ^k mice produce offspring that lack H2-K ^k antibody-positive B cells

The relevance of this model to the understanding of tolerance lies in the fact that the double transgenic F1 hybrids failed to produce anti-egg lysozyme antibodies after repeated immunization with egg lysozyme. Thus, these animals have B lymphocytes carrying and expressing a gene that codes for a self-reactive antibody but cannot respond to the antigen. Experiments with these cells suggest that one or several of the kinases activated during the response of a normal B cell to antigenic stimulation remain in an inactive state, interrupting the activation cascade.

2. *Reversibility of B-Cell Anergy*

By definition, a state of anergy should be reversible. Reversibility was experimentally proven by transferring lymphocytes from double transgenic F1 hybrids expressing the gene coding for anti-egg lysozyme antibody to irradiated nontransgenic recipients of the same strain. In this new environment, from which egg lysozyme was absent, the transferred B lymphocytes produced anti-egg lysozyme antibodies upon immunization. These experiments suggest that continuous exposure to the circulating self-antigen is necessary to maintain B-cell anergy.

Another approach to activate anergic cells is to separate peripheral blood B lymphocytes from an anergic animal and stimulate them *in vitro* with lipopolysaccharide, which is a polyclonal B-cell mitogen for murine cells. As a consequence of this stimulation, the signaling block that characterizes anergy is overridden, and autoreactive B cells secreting anti-lysozyme antibody can be detected.

3. *Models for B-Lymphocyte Clonal Deletion*

Evidence supporting clonal deletion in B-cell tolerance has also been recently obtained in transgenic animal models. Experiments were carried out in F1 double transgenic mice, which were raised by mating animals that expressed egg lysozyme not as a soluble protein, but as an integral membrane protein, with transgenic mice of the same strain carrying the gene for IgM anti-egg lysozyme antibody. In the resulting double transgenic F1 hybrids, B lymphocytes carrying IgM anti-egg lysozyme antibody could not be detected.

Additional experiments have proven that stimulation of an immature IgM/IgD autoreactive B-cell clone by a self antigen abundantly expressed on a cell membrane leads to clonal deletion by apoptosis. The elimination of autoreactive clones seems to take place in the lymph node germinal centers.

4. *Conclusions and Unanswered Questions*

The sum of experimental data suggests that B-cell tolerance can result both from clonal anergy and clonal deletion, and the choice of mechanism depends on whether the antigen is soluble or membrane-bound. Clonal deletion involves apoptosis of the self-reactive cells, but we do not know why only membrane-bound antigens appear to trigger apoptosis. B-cell anergy, on the other hand, is associated with a block in the transduction of the activating signal resulting from the binding of antigen to the membrane immunoglobulin, probably consequent to the lack of co-stimulatory signals usually delivered by activated T_H2 cells (see Chapters 4 and 11).

Table 16.4 T-Cell Tolerance

Clonal deletion	Ag presented in the thymus T cells die by apoptosis TcR repertoire bias Never absolute (residual autoreactive cells seem to persist)
Clonal anergy	Occurs in periphery Stimulation of T cells in the absence of proper co-stimulation leads to anergy

C. T-Lymphocyte Tolerance Models

The main characteristics of T-cell tolerance are summarized in Table 16.4. As in the case of B-cell anergy, experimental evidence supporting both anergy and clonal deletion as mechanisms leading to T-cell tolerance has been obtained in transgenic mouse models.

1. Experimental Models for T-Lymphocyte Clonal Deletion

There is solid experimental evidence supporting clonal deletion as a mechanism involved in T-cell tolerance. Of seminal importance were the experiments in which transgenic mice were transfected with the gene coding for a T-cell receptor (TcR) cloned from a MHC-I restricted CD8⁺ cytotoxic T-cell clone specific for the male HY antigen (Fig. 16.2). This TcR

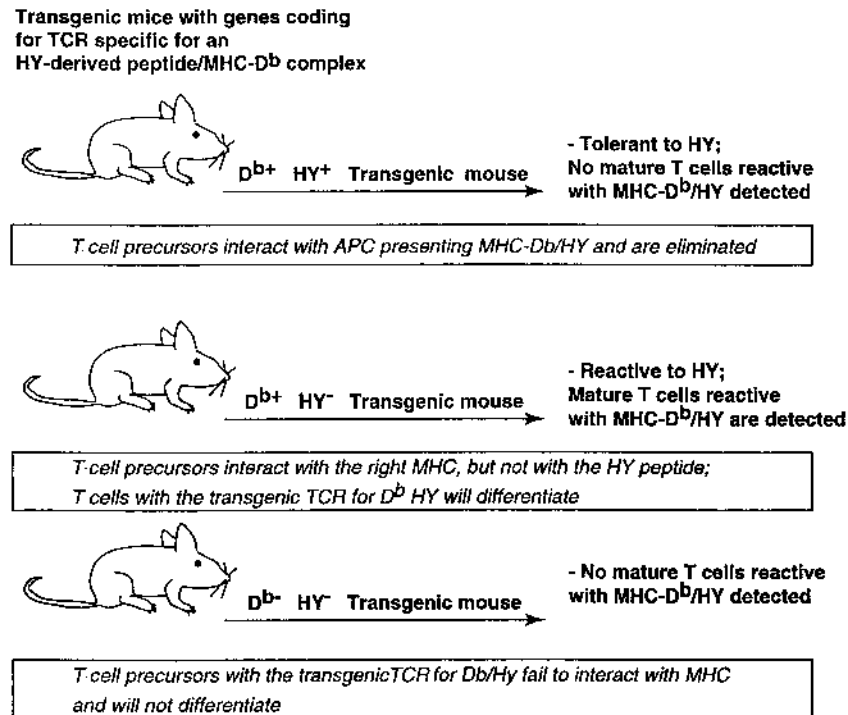

Fig. 16.2 Diagrammatic representation of an experiment in which transgenic animals expressing a TcR specific for an HY-derived peptide–MHC-D^b complex were shown to become tolerant to the HY peptide, but only in D^{b+} animals. The tolerance in this model was apparently due to clonal deletion, since no mature T cells reactive with MHC-D^b/HY were detected in the tolerant animals.

was able to mediate a cytotoxic reaction against any cell expressing the HY antigen. While female transgenic mice (HY⁻) were found to have mature CD8⁺ cells expressing the TcR specific for HY, none of the transgenic male animals (HY⁺) had detectable mature CD8⁺ cells expressing the anti-HY TcR. However, functionally harmless CD4⁺ cells with the autoreactive TcR could be detected in male animals.

These observations were interpreted as meaning that those lymphocytes expressing the autoreactive TcR and the CD8⁺ antigen interacted effectively with a cell presenting an immunogenic HY-derived peptide in association with a MHC-I molecule, and those cells were deleted. CD4⁺ lymphocytes, even if carrying the same TcR, cannot interact effectively with MHC-I-associated HY-derived peptides and were spared (see Chapter 10). Similar experiments using mice transfected with genes coding for MHC class II restricted TcRs showed that the CD4⁺ lymphocytes were selectively deleted, as expected from the fact that the reaction between a TcR and an MHC-II-associated peptide is stabilized by CD4 molecules. In other words, the role of CD4 and CD8 as stabilizers of the reaction between T lymphocytes and antigen-presenting cells is not only important for antigenic stimulation but is also critical for clonal deletion.

2. Mechanisms of T-Cell Clonal Deletion

A common aspect of all types of clonal deletion is that cell death is due to *apoptosis* (see Chapter 11) involving interaction of the Fas molecule with its ligand. However, many details concerning the control of T-cell apoptosis remain unexplained.

3. Models for T-Cell Anergy

Experimental models addressing the question of how T cells become tolerant to tissue-specific determinants that are not expressed in the thymus have provided evidence for the role of clonal anergy. Transgenic mice were constructed in which the transgene was coupled to a tissue-specific promoter that directed their expression to an extrathymic tissue. For example, heterologous MHC class II (I-E) genes were coupled to the insulin promoter prior to their injection to fertilized eggs. Consequently, the MHC class II antigens coded by the transfected genes were expressed only in the pancreatic islet β cells. Class II (I-E) specific helper T cells were detectable in the transgenic animals, but they could not be stimulated by exposure to lymphoid cells expressing the transfected MHC-II genes. Thus, tolerance to a peripherally expressed MHC-II self antigen can be due to clonal anergy.

4. Mechanisms of T-Cell Anergy

Proper stimulation of mature CD4⁺ T lymphocytes requires at least two signals: one delivered by the interaction of the TcR with the MHC-II-Ag complex, while the other signal(s) is (are) delivered by the accessory cell. Both signals require cell-cell contact involving a variety of surface molecules and the release of soluble cytokines (see Chapters 4 and 11). When all these signals are properly transmitted to the T lymphocyte, a state of activation ensues. Several experiments suggest that the state of anergy develops when TcR-mediated signaling is not followed by co-stimulatory signals. For example, a state of anergy is induced when T lymphocytes are stimulated with chemically fixed accessory cells (which cannot release cytokines or upregulate membrane molecules involved in the delivery of co-stimulatory signals) or with purified MHC-II-antigen complexes (which also cannot provide co-stimulatory signals).

From the multitude of co-stimulatory pairs of molecules that have been described, the CD28/CTLA4-B7 family is the most significant in the physiology of T-cell anergy. CD28-mediated signals are necessary to induce the production of IL-2, which seems to be critical for the initial proliferation of T_H0 cells and eventual differentiation of T_H1 cells. CD28 engagement also results in a lower threshold for effective TCR activation and therefore may enhance the lower avidity interactions between TCR and autoantigens. If the interaction between CD28 and its ligand is prevented at the onset of the immune response, anergy and tolerance ensue. Also, if CD80/86 molecules interact with CTLA4 rather than CD28, a downregulating signal is delivered to the T lymphocyte (see Chapter 11). In contrast to the interactions involving CD28, those that involve CTLA4 may increase the threshold of T-cell activation and inhibit T-cell responses to low-affinity autoantigens.

The molecular basis for T-cell anergy is emerging. On one hand there seems to be an inhibition of the MAP kinase pathway, resulting in decreased Jun and Fos induction or activation and, consequently, to a decreased expression of the genes regulated by NF-AT1 that include the IL-2 gene and many other cytokine genes. On the other hand, there is evidence suggesting that anergy is associated with the expression of cAMP-regulating elements that have a direct suppressive effect on the transcription of the IL-2 gene.

It is possible that a parallel could be defined for B-cell anergy. The CD40 (B cells)–CD40 ligand (T cells) interaction is critically important for B-cell differentiation. In the absence of CD40 signaling, B cells are easy to tolerize. The differences between high-zone versus low-zone tolerance may be a result of differences in the degree of co-stimulation received by T cells. In high-zone tolerance, the co-stimulatory signals are excessively strong and both T cells and B cells are downregulated. Very low antigen doses fail to induce the delivery of co-stimulatory signals to T cells, and low-zone T-cell tolerance ensues.

5. Conclusions

Clonal deletion seems extremely efficient during embryonic differentiation, but a large number of potentially autoreactive clones seem to escape deletion. Whether those autoreactive clones remain anergic or are activated may just depend on whether the autoantigens against which they are directed are ever presented in a context able to induce an active immune response, i.e., by activated APC able to deliver co-stimulatory signals to the autoreactive T and/or B cells. Under normal physiological conditions, the recognition of autoantigens is more likely to take place in the absence of co-stimulatory signals by helper T cells, conditions that are likely to contribute to the perpetuation of a state of T-cell anergy. The perpetuation of the anergic state by incomplete signaling of autoreactive clones is believed to be significant in the maintenance of tolerance in adult life.

V. DOWNREGULATION OF THE IMMUNE RESPONSE

Many different mechanisms are involved in the downregulation of the immune response. Extreme situations of downregulation may very well be indistinguishable from tolerance. This similarity between activation of suppressor circuits and clonal anergy is made more obvious by the fact that the experimental protocols used to induce one or the other are virtually identical. However, there are defined mechanisms that result in the downregulation of the immune response through the activation of a variety of immunoregulatory cells that, under the right circumstances, downregulate the immune response. Both monocytes and T

lymphocytes appear able to have downregulatory properties. Monocyte-mediated suppression is usually due to the release of PGE₂ and is nonspecific. The situation with lymphocytes is more complex, involving more than one type of cell.

A. Suppressor T Cells

For a couple of decades there was intense research on a CD8⁺ suppressor T-cell subpopulation. In mice, those cells mediated antigen-specific suppression via suppressor factors that may simply represent released TcR molecules. However, attempts to isolate and sequence suppressor factors or to clone their genes have met with failure. It has also been impossible to clone T-suppressor cells, so their existence as a defined subpopulation has not been confirmed.

In humans there is some evidence suggesting that immunoregulatory CD8⁺ lymphocytes, after antigen-specific stimulation, may exert their effect by releasing nonspecific suppressor factors such as TGF-β and interleukin-10. Since the trigger for the release of these factors would be the specific recognition of an antigen, and the effects of soluble factors must be limited to cells in the immediate vicinity of the stimulated cell, the suppression would predominantly affect helper T cells recognizing the same antigen in association with an MHC-II molecule.

B. Mucosal Tolerance

Recent reports of therapeutic benefit of oral administration of collagen to patients with rheumatoid arthritis raised considerable interest in the concept of oral tolerance. This phenomenon had been first observed by H. G. Wells in 1911, when he demonstrated that guinea pigs sensitized to hen albumin (ovalbumin) would develop systemic anaphylaxis after reexposure to the antigen unless they were previously given the antigen with their food. The recent investigations have demonstrated that tolerance can also be induced by administration of antigen (such as ovalbumin) by inhalation.

The sum of experimental data collected so far suggests that the administration of large doses of oral antigen causes T_H1 anergy-driven tolerance. However, this seems to be a rather exceptional mechanism, with little clinical application. In contrast, the administration of low doses of antigen is believed to stimulate T_H2 responses and cause bystander suppression of autoreactive T_H1 cells. A proposed framework for this type of suppression is as follows:

1. The ingested antigen (usually a protein) is transported to submucosal accessory cells in the Peyer's patches, where it is processed and presented to regulatory T cells (both CD4⁺ and CD8⁺ phenotypes, including special subpopulations of γδ CD4⁺ and CD8⁺ T cells), which after proliferation and differentiation become functionally suppressor. The suppressor effect is mediated by secretion of TGF-β, IL-10, and IL-4 after reexposure to the tolerizing antigen.
2. When antigen is introduced in small doses as a nasal aerosol, the main effect seems to be the stimulation of immunoregulatory γδ CD8⁺ cells that cause a shift from a predominant and pathogenic T_H1 response to a less harmful T_H2 response.
3. The activated regulatory T cells enter the circulation and are attracted to areas of ongoing reactivity. In the peripheral lymphoid tissues they may downregulate

immune responses to the tolerizing antigen. In tissues where effector cells are causing inflammatory changes, the recruitment of activated regulatory T cells releasing TGF- β and IL-10 may suppress the activity of T_H1 assisting the local immune response process, resulting in a downregulation of the inflammatory response.

The antigen used to induce oral tolerance does not need to be identical to that recognized by the autoreactive T cells *in vivo*, since the suppressor effects of IL-10 and TGF- β are nonspecific and can affect T cells reacting with other antigens (bystander suppression). However, the best results with oral tolerization protocols are obtained when antigens structurally related to the autoantigens are given orally. Thus, cross-reactivity between the two antigens may be important in localizing the activated suppressor CD8⁺ cells to the right tissue.

C. Anti-idiotypic Immune Responses

The role of anti-idiotypic circuits in the downregulation of T and B cells has been the object of considerable interest and is discussed in Chapters 12 and 17.

VI. TERMINATION OF TOLERANCE

If tolerance depends on the maintenance of a state of anergy, there are several possible scenarios that could explain the termination of tolerance.

A. Clonal Regeneration

Because new B lymphocytes are constantly produced from stem cells, if a tolerogenic dose of antigen is not maintained, the immune system will eventually replace aging tolerant cells by young, nontolerant cells and recover the ability to mount an immune response.

B. Cross-Immunization

Exposure to an antigen that cross-reacts with a tolerogen may induce the activation of T-helper lymphocytes specific for the cross-reacting antigen. As a consequence, the activated T_H cells will provide autoreactive B lymphocytes with the necessary co-stimulatory signals necessary to initiate a response against the tolerogen.

C. Co-stimulation of Anergic Clones

It was discussed above that anergy may be the result of incomplete stimulation of T lymphocytes. Thus, it can be postulated that proper stimulation of T lymphocytes may reestablish the co-stimulatory pathways, terminate anergy, and initiate the autoreactive process. Experimental evidence supporting this concept was obtained in studies of transgenic mice expressing a lymphocytic choriomeningitis viral glycoprotein on the pancreatic cells. These transgenic mice have T lymphocytes that recognize the glycoprotein but remain anergic. However, the state of anergy in these transgenic mice can be terminated by an infection with the lymphocytic choriomeningitis virus. The infection stimulates the

immune system, terminates the state of peripheral T-cell unresponsiveness, and the previously tolerant animals develop inflammatory changes in the Langerhans islets (insulinitis) caused by lymphocytes reacting with the viral antigen expressed on the pancreatic cells. Those changes precede the development of diabetes. This model supports the concept of tolerance resulting from the lack of co-stimulatory signals and also supports the role of infections, by generating a microenvironment favorable to the induction of an active immune response, as an initiating factor indirectly responsible for the activation of autoreactive clones.

A special type of infection that may be involved in termination of tolerance involves superantigen-producing bacteria. These superantigens react with most MHC-II molecules and with the TcR of specific variable-region families. Those TcR families are expressed by as much as one third of the total T-cell population. The cross-linking of TcRs on large numbers of T lymphocytes in close apposition with activated antigen-presenting cells delivers strong activating signals to T lymphocytes. The consequence is that previously anergic self-reactive T cells will be activated (as evidenced by the active expression of the IL-2 receptor gene) and a previously downregulated autoimmune response becomes active.

VII. AUTOIMMUNITY

A. Introduction

Failure of the immune system to “tolerate” self antigens may result in the development of pathological processes known as *autoimmune diseases*. At the clinical level, autoimmunity is apparently involved in a variety of apparently unrelated diseases such as systemic lupus erythematosus (SLE), insulin-dependent diabetes mellitus, myasthenia gravis, rheumatoid arthritis, multiple sclerosis, and hemolytic anemia. At least 40 diseases are known or considered to be autoimmune in nature, affecting about 5% of the general population. Their distribution by sex and age is not uniform. As a rule, autoimmune diseases predominate in females and have a bimodal age distribution. A first peak of incidence is around puberty, whereas the second peak is in the forties and fifties.

B. Classification of the Autoimmune Diseases

There are several different ways to classify autoimmune diseases. Because several autoimmune diseases are strongly linked with MHC antigens, one of the most recently proposed classifications, shown in Table 16.5, groups autoimmune diseases according to their association with class I or with class II MHC markers. It is interesting to notice that although

Table 16.5 Classification of Autoimmune Diseases

I. MHC class II-associated
A. Organ-specific (autoantibody directed against a single organ or closely related organs)
B. Systemic (systemic lupus erythematosus—variety of autoantibodies to DNA, cytoplasmic antigens, etc.)
II. MHC class I-associated
A. HLA-B27-related spondyloarthropathies (ankylosing spondylitis, Reiter’s syndrome, etc.)
B. Psoriasis vulgaris (associated with HLA-B13, B16, and B17)

autoimmune diseases may afflict both men and women, there is female preponderance for the class II-associated diseases and a definite increase in the prevalence of class I-associated diseases among males.

C. Pathophysiology of Autoimmune Diseases

The autoimmune pathological process may be initiated and/or perpetuated by autoantibodies, immune complexes containing autoantigens, and autoreactive T lymphocytes. Each of these immune processes plays a preponderant role in certain diseases or may be synergistically associated, particularly in multiorgan, systemic autoimmune diseases.

1. *The Role of Autoantibodies in Autoimmune Diseases*

B lymphocytes with autoreactive specificities remain nondeleted in the adult individuals of many species. In mice, polyclonal activation with lipopolysaccharide leads to production of autoantibodies. In humans, bacterial and viral infections (particularly chronic) may lead to the production of anti-immunoglobulin and antinuclear antibodies. In general, it is accepted that polyclonal B-cell activation may be associated with the activation of autoreactive B lymphocytes.

Autoantibody-associated diseases are characterized by the presence of autoantibodies in the individual's serum and by the deposition of autoantibodies in tissues. The pathogenic role of autoantibodies is not always obvious and depends on several factors, such as the availability and valence of the auto-antigen and the affinity and charge of the antibody.

Antibodies with high affinity for the antigen are considered to be more pathogenic because they form stable IC that can activate complement more effectively.

Anti-DNA antibodies of high isoelectric point, very prevalent in SLE, have a weak positive charge at physiological pH and bind to the negatively charged glomerular basement membrane, which also binds DNA. Such affinity of antigens and antibodies for the glomerular basement membrane creates the ideal conditions for in situ IC formation and deposition, which is usually followed by glomerular inflammation.

Autoantibodies may be directly involved in the pathogenesis of some diseases, while in others may serve simply as disease markers without a known pathogenic role. For example, the anti-Sm antibodies found exclusively in patients with SLE are not known to play a pathogenic role. However, in many other situations autoantibodies can trigger various pathogenic mechanisms leading to cell or tissue destruction (Table 16.6).

Complement-fixing antibodies (IgG and IgM) to red cells may cause intravascular red cell lysis if the complement activation sequence proceeds all the way to the formation of the membrane attack complex or may induce phagocytosis and extravascular lysis if the sequence is stopped at the C3 level, due to the accumulation of C3b fragments on the red cell membrane.

If the antigen-antibody reaction takes place in tissues, pro-inflammatory complement fragments (C3a, C5a) are generated and attract granulocytes and mononuclear cells, which can release proteolytic enzymes and toxic radicals in the area of IC deposition, causing tissue damage.

Other autoantibodies may have a pathogenic role dependent not on causing cell or tissue damage, but on interference with cell functions resulting from their binding to physiologically important cell receptors.

Table 16.6 Pathogenic Mechanisms Triggered by Autoantibodies

Mechanism	Disease	Comments
C'-mediated cell lysis	Autoimmune cytopenias	C'-activating immunoglobulin binds to cell membrane antigen; C' is activated; membrane attack complex is formed; cell is lysed
Tissue destruction by inflammatory cells	SLE	Anti-nuclear antibodies bind to tissue-fixed antigens; C' is activated; C3a and C5a are produced; PMNs are attracted; inflammation develops
Blockage of receptor	Insulin-resistant diabetes mellitus (acanthosis nigricans)	Insulin receptor antibodies bind to insulin receptor and compete with insulin
Charge-facilitated	Lupus nephritis	Cationic anti-DNA tissue deposition; antibodies bind to glomerular basement membrane
Activation of C'	Membranoproliferative glomerulonephritis	C3bBb antibodies (nephritic factors) bind to and stabilize the C3 convertase (C3bBb), which cleaves C3
Phagocytosis and intracellular lysis	Autoimmune cytopenias	Antibody binds to cell; may or may not activate C'; cell-antibody-(C3b, C3d) complexes are phagocytosed by Fc receptor and/or complement receptor-bearing cells

Representative human autoimmune diseases in which auto-antibodies are believed to play a major pathogenic role are listed in Table 16.7. It must be noted in some of these diseases there is also a cell-mediated immunity component. For example, in myasthenia gravis, autoreactive T lymphocytes have been described, and both autoreactive cell lines and clones have been successfully established from patient's lymphocytes. These T lymphocytes may provide help to autoreactive B lymphocytes producing anti-acetylcholine receptor antibodies. In such cases, autoreactive T lymphocytes could be more central in the pathogenesis of the disease than auto-antibody producing B lymphocytes. However, the pathogenic role of autoantibodies is evident from the fact that newborns to mothers with myasthenia gravis develop myasthenia-like symptoms for as long as they have maternal autoantibodies in circulation.

Table 16.7 Antibody-Mediated Autoimmune Diseases

Disease	Antigen
Autoimmune cytopenias (anemia, thrombocytopenia, neutropenia)	Erythrocyte, platelet, or neutrophil cell surface determinant
Goodpasture's syndrome	Type IV collagen
Pemphigus vulgaris	Cadherin on epidermal keratinocytes
Myasthenia gravis	Acetylcholine receptor
Hyperthyroidism	Thyroid-stimulating hormone receptor (Graves disease)
Insulin-resistant diabetes (acanthosis nigricans)	Insulin receptor
Pernicious anemia	Intrinsic factor, parietal cells

2. *The Pathogenic Role of Immune Complexes in Autoimmune Diseases*

In autoimmune diseases, there is ample opportunity for the formation of immune complexes (IC) involving autoantibodies and self antigens. Several factors determine the pathogenicity of IC, as discussed in greater detail in Chapter 23. They include the size of the IC (intermediate-size IC are the most pathogenic), the ability of the host to clear IC (individuals with low complement levels or deficient Fc receptor and/or complement receptor function have delayed IC clearance rates and are prone to develop autoimmune diseases), and physicochemical properties of IC (which determine the ability to activate complement and/or the deposition in specific tissues). In many occasions, IC are formed in situ, activate the complement system, complement split products are formed, and neutrophils are attracted to the area of IC deposition where they will mediate the IC-mediated tissue destruction.

SLE and polyarteritis nodosa are two classical examples of autoimmune diseases in which IC play a major pathogenic role. In SLE, DNA and other nuclear antigens are predominantly involved in the formation of IC, while in polyarteritis nodosa, the most frequently identified antigen is hepatitis B surface antigen.

3. *The Role of Activated T Lymphocytes in the Pathogenesis of Autoimmune*

Typical T-cell-mediated autoimmune diseases are summarized in Table 16.8. T lymphocytes that are involved in the pathogenesis of such autoimmune diseases may:

- Be autoreactive and recognize self antigens
- Recognize foreign antigen associated with self determinants (modified self)
- Respond to foreign antigens but still induce self tissue destruction.

Cytotoxic CD8⁺ lymphocytes play a pathogenic role in some autoimmune diseases, usually involving the recognition of nonself peptides expressed in the context of self MHC and destroying the cell expressing such “modified” self. For example, coxsackie B virus-defined antigens expressed on the surface of myocardial cells may induce CD8⁺-mediated tissue destruction, causing a virus-induced autoimmune myocarditis.

Activated CD4⁺ helper cells appear to be frequently involved in cell-mediated autoimmune reactions. Their pathogenic effects are mediated by the release of cytokines (IFN- γ , IL-1, L-2, IL-4, etc.), which can either trigger inflammatory reactions (if T_H1 cells are predominantly involved) or activate autoantibody-producing B lymphocytes (if T_H2 cells are predominantly involved). As a rule, T_H1 cells appear to play a dominant role in many organ-specific autoimmune diseases, and T_H2 cells are predominantly involved in systemic autoimmune diseases, such as SLE or rheumatoid arthritis.

Table 16.8 Examples of T-Cell-Mediated Autoimmune Diseases

Disease	Specificity of T-cell clone/line ^a	T cell involved
Experimental allergic encephalomyelitis	Myelin basic protein	CD4 ⁺
Autoimmune thyroiditis	Thyroid follicular epithelial cells	?
Insulin-dependent diabetes mellitus	Pancreatic islet beta cells	CD8 ⁺ (CD4 ⁺)
Viral myocarditis	Coxsackie B virus	CD8 ⁺

^a Derived from cells isolated from tissue lesions or peripheral blood of patients and animals affected by the experimental disease. Some of these T-cell lines have been used for adoptive transfer of the disease. In experimental animals, treatment with anti-T-cell antibodies may improve the clinical manifestations of the disease.

D. Pathogenic Factors Involved in the Onset of Autoimmune Diseases

Multiple factors have been proposed as participating in the pathogenesis of autoimmune diseases. These factors can be classified as immunological, genetic, environmental, and hormonal. Each group of factors is believed to contribute in different ways to the pathogenesis of different diseases.

1. *Abnormal Immunoregulation*

Multiple lymphocyte abnormalities have been described in patients with autoimmune diseases. Prominent among them are B-lymphocyte overactivity, presence of spontaneously activated T and B lymphocytes, and decreased suppressor T-cell function. These abnormalities are typified in SLE and will be discussed in Chapter 18.

2. *Anti-idiotypic Antibodies*

These antibodies may play an important role in autoimmunity. For example, during a normal immune response to a virus, an immune response directed against the viral structures mediating attachment to its target cell is likely to be triggered. As the immune response evolves, anti-idiotypic antibodies reacting with the antigen-binding site of the antiviral antibodies may develop. These anti-idiotypes, by recognizing the “internal image of the antigen” (which is the configuration of the binding site of the first antibody), may be able to combine with the virus receptor protein in the cell. If the membrane protein used as binding site by the virus happens to be a receptor with important physiological functions, the synthesis of anti-idiotypic antibodies may have adverse effects by either activating or blocking the physiological activation of these functions.

Such a mechanism could explain the origin of antibodies against the acetylcholine and the TSH receptors detected in myasthenia gravis and Grave’s disease, respectively. A hypothetical viral infection would trigger the synthesis of anti-idiotypic antibodies cross-reacting with the acetylcholine receptor at the neuromuscular junction or with the TSH receptor on thyroid cells; these antibodies could interfere with normal function, cause cell death, or induce cell stimulation depending upon their isotype and the receptor epitopes to which they bind.

3. *Genetic Factors*

Clinical observations have documented increased frequency of autoimmune diseases in families and increased rates of clinical concordance in monozygotic twins. Several studies have also documented associations between HLA antigens and various diseases (see Chapter 3). As stated earlier in this chapter, autoimmune diseases can be classified in two groups: one apparently associated with MHC-I genetic markers, and the other associated with MHC-II genetic markers.

The classical example of linkage with MHC-I markers is the association between HLA-B27 and inflammatory spondyloarthropathies (ankylosing spondylitis, Reiter’s syndrome, etc.). The pathogenic relevance of HLA-B27 is strongly supported by experiments with transgenic mice carrying the gene for HLA-B27. Those transgenic animals spontaneously develop inflammatory disease involving the gastrointestinal tract, peripheral and vertebral joints, skin, nails, and heart. The disease induced in transgenic mice resembles strikingly the B27-associated disorders that afflict humans with that gene. It has been postulated that the autoimmune reaction is triggered by an infectious peptide presented by

HLA-B27 and followed by cross-reactive lymphocyte activation by an endogenous collagen-derived peptide, equally associated with HLA-B27.

The linkage of autoimmunity with MHC-II markers is better understood. With the expanded definition of MHC-II alleles due to the development of antisera and DNA probes and because of the successful sequencing of the genes coding for the constitutive polypeptide chains of MHC-II molecules, the significance of MHC-II alleles has become clear. For example, insulin-dependent diabetes mellitus (IDDM) is strongly associated with serologically defined MHC-II markers (HLA-DR3 and HLA-DR4) but is even more strongly correlated with the presence of uncharged amino acids at position 57 of the β chain of DQ (DQB) (see Chapter 18). Those MHC-II molecules may be critically involved in the presentation of diabetogenic peptides to the immune system.

The exact mechanisms responsible for the association between HLA alleles and disease susceptibility are being actively investigated. Two have been hypothesized, based on the persistence and later activation of autoreactive clones:

1. Molecular mimicry, i.e., cross-reactivity between peptides derived from infectious agents and peptides derived from autologous proteins which are expressed by most normal resting cells in the organism. Anergic autoreactive T-cell clones would be activated by an immune response against an infectious agent due to this type of cross-reactivity.
2. Lack of expression of MHC alleles able to bind critical endogenous peptides. Under these circumstances potentially autoreactive T-lymphocyte clones would not be eliminated and would remain available for later activation due to an unrelated immune response or by the presentation of a cross-reactive peptide.

Another important genetic determinant of autoreactivity is the TcR repertoire of a given individual. Several autoimmune diseases show associations with specific TcR variable-region types. This is not surprising because the specific recognition of different oligopeptides by different T lymphocytes depends on the diversity of the TcR (see Chapters 10 and 11). Therefore, the development of an autoimmune response should require that the genome of an individual includes genes encoding a particular array of V region genes whose transcription resulted in the expression of TcR able to combine with a specific autologous peptide. In addition, the clones expressing such receptors must not be deleted during embryonic differentiation.

These postulates are supported by immunogenetic studies in different animals and humans with different manifestations of autoimmunity. Those studies suggest that linkages between specific TcR V-region genes and specific autoimmune diseases may actually exist (e.g., IDDM, multiple sclerosis, and SLE). Experimental corollaries of the postulated positive association between specific TcR V-region genes and disease are found in experimental allergic encephalomyelitis and murine collagen-induced arthritis. The lymphocytes obtained from arthritic joints of mice susceptible to collagen-induced arthritis have a very limited repertoire of V β genes. In mouse strains that do not develop collagen-induced arthritis there are extensive deletion of V β genes, including those preferentially expressed by susceptible mice.

Even in identical twins, however, concordance for a particular autoimmune disease never exceeds 40%, suggesting that the presence of autoimmunity-associated TcR V-region genes is not sufficient to cause disease by itself. Indeed, with certain exceptions, human autoimmune diseases are multigenic and the number of the involved genes has not been determined. Recent studies have undertaken genome-wide searches to locate loci and

genes that are involved in humans with systemic autoimmune diseases and the corresponding animal models. The studies use microsatellite markers and patients from families with multiple afflicted members. Progress has been made, but definitive results are not yet available.

In mice that develop a disease resembling SLE at least 31 different genes contributing to the development of the disease have been identified so far. Study of congenic mice has shed some light into how different loci contribute, through positive and negative epistatic interactions, to loss of tolerance to autoantigens and the progressive establishment of a lupus-like disease. The number of genes involved in human lupus must be significantly higher. A similarly high number of loci have been proposed for diabetes and arthritis in humans and laboratory animals.

4. Environmental Factors

The most important environmental factors are believed to be foreign antigens sharing structural similarity with self-determinants. Exposure to these epitopes can trigger autoimmune reactions. The term *molecular mimicry* is used to describe identity or similarity of either amino acid sequences or structural epitopes between foreign and self antigens.

One of the best known examples of autoimmunity resulting from the exposure to cross-reactive antigens is the cardiomyopathy that complicates many cases of acute rheumatic fever. Group A β -hemolytic streptococci have several epitopes cross-reactive with tissue antigens. One of them cross-reacts with an antigen found in cardiac myosin. The normal immune response to such a cross-reactive strain of *Streptococcus* will generate lymphocyte clones that will react with myosin and induce myocardial damage long after the infection has been eliminated.

Several other examples of molecular mimicry have been described, as summarized in Table 16.9, and additional ones await better definition. For example, molecular mimicry between the envelope glycolipids of gram-negative bacteria and the myelin of the peripheral nerves may explain the association of the Gullain-Barré syndrome with *Campylobac-*

Table 16.9 Human Proteins with Structural Homology to Human Pathogens

Disease	Human protein	Pathogen
Ankylosing spondylitis, Reiter's syndrome	HLA-B27	<i>Klebsiella pneumoniae</i>
Rheumatoid arthritis	HLA-DR4	Epstein-Barr virus
IDDM	Insulin receptor	Papillomavirus
	HLA-DR	Cytomegalovirus
	Glutamate decarboxylase	Coxsackievirus P2-C enzyme
Myasthenia gravis	Acetylcholine receptor	Poliovirus
Ro-associated clinical syndromes	Ro/SSA antigen	Vesicular stomatitis virus
Rheumatic heart disease	Cardiac myosin	Group A streptococci
Celiac disease	A-gliadin or wheat gluten	Adenovirus type 12
Acute proliferative glomerulonephritis	Vimentin	<i>Streptococcus pyogenes</i> type 1
Lyme disease (rheumatic manifestations)	LFA-1	<i>B. burgdoferi</i> outer surface protein-A

ter jejuni infections. Mimicry between LFA-1 and the *Borrelia burgdorferi* outer surface protein A is considered responsible for the rheumatic manifestations of Lyme's disease. Mimicry between glutamate decarboxylase, an enzyme concentrated in pancreatic β cells, and coxsackievirus P2-C, an enzyme involved in the replication of coxsackievirus B, has been considered responsible for the development of insulin-dependent diabetes in humans and in murine models of this disease.

Infectious agents, particularly viruses, can precipitate autoimmunity by inducing the release of sequestered antigens. In autoimmune myocarditis, associated with coxsackie B3 virus, the apparent role of the virus is to cause the release of normally sequestered intracellular antigens as a consequence of virus-induced myocardial cell necrosis. Autoantibodies and T lymphocytes reactive with sarcolemma and myofibril antigens or peptides derived from these antigens emerge, and the autoreactive T lymphocytes are believed to be responsible for the development of persistent myocarditis.

On the other hand, latent viral infections are believed to be responsible for the development of many autoimmune disorders. Latent infection is commonly associated with integration of the viral genome into the host chromosomes, and while integrated viruses very seldom enter a full replicative cycle and do not cause cytotoxicity, they can interfere, directly or indirectly, with several functions of the infected cells. For example, viral proteins may interfere with the function of proteins involved in the control of cell death and survival, such as p53 and bcl-2. In addition, viral proteins may mimic chemokine receptors or ligands and therefore mislead the function of immune cells. T-cell activation secondary to an in apparent viral infection has the potential to induce autoimmunity secondary to the release of interferon- γ and TNF, both known to be potent inducers of MHC-II antigen expression. The increased expression of class II MHC antigens would then create optimal conditions for the onset of an autoimmune response directed against MHC-II-self peptide complexes. Such a mechanism has been proposed to explain the onset of autoimmune thyroiditis. An unknown nonlytic virus would cause T-lymphocyte activation in the thyroid gland, followed by increased expression of MHC-II and thyroid-derived peptides, and finally, an antithyroid immune reaction would develop.

Finally, physical trauma can also lead to immune responses to sequestered antigens. The classical example is sympathetic ophthalmia, an inflammatory process of apparent autoimmune etiology affecting the normal eye after a penetrating injury of the other. This process may not be limited to trauma; tissue injury induced by any cause may result in the generation of autoreactive T cells that recognize previously cryptic epitopes. Over time, this process will lead to expansion of the immune response by facilitating the onset of immune responses to additional epitopes. This process is known as "epitope spreading."

5. Central Issues in Molecular Mimicry

There are still difficulties in proving that infections are the cause of autoimmune diseases. The infection may have resolved long before the appearance of disease or the infection may be in apparent, thus obscuring the temporal association between infection and autoimmunity. Alternatively, molecular mimicry may be the result rather than the cause of autoimmunity. The infectious process may result in the alteration of nonimmunogenic antigenic determinants as a consequence of tissue injury. The autoantibodies that appear when the disease is diagnosed may then be the result of tissue injury rather than the cause of it.

E. Animal Models of Autoimmunity

Our understanding of autoimmune disease has been facilitated by studies in animal models. Several animal models have been developed, each sharing some characteristics of a human disease of autoimmune etiology. These animal models often provide the only experimental approaches to the study of the pathogenesis of autoimmune diseases.

In some experimental models, injecting normal animals with antigens extracted from the human target tissues induces autoimmune diseases. A rapid onset and an acute course characterize the resulting diseases. These models have been particularly useful in the study of autoimmune thyroiditis and arthritis (collagen-induced arthritis). Most useful for the study of autoimmunity are animals that develop autoimmune disease spontaneously, whose course is protracted and parallels closely the disease as seen in humans. Representative animal models of different autoimmune diseases are listed in Table 16.10.

1. Experimental Allergic Encephalomyelitis

Experimental allergic encephalomyelitis (EAE) in mice and rats is the best characterized experimental model of organ-specific autoimmune disease. Immunizing animals with myelin basic protein and adjuvant induces the disease. One to 2 weeks later, the animals develop encephalomyelitis characterized by perivascular mononuclear cell infiltrates and demyelination. The mononuclear cell infiltrates show a predominance of CD4⁺ helper T lymphocytes, which upon activation release cytokines that attract phagocytic cells to the area of immunological reaction; those cells are, in turn, activated and release enzymes responsible for the demyelination. CD4⁺ T-lymphocyte clones from animals with EAE disease can transfer the disease to normal animals of the same strain. Genetic manipulations leading to deletion of the genes coding for two specific variable regions of the TcR β chain (V β 8 and V β 13) prevent the expression of disease. These two V β regions must obviously be involved in the recognition of a dominant epitope of human myelin.

Table 16.10 Representative Autoimmune Disease Models and Their Human Analogs

	Animal model	Human disease analog
A. Antigen-induced		
Myelin basic protein	Experimental allergic encephalomyelitis	Multiple sclerosis
Collagen type II	Collagen-induced arthritis	Rheumatoid arthritis
B. Induced by injecting mycobacterial extract	Adjuvant arthritis	Rheumatoid arthritis
C. Chemically induced		
HgCl ₂	Nephritis in rats	Nephritis
D. Spontaneous models		
NZB. (NZB \times NZW)F ₁	Murine lupus	SLE
MRL 1pr/1pr		
BXS murine strains		
Non-obese diabetic mice and rats	Diabetes	IDDM
Inbred BB rats		
E. Transgenic animals		
HLA-B27 transgenic rats	Spondyloarthropathy	Inflammatory spondyloarthropathies

2. Diabetes

Diabetes develops spontaneously in inbred BB rats, as well as in nonobese diabetic (NOD) mice. In both strains the onset of the disease is characterized by T-cell-mediated insulinitis, which evolves into diabetes. This disease demonstrates H-2 linkage remarkably similar to that observed between human IDDM and HLA-DR3, DR4, and other MHC-II alleles. In NOD mice, a decreased expression of MHC-I genes, secondary to a TAP-1 gene deficiency, has been recently characterized. Such a deficiency would prevent these animals from deleting autoreactive clones during T-cell differentiation.

3. Systemic Lupus Erythematosus

A number of murine strains spontaneously develop autoimmune disease that resembles human SLE:

(NZB × NZW)_{F1} female mice develop glomerulonephritis, hemolytic anemia, and anti-DNA antibodies. Numerous alterations in T- and B-lymphocyte function, cytokine release, and macrophage functions have been described in these animals.

MRL-Ipr/Ipr mice, which lack Fas antigen, and *gld* mice, which lack Fas ligand, produce autoantibodies and develop arthritis and kidney disease, but they also develop massive lymphadenopathy, which is not seen in human disease.

BXSB mice develop anti-DNA antibodies, nephritis, and vasculitis. In this strain, in contrast to the others, disease susceptibility is linked to the Y chromosome.

VIII. TREATMENT OF AUTOIMMUNE DISEASES

Standard therapeutic approaches to autoimmune disease usually involve symptomatic palliation with anti-inflammatory drugs and attempts to downregulate the immune response. Glucocorticoids, which have both anti-inflammatory and immunosuppressive effects, have been widely used, as have immunosuppressive and cytotoxic drugs. However, the use of these drugs is often associated with severe side effects and is not always efficient. Other therapeutic approaches that have been tried have had as their objective inducing tolerance or at least downregulating the autoimmune response.

Induction of tolerance to the responsible antigen is the most logical approach to the treatment of autoimmune disorders. This approach is hampered by the fact that the identity of the antigen is not known with certainty in many diseases. However, this may not be an insurmountable obstacle, due to the phenomenon recently described as “bystander tolerance.” When a cross-reactive antigen is used to induce oral tolerance, immunoregulatory cells secreting IL-10 and TGF- β differentiate in the submucosa and migrate to lymphoid organs and inflamed site, where they suppress the activity of pro-inflammatory T_H1 cells. The effects of regulatory cells are not antigen-specific, so they may extend to autoreactive T cells interacting with a peptide different from those generated by the orally-administered tolerogen. Examples of the beneficial effects of oral tolerization have been described, both in animal models and humans. In experimental animals, oral administration of basic myelin protein has been shown to decrease the severity of experimental allergic encephalitis. In patients with rheumatoid arthritis oral administration of collagen type II was followed by clinical improvement.

Table 16.11 Summary of Interventions Aimed at Disrupting Co-stimulation of T Cells in Animal Models of AutoImmune diseases

Model	Anti-CD80 Ab	Anti-CD86	CTLA4-Ig
SLE-like disease in (NZB × NZW)F ₁ mice			Benefit
Insulin-dependent diabetes in NOD mice	Worsening	Prevention	
Experimental allergic encephalomyelitis	Benefit (↑ T _H 2)	Worsening	

B-cell tolerization has been successfully tried in patients with SLE. Administration of a construct of four short DNA fragments conjugated to a dextran backbone caused cessation of DNA antibody synthesis. Apparently, the construct bound to B-cell surface immunoglobulins in DNA-specific B cells and caused its internalization. The reason why this causes the interruption of antibody synthesis has not been clarified.

The knowledge that co-stimulatory signals are essential for T-cell activation has led to attempts to induce anergy by disrupting co-stimulatory interactions, with variable but promising results in animal models (see Table 16.11). Some interesting results have been obtained in mice that develop SLE-like disease:

Administration of anti-CD40L monoclonal antibodies to asymptomatic (NZB × NZW) F₁ female mice delays the onset of nephritis. This approach seems to tolerate B cells, which otherwise would be involved in the synthesis of DNA autoantibodies, and is believed to play a critical role in the development of glomerulonephritis in SLE (see Chapter 18).

Administration of anti-CD40 monoclonal antibodies can induce the reversion of established nephritis in (NZB × NZW) F₁ female mice, possibly by blocking the interaction between activated autoreactive T cells and CD40-expressing endothelial cells. In the absence of this co-stimulatory signal the autoreactive T cells may become downregulated and the disease progress is blocked.

Disruption of the action of cytokines using soluble forms of cytokine receptors has been extensively considered. A recombinant, soluble TNF receptor produced by a hybrid genome in which the TNF receptor gene was fused to a human IgG Fc gene has been successfully introduced in the treatment of rheumatoid arthritis. In this case, the addition of the IgG constant region gene has the effect of prolonging the half-life of the recombinant TNF receptor in circulation. Similarly, CTLA4Ig (fusion of CTLA4 to Fc IgG) has been used in the treatment of murine lupus, and it was recently reported to have therapeutic effects in patients with psoriasis.

Injection of normal pooled immunoglobulins (IVIg) has been tried in a number of human autoimmune diseases and proved to be of definite help in a form of pediatric vasculitis (Kawasaki's syndrome) as well as in many cases of idiopathic thrombocytopenic purpura. The mechanism of action is believed to involve B-cell downregulation as a consequence of the simultaneous cross-linking of membrane immunoglobulins by anti-idiotypic antibodies contained in the IVIg preparations and of Fc receptors. The consequence of this downregulation is a decreased synthesis of auto-antibodies.

Elimination or downregulation of T cells by injection of monoclonal anti-T-cell antibodies has been shown to be therapeutic in a number of animal models as well as in human transplantation. Murine monoclonal antibodies are immunogenic and unsuitable for long-term use in humans. However, it is possible that genetically engineered humanized

monoclonal antibodies will prove useful. These humanized monoclonals are encoded by recombinant genomes in which all immunoglobulin-coding genes minus those coding for the antibody-binding site are of human origin, while the genes coding for the specific antibody binding site are obtained from a murine B-cell clone of known specificity. Because the immunogenic epitopes are predominantly located in the constant regions, which in these monoclonals are homologous, humanized monoclonals can be repeatedly administered to humans with low risk of inducing serum sickness. The clinical value of these antibodies in human autoimmune diseases is being evaluated.

Administration of immunotoxins that have been prepared by combining either monoclonal antibodies or IL-2 with cytotoxins is expected to increase the destruction rate of the cells responsible for the autoimmune process. These approaches have not met with great success. It is hoped that better definition of cell markers for activated lymphocyte subsets involved in the pathogenesis of autoimmune diseases may lead to the introduction of more specific and more effective antibodies or immunotoxins.

Reestablishment of a perturbed T_H1/T_H2 lymphokine balance has been successful in a number of animal models. T_H2 diseases (such as lupus) would benefit from blockade of the action of T_H2 cytokines such as IL-4, whereas T_H1 diseases (such as EAE) would benefit from the administration of IL-4. However, the effects of cytokines are pleiotropic, and the expected outcome of these interventions in humans may not be accomplished without undesirable side effects.

Autoimmune cells have been shown to display signaling abnormalities, and it has been suggested that use of drugs that block certain kinase activity to be of therapeutic value. It has been reported that administration of tyrphostin, an inhibitor of Janus-associated kinase (JNK), reduced EAE disease activity.

Autologous hematopoietic cell transplantation following ablation of the immune system has been reported to be helpful in patients with systemic autoimmune diseases that are refractory to conventional treatment. Current multicenter trials will determine the usefulness of this modality in the treatment of various severe autoimmune disorders including rheumatoid arthritis, multiple sclerosis, and systemic lupus erythematosus. It is expected that the eradication of the immune system and grafting of normal stem cells will set the immune clock back several years.

Plasmapheresis consists of pumping the patient's blood through a special centrifuge to separate plasma from white and red cells. The red cells and plasma substitutes are pumped back into the patient, while the plasma is discarded. The rationale for plasmapheresis in the treatment of autoimmune diseases is to remove pathogenic autoantibodies and immune complexes from the circulation.

SELF-EVALUATION

Questions

Choose the one *best* answer.

- 16.1 Which of the following is characteristic of tolerance induced with low doses of a given protein?
- A. Both T and B lymphocytes are unresponsive
 - B. Only B lymphocytes are unresponsive
 - C. T lymphocytes are predominantly affected
 - D. The autoreactive clones are permanently deleted
 - E. The duration of the tolerant state is relatively short

- 16.2 Which of the following combinations of antigens and routes of administration should be preferred in an experiment whose goal is to induce tolerance in laboratory animals?
- Aggregated antigens, intradermal
 - Aggregated antigens, intramuscular
 - Aggregated antigens, intravenous
 - Aggregate-free antigens, intramuscular
 - Aggregate-free antigens, intravenous
- 16.3 Which of the following would be expected in a state of tolerance due to clonal inactivation (anergy)?
- Irreversible, due to antigen-specific helper T-cell deficiency
 - Irreversible, due to lack of antigen processing
 - Reversible, due to the lack of peripheral mechanisms ensuring the persistence of the tolerant state
 - Reversible, if the autoreactive clones are effectively stimulated
- 16.4 If an animal is made tolerant to low doses of dinitrophenyl (DNP)-BGG, the injection of an immunogenic dose of nitrophenyl acetyl (NP)-BGG will be followed by:
- Antibody response to BGG only
 - Antibody response to NP and BGG
 - Antibody response to NP only
 - Antibody response to NP, DNP, and BGG
 - No apparent response to either NP or BGG
- 16.5 Tolerance to self antigens is favored by all of the following factors except:
- Binding of fragments derived from endogenous antigens to MHC-II molecules
 - Continuous exposure to low doses of circulating antigen
 - Cross-reactivity with microbial antigens
 - Exposure to endogenous antigens during the differentiation of the immune system
 - Release to the circulation of cellular antigens or their fragments
- 16.6 The carditis associated with rheumatic fever is believed to be caused by:
- Activation of T lymphocytes carrying a TcR that cross-reacts with membrane structures of infected myocardial cells
 - An autoimmune reaction triggered by the release of myosin from cardiac cells directly damaged by infection with group A *Streptococcus*
 - Antibodies to group A *Streptococcus*, which cross-react with cardiac myosin
 - Deposition of immune complexes in the myocardium
 - Increased expression of MHC-II molecules in myocardial tissue infected with group A *Streptococcus*
- 16.7 An animal injected with 2 mg of DNP-BSA i.v. while immunosuppressed with cyclophosphamide fails to show antibody responses to either DNP or bovine serum albumin (BSA) 2 weeks later. The response to human gamma globulin (HGG) is, however, intact. Cyclophosphamide is stopped, and 4 weeks later the animal is challenged with 2 mg of DNP-HGG mixed

with complete Freund's adjuvant i.m. Ten days later you would expect to detect:

- A. Anti-DNP antibodies only
- B. Anti-HGG and anti-DNP antibodies
- C. Anti-HGG antibodies only
- D. Anti-HGG, anti-BSA, and anti-DNP antibodies
- E. No antibodies at all

In Questions 16.8–16.10, match the phrase with the letter heading that is most closely related to it. The same heading may be used once, more than once, or not at all. Match the autoimmune disease with the mechanism most likely involved in its pathogenesis:

- A. Cross-reactive anti-idiotypic antibodies
 - B. Cross-reactive idiotypes
 - C. Increased antigen presentation
 - D. Molecular mimicry
 - E. Release of sequestered antigens
- 16.8 Myocarditis associated to coxsackie B3 virus infection
 16.9 Sympathetic ophthalmia
 16.10 Guillain-Barré syndrome

Answers

- 16.1 (C) Low-zone tolerance (induced with small concentrations of antigen) affects predominantly T cells and is of long duration, but the autoreactive clones are not deleted.
- 16.2 (E)
- 16.3 (D) Clonal anergy is believed to be significant in human tolerance, particularly because anergy (in contrast to clonal deletion) is potentially reversible, and, therefore, this type of anergy is compatible with autoimmunity, while clonal deletion is not. The reversibility, however, is not believed to be spontaneous, as if it resulted from the lack of peripheral mechanisms to ensure the persistence of the tolerant state, but rather to result from vigorous stimulation of anergic cells, most likely by cross-reactive antigens properly presented in association with fully functional accessory cells.
- 16.4 (E) The animal has been made tolerant to BGG by injection of low doses of antigen (low zone tolerance). Thus, T lymphocytes are tolerant and will not assist the response of B cells to either hapten or carrier.
- 16.5 (C) The cross-reactivity with microbial antigens is actually believed to be an important factor leading to loss of tolerance. All the other listed factors may be relevant in the inductive stages of tolerance.
- 16.6 (C) Rheumatic fever is believed to be an example of cross-reactive autoimmunity. Some strains of group A *Streptococcus* elicit antibodies that cross-react with myosin, leading to the development of the cardiac lesions characteristic of the disease.

- 16.7 (B) The conditions described in the stem are likely to result in T-cell tolerance. This type of tolerance is long lasting, and in the case of a hapten-carrier reaction the tolerance is specifically directed against the carrier. When the tolerant animal is stimulated with a different hapten-carrier combination, a response to both is expected, since the B lymphocytes are not tolerant, and the T lymphocytes are only tolerant to BSA and not to HGG.
- 16.8 (E) Coxsackie B3 virus is believed to damage the myocardium and induce the release of myosin, which will cause an autoimmune reaction that will perpetuate the myocarditis.
- 16.9 (E)
- 16.10 (D) The Guillain-Barré syndrome is believed to result from an autoimmune response triggered by cross-reactivity between microbial antigens and neuronal cells. One of the best characterized cross-reactions is triggered by the glycolipids in the membrane of *Campylobacter jejuni* and explains the association between infections caused by this bacterium and the Guillain-Barré syndrome.

BIBLIOGRAPHY

- Albert, L. J., and Inman, R. D. Molecular mimicry and autoimmunity. *N. Engl. J. Med.* 341:2068, 2000.
- Blackman, M., Kapler, J., and Marrack, P. The role of the T lymphocyte receptor in positive and negative selection of developing T lymphocytes. *Science* 248:1335, 1990.
- Burkly, L. C., Lo, D., and Flavell, R. A. Tolerance in transgenic mice expressing major histocompatibility molecules extrathymically on pancreatic cells. *Science* 248:1364, 1990.
- Faria, A. M. C., and Weiner, H. L. Oral tolerance: Mechanisms and therapeutic applications. *Adv. Immunol.* 73:153, 1999.
- Fields, P. E., Gajewski, T. F., and Fitch, F. W. Blocked Ras activation in anergic CD4⁺ T cells. *Science* 271:1276, 1996.
- Flavell, R. A., and Hafler, D. A. Autoimmunity. What is the turning point? *Curr. Opin. Immunol.* 11:635, 1999.
- Goodnow G. C. Transgenic mice and analysis of B-cell tolerance. *Ann. Rev Immunol.* 10:489, 1992.
- Harlan, D. M., Abe, R., Lee, K. P., and June, C. H. Potential roles of the B7 and CD28 receptor families in autoimmunity and immune evasion. *Clin. Immunol. Immunopathol.* 75:99, 1995.
- Lowrey, J. A., Savage, N. D. L., Palliser, D., et al. Induction of tolerance via the respiratory mucosa. *Int. Arch. Allergy Appl. Immunol.* 116:93, 1998.
- Mayer, L. Oral tolerance: New approaches, new problems. *Clin. Immunol.* 94:1, 2000.
- Oldstone, M. B. Molecular mimicry and immune-mediated diseases. *FASEB J.* 12:1255, 1998.
- Ridge, J. P., Fuchs, E. J., and Matzinger, P. Neonatal tolerance revisited: turning on newborn T cells with dendritic cells. *Science* 271:1723, 1996.
- Sakata, K.-M., Sakata, A., Kong, L., et al. Role of Fas/FasL interaction in physiology and pathology: The good and the bad. *Clin. Immunol. Immunopath.* 87:1, 1998.
- Powell, J. D., Lemer, C. G., Ewoldt, G. R., and Schwartz, R. H. The -180 site of the IL-2 promoter is the target of CREB/CREM binding in T cell anergy. *J. Immunol* 163:6631, 1999.
- Thomson, C. B. Distinct roles for the costimulatory ligands B7-1 and B7-2 in helper cell differentiation *Cell* 81:979, 1995.
- Theofilopoulos, A. N., Kono, D. H. The genes of systemic autoimmunity. *Proc. Assoc. Am. Phys.* 111:228, 1999.

17

Organ-Specific Autoimmune Diseases

Gabriel Virella and Jean-Michel Goust

I. INTRODUCTION

Autoimmune diseases can be roughly divided into organ-specific and systemic, based both on the extent of their involvement and the type of “autoantibodies” present in the patients. The systemic forms of autoimmune diseases, best exemplified by systemic lupus erythematosus (SLE) and rheumatoid arthritis, will be discussed in Chapters 18 and 19. Less generalized autoimmune processes may affect virtually every organ system (Table 17.1); in many instances only certain cell types within an organ system will be affected in a particular disease, e.g., gastric parietal cells in pernicious anemia. In this chapter we will restrict our discussion to the major autoimmune diseases that affect specific organs and the associated autoantibodies with the understanding that in many cases these antibodies are not the cause of the disease, but just a secondary manifestation.

II. AUTOIMMUNE DISEASES OF THE THYROID GLAND

Autoimmune factors have been implicated two major thyroid diseases: Graves’ disease and Hashimoto’s disease.

A. Graves’ Disease

Graves’ disease, also known as thyrotoxicosis, diffuse toxic goiter, and exophthalmic goiter, is the result of the production of antibodies against the thyrotrophic hormone (TSH)

Table 17.1 Examples of Organ-Specific and Systemic Autoimmune Diseases

Disease	Target tissue	Antibodies (mainly against)
Organ-specific diseases		
Graves' disease	Thyroid	TSH receptor
Hashimoto's thyroiditis	Thyroid	Thyroglobulin
Myasthenia gravis	Muscle	Acetylcholine receptors
Pemicious anemia	Gastric parietal cells	Gastric parietal cells, intrinsic factor (IF), B12-IF complex
Addison's disease	Adrenals	Adrenal cells, Microsomal antigen
Insulin-dependent diabetes mellitus	Pancreas	Pancreatic islet cells, insulin
Primary biliary cirrhosis	Liver	Mitochondrial antigens
Autoimmune chronic active hepatitis	Liver	Nuclear antigens, smooth muscle, liver-kidney microsomal antigen, soluble liver antigen, etc.
Autoimmune hemolytic anemia	RBCs	RBCs
Idiopathic thrombocytopenic purpura	Platelets	Platelets
Systemic diseases		
Systemic lupus erythematosus	Kidney, skin, lung, brain	Nuclear antigens, microsomes, IgG, etc.
Rheumatoid arthritis	Joints	IgG, nuclear antigens
Sjögren's syndrome	Salivary and lachrymal glands	Nucleolar mitochondria
Goodpasture's syndrome	Lungs, kidneys	Basement membranes

receptor (thyroid receptor antibodies). The TSH receptor antibodies detected in patients with Graves' disease stimulate the activity of the thyroid gland. For that reason they have been known by a variety of descriptive terms, including long-acting thyroid stimulator (LATS), thyroid-stimulating immunoglobulin (TSI), and thyroid-stimulating antibodies.

Thyroid-stimulating antibodies are detected in 80–90% of patients with Graves' disease, are usually of the IgG isotype, and have the capacity to stimulate the production of thyroid hormones by activating the adenylate cyclase system after binding to the TSH receptor. Biopsy of the thyroid gland shows diffuse lymphoplasmocytic interstitial infiltration.

Graves' disease has its peak incidence in the third to fourth decade and has a female-to-male ratio of 4–8:1. Patients usually present with diffuse goiter, and 60–70% of patients have ocular disturbances. Symptoms of hyperthyroidism include increased metabolic rate with weight loss, nervousness, weakness, sweating, heat intolerance, and loose stools. Abnormalities on physical examination include diffuse and nontender enlargement of the thyroid, tachycardia, warm and moist skin, tremor, exophthalmos, and pretibial edema. Exophthalmos (protrusion of the eyeball) can be unilateral or bilateral and may be associated with proptosis, conjunctivitis, and/or periorbital edema. Exophthalmos is classically attributed to an increased volume of extraocular tissues due to edema and/or to deposition of mucopolysaccharides. Recently, it has been proposed that an autoimmune response to a tissue antigen expressed on both thyroid and eye muscle membrane could induce orbital inflammation and be responsible for the protrusion of the eyeball.

The diagnosis is usually investigated in patients with hyperthyroidism, found to have increased levels of thyroid hormones (triiodothyronine or T_3 and thyroxine or T_4) and increased uptake of T_3 . The diagnosis is confirmed by demonstration of anti-thyroid receptor antibodies using two types of assays:

1. Those based on the inhibition of TSH binding by TSI antibodies (TSH-binding inhibition assay). This assay is relatively simple and precise, but the results obtained do not always correlate with disease activity, since nonstimulating antibodies can also block TSH binding.
2. Those based on the functional consequences of thyroid receptor antibody binding to TSH. This last group of assays measures true thyroid stimulating antibodies and includes (1) tests in which the endpoint for thyroid activation is the accumulation of intracellular colloid droplets or the penetration of thrombogenic substrates into lysosomal membranes, (2) tests in which the activation of adenylate cyclase is measured, and (3) tests in which cAMP accumulation is measured.

The functional assays correlate better with disease activity but are difficult to calibrate and reproduce, and when heterologous thyroid is used as substrate there is always the possibility that some human TSI antibodies might not react across species.

Therapy is directed at reducing the thyroid's ability to respond to stimulation by antibodies. This can be achieved surgically, by subtotal thyroidectomy, or pharmacologically, either by administration of radioactive iodine (^{131}I) (which is difficult to dose), or by the use of antithyroid drugs such as propylthiouracil and methimazole, which are useful but slow in their effects.

B. Hashimoto's Disease

Hashimoto's thyroiditis (autoimmune thyroiditis) is, in its early stages, a subclinical disease in which no thyroid dysfunction is evident and no therapy is needed. With time it evolves to hypothyroidism and replacement therapy may be needed. A cell-mediated autoimmune reaction triggered by unknown factors is believed to be primarily responsible for the development of the disease. Several lines of evidence support this conclusion:

1. The inflammatory infiltrate of the thyroid gland shows predominance of activated, lymphokine-secreting T lymphocytes. Numerous plasma cells can also be seen. IL-1 predominates among the cytokines released by activated mononuclear cells, and it has been shown that this cytokine can induce the expression of Fas in thyroid cells, which also express FasL. It has been postulated that this dual expression of Fas and FasL sets the stage for exaggerated apoptosis and may explain the slowly progressive decline of thyroid function in these patients.
2. Infusing lymphocytes from sick to healthy laboratory animals can easily transfer thyroiditis.
3. Infants of mothers with active disease carrying IgG antibodies (which cross the placenta) are unaffected.

Whether or not autoantibodies against thyroglobulin and microsomal antigens frequently detected in those patients play any pathogenic role is unclear. The main argument supporting their involvement is a good correlation between their titers and disease activity. However, this relationship is also expected if those antibodies arise as a consequence of the activation of helper T cells. This could be a result of the presentation of high levels of

MHC-II–endogenous peptide complexes to anergic T_H2 cells, breaking tolerance and causing the inactivation of autoreactive B lymphocytes. Furthermore, these autoantibodies antibodies are detected in low titers in up to 15% of the normal adult female population.

Hashimoto's thyroiditis is the most common form of thyroiditis, and it usually has a chronic evolution. Its incidence peaks during the third to fifth decades, with a female-to-male ratio of 10:1. It is characterized by a slow progression to hypothyroidism, and symptoms develop insidiously. Patients often present with dysphagia or a complaint that their clothes are too tight around the neck. Most patients become hypothyroid with symptoms of malaise, fatigue, cold intolerance, and constipation. Signs include dry, coarse hair and a diffuse enlarged goiter, usually not tender.

The diagnosis is usually confirmed by the detection of anti-thyroglobulin antibodies. Sixty to 75% of the patients show a positive reaction by passive hemagglutination using thyroglobulin-coated erythrocytes (titers higher than 25, while normal individuals usually have titers up to 5). Although these antibodies are also found in other autoimmune disorders such as pernicious anemia, Sjogren's syndrome, and in 3–18% of normal individuals, the titer of autoantibodies is lower in all other groups with the exception of patients with Sjogren's syndrome. In patients with hypothyroidism, T_3 and T_4 levels and T_3 uptake are low and TSH is increased.

The treatment of Hashimoto's thyroiditis depends, largely, on the stage of the disease and the clinical symptoms. In the early stages glucocorticoids may be used as mild immunosuppressants, with the aim of reducing the autoimmune response and extending the asymptomatic phase. When patients develop hypothyroidism, thyroid hormone replacement is indicated. In patients with large goiters, the administration of thyroxine and triiodothyronine may reduce the size of the thyroid gland.

III. ADDISON'S DISEASE (CHRONIC PRIMARY HYPOADRENALISM)

Addison's disease can either be caused by exogenous agents (e.g., infection of the adrenals by *Mycobacterium tuberculosis*) or be idiopathic. The idiopathic form is believed to have an immune basis, since 50% of patients have been found to have antibodies to the microsomes of adrenal cells (as compared to 5% in the general population) by immunofluorescence. The autoantibodies directed against the adrenal react mainly in the zona glomerulosa, zona fasciculata, and zona reticularis and are believed to play the main pathogenic role in this disease, causing atrophy and loss of function of the adrenal cortex. Biopsy of the adrenal glands shows marked cortical atrophy with an unaltered medulla. Abundant inflammatory mononuclear cells are seen between the residual islands of epithelial cells.

The autoimmune form of Addison's disease is found frequently in association with other autoimmune diseases, such as thyroiditis, pernicious anemia, and diabetes mellitus; autoantibodies to adrenal cortex are not found in Addison's disease caused by tuberculosis of the adrenal glands.

Symptoms of Addison's disease or adrenal insufficiency include weakness, fatigability, anorexia, nausea, vomiting, weight loss, and diarrhea. Signs include increased skin pigmentation and vascular collapse and hypotension. Addison's disease is most commonly found in the fourth and fifth decades of life and is two to three times more frequent in females.

The diagnosis is confirmed by demonstration of antiadrenal antibodies by indirect immunofluorescence. Low plasma cortisol levels and low levels of urine 17-ketosteroids and 17-hydroxycorticoids are characteristic of the disease. Frequent metabolic abnormali-

ties include acidosis, hyperkalemia, hyponatremia, low levels of chloride and bicarbonate, and hypoglycemia. Lymphocytosis with eosinophilia may be present.

The treatment of Addison's disease consists of replacement of both glucocorticoids and mineralocorticoids.

IV. AUTOIMMUNE DISEASES OF THE PANCREAS

A. Diabetes Mellitus

Diabetes mellitus (DM) is a multiorgan disease with multiple etiologies and certainly with more than one basic abnormality. In type 1 diabetes (autoimmune diabetes), the basic defect is a decreased to absent production of insulin secondary to β -cell destruction (for which reason it is also known as insulin-dependent DM, or IDDM). In type 2 diabetes, there is a decrease in the effect of insulin at the target cell level. In this chapter we will limit our discussion to type 1 diabetes, which in the vast majority of cases is an autoimmune disorder.

1. Pathogenesis

The major body of evidence on which the concept of type 1 diabetes being an autoimmune disease has been based is the detection of many different types of autoantibodies in patients with DM. These antibodies do not seem to play a major pathogenic role, at least as initial pathogenic insults; they seem to reflect the intensity of the underlying autoimmune reaction against the islet cell β cells. These antibodies can be detected before diabetes becomes clinically evident, and the number of different antibodies detected seems to be inversely correlated with the length of the disease-free interval in positive individuals. The following are the major types of autoantibodies detected in patients with IDDM.

1. Anti-islet cell antibodies (ICA) are classically detected by indirect immunofluorescence and react against membrane and cytoplasmic antigens of the islet cells. ICA are detected in as many as 90% of type 1 diabetic patients at the time of diagnosis, but they diminish in frequency to 5–10% in patients with long-standing DM. Other interesting characteristics of ICA are their isotype distribution, with predominance of subclasses IgG2 and/or IgG4 (which have limited complement-activating properties), and their detection months or years before the appearance of clinical symptoms.
2. The best characterized islet cell antigens against which antibodies have been demonstrated in type 1 diabetics and individuals predisposed to develop the disease are IA-2 α and IA-2 β (phogrin), two closely related β cell-associated tyrosine phosphatases. About two thirds of the patients have antibodies to IA-2 α , and about 60% of the patients have antibodies to IA-2 β . Epitope mapping studies suggest that the immunogenic epitopes are located in the intracytoplasmic segment of these enzymes. Antibodies to glutamic acid decarboxylase (GAD) are also present in a large proportion of newly diagnosed diabetics (84%).
3. Anti-insulin autoantibodies are detected in as many as 92% of non-insulin-treated patients with IDDM at the time of diagnosis. The pathogenic significance of insulin autoantibodies is not clear, but the coexistence of anti-insulin antibodies and ICA has a strong predictive value for the future development of diabetes. Two theories have been proposed to explain the emergence of anti-insulin antibodies: (1) During destruction of the islet cells, insulin may be exposed to the im-

immune system in a form that may be recognized as foreign. This could explain the development of anti-insulin antibodies in type I patients with insulinitis (islet cell inflammation). (2) A recent finding of antigenic mimicry between insulin and a retroviral antigen, apparently leading to the spontaneous emergence of anti-insulin antibodies in non-obese diabetic prone mice, supports the alternative possibility that anti-insulin antibodies may be triggered as a result of infection with an agent expressing cross-reactive antigen(s).

4. Induced anti-insulin antibodies can be found in all diabetic patients treated with insulin. The incidence of these antibodies was greater when bovine or porcine insulin was used. However, anti-human insulin antibodies can also be detected (less frequently) in patients treated with recombinant human insulin, whose tertiary configuration differs from that of the insulin released by the human pancreas. The antibodies directed against therapeutically administered insulins appear to be predominantly of the IgG2 and IgG4 isotypes.

Cell-mediated immunity is believed to have a more important pathogenic role in causing islet cell damage than the autoantibodies to islet cells and insulin. One major argument in favor of the involvement of cell-mediated mechanisms is the fact that the pathological hallmark of recent onset diabetes is the mononuclear cell infiltration of the islet cells, known as insulinitis. Similar observations can be made in animals with experimentally induced forms of diabetes. The predominant cells in the islet cell infiltrates are T lymphocytes, including both activated CD4⁺ and CD8⁺ T lymphocytes. Activated monocytes are also present in the infiltrates. The major pathogenic role seems to be played by CD4⁺ T cells, with a T_H0-T_H1 cytokine secreting pattern. Those cells secrete large amounts of IL-2 and IFN- γ .

The significance of increased IL-2 secretion may lie in the fact that IL-2 causes the upregulation of MHC-II in islet β cells, thus creating favorable conditions for the activation of autoreactive cells. In experimental animal models, this change precedes the development of insulinitis. IFN- γ , on the other hand, activates macrophages, causing the release of cytokines, such as IL-1 and IL-12, and toxic radicals. IL-1 has been shown to lead to β -cell damage by indirect mechanisms. IL-12 may promote the differentiation and activation of additional T_H1 cells as well as the activation of cytotoxic T cells and NK cells. Toxic radicals, such as superoxide and nitric oxide, are known to be toxic to islet cells *in vitro*. It has been shown that IFN- γ can also activate the synthesis of oxygen active radicals and nitric oxide in β cells. These compounds can react with each other, forming peroxynitrate, which is highly toxic. Activated CD8⁺ cells may also be involved in monocyte activation through the secretion of IFN- γ . The main question that remains unanswered is the nature of the epitopes that are recognized by these cells and that trigger their activation.

Of crucial importance to our understanding of the pathogenesis of DM is the definition of the insult(s) that may activate autoreactive T lymphocytes and trigger the disease. It is generally accepted that an environmental insult, most likely a viral infection, plays the initiating role, causing β -cell cytotoxicity. There is suggestive evidence supporting the pathogenic role of viral infections in some patient populations. For example, 12–15% of patients with congenital rubella develop type 1 diabetes, particularly when they are DR3 or DR4 positive. But for the majority of diabetic patients, a link with any given viral infection remains elusive.

Whatever the initial insult to the β cell may be, it can be postulated that damaged β cells are ingested by macrophages, which will express islet cell-derived peptides in association with MHC-II, thus creating conditions for the initiation of an autoimmune T-cell re-

sponse. In addition, macrophages activated as a consequence of phagocytosis will release cytokines, such as IL-1 and IL-12, which activate T cells. Activated T cells, in turn, will release IFN- γ , which activates macrophages and induces MHC-II expression. This mutual activation of macrophages and T cells results in the inflammatory process known as insulinitis, which perpetuates β -cell destruction through the release of cytokines and toxic compounds and the differentiation of cytotoxic T cells. β -Cell death seems to result from both necrosis and apoptosis.

The nature of the epitopes recognized by autoreactive T cells has not been fully determined. Different authors have published results suggesting that insulin-derived, GAD-derived, and IA-2 α and β epitopes are recognized by autoreactive T cells. The overall evidence suggests that the T-cell autoimmune response is polyclonal. Once the antigens recognized by sensitized T cells are identified, it will remain to be determined whether viral infections play a pathogenic role, perhaps through upregulation of MHC-II and generation of high concentrations of self peptides resulting from processing of proteins released by dying β cells.

2. Genetic Factors

Type 1 DM is a polygenic disease. Twenty different chromosomal regions possibly influencing the development of this form of diabetes have been identified. Of those, two have been better characterized.

The IDDM1 region, which includes the MHC genes determining resistance/susceptibility to diabetes, is considered to be the major genetic determinant of predisposition for the development of diabetes. Several DP and DQ alleles are associated with predisposition or resistance to diabetes. Ninety-five percent of diabetics express DR3 and/or DR4, compared to 42–54% of nondiabetics. This corresponds to a relative disease risk of 2–5. Seventy-five percent of diabetics express the Dw4 allele versus 54% of nondiabetics. Several DQ and DR alleles associated with susceptibility or resistance to diabetes have been identified. In Caucasians, resistance is associated with the DQ β w3.1 allele, characterized by the presence of aspartate (a negatively charged amino acid) in position 57 of the β chain. The presence of a neutral amino acid in that same position is characteristic of susceptibility alleles, such as DQ 2 or DQ 8 (which are in linkage disequilibrium with DR3 and DR4), as is presence of arginine in position 52 of DQ α . Individuals with two Asp⁻ DQ alleles have the highest degree of predisposition to DM (Table 17.2).

Table 17.2 Insulin-Dependent Diabetes-Related MHC Markers

Markers associated with protection	Markers associated with predisposition
DR2	DR3
DR5	DR4 ^a
DQ β w3.1 ^b	DQ β w3.2 ^b
Asp 57 ⁺ DQ β	Asp 57 ⁻ DQ β ^c
	Arg52 ⁺ DQ α

^a Maximal risk in DR3/DR4 heterozygous individuals.

^b DR4 subtypes; DQ β w3.2 is associated with predisposition mainly in DR3/DR4 heterozygotes.

^c Maximal predisposition is associated either with the expression of two Asp⁻ 57 alleles of DR3 or DR4 or with the expression of an Asp 57⁻, Arg52⁺ DQ α β heterodimer. Maximal protection is associated with expression of two Asp 57⁺ DQ β alleles.

MHC-I genes associated with predisposition to develop diabetes have also been identified. These MHC-I molecules are believed to be involved in the presentation of “diabetogenic” peptides to CD8⁺ cells, as supported by the finding of activated CD8⁺ T cells in the infiltrates surrounding the islets. Two additional sets of genes may play significant roles in determining whether CD8⁺ T cells are activated or not:

1. Loci coding for proteasome components, which influence the type of peptides generated from autologous proteins. The generation of endogenous “diabetogenic” peptides, therefore, may depend on the nature of proteasomes.
2. Loci coding for the synthesis of transport-associated proteins (TAP proteins) responsible for the transport of endogenous peptides to the endoplasmic reticulum, where those peptides become associated with MHC-I peptides. The Tap genes are located in chromosome 6, near the MHC region, and may be transmitted in linkage disequilibrium with MHC-II genes. One Tap-2 gene allele (Tap-2*0101) is associated with susceptibility to diabetes (relative risk of 3.4), while another has been defined as protective in relation to diabetes.

The IDDM2 region includes the insulin gene and the insulin-growth factor II loci on chromosome 11. These genes have low expression in the thymus, perhaps impairing the ability to develop central tolerance to insulin-derived peptides.

Several other regions are linked to diabetes predisposition with variable consistency. These include regions with loci coding for insulin growth factor-binding proteins (chromosome 2), which appear to be linked with predisposition to develop diabetes, particularly in females, and the CTLA-4 gene (also in chromosome 2), which is likely to play a significant role in the regulation of peripheral tolerance.

3. *Genetic Factors in the Development of Diabetes*

Several hypotheses have been advanced to explain how MHC molecules, proteasomes, and TAP proteins influence the development of diabetes, hinging on their ability to generate and present in association with MHC molecule β -cell-derived peptides involved in the elicitation of the autoimmune response resulting in diabetes (diabetogenic peptides). One of the many interpretations put forward is that the basis for the MHC-II role in protection or predisposition for type 1 DM is related to the differential ability to bind diabetogenic peptides generated from the ingestion of β cells undergoing spontaneous apoptosis and present them to the immune system. Protective MHC-II molecules would not bind those peptides, whereas predisposing MHC-II molecules would. Presentation of MHC-II-bound diabetogenic peptides by itself is not sufficient to explain the development of autoimmunity, because in physiological conditions it is likely to result in tolerance. The emergence of IDDM seems to be preceded by an abnormally low expression of predisposing MHC-II molecules and co-stimulatory molecules by dendritic cells. As a consequence, the ability to maintain peripheral tolerance to diabetogenic peptides may be lost early in life.

Later on, as a consequence of strong activation secondary to a viral infection that causes β -cell damage and ingestion of damaged cells by activated APCs, these markers would be upregulated and their binding sites occupied with diabetogenic peptides generated in the phagolysosomes where the β -cell debris is digested. The MHC-II-peptide complexes generated in this way should be expressed with sufficient density as to activate a vigorous CD4⁺ T-cell response from individuals no longer tolerant. Activated CD8⁺ T cells are also present in the infiltrates surrounding the islets of diabetic patients and diabetic ex-

perimental animals. Those cells must be activated by recognizing MHC-I-expressed diabetogenic peptides, generated in patients with the proper conjunction of MHC-I molecules, proteasomes, and TAP proteins.

Finally, whether or not an individual carrying predisposing genes does or does not develop diabetes may depend on (1) whether all the cells necessary to start an active autoimmune response receive the correct activation signals and (2) the lack of activation of counterregulatory cells that otherwise would keep the autoreactive clones in check.

4. *Sequence of Pathogenic Events Leading to the Development of IDDM*

Based on our current knowledge of the control of immunological responses and tolerance and on data accumulated from studies of IDDM patients and experimental animal models, the following hypothetical sequence of events leading to the development of IDDM can be proposed. First, one has to admit that autoreactive clones potentially able to be engaged in autoimmunity against pancreatic β cells persist in adult life. Under normal conditions, the interaction of those self-reactive TcR with MHC–diabetogenic peptide complexes expressed in cells unable to deliver co-stimulatory signals results in weak, tolerogenic, or apoptotic signaling of the autoreactive T cells.

The structure of MHC molecules and the repertoire of proteasomes and TAP proteins genetically determine the level of expression of diabetogenic peptides. Those individuals able to express high levels of those peptides in association with MHC molecules are at greater risk to develop IDDM. A viral infection affecting the β cells or neighboring tissues leads to the activation of T_H cells involved in the antiviral response. Those cells will deliver co-stimulatory signals to the autoreactive T_H cells, pushing them into a state of activation rather than anergy. IL-2 and other cytokines released by activated T cells induce the expression of MHC-II and CAMs in β cells.

The activated autoreactive T cells accumulate in the pancreatic islets and release chemotactic cytokines and interferon- γ , which will attract and activate monocytes/macrophages to the area, where interactions with islet cells overexpressing CAMs will contribute to their fixation in the islets. The activated monocytes/macrophages release cytokines such as IL-1, IL-12, TNF, and toxic compounds such as oxygen active radicals and nitric oxide. The cytokines contribute to the damage by increasing the level of activation of T_H1 cells (IL-12), monocytes, and macrophages (IL-1, TNF). In addition, IL-1 and interferon- γ (released by activated T_H1 cells) induce the expression of Fas on islet cells. Islet cell death is a consequence of several mechanisms, including Fas-FasL apoptosis signaling and the release of toxic radicals that lead to oxidative changes of cell and organelle membrane lipids.

5. Immunotherapy

Two main approaches to immunotherapy have been evaluated: one involving the use of immunosuppressants, the other involving tolerization.

Among immunosuppressants, cyclosporin A received considerable attention in trials, with the goal of preventing the full development of DM. To be effective, immunosuppressive therapy needs to be instituted in recently diagnosed patients with residual β -cell function, but the treatment is only effective while cyclosporin A is administered. In the vast majority of cases, progression to diabetes is seen soon after immunosuppressive therapy is discontinued.

Induction of tolerance seems possible after administration of insulin either by aerosol or by the oral route. Aerosol administration seems to result in the induction of γ/δ CD8⁺ T cells that secrete IL-10 and IL-4 and, in experimental animal models, are able to prevent the development of diabetes. Oral administration seems to generate a similar set of γ/δ CD4⁺ regulatory cells that secrete large amounts of TGF- β in addition to IL4 and IL-10. There are ongoing trials in which children identified as at risk by DQ haplotype analysis are given insulin by one of these routes, hoping to delay or prevent the onset of DM.

B. Acanthosis Nigricans

Acanthosis nigricans is a rare syndrome that received its name because of thickening and hyperpigmentation of the skin in the flexural and intertriginous areas. Patients with this disorder develop a particularly labile form of diabetes associated with antibodies directed against the insulin receptor. These antibodies block the binding of insulin to the receptor. If the antibodies themselves are devoid of activating properties, they induce insulin-resistant diabetes. On the other side, the antibodies may stimulate the insulin receptor and cause hypoglycemia.

The clinical symptoms can be rather variable, depending on the biological properties of the predominant antibody population. Blocking antibodies to the insulin receptor cause hyperglycemia that does not respond to the administration of insulin (insulin-resistant diabetes). In contrast, insulin receptor antibodies with stimulating properties may induce the cellular metabolic effects usually triggered by insulin, albeit in an abnormal and unregulated fashion. The clinical picture is one of hyperinsulinism. The same patient may undergo cycles of predominance of hypo- and hyperinsulinism-like symptoms, mimicking an extremely brittle and difficult to control form of diabetes.

V. AUTOIMMUNE DISEASES OF THE GASTROINTESTINAL TRACT AND LIVER

A. Pernicious Anemia

Pernicious or megaloblastic anemia is a severe form of anemia secondary to a special type of chronic atrophic gastritis associated with lack of absorption of vitamin B₁₂. Pathologically the disease is associated with chronic atrophic gastritis and with defective production and/or function of intrinsic factor, which is required for the absorption of vitamin B₁₂. Three types of autoantibodies have been described in patients with this disease:

- Type I (blocking) antibodies, present in 75% of patients, bind to intrinsic factor (IF) and prevent its binding to vitamin B₁₂.
- Type II (binding) antibodies react with the IF–vitamin B₁₂ complex and inhibit IF action. The type II antibody is found in 50% of patients, and it does not occur in the absence of type I antibody.
- Type III (parietal canalicular) antibodies, present in the microvilli of the canalicular system of the gastric mucosa, are detected in 85–90% of patients and react with the parietal cell, inhibiting the secretion of IF.

In 10–15% of patients with pernicious anemia, no antibody can be detected with currently available techniques. Other autoimmune diseases such as thyroiditis and Addison's disease are diagnosed with abnormally high frequency in patients with pernicious anemia.

Severe neuropathy and megaloblastic anemia dominate the clinical picture in patients with vitamin B₁₂ deficiency. The development of neuropathy is a consequence of the fact that vitamin B₁₂ is an essential coenzyme for the metabolism of homocysteine, the metabolic precursor of methionine and choline. Choline is required for the synthesis of choline-containing phospholipids, and methionine is also needed for the methylation of basic myelin. The synthesis of fatty acids is also abnormal, and those abnormal fatty acids are incorporated into neural tissues. Therefore, the metabolism of myelin is abnormal in patients with vitamin B₁₂ deficiency resulting in demyelination and nerve tissue damage. The symptoms include weakness and numbing of the extremities, secondary to loss of myelin on the dorsal and lateral spinal tracts. Signs consist of loss of vibratory sense, ataxia, incoordination, and impaired mentation.

The hematopoietic abnormalities are a consequence of the fact that vitamin B₁₂ is required for the normal cellular metabolism of tetrahydrofolate; if tetrahydrofolate is not properly synthesized, folate will not be properly conjugated, and a tissue folate deficiency will ensue. In turn, purine metabolism is impaired, DNA metabolism is abnormal, and hematopoiesis cannot proceed normally. This affects the bone marrow because the hemopoietic precursors are rapidly dividing cells. Red cells, granulocytes, as well as platelets are affected. The term *megaloblastic anemia* refers to the finding of abnormal red cells in the peripheral blood and hypercellularity with numerous megaloblasts on the bone marrow (from which the term megaloblastic anemia derives). Neutopenia, hypersegmented neutrophils, and mild to moderate thrombocytopenia are often present in these patients. Parenteral administration of vitamin B₁₂ is followed by a marked increase in reticulocyte count, which is considered diagnostic.

Abnormalities of the digestive tract include atrophic glossitis and gastritis, which probably result from impaired epithelial regeneration. A histamine stimulation test of the gastric cells will show achlorhydria.

Treatment involves intramuscular injection of vitamin B₁₂ that will correct both hematological and neurological manifestations.

B. Primary Biliary Cirrhosis

Primary biliary cirrhosis (autoimmune cholangitis) is a chronic granulomatous inflammatory liver disease that results in destruction of the intrahepatic biliary tree, specifically affecting the epithelium of the small intrahepatic bile ducts. This disease is often associated with other autoimmune diseases such as Sjögren's syndrome and scleroderma.

Although the true pathogenic process is not known, several immunological abnormalities can be demonstrated, such as antimitochondrial antibodies, detected in over 99% of patients, circulating serum immune complexes, increased levels of serum immunoglobulins, and abnormal counts and function of CD4⁺ and CD8⁺ T lymphocytes.

The disease is mainly a disease of middle-aged women. The onset is insidious and is heralded by pruritus and symptoms of cholestasis. Jaundice is a late sign. Patients have a large, nontender liver. The most significant findings from the diagnostic point of view include detection of antimitochondrial antibodies and increase in serum alkaline phosphatase with normal transaminases and bilirubin.

There is no satisfactory treatment for this disease. Penicillamine, a heavy metal-chelating agent, has been used with some success. By unknown mechanisms, this drug is known to reduce the ratio of helper to suppressor cells, which is reflected into a depression of humoral immune responses in both experimental animals and humans. However, penicillamine is nephrotoxic, and its use may be associated with severe side effects.

C. Chronic Active Hepatitis

Chronic active hepatitis (CAH) is a disease characterized by persistent hepatic inflammation, necrosis, and fibrosis, which often lead to hepatic insufficiency and cirrhosis. It can be subclassified by its etiology as virus-induced, drug-induced, or chemically induced, autoimmune, and cryptogenic (cases that do not fit into any of the other groups).

Viral chronic active hepatitis can be caused by a variety of hepatotropic viruses, namely hepatitis B, C, and D viruses. The liver disease is often accompanied by extrahepatic manifestations suggestive of immune complex disease, such as arthralgias, arthritis, skin rash, vasculitis, and glomerulonephritis. These manifestations are believed to result from chronic viral antigen release, eliciting an antibody response and consequent immune complex formation and deposition in different tissues and organs.

Autoimmune chronic active hepatitis is characterized by the presence of autoantibodies and by lack of evidence of viral infection. Based on the pattern of autoantibodies detected in different patients, CAH can be subclassified into four types. The best characterized is the classic autoimmune chronic hepatitis (also known as “lupoid hepatitis”), defined by the detection of antinuclear antibodies. The term “lupoid” is used to stress the common feature (i.e., antinuclear antibodies) of this type of CAH and systemic lupus erythematosus. The antinuclear antibodies in autoimmune CAH are heterogeneous and are not directed against any specific nuclear antigen. In addition, autoantibodies to liver membrane antigens and to smooth muscle are also detected in patients with this type of CAH. The other types of autoimmune chronic active hepatitis are characterized by different patterns of detection of autoantibodies to smooth muscle, liver-kidney microsomal antigens, and soluble liver antigens.

The autoimmune form of CAH affects predominantly young or postmenopausal women. A genetic predisposition is suggested by the strong association with certain MHC antigens, particularly HLA-B1, B8, DRw3, and DRw4, which are also found in association with other autoimmune disorders. In addition, relatives may suffer from a variety of “autoimmune” diseases, such as thyroiditis, diabetes mellitus, autoimmune hemolytic anemia, and Sjögren’s syndrome. Evidence suggesting a dysregulation of the immune system in these patients includes marked hypergammaglobulinemia and detection of multiple autoantibodies.

Liver damage in all forms of CAH is believed to be the result of a cell-mediated immune response against altered hepatocyte membrane antigens. Both circulating and liver-derived lymphocytes from these patients have been shown to be cytotoxic for liver cells in vitro. Antibody-dependent cell-mediated cytotoxicity has also been suggested as playing a pathogenic role.

In the case of viral infections, the expression of viral proteins in the cell membrane of infected cells could be the initiating stimulus for the response. The trigger of most autoimmune forms of CAH remains unknown. In some cases, drugs, particularly α -methyl-dopa, may play the initiating role. α -Methyl-dopa is believed to modify membrane proteins of a variety of cells and induce immune responses that cross-react with native membrane proteins and perpetuate the damage, even after the drug has been removed.

The pathogenesis of cryptogenic CAH, in which there is no evidence of viral infection, exposure to drugs known to be associated with CAH, or autoimmune responses, remains unknown. It is possible that most of these cases are caused by an undetected viral infection or by exposure to an unsuspected drug or chemical agent.

The diagnosis of CAH is usually established by liver biopsy. Typically, the biopsy will reveal a picture of “piecemeal necrosis,” characterized by marked mononuclear cell

infiltration of the periportal spaces and/or paraseptal mesenchymal-parenchymal junctions, often expanding into the lobules. Plasma cells are often prominent in the infiltrate. There is also evidence of hepatocyte necrosis at the periphery of the lobules, with evidence of regeneration and fibrosis. It is believed that this picture reflects an immune attack of the infiltrating lymphocytes directed against the periportal and paraseptal lymphocytes. In one quarter to one half of the patients (depending on the study), evidence of postnecrotic cirrhosis is detected, and in some patients the evolution towards cirrhosis is progressive.

Treatment involves administration of glucocorticoids in the autoimmune forms and antiviral agents in cases associated with viral infection. α -Interferon administration seems beneficial for patients with viral CAH, who can complete several months of therapy without severe side effects. In some cases interferon administration is associated with the emergence of antinuclear antibodies, which usually disappear after therapy is discontinued, but rarely may evolve towards a complete picture of autoimmune CAH requiring glucocorticoid therapy.

VI. AUTOIMMUNE DISEASES OF THE NEUROMUSCULAR SYSTEMS

A. Myasthenia Gravis

Myasthenia gravis (MG) is a chronic autoimmune disease caused by a disorder of neuromuscular transmission. Two main pathological findings are characteristic of myasthenia gravis: (1) the production of antinicotinic acetylcholine receptor antibodies, detected in 85–90% of the patients, and (2) a 70–90% reduction in the number of acetylcholine receptors in the neuromuscular junctions.

The reduction in the number of acetylcholine receptors is believed to be due to their destruction by the immune system. This could be a consequence of direct cytotoxicity by complement, opsonization, ADCC, activation of phagocytic cells, or T-cell-mediated cytotoxicity. Cell-mediated immunity has been suggested as playing the major pathogenic role due to the lymphocytic infiltration often seen at the neuromuscular junction level, and because blast transformation can be achieved *in vitro* by stimulating T lymphocytes isolated from myasthenia gravis patients with acetylcholine receptor protein. However, the lymphocytic infiltrates are not detected in a significant number of patients clinically indistinguishable from those with infiltrates.

Thymic abnormalities are frequent in myasthenia gravis. Seventy percent of the patients have increased numbers of B-cell germinal centers within the thymus, which some authors have suggested to be the source of autoantibodies. About 10% of the patients develop malignant tumors of the thymus (thymomas).

The symptoms of myasthenia gravis are increased muscular fatigue and weakness, especially becoming evident with exercise. Weakness is usually first detected in extraocular muscles, resulting in diplopia or ptosis. The face, tongue, and upper extremities are also frequently involved. Skeletal muscle involvement is usually proximal. The disease is usually marked by spontaneous remission periods. The diagnosis is confirmed by the finding of anti-acetylcholine receptor antibodies.

Treatment is based on the administration of acetylcholinesterase inhibitors, such as neostigmine and pyridostigmine (Mestinon), in combination with atropine. Virtually complete or partial relief of symptoms can be achieved with medical treatment in a significant number of patients. Thymectomy is undertaken with improvement in 75% of patients and

with remission in the other 25%, although it may be several months after surgery when clinical improvement starts to be obvious. Those patients that do not respond to either form of therapy may be treated with glucocorticoids, which can induce clinical improvement in 60–100% of patients, depending on the series. Plasmapheresis and thoracic duct drainage can also be effective by removing circulating antibodies. However, the benefits of this type of therapy are very short-lived, unless the synthesis of autoantibodies is curtailed with glucocorticoids or immunosuppressive drugs.

B. Multiple Sclerosis

Multiple sclerosis (MS) is an autoimmune disease that results from the destruction of the myelin sheath in the central nervous system. MS lesions observed at autopsy are characterized by areas of myelin loss surrounding small veins in the deep white matter. A perivenous cuff of inflammatory cells is associated to acute lesions but is absent from old lesions where gliosis replaces myelin and the oligodendrocytes that produce and support it.

The inflammatory cells found in MS lesions are a mixture of T and B lymphocytes and macrophages (known as microglial cells in the central nervous system). The T lymphocytes are mostly CD4⁺, express IL-2R, and secrete IL-2 and IFN- γ . A smaller proportion of CD4⁺ lymphocytes produce IL-4 and IL-10, suggesting that T_H1 activity predominates over T_H2 activity. A few CD8⁺ lymphocytes are also present in the lesions. Several lines of evidence support the importance of T lymphocytes in the pathogenesis of MS:

1. Experimental allergic encephalomyelitis (EAE), the best animal model for MS, is transferred by CD4⁺ T lymphocytes but not by serum. Injection of T-cell clones specific for the immunodominant epitope of myelin basic protein (MBP) derived from sick animals is the most efficient protocol to transmit the disease to healthy animals.
2. MBP-specific CD4 clones can be established from lymphocytes isolated from the spinal fluid of MS patients. These clones generally recognize an epitope located at amino acids 87–99, but clones specific for other groups of 12 amino acids in the MBP molecule and to other myelin components, such as proteolipid protein and myelin-associated glycoprotein, are also expanded. Therefore, many different T-cell clones with different TcRs appear to be involved in the autoimmune response.

MS occurs mostly in young adults between the ages of 16 and 40 years with a 3-to-1 female predominance. It is more frequent in northern latitudes. In the United States it is more prevalent north of the Mason-Dixon line. In Europe, Scandinavian countries and Scotland have the highest incidence.

As in many other autoimmune diseases, the role of genetic factors was suggested by the finding that some HLA alleles are overrepresented among MS patients, particularly HLA-DR2 and HLA-DQ1, which are found in up to 70% of the patients. These class II MHC molecules are likely to be involved in peptide presentation to CD4⁺ lymphocytes. It has been demonstrated that normal individuals have myelin-specific T cells in their blood, suggesting that MBP-specific T lymphocytes are not deleted during differentiation, probably because myelin antigens are not expressed in the thymus. However, many of the normal individuals with myelin-specific T cells in their blood do not develop MS,

even when they are HLA-DR2. Thus, in normal individuals these clones remain in a state of anergy or tolerance.

Very little is known about what activates previously unreactive MBP-specific clones and other autoreactive clones involved in MS. Viral infections have been proposed as the trigger for MS, perhaps as a consequence of molecular mimicry. In fact, many viral antigens from corona viruses, Epstein-Barr virus, hepatitis B virus, herpes simplex virus, and others have sequences identical to MBP epitopes. Consequently, the immune response to the virus would activate cross-reactive sets of T cells recognizing peptides derived from myelin basic protein. Another possibility is that a viral superantigen could inadvertently activate MBP-specific T lymphocytes and cause their expansion.

In any case, autoreactive T lymphocytes, by themselves, are incapable of damaging the myelin sheath. However, autoreactive T lymphocytes secrete interferon- γ , which activates the macrophages found in the lesions. Some of these activated macrophages are seen attached to the myelin sheath, which they actively strip and phagocytose, becoming lipid laden. In addition, once they have engulfed myelin, they present myelin-derived antigens to T cells, contributing to the perpetuation of the immune reaction.

The clinical manifestations of MS are protean and often include visual abnormalities, abnormal reflexes, and sensory and motor abnormalities. This variety of manifestations reflects the fact that lesions can occur *anywhere* in the white matter of the brain, cerebellum, pons, or spinal cord at any time. The multiplicity and progression (both in number and extent) of MS lesions is the major clinical diagnostic criterion for this disease.

The course of MS is characterized by relapses and remissions in about 60% of the patients, but each new attack may bring additional deficits when the myelin sheaths are incompletely or imperfectly replaced. Frequently after 5–15 years of evolution these patients enter a phase of relentless chronic progression and become wheelchair bound, bedridden, and totally dependent for all activities of daily living. In the remaining 40% of the cases, MS is chronically progressive from the onset.

Confirmation of a diagnosis of MS is not easy. Magnetic resonance imaging (MRI) is an invaluable diagnostic tool. It demonstrates the breakdown of the blood-brain barrier that is always present at the beginning of a new attack and can also document the spatial dissemination of MS lesions. However, MRI abnormalities alone are not diagnostic, because several other diseases can be associated with similar abnormalities. Spinal fluid electrophoresis is another valuable diagnostic test, based on the detection of oligoclonal bands (multiple electrophoretically homogeneous bands) of IgG in the spinal fluid. It is not specific for multiple sclerosis, because this can be observed in other neurological illnesses associated with an intrathecal immune response.

The present treatment of MS is not satisfactory. Glucocorticoids have been used extensively during the past 20 years. Usually high doses are required (to seal the blood-brain barrier), not suitable for long-term administration. In addition, glucocorticoid administration does not affect significantly disease progression.

Recombinant interferon β 1b and the closely related interferon β 1a are recommended for the treatment of relapsing-remitting MS. These interferons act by downregulating IFN- γ production and class II expression on antigen-presenting cells. Interferon β administration has been shown to slow down the progression of MS.

Copolymer-1 (COP-1, Copaxone), a synthetic basic copolymer of four amino acids designed to resemble MBP epitopes, without the ability to induce T-cell proliferation, has been recently introduced with some success. Administration of this product reduces the frequency of relapses of MS, lessens disease activity as measured by MRI, and can induce

neurological improvement. Two mechanisms of action have been proposed for Copaxone based on studies carried out in experimental animals:

1. Cop 1 is a TCR antagonist of the immunodominant 82–100 epitope of MBP, thus turning off the immune response to MBP.
2. Oral Copaxone administration may lead to a tolerant state by downregulating T-cell immune responses to MBP. This effect is supposed to be mediated by IL-10–secreting regulatory T cells.

In humans, administration of Copaxone is associated with an elevation of serum IL-10 levels and profound changes in T lymphocyte activity, including suppression of the pro-inflammatory cytokine TNF mRNA, and elevation of the anti-inflammatory cytokines TGF- β and IL-4 mRNA. These results suggest that Copaxone may induce a shift from T_H1 to a regulatory T-cell cytokine profile, possibly associated with bystander suppression of the autoreactive immune response.

VII. AUTOIMMUNE DISEASES OF THE BLOOD CELLS

Virtually all types of blood cells can be affected by autoantibodies. Autoimmune hemolytic anemia (AHA) is discussed in detail in Chapter 22.

A. Autoimmune Neutropenia

A reduction of the total number of neutrophils is the most frequent cause of infection due to defective phagocytosis. Although there are congenital forms of neutropenia of variable severity, most frequently neutropenia is secondary to a variety of causes (see Table 17.3). Autoimmune neutropenia can be seen in patients with rheumatoid arthritis, usually in association with splenomegaly (Felty's syndrome).

B. Idiopathic Thrombocytopenic Purpura

Idiopathic thrombocytopenic purpura (ITP) is an autoimmune disease associated with low platelet counts (thrombocytopenia). The low platelet counts result from a shortened platelet half-life, usually caused by antiplatelet antibodies that cannot be compensated by increased release of platelets from the bone marrow.

Table 17.3 Causes of Neutropenia

I. Congenital
II. Secondary (acquired)
A. Depressed bone marrow granulocytosis
1. Drug-induced
2. Tumor invasion
3. Nutritional deficiency
4. Unknown cause (idiopathic)
B. Peripheral destruction of neutrophils
1. Autoimmune (Felty's syndrome) ^a
2. Drug-induced

^a An association of rheumatoid arthritis, splenomegaly, and neutropenia.

Antiplatelet autoantibodies have been detected in 60–70% of patients with the “immunoinjury” technique that relies on the release of platelet factors, such as serotonin, following exposure to sera containing such antibodies. Competitive binding assays and antiglobulin assays can also be used to demonstrate antiplatelet antibodies.

ITP can present as an acute or as a chronic form. Acute ITP is due to the formation of immune complexes containing viral antigens that become adsorbed to the platelets or to the production of antiviral antibodies that cross-react with platelets. Platelet destruction can be due to irreversible aggregation caused by immune complexes, or when antiplatelet antibodies are involved, or to complement-induced lysis or phagocytosis. Chronic ITP is caused by autoantibodies that react with platelets and lead to their destruction by phagocytosis.

Clinically, ITP is characterized by easy and exaggerated bleeding secondary to thrombocytopenia. Patients with ITP usually present with subcutaneous and mucosal bleeding. The subcutaneous bleeding is clinically described as petechiae or ecchymosis, appearing without obvious cause. When the bleeding is profuse, it will lead to the appearance of areas of purple discoloration, from which the designation of “purpura” derives. Epistaxis and gingival, genitourinary, and gastrointestinal tract bleeding are the common manifestations of mucosal bleeding.

The acute forms of ITP are seen mainly in children, often in the phase of recovery after a viral exanthem or an upper respiratory infection and is usually self-limited. In contrast, chronic ITP is an adult disease, often associated with other autoimmune diseases. The diagnosis is based on the platelet count, which in the acute form is usually less than $20,000/\text{mm}^3$, whereas in the chronic form the platelet counts range between $30,000$ and $100,000/\text{mm}^3$. The white cell count is usually normal. The bone marrow is also usually normal, but in some cases an increase in megakaryocytes may be seen, representing an attempt to compensate for the excessive destruction in the peripheral blood. The spleen may be enlarged due to platelet sequestration by phagocytic cells.

The treatment of ITP can be surgical or medical. Splenectomy is usually reserved for patients in whom the spleen is the major site for platelet sequestration and destruction. The removal of the spleen is often associated with prolonged platelet survival.

Glucocorticoids have been used in cases in which splenectomy is not indicated or has not been beneficial. However, the efficiency of glucocorticoids in severe cases of ITP is questionable.

In the last decade, administration of intravenous gammaglobulin has become the therapy of choice. It is associated with a prolongation of platelet survival and improvement in platelet counts. Several mechanisms have been proposed to explain this effect of intravenous gammaglobulin in ITP:

1. Competition with immune complexes for the binding to platelets (immune complexes would cause irreversible aggregation or complement-mediated cytolysis and intravenous gammaglobulin would not).
2. Blocking of Fc receptors in phagocytic cells, which would inhibit the ingestion and destruction of antibody-coated platelets (for which there is experimental documentation). This mechanism is most likely to explain the rapid increase in platelet counts seen after therapy with intravenous immunoglobulin is initiated.
3. The long-term, beneficial effects of intravenous gammaglobulin administration are apparently a consequence of the downregulation of autoreactive B cells caused by co-ligation of mlg (by anti-idiotypic antibodies reactive with the mlg of autoreactive B cells present in the IVIg) and FcII γ R (by the Fc region of IVIg). This co-ligation is believed to even be able to induce B-cell apoptosis. The end result is a decrease of the titers of antiplatelet antibodies.

SELF-EVALUATION

Questions

Choose the one *best* answer.

- 17.1 Which of the following characteristics best defines thyroid-stimulating antibodies?
- A. Activation of thyroid function after binding to the thyroglobulin receptor
 - B. Association with Graves' disease
 - C. Blocking the binding of TSH to its receptor
 - D. IgG isotype
 - E. Mimicking the effects of TSH upon binding to the TSH receptor
- 17.2 Which of the following genetic markers is associated with protection against the development of diabetes?
- A. Arginine at DQ α 52
 - B. Aspartic acid at DQ β 57
 - C. B27 positivity
 - D. D3/DR4 positivity
 - E. Valine at DQ β 57
- 17.3 What is believed to be the mechanism responsible for long-term therapeutic effect of intravenous gammaglobulin in patients with idiopathic thrombocytopenic purpura?
- A. Blockade of Fc receptors on phagocytic cells
 - B. Downregulation of autoreactive B cells
 - C. Inactivation of helper T cells
 - D. Induction of T cells with regulatory activity
 - E. Stimulation of megakaryocyte release from the bone marrow
- 17.4 Which of the following is believed to be the pathogenic mechanism of the neurological abnormalities associated with pernicious anemia?
- A. Abnormal synthesis of phospholipids and fatty acids
 - B. Autoimmune demyelination affecting both motor and sensory tracts
 - C. Lack of oxygen supply to the dorsal and lateral spinal tracts
 - D. Loss of acetylcholine receptors at the neuromuscular junctions
 - E. Progressive and multifocal degeneration of neural tissue
- 17.5 A patient develops jaundice and is found to have positive serologies for hepatitis B. Several weeks later the patient continues to have elevated liver enzymes and positive serologies and starts to complain of joint pains. Soon thereafter she develops hemorrhagic skin lesions in the lower extremities. Her platelet count is within normal limits. Which of the following mechanisms is most likely involved in the later manifestations of this patient's disease?
- A. Deposition of circulating immune complexes
 - B. Deposition of unconjugated bilirubin in tissues
 - C. Exacerbation of the liver disease by co-infection with hepatitis D virus
 - D. Production of antiviral antibodies cross-reactive with tissue antigens
 - E. Reaction of autoantibodies with tissue antigens

- 17.6 The use of immunosuppressive drugs in recently diagnosed type 1 diabetic patients is aimed at:
- A. Avoiding further destruction of islet cells by islet cell antibodies
 - B. Preventing further loss of islet cells due to cell-mediated cytotoxicity
 - C. Reducing the expression of “predisposing” MHC-II haplotypes
 - D. Reducing the synthesis of anti-insulin antibodies
 - E. Reducing the synthesis of anti-islet cell antibodies

In Questions 17.7–17.10 match each word or phrase with the lettered heading that is most closely related to it. The same heading may be selected once, more than once, or not at all.

- A. Glutamic acid decarboxylase (GAD) antibodies
 - B. Long-acting thyroid stimulator
 - C. Neutrophil antibodies
 - D. Nuclear antibodies
 - E. Thyroglobulin antibodies
- 17.7 Autoimmune chronic active hepatitis
 17.8 Felty’s syndrome
 17.9 Hashimoto’s thyroiditis
 17.10 Insulin-dependent diabetes mellitus

Answers

- 17.1 (E) All antibodies to the TSH receptor, including TSI and those antibodies devoid of stimulating effects, bind to the TSH receptor and block the binding of the hormone, which is the natural substrate for the receptor. In addition, TSI are so designed because they induce the same type of stimulating effects over thyroid cells as TSH.
- 17.2 (B) The presence of aspartic acid at DQ β 57 is associated with protection against the development of diabetes, probably by interfering with the binding of peptides associated with the autoimmune reaction against β cells.
- 17.3 (B) The long-term effects of intravenous gammaglobulin (IVIg) administration to patients with ITP are believed to result from the downregulation of autoreactive B cells caused by co-ligation of mlg (by anti-idiotypic antibodies reactive with the mlg of autoreactive B cells present in the IVIg) and FcII γ R (by the Fc region of IVIg). The end result is a decrease of the titers of antiplatelet antibodies. In contrast, the fast increase in platelet count seen in patients with ITP after therapy with intravenous gammaglobulin has been instituted is believed to be due to the blockade of the Fc receptors of reticuloendothelial phagocytic cells by the infused IgG.
- 17.4 (A) The neuropathy associated with pernicious anemia is secondary to demyelination caused by an abnormal synthesis of phospholipids and fatty acids affecting predominantly the dorsal and lateral spinal tracts.
- 17.5 (A) In hepatitis B–associated CAH, there is continuing synthesis and release of viral antigens, which become associated in circulation with the corresponding antibodies, forming soluble immune complexes that eventually can be trapped at the level of small vessels in the skin, kidneys, and joints, initiating inflammatory processes that lead to tissue damage.

- 17.6 (B) At the time of diagnosis of type I diabetes, there is active insulinitis, but not all islet cells are destroyed; often a brief spontaneous remission (honeymoon period) can be observed shortly after the initial diagnosis. The rationale for the use of immunosuppressive drugs at that time is to reduce the attack of cytotoxic cells to the β cells of the Langerhans islets, hoping to preserve their function and to avoid progression towards diabetes.
- 17.7 (D)
- 17.8 (C)
- 17.9 (E)
- 17.10 (A) One of the antigens recognized by islet cell antibodies characteristic of the prediabetic and early stages of insulin-dependent diabetes glutamic acid decarboxylase.

BIBLIOGRAPHY

- Amason, B. G. Immunologic therapy of multiple sclerosis. *Ann. Rev. Med.* 50:291, 1999.
- Amrani, A., Verdaguer, J., Thiessen, S., et al. IL-1 α , IL-1 β and IFN- γ mark β cells for Fas-dependent destruction by diabetogenic CD4+ T lymphocytes. *J. Clin. Invest.* 105:459, 2000.
- Ballow M. Is steroid-dependent asthma a disease treatable with intravenous immunoglobulin? *Clin. Immunol.* 91:123, 1999.
- Green, E. A. and Flavell, R. A. The initiation of autoimmune diabetes. *Curr. Opin. Immunol.* 11:663, 1999.
- Griffin, A. C., Zhao, W., Wegmann, K. W., and Hickley, W. F. Experimental autoimmune insulinitis. Induction by T lymphocytes specific for a peptide of proinsulin. *Am. J. Pathol.* 147:845, 1995.
- Lemark, A. Selecting culprits in β -cell killing. *J. Clin. Invest.* 104: 1487, 1999.
- Lindstrom, J., Shelton, D., and Fujii, Y. Myasthenia gravis. *Adv. Immunol.* 42:233, 1988.
- Mariotti, S., Chiovato, L., Vitti, P., Marcocci, C., Fenzi, G. F., Del Prete, G. F., Tiri, A., Romagnani, S., Ricci, M., and Pinchera, A. Recent advances in the understanding of humoral and cellular mechanisms implicated in thyroid autoimmune disorders. *Clin. Immunol. Immunopath.* 50:S73, 1989.
- McDougall, I. R. Graves' disease. Current concepts. *Med. Clin. North Am.* 75:79, 1991.
- Pozzilli, P., Visalli, N., Boccuni, M., et al. Randomized trial comparing nicotinamide and nicotinamide plus cyclosporine in recent onset insulin-dependent diabetes. *Diabetic Med.* 11:98, 1994.
- Rapoport, B. Pathophysiology of Hashimoto's thyroiditis and hypothyroidism. *Ann. Rev. Med.* 42:91, 1991.
- Ridgway, W. M., and Fatham, C. G. The association of MHC with autoimmune diseases: Understanding the pathogenesis of autoimmune diabetes. *Clin. Immun. Immunopath.* 86:3, 1998.
- Von Bohemer, H., and Sarukhan, A. GAD, a single autoantigen for diabetes. *Science*, 284:1135, 1999.
- Wong, F. S., Karttunen, J. Dumont, C., et al. Identification of an MHC class-I restricted autoantigen in type 1 diabetes by screening an organ-specific cDNA library. *Nature Med.* 5:1026, 1999.
- Wong, F. S., and Janeway Jr., C. A. Insulin-dependent diabetes mellitus and its animal models. *Curr. Opin. Immunol.* 11:643, 1999.

18

Systemic Lupus Erythematosus

George C. Tsokos and Jean-Michel Goust

I. INTRODUCTION

Systemic lupus erythematosus (SLE) is a generalized autoimmune disorder associated with multiple cellular and humoral immune abnormalities and protean clinical manifestations. It is most common in females of child-bearing age.

Case 18.1

A 25-year-female was taken to the emergency room by her husband after having a generalized seizure. When she regained consciousness, she gave a history of feeling tired over the previous 3 weeks, to the point that she was breathless and exhausted after climbing to her second floor apartment. She also complained of the progressive development of pain and stiffness in her wrists and fingers. She had noticed what looked like a bad sunburn on her cheeks and had been running a slight fever (99.9°F). Her past history was significant for two previous episodes of moderate wrist and finger pain that was relieved by aspirin. She had experienced two miscarriages in the past 3 years. Social history revealed that she did not smoke, drank only in moderation, and did not use recreational drugs. On physical examination this well-nourished female had a temperature of 101.5°F, pulse 90/min, BP 135/60, and weight 142 lb., representing a loss of 7 lb. in 3 weeks. She had what appeared to be a second-degree burn on her face. Hands and wrists were warm, painful to pressure, and had a limited range of motion that slowly increased with mobilization. Neurological examination revealed no evidence of a focal deficit. Optic fundi were normal. Remaining PE was unremarkable.

This case history raises the following questions:

What is the most likely explanation for this patient's fatigue and seizures?

Is there any likely relationship between her disease and the three miscarriages?

What is the pathogenesis of this patient's skin lesions?

What complications should one be most concerned about?

What test(s) would help confirm the diagnosis and evaluate the cause of this patient's symptoms?

What triggered this disease in this patient?

II. CLINICAL MANIFESTATIONS

The clinical expression of SLE varies among different patients. The kind of organ (vital vs. nonvital) that becomes involved determines the seriousness and the overall prognosis of the disease. The average frequency of some main clinical manifestations of SLE that may be observed during the entire course of SLE is shown in Table 18.1.

A. Diagnosis

The diagnosis is based on the verification that any four of the clinical and/or laboratory manifestations listed in Table 18.2 are present simultaneously or serially during a period of observation.

B. Course

Exacerbations and remissions, heralded by the appearance of new manifestations and worsening of preexisting symptoms, give the disease its fluctuating natural history. Although high levels of autoantibodies and low levels of serum complement (C3, C4) may accompany clinical disease activity, there is no laboratory marker as of yet that can reliably predict an upcoming flare.

C. Overlap Syndromes

Occasionally, physicians observe clinical situations in which the differentiation between SLE and another connective tissue disease is difficult. In some patients the distinction may

Table 18.1 Main Clinical Manifestation of SLE

Manifestation	% of patients
Musculoarticular	95
Renal disease	60
Pulmonary disease (pleurisy, pneumonitis)	60
Cutaneous disease (photosensitivity, alopecia, etc.)	80
Cardiac disease (pericarditis, endocarditis)	20
Fever of unknown origin	80
Gastrointestinal disease (hepatomegaly, ascites, etc.)	45
Hematological/Reticuloendothelial (anemia, leukopenia, splenomegaly)	85
Neuropsychiatric (organic brain syndrome, seizures, peripheral neuropathy, etc.)	20

Table 18.2 Diagnostic Features of Systemic Lupus Erythematosus^a

Facial erythema (butterfly rash)
Discoid lupus
Photosensitivity
Oral or nasopharyngeal ulcers
Arthritis without deformity
Pleuritis or pericarditis
Psychosis or seizures
Hemolytic anemia, leukopenia, lymphopenia, or thrombocytopenia
Heavy proteinuria or cellular casts in the urinary sediment
Positive lupus erythematosus cell preparation, positive anti-dsDNA, anti-Sm antibodies, false-positive syphilis serologies, positive anticardiolipin antibodies
Antinuclear antibody

^a Established by the American College of Rheumatologists.

be impossible, and they are classified as having an overlap syndrome. This syndrome represents the association of SLE with another disorder such as scleroderma or rheumatoid arthritis. On the other hand, some patients have symptoms and laboratory findings that are reminiscent of lupus, yet a formal diagnosis (defined by the criteria listed in Table 18.2) cannot be made. Patients who take certain drugs (hydralazine, procainamide, etc.) may present with an incomplete picture of lupus known as drug-induced lupus. Other patients may present with an incomplete picture of lupus that may remain stable over a period of years or evolve with the appearance of additional manifestations.

III. IMMUNOLOGICAL ABNORMALITIES IN SLE

A. Autoantibodies

The LE cell is a peculiar-looking polymorphonuclear leukocyte, which has ingested nuclear material. It was possible to reproduce this phenomenon in vitro by incubating normal neutrophils with damaged leukocytes preincubated with sera obtained from SLE patients. Investigations concerning the nature of this phenomenon led to the discovery that antibodies directed to nuclei could promote the formation of LE cells and subsequently to the definition of a heterogeneous group of antinuclear antibodies.

Antinuclear antibodies (ANAs) are detected by an indirect immunofluorescence assay using a variety of tissues and cell lines as substrates. A positive result is indicated by the observation of nuclear fluorescence after incubating the cells with the patient's serum and, after thorough washing to remove unbound immunoglobulins, with an antihuman immunoglobulin serum. Four patterns of fluorescence can be seen indicating different types of antinuclear antibodies (see Table 18.3). The test for antinuclear antibodies is not very specific but is very sensitive. A negative result virtually excludes the diagnosis of SLE (95% of patients with SLE are ANA positive), while high titers are strongly suggestive of SLE but not confirmatory, since ANAs can be detected in other conditions including other systemic autoimmune/collagen diseases and chronic infections.

DNA antibodies are the most important in SLE. They can react with single-stranded DNA (ssDNA) or with double-stranded DNA (dsDNA). Two thirds of patients with SLE have circulating anti-DNA antibodies. Although anti-ssDNA may be found in many dis-

Table 18.3 Immunofluorescence Patterns of Antinuclear Antibodies

Pattern	Antigen	Disease association(s)
Peripheral	Double-stranded DNA	SLE
Homogeneous	DNA-histone complexes	SLE and other connective tissue diseases
Speckled	Non-DNA nuclear antigens	
	Sm	SLE
	ribonucleoprotein	Mixed connective tissue disease, SLE, scleroderma, etc.
	SS-A, SS-B	Sjögren's disease
Nucleolar	Nucleolus-specific RNA	Scleroderma

eases besides SLE, anti-dsDNA antibodies are found almost exclusively in SLE (40–60% of the patients). Most are commonly detected by immunofluorescence using as a substrate a noninfectious flagellate, *Crithidia lucilliae*, which has a kinetoplast packed with double-stranded DNA (see Chapter 15). This test is very specific, and the antibodies can be semi-quantitated by titration of the serum (to determine the highest serum dilution associated with visible fluorescence of the kinetoplast after addition of a fluorescent-labeled anti-IgG antibody). Most laboratories use enzyme-linked immunosorbent assays to detect DNA antibodies.

Antibodies to the DNA-histone complex are present in over 65% of patients with SLE. The use of enzyme-linked immunosorbent assays (ELISAs) has permitted the identification of antibodies to all histone proteins including H1, H2A, H2B, H3, and H4. Antihistone antibodies are also present in patients with drug-induced SLE, most frequently associated with hydralazine and procainamide therapies.

Antibodies to nonhistone proteins have been studied intensely lately. The nonhistones against which antibodies have been described include:

Anti-Sm. Antibodies to the Sm antigen are present in one third of patients with SLE.

Sm antibodies have not been found in other conditions. The antigenic determinant is on a protein that is conjugated to one of six different small nuclear RNAs (snRNA).

Anti-U1-RNP. The antigenic epitope is on a protein conjugated to U1-RNA. Antibodies to this antigen are present in the majority of patients with SLE and in mixed connective tissue disease, which represents an overlap syndrome.

Anti-SS-A/Ro. These antibodies are present in one third of patients with SLE and two thirds of patients with Sjögren's syndrome (SS). Antibodies to the Ro antigen are frequently found in patients with SLE who are ANA-negative. Babies born to mothers with Ro antibodies may have heart block, leukopenia, and/or skin rash.

Anti-SS-B/La. The antigenic epitope recognized by this antibody is on a 43 kDa protein conjugated to RNA. Antibodies to La antigen are present in about one third of patients with SLE and in approximately one half of the patients with Sjögren's syndrome.

Patients with SLE frequently have antiphospholipid antibodies and anticardiolipin antibodies. The anticardiolipin antibodies recognize a cryptic epitope on β 2-glycoprotein I

that is exposed after it binds to anionic phospholipids. A related group of antibodies are the phospholipid antibodies that react with phospholipids and are apparently implicated as one of the causes of clotting disorders in SLE.

SLE patients may present with bleeding disorders, which in some cases are secondary to autoimmune thrombocytopenia and in others seem to be caused by heterogeneous collection of antibodies to clotting factors, known as lupus anticoagulant. Some of these antibodies seem to recognize complexes of phospholipids and clotting factors (e.g., prothrombin), thus overlapping with the phospholipid antibodies.

B. The Pathogenic Role of Autoantibodies in SLE

Classically, it has been accepted that autoantibodies do not play the initiating role in the pathogenesis of SLE. On the other hand, it is accepted that autoantibodies are likely to either play an important role as cofactors in the pathogenesis of the disease or play a direct role in the pathogenesis of some of the manifestations of the disease. This dogma, based on the belief that autoantibodies cannot enter living cells, has recently been challenged. Not only can anti-RNP, anti-DNA, and anti-Ro enter live cells, but they also can induce apoptosis. Thus, the concepts about the pathogenic role of autoantibodies are likely to change in the future.

1. T-cell antibodies are believed to bind and eliminate certain subsets of T cells (suppressor-inducer); as a consequence, the normal negative feedback circuits controlling B-cell activity may not be operational, explaining the uncontrolled production of autoantibodies by the B cells.
2. Antibodies against CR1 (complement receptor 1) and against the C3 convertase are occasionally detected. CR1 antibodies may block the receptor and interfere with the clearance of immune complexes. Antibodies to the C3 convertase, by stimulating its function, may contribute to increased C3 consumption.
3. Anti-red cell antibodies and antiplatelet antibodies are the cause, respectively, of hemolytic anemia and thrombocytopenia.
4. Autoantibodies directed against central nervous system (CNS) antigens may be detected in the serum and the cerebrospinal fluid of patients with SLE who have CNS involvement and have also been considered, but not proven, pathogenic.
5. DNA antibodies form immune complexes by reacting with DNA and are implicated in the pathogenesis of glomerulonephritis (see below).
6. Cardiolipin antibodies, phospholipid antibodies, and lupus anticoagulant are detected frequently in SLE patients. The cardiolipin antibodies cause false positivity in serological tests for syphilis. Cardiolipin and phospholipid antibodies are also associated with miscarriages, thrombophlebitis, thrombocytopenia, and various central nervous system manifestations secondary to vascular thrombosis. The constellation of these symptoms is known as phospholipid antibody syndrome, and although it was first recognized in lupus patients, the majority of the cases do not fulfill the diagnostic criteria for SLE.
7. Ro antibodies, when present in mothers with SLE, seem to be associated with the development of heart block in their babies.

C. The Diagnostic Value of Autoantibodies

Some autoantibodies may not be linked with any specific clinical manifestations but are very useful as disease markers. For example, dsDNA and Sm antibodies are diagnostic of SLE. Most other autoantibodies are present in more than one clinical disease or syndrome. However, even if many of the patients share some common immunological abnormalities, particularly the presence of antinuclear antibodies or of rheumatoid factor, specific disorders can usually be individualized by the presence of a specific set of autoantibodies.

IV. PATHOGENESIS OF SLE

Multiple environmental, hormonal, genetic, and immunoregulatory factors are involved in the expression of the disease. In any given patient, different factors contribute variably to the expression of the disease.

A. Genetic Factors

The understanding of the pathogenic mechanisms underlying the progression of SLE has been facilitated by the discovery of spontaneously occurring disease in mice that resembles SLE in many respects. During the inbreeding of mice, it was observed that the F₁ (first-generation) hybrids obtained by mating black and white mice from New Zealand [(NZB × NZW) F₁] spontaneously developed a systemic autoimmune disease involving a variety of organs and systems. Throughout the course of their disease, the mice develop hypergammaglobulinemia, reflecting a state of hyperactivation of the humoral immune system. The animals have a variety of autoantibodies and manifestations of autoimmune disease and immune complex disease similar to those seen in humans with SLE. As the disease progresses, they develop nephritis and lymphoproliferative disorders and die.

The importance of genetic factors in the development of disease in NZB mice is underlined by the observation that the parental NZB mice have a mild form of the disease manifested by autoimmune hemolytic anemia, but that the introduction of the NZW genetic background made the disease accelerate and worsen. Genetic linkage studies and microsatellite gene marker analysis indicate that many of the immunological abnormalities are under multigenic control, one gene(s) controlling the animal's ability to produce anti-DNA antibodies, another the presence of antierythrocyte antibodies, and still other genes controlling high levels of IgM production and lymphocytic proliferation.

Two other mouse strains that develop a SLE-like disease spontaneously have been identified: MRL *lpr/lpr* and MRL *gld*. The first strain has a defect in the Fas gene, whereas the second has a defect in the Fas ligand gene. The products of these two genes are responsible for the programmed cell death of cells also known as apoptosis, which is critical for the control of undesirable immune responses. Only rare patients with lupus have structural defects of the Fas/Fas ligand proteins.

Several pieces of evidence indicate that genetic factors also play a role in the pathogenesis of human SLE. Serum DNA and T-cell antibodies as well as cellular abnormalities are present in healthy relatives of lupus patients. There is moderate degree of clinical disease concordance among monozygotic twins. The fact that the clinical concordance between twins is only moderate strongly indicates that genetic factors alone may not lead to the expression of the disease and that other factors are needed. The genes that could play a

role, probably in synergy with environmental factors, have not been identified. Current evidence indicates that in humans, as in mice, these genes are probably linked to the MHC. For example, the HLA-DR2 haplotype is overrepresented in patients with SLE. Also, as mentioned before, an SLE-like disease develops frequently in individuals with C4 and C2 deficiencies (C4 and C2 genes are located in chromosome 6, in close proximity to the MHC genes). Also, individuals lacking C1q are also prone in developing lupus. Recently, genome-wide searches for “lupus” genes have been undertaken. These studies have reported various genome areas to be associated with lupus. Interestingly, many of these areas are found in 6p and 1q.

B. Immune Response Abnormalities

SLE is a disease associated with profound immunoregulatory abnormalities, affecting both humoral and cell-mediated responses.

1. B-Cell Abnormalities

Increased numbers of B cells and plasma cells are detected in the bone marrow and peripheral lymphoid tissues secreting immunoglobulins spontaneously. The number of these cells correlates with disease activity. Only a limited number of light and heavy-chain genes are used by autoantibodies, demonstrating that the autoantibody response involves only a few of all B-cell clones available. Furthermore, the changes appearing in their sequence over time strongly suggest that they undergo affinity maturation, a process that requires T-cell help. It also suggests that a few antigens drive the response. Immunosuppressive drug treatment of both murine and human lupus causes clinical improvement associated with decreased B-cell activity. Any infection that induces B-cell activation is likely to cause a clinical relapse in patients with inactive SLE.

2. T-Cell Abnormalities

From our knowledge of the biology of the immune response, it can be assumed that the production of high titers of IgG anti-dsDNA antibodies in patients with SLE must depend upon excessive T-cell help and/or insufficient control by suppressor T cells. Support for this theory is provided by the following observations:

1. In both human and murine lupus, a new subset of CD3⁺ cells that express neither CD4 nor CD8 has been found to provide help to autologous B cells synthesizing DNA antibodies.
2. The finding of anti-T-cell antibodies in the serum of (NZB × NZW) F₁ mice and in the sera of humans with SLE raised the possibility that the deletion of a specific subset of regulatory cells could contribute to the inordinate B-cell activity associated with the development of autoimmunity. Obviously, defective suppressor T-cell function could enhance the helper T-cell-mediated B-cell overactivity.
3. In humans, anti-T-cell antibodies are also responsible for the lymphopenia that is frequently seen in patients with SLE. This lymphopenia is often associated with findings suggestive of a generalized depression of cell-mediated immunity, such as decreased lymphokine production (IL-1 and IL-2) and lack of reactivity (anergy) both in vivo and in vitro to common recall antigens, particularly during

active phases of human SLE. The impairment of cell-mediated immunity may explain the increased risk of severe opportunistic infections in patients with SLE.

4. Extensive deletions in the T-cell repertoire have been found in NZW mice in which the $C\beta_2$ and $D\beta_2$ genes of the T-cell antigen receptor are missing. These deletions could be associated with a faulty establishment of tolerance to self-MHC during intrathymic ontogeny.
5. In humans, restriction fragment length polymorphism studies of the constant region of the TcR demonstrated an association between TcR α chain polymorphism and SLE and TcR β chain polymorphism and production of anti-Ro antibodies. More recently, sequence information of the TCR chains of pathogenic human T-cell clones demonstrated bias in the T-cell repertoire selection process, whose meaning is still to be defined. The immune response is thus "oligoclonal" in both T and B compartments.

C. Immune Complexes in SLE

The pathogenic role of immune complexes (IC) in SLE has been well established. As summarized in Figure 18.1, this pathogenic role is a result of a variety of abnormal circumstances.

First, marked elevations in the levels of circulating immune complexes can be detected in patients with SLE sera during acute episodes of the disease by a variety of techniques (see Chapter 23). Since patients with active SLE have high levels of free circulating DNA and most also have DNA antibodies, DNA-anti-DNA IC are likely to be formed either in circulation or in collagen-rich tissues and structures such as the glomerular basement membrane, which have avidity for DNA.

Besides the fact that immune complexes are formed at increased rates in patients with SLE, the clearance rate of circulating immune complexes is decreased. Several factors seem to contribute to the impaired clearance of immune complexes:

1. Immune complexes are cleared by the Fc receptor bearing cells of the reticuloendothelial system. This function has been found to be decreased in patients with SLE. Many patients with lupus nephritis have alleles of Fc receptors that bind IgG with less avidity.
2. Immune complexes often have adsorbed complement components and split products, including C3b, which reacts with CR1. Consequently, IC are transported to the reticuloendothelial system by red blood cells, which bind them through their CR1. Patients with SLE have decreased numbers of CR1, a fact that may compromise the clearance of immune complexes and contribute to the development of IC-induced inflammatory reactions.
3. Immune complexes are partially solubilized as a consequence of complement activation, a process that contributes to their inactivation and clearance. Individuals with C4 deficiency develop a disease with clinical features resembling those of SLE. This observation can be explained by the fact that immune complexes are cleared at slower rates in C4-deficient individuals, perhaps due to the role of C4 fragments in the solubilization and clearance of circulating immune complexes.

The pro-inflammatory properties of immune complexes in SLE are suggested by a variety of observations. First, rising levels of DNA antibodies in conjunction with falling serum C3 levels (reflecting consumption by antigen-antibody complexes) are associated

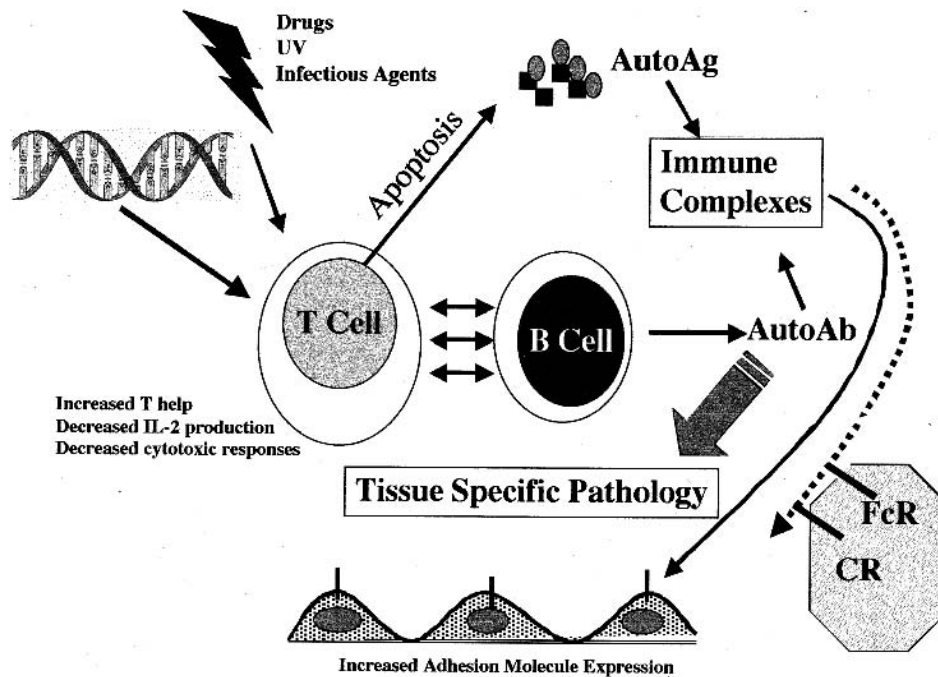

Fig. 18.1 Diagrammatic overview of the pathogenesis of systemic lupus erythematosus: multiple genetic, environmental, and hormonal factors influence the function of T and B lymphocytes. T cells display a wide spectrum of abnormalities including decreased cytotoxic responses and increased ability to help B cells produce antibodies. Lupus B cells with the help of T cells produce autoantibodies that bind to autoantigens found on cells and tissues and others released in the circulation by apoptotic cells. The resulting immune complexes are not cleared effectively because, besides the fact that they are produced at increased rates, the receptors that are responsible for their clearance, i.e., Fc and complement receptors, are deficient either in number or in function. Once deposited in tissues, immune complexes initiate a cascade that eventually results in tissue injury (see Chapter 23).

with disease flares. Second, patients with IgG1 and IgG3 (complement fixing) DNA antibodies develop lupus nephritis more frequently than do patients in whom DNA antibodies are of other isotypes. Glomerulonephritis, cutaneous vasculitis, arthritis, and some of the neurological manifestations of SLE are fully explainable by the development of local inflammatory lesions secondary to the formation or deposition of IC. What remains unclear is whether tissue-fixed IC are circulating IC that eventually become deposited in tissues or if they result from the formation of antigen-antibody complexes in situ.

In SLE patients, immune complex deposits have also been noted on the dermo-epidermal junction of both inflamed skin and normal skin, appearing as a fluorescent “band” when a skin biopsy is studied by immunofluorescence with anti-sera to immunoglobulins and complement components (band test).

D. Glomerulonephritis

Immunofluorescence studies indicate that the capillary tufts of renal glomeruli in patients with lupus nephritis contain deposits of immunoglobulins and complement. Several lines

of evidence support the conclusion that those deposits represent immune complexes and that these IC are likely to play a primary pathogenic role.

Elution studies have shown that DNA and DNA antibodies are present in these deposits, confirming that they correspond to antigen-antibody complexes. The deposition of IC in the glomerular basement membrane can be explained in three different ways:

1. Deposition of soluble, circulating IC (as discussed in Chapter 23).
2. Formation of immune complexes in situ. DNA has affinity to glomerular basement membranes and, once immobilized, may react with circulating DNA antibodies to form antigen-antibody complexes.
3. Cross-reaction of DNA antibodies with collagen and cytoskeleton proteins.

Currently in situ formation of DNA-anti-DNA immune complexes appears as the most likely initiating event, but regardless of how they are formed, IC in the basement membrane are considered nephritogenic because they may activate complement and cause inflammation.

The pathogenic role of IC deposited in the kidney is supported by the fact that there is ample evidence for complement activation via the classic and the alternative pathway in patients with active nephritis. Circulating levels of C3 and C4 are usually decreased, whereas plasma levels of complement breakdown products such as C3a, C3d, and Bb are increased. C1q, C3b, and complement split products such as C3d, C3bi, and C3c can be detected attached to circulating immune complexes.

E. Nonimmune Factors Influencing the Course of SLE

In addition and in close interplay with genetic and immunological factors, a variety of other factors have an apparent effect on the evolution of the disease.

1. Hormonal Effects

The expression of the genetic and immunological abnormalities characteristic of murine lupus-like disease is influenced by female sex hormones. For example, in (NZB×NZW) F1 mice, the disease is more severe in females. Administration of estrogens aggravates the evolution of the disease, which is only seen in castrated male mice and not in complete males.

The extent of the hormonal involvement in human SLE cannot be proven directly, but the large female predominance (9:1 female-to-male ratio) as well as the influence of puberty and pregnancies at the onset of the disease, or the severity of the disease's manifestations, indicates that sex hormones play a role in the modulation of the disease. Recent investigations suggest that estradiol causes an increased expression of calcineurin, which could lead to increased synthesis of pro-inflammatory cytokines, particularly of the T_H2 group. This could lead to an exaggeration of humoral immunity abnormalities during pregnancy, which in turn could exacerbate the inflammatory processes secondary to IC formation.

2. Environmental Factors

Several environmental insults have been related to the onset or relapse of SLE. Sunlight exposure was the first environmental factor influencing the clinical evolution of human SLE to be identified. Exposure to sunlight may precede the clinical expression of the disease or disease relapse. This could be related to the fact that the Langerhans cells of the skin and

keratinocytes release significant amounts of interleukin-1 upon exposure to UV light and could thus represent the initial stimulus tipping off a precarious balance of the immune system.

Infections also seem to play a role. The normal immune response to bacterial and viral infections may spin off into a state of B-cell hyperactivity, triggering a relapse.

Drugs, particularly those with DNA-binding ability, such as hydantoin, isoniazide, and hydralazine, can cause a drug-induced lupus-like syndrome. These drugs are known to cause DNA hypomethylation. Because hypomethylated genes are transcribed at higher rates, it is theoretically possible that they cause SLE by increasing the transcription rate of genes involved in the expression of the disease. ANA antibodies appear in 15–70% of patients treated with any of these drugs for several weeks. These ANA antibodies belong, in most cases, to the IgM class and react with histones. Only when the antibodies switch from IgM to IgG does the patient become symptomatic. These ANA usually disappear after termination of the treatment. Patients with drug-induced SLE usually have a milder disease, without significant vital organ involvement.

Case 18.1 Revisited

The patient's fatigue could just be a reflection of a systemic inflammatory disease but could also be due to anemia. Hemolytic anemia is not infrequent in SLE. Seizures and other neurological symptoms may be due to (1) deposition of immune complexes in CNS tissues, (2) binding of antineuronal autoantibodies, with or without complement activation, (3) the effect of infiltrating autoreactive T cells, or (4) the effects of neurotoxins (such as quinolinic acid) released by activated immune cells.

Patients with SLE often develop antiphospholipid antibodies. Although the exact pathogenic sequence is not known, these antibodies interfere with clotting factors, causing vascular thrombosis usually without vasculitis.

The pathogenesis of skin lesions is likely to involve several factors. Deposition of IC at the dermo-epidermal junction is likely to play a role, but not the only one, since this deposition can be observed in normal skin. Exposure to sunlight is likely to play a significant role as well, perhaps because the Langerhans cells and keratinocytes of the skin release significant amounts of interleukin-1 upon exposure to UV light. This could represent an additional trigger to a local inflammatory reaction, involving both the effects of UV exposure and the effects of IC deposition.

In this patient, several complications would cause concern: autoimmune hemolytic anemia may be extremely difficult to treat, and the progression of her CNS involvement would also raise considerable therapeutic problems. In addition, deterioration of kidney function due to the development of lupus nephritis is always a major concern in any patient with SLE.

This patient presented with several clinical features typical of SLE: facial erythema, arthritis, seizures, and possible anemia. The detection of autoantibodies such as those directed against dsDNA or the Sm antigen would be confirmatory, but even if only nonspecific antinuclear antibodies were detected, a diagnosis of SLE should still be entertained. To evaluate the cause of some of the most striking symptoms of this patient, it would be indicated to perform a complete blood count, and if anemia was present, Coombs' tests should be ordered. Other important tests to be ordered include x-rays of the hands, rheumatoid factor, anticardiolipin and antiphospholipid antibodies, serum creatinine, and urine protein (to evaluate kidney function).

One of the most difficult questions to answer is what triggers the onset of an autoimmune disease. This patient fits in the age and sex group in which SLE is more prevalent. In addition to hormonal influences, it is likely that this patient carries a genetic predisposition to develop SLE (although the precise marker and nature of such predisposition are not yet clearly identified). Most unclear of all is what was the initial stimulus. An infection leading to cross-reactive autoimmunity is a very appealing hypothesis, but we have no clue about the nature of such infection.

V. TREATMENT

Improvement of our understanding of the pathogenesis of SLE has led to reasonable therapeutic strategies that have improved dramatically the well-being and life expectancy of patients with SLE, whose survival rate at 10 years is now 80%. The therapeutic approach to each patient is determined by the extent of the disease and, most importantly, by the nature and extent of organ involvement. Careful avoidance of factors implicated in the induction of relapses—high-risk medications, exposure to sunlight, infections, etc.—is always indicated, but in most cases administration of anti-inflammatory and immunosuppressive drugs is essential.

Corticosteroids combine anti-inflammatory effects with a weak immunosuppressive capacity. The anti-inflammatory effect is probably beneficial in disease manifestations secondary to immune complex deposition, while the immunosuppressive effect may help to curtail the activity of the B-cell system.

Nonsteroidal anti-inflammatory drugs are frequently used to control arthritis and serositis.

In patients with vital organ involvement (i.e., glomerulonephritis, CNS involvement), immunosuppressive drugs may be indicated. Cyclophosphamide, given intravenously, has been successfully used to prolong adequate renal function with few side effects. Maximal benefit is achieved when long-term treatment is started early, with relatively good renal function. In some patients, clinical effects require the administration of high (nonablative) doses of cyclophosphamide.

A number of experimental therapeutic approaches have been used, or are under study, in patients with SLE. These new approaches capitalize on information that has been generated from the study of the pathogenesis of the disease.

As discussed earlier, much of the produced autoantibody is the result of cognate interaction between helper T cells and B lymphocytes. Therefore, the interruption of this interaction by either humanized antibodies (see Chapter 24) or recombinant downregulating ligands (recombinant molecules constituted by the binding site of a molecule that delivers downregulating signals and the Fc portion of IgG to prolong serum half-life) is expected to have therapeutic value. Such reagents include anti-CD40 ligand antibody and the CTLA4-Ig.

Since levels of IL-10 have been found to be increased in the sera of patients with lupus and because IL-10 promotes B-cell function, ongoing trials will determine the value of anti-IL-10 antibody in the treatment of human lupus.

Complement activation mediates significant pathology in human lupus. An anti-C5 antibody that disrupts complement activation is currently in clinical trials to determine its role in the treatment of lupus.

Additional trials will determine the possibility of curing, lupus or setting back the lupus clock, by ablating (by means of administration of large doses of cytotoxic drugs or total body irradiation) the patient's own immune system and reinfusing autologous hematopoietic stem cells.

SELF-EVALUATION

Questions

Choose the one *best* answer.

- 18.1 High titers of circulating anti-dsDNA in the serum of patients who have systemic lupus erythematosus are:
- A. Associated with the formation of mixed cryoglobulins
 - B. Frequently associated with hemolytic anemia
 - C. Predictors of the development of inflammatory complications
 - D. Rarely associated with high titers of antinuclear factor
 - E. Suggestive of a drug-induced etiology

Questions 18.2–18.3 refer to the following case history: A 28-year-old woman has a history of weight loss, intermittent fever and pains in several joints, mainly hands, wrists, and knees. Physical examination shows an erythematosus rash on the malar regions and enlarged, nontender, lymph nodes in the axillary and inguinal regions. Laboratory tests showed anemia, a positive indirect Coombs' test, positive antinuclear antibodies, and proteinuria (3 g/24 h).

- 18.2 The proteinuria in this patient is likely to result from:
- A. Bacterial infections
 - B. Idiopathic glomerulonephritis
 - C. Inflammation triggered by autoantibodies reactive with the glomerular basement membrane
 - D. Tubular damage secondary to hemolysis
 - E. Type III hypersensitivity reaction at the glomerular level
- 18.3 Which of the following antibody assays would be most valuable from the diagnostic point of view?
- A. Anti-dsDNA
 - B. Anti-nuclear antibodies (diffuse pattern)
 - C. Rheumatoid factor
 - D. Anti-SS-A
 - E. Anticentromere antibodies
- 18.4 The exaggerated synthesis of autoantibodies in SLE is believed to result from:
- A. Excessive activity of CD4⁺ helper lymphocytes
 - B. Genetic abnormalities resulting in the overexpression of TCR able to react with autologous DNA
 - C. Massive stimulation of the immune system by bacterial DNA
 - D. The exaggerated release of interleukins-1 and -2 during the active states of the disease

- E. Uncontrolled activation of B lymphocytes
- 18.5 A direct immunofluorescence study of a normal skin biopsy obtained from a patient with systemic lupus erythematosus (SLE) using fluorescein-labeled antihuman IgG antiserum shows deposition of irregularly stained material at the dermo-epidermal junction. This result is considered as indicative of the presence of:
- A. Antinuclear antibodies (ANA)
 - B. Anticollagen antibodies
 - C. Antielastin antibodies
 - D. Antiepithelial antibodies
 - E. Antigen-antibody complexes
- 18.6 Soluble immune complexes with highest potential pathogenicity are likely to have the following characteristic(s):
- A. Contain IgG1 antibodies
 - B. Be formed in antibody excess
 - C. Contain ssDNA
 - D. Contain IgM antibodies
 - E. Be of extremely large size
- 18.7 Phospholipid antibodies in SLE are associated with:
- A. Autoimmune hemolytic anemia
 - B. Central nervous system involvement
 - C. Congenital heart block
 - D. False-positive serologies for Lyme disease
 - E. Thrombophlebitis
- 18.8 The pathogenic role of DNA antibodies has best been proven in association to:
- A. Pleurisy
 - B. Hemolytic anemia
 - C. Cutaneous vasculitis
 - D. Glomerulonephritis
 - E. Pericarditis
- 18.9 Of the four known patterns of fluorescence observed in positive nuclear antibody, which is more specific for SLE?
- A. Homogeneous
 - B. Nucleolar
 - C. Peripheral
 - D. Speckled
- 18.10 The detection of a sudden decrease in circulating levels of C3 in a patient with SLE is indicative of:
- A. Complement deficiency as an underlying etiological factor
 - B. Efficiency of anti-inflammatory medications
 - C. Increased disease activity
 - D. Increased levels of circulating immune complexes
 - E. Renal damage

Answers

- 18.1 (C) Soluble IC formed at slight antigen excess between dsDNA and its corresponding antibody appears to play the main pathogenic role in SLE-

associated glomerulonephritis and other inflammatory complications. Mixed cryoglobulins usually correspond to cold-precipitable immune complexes involving a first antibody (IgG or IgA) and a second anti-immunoglobulin antibody (IgM in most cases) and are more frequently observed in patients with chronic infections or rheumatoid arthritis than in SLE patients.

- 18.2 (E) The sum of clinical and laboratory data in this patient is strongly suggestive of SLE. In those patients, proteinuria is usually caused by glomerulonephritis secondary to the deposition of immune complexes in (or around) the basement membrane. Anti-basement membrane antibodies can also cause glomerulonephritis, but these antibodies are found in Goodpasture's syndrome and not in SLE. The hemolytic anemia in SLE is usually due to extravascular hemolysis (the anti-RBC antibodies are of the IgG isotype, not very efficient in causing intravascular hemolysis).
- 18.3 (A) Anti-dsDNA antibodies are virtually diagnostic of SLE.
- 18.4 (E) The production of autoantibodies in SLE (both human and experimental) is secondary to a state of hyperactivation of B cells, which is partly due to autocrine or paracrine B-cell stimulation, increased help from a poorly characterized double negative T-cell subpopulation, and decreased activity of regulatory T cells.
- 18.5 (E) The study described in this question is known as the "band test," and a positive result is considered as indicating the deposition of antigen-antibody complexes at the dermo-epidermal junction.
- 18.6 (A) IgG1 is complement-fixing and able to interact with the Fc receptors of phagocytic cells; both properties appear to be important in the induction of inflammatory changes secondary to IC deposition.
- 18.7 (B) The presence of phospholipid antibodies is associated with miscarriages, thrombophlebitis, thrombocytopenia, and false positivity in serological tests for syphilis (not Lyme disease). Anti-Ro antibodies are passively transmitted transplacentally from mothers with SLE, which seem associated with the development of heart block in newborns.
- 18.8 (D)
- 18.9 (C) The pattern of peripheral fluorescence corresponds to the existence of dsDNA antibodies, which are specific for SLE.
- 18.10 (C) A sudden decrease of C3 indicates excessive consumption associated with intensification of an inflammatory process. It does not indicate whether the inflammatory process is located in the kidneys or elsewhere. Increased levels of circulating IC do not necessarily cause significant complement activation. C3 levels only correlate with circulating IC levels in situations such as acute serum sickness, when not only are there high levels of soluble complexes, but the IC are trapped in tissues and cause inflammatory reactions as a consequence of complement activation.

BIBLIOGRAPHY

Boumpas, D. T., Fessler, B. J., Austin, H. A., 3rd, Balow, J. E., Klippel, J. H., Lockshin, M. D. Systemic lupus erythematosus: emerging concepts. Part 1: Renal, neuropsychiatric, cardiovascu-

- lar, pulmonary, and hematologic disease. *Ann. Intern. Med.* 121:940, 1995; Part 2: Dermatologic and joint disease, the antiphospholipid antibody syndrome, pregnancy and hormonal therapy, morbidity and mortality, and pathogenesis. *Ann. Intern. Med.* 123:42, 1995.
- Fox, R. I. Sjögren's syndrome. *Curr. Opin. Rheumatol.* 7:409, 1995.
- Hess, E. V., and Farhey, Y. Etiology, environmental relationships, epidemiology, and genetics of systemic lupus erythematosus. *Curr. Opin. Rheumatol.* 7:371, 1995.
- Kammer, G. K., and Tsokos, G. C., eds. *Lupus; Molecular and Cellular Pathogenesis*. Humana Press, Totowa, NJ, 1999.
- Kammer, G. K., and Tsokos, G. C. Emerging concepts of the molecular basis for estrogen effects on T lymphocytes in systemic lupus erythematosus. *Clin. Immunol. Immunopath.* 89:192, 1998.
- Radic, M. Z., and Weigert, M. Genetic and structural evidence for antigen selection of anti-DNA antibodies. *Ann. Rev. Immunol.* 12:487, 1994.
- Swadzba, J., De Clerck, L. S., Stevens, W. J., et al. Anticardiolipin, anti-beta(2)-glycoprotein I, antiprothrombin antibodies, and lupus anticoagulant in patients with systemic lupus erythematosus with a history of thrombosis. *J. Rheumatol.* 24:1710, 1997.
- Tan, F. J., Chan, E. K. L., Sullivan, K. F., and Rubin, R. L. Antinuclear antibodies (ANAs): Diagnostically specific immune markers and clues toward the understanding of systemic autoimmunity. *Clin. Immunol. Immunopathol.* 47:121, 1988.
- Theofilopoulos, A. N. The basis of autoimmunity: Part I. Mechanisms of aberrant self-recognition. *Immunol. Today* 16:90-98, 1995. Part II. Genetic predisposition. *Immunol. Today* 16:150, 1995.
- Tsokos, G. C., and Boumpas, D. T. Human systemic lupus erythematosus. In *Molecular Aspects of Autoimmunity*. Gordon and Breach/Harwood Academic Publishers, Langhorne, PA, 2000.
- Wallace, D. Systemic lupus erythematosus. *Sci. Med.* 6:18, 1999.

19

Rheumatoid Arthritis

Jean-Michel Goust and Gabriel Virella

I. INTRODUCTION

Rheumatoid arthritis (RA) is a chronic autoimmune disease characterized by inflammatory and degenerative lesions of the distal joints, frequently associated with multiorgan involvement. This disease affects just under 1% of the population and its etiology is complex; immunological, genetic, and hormonal factors are thought to determine its development. Rheumatoid arthritis waxes and wanes for many years, but the attacks progressively run into one another, setting the stage for the chronic form of the disease, which is associated with deformity and functional impairment.

Case 19.1

A 28-year-old married African American seeks medical attention because of exacerbation of joint pains. She had been diagnosed as having rheumatoid arthritis 4 years earlier. She had been doing very well during her second pregnancy and delivered her son 6 months ago, but during the past 2 months started to suffer from progressively severe pains affecting her hands, feet, and right knee. The pain is particularly severe in the morning but decreases around noon. She has been taking ibuprofen since the beginning of her last relapse, but the medication seems to have lost its effectiveness. On examination, the mucosa appear slightly pale and the distal joints of both hands are swollen, erythematous, and warm. There is a moderate amount of synovial fluid in the right knee. The spleen is palpable 3 cm below the rib cage. A subcutaneous nodule is visible just below the left elbow. The rest of the physical examination is within normal limits. A hemogram shows a red cell count of $3.9 \times$

377

$10^6/\text{mm}^3$, white blood cell count of $5200/\text{mm}^3$ with 20% neutrophils and 70% lymphocytes. Hematocrit was 38%, hemoglobin 11 g/dL. A rheumatoid factor titer was 2560 and antinuclear antibodies were positive (homogeneous pattern, titer of 320). X-rays of the hand showed cartilage erosion and fluid in the distal phalanges of both hands.

This case history raises the following questions:

Should the diagnosis of rheumatoid arthritis be revised because of the positive antinuclear antibody assay?

What is the significance of the low neutrophil count in this patient's blood?

What is the pathogenesis of the joint lesions?

Is the subcutaneous nodule seen below the left elbow related to rheumatoid arthritis?

Why did the patient do better during pregnancy?

Should the therapy be modified?

II. CLINICAL AND PATHOLOGICAL ASPECTS OF RHEUMATOID ARTHRITIS

A. Localized Disease: Clinical Presentation

A chronic inflammatory process of the joints that progresses through different stages of increasing severity (Table 19.1) characterizes rheumatoid arthritis. The damage is reversible until cartilage and bones become involved (stages 4 and 5). At that time the changes become irreversible and result in severe functional impairment.

The most common clinical presentation of rheumatoid arthritis is the association of pain, swelling, and stiffness of the metacarpophalangeal and wrist joints, often associated with pain in the sole of the foot, indicating metatarso-phalangeal involvement. The disease is initially limited to small distal joints. With time, rheumatoid arthritis progresses from the distal to the proximal joints so that in the late stages, joints such as the ankles, knees, and elbows may become affected.

B. Pathological Manifestations of Localized Disease

In the early stages the inflammatory lesion is limited to the lining of the normal diarthrodial joint. A thin membrane composed of two types of synoviocytes, the type A synovio-

Table 19.1 Stages of Rheumatoid Arthritis

Stage	Pathological process	Symptoms	Physical signs
1	Antigen presentation to T lymphocytes	None	None
2	Proliferation of T and B lymphocytes	Malaise, mild joint stiffness	Swelling of small joints
3	Neutrophils in synovial fluid; synovial cell proliferation	Joint pain and morning stiffness, malaise	Swelling of small joints
4	Invasive pannus; degradation of cartilage	Joint pain and morning stiffness, malaise	Swelling of small joints
5	Invasive pannus; degradation of cartilage; bone erosion	Joint pain and morning stiffness malaise	Swelling of small joints; deformities

cyte, which is a phagocytic cell of the monocyte-macrophage series with a rapid turnover, and the type B synoviocyte, which is believed to be a specialized fibroblast, constitutes the normal synovial lining. This cellular lining sits on top of a loose acellular stroma that contains many capillaries.

The earliest pathological changes, seen at the time of the initial symptoms, affect the endothelium of the microvasculature, whose permeability is increased, as judged by the development of edema and of a sparse inflammatory infiltrate of the edematous subsynovial space, in which polymorphonuclear leukocytes predominate. Several weeks later, hyperplasia of the synovial lining cells and perivascular lymphocytic infiltrates can be detected.

In the chronic stage, the size and number of the synovial lining cells increases and the synovial membrane takes a villous appearance. There is also subintimal hypertrophy with massive infiltration by lymphocytes, plasmablasts, and granulation tissue, forming what is known as pannus. This thick pannus behaves like a tumor and in the ensuing months and years continues to grow, protruding into the joint. The synovial space becomes filled by exudative fluid, and this progressive inflammation causes pain and limits motion. With time, the cartilage is eroded and there is progressive destruction of bones and tendons, leading to severe limitation of movement, flexion contractures, and severe mechanical deformities.

C. Systemic Involvement: Clinical Presentation

It is common to observe some signs and symptoms more indicative of a systemic disease, particularly those that are indicative of vasculitis. The most frequent sign is the formation of the rheumatoid nodules over pressure areas, such as the elbows. These nodules are an important clinical feature because, with rare exceptions, they are pathognomonic of RA in patients with chronic synovitis and generally indicate a poor prognosis.

D. Systemic Involvement: Pathological Manifestations

In contrast with the necrotizing vasculitis associated with systemic lupus erythematosus (SLE), due almost exclusively to immune complex deposition, the vasculitis seen in rheumatoid arthritis is associated with granuloma formation. This indicates that cell-mediated immune processes are also likely involved. Regardless of the exact pathogenesis of the vasculitic process, rheumatoid patients with vasculitis usually have persistently elevated levels of circulating immune complexes and, generally, a worse prognosis.

Histopathological studies of rheumatoid nodules show fibrinoid necrosis at the center of the nodule surrounded by histiocytes arranged in a radial palisade. The central necrotic areas are believed to be the seat of immune complex formation or deposition. When the disease has been present for some time, small brown spots may be noticed around the nailbed or associated with nodules. These indicate small areas of endarteritis.

E. The Overlap Syndrome

The overlap syndrome describes a clinical condition in which patients show variable degrees of association of rheumatoid arthritis and systemic lupus erythematosus. The existence of this syndrome suggests that the demarcation between SLE and RA is not absolute, resulting in a clinical continuum between both disorders.

Clinically these patients present features of both diseases. Histopathological studies also show lesions characteristic of the two basic pathological components of RA and SLE

(necrotizing vasculitis and granulomatous reactions). Serological studies in patients with the overlap syndrome demonstrate both antibodies characteristically found in SLE (e.g., anti-dsDNA) and antibodies typical of RA (rheumatoid factor, see below).

F. Other Related Diseases

Sjögren's syndrome can present as an isolated entity or in association with rheumatoid arthritis, SLE, and other collagen diseases. It is characterized by dryness of the oral and ocular membranes (sicca syndrome), and the detection of rheumatoid factor is considered almost essential for the diagnosis, even for those cases without clinical manifestations suggestive of rheumatoid arthritis.

Felty's syndrome is an association of rheumatoid arthritis with neutropenia caused by antineutrophil antibodies. The spleen is often enlarged, possibly reflecting its involvement in the elimination of antibody-coated neutrophils.

III. AUTOANTIBODIES IN RHEUMATOID ARTHRITIS

A. Rheumatoid Factor and Anti-immunoglobulin Antibodies

The serological hallmark of rheumatoid arthritis is the detection of rheumatoid factor (RF) and other anti-immunoglobulin (Ig) antibodies. By definition, classical RF is an IgM antibody to autologous IgG. The more encompassing designation of anti-immunoglobulin antibodies is applicable to anti-IgG antibodies of IgG or IgA isotypes. As a rule, the affinity of IgM rheumatoid factor for the IgG molecule is relatively low and does not reach the mean affinity of other IgM antibodies generated during an induced primary immune response.

Rheumatoid factors from different individuals show different antibody specificity, reacting with different determinants of the IgG molecule. In most cases, the antigenic determinants recognized by the antigen-binding sites of these IgM antibodies are located in the C_{γ2} and C_{γ3} domains of IgG; some of these determinants are allotype-related. Circulating RF reacts mostly with IgG1, IgG2, and IgG4; in contrast, RF detected in synovial fluid react more frequently with IgG3 than with any other IgG subclasses. The significance of these differences is unknown, but they suggest that different B-cell clones may produce circulating RF and synovial RF. Other RF react with determinants that are shared between species, a fact that explains the reactivity of the human RF with rabbit IgG as well as with IgG from other mammals.

The frequent finding of RF reactive with several IgG subclasses in a single patient suggests that the autoimmune response leading to the production of the RF is polyclonal. This is supported by the fact the idiotypes of RF are heterogeneous, being obviously the product of several different V-region genes.

1. *Methods Used for the Detection of Rheumatoid Factor*

Rheumatoid factor and anti-Ig antibodies can be detected in the serum of affected patients by a variety of techniques.

The Rose-Waaler test is a passive hemagglutination test which uses sheep or human erythrocytes coated with anti-erythrocyte antibodies as indicators. The agglutination of the IgG-coated red cells to titers greater than 16 or 20 is considered indicative of the presence of RF. These tests detect mostly the classic IgM rheumatoid factor specific for IgG.

The latex agglutination test employs IgG-coated polystyrene particles mixed with serum suspected of containing RF or anti-Ig antibodies (see Chapter 15). The agglutination

of latex particles by serum dilutions greater than 1:20 is considered a positive result. This test detects anti-immunoglobulin antibodies of all isotypes.

2. *Diagnostic Specificity of Anti-immunoglobulin Antibodies*

As with many other autoantibodies, the titers of RF are a continuous variable within the population studied. Thus, any level intending to separate the seropositive from the seronegative is arbitrarily chosen to include as many patients with clinically defined RA in the seropositive group, while excluding from it as many nonrheumatoid subjects as possible.

Even with these caveats, RF is neither specific nor diagnostic of RA. First, it is found in only 70–85% of RA cases, while it can be detected in many other conditions, particularly in patients suffering from Sjögren's syndrome. Also, RF screening tests can be positive in as many as 5% of apparently normal individuals, sharing the same V-region idiotypes (and by implication, the same V-region genes) as the antibodies detected in RA patients.

3. *Physiological Role of Anti-immunoglobulin Antibodies*

The finding of RF in normal individuals indicates that RF may have a normal, physiological role, such as to ensure the rapid removal of infectious antigen-antibody complexes from circulation. The synthesis of anti-Ig antibodies in normal individuals follows some interesting rules:

1. Anti-Ig antibodies are detected transiently during anamnestic responses to common vaccines and, in these cases, are usually reactive with the dominant immunoglobulin isotype of the antibodies produced in response to antigenic stimulation.
2. Anti-Ig antibodies are also found in relatively high titers in diseases associated with persistent formation of antigen-antibody complexes such as subacute bacterial endocarditis, tuberculosis, leprosy, and many parasitic diseases.
3. The titers of vaccination-associated RF follow very closely the variations in titer of the specific antibodies induced by the vaccine; similarly, the levels of RF detected in patients with infections associated with persistently elevated levels of circulating immune complexes decline once the infection has been successfully treated. In contrast, the anti-immunoglobulin antibodies detected in patients with rheumatoid arthritis persist indefinitely, reflecting their origin as part of an autoimmune response.
4. Infection-associated RF binds to IgG molecules whose configuration has been altered as a consequence of binding to exogenous antigens. The resulting RF-IgG-Ag complexes are large and quickly cleared from circulation. The adsorption of IgG to latex particles seems to induce a similar conformational alteration of the IgG molecule as antigen-binding, and as a result IgG-coated latex particles can also be used to detect this type of RF.

The transient nature of anti-Ig antibodies in normal individuals suggests that the autoreactive clones responsible for the production of autoantibodies to human immunoglobulins are not deleted during embryonic differentiation. The persistence in adult life of such autoreactive clones is supported by the observation that the bone marrow contains precursors of RF-producing B cells. Their frequency is surprisingly high in mice, where it is relatively easy to induce the production of RF in high titers after polyclonal B-cell stimulation. Human bone marrow B lymphocytes can also be stimulated to differentiate into RF-producing plasmablasts by mitogenic stimulation with PWM or by infection with Epstein-Barr virus. In addition, tolerance to self-IgG must be ensured by a strong negative feedback mechanism(s), since tolerance is broken only temporarily.

4. *Phenotype of B-Cell Precursors of RF-Producing Plasmablasts*

In mice and in humans, B lymphocytes capable of differentiating into RF-producing plasmablasts express CD5 in addition to the classical B-cell markers, such as membrane IgM and IgD, CR2, CD19, and CD20. CD5, expressed by less than 2% of the B lymphocytes of a normal individual, was first detected in patients suffering from very active rheumatoid arthritis. It is considered a marker characteristic of autoimmune situations.

5. *Pathogenic Role of Rheumatoid Factor and Anti-immunoglobulin Antibodies*

RF titers are highly variable, even in patients with full-blown RA, and do not seem to correlate very closely with the activity of the disease. However, high titers of RF tend to be associated with a more rapid progression of the articular component and with systemic manifestations, such as subcutaneous nodules, vasculitis, intractable skin ulcers, neuropathy, and Felty's syndrome. Thus, the detection of RF in high titers in a patient with symptomatic RA is associated with a poor prognosis.

The pathogenic properties of RF are likely to be derived from the biological characteristics of the antibodies involved. Classical IgM RF activates complement via the classical pathway, and the ability of RF to fix complement is of pathogenic significance, because it may be responsible, at least in part, for the development of rheumatoid synovitis.

The source of the anti-Ig antibodies that are likely to play an important role in causing arthritic lesions is predominantly the synovium of the affected joints. The joints are the principal sites of RF production in RA patients, and it should also be noted that in some individuals the locally produced anti-Ig antibodies are of the IgG isotype. When this is the case, the joint disease is usually more severe, because anti-IgG antibodies of the IgG isotype have a higher affinity for IgG than their IgM counterparts; consequently, they form stable immune complexes, which activate complement very efficiently.

6. *Seronegative Rheumatoid Arthritis*

Some patients with RA may have negative results on the screening tests for RA. True seronegative RA cases exist, particularly among agammaglobulinemic patients. In spite of their inability to synthesize antibodies, these patients develop a disease clinically indistinguishable from RF-positive rheumatoid arthritis. This is a highly significant observation since it argues strongly against the role of the RF or other serological abnormalities as a major pathogenic insult in rheumatoid arthritis and suggests that the inflammatory response in the rheumatoid joint could be largely cell mediated. However, in many instances negative serologies in patients with RA are falsely negative. Three different mechanisms may account for false-negative results in the RA test:

1. Anti-Ig antibodies of isotypes other than IgM, less efficient than IgM RF in causing agglutination (particularly in tests using red cells) and therefore more likely to be overlooked, may be present.
2. The reaction between IgG RF and endogenous IgG results in the formation of soluble immune complexes that, if the affinity of the reaction is relatively high, will remain associated when the RF test is performed. Under these conditions, the RF-binding sites are blocked, unable to react with the IgG coating indicator red cells or latex particles
3. RF may be present in synovial fluid but not in peripheral blood.

In clinical practice, it is very seldom necessary to investigate these possibilities, since a positive test is not necessary for the diagnosis.

B. Anticollagen Antibodies

Antibodies reacting with different types of collagen have been detected with considerable frequency in connective tissue diseases such as scleroderma. In rheumatoid arthritis, considerable interest has been aroused by the finding that antibodies elicited by injection of type II collagen with complete Freund's adjuvant into rats are associated with the development of a rheumatoid-type disease. However, the frequency of these antibodies in RA patients has been recently estimated to be in the 15–20% range, which is not compatible with a primary pathogenic role. It is probable that the anticollagen antibodies in RA arise as a response to the degradation of articular collagen that could yield immunogenic peptides.

C. Antinuclear Antibodies

Antibodies against native, double-stranded DNA are conspicuously lacking in patients with classical RA, but antibodies against single-stranded DNA can be detected in about one third of the patients. The epitopes recognized by anti-ssDNA antibodies correspond to DNA-associated proteins. The detection of anti-ssDNA antibodies does not have diagnostic or prognostic significance because these antibodies are neither disease-specific nor involved in immune complex formation.

The reasons for the common occurrence of anti-ssDNA in RA and in many other connective tissue diseases are unknown. However, these antibodies may represent an indicator of immune abnormalities due to the persistence of abnormal B-lymphocyte clones that have escaped the repression exerted by normal tolerogenic mechanisms and that are able to produce autoantibodies of various types.

IV. GENETIC FACTORS IN RHEUMATOID ARTHRITIS

A. HLA Associations

The incidence of familial rheumatoid arthritis is low, and only 15% of the identical twins are concordant for the disease. However, 70–90% of Caucasians with rheumatoid arthritis express the HLA DR4 antigen that is found in about 15–25% of the normal population. Individuals expressing this antigen are 6–12 times more at risk of having RA, but HLA-DR1 was also found to increase susceptibility to RA and wide fluctuations in the frequency of these markers are seen between different patient populations.

B. HLA-DR4 Subtypes

DNA sequencing of the β chain of the DR4 and DR1 molecules defined five HLA-DR4 subtypes: Dw4, Dw10, Dw13, Dw14, and Dw15. While Dw4, Dw10, Dw13, and Dw15 differ from each other in amino acid sequence at positions 67, 70, and 74 of the third hyper-variable region of the β 1 domain of the β chain, Dw4 and Dw14 have identical amino acid sequences at these positions and are associated with RA. The same amino acids are present in the Dw1 subtype of HLA-DR1. The prevalence of Dw4, Dw14, or Dw1 in the general population is 42%. Of these individuals, 2.2% develop RA. In contrast, the frequency of RA in individuals negative for these markers is only 0.17%, a 12.9-fold difference. Since most humans are heterozygous, a given individual may inherit more than one susceptibility allele. Individuals having both Dw4 and Dw14 have a much higher risk (seven to one)

Table 19.2 HLA-DR Subtypes and Rheumatoid Arthritis

Subtype	Critical residues on the 3rd diversity region of β 1				Predisposition to rheumatoid arthritis
	67	70	71	74	
DRB1*0101 (Dw1)	L	Q	R	A	+
DRB1*0401 (Dw4)	L	Q	K	A	+
DRB1*0404 (Dw14)	L	Q	R	A	+
DRB1*0403 (Dw13)	L	Q	R	E	-
DRB1*0402 (Dw10)	I	D	E	A	-

A = Ala; D = Asp; E = Glu; I = Isoleu; K = Lys; L, Leu; Q, Gln; R, Arg.

of developing severe RA. In contrast, individuals with the Dw10 and Dw13 markers, whose sequence differs in the critical residues (Table 19.2), seem protected against RA.

The interpretation of these findings hinges on the fact that amino acids 67 to 74 are located on the third hypervariable region of the DR4 and DR1 β chains. This region is part of a helical region of the peptide-binding pouch of the DR β chain (see Chapter 3) that interacts both with the side chains of antigenic peptides and with the TcR. Its configuration, rather than the configuration of any other of the hypervariable regions of the DR4 and DR1 β chains, seems to determine susceptibility or resistance to RA, depending on the charge of amino acids located on critical positions. In the case of Dw1 and Dw14 the sequence of the 70–74 motif is identical (QRRAA), while the homologous sequence in Dw4 (QKRAA) shows one single substitution (a basic arginine by an equally basic lysine). In contrast, the sequence of the same stretch of amino acids in protective alleles shows a higher degree of divergence. In Dw10 aspartic acid and glutamic acid replace the first two amino acids (glutamine and arginine or lysine), resulting in a total change in the charge and affinity of the peptide-binding pouch. In the case of Dw13, glutamic acid replaces alanine at position 74, again resulting in a marked charge difference relatively to Dw1, 4, and 14.

It has been postulated that the structure of those DR4 and DR1 molecules associated with increased risk for the development of RA is such that they bind very strongly an “arthritogenic epitope” derived from an as yet unidentified agent. Bacterial antigens, including heat shock proteins, microbial proteins from *Proteus mirabilis*, Epstein-Barr virus, or retroviruses, as well as autologous proteins such as type II collagen or cartilage glycoprotein gp39 have been proposed as candidate sources for these peptides. The consequence of the binding of immunogenic peptides would be a strong and prolonged immune response that would be the basis of the inflammatory response in the joints. Obviously, the predominant localization of the inflammatory reaction to the peri-articular tissues implies that the level of expression of the peptides in question must be higher in those tissues. The reverse would be the case for those DR4 molecules associated with protection against the development of RA.

Supporting this interpretation are several observations concerning the severity of the disease in patients bearing those HLA antigens and subtypes. For example, DR4 positivity reaches 96% in patients suffering from Felty’s syndrome, the most severe form of the disease. More recent studies showed that RA patients who are DR4-Dw14 positive have a faster progression to the stages of pannus formation and bone erosion.

The most significant discrepancy in this apparent consensus sequence between DR sequence and RA susceptibility was found in African Americans with RA; in this group,

only 20% are DR4⁺. In this ethnic group predisposition and severity appear independent of the presence and dose of the “arthritogenic” DR alleles identified in Caucasians.

V. CELL-MEDIATED IMMUNITY ABNORMALITIES IN RHEUMATOID ARTHRITIS

It is accepted that cell-mediated immune mechanisms play the main pathogenic role in rheumatoid arthritis. This conclusion is based on studies performed in the synovial fluid and on the hypertrophic synovium of the rheumatoid joints, both easily accessible to study by needle biopsy or aspiration. All the essential cellular elements of the immune response are present in the joint, and the main challenge is to reconstitute the sequence of events that leads to the progressive destruction of joint tissues.

A. Role of T Lymphocytes

Immunohistological studies of the inflammatory infiltrates of the synovial membrane show marked lymphocytic predominance (lymphocytes may represent up to 60% of the total tis-

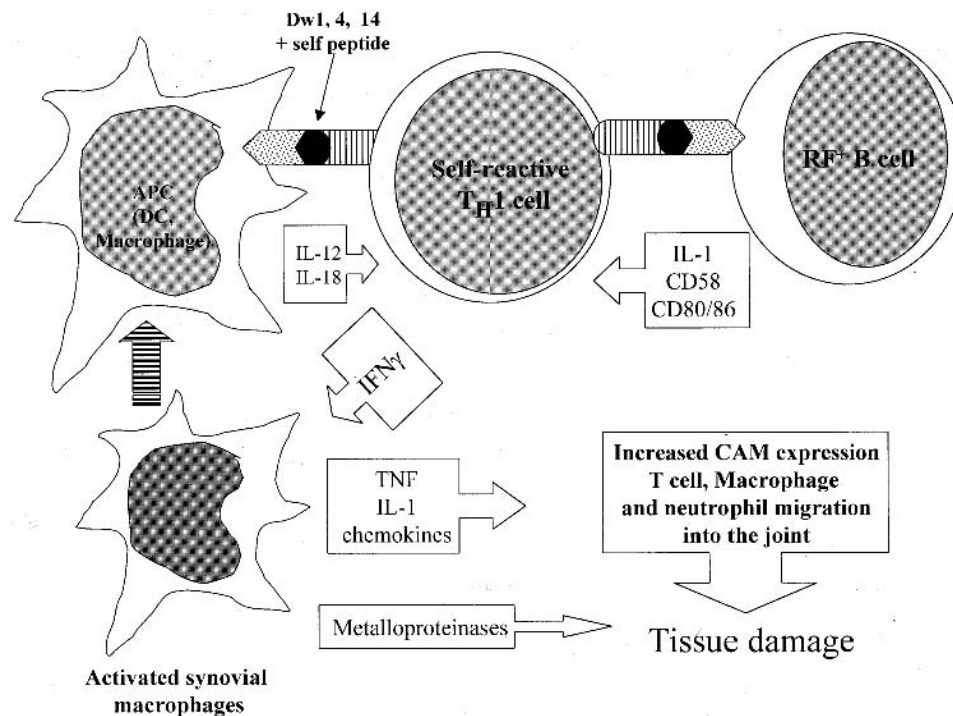

Fig. 19.1 Diagrammatic representation of the pathogenesis of rheumatoid arthritis. In this diagram it is postulated that T_H1 lymphocytes play the central role in the sequence of events that leads to the activation of synovial macrophages, which is the main effector system mobilized by this helper T-cell subpopulation. Not shown in the diagram is the role of RF as the mediator for complement and neutrophil-mediated articular and extrarticular inflammation.

sue net weight). Among the lymphocytes infiltrating the synovium, CD4⁺ helper T lymphocytes outnumber CD8⁺ lymphocytes in a ratio of 5:1. The critical pathogenic role for T_H lymphocytes is suggested by two important observations:

1. Rheumatoid arthritis is associated with specific DR alleles (see below), and it is well accepted that MHC-II molecules present immunogenic peptides to T_H lymphocytes
2. Increased concentrations of many lymphocyte-released cytokines are measurable in the synovial fluid, probably reflecting the activated state of infiltrating lymphocytes.

Most of the infiltrating CD4⁺ lymphocytes have the phenotype of a terminally differentiated memory helper T cell (CD4⁺, CD45RO⁺), which represent 20–30% of the mononuclear cells in the synovium. They also express class II MHC, consistent with chronic T-cell activation, but only 10% express CD25, suggesting that they do not proliferate actively in the synovial tissues. In situ hybridization studies performed in biopsies of synovial tissue obtained at late stages of the disease disclosed that these chronically activated T cells express mRNAs for IL-2, IFN- γ , IL-7, IL-13, IL-15, and GM-CSF. One conspicuously missing interleukin is IL-4, suggesting that the CD4⁺, CD45RO⁺ T lymphocytes in the synovial tissues are predominantly of the T_H1 type, which produce predominantly IL-2 and IFN- γ . A variety of chemokines (RANTES, MIP1- α , MIP1- β , and IL-8), most of which are produced by lymphocytes, can also be detected in the synovial fluid. These chemokines are probably responsible for the attraction of additional T lymphocytes, monocytes, and neutrophils to the rheumatoid joint. T cells in the RA synovium also express CD40L, and are, therefore, able to deliver co-stimulating signals to B cells and dendritic cells (see below).

A most significant question that remains unanswered involves the nature of the stimulus responsible for the activation of the T lymphocytes found in the synovial infiltrates. Studies of the TcR V β genes expressed by the infiltrating T lymphocytes have shown that the repertoire is limited, i.e., only some T-cell clones appear to be activated, and the same clones are found in several joints of the same patient. An even more restricted profile was observed when the analysis was confined to the antigen-binding area of the V β chain (the so-called CDR3 region). These findings suggest that antigenic stimulation through the TcR plays a critical role. However, a defined correlation between the V β chains expressed by the infiltrating T lymphocytes and the patient's MHC-II alleles has not yet been found. Such a correlation is expected because of the role played by the MHC molecules in selecting the T-cell repertoire of any given individual (see Chapter 10). Thus, HLA-linked RA susceptibility alleles could introduce a first bias in TcR selection, but there is no evidence supporting this hypothesis.

The long-term goal of these approaches—to identify the actual targets of the immune attack—remains elusive at this time. A major obstacle is our limited knowledge about the immunogenic peptides recognized by different TcR V β -region families. Until some breakthrough happens in that area, our understanding will remain fragmentary and highly speculative.

B. Antigen Presentation and the Dendritic Cells

The autoimmune response that underlies the pathogenesis of RA is mostly localized to the synovial tissue and fluid in the synovial space. Fully differentiated dendritic cells can be

found in the synovial tissue, surrounding small vessels and in close association with T cells and B-cell follicles. These dendritic cells (DC) appear to be derived from circulating precursors, attracted to the synovium by chemokines such as MIP-1 α , MCP, and RANTES (see Chapter 11), a process made possible by the expression of CAMs induced by TNF and IL-1. On reaching the synovium, DC undergo differentiation and activation under the influence of T cells expressing the CD40L and of some of the cytokines present in high concentrations in the synovial fluid, such as GM-CSF, TNF, and IL-1. Their differentiation in the synovium seems associated with an increased ability to present self antigen and, therefore, to stimulate autoimmune responses. Activated and differentiated DC are also known to secrete IL-18, which, as discussed below, has pro-inflammatory activity, synergizes with IL-12 in the expansion of T_H1 cells, and induces the synthesis and release of interferon- γ by activated T_H1 cells.

C. B Cells as Local Amplifiers of the Autoimmune Response

B cells expressing RF on their membrane can be found in the synovium of chronically inflamed joints. These RF⁺ B cells can bind immune complexes by the Fc portion of the antibodies, a process that results in B-cell activation and peptide presentation to T cells. In this role as APCs, RF⁺ B cells can activate multiple T-cell clones recognizing a wide variety of endogenous and exogenous peptides internalized as IC. Thus, RF⁺ B cells amplify intrasynovium immune responses and contribute to the exacerbation of the local inflammatory process.

D. The Multiple Roles of Synovium Macrophages

The synovial infiltrates are rich in activated monocytes, macrophages, and macrophage-derived synoviocytes, which are believed to play several critical pathogenic roles. One of the significant roles played by these cells is antigen presentation to CD4⁺ lymphocytes. It is not unusual to see macrophage-lymphocyte clusters in the inflamed synovial tissue and in those clusters, CD4⁺ lymphocytes are in very close contact with large macrophages expressing high levels of class II MHC antigens. In addition, IL-12 and IL-18 mRNA and secreted IL-12 and IL-18 are found at biologically active concentrations and could play an important role in T_H1 expansion and differentiation.

The other critical role of synovial monocytes and macrophages is to induce and perpetuate local inflammatory changes. Several lines of evidence support this role. First, the synovial fluid of patients with RA contains relatively large concentrations of phospholipase A₂ (PLA₂), an enzyme that has a strong chemotactic effect on lymphocytes and monocytes. Moreover, this enzyme is actively involved in the metabolism of cell membrane phospholipids, particularly in the early stages of the cyclooxygenase pathway, which leads to the synthesis of eicosanoids such as the prostaglandin PGE₂, one of a series of pro-inflammatory mediators generated from the breakdown of arachidonic acid. Thus, it is possible that these high levels of PLA₂ reflect a hyperactive state of infiltrating macrophages engaged in the synthesis of PGE₂ and other eicosanoids. Other factors locally released by activated macrophages include transforming growth factor- β (TGF- β), GM-CSF, and interleukin-18.

TGF- β further contributes to the predominance of T_H1 activity over T_H2 activity at the inflammatory sites.

GM-CSF induces the proliferation of several cell types in the monocyte-macrophage family, including dendritic cells. It has been suggested that this overproduction of GM-CSF

by all CD4 cells (macrophages and T lymphocytes) is responsible for the relatively large number of dendritic cells found in the inflammatory lesion. This is a significant finding, because activated dendritic cells release a variety of pro-inflammatory lymphokines, such as IL-1. Another prominent role of GM-CSF is to be a very strong inducer of the expression of MHC-II molecules (stronger than interferon- γ). Increased MHC-II expression is believed to be an important factor leading to the development of autoimmune responses and could help perpetuate a vicious circle of antiseif immune response by facilitating the persistent activation of T_H1 cells and, consequently, the stimulation of synovial cells, monocytes, and dendritic cells.

Interleukin-18, in addition to promoting differentiation of T_H1 cells in synergism with IL-12, promotes the synthesis of interferon- γ , thus contributing indirectly to macrophage activation. In addition, mononuclear cells activated by IL-18 release GM-CSF, TNF, and prostaglandin E₂ and show increased expression of inducible nitric oxide synthase. Therefore, IL-18 can be classified as a pro-inflammatory cytokine.

Finally, activated macrophages secrete a variety of metalloproteinases (including collagenase, elastase, stromelysin, matrylisin, and gelatinase B), particularly when stimulated with IL-1 and TNF- α . Studies of biopsies of the rheumatoid synovium discussed above found these two cytokines at levels high enough to deliver such stimulatory signals to monocytes and fibroblasts. The subsequent release of metalloproteinases is believed to have a primary role in causing tissue damage in the inflamed joints.

VI. OVERVIEW OF PATHOGENESIS OF RHEUMATOID ARTHRITIS

A. Predisposing Factors

Two important types of factors seem to have a strong impact in the development of rheumatoid arthritis.

1. Genetic Factors

The link to HLA-DR4, and particularly with subtypes Dw4 and Dw14, as well as with the structurally related Dw1 subtype of HLA-DR1, has been previously discussed in this chapter. It is currently accepted that such DR subtypes may be structurally fitted to present a peptide to autoreactive or cross-reactive helper T lymphocytes, thus precipitating the onset of the disease.

2. Hormonal Factors

The role of hormonal factors is suggested by two observations:

1. RA is three times more frequent in females than in males, predominantly affecting women 30–60 years of age.
2. Pregnancy produces a remission during the third trimester, sometimes followed by exacerbation after childbirth.

These observations suggest that hormonal factors may have a significant effect on the development of rheumatoid arthritis. However, to this day the responsible factors have not been defined. On the other hand, a possible mechanism by which pregnancy would cause an improvement in the clinical picture has recently suggested by the observation that estrogens potentiate B lymphocyte responses in vitro. This increased B-cell activity is likely

to reflect a shift of predominant T_H activity from T_{H1} to T_{H2} , which is considerably less pro-inflammatory.

B. Precipitating Factors

Three main mechanisms responsible for the escape from tolerance that must be associated with the onset of RA have been proposed.

1. Decreased activity of downregulating T cells
2. Nonspecific B-cell stimulation by microbial products (e.g., bacterial lipopolysaccharide) or infectious agents (e.g., viruses)
3. Stimulation of self-reactive T lymphocytes as a consequence of the presentation of a cross-reactive peptide (possibly of infectious origin) by an activated antigen-presenting cell (e.g., dendritic cell or RF^+ B cell)

The genetic linkages discussed earlier in this chapter support the last theory. Also, the key role of T lymphocytes is supported by histological data (discussed earlier) and by the observations that HIV infection and immunosuppression for bone marrow transplantation, two conditions that depress helper T-lymphocyte function very profoundly, are associated with remissions of RA.

C. Self-Perpetuating Mechanisms

Once helper T cells are activated, a predominantly T_{H1} response develops. Activated T_{H1} cells release interferon- γ and GM-CSF, which activate macrophages and related cells, inducing the expression of MHC-II molecules, creating conditions for continuing and stronger stimulation of helper T lymphocytes. As this cross-stimulation of T_{H1} lymphocytes and macrophages continues, chemotactic factors are released and additional lymphocytes, monocytes, dendritic cells, and granulocytes are recruited into the area. As inflammatory cells become activated, they release proteases and pro-inflammatory mediators, such as PGE_2 . The release of proteases will cause damage on the synovial and peri-synovial tissues, while the activation of osteoblasts and osteoclasts by mediators released by activated lymphocytes and macrophages (particularly IL-1 and IL-6) is the cause of bone damage and abnormal repair.

D. Initiating Factors

While our understanding of the basic immune abnormalities and of the self-perpetuating circuits involved in RA has become more complete, there is considerable uncertainty about the factor(s) that may be responsible for the initiation of the disease. There is also very little knowledge about the factors that localize the disease to the joints on the initial stages. For example, there is experimental evidence supporting a critical role of DC, probably by promoting autoreactive T-cell activation, but there is no logical way to explain how the DC would be initially activated and localized to the synovial tissue. Observations in animal models suggest that arthritis can develop in the absence of autoreactivity to joint antigens, a model that could explain the association with infections such as those caused by *Proteus mirabilis* and Epstein Barr virus. What this model fails to provide is an explanation for the localization of the ensuing autoimmune reaction to the joints. In addition, the MHC molecules linked to RA appear to be able to recognize peptides derived from joint tissue

proteins. If this is proven to be unquestionably the case, what remains to be explained is what triggers the initial activation of antigen-presenting cells in the joints to an extent that the recognition of self peptides takes place in an environment conducive to the development of an immune response rather than maintaining the normal state of anergy.

VII. THERAPY

It is not surprising that our very incomplete knowledge of the pathogenesis of rheumatoid arthritis is reflected at the therapeutic level. Most of our current therapeutic approaches are palliative, aiming to reduce joint inflammation and tissue damage. Under these conditions, RA therapy is often a frustrating experience for patients and physicians.

A. Nonsteroidal Anti-inflammatory Drugs

This group of anti-inflammatory drugs includes, among others, aspirin, ibuprofen, naproxen, indomethacin, and the recently introduced COX-2 inhibitors. These compounds have as common mechanism of action the inhibition of the cyclooxygenase pathway of arachidonic acid metabolism, which results in a reduction of the local release of prostaglandins. Their administration is beneficial in many patients with rheumatoid arthritis.

B. Glucocorticoids

In more severe cases, in which the nonsteroidal anti-inflammatory drugs (NSAIDs) are not effective, glucocorticoids are indicated. However, the use of glucocorticoids in RA raises considerable problems, because in most instances their administration masks the inflammatory component only as long as it is given. Thus, glucocorticoid therapy needs to be maintained for long periods of time at doses exceeding 20 mg/day, exposing the patient to very serious side effects, including muscle and bone loss, which may become more devastating than the original arthritis.

C. Disease-Modifying Drugs

A variety of potent drugs have been used in attempts to reduce the intensity of the autoimmune reaction and/or the consequent inflammatory reaction and attenuate the clinical manifestations of the disease. This group includes a series of drugs that seems mainly to have anti-inflammatory effects, such as auranofin and gold salts, hydroxychloroquine, minocycline, sulfasalazine, D-penicillamine, and a group of cytotoxic/immunosuppressive drugs that include methotrexate, azathioprine, chlorambucil, cyclophosphamide, leflunomide, and cyclosporin A. All these agents have side effects, some more severe than others. Usually less toxic compounds are used first and more toxic agents are introduced if the patient continues to deteriorate. Some authors have claimed that methotrexate, administered in low weekly doses, is not associated with long-term side effects while controlling the inflammatory component of the disease and delaying the appearance of the chronic phase. The use of agents specifically directed at reducing T-cell activation levels, such as cyclosporin A and leflunomide, by themselves or in association (e.g., leflunomide plus methotrexate), has also been successful.

D. Biological Response Modifiers

Considerable interest has been devoted in recent years to the use of biological response modifiers (BRM) (discussed in detail in Chapter 24). Two basic types of BRMs have been used: those that try to suppress activated T-cell populations and those that have the neutralization of pro-inflammatory cytokines as their major mechanism of action. To this date, there has been very limited success with BRMs targeting activated T cells, while the opposite has been true with BRMs that downregulate the effects of proinflammatory cytokines. Among the latter, recombinant humanized anti-TNF (infliximab) and a recombinant form of a soluble TNF receptor (etanercept) have been most successful in clinical trials and have received FDA approval. Other BRMs, such as monoclonal antibodies directed to IL-6 and IL-6 receptors, CD4, and ICAM-1 are still being evaluated.

It seems possible that maximal clinical benefit for RA patients may be obtained from the combination of more than one type of therapeutic agent. For example, the combination of infliximab and methotrexate seems particularly effective.

E. Reinduction of Tolerance

Attempts to reinduce tolerance to cartilage antigens postulated to be involved in the autoimmune response by feeding animal cartilage extracts to RA patients have yielded promising results. However, the clinical benefits reported so far have been observed in short-term studies, and research is necessary to determine if the benefits persist in the long run. Also, additional studies are needed to better define the mechanism(s) involved in oral tolerization.

Case 19.1 Revisited

Antibodies against single-stranded DNA can be detected in about one third of the patients. The epitopes recognized by anti-ssDNA antibodies correspond to DNA-associated proteins, corresponding to the homogeneous pattern seen by immunofluorescence (See chapter 20). The detection of anti-ssDNA antibodies does not have diagnostic or prognostic significance because these antibodies are neither disease-specific nor involved in immune complex formation.

The low neutrophil count and splenomegaly seen in this patient are suggestive of Felty's syndrome, the association of rheumatoid arthritis with autoimmune neutropenia.

The pathogenesis of rheumatoid arthritis is surrounded by questions. It is believed that activation of self-reactive T lymphocytes as a consequence of the presentation of a cross-reactive peptide (possibly of infectious origin) by an activated antigen-presenting cell is the initial step. Such a peptide would be mostly expressed in the synovial tissues, and the activation of helper T cells (predominantly T_H1) would be followed by the release of interferon- γ and GM-CSF that activate macrophages and antigen presenting cells. Activated macrophages overexpress MHC-II molecules, creating conditions for continuing and stronger stimulation of helper T lymphocytes. As this cross-stimulation of T_H1 lymphocytes and macrophages continues, chemotactic factors are released and additional lymphocytes, dendritic cells, monocytes, and granulocytes are recruited into the area. As inflammatory cells become activated, they release metalloproteinases and pro-inflammatory mediators, such as TNF and PGE_2 . The release of metalloproteinases will cause damage to the synovium and cartilage. When the process evolves to this level of joint damage, the prognosis is poor.

The subcutaneous nodule seen below the left elbow is a rheumatoid nodule, the clinical expression of vasculitis associated with RA.

It is common to observe some signs and symptoms more indicative of a systemic disease, particularly vasculitis, secondary to immune complex deposition in the vessels of the dermis. Rheumatoid nodules are virtually pathognomonic of RA and indicate a poor prognosis.

RA predominantly affects women from 30 to 60 years of age for reasons that remain unclear but that may be related to hormonal influences in the T_H1/T_H2 balance. Pregnancy is often associated with remission, probably reflecting the fact that estrogens favor T_H2 cell activity, which in the case of RA seems not to be as pathogenic as T_H1 activity.

In a case of severe RA such as the one described, administration of nonsteroidal anti-inflammatory agents is not likely to be effective. Disease-modifying agents, such as methotrexate, administered in low weekly doses, possibly in combination with leflunomide or infliximab, are likely to control the inflammatory component of the disease and delay the onset of the chronic phase without serious side effects.

SELF-EVALUATION

Questions

Choose the one *best* answer.

- 19.1 The classical rheumatoid factors predominantly detected by techniques based on red cell agglutination are anti-IgG antibodies of the:
 - A. IgA isotype
 - B. IgD isotype
 - C. IgE isotype
 - D. IgG isotype
 - E. IgM isotype
- 19.2 A patient with rheumatoid arthritis develops unexpected fever. A PPD test is negative and repeated blood cultures are negative. A CBC shows mild anemia and a very low neutrophil count. This patient's neutropenia is likely to be secondary to a(n):
 - A. Autoimmune reaction
 - B. Bone marrow depression
 - C. Hypersensitivity reaction
 - D. Infectious process
 - E. Metabolic abnormality
- 19.3 Which of the following observations provided the strongest argument against a primary pathogenic role for rheumatoid factor in rheumatoid arthritis?
 - A. Detection of other autoantibodies in patients with RA
 - B. Detection of RF in patients with chronic infections
 - C. Development of a clinically indistinguishable form of RA in seronegative agammaglobulinemic patients
 - D. Negativity of standard RF assays in about 25–30% of the patients with classical RA
 - E. Presence of RF in low titers in asymptomatic individuals

- 19.4 Which of the following cytokines released by dendritic cells induces T_H1 cell differentiation and activation?
- A. Lymphotoxin- α
 - B. IL-1
 - C. IL-6
 - D. IL-8
 - E. IL-18
- 19.5 Which of the following is a common cause of seronegativity in patients with rheumatoid arthritis?
- A. Agammaglobulinemia
 - B. Anti-immunoglobulin antibodies reacting exclusively with IgA
 - C. Circulating IgG-anti-IgG immune complexes
 - D. IgG anti-immunoglobulin antibodies
 - E. IgM anti-immunoglobulin antibodies
- 19.6 What is the significance of detecting a high titer of rheumatoid factor in a patient with suspected rheumatoid arthritis?
- A. A diagnosis of Felty's syndrome should be considered
 - B. A diagnosis of Sjögren's syndrome should be considered
 - C. High probability for the development of systemic complications
 - D. Large concentrations of circulating immune complexes are likely to exist in circulation
 - E. No special meaning
- 19.7 Which of the following cell populations is most likely to play the key role in the release of mediators responsible for the inflammatory process and tissue damage in the joints of patients with RA?
- A. $CD4^+, CD45RO^+$ T lymphocytes
 - B. $CD5^+, CD22^+$ B lymphocytes
 - C. $CD22^+$ B lymphocytes
 - D. $MHC-II^+$ macrophages
 - E. RF^+ B lymphocytes
- 19.8 Which of the following cytokines is the target of effective BRM therapy in rheumatoid arthritis?
- A. GM-CSF
 - B. IL-12
 - C. IL-18
 - D. Interferon- γ
 - E. TNF
- 19.9 Which of the following membrane markers is shared by most T lymphocytes and a B-lymphocyte subpopulation supposedly involved in autoimmune reactions?
- A. CD5
 - B. CD11/18
 - C. CD25
 - D. CD45RO
 - E. MHC-II

- 19.10 Which of the following is the common mechanism of action for most of the nonsteroidal anti-inflammatory agents used in rheumatoid arthritis?
- A. Blockage of the cyclooxygenase pathway
 - B. Inhibition of matrix metalloproteinases
 - C. Inhibition of phospholipase A₂
 - D. Inhibition of platelet aggregation
 - E. Reduced expression of cytokine genes

Answers

- 19.1 (E) The classical rheumatoid factors are IgM antibodies reacting with IgG immunoglobulins and are preferentially detected by passive hemagglutination tests using IgG-coated red cells as an indicator system.
- 19.2 (A) The association of rheumatoid arthritis and neutropenia is known as Felty's syndrome, and the neutropenia is secondary to the effect of antineutrophil antibodies. NSAIDs are unlikely to cause neutropenia or bone marrow depression, although neutropenia can emerge in association with many different drugs as an unexpected side effect. Infectious processes are not usually associated with neutropenia or common hypersensitivity reactions.
- 19.3 (C) In most patients with seronegative rheumatoid arthritis, the test is false negative for a variety of reasons. In contrast, agammaglobulinemic patients who develop rheumatoid arthritis are truly seronegative and provide the best argument against a primary pathogenic role of rheumatoid factor.
- 19.4 (E) Of the listed cytokines, lymphotoxin- α and IL-18 are involved in T_H1 lymphocyte proliferation and/or differentiation, but IL-18 is the only one released by dendritic cells.
- 19.5 (C) The serum of most patients with seronegative rheumatoid arthritis contains circulating immune complexes involving anti-IgG antibodies of the IgG isotype and IgG. The anti-Ig antibodies in these complexes have their binding sites blocked, and the IC do not dissociate as readily as those involving IgM. As a result, false-negative results are obtained in the screening tests.
- 19.6 (C) Positive RF tests with high titers can be observed in patients with RA and are often associated with systemic complications. Similar high titers of rheumatoid factor can be detected in patients with Sjögren's syndrome or Felty's syndrome, but the high titers of RF by themselves do not indicate a higher probability of these last two diagnoses than RA. The titer of RF cannot be considered as a direct indication of the levels of circulating IC, because the titer of the RF tests really depends on the amount of free antibody binding sites, which can become involved in the cross-linking of indicator particles or red cells. Thus, antigen-antibody ratios, RF isotype, and RF affinity or IgG will have a stronger impact on the results of the RF test than the concentration of circulating IC.

- 19.7 (D) Activated macrophages overexpress MHC-II molecules and release a variety of pro-inflammatory cytokines and metalloproteinases. The contribution of T lymphocytes can only be indirect, by inducing macrophage activation. RF⁺ B lymphocytes play a significant role in amplifying the pro-inflammatory immune response in synovial tissues, but they also have mostly indirect role in causing inflammation and tissue damage.
- 19.8 (E) Two BRMs targeting TNF have been successfully used in rheumatoid arthritis: humanized monoclonal antibodies to TNF (infliximab) and recombinant soluble TNF receptors (etanercept).
- 19.9 (A)
- 19.10 (A) Most nonsteroidal anti-inflammatory agents inhibit the cyclooxygenase pathway of arachidonic acid metabolism that leads to the synthesis of prostaglandins E₂ and F₂.

BIBLIOGRAPHY

- Auger, I., Toussiro, E., and Roudier, J. Molecular mechanisms involved in the association of HLA-DR4 and rheumatoid arthritis. *Immunol. Res.* 16:121, 1997.
- Carsons, A., Chen, P. P., and Kipps, T. J. New roles for rheumatoid factor. *J. Clin. Invest.* 87:379, 1991.
- Feldman, M., and Maini R. N. The role of cytokines in the pathogenesis of rheumatoid arthritis. *Rheumatology* 38 (Suppl. 3):3, 1999.
- Gracie, J. A., Forsey, R. J., Chan, W. L., et al. A proinflammatory role for IL-18 in rheumatoid arthritis. *J. Clin. Invest.* 104:1393, 1999.
- Kirwan, J. R., and the ARC Low Dose Glucocorticosteroid Study Group. The effects of glucocorticoids on joint destruction in rheumatoid arthritis. *N. Engl. J. Med.* 333:142, 1995.
- McDaniel, D. O., Alarcon, G. S., Pratt, P. W., and Reveille, J. D. Most African-American patients with rheumatoid arthritis do not have the rheumatoid antigenic determinant. *Ann. Int. Med.* 123:1812, 1995.
- Schur, P. H. Serologic tests in the evaluation of rheumatic diseases. *Immunol. Allergy Practice* 13:138, 1991.
- Struik, L., Hawes, J. E., Chatila, M. K., et al. T cell receptors in rheumatoid arthritis. *Arthr. Rheum.* 38:577, 1995.
- Thomas, R., MacDonald, K. P. A., Pettit, A. R., et al. Dendritic cells and the pathogenesis of rheumatoid arthritis. *J. Leuk. Biol.* 66:286, 1999.
- Wallis, W. J., Furst, D. E., Strand, V., and Keystone, E. Biologic agents and immunotherapy in rheumatoid arthritis. *Rheum. Dis. Clin. North Am.* 24:537, 1998.
- Winchester, R. The molecular basis of susceptibility to rheumatoid arthritis. *Adv. Immunol.* 56:389, 1994.
- Yocum, D. E. T cells: Pathogenic cells and treatment targets in rheumatoid arthritis. *Semin. Arthritis Rheum.* 29:27, 1999.
- Ziff, M. The rheumatoid nodule. *Arthr. Rheum.* 33:768, 1990.

20

Hypersensitivity Reactions

Gabriel Virella

I. INTRODUCTION

The immune response of vertebrates has evolved as a mechanism to eradicate infectious agents that succeed in penetrating natural anti-infection barriers. However, in some instances the immune response can be the cause of disease, either as an undesirable effect of an immune response directed against an exogenous antigen or as a consequence of an autoimmune reaction. These undesirable immune responses define what is known as hypersensitivity, i.e., an abnormal state of immune reactivity that has deleterious effects on the host. A patient with hypersensitivity to a given compound suffers pathological reactions as a consequence of exposure to the antigen to which he or she is hypersensitive. The term “allergy” is often used to designate a pathological condition resulting from hypersensitivity, particularly when the symptoms occur shortly after exposure.

Hypersensitivity reactions can be classified as immediate or as delayed, depending on the time elapsed between the exposure to the antigen and the appearance of clinical symptoms. They can also be classified as humoral or cell-mediated, depending on the arm of the immune system predominantly involved. A classification combining these two elements was proposed in the 1960s by Gell and Coombs, and although many hypersensitivity disorders may not fit well into their classification, it remains popular because of its simplicity and obvious relevance to the most common hypersensitivity disorders.

The Gell and Coombs’ classification of hypersensitivity reactions considers four types of hypersensitivity reactions. Type I, II, and III reactions are basically mediated by antibodies with or without participation of the complement system; type IV reactions are

Table 20.1 General Characteristics of the Four Types of Hypersensitivity Reactions as Defined by Gell and Coombs

Type	Clinical manifestations	Lag between exposure and symptoms	Mechanism
I (immediate)	Anaphylaxis, asthma, hives, hay fever	Minutes	Homocytotropic Ab (IgE)
II (cytotoxic)	Hemolytic anemia, cytopenias, Goodpasture's syndrome	Variable	Complement-fixing/opsonizing, Ab (IgG, IgM)
III	Serum sickness, Arthus reaction, vasculitis	6 hr ^a	Immune complexes containing complement-fixing Ab (mostly IgG)
IV (delayed)	Cutaneous hypersensitivity; graft rejection	12–48 hr	Sensitized lymphocytes

^a For the Arthus reaction.

cell-mediated (see Table 20.1). While in many pathological processes mechanisms classified in more than one of these types of hypersensitivity reactions may be operative, the subdivision of hypersensitivity states into four broad types aids considerably in the understanding of their pathogenesis.

II. TYPE I HYPERSENSITIVITY REACTIONS (IGE-MEDIATED HYPERSENSITIVITY, IMMEDIATE HYPERSENSITIVITY)

A. Historical Overview

Much of our early knowledge about immediate hypersensitivity reactions was derived from studies in guinea pigs. Guinea pigs immunized with egg albumin frequently suffer from an acute allergic reaction upon challenge with this same antigen. This reaction is very rapid (observed within a few minutes after the challenge) and is known as an anaphylactic reaction. It often results in the death of the animal in anaphylactic shock. If serum from a guinea pig sensitized 7–10 days earlier with a single injection of egg albumin and adjuvant is transferred to a nonimmunized animal that is challenged 48 hours later with egg albumin, this animal develops an anaphylactic reaction and may die in anaphylactic shock. Because hypersensitivity was transferred with serum, this observation suggested that antibodies play a critical pathogenic role in this type of hypersensitivity.

The passive transfer of hypersensitivity can take less dramatic aspects if the reaction is limited to the skin. To study what is known as passive cutaneous anaphylaxis, nonsensitized animals are injected intradermally with the serum from a sensitized donor. The serum from the sensitized donor contains homocytotropic antibodies that become bound to the mast cells in and around the area where serum was injected. After 24–72 hours the antigen in question is injected intravenously, mixed with Evans blue dye. When the antigen reaches the area of the skin where antibodies were injected and became bound to mast cells, a localized type I reaction takes place, characterized by a small area of vascular hyperperme-

ability that results in edema and redness. When Evans blue is injected with the antigen, the area of vascular hyperpermeability will have a blue discoloration due to the transudation of the dye.

The Prausnitz-Küstner reaction, carried out in humans, contributed to our initial understanding of the immediate hypersensitivity reaction. Serum from an allergic patient was injected intradermally into a nonallergic recipient. Twenty-four to 48 hours later the area of skin where the serum was injected was challenged with the antigen that was suspected to cause the symptoms in the patient. A positive reaction consisted of a wheal and flare appearing a few minutes after injection of the antigen. The reaction can also be performed in primates, which are injected intravenously with serum of an allergic individual and challenged later with intradermal injections of a battery of antigens that could be implicated as the cause of the allergic reaction. These reactions are no longer used for any clinical purpose.

B. Clinical Expression

A wide variety of hypersensitivity states can be classified as immediate hypersensitivity reactions. Some have a predominantly cutaneous expression (hives or urticaria), others affect the airways (hay fever, asthma), while still others are of a systemic nature. The latter are often designated as anaphylactic reactions, of which anaphylactic shock is the most severe form.

The expression of anaphylaxis is species specific. The guinea pig usually has bronchoconstriction and bronchial edema as its predominant expression, leading to death in acute asphyxiation. In the rabbit, on the contrary, the most affected organ is the heart, and the animals die of right heart failure. In humans, bronchial asthma in its most severe forms closely resembles the reaction in the guinea pig.

Most frequently, human type I hypersensitivity has a localized expression, such as the bronchoconstriction and bronchial edema that characterize bronchial asthma, the mucosal edema in hay fever, and the skin rash and subcutaneous edema that defines urticaria (hives). The factor(s) involved in determining the target organs that will be affected in different types of immediate hypersensitivity reactions are not well defined, but the route of exposure to the challenging antigen seems an important factor. For example, allergic (extrinsic) asthma and hay fever are usually associated with inhaled antigens, while urticaria is seen as a frequent manifestation of food allergy.

Systemic anaphylaxis is usually associated with antigens that are directly introduced into the circulation, such as in the case of hypersensitivity to insect venom or to systemically administered drugs. Systemic anaphylactic reactions in humans usually present with itching, erythema, vomiting, abdominal cramps, diarrhea, respiratory distress, and, in severe cases, laryngeal edema and vascular collapse leading to shock that may be irreversible.

Some individuals have an obvious tendency to develop hypersensitivity reactions. The term atopy is used to designate this tendency of some individuals to become sensitized to a variety of allergens (antigens involved in allergic reactions) including pollens, spores, animal danders, house dust, and foods. These individuals, when skin tested, are positive to several allergens, and successful therapy must take this multiple reactivity into account. A genetic background for atopy is suggested by the fact that this condition shows familial prevalence.

C. Pathogenesis

Immediate hypersensitivity reactions are a consequence of the predominant synthesis of specific IgE antibodies by the allergic individual; these IgE antibodies bind with high affinity to the membranes of basophils and mast cells. When exposed to the sensitizing antigen, the reaction with cell-bound IgE triggers the release of histamine through degranulation, and the synthesis of leukotrienes C_4 , D_4 , and E_4 (this mixture constitutes what was formerly known as slow reacting substance of anaphylaxis or SRS-A). These substances are potent constrictors of smooth muscle and vasodilators and are responsible for the clinical symptoms associated with immediate hypersensitivity (see Chapter 21). Recent evidence, however, has shown that in animal models, IL-13, released by T_H2 cells, can induce clinical manifestations of asthma independently of IgE and eosinophils. Thus, the concept that immediate hypersensitivity is exclusively antibody-mediated may need to be revised.

III. CYTOTOXIC REACTIONS (TYPE II HYPERSENSITIVITY)

This second type of hypersensitivity involves, in its most common forms, complement-fixing antibodies (IgM or IgG) directed against cellular or tissue antigens. The clinical expression of type II hypersensitivity reaction depends largely on the distribution of the antigens recognized by the responsible antibodies.

A. Autoimmune Hemolytic Anemia and Other Autoimmune Cytopenias

Autoimmune hemolytic anemia, autoimmune thrombocytopenia, and autoimmune neutropenia (discussed in greater detail in Chapters 17 and 22) are clear examples of type II (cytotoxic) hypersensitivity reactions in which the antigens are unique to cellular elements of the blood. Autoimmune hemolytic anemia is the best understood of these conditions.

Patients with autoimmune hemolytic anemia synthesize antibodies directed to their own red cells. Those antibodies may cause hemolysis by two main mechanisms:

1. If the antibodies are of the IgM isotype, complement is activated up to C9, and the red cells can be directly hemolyzed (intravascular hemolysis).
2. If, for a variety of reasons, the antibodies (usually IgG) fail to activate the full complement cascade, the red cells will be opsonized with antibody (and possibly C3b) and are taken up and destroyed by phagocytic cells expressing $Fc\gamma R$ and C3b receptors (extravascular hemolysis).

Intravascular hemolysis is associated with release of free hemoglobin into the circulation (hemoglobinemia), which eventually is excreted in the urine (hemoglobinuria). Massive hemoglobinuria can induce acute tubular damage and kidney failure, which is usually reversible. In contrast, extravascular hemolysis is usually associated with increased levels of bilirubin, derived from cellular catabolism of hemoglobin. All hemolytic reactions usually lead to the mobilization of erythrocyte precursors from the bone marrow to compensate for the acute loss. This is reflected by reticulocytosis and, in severe cases, by erythroblastosis (see Chapter 22).

B. Goodpasture's Syndrome

The classical example of a type II hypersensitivity reaction in which the antibodies are directed against tissue antigens is Goodpasture's syndrome. The pathogenesis of Goodpasture's syndrome involves the spontaneous emergence of basement membrane autoantibodies that bind to antigens of the glomerular and alveolar basement membranes. Those antibodies are predominantly of the IgG isotype. Using fluorescein-conjugated antisera, the deposition of IgG and complement in patients with Goodpasture's syndrome usually follows a linear, very regular pattern, corresponding to the outline of the glomerular or alveolar basement membranes.

Two types of observations support the pathogenic role of anti-basement membrane antibodies:

1. Elution studies yield immunoglobulin-rich preparations that, when injected into primates, can induce a disease similar to human Goodpasture's syndrome.
2. Goodpasture's syndrome recurs in patients who receive a kidney transplant, and the transplanted kidney shows identical patterns of IgG and complement deposition along the glomerular basement membrane.

Once antigen-antibody complexes are formed in the kidney glomeruli or in the lungs, complement will be activated and, as a result, C5a and C3a will be generated. These complement components are chemotactic for polymorphonuclear (PMN) leukocytes; C5a also increases vascular permeability directly or indirectly (by inducing the degranulation of basophils and mast cells) (see Chapter 9). Furthermore, C5a can upregulate the expression of cell adhesion molecules of the CD11b/CD18 family (see Chapter 13) in PMN leukocytes and monocytes, promoting their interaction with ICAM-1 expressed by endothelial cells, thus facilitating the migration of inflammatory cells into the extravascular space. In the extravascular space PMN leukocytes will recognize the Fc regions of basement membrane-bound antibodies, as well as C3b bound to the corresponding immune complexes, and will release their enzymatic contents, which include a variety of metalloproteinases including collagenases and plasminogen activator. Plasminogen activator converts plasminogen into plasmin, which in turn can split complement components and generate bioactive fragments, enhancing the inflammatory reaction. Collagenases and other metalloproteinases cause tissue damage (i.e., destruction of the basement membrane), that eventually may compromise the function of the affected organ.

The pathological sequence of events after the reaction of anti-basement membrane antibodies with their corresponding antigens is indistinguishable from the reactions triggered by the deposition of soluble immune complexes or by the reaction of circulating antibodies with antigens passively fixed to a tissue, considered as type III hypersensitivity reactions.

C. Nephrotoxic (Masugi) Nephritis

This experimental model of immunologically mediated nephritis, named after the scientist who developed it, is induced by injection of heterologous anti-basement membrane antibodies into healthy animals. Those antibodies combine with basement membrane antigens, particularly at the glomerular level, and trigger the development of glomerulonephritis.

This experimental model has been extremely useful to demonstrate the pathogenic importance of complement activation and of neutrophil accumulation. For example, if in-

stead of complete antibodies, one injects Fab or F(ab')₂ fragments generated from anti-basement membrane antibodies that do not activate complement, the accumulation of neutrophils in the glomeruli fails to take place, and tissue damage will be minimal to nonexistent. Similar protection against the development of glomerulonephritis is observed when animals are rendered C3 deficient by injection of cobra venom factor prior to the administration of anti-basement membrane antibodies, or when those antibodies are administered to animals rendered neutropenic by administration of cytotoxic drugs or of antineutrophil antibodies.

IV. IMMUNE COMPLEX-INDUCED HYPERSENSITIVITY REACTIONS (TYPE III HYPERSENSITIVITY)

In the course of acute or chronic infections, or as a consequence of the production of autoantibodies, antigen-antibody complexes (also known as Immune complexes) are likely to be formed in circulation or in tissues to which the pertinent self antigens or microbial antigens are expressed or have been adsorbed. Both scenarios can lead to inflammatory changes which are characteristic of the so-called immune complex diseases (see Chapter 23).

Circulating immune complexes are usually adsorbed to red cells and cleared by the phagocytic system (see Chapters 9, 13 and 23). In most cases this will be an inconsequential sequence of events, but in cases where there is massive formation of circulating immune complexes (e.g., serum sickness), the clearance capacity of the phagocytic system is exceeded, and inflammatory reactions can be triggered by the deposition of those immune complexes in tissues. A simplified sequence of events leading to immune complex-induced inflammation is shown in Figure 20.1.

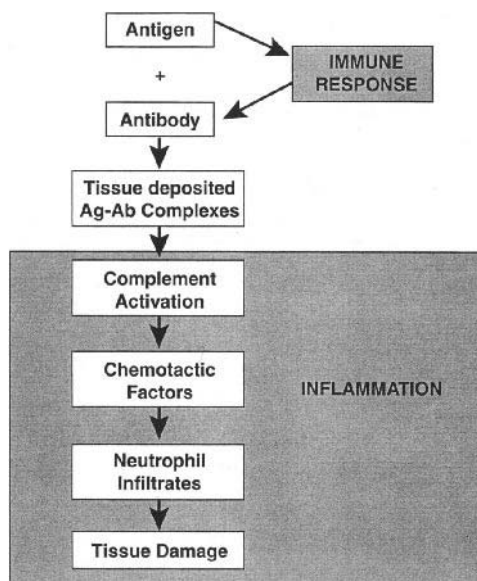

Fig. 20.1 Diagrammatic representation of the sequence of events triggered by the deposition of soluble immune complexes that eventually results in inflammation and tissue damage.

The in situ formation of immune complexes is likely to be a scenario more likely involved in the pathogenesis of inflammatory reactions. The adsorption of circulating antigens of microbial origin or released by dying cells to a variety of tissues seems to be a relatively common event. If the same antigens trigger a humoral immune response, immune complex formation may take place in the tissues where the antigens are adsorbed, in which case clearance by the phagocytic system may become impossible. In fact, tissue-bound immune complexes are very strong activators of the complement system and of phagocytic cells, triggering a sequence of events leading to tissue inflammation virtually identical to that observed in cases of in situ immune reactions involving tissue antigens and the corresponding antibodies.

A. The Arthus Reaction

Arthus, who observed that the intradermal injection of antigen into an animal previously sensitized results in a local inflammatory reaction, first described this reaction at the turn of the century. A human equivalent of this reaction can be observed in some reactions to immunization boosters in individuals who have already reached high levels of immunity.

The Arthus reaction is triggered by the combination of complement-fixing IgG antibodies (characteristically predominating in hyperimmune states in most species) and tissue-fixed antigens. The lag time between antigen challenge and the reaction is usually 6 hours, which is considerably longer than the time lag of an immediate hypersensitivity reaction, but considerably shorter than that of a delayed hypersensitivity reaction.

Arthus reactions are typically elicited in the skin. They are usually edematous in the early stages, but later can become hemorrhagic and, eventually, necrotic. Deep tissues can also be affected, because the same pathogenic mechanisms can lead to deep tissue inflammation whenever the antigen, although intrinsically soluble, is unable to diffuse freely and remains retained in or around its penetration point (e.g., the perialveolar spaces for inhaled antigens).

Because it is easily induced in a variety of laboratory animals, the Arthus reaction is one of the best studied models of immune complex disease. Immunohistological studies have shown that soon after antigen is injected in the skin, IgG antibody and C3 will appear in perivascular deposits at the site of injection. This is followed by a massive influx of granulocytes, believed to result from activation of the complement system by the in situ-formed immune complexes (ICs). The importance of granulocytes was confirmed in experiments in which investigators tried to induce the Arthus reaction in laboratory animals rendered neutropenic by administration of nitrogen mustard or of antineutrophil serum. Under these experimental conditions the inflammatory reaction is prevented and the reaction does not develop.

In spite of their pathogenic role, granulocytes will actively engulf and catabolize the tissue-deposited ICs, eliminating the trigger for the inflammatory reaction. As the ICs are eliminated, the cellular infiltrate changes from a predominance of neutrophils and other granulocytes to a predominance of mononuclear cells, which is usually associated with the healing stage. The degree of healing depends on whether the exposure to the triggering antigen is a discrete event or repeated over time. Single or widely spaced exposure is usually followed by complete healing, while frequently repeated exposures tend to lead to irreversible damage.

B. Serum Sickness

In the preantibiotic era, the treatment of rabies, bacterial pneumonia, diphtheria, and other infections involved the administration of heterologous antisera as a way to transfer immunity to the offending agents. In many instances, serotherapy appeared to be successful and the patient improved, but a week to 10 days after the injection of heterologous antiserum, the patient developed what was termed as “serum sickness”: a combination of cutaneous rash (often purpuric), fever, arthralgias, mild acute glomerulonephritis, and carditis. Currently, serum sickness as a complication of passive immunotherapy with heterologous antisera is seen after injection of heterologous antisera to snake venom, after the administration of mouse monoclonal antibodies in cancer immunotherapy, and after the administration of heterologous (monoclonal or polyclonal) antilymphocyte sera in transplanted patients. But it can also be a side effect of some forms of drug therapy, particularly with penicillin and related drugs.

Serum sickness is extremely easy to reproduce in experimental animals through the injection of heterologous proteins. Basically two types of experimental serum sickness can be induced:

- Acute, after a single immunization with a large dose of protein
- Chronic, after repeated daily injections of small doses of protein

While acute serum sickness is reversible, the chronic form, which closely resembles human glomerulonephritis, is usually associated with irreversible damage.

In all types of serum sickness, the initial event is the triggering of a humoral immune response, which explains the lag period of 7–10 days between the injection of heterologous protein (or drug) and the beginning of clinical symptoms. The lag period is shorter and the reaction more severe if there has been presensitization to the antigen in question.

As soon as antibodies are produced in sufficient amounts, they combine with the antigens (which at that time are still present in relatively large concentrations in the serum of the injected individual or experimental animal). Initially, the antigen-antibody reaction will take place in conditions of great antigen excess, and the resulting complexes are too small to activate complement or to be taken up by phagocytic cells and will remain in circulation without major consequences. As the immune response progresses and increasing amounts of antibody are produced, the antigen-antibody ratio will be such that intermediate-sized immune complexes will be formed. The intermediate-sized immune complexes are potentially pathogenic; they are large enough to activate complement and small enough to cross the endothelial barrier (particularly if vascular permeability is increased as a consequence of complement activation and release of C3a and C5a). Once they reach the extravascular space, inflammatory cells are recruited and activated and initiate the chain of events leading to tissue inflammation. As in the case of the Arthus reaction, the inflammatory changes associated with serum sickness do not take place or are very mild if complement or neutrophils are depleted.

The deposition of immune complexes can take place in different organs, such as the myocardium (causing myocardial inflammation), skin (causing erythematous rashes), joints (causing arthritis), and kidney (causing acute glomerulonephritis). Soluble immune complexes can also be absorbed by formed elements of the blood, particularly erythrocytes, neutrophils, and platelets. Although red cell absorption is usually a protective mechanism (see Chapter 9), if the amounts and characteristics of red blood cell–absorbed ICs are such that the regulatory function of CR1 is overridden, hemolysis may take place. Thrombocy-

topenia and neutropenia can also result from the activation of the complement system by cell-associated immune complexes. Purpuric rashes due to thrombocytopenia are frequently seen in serum sickness.

V. DELAYED (TYPE IV) HYPERSENSITIVITY REACTIONS

In contrast to the other types of hypersensitivity reactions discussed above, type IV or delayed hypersensitivity is a manifestation of cell-mediated immunity. In other words, this type of hypersensitivity reaction is due to the activation of specifically sensitized T lymphocytes rather than to an antigen-antibody reaction.

A. The Tuberculin Test as a Prototype Type IV Reaction

Intradermal injection of tuberculin or purified protein derivative (PPD) into an individual that has been previously sensitized (by exposure to *Mycobacterium tuberculosis* or by BCG vaccination) is followed, 24 hours after the injection, by a skin reaction at the site of injection characterized by redness and induration. Histologically, the reaction is characterized by perivenular mononuclear cell infiltration, often described as “perivascular cuffing.” Macrophages can be seen infiltrating the dermis. If the reaction is intense, a central necrotic area may develop. The cellular nature of the perivascular infiltrate, which contrasts with the predominantly edematous reaction in a cutaneous type I hypersensitivity reaction, is responsible for the induration.

B. Experimental Studies

Experiments carried out with guinea pigs investigating the elements involved in transfer of delayed hypersensitivity were critical in defining the involvement of lymphocytes in delayed hypersensitivity. When guinea pigs are immunized with egg albumin and adjuvant, not only do they become allergic, as discussed earlier, but they also develop cell-mediated hypersensitivity to the antigen. This duality can be demonstrated by passively transferring serum and lymphocytes from sensitized animals to nonsensitized recipients of the same strain and challenging the passively immunized animals with egg albumin. The animals that received serum will develop an anaphylactic response immediately after challenge, while those that received lymphocytes will only show signals of a considerably less severe reaction after at least 24 hours have elapsed from the time of challenge.

Most of our knowledge about the pathogenesis of delayed hypersensitivity reactions derives from experimental studies involving contact hypersensitivity. Experimental sensitization through the skin is relatively easy to induce by percutaneous application of low molecular weight substances such as picric acid or dinitrochlorobenzene (DNCB). The initial application leads to sensitization, a second application will elicit a delayed hypersensitivity reaction in the area where the antigen is applied.

1. Induction

The compounds used to induce contact hypersensitivity are not immunogenic by themselves. It is believed that these compounds couple spontaneously to an endogenous carrier

protein, and as a result of this coupling the small molecule will act as a hapten, while the endogenous protein will play the role of a carrier. A common denominator of the sensitizing compounds is the expression of reactive groups, such as Cl, F, Br, and SO_3H , which enable them to bind covalently to the carrier protein.

Spontaneous sensitization to drugs, chemicals, or metals is believed to involve diffusion of the haptenic substance into the dermis mostly through the sweat glands (hydrophobic substances appear to penetrate the skin more easily than hydrophilic substances) and once in the dermis, the haptenic groups will react spontaneously with "carrier" proteins. By a pathway that has not been defined, the Langerhans cells of the epidermis take up the hapten carrier conjugates, and a sensitizing peptide is presented in association with MHC-II molecules. Since the carrier protein is autologous, it would be expected that the sensitizing peptide contained the covalently associated sensitizing compound.

A unique feature of delayed hypersensitivity is that T lymphocytes are mostly involved in the antihapten response, while in most experimentally induced hapten-carrier responses the hapten is recognized by B lymphocytes. This may be explained, at least in part, by the fact that Langerhans cells migrate to regional lymph nodes, where they become dendritic cells and predominantly populate the paracortical areas, where they are in optimal conditions to present antigens to CD4^+ T lymphocytes (see Chapter 2).

2. Effector Mechanisms

The initial sensitization results in the acquisition of immunological memory. Later, when the sensitized individual is challenged with the same chemical, sensitized T cells will be stimulated into functionally active cells, releasing a variety of cytokines, which include IL-8, RANTES, and macrophage chemotactic proteins that attract and activate monocytes/macrophages, lymphocytes, basophils, eosinophils, and neutrophils. Other cytokines released by activated lymphocytes, particularly TNF and IL-1 upregulate the expression of cell adhesion molecules (CAMs) in endothelial cells, facilitating the adhesion of leukocytes to the endothelium, a key step in the extravascular migration of inflammatory cells. As a result of the release of chemokines and of the upregulation of CAMs, a cellular infiltrate predominantly constituted by mononuclear cells, but also including granulocytes, forms in the area where the sensitizing compound has been reintroduced 24–48 hours after exposure. The tissue damage that takes place in this type of reaction is likely to be due to the effects of active oxygen radicals and enzymes (particularly proteases, collagenase, and cathepsins) released by the infiltrating leukocytes, activated by the chemokines and other cytokines.

In severe cases, a contact hypersensitivity reaction may exhibit an exudative, edematous, highly inflammatory character. The release of proteases from monocytes and macrophages may trigger the complement-dependent inflammatory pathways by directly splitting C3 and C5; C5a will add its chemotactic effects to those of chemokines released by activated mononuclear cells and will also cause increased vascular permeability, a constant feature of complement-dependent inflammatory processes. It is not surprising, therefore, that a reaction which at the onset is cell mediated and associated to a mononuclear cell infiltrate, may, in time, evolve into a more classical inflammatory process with predominance of neutrophils and a more edematous character, less characteristic of a cell-mediated reaction.

C. Contact Hypersensitivity in Humans

Contact hypersensitivity reactions are observed with some frequency in humans due to spontaneous sensitization to a variety of substances:

Plant cathecols are apparently responsible for the hypersensitivity reactions to poison ivy and poison oak.

A variety of chemicals can be implicated in hypersensitivity reactions to cosmetics and leather.

Topically used drugs, particularly sulfonamides, often cause contact hypersensitivity.

Metals such as nickel can be involved in reactions triggered by contact with bracelets, earrings, or thimbles.

The diagnosis of contact hypersensitivity is usually based on a careful history of exposure to potential sensitizing agents and on the observation of the distribution of lesions that can be very informative about the source of sensitization. Patch tests using small pieces of filter paper impregnated with suspected sensitizing agents which are taped to the back of the patient can be used to identify the sensitizing substance.

D. The Jones-Mote Reaction

Following challenge with an intradermal injection of a small dose of a protein to which an individual has been previously sensitized, a delayed reaction (with a lag of 24 hours), somewhat different from a classical delayed hypersensitivity reaction, may be seen. The skin appears more erythematous and less indurated, and the infiltrating cells are mostly lymphocytes and basophils, the last sometimes predominating. The reaction has also been described, for this reason, as cutaneous basophilic hypersensitivity. Experimentally, it has been demonstrated that this reaction is triggered as a consequence of the antigenic stimulation of sensitized T lymphocytes.

E. Homograft Rejection

A most striking clinical manifestation of a delayed hypersensitivity reaction is the rejection of a graft. In classical chronic rejection, the graft recipient's immune system is first sensitized to peptides derived from alloantigens of the donor. After clonal expansion, activated T lymphocytes will reach the target organ, recognize the alloantigen-derived peptides against which they became sensitized, and initiate a sequence of events that leads to inflammation and eventual necrosis of the organ. This topic will be discussed in detail in Chapter 25.

F. Systemic Consequences of Cell-Mediated Hypersensitivity Reactions

While type IV hypersensitivity reactions with cutaneous expression usually have no systemic repercussions, cell-mediated hypersensitivity reactions localized to internal organs, such as the formation of granulomatous lesions caused by chronic infections with *Mycobacterium* species may be associated with systemic reactions. Cytokines released by activated lymphocytes and inflammatory cells play a major pathogenic role in such reactions. Pro-inflammatory cytokines, particularly IL-1, induce the release of prostaglandins in the hypothalamic temperature regulating center and cause fever, thus acting as a pyrogenic fac-

tor. TNF is also pyrogenic, both directly and by inducing the release of IL-1 by endothelial cells and monocytes. In addition, these two cytokines activate the synthesis of acute phase proteins (e.g., C-reactive protein) by the liver.

Prolonged release of TNF, on the other hand, may have deleterious effects since this factor contributes to the development of cachexia. Cachexia develops because TNF inhibits lipoprotein lipase, and as a consequence there is an accumulation of triglyceride-rich particles in the serum and a lack of the breakdown of triglycerides into glycerol and free fatty acids. This results in decreased incorporation of triglycerides into the adipose tissue and, consequently, in a negative metabolic balance. The cells continue to break down stored triglycerides by other pathways to generate energy, and the used triglycerides are not replaced. Cachexia is often a preterminal development in patients with severe chronic infections.

SELF-EVALUATION

Questions

Choose the one *best* answer.

- 20.1 Which of the following is believed to be the triggering step of a cutaneous hypersensitivity reaction to nickel?
 - A. Activation of the complement system
 - B. Formation of nickel-protein complexes
 - C. Induction of IgE antibody synthesis
 - D. Migration of inflammatory cells to the site of exposure
 - E. Release of pro-inflammatory cytokines by activated lymphocytes
- 20.2 Which of the following antigens is least likely to induce a delayed hypersensitivity reaction?
 - A. Candida antigen
 - B. Mumps antigen
 - C. Ragweed pollen
 - D. Tetanus toxoid
 - E. Tuberculin
- 20.3 Which of the following is a pathogenic step characteristically associated with an Arthus reaction?
 - A. Complement activation by the classical pathway
 - B. Formation of mononuclear cell infiltrates
 - C. High levels of IgM antibodies
 - D. Histamine release
 - E. Induction of IgE antibodies
- 20.4 Which of the following histopathological features is most likely to be evident on a skin biopsy of a patient having a delayed hypersensitivity reaction?
 - A. Deposits of immunoglobulins and complement in and around the arterial wall
 - B. Massive edema of the subcutaneous tissues
 - C. Necrosis of the epidermis
 - D. Periarteriolar neutrophil infiltrates
 - E. Perivenular mononuclear cell infiltrates

- 20.5 The persistence of an immediate hypersensitivity reaction for several hours is most likely a consequence of the:
- A. Fixation of mononuclear cells at the site of the reaction
 - B. Persistent activation of the complement system
 - C. Recruitment of basophils as a consequence of the upregulation of endothelial cell adhesion molecules
 - D. Release of leukotrienes C₄, D₄, and E₄
 - E. Systemic effects of pro-inflammatory cytokines
- 20.6 The pathogenesis of type II (cytotoxic) hypersensitivity reactions typically involves:
- A. Adsorption of antigen-antibody complexes to cell membranes
 - B. Cell or tissue damage caused by activated cytotoxic T lymphocytes
 - C. Complement activation by IgM or IgG antibodies
 - D. Direct cell lysis caused by cytotoxic antibodies
 - E. Release of histamine in the early stages
- 20.7 Progressive weight loss in a patient suffering from a chronic granulomatous infection with predominant mononuclear cell involvement is likely to be due to:
- A. Loss of protein by kidneys damaged as a consequence of immune complex deposition
 - B. Massive edema
 - C. Massive utilization of glucose by activated mononuclear cells
 - D. Persistent high fever
 - E. Persistent release of TNF

Questions 20.8–20.10 consist of a set of lettered headings followed by a list of numbered words or phrases. For each numbered word or phrase, select the one lettered heading that is most closely related to it. The same heading can be used once, more than once, or not at all.

- A. Cell-mediated (delayed) hypersensitivity
 - B. Cutaneous basophilic hypersensitivity
 - C. Cytotoxic hypersensitivity
 - D. IgE-mediated anaphylaxis
 - E. Immune complex-mediated hypersensitivity
- 20.8 Chronic “drug” dermatitis in the upper eyelids of a 24-year-old woman
- 20.9 Serum sickness-associated glomerulonephritis
- 20.10 Shock following a penicillin injection

Answers

- 20.1 (B) The substances involved in contact dermatitis are often small molecules that apparently act as haptens after spontaneously reacting with an endogenous protein that will serve as a carrier. Without this step, cutaneous dermatitis will not develop.
- 20.2 (C) Pollens are usually involved in type I hypersensitivity, and the skin tests with pollens elicit typical immediate hypersensitivity reactions.
- 20.3 (A) The Arthus reaction involves primarily complement-fixing antibodies. The cellular infiltrate is mainly composed of neutrophils and other granulocytes.

- 20.4 (E) In contrast of type II hypersensitivity, the cellular infiltrates in delayed hypersensitivity are perivenular and usually show a predominance of mononuclear cells.
- 20.5 (D) The initial phase of in immediate hypersensitivity reaction is due to mast cell and basophil degranulation with release of stored histamine. In later stages, the reaction is sustained by the secretion of SRS-A (a mixture of leukotrienes C₄, D₄, and E₄), which are synthesized de novo by stimulated basophils and mast cells.
- 20.6 (C) Complement activation is the key element and will either lead to direct cytolysis or to phagocytosis.
- 20.7 (E) TNF inhibits lipoprotein lipase, and as a consequence here is an accumulation of triglyceride-rich particles in the serum and a lack of the breakdown of triglycerides into glycerol and free fatty acids. The incorporation of triglycerides into the adipose tissue is inhibited, resulting in a negative metabolic balance. The cells continue to break down stored triglycerides by other pathways to generate energy, and the used triglycerides are not replaced. The kidneys are usually not affected (IC deposition is a feature of type II hypersensitivity reactions). Massive edema is seen in patients receiving large amounts of recombinant IL-2, but not in patients with T-lymphocyte activation. Fever, by itself, does not lead to cachexia.
- 20.8 (A) Sensitization to cosmetics such as eye shadow is not uncommon and involves a type IV reaction, usually induced by formalin that is added as a preservative.
- 20.9 (E) Serum sickness can be associated with glomerulonephritis secondary to the deposition of immune complexes involving heterologous antigens and the corresponding antibodies.
- 20.10 (D)

BIBLIOGRAPHY

- Brostoff, J., Scadding, G. K., Male, D., and Roitt, I. M., eds. *Clinical Immunology*. Gower Med. Publ., London, 1991.
- Collins, T. Adhesion molecules in leukocyte emigration. *Sci. Am. Med.* 2(6):28, 1995.
- Kaplan, A. P., Kuna, P., and Reddigari, S. R. Chemokines and the allergic response. *Exp. Dermatol.* 4:260, 1995.
- Kavanaugh, A. Adhesion molecules as therapeutic targets in the treatment of allergic and immunologically mediated disorders. *Clin. Immunol. Immunopath* 80 (part 2):S40, 1996.
- Old, L. J. Tumor necrosis factor. *Sci. Am.* May: 59, 1988.
- Schroeder, J. T., Kagey-Sobotka, A., and Lichtenstein, L. M. The role of the basophil in allergic inflammation. *Allergy* 50:463, 1995.
- Schwiebert, L. A., Beck, L. A., Stellato, C., et al. Glucocorticosteroid inhibition of cytokine production; relevance to antiallergic actions. *J. Allergy Clin. Immunol.* 97:143, 1996.
- Sell, S., ed. *Immunology, Immunopathology and Immunity*, 5th ed., Appleton & Lange, Stamford, CT, 1996.
- Wills-Karp, M., Luyimbazi, J., Xu, X., et al. Interleukin-13: Central mediator of allergic asthma. *Science* 282:2258, 1998.

21

IgE-Mediated (Immediate) Hypersensitivity

Jean-Michel Goust and Albert F. Finn, Jr.

I. INTRODUCTION

The term immediate hypersensitivity describes the main characteristic of IgE-mediated hypersensitivity reactions: the short time lag (seconds to minutes) between antigen exposure and the onset of clinical symptoms. This is because the initial symptoms of immediate hypersensitivity depend on the release of preformed mediators stored in cytoplasmic granules of basophils and mast cells; the release is triggered by the reaction of membrane-bound IgE with the corresponding antigen (also known as allergen, by being involved in allergic reactions).

II. Major Clinical Expressions

Immediate hypersensitivity or allergic reactions can have a variety of clinical expressions, including anaphylaxis, bronchial asthma, urticaria (hives), and rhinitis (hay fever). Table 21.1 summarizes the morbidity and mortality data for the two most severe types of allergic reactions, anaphylaxis and asthma.

Anaphylaxis is an acute life-threatening IgE-mediated reaction usually affecting multiple organs. The time of onset of symptoms depends on the level of hypersensitivity and the nature of the antigen, intensity of exposure, and site of exposure to the antigen. In a typical case, manifestations begin within 5–10 minutes after antigenic challenge. Reactions that appear more slowly tend to be less severe. Intervals longer than 2 hours leave the diagnosis of anaphylaxis open to question.

Table 21.1 Morbidity and Mortality from Systemic Anaphylaxis and Bronchial Asthma in the United States

	Morbidity	Mortality
Systemic anaphylaxis		
Caused by antibiotics	10–40:100,000 injections	1:100,000 injections
Caused by insect bites	10:100,000 persons/yr	10–80/yr
Asthma	10 million persons (4–5% of U.S. population)	5–30 years of age: 0.4/100,000/yr >60 years of age: 10:100,000/yr

Multiple organ systems are usually affected, including the skin (pruritus, flushing, urticaria, angioedema), respiratory tract (bronchospasm and laryngeal edema), and cardiovascular system (hypotension and cardiac arrhythmias).

As a rule, most of the acute manifestations subside within 1 or 2 hours. However, similar symptoms of variable intensity may occur 6–12 hours later. This late phase reaction results from cytokine release from activated basophils, secondary immune cell activation, and further elaboration and release of mediators of inflammation—mechanisms very similar to those responsible for the late phase of asthma.

When death occurs, it is usually due to laryngeal edema, intractable bronchospasm, hypotensive shock, or cardiac arrhythmias developing within the first 2 hours.

Atopy is defined as a genetically determined state of IgE-related disease. Its most common clinical manifestations include asthma, rhinitis, urticaria, and atopic dermatitis. Allergic asthma, by its potential severity and frequency, is the most important manifestation of atopy. However, not all cases of asthma are of proven allergic etiology. The differential characteristics of allergic (extrinsic) and nonallergic (intrinsic) asthma are summarized in Table 21.2. The major difference between both is the strong association of allergic asthma with specific IgE antibodies and eosinophils, both of which play important pathophysiological roles.

Table 21.2 Major Characteristics of Allergic and Nonallergic Bronchial Asthma

Symptoms	Dyspnea with prolonged expiratory phase; may be associated with cough and sputum	
Chest x-rays	Hyperlucency (reflecting impaired expiratory capacity), bronchial thickening	
	<i>Allergic</i>	<i>Nonallergic</i>
Blood	Eosinophilia	Normal eosinophil count
Sputum	Eosinophilia	No eosinophils
Total IgE	Raised	Normal
Antigen-specific IgE	Raised	None
Pathology	Obstruction of airways due to smooth muscle hypertrophy with constriction and mucosal edema Hypertrophy of mucous glands Eosinophil infiltration	
Frequency	Children: 80% ^a Adults: 60% ^a	20% 40%

^a % of total number of bronchial asthma cases seen in each age range.

Case 21.1

A 20-year-old female attending college in the Southeast presented to the infirmary with wheezing, nocturnal cough, and shortness of breath. She reported that since the fall she had worsening of her asthma as well as nasal congestion and paroxysms of sneezing. During the summer at her parents' residence in Los Alamos, New Mexico, she had minimal nasal congestion in the mornings. She admitted to a long history of mild wheezing as a child. This semester she resides in a home with several other students. There is a cat in the house, although she avoids it as it makes her eyes itch. Presently she uses her albuterol inhaler frequently during the day and at night.

On physical exam she was audibly wheezing and mildly tachypneic. Her conjunctivae were mildly injected. The nasal mucosa was edematous and pale with copious watery secretions. Ears were normal, and mouth was unremarkable. Auscultation of the chest revealed a prolonged expiratory phase with diffuse wheezing bilaterally. Extremities were without clubbing, cyanosis, or edema.

Lab data: complete blood count—Hgb = 13.5 g/dL; HCT = 39%; WBC = $9.8 \times 10^6/\mu\text{L}$ (normal 4.8–10.8); increased eosinophil count. Arterial blood gases: pH = 7.44; $\text{PCO}_2 = 38 \text{ mmHg}$; $\text{PO}_2 = 78 \text{ mmHg}$; O_2 saturation = 93%. IgE = 689 IU/mL. Chest x-ray: PA and lateral views of the chest revealed increased AP diameter and flattening of the diaphragms. There were no infiltrates or effusions. Ventilatory studies: Peak flow was 200 L/min with improvement to 320 L/min after treatment with nebulized albuterol. This case raises several questions:

What possible factors contributed to her respiratory problems?

Why does she have difficulty exhaling, though it improves with a beta-agonist?

What histopathological findings would be expected on a biopsy of the bronchial mucosa?

Which cytokines are critically involved in the pathogenesis of this patient's allergic disease?

What therapeutic agents are useful acutely and for long-term therapy?

III. PATHOGENESIS

The pathogenesis of immediate hypersensitivity reactions involves a well-defined sequence of events:

1. Synthesis of specific IgE antibodies.
2. Binding of IgE antibodies to $\text{Fc}_\epsilon\text{-I}$ receptors on basophils and mast cells; once bound, IgE acts as an antigen receptor.
3. Cross-linking of receptor-bound IgE by a multivalent antigen initiates the release of preformed vasoactive compounds and the synthesis and later release of mediators of inflammation.
4. The preformed substances released by basophils and mast cells have significant effects on target tissues, such as smooth muscle, vascular endothelium, and mucous glands. They also act as chemoattractant cytokines and may elicit central nervous system-mediated reflexes (e.g., sneezing).
5. Furthermore, activated basophils and mast cells can synthesize and express IL-4 and the CD40 ligand, both essential factors to stimulate IgE synthesis (see Chapter 11).

A. IgE Antibodies

Prausnitz and Küstner published the first demonstration that serum contains a factor capable of mediating specific allergic reactions in 1921. The injection of serum from a fish-allergic person (Küstner) into Dr. Prausnitz's skin and subsequent exposure of Dr. Prausnitz to fish antigen injected in the same site resulted in an allergic wheal and flare response.

In 1967 Ishizaka and collaborators isolated a new class of immunoglobulin, designated as IgE, from the serum of ragweed-allergic individuals. Several patients with IgE-producing plasmocytomas were subsequently discovered and provided a source of very large amounts of monoclonal IgE that greatly facilitated further studies of IgE structure and the production of anti-IgE antibodies.

1. Quantitative Assay of IgE Antibodies

The total IgE concentration, even in allergic individuals, is extremely low, not detectable by most routine assays used for the assay of IgG, IgA, and IgM. The concentration of specific IgE antibody to any given allergen is a very small fraction of the total IgE.

Early attempts to measure IgE involved cumbersome and often unreliable bioassays. The availability of anti-IgE antibodies allowed the development of radioimmunoassays sufficiently sensitive to determine total serum IgE and IgE antibody levels accurately.

The paper disc radioimmunosorbent test (PRIST) was one of the first solid-phase radioimmunoassays (see Chapter 15) introduced in diagnostic medicine. This assay, diagrammatically summarized in Figure 21.1, measures total serum IgE.

1. A serum sample is added to a small piece of adsorbent paper to which anti-IgE antibodies are covalently bound. The immobilized antibody captures IgE.
2. ^{125}I -labeled anti-IgE antibodies are subsequently added and will bind to the paper-bound-IgE. The radioactivity counted in the solid phase is directly related to the IgE level in the serum tested.
3. The results are expressed in nanograms/mL ($1 \text{ ng} = 10^{-6} \text{ mg}$) or in international units ($1 \text{ I.U.} = 2.5 \text{ ng/mL}$): 180 IU/mL is considered as the upper limit for normal adults. Allergic individuals often have elevated levels of IgE. However, some asymptomatic individuals may also have elevated IgE levels. Therefore, a diagnosis of immediate hypersensitivity cannot be based solely on the determination of abnormally elevated IgE levels.

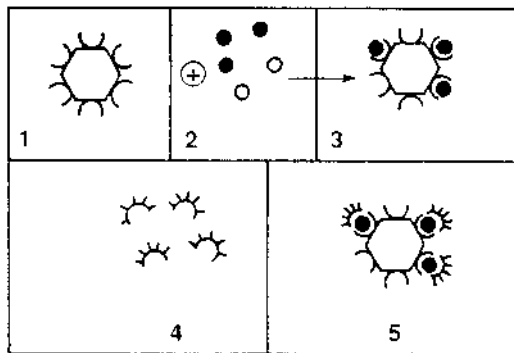

Fig. 21.1 Diagrammatic representation of the general principles of the radioimmunosorbent test for IgE quantitation.

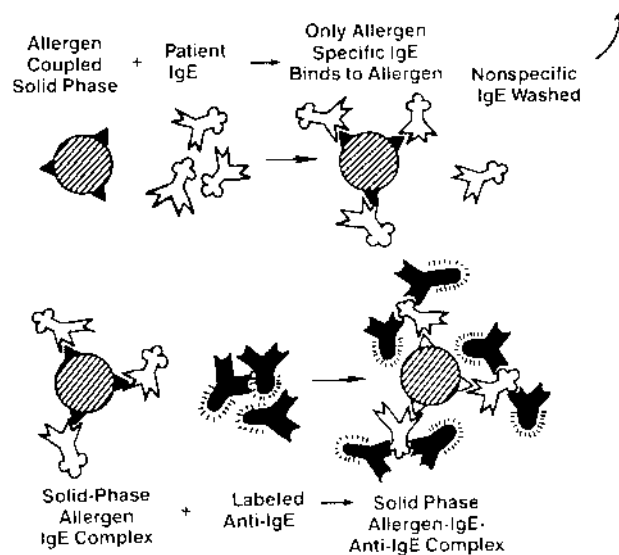

Fig. 21.2 Diagrammatic representation of the general principles of the radioallergosorbent test (RAST) for quantitation of specific IgE antibodies.

Sensitive EIA and quantitative fluorescence assays were later developed that are equally able to measure total IgE levels without the need for use of radiolabeled compounds.

The radioallergosorbent test (RAST), diagrammatically summarized in Figure 21.2, is a solid phase radioimmunoassay that determines antigen-specific IgE, which from the diagnostic point of view is considerably more relevant than the measurement of total serum IgE levels.

1. A given allergen (ragweed antigen, penicillin, β -lactoglobulin, etc.) is covalently bound to polydextran beads
2. Patient's serum is added to beads coated with a single antigen; the antigen-specific IgE, if present, will bind to the immobilized antigen.
3. After washing off unbound immunoglobulins, radiolabeled anti-IgE is added. The amount of bead-bound radioactivity counted after washing off unbound labeled antibody is directly related to the concentration of antigen-specific IgE present in the serum.

2. Skin Tests

Although the RAST assays are highly specific and accurate, they are expensive and lack sensitivity, and the range of antigens for which there are available tests is limited. In addition, some authors have cast doubts about the biological relevance of the RAST assay results. The alternative method for diagnosis of specific allergies is provocation skin tests, which allow testing to a wider array of antigens. Although positive skin tests depend on the existence of IgE antibodies, they do not allow a direct quantitative assay of such antibodies; rather, they provide information about their ability to mediate the hypersensitivity reaction. This explains the opinion of many specialists that the results of skin tests correlate better with clinical data than the results of the RAST assays.

The skin tests for immediate hypersensitivity are performed by injecting small amounts of purified allergens percutaneously or intradermally in known patterns. The patients are then observed for about 30 minutes to one hour. Classical IgE-mediated hypersensitivity reactions present as a wheal and flare at the site of the allergen exposure, which develops in a matter of minutes.

In highly sensitized individuals, there is always a risk of anaphylaxis, even after minimal challenge. Because of this risk, trained professionals should always perform these tests in a properly equipped clinical facility.

B. The IgE Antibody Response

IgE is predominantly synthesized in perimucosal lymphoid tissues of the respiratory and gastrointestinal tract. In developing countries the main antigenic stimulus for IgE synthesis are parasites (particularly nematodes). Levels of circulating IgE considered as normal in a developing country with endemic parasitism are two to three orders of magnitude higher than in the western world. The vast majority of allergens, which are either ingested or inhaled, stimulate the same perimucosal tissues. In the perimucosal tissues only B lymphocytes with membrane IgE will differentiate into IgE-producing plasma cells. Those IgE-carrying B cells are only a small fraction of the total B cell population in the submucosa but are overrepresented in the perimucosal lymphoid tissues compared to other lymphoid territories.

During the primary immune response to an allergen or a parasite, most of the IgE synthesized appears to be of low affinity. The changes occurring after a second exposure include the synthesis of IgE of progressively higher affinity, probably as a consequence of somatic hypermutations (see Chapters 7 and 12). This may be the reason why allergic reactions very seldom develop after the first exposure to an allergen. When a hypersensitivity reaction appears to develop after what seems to be a first exposure to any given allergen, one must consider the possibility of cross-reaction between a substance to which the individual was previously sensitized and the substance that elicits the allergic reaction. Such cross-reactions are usually due to molecular mimicry (see Chapter 16) and can be quite unpredictable.

Repeated exposures to parasites or allergens will stimulate the differentiation of memory cells and the proportion of circulating high-affinity antigen-specific IgE will also increase with repeated exposures. In patients suffering from severe pollen allergies, antigen-specific IgE may constitute up to 50% of the total IgE.

C. Genetic Control of IgE Synthesis

The study of total IgE levels in normal nonallergic individuals shows a distribution in three groups: high, intermediate, and low producers (Fig. 21.3). Family studies further suggested that the ability to produce high levels of IgE is a recessive trait, controlled by unknown genes independent of the HLA system. A candidate gene has been localized to chromosome 5(5q31–q33)—in close proximity to the genes for IL-4, IL-5, and IL-13. The gene in question seems not only to influence the synthesis of IgE, but also determines bronchial hyperresponsiveness to histamine and other mediators.

On the other hand, the tendency to develop allergic disorders in response to specific allergens is HLA linked. For instance, the ability to produce antigen-specific IgE after exposure to the Ra5 antigen of ragweed is observed more often in HLA B7, DR2 individuals

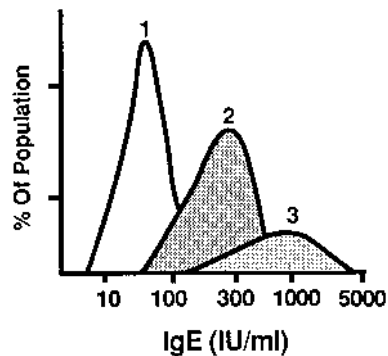

Fig. 21.3 Distribution of IgE levels in a population of nonallergic individuals. Three subpopulations appear to exist: one constituted by low-responder individuals (1), one by high-responder individuals (3), and a third population of individuals with intermediate levels of IgE (2).

than in the general population. Recent studies suggest that various MHC class II antigens are associated with high responses to many different allergens (Fig. 21.4). The biological basis for the association between MHC-II molecules and allergic predisposition is believed to be one of the many expressions of the control exerted by APC on the immune response. This theory is based on the assumption that the MHC-II repertoire determines what antigen-derived peptides are most efficiently presented to helper T cells.

The genes controlling high IgE levels and high IgE antibody synthesis after exposure to allergens appear to have synergistic effects. For example, an HLA B7, DR2 individual who is also genetically predisposed to produce high levels of IgE is likely to have a more severe allergic disorder than an individual without this genetic combination.

D. T-B Cell Cooperation in IgE Antibody Responses

The role of activated T_H2 cells in type I hypersensitivity reaction has been emphasized in recent years. Production of high levels of IgE has been shown to be dependent on the acti-

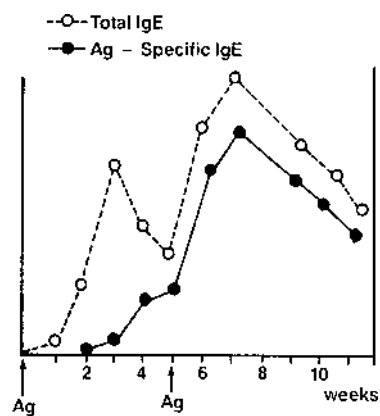

Fig. 21.4 Longitudinal evolution of total IgE and antigen-specific IgE levels during an immune response to an allergen.

vation of IL-4-producing T_H2 cells as well as on the delivery of co-activating signals involving CD28/CD80 and CD40/CD40L. IL-4 has been clearly demonstrated to promote IgE synthesis by activated B lymphocytes. In addition, IL-4 is both a growth and differentiation factor for mast cells and basophils, causing their number to increase in all tissues where they will be able to bind more IgE. IL-5, which is produced at the same time by the same activated CD4 lymphocytes, is believed to play a role in the late phase of allergic reactions, which is discussed later in this chapter.

Both in humans and animal models the production of allergen-specific IgE in humans persists long after the second exposure. This may result from the capture of IgE-containing immune complexes by dendritic cells, which express the Fc_ϵ -RII (CD23). Membrane-bound immune complexes are known to persist for longer periods of time, constantly stimulating B cells and promoting the persistence of secondary immune responses and the differentiation of antibodies with increased affinity (see Chapter 12). At the same time, other immune complexes, perhaps containing IgG antibody, will be internalized, processed, and be the source of allergen-derived peptides that will continue to activate the T_H2 subpopulation.

E. Interaction of IgE with Cell Surface Receptors

Two types of Fc receptors reacting with IgE molecules have been characterized.

A unique high-affinity receptor designated as Fc_ϵ -RI, expressed on the surface of basophils and mast cells. Most IgE antibodies interact with this receptor and become cell-associated soon after secretion from plasma cells.

The structure of the Fc_ϵ -RI is unique among the well-characterized lymphoid cell receptors. It is composed of three subunits: a heterodimer formed by the interaction of two chains (α and β), and a homodimer of a third type of chain (γ chain). The whole molecule is therefore designated as $\alpha\beta\gamma_2$ (Fig. 21.5). The external domain of the α chain binds the Fc portion of IgE. The β and γ chains function as signal transduction units. Both of them contain ITAM motifs (see Chapter 4). Cross-linking of the Fc_ϵ -RI results in activation of the protein kinase Lyn, which phosphorylates ITAM tyrosines, leading then to the activation of other protein kinases, such as Syk, as well as of the integral membrane linker molecule LAT (see Chapter 11). The phosphorylation of Syk and LAT is followed by activation of signaling cascades, which eventually lead to the release of performed granules and to the expression of a variety of genes coding for cytokines, enzymes, etc.

The interaction between the Fc_ϵ -RI and IgE is consistent with a simple bimolecular forward reaction and a first-order reverse reaction:

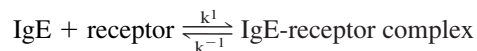

The affinity constant of the interaction, $KA = k^1/k^{-1}$ ranges from 10^8 to 10^{10} M/L⁻¹. Because of the high affinity of the interaction between IgE and this Fc_ϵ -RI, IgE binds rapidly and very strongly to cells expressing it and is released from these cells very slowly. Passively transferred IgE remains cell-bound for several weeks in the skin of normal humans. Because the mast cells and basophils do not produce IgE molecules, there is no clonal restriction at the mast cell/basophil level. Therefore, if the patient produces IgE antibodies to more than one allergen, each basophil or mast cell may bind IgE antibodies of different specificities.

The interaction between IgE and Fc_ϵ -RI does not result in cell activation. IgE serves as an antigen-receptor for mast cells and basophils. Receptor-bound IgE discriminates

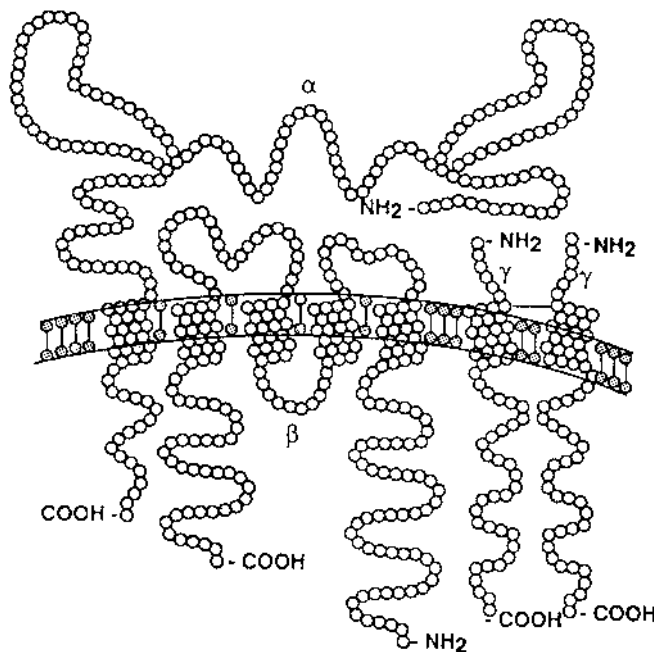

Fig. 21.5 Diagrammatic representation of the primary structure of the Fc_{ϵ} -RI. (Modified from Metzger, H. *Clin. Exp. Allergy* 21:1, 1991.)

among antigens, binding exclusively those to which the patient has become sensitized. Receptor-bound IgE must be cross-linked in order for basophils and mast cells to release their intracellular mediators (Fig. 21.6). The physiological cross-linking agent is the allergen, which is multivalent. Cross-linking of receptor bound IgE can also be induced with anti-IgE antibodies or with their divalent $F(ab')_2$ fragments. Unoccupied receptors may be cross-linked with aggregated Fc fragments of IgE. In contrast, mast cells and basophils with IgE-antihapten antibodies on their membranes, cannot be stimulated by soluble, univalent, haptens, because those are unable to cross-link membrane IgE molecules. Stimulation is only possible when carrier-bound haptens are used, because those can cross-link many IgE molecules.

All the types of cross-linking listed above are equally efficient in activating IgE-carrying mast cells and basophils. The details concerning the sequence of events in the ensuing activation cascade are still under investigation. The consequences of activation, however, are well known: release of granule contents into the extracellular space and activation of the synthesis of additional mediators.

Cross-linking of receptor-bound IgE is not the only signal leading to the liberation of mediators from basophils and mast cells; these cells also respond to C3a, C5a, basic lysosomal proteins, kinins, and autoantibodies of the IgG isotype directed against the α subunit of the Fc_{ϵ} -RI (these autoantibodies are detected in 40% of the patients with chronic idiopathic urticaria). It is apparent that there are multiple pathways for mast cell activation and that the participation of cell-bound IgE is not always needed.

Fc_{ϵ} -RII (CD23) is expressed on the membrane of lymphocytes, platelets, eosinophils, and dendritic cells and binds IgE with lower affinity than Fc_{ϵ} -RI. The role of Fc_{ϵ} -RII on

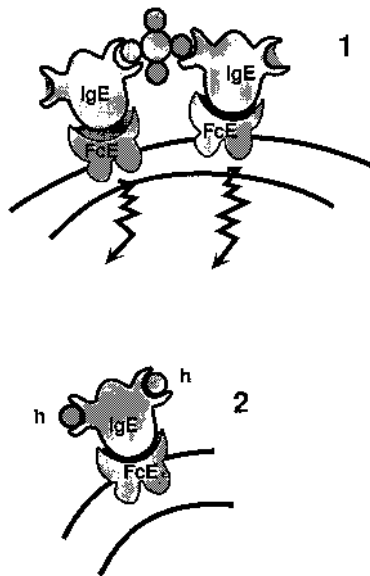

Fig. 21.6 Diagrammatic depiction of the conditions required for stimulation of mediator release by mast cells and basophils. In panel 1, the reaction of membrane-bound IgE with a polyvalent antigen, leading to cross-linking of IgE molecules, is represented. This type of reaction leads to mediator release. In panel 2, the reaction of membrane-bound IgE with a monovalent hapten is illustrated. This reaction does not lead to mediator release.

dendritic cells has been previously discussed, and it is supposed to be involved in targeting eosinophils to parasites in one of the different variations of ADCC; its effect on platelets and lymphocytes is unclear.

F. Early and Late Phases in Type I Hypersensitivity

1. Early Phase

The metachromatic cytoplasmic granules of basophils and mast cells contain a variety of preformed mediators (Table 21.3). After cross-linking of Fc-receptor associated IgE, mast cells and basophils undergo a series of biochemical and structural changes.

The first change to be detected is the polymerization of microtubules, which is energy-dependent (inhibited by 2-deoxyglucose), enhanced by the addition of 3',5'-guanosine monophosphate (GMP), and inhibited by the addition of 3',5'-adenosine monophosphate (AMP) and colchicine. The polymerization of microtubules allows the transport of the cytoplasmic granules to the cell membrane to which they fuse. This is followed by the opening of the granules and the release of histamine and other preformed mediators, such as platelet-activating factor (PAF) and chemotactic factors for eosinophils (ECFA), into the surrounding medium. In vitro, this sequence of events takes 30–60 seconds.

Histamine is the mediator responsible for most of the symptoms observed during the early phase of allergic reactions. Since the constricting effect of histamine on the smooth muscle lasts only 1 or 2 hours, this phase stops shortly after most of the granules have been emptied.

Table 21.3 Mediators of Immediate Hypersensitivity Produced by Mast Cells and Basophils

Mediators	Structure	Actions
Stored		
Histamine	5- β -Imidazolylethylamine (MW 111)	Smooth muscle contraction; increased vascular permeability; many others
Eosinophil chemotactic factors of anaphylaxis (ECF-A)	Acidic tetrapeptides (MW 360–390); others (MW 500–3000)	Chemotactic for eosinophils
Proteolytic enzymes	Tryptase, chymase, and other enzymes in human mast cells	Actions in vivo unknown; possibly include C' activation
Heparin	Acidic proteoglycan (MW \approx 50,000)	Anticoagulant; C' inhibitor
Neutrophil chemotactic factor	Poorly characterized activity with MW > 750,000	Chemotactic for neutrophils
Other granulo proteins	Numerous poorly characterized peptides	In vivo significance not yet known
Newly synthesized (upon stimulation of mast cells of basophils)		
Slow-reacting substance of anaphylaxis (SRS-A)	Leukotrienes C ₄ , D ₄ , E ₄ (derived from arachidonic acid, MW 439–625) ^a	Smooth muscle contraction; increased vascular permeability; glandular hypersecretion
Prostaglandin D ₂	Cyclooxygenase, product of arachidonic acid ^b	Smooth muscle contraction
Platelet activating factor (PAF)	Phospholipid (MW 300–500) ^c	Platelet aggregation and release reaction; increased vascular permeability; eosinophil chemotaxis
Leukotriene B ₄	Eicosotetraenoate product of arachidonic acid (MW 336)	Chemotactic for eosinophils and neutrophils; neutrophil aggregation

^a Also released by activated eosinophils.

^b Produced exclusively mast cells.

^c Also stored as a preformed mediator.

Platelet-activating factor (PAF), a mediator rapidly released after basophil/mast cell activation, is a phospholipid whose effects include platelet aggregation, chemotaxis of eosinophils, release of vasoactive amines, and increased vascular permeability (both due to a direct effect and to the release of vasoactive amines). PAF is also released by neutrophils and other cells.

2. Late Phase

The cells remain viable after degranulation and proceed to synthesize other substances, which will be released at a later time, causing the late phase of a type I hypersensitivity reaction. The mediators responsible for the late phase of the response are not detected until several hours after release of histamine and other preformed mediators. The long latency period between cell stimulation and detection of these mediators suggest that they are

synthesized by mast cells after stimulation and/or by cells attracted by the above-mentioned chemotactic factors. The main mediators involved in the late phase are leukotrienes C₄, D₄, and E₄ [LTC₄, LTD₄, LTE₄, slow reacting substance of anaphylaxis (SRS-A)]. This mixture of leukotrienes previously known as SRS-A reaches effective concentrations only 5–6 hours after challenge and have effects on target cells lasting for several hours. LTC₄ and LTD₄ are several fold more potent than histamine in causing smooth muscle contraction, bronchovascular leak, and mucous hypersecretion in human bronchi.

3. *Role of Eosinophils in the Late Phase*

Eosinophils are attracted to the site where an immediate hypersensitivity reaction is taking place by chemotactic factors released by basophils, mast cells, and T_H2 lymphocytes:

ECFA and PAF, preformed chemotactic factors released during basophil or mast cell degranulation

Leukotriene B₄, synthesized and released by stimulated basophils/mast cells

Interleukin-5, released by activated T_H2 lymphocytes, mast cells, and eosinophils

In many cases, the appearance of eosinophils signals the onset of internal negative feedback and control mechanisms that terminate the immediate hypersensitivity reaction. This effect is associated with the production and release of enzymes, particularly histaminase (which degrades histamine) and phospholipase D (which degrades PAF). Active oxygen radicals released by stimulated granulocytes, including eosinophils and perhaps neutrophils (which are also attracted by ECF-A and LTB₄), cause the breakdown of leukotrienes. Histamine itself can contribute to the downregulation of the allergic reaction by binding to a type II histamine receptor expressed on basophils and mast cells; the occupancy of this receptor leads to an intracellular increase in the level of cAMP which inhibits further release of histamine (negative feedback).

In contrast, persistent eosinophil infiltrates are associated with intense inflammation that causes prolongation of symptoms. For example, asthmatic patients may develop a prolonged crisis during which the symptoms remain severe, and breathing becomes progressively more difficult, leading to a situation of increasing respiratory distress, which does not respond to the usual treatment.

In these patients it is frequent to find very heavy peribronchial cellular infiltrates of the epithelium and lamina propria, where eosinophils predominate, but containing also T lymphocytes and plasma cells (chronic eosinophilic bronchitis). The infiltrating lymphocytes are mostly activated CD4, CD25⁺ T lymphocytes, whose cytokine mRNA pattern is typical of the T_H2 subpopulation.

Three major cytokines released by T_H2 cells are believed to play significant roles in immediate hypersensitivity reactions, particularly in bronchial asthma:

1. IL-4 is a critical factor in promoting T_H2-cell differentiation, B-cell activation, and switch to IgE synthesis
2. IL-13, a cytokine related to IL-4, has been shown in experimental animal models to induce the pathophysiological features of asthma in an IgE and eosinophil-independent manner. This observations raise the interesting possibility that asthma may be mediated not only by IgE-producing B cells, but also by activated T_H2 cells.
3. IL-5 released from the infiltrating activated T_H2 lymphocytes seems to attract, retain, and activate eosinophils. Activated eosinophils release leukotrienes and

two toxic proteins: eosinophilic cationic protein and major basic protein. These proteins decrease ciliary movement, are cytotoxic for bronchial epithelium, and cause nonspecific bronchial hyperactivity and cellular denudation. This is believed to be a critical step in the pathogenesis of chronic airways inflammation that after decades may lead to chronic obstructive pulmonary disease with irreversible remodeling of the airways.

A similar pathogenic sequence seems responsible for a state of bronchial hyperresponsiveness to many stimuli that develops in the wake of an asthma crisis.

The severity of the clinical symptoms in an immediate hypersensitivity reaction is directly related to the amount of mediators released and produced, which in turn is determined by the number of “sensitized” cells stimulated by the antigen. The expression of early and late phases can be distinguished clinically:

In the case of a positive immediate reaction elicited by a skin test, the early phase resolves in 30–60 minutes; the late phase generally peaks at 6–8 hours and resolves at 24 hours.

In the case of an asthma crisis, the early phase is characterized by shortness of breath and nonproductive cough and lasts 4–5 hours. If the exposure to the responsible airborne allergen is very intense, life-threatening bronchospasm may develop. With less intense or chronic exposure, the initial symptoms of wheezing and dry cough will linger for a few hours.

Around the sixth hour, the cough starts to produce sputum, signaling the onset of the late phase during which the dyspnea may become more severe. In very severe cases, death may occur at this late stage because of persistent bronchoconstriction and peribronchial inflammation associated with increased mucous secretion, both factors contributing to severe airflow obstruction.

III. PREVENTION AND THERAPY

A. Prevention

Environmental control—trying to prevent exposure to the allergen—is possible for individuals sensitized to a limited number of allergens; however, it cannot be easily achieved by individuals sensitized with multiple or ubiquitous allergens.

Hyposensitization is the standard of care in individuals with insect venom IgE-mediated hypersensitivity and has beneficial results in patients suffering from pollen and perennial allergies (i.e., dust mites, cat dander). Hyposensitization is achieved by subcutaneous injection of very small quantities of the sensitizing antigen, starting at the nanogram level, and increasing the dosage on a weekly basis. This induces the production of IgG blocking antibodies and an increase in the number of regulatory cells able to turn off the production of IgE antibodies, as reflected by a decline of serum IgE levels. Because both effects tend to be simultaneous, they appear to correlate with a decrease of the allergic symptoms (Fig. 21.7).

Conceptually, circulating blocking antibodies of the IgG class should have a protective effect by combining with the antigen before it reaches the cell-bound IgE. In fact, a significant clinical improvement correlates better with an increase in blocking IgG than with a decrease in antigen-specific IgE.

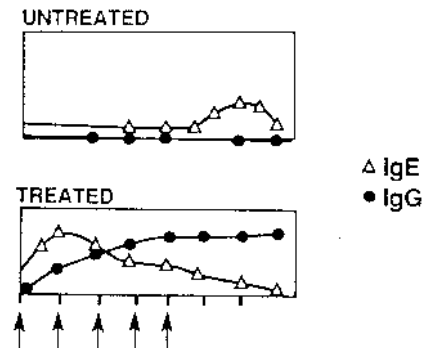

Fig. 21.7 Evolution of allergen-specific IgE and IgG levels in patients submitted to hyposensitization (treated) and control patients (untreated).

The beneficial effect of the competition between IgG and IgE antibodies is easy to understand in cases of insect venom anaphylaxis in which the allergen is injected directly in the circulation where it can be “blocked” by circulating IgG; however, it is more difficult to understand the protective mechanism involved in respiratory allergies, when the allergen has almost direct access to the sensitized cells without entering the systemic circulation. It must be stressed, however, that the results of hyposensitization in respiratory allergies are not as consistent as the results of hyposensitization against insect venoms.

For unclear reasons, IgG blocking antibodies do not interfere with a RAST assay for IgE antibodies. Therefore, a successfully hyposensitized patient may show persistently abnormal results in the RAST assay.

B. Drug Therapy

Various drugs are used to treat or prevent immediate hypersensitivity reactions. Some inhibit or decrease mediator’s release by mast cells or basophils; others block or reverse the effect of mediators. The complex interactions of different drugs able to influence mediator release are summarized in Figure 21.8.

Localized allergic reactions [seasonal rhinitis (hay fever), perennial rhinitis, and urticaria] respond often favorably to antihistaminic compounds, which compete with histamine in the binding to their type I receptors at the target cell level. Systemic reactions often require very aggressive and urgent measures, particularly the administration of epinephrine (see below).

Bronchial asthma presents very complex therapeutic problems. Current therapy is based upon the understanding that an initial acute bronchoconstrictive attack is followed by progressive inflammation in the airways and, later, by increased bronchial responsiveness. Each phase requires a different treatment.

1. Early Phase

In the early phase, relief of bronchial obstruction is the initial therapeutic goal. β -Adrenergic agonists, methylxanthines, and anticholinergic compounds are the main drugs used.

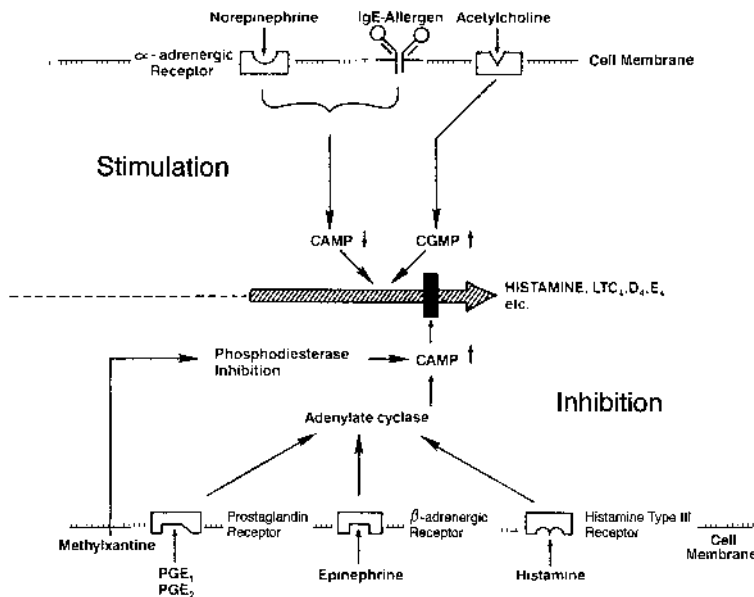

Fig. 21.8 Diagrammatic representation of the major pathways leading to stimulation and inhibition of mediator release by basophils and mast cells. (Modified from David, J., and Rocklin, R. E. Immediate hypersensitivity. In *Scientific American Medicine*, E. Rubinstein and D. D. Federman, eds. Scientific American, Inc., New York, 1983.)

β -Adrenergic receptor agonists (epinephrine, isoproterenol, and albuterol) increase cAMP levels by stimulating membrane adenylylase directly, inhibiting further degranulation of mast cells and basophils. As stated earlier, epinephrine is the drug of choice for treatment of severe allergic reactions such as anaphylaxis or severe asthma. However, these drugs do not affect eosinophils so that when patients have significant peribronchial eosinophilic inflammation, administration of β -agonists will have diminishing benefits. The patient will have a tendency to increase their use to try to achieve symptomatic relief. But since eosinophils are unaffected, the bronchitis progresses and can reach a stage at which the patient is at risk of death or near death. A patient's increasing need for β -agonists should be considered a sign of worsening lower airway inflammation.

Methylxanthines (e.g., theophylline) block phosphodiesterases, leading to a persistently high intracellular level of cAMP, which in turn inhibits histamine release. However, recent studies have led us to question this interpretation because the levels of serum methylxanthine reached during the treatments are much lower than those needed to inhibit phosphodiesterases.

Most cholinergic agents, raising intracellular levels of cyclic GMP, have an enhancing effect on mediator release: their use must be avoided in asthmatic patients since they aggravate the symptoms. On the opposite side, anticholinergic drugs that block vagal cholinergic tone may be useful but are not as efficient as β -agonists.

2. Late Phase

In the late phase, treatment needs to focus on the eosinophilic bronchitis, an inflammatory reaction no longer responding to the agents useful for treatment in the early phase. Therefore, the treatment's goals are quite different and will include locally administered corticosteroids, cromolyn, and leukotriene-modifying drugs.

Glucocorticoids have no direct action on IgE synthesis or mast cell degranulation in the lung but strongly inhibit eosinophil degranulation, and thus they have an excellent anti-inflammatory effect that inhibits the progression of the late phase, preventing or reducing bronchial hyperresponsiveness.

These effects can be achieved safely through the administration of glucocorticoids by aerosol, delivering small intrabronchial concentrations that result in local anti-inflammatory effects with low daily doses. This avoids the risk of systemic side effects previously incurred with chronic systemic administration. Glucocorticoids administered by aerosol are now recommended for the treatment of chronic asthma, irrespective of its degree or severity.

Systemic administration of glucocorticoids is reserved for the treatment of severe acute episodes, in order to prevent the development of the severe late phase reactions, or for the treatment of severe recalcitrant asthma.

Disodium cromoglycate (cromolyn) and nedocromil sodium (not shown in Fig. 21.8) are examples of prophylactic drugs. Their mechanism of action is still being investigated; however, it is believed that these drugs attenuate mast cell degranulation. Objectively, they decrease bronchoconstriction and have proven invaluable in helping to reduce the needs for glucocorticoids.

Several leukotriene-modifying drugs are being employed in the treatment of asthma. These agents include lipooxygenase enzyme inhibitors, which downregulate the production of leukotrienes, and leukotriene receptor antagonists that block the effects of leukotrienes. Presently they are used in mild forms of asthma or as adjuncts to inhaled glucocorticoids.

Case 21.1 Revisited

This 20-year-old college student with rhinitis and asthma represents an individual with atopic disease. She has symptoms consistent with inflammation in the upper and lower airways. Her environment changed with the new semester, and she had worsening of her allergic disease. It is probable that her exposure to cat allergens, as well as increased levels of mold and dust mite allergens, is contributing to her most severe symptoms.

When allergens enter the airways during respiration, they induce an allergic response in the respiratory mucosa. In the nasal airways, the inflammation and glandular hypersecretion results in nasal airway obstruction. In the lower airway the main changes are an eosinophilic inflammation associated with smooth muscle hypertrophy, mucosal edema, glandular hypersecretion, and bronchospasm. These changes in the lower airway result in a reduction of the airways caliber, which is more accentuated during expiration, causing air trapping and difficulty exhaling. The use of a beta-agonist results in smooth muscle relaxation and the ability to exhale against a lessened airway resistance.

A biopsy of the bronchial mucosa would reveal marked inflammation of the mucosa. There would be a cellular infiltrate with abundant eosinophils. Glandular hyperplasia and denudation of the ciliated epithelial cells would also likely be present. The basement membrane would appear thickened.

This patient's atopic disease is promoted by a predominantly T_H2 response. As a consequence of the release of large amounts of IL-4, a cytokine critical to the elaboration of

IgE, she has an elevated IgE and likely has specific IgE for allergens derived from sources such as mold spores, dust mites, and cat dander. In addition, the inflammation is typically eosinophilic, and IL-5 is a necessary chemokine for eosinophils.

Acutely, this patient needs to have relief of the airway obstruction. Bronchodilators, including inhaled beta-agonists and theophylline, would be used. Long term the patient would require anti-inflammatory agents. Initially, systemic glucocorticoids would be employed. However, for long-term therapy inhaled agents such as aerosolized glucocorticoids, inhaled cromolyn or nedocromil, and leukotriene-modifying agents would be preferred.

SELF-EVALUATION

Questions

Choose the one *best* answer.

- 21.1 Which of the following characteristics is associated with the Fc ϵ -RI?
 - A. Expression on lymphocytes, monocytes, and eosinophils
 - B. High affinity binding of its ligand
 - C. Involvement in antibody-dependent cellular cytotoxicity reactions
 - D. Lack of signaling properties
 - E. Structural classification as a member of the immunoglobulin superfamily
- 21.2 Which of the following agents are preferred for treatment of the chronic inflammatory component associated with moderate to severe asthma?
 - A. Aerosolized glucocorticoids
 - B. Antihistaminics
 - C. β -Adrenergic receptor stimulators
 - D. Methylxantines
 - E. Systemic glucocorticoids
- 21.3 Which of the following statements best characterizes the changes observed in IgE as a consequence of successful hyposensitization?
 - A. Combines with the injected allergen and forms circulating immune complexes
 - B. Decreases in serum
 - C. Increases in serum
 - D. Is not significantly affected
 - E. Is replaced by IgG at the cell membrane level
- 21.4 A 33-year-old female feels acutely ill a few minutes after eating oysters on the half-shell. She feels dizzy and passes out. The maitre d' asks for help from any physician in the house. Several clients come to the rescue and agree that the patient seems to be in shock. Which of the following medications would likely to be most effective in treating this patient?
 - A. Antihistaminics
 - B. Cholinergic drugs
 - C. Epinephrine
 - D. Methylxanthines
 - E. Sodium cromoglycate

- 21.5 Which of the following is coupled to the solid phase in a radioallergosorbent test (RAST) assay?
- A. A given allergen
 - B. Anti-IgE
 - C. Antibodies to a given allergen
 - D. IgE
 - E. The patient's serum
- 21.6 Which of the following newly synthesized mast cell mediators is responsible for the attraction of eosinophils to the peribronchial tissues in the late stages of an asthma attack?
- A. Eosinophil chemotactic factor A
 - B. Leukotriene B₄ (LTB₄)
 - C. Major basic protein
 - D. Platelet aggregation factor
 - E. Prostaglandin E₂
- 21.7 Which of the following reagents will be able to induce the release of histamine from the mast cells of a ragweed-sensitized individual?
- A. A univalent fragment of ragweed
 - B. F(ab')₂ from an anti-IgE antibody
 - C. Fab from an anti-IgE antibody
 - D. IgE antiragweed
 - E. IgG antiragweed
- 21.8 A major control mechanism of type I hypersensitivity reactions mediated by eosinophils is the release of:
- A. Cationic proteins
 - B. Histaminase
 - C. Leukotrienes C₄, D₄, and E₄
 - D. Major basic proteins
 - E. Platelet-activating factor
- 21.9 Which of the following mediators is not involved (directly or indirectly) in negative-feedback reactions in immediate hypersensitivity?
- A. Active oxygen radicals
 - B. Eosinophil chemotactic factor A (ECF-A)
 - C. Histaminase
 - D. Phospholipase D
 - E. Prostaglandin D₂
- 21.10 What is the meaning of the incidental finding of an elevated serum IgE level of 500 IU/mL in a clinically asymptomatic individual?
- A. The subject is atopic.
 - B. HLA-B7 is likely to be represented on the individual's phenotype.
 - C. Hyposensitization is not likely to be effective.
 - D. The individual is a high IgE producer.
 - E. The individual will definitely develop allergies.

Answers

- 21.1 (B) The Fc_ε-RI is the Fc receptor with the highest affinity for its ligand (IgE). It is only expressed on basophils and mast cells, which do not mediate ADCC reactions, and is structurally unrelated to the immunoglobulin superfamily.

- 21.2 (A) Aerosolized glucocorticoids are preferred to systemic glucocorticoids because they are effective in most cases with less risk of development of side effects. Antihistaminics and methylxanthines may have anti-inflammatory properties, but they are not sufficiently effective to be useful as primary treatment for chronic asthma.
- 21.3 (B) Hyposensitization appeared to induce and/or to increase the activity regulatory cells able to turn off the synthesis of IgE antibodies. This immunoregulatory modulation is reflected by a decrease in serum IgE levels.
- 21.4 (C) This patient appears to have developed anaphylactic shock after ingesting raw oysters. Epinephrine is the drug of choice for immediate treatment of life-threatening anaphylaxis.
- 21.5 (A) The allergen is coupled to the solid phase; if IgE antibodies are present in the patient's serum they will become bound to the antigen in the solid phase, and their presence can be revealed with a radiolabeled anti-IgE antibody.
- 21.6 (B) The two other chemotactic factors for eosinophils, platelet-activating factor (PAF) and eosinophil chemotactic factor A (ECF-A), are released in the early phase.
- 21.7 (B) The release of histamine requires the cross-linking of membrane IgE, which can be induced either by complete anti-IgE antibodies, bivalent F(ab')₂ fragments of anti-IgE antibodies, or multivalent antigen of the right specificity.
- 21.8 (B)
- 21.9 (E) Active oxygen radicals inactivate leukotrienes; phospholipase D degrades PAF; histaminase degrades histamine; ECF-A is chemotactic for eosinophils, which release phospholipase D, histaminase, and other protective factors.
- 21.10 (D) Some nonallergic individuals may have IgE values above the upper normal limit. It is not possible to conclude that an individual with high IgE levels will definitely develop an allergic disease.

BIBLIOGRAPHY

- Bochner B. S., Udem B. J., and Lichtenstein L. M. Immunological aspects of asthma. *Ann. Rev. Immunol.* 12:295, 1994.
- Burrows, B., and Lebowitz, M. D. The β -agonist dilemma. *N. Engl. J. Med.* 326:560, 1992.
- Geha, R. S. Regulation of IgE synthesis in humans. *J. Allergy Clin. Immunol.* 90:143, 1992.
- Goetzl, E. J., Payan, D. G., and Goldman, D. W. Immunopathogenetic role of leukotrienes in human diseases. *J. Clin. Immunol.* 4:79, 1984.
- Kon, O. M., and Kay, A. B. T cells and chronic asthma. *Internat. Arch. Allergy Immunol.* 118:133, 1999.
- Postma, D., Bleecker, E. R., Amelung, P. J., Holroyd, K. J. Jianfeng, X., Panhuysen, C. U. V., Meyers, D., Levitt, R. C. Genetic susceptibility to asthma-bronchial hyperresponsiveness coinherited with a major gene for atopy. *N. Engl. J. Med.* 333:894, 1995.
- Rolland, J. Immunotherapy of allergy: anergy, deletion, and immune deviation. *Curr. Opin. Immunol.* 10:640, 1998.
- Saitoh, S., Arudchandran, R., Manetz, T. S., et al. LAT is essential for Fc ϵ RI-mediated mast cell activation. *Immunity* 12:525, 2000.

- Weller, P. F. The immunobiology of eosinophils. *N. Engl. J. Med.* 324:1110, 1991.
- Wills-Kapp, M., Luyimbazi, J., Xu, X., et al. Interleukin-13: Central mediator of allergic asthma. *Science* 282:2258, 1998.
- Yssel, H., Abbal, C., Pene, J., and Bousquet, J. The role of IgE in asthma. *Clin. Exp. Allergy* 28 (Suppl 5):104, 1998.
- Yssel, H., and Groux, H. Characterization of T cell subpopulations involved in the pathogenesis of asthma and allergic diseases. *Int. Arch. Allergy Immunol.* 121:10, 2000.

22

Immunohematology

Gabriel Virella and Mary Ann Spivey

I. INTRODUCTION: BLOOD GROUPS

A. The ABO System

The first human red cell antigen system to be characterized was the ABO blood group system. Specificity is determined by the terminal sugar in an oligosaccharide backbone structure. The terminal sugars of the oligosaccharides defining groups A and B are immunogenic. In group O the precursor H oligosaccharide is unaltered. The red cells express either A, B, both A and B, or neither, and antibodies are found in serum to antigens not expressed, as shown in Table 22.1.

The ABO group of a given individual is determined by testing both cells and serum. The subject's red cells are mixed with serum containing known antibody, and his serum is tested against cells possessing known antigen. For example, the cells of a group A individual are agglutinated by anti-A serum but not by anti-B serum, and his serum agglutinates type B cells but not type A cells. The typing of cells as group O is done by exclusion (a cell not reacting with anti-A or anti-B is considered to be of blood group O).

The anti-A and anti-B isoagglutinins are synthesized as a consequence of cross-immunization with Enterobacteriaceae that have outer membrane oligosaccharides strikingly similar to those that define the A and B antigens (see Chapter 14). For example, a newborn with group A blood will not have anti-B in his serum, since it has had no opportunity to undergo cross-immunization. When his intestine is eventually colonized by the normal microbial flora, the infant will start to develop anti-B, but will not produce anti-A because of his tolerance to his own blood group antigens (see Table 22.1).

Table 22.1 The ABO System

Red cell antigen	Serum isoagglutinins	Blood group
A	Anti-B	A
B	Anti-A	B
A and B	None	AB
None	Anti-A and -B	O

The inheritance of the ABO groups follows simple Mendelian rules, with three common allelic genes—*A*, *B*, and *O* (*A* can be subdivided into A_1 and A_2)—of which any individual will carry two, one inherited from the mother, and one from the father.

B. The Rh System

1. Historical Overview

In the late 1930s it was discovered that the sera of most women who gave birth to infants with hemolytic disease contained an antibody that reacted with the red cells of their infants and with the red cells of 85% of Caucasians. A year later it was discovered that a reagent produced by injecting blood from the monkey *Macacus rhesus* into rabbits and guinea pigs agglutinated Rhesus red cells and appeared to have the same specificity as the neonatal antibody. Individuals whose cells reacted with the reagent were termed Rh-positive (for the Rhesus monkey); those whose cells were not agglutinated were termed Rh-negative.

2. Theories, Nomenclatures, and Antigens of the Rh system

The Rh system is now known to have many antigens in addition to the one originally described, and several nomenclature systems were developed. For practical purposes the Fisher-Race nomenclature is now used almost exclusively. Fisher and Race originally postulated that the Rh gene complex is formed by combinations of three pairs of allelic genes: *Cc*, *Dd*, *Ee*. This was later modified to a model that proposed a single genetic locus with three subloci. The possible combinations are: *Dce*, *DCE*, *DcE*, *DCE*, *dce*, *dCe*, *dcE*, and *dCE*. Thus a *DCE/dcE* individual can only pass *DCE* or *DcE* to his offspring and no other combination. The original antigen discovered is called D, and people who possess it are called Rh-positive. The antigen d has never been discovered, and the symbol “d” is used to denote the absence of D. All individuals lacking the D antigen are termed Rh-negative. The most frequent genotype of D-negative individuals is *dca/dce*.

Recent studies analyzing DNA from donors of different Rh phenotypes have found that there are neither three nor one locus governing Rh but that there are two structural loci governing Rh in Rh (D)-positive individuals and only one present in Rh-negative persons. Therefore, one gene appears to encode the D protein and the other governs the presence of the C, c, E, and e antigens. Since most Rh-negative persons completely lack a *D* gene and have nothing in its place, and the few others appear to have a partial or inactive *D* gene, it is easier to understand why a d antigen does not exist.

C. Other Blood Groups

Several other blood group systems with clinical relevance have been characterized. Most transfusion reactions other than those caused by clerical error are due to alloimmunization to antigens of the Kell, Duffy, and Kidd systems, of which the Kell system is the most polymorphic. Occasionally antibodies to these antigens may cause hemolytic disease of the newborn. On the other hand, most cases of autoimmune hemolytic anemia involve autoantibodies directed to public antigens (antigens common to most, if not all, humans), such as the I antigen or core Rh antigens.

There are over 200 blood group antigens in addition to those of the ABO and Rh systems. Some of the most important blood groups are seen in Table 22.2 Blood group antigenic determinants are either carbohydrate or protein in nature. Upon exposure to foreign carbohydrate antigens, IgM antibodies are predominantly produced while IgG antibodies predominate after immunization to proteinborne blood group antigens. Many IgM antibodies have a low thermal amplitude (i.e., react better at temperatures below normal body temperature) and may lack clinical significance.

Many of the proteins recognized as blood group antigens are important to the integrity of the red blood cell. This does not appear to be true of the carbohydrate antigens. Some blood groups have known associated biological functions such as the Duffy glycoprotein that is the receptor for *Plasmodium vivax*, which causes malaria. The Duffy glycoprotein also has recently been shown to be a chemokine receptor able to bind both C-X-C and C-C chemokines (see Chapter 11), and for this reason has been renamed as Duffy antigen receptor for chemokines (DARC). Its function on the mature red cell membrane is not known. Another known function of some blood groups is transport, and the Kidd protein is the urea transporter. Many carbohydrate antigens bind bacteria, for example, the P antigen, which binds *Escherichia coli*, and the Lewis system Le^b antigen on gastric epithelial cells, which binds *Helicobacter pylori*, the organism implicated in gastritis, gastric ulcers, and gastric carcinoma.

Table 22.2 Characteristics of Some Common Blood Group Antigens and Antibodies

Blood group	Antigen structure	Usual antibodies	Clinical significance	
			HTR ^a	HDN ^b
ABO	Carbohydrate	Anti-A, -B	Yes	Yes (mild)
Rh	Protein	Anti-D, E, c	Yes	Yes
Kell	Protein	Anti-K	Yes	Yes
Kidd	Protein	Anti-Jk ^a , -Jk ^b	Yes	Few
Duffy	Glycoprotein	Anti-Fy ^a , -Fy ^b	Yes	Yes
MNS	Glycoprotein	Anti-M	Few	Few
P	Carbohydrate	Anti-P ₁	Rare	No
Lewis	Carbohydrate	Anti-Le ^a , -Le ^b	Few	No
I	Carbohydrate	Autoanti-I	No ^c	No ^c

^a HTR, hemolytic transfusion reaction.

^b HDN, hemolytic disease of the newborn.

^c The clinical significance of anti-I antibodies relates to a special form of autoimmune hemolytic anemia, known as cold agglutinin disease.

II. SEROLOGICAL PRINCIPLES OF BLOOD TRANSFUSION

A. Laboratory Determination of Blood Types

1. Reagents

Most reagents used for blood group typing consist of monoclonal antibodies, usually of mouse origin, used individually or blended, directed against the different blood group antigens. A major advantage of the use of monoclonals is their specificity, minimizing the possibility of false-positive reactions due to additional contaminating antibodies found in human serum reagents. An important disadvantage derives from the fact that monoclonal antibodies react with a single epitope and the blood group antigens have multiple epitopes. Thus, individuals missing the epitope recognized by the antibody may be typed as negative. Using a blend of monoclonal antibodies, each one of them recognizing a different epitope of a given antigen, significantly reduces this problem.

2. Tests

Direct hemagglutination is the simplest, preferred test. It is easy to perform with typing reagents containing IgM antibodies that directly agglutinate cells expressing the corresponding antigen. Reagents containing IgG antibodies can also be used in a direct hemagglutination test. Protein is added in relatively high concentration to the reagent with the purpose of dissipating the repulsive forces that keep the red cells apart. As a consequence, IgG antibodies can directly agglutinate the red cells.

In general, reagents containing IgG antibodies are used in an indirect antiglobulin test (see below) as a way to induce the agglutination of red cells coated with the corresponding antibodies. The advent of monoclonal reagents has made it possible to do many typings by direct agglutination, which previously required the indirect antiglobulin test when only IgG human source reagents were available.

B. Direct and Indirect Antiglobulin (Coombs') Tests

In 1945, Coombs, Mourant, and Race described the use of antihuman globulin serum to detect red cell bound nonagglutinating antibodies. There are two basic types of antiglobulin or Coombs' tests.

1. Direct Antiglobulin Test

The direct antiglobulin test is performed to detect *in vivo* sensitization of red cells or, in other words, sensitization that has occurred in the patient (Fig. 22.1). The test is performed by adding antihuman IgG (and/or antihuman complement, to react with complement components bound to the red cells as a consequence of the antigen-antibody reaction) to the patient's washed red cells. If IgG antibody is bound to the red cells, agglutination (positive result) is observed after addition of the antiglobulin reagent and centrifugation. The direct antiglobulin test is an aid in the diagnosis and investigation of:

- Hemolytic disease of the newborn
- Autoimmune hemolytic anemia
- Drug-induced hemolytic anemia
- Hemolytic transfusion reactions

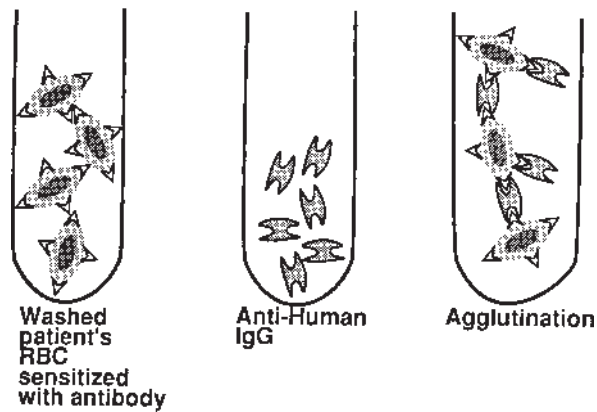

Fig. 22.1 Diagrammatic representation of a direct Coombs' test using anti-IgG antibodies.

2. *Indirect Antiglobulin Test*

The indirect antiglobulin test detects *in vitro* sensitization, i.e., sensitization that has been allowed to occur in the test tube under optimal conditions (Fig. 22.2). Therefore, the test is used to investigate the presence of nonagglutinating red cell antibodies in a patient's serum. The test is performed in two steps (hence the designation of "indirect"):

1. A serum suspected of containing red cell antibodies is incubated with normal red blood cells.
2. After washing unbound antibodies, antihuman IgG (and/or anticomplement) antibodies are added to the red cells as in the direct test.

The indirect antiglobulin test is useful in:

- Detecting and characterizing red cell antibodies using test cells of known antigenic composition (antibody screening)
- Cross-matching
- Phenotyping blood cells for antigens not demonstrable by other techniques

3. *Compatibility Testing*

Before a blood transfusion, a series of procedures need to be done to establish the proper selection of blood for the patient. Basically, those procedures try to establish the compatibility between donor and recipient ABO and Rh systems and to rule out the existence of antibodies in the recipient's serum that could react with transfused red cells. To establish the ABO and Rh compatibility between donor and recipient, both the recipient and the blood to be transfused are typed. To rule out the existence of antibodies (other than anti-A or anti-B), a general antibody screening test is performed with group O red cells of known composition. The O⁺ cells are first incubated with the patient's serum to check for agglutination; if this test is negative, an indirect antiglobulin (Coombs') test is performed.

4. *The Cross-Match*

The most direct way to detect antibodies in the recipient's serum that could cause hemolysis of the transfused red cells is to test the patient's serum with the donor's cells (major

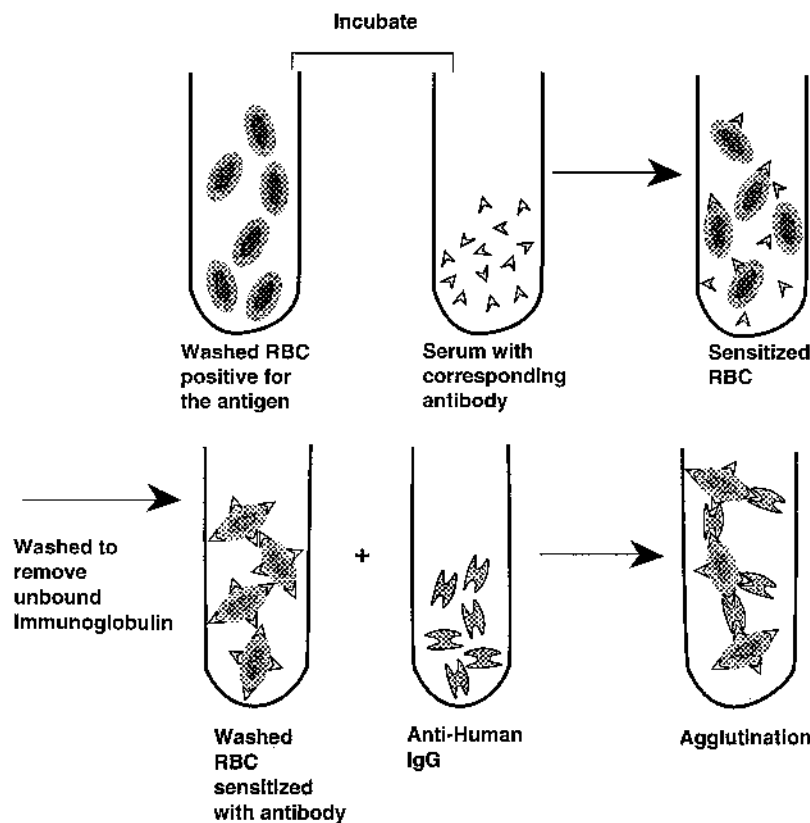

Fig. 22.2 Diagrammatic representation of an indirect Coombs' test.

cross-match). The complete cross-match also involves the same tests as the antibody screening test described above.

An abbreviated version of the cross-match is often performed in patients with a negative antibody screening test. This consists of immediately centrifuging a mixture of patient's serum and donor cells to detect agglutination; this primarily checks for ABO incompatibility.

The minor cross-match, which consists of testing patient's cells with donor serum is of little significance and rarely performed, since any donor antibodies would be greatly diluted in the recipient's plasma and rarely cause clinical problems.

5. Implications of Positive Antibody Screening for Transfusion

Donor blood found to contain clinically significant red cell antibodies must be issued as packed red cells, containing very little plasma, and thus can be safely transfused.

If a patient has a positive antibody screening test due to a clinically significant antibody, the antibody is identified using a panel of cells of known antigenic composition and antigen-negative blood is selected for transfusion.

C. Alternatives to Tube Testing

Newer methods that represent alternatives to the traditional tube test are being increasingly utilized in larger blood banks. These methods require little training, offer greater standardization and use a micro sample. The reactions are stable and may be rechecked by another technologist.

The gel test uses six microtubes in a card, replacing six test tubes. In each microtube a column of dextran acrylamide gel particles functions as a filter that traps agglutinates upon centrifugation. This technique may be used for antiglobulin tests where gels containing antiglobulin serum are used to trap sensitized but unagglutinated red cells. The red cells in a negative test will all centrifuge to the bottom of the microtube. The gel test is adaptable to typing, antibody screening, antibody identification, and cross-matching.

Solid-phase red cell adherence tests use immobilized antibody for the direct test. The red cells to be typed are added to antibody-coated wells in a polystyrene tray. The red cells will adhere in a monolayer across the well in a positive test but will settle to the bottom in a negative test. The indirect test uses red cells of known composition, which are immobilized in a monolayer. In order to demonstrate that a patient's serum has an antibody directed against a red cell sample, indicator red cells coated with anti-IgG are added after the immobilized red cells have been incubated with the patient's serum. If the immobilized cells have reacted with the patient's antibody, the reaction with the second batch of anti-IgG-coated erythrocytes results in red-cell effacement across the well. Antibody screening and identification may be done by the indirect test. Automated solid phase techniques are being used by some blood centers.

III. BLOOD TRANSFUSION REACTIONS

Transfusion reactions may occur due to a wide variety of causes (Table 22.3). Among them, the most severe are those associated with hemolysis, which may be life threatening. A list of the causes of fatal transfusion reactions reported to the U.S. FDA from 1985 to 1987 is reproduced in Table 22.4.

The most frequent cause is an ABO mismatch due to clerical error, resulting in transfusion of the wrong blood. Transfusion of blood incompatible for other blood groups to a patient previously sensitized during pregnancy or as a consequence of earlier transfusions can also cause a hemolytic reaction.

A. Intravascular Hemolytic Reactions

The binding of preformed IgM antibodies to the red cells triggers intravascular hemolytic transfusion reactions. IgM antibodies are very effective in causing the activation of the complement system. Massive complement activation by red cell antibodies causes in-

Table 22.3 Classification of Transfusion Reactions

A. Nonimmune
B. Immune
1. Red cell incompatibility
2. Incompatibilities associated with platelets and leukocytes
3. Incompatibilities due to anti-allotypic antibodies (anti-Gm or Am antibodies)

Table 22.4 Summary of Fatal Transfusion Reactions^a

Causes	No.
Hemolytic reactions	
ABO incompatible transfusions	29
Collection errors	7
Blood bank clerical errors	8
Blood bank technical errors	1
Nursing unit errors	11
Undetermined	2
Non-ABO incompatible transfusions ^b	6
No detectable antibody	3
Glycerol	1
Nonhemolytic reactions	
Bacterial contamination	11 ^c
Acute respiratory distress	9
Anaphylaxis	6

^a Reported to the Food and Drug Administration from 1985 to 1987.

^b Including anti-Jk^b, -c, Fy^a, and -K.

^c In nine cases, the source of contamination was a platelet preparation.

Source: Beig, K., Calhoun, A., and Petz, L. D. ISTB & AABB Joint Congress, Los Angeles, 1990, Abstract S282.

travascular red cell lysis, with release of hemoglobin into the circulation. Most intravascular reactions are due to ABO incompatibility. The direct antiglobulin test may be negative if donor cells are quickly lysed.

Due to the massive release of soluble complement fragments (e.g., C3a and C5a) with anaphylotoxic properties, the patient may suffer generalized vasodilatation, hypotension, and shock. Because of the interrelationships between the complement and clotting systems, disseminated intravascular coagulation may occur during a severe transfusion reaction. As a consequence of the nephrotoxicity of free hemoglobin, the patient may develop acute renal failure, usually due to acute tubular necrosis.

B. Extravascular Hemolytic Reactions

Extravascular hemolytic reactions are caused by the opsonization of red cells with IgG antibodies. IgG red cell antibodies can activate complement but do not cause spontaneous red cell lysis. Red cells opsonized with IgG (often with associated C3b) are efficiently taken up and destroyed by phagocytic cells, particularly splenic and hepatic macrophages.

These reactions are usually less severe than intravascular transfusion reactions. In addition, transfusion reactions may be delayed when an anamnestic response in a patient with undetectable antibody is the precipitating factor. Typically, a positive direct antiglobulin (Coombs') test will be noted after transfusion in association with a rapidly diminishing red cell concentration.

C. Clinical Presentation

The most common initial symptom in a hemolytic transfusion reaction is fever, frequently associated with chills. Red or wine-colored urine (due to hemoglobinuria) may be noted. With progression of the reaction, the patient may experience chest pains, dyspnea, hypotension, and shock. Renal damage is indicated by back pain, oliguria, and in most severe cases, anuria.

During surgery, the only symptom may be bleeding and/or hypotension. Generalized bleeding is the most serious manifestation of disseminated intravascular coagulation

D. Laboratory Investigation

Immediately after a hemolytic transfusion reaction is suspected, the following procedures must be carried out:

- A clerical check to detect any errors that may have resulted in the administration of a unit of blood to the wrong patient.

- Confirmation of intravascular hemolysis by visual or photometric comparison of pre- and postreaction plasma specimens for free hemoglobin (the prereaction specimen should be light yellow, and the postreaction sample should have a pink/red discoloration).

- Direct antiglobulin (Coombs') test on pre- and postreaction blood samples.

If any of the above procedures gives a positive result supporting a diagnosis of intravascular hemolysis, additional serological investigations are indicated, including the following:

- Repeat ABO and Rh typing on patient and donor samples.

- Repeat antibody screening and cross-matching.

- If an anti-red cell antibody is detected, determine its specificity using a red cell panel in which group O red cells of varied antigenic composition are incubated with the patient's serum to determine which RBC antigen(s) are recognized by the patient's antibody(ies).

Additionally, one or several of the following confirmatory tests may be performed:

- Measurement of unconjugated bilirubin on blood drawn 5–7 hours after transfusion (the concentration should rise as the released hemoglobin is processed).

- Determination of free hemoglobin and/or hemosiderin in the urine (neither is normally detected in the urine).

- Measurement of serum haptoglobin (if hemolysis is not apparent upon visual inspection of the serum).

E. Nonhemolytic Immune Transfusion Reactions

1. Antileukocyte Antibodies

When a patient has antibodies directed to leukocyte antigens, a transfusion of any blood product containing cells expressing those antigens can elicit a febrile transfusion reaction. Leukocyte-depleted blood products should be used for transfusions in patients with recurrent febrile reactions.

Special problems are presented by patients requiring platelet concentrates that have developed anti-HLA antibodies or antibodies directed to platelet-specific antigens (HPA antigens). In such cases, it will be necessary to give HLA or HPA-matched platelets, since platelets will be rapidly destroyed if given to a sensitized individual with circulating antibodies to the antigens expressed by the donor's platelets.

Transfusion of blood products containing antibodies to leukocyte antigens expressed by the patient receiving the transfusion can induce intravascular leukocyte aggregation. These aggregates are usually trapped in the pulmonary microcirculation, causing acute respiratory distress and, in some cases, noncardiogenic pulmonary edema. A similar situation may emerge when granulocyte concentrates are given to a patient with antileukocyte antibodies reactive with the transfused granulocytes.

2. Anti-IgA Antibodies

The transfusion of any IgA-containing blood product into a patient with preformed anti-IgA antibodies can cause an anaphylactic transfusion reaction. Transfusion reactions are not usually observed when the antibody titers (determined by passive hemagglutination) are low. Anti-IgA antibodies are mostly detected in immunodeficient individuals, particularly those with IgA deficiency.

It is very important to test for anti-IgA antibodies in any patient with known IgA deficiency that is going to require a transfusion, even if the patient has never been previously transfused. If an anti-IgA antibody is detected, it is important to administer packed red cells with all traces of plasma removed by extensive washing. If plasma products are needed, they should be obtained from IgA-deficient donors.

IV. HEMOLYTIC DISEASE OF THE NEWBORN (ERYTHROBLASTOSIS FETALIS)

Case 22.1

A 25-year-old gravida 1, para 0 woman who had not received prenatal care appeared at the emergency room just prior to delivering a 3.5 kg baby girl. The mother was found to be group O, Rh-negative, and her antibody screen was negative. Twenty hours later the nurse observed that the neonate was jaundiced. A hemogram with differential showed WBC of $6200/\mu\text{L}$, RBC of $4.1 \times 10^6 \mu\text{L}$, and hemoglobin of 15 g/dL. The differential showed 5% reticulocytes.

This case raises several questions:

1. *What is the most probable cause of the neonatal jaundice, and what treatment, if any, is usually indicated in such cases?*
2. *What laboratory tests should be ordered to investigate the cause of this newborn's jaundice?*
3. *Can this situation be prevented? How?*

A. Pathogenesis

Immunological destruction of fetal and/or newborn erythrocytes is likely to occur when IgG antibodies are present in the maternal circulation directed against the corresponding antigen(s) present on the fetal red blood cells (only IgG antibodies can cross the placenta and reach the fetal circulation).

The two types of incompatibility most usually involved in hemolytic disease of the newborn are anti-D and anti-A or -B antibodies. Anti-A or anti-B antibodies are usually IgM, but in some circumstances, IgG antibodies may develop (usually in group O mothers). This can be secondary to immune stimulation (some vaccines contain blood group substances or cross-reactive polysaccharides) or may occur without apparent cause for unknown reasons.

B. Mechanisms of Sensitization

Although the exchange of red cells between mother and fetus is prevented by the placental barrier during pregnancy, about two thirds of all women after delivery (or miscarriage) have fetal red cells in their circulation.

If the mother is Rh-negative and the infant Rh-positive, the mother may produce antibodies to the D antigen. The immune response is usually initiated at term, when large amounts of fetal red cells reach maternal circulation. In subsequent pregnancies, even the small number of red cells crossing the placenta during pregnancy are significant enough to elicit a strong secondary response, with production of IgG antibodies. As IgG antibodies are produced in larger amounts, they will cross the placenta, bind to the Rh-positive cells, and cause their destruction in the spleen through Fc-mediated phagocytosis. Usually, the first child is not affected, since the red cells that cross the placenta after the 28th week of gestation do so in small numbers and are unlikely to elicit a primary immune response.

IgG anti-D antibodies do not appear to activate the complement system, perhaps because the D antigenic sites on the red cell surface are too separated to allow the formation of IgG doublets with sufficient density of IgG molecules to induce complement activation. Complement, however, is not required for phagocytosis that can be mediated by the Fc receptors in monocytes and macrophages.

C. Epidemiology

Prior to the introduction of immunoprophylaxis, the frequency of clinically evident hemolytic disease of the newborn was estimated to be about 0.5% of total births, mostly due to anti-D, with a mortality rate close to 6% among affected newborns. Recent figures are considerably lower: 0.15–0.3% incidence of clinically evident disease, and the perinatal mortality rate appears to be declining to about 4% of affected newborns. Due to the introduction of immunoprophylaxis, the proportion of cases due to anti-D antibodies decreased, while the proportion of cases due to other Rh antibodies, and to antibodies to antigens of other systems, increased.

D. Clinical Presentation

The usual clinical features of this disease are anemia and jaundice present at birth or, more frequently, in the first 24 hours of life. In severe cases, the infant may die in utero. Unless treated appropriately, other severely affected children who survive until the third day develop signs of central nervous system damage, attributed to the high concentrations of unconjugated bilirubin (kernicterus). The peripheral blood shows reticulocytes and circulating erythroblasts (hence the term “erythroblastosis fetalis”).

E. Immunological Diagnosis

A strongly positive direct Coombs' (antiglobulin) test with cord red blood cells is invariably found in cases of Rh incompatibility, although 40% of the cases with a positive reaction do not require treatment. In ABO incompatibility, the direct antiglobulin test is usually weakly positive and may be confirmed by eluting antibodies from the infant's red cells and testing the eluate with A and B cells.

F. Prevention

Rh hemolytic disease of the newborn is rarely seen when mother and infant are incompatible in both Rh and ABO systems. In such cases, the ABO isoagglutinins in the maternal circulation appear to eliminate any fetal red cells before maternal sensitization occurs. This observation led to a very effective form of prevention of Rh hemolytic disease of the newborn, achieved by the administration of anti-D IgG antibodies (Rh immune globulin) to Rh-negative mothers.

The therapeutic anti-D preparation is manufactured from the plasma of previously immunized mothers with persistently high titers, or from male donors immunized against Rh-positive RBCs. Its mechanism of action is not entirely clear, but a recently proposed mechanism to explain the immunotherapeutic effect of intravenous gamma globulin in idiopathic thrombocytopenia has some interesting parallels. According to this postulate, it is possible that Rh immune globulin may downregulate anti-D-producing B cells as a consequence of co-ligation of surface immunoglobulin (by anti-idiotypic specificities present in the Rh immune globulin) and Fc γ R (by the Fc region of red cell-bound anti-D).

The schedule of administration involves two separate doses. Antepartum administration of a full dose of Rh immune globulin at the 28th week of pregnancy is recommended, in addition to postpartum administration. The rationale for this approach is to avoid sensitization due to prenatal spontaneous or posttraumatic bleeding. Prenatal anti-D prophylaxis is also indicated at the time that an Rh-negative pregnant woman is submitted to amniocentesis and must be continued at 12-week intervals until delivery to maintain sufficient protection. The postpartum dose is administered in the first 72 hours after delivery of each Rh-incompatible infant (before sensitization has had time to occur). The risk of immunization with a postpartum dose alone is 1–2%. Antepartum administration decreases the risk to 0.1%.

The recommended full dose is 300 μ g intramuscularly, which can be increased if there is laboratory evidence of severe feto-maternal hemorrhage (by tests able to determine the number of fetal red cells in maternal peripheral blood, from which one can calculate the volume of feto-maternal hemorrhage). Smaller doses (50 μ g) should be given after therapeutic or spontaneous abortion in the first trimester.

G. Treatment

To prevent serious hemolytic disease of the newborn in their infants, pregnant women who have a clinically significant antibody in the maternal circulation directed against a fetal antigen are carefully monitored. Amniocentesis is usually performed if the antibody has an antiglobulin titer greater than 16 or if the woman has a history of a previously affected

child. The amniotic fluid is examined for bile pigments at appropriate intervals, and the severity of the disease is assessed according to those levels. An alternate approach is to monitor the fetus by percutaneous umbilical blood sampling (PUBS), which allows for direct hematological and biochemical measurements by removing blood from the umbilical vessel using ultrasound guidance.

If fetal maturity has been established, labor may be induced, and, if necessary, the baby can be exchange-transfused after delivery. If fetal lung maturity is inadequate (judged by the lecithin/sphingomyelin ratio in amniotic fluid), intrauterine transfusion may be performed by transfusing O, Rh-negative red cells to the fetus.

Case 22.1 Revisited

1. *Many clinical conditions can cause neonatal jaundice. In a blood group O, Rh-negative mother, hemolytic disease of the newborn secondary to anti-Rh or anti-A/B antibodies needs to be considered. In gravida 1, para 0 females, the disease is unlikely to be due to Rh incompatibility, and ABO hemolytic disease of the newborn is usually mild. Treatment is not usually required. If indicated, phototherapy will usually reduce the bilirubin concentration, and exchange transfusion is rarely necessary.*

2. *The following test results were obtained:*

<i>Blood group and Rh type:</i>	<i>A, Rh-positive</i>
<i>Characterization of antibodies:</i>	
<i>Direct antiglobulin test</i>	<i>Weakly positive</i>
<i>Antibody eluted from RBC</i>	<i>Anti-A</i>
<i>Bilirubin, total</i>	<i>7.4 mg/dL</i>
<i>Bilirubin, direct</i>	<i>0.1 mg/dL</i>

The conclusion from the laboratory tests was that the child had jaundice secondary to a mild hemolytic anemia of immune cause.

3. *Prevention of hemolytic disease of the newborn is a multistep process. First, this woman should have had a blood typing and antibody-screening test ordered in the first trimester. In Rh-negative women the antibody-screening test is repeated at 28 weeks. If a woman has a positive antibody screening test, the antibody must be identified and its clinical significance assessed. This basically means determining whether it is IgG and can cross the placenta and react with incompatible fetal cells at body temperature. Clinically significant antibodies must be monitored closely throughout pregnancy so that treatment such as early delivery or intrauterine transfusions may be given if necessary. In addition, if anti-D antibodies were not detected in this patient, she should have been given a full dose of Rh immune globulin at 28 weeks and again within 72 hours after delivery. The risk of sensitization for an Rh-negative woman delivering her first Rh-positive infant is about 8%. The postpartum dose protects at the time of delivery when the largest number of fetal cells enters the maternal circulation and reduces the risk of positive red cells (Rh immune globulin should be given as a fail-safe approach). The antepartum dose prevents a small number of women who have larger than normal amounts of fetal cells entering their circulation during pregnancy from becoming sensitized and decreases the risk. ABO hemolytic disease of the newborn cannot be prevented, but it is rarely serious.*

V. IMMUNE HEMOLYTIC ANEMIAS

The designation of hemolytic anemias includes a heterogeneous group of diseases whose common denominator is the exaggerated destruction of red cells (hemolysis). In this chapter we will discuss only the hemolytic anemias in which an abnormal immune response plays the major pathogenic role.

Case 22.2

A 65-year-old man being treated for essential hypertension with a combination of thiazide and α -methyldopa was seen by his internist. He was complaining of tiredness and shortness of breath. The following laboratory results were obtained:

Hemoglobin	10 gm/dL
Hematocrit	31%
Reticulocytes	8%
Bilirubin, direct	1.5 mg/dL
Bilirubin, total	3.6 mg/dL
Direct antiglobulin test	Positive with anti-IgG
Indirect antiglobulin test	Positive

Panels performed on both the serum and an eluate from the patient's red cells revealed positive reactions with all cells tested, indicating the presence of an antibody of broad specificity.

This case raises several questions:

1. What are the two most probable causes of this patient's anemia, and why is it important to distinguish between the two?
2. What is the pathogenesis of the two types of hemolytic anemia most likely involved?
3. What immediate measure(s) should be instituted?

A. Autoimmune Hemolytic Anemia (Warm Antibody Type)

This is the most common form of autoimmune hemolytic anemia. It can be idiopathic (often following overt or subclinical viral infection) or secondary, as shown in Table 22.5.

1. Pathogenesis

“Warm” autoimmune hemolytic anemia (AIHA) results from the spontaneous emergence of IgG antibodies, which may have a simple Rh specificity such as anti-e, or uncharacterized specificities common to almost all normal red cells (“public” antigens, thought to be the core of the Rh substance). In many patients one can find antibodies of more than one specificity. The end result is that the serum from patients with autoimmune hemolytic anemia of the warm type is likely to react with most, if not all, of the red cells tested. These antibodies usually cause shortening of red cell life due to the uptake and destruction by phagocytic cells in the spleen and liver.

2. Diagnosis

Diagnosis relies on the demonstration of antibodies coating the red cells or circulating in the serum. RBC-fixed antibodies are detected by the direct antiglobulin Coombs' test. The

Table 22.5 Immune Hemolytic Anemias

Autoimmune hemolytic anemias (AIHA)	
Warm antibody AIHA	
Idiopathic (unassociated with another disease)	
Secondary (associated with chronic lymphocytic leukemia, lymphomas, systemic lupus erythematosus, etc.)	
Cold antibody AIHA	
Idiopathic cold hemagglutinin disease	
Secondary cold hemagglutinin syndrome	
Associated with <i>M. pneumoniae</i> infection	
Associated with chronic lymphocytic leukemia, lymphomas, etc.	
Immune drug–induced hemolytic anemia	
Alloantibody–induced immune hemolytic anemia	
Hemolytic transfusion reactions	
Hemolytic disease of the newborn	

Source: Modified from Petz, L. D., and Garraty, G. Laboratory correlations in immune hemolytic anemias. In *Laboratory Diagnosis of Immunologic Disorders*, G. N. Vyas, D. P. Stites, and G. Brechter, eds. Grune & Stratton, 1974.

test can be done using anti-IgG antiglobulin, anticomplement, or polyspecific antiglobulin serum that has both anti-IgG and anticomplement. The polyspecific or broad-spectrum antiglobulin sera produce positive results in higher numbers of patients, as shown in Table 22.6.

The search for antibodies in serum is carried out by the indirect antiglobulin test. Circulating antibodies are only present when the red cells have been maximally coated, and the test is positive in only 40% of the cases tested with untreated red cells. A higher positivity rate (up to 80%) can be achieved by using red cells treated with enzymes such as trypsin, papain, ficin, and bromelin in the agglutination assays. The treatment of red cells

Table 22.6 Typical Results of Serological Investigations in Patients with Autoimmune Hemolytic Anemia

	Cells, direct Coomb’s test			Serum	
	Antibody to	Positivity rate (%)	Antibody isotype	Serological AB characteristics	Specificity
Warm AIHA	IgG	30	IgG	Positive indirect Coombs’ test (40%)	Rh system antigens (“public”)
	IgG + C’	50		Agglutination of enzyme-treated RBC (80%)	
	C’	20			
Cold agglutinin disease	C’		IgM	Monoclonal I antigen IgMk agglutinates RBC to titers >1024 at 4°C	

Source: Modified from Petz, L. D., and Garraty, G. Laboratory correlations in immune hemolytic anemias. In *Laboratory diagnosis of Immunologic Disorders*, G. N. Vyas, D. P. Stites, and G. Brechter, eds. Grune & Stratton, 1974.

with these enzymes increases their agglutinability by either increasing the exposure of antigenic determinants or by reducing the surface charge of the red cells. In the investigation of warm-type AIHA, all tests are carried out at 37°C.

B. Cold Agglutinin Disease and Cold Agglutinin Syndrome

These diseases can also be idiopathic or secondary.

1. Pathogenesis

The cold agglutinins are classically IgM antibodies (very rarely IgA or IgG) and react with red cells at temperatures below normal body temperature.

In chronic, idiopathic, cold agglutinin diseases, the antibodies are in the vast majority of cases of the IgM κ isotype and react with the I antigen. This is a public antigen in adults. The fetus expresses the “i” antigen, common to primates and other mammals, which is the precursor of the “I” specificity. The newborn expresses i predominantly over I; in the adult, the situation is reversed.

In postinfectious cold agglutinin syndrome, the antibodies are also predominantly IgM but contain both κ and λ light chains, suggesting their polyclonal origin. The cold agglutinins that appear in patients with *Mycoplasma pneumoniae* infections are usually reactive with the I antigen, while those that appear in association with infectious mononucleosis usually react with the i antigen.

The range of thermal reactivity of cold agglutinins may reach up to 35°C. Such temperatures are not difficult to experience in exposed parts of the body during the winter. Cold-induced intravascular agglutination, causing ischemia of cold-exposed areas, and hemolysis are the main pathogenic mechanisms in cold agglutinin disease.

2. Clinical Presentation

Hemolysis is usually mild but in some cases may be severe, leading to acute tubular necrosis. But in most cases the clinical picture is dominated by symptoms of cold sensitivity (Raynaud’s phenomenon, vascular purpura, and tissue necrosis in exposed extremities).

3. Laboratory Diagnosis

Testing for cold agglutinins is usually done by incubating a series of dilutions of the patient’s serum (obtained by clotting and centrifuging the blood at 37°C immediately after drawing) with normal group O RBCs at 4°C. Titers up to the thousands or even millions can be observed in patients with cold agglutinin disease. Intermediate titers (<1000) can be found in patients with *Mycoplasma pneumoniae* infections (postinfectious cold agglutinins). Low titers (<64) can be found in normal asymptomatic individuals.

C. Drug-Induced Hemolytic Anemia

Three different types of immune mechanisms may play a role in drug-induced hemolytic anemias, as summarized in Table 22.7. It is important to differentiate between drug-induced hemolytic anemia and warm autoimmune hemolytic anemia, because cessation of the drug alone will usually halt the drug-induced hemolytic process.

Table 22.7 Correlation Between Mechanisms of Red Cell Sensitization and Laboratory Features in Drug–Induced Immunohematological Abnormalities

Mechanism	Prototype drugs	Clinical findings	Serological evaluation	
			Usual direct Coombs' result	In vitro tests for Ab characterization
Immune complex (drug-dependent)	Quinidine Phenacetin 3rd-gen, cephalosporins	Intravascular hemolysis; renal failure; thrombocytopenia	Positive with anti-C'	Drug + serum + RBC; Ab is often IgM
Drug adsorption to RBC	Penicillins 1–2nd-gen. cephalosporins	Extravascular hemolysis associated with high i.v., doses	Positive with anti-IgG	Drug-coated RBC + serum; antibody is IgG
Autoimmune	α-methyl dopa L-dopa Procainamide	Onset of extravascular hemolysis associated with high doses	Positive with anti-IgG	Normal RBC + serum; autoantibody to RBC identical to IgG Ab in warm AIHA

Ab = antibody.
RBC = red blood cell.

1. Immune Complex Mechanism (Drug-Dependent Antibody Mechanism)

Traditionally this mechanism has been thought to be a part of the formation of soluble immune complexes between the drug and the corresponding antibodies, which is followed by nonspecific adsorption to red cells and complement activation. Alternatively, the neoantigen concept proposes that the drug binds transiently with the red cell, forming a “nonself” epitope, which stimulates antibody formation. The distinction between this mechanism and the drug adsorption mechanism, where a stable bond is formed between the drug and the cell membrane, may be more apparent than real. When IgM antibodies are predominantly involved, intravascular hemolysis is frequent, and the direct Coombs' test is usually positive if anticomplement antibodies are used. IgG antibodies can also form immune complexes with different types of antigens and be adsorbed onto red cells and platelets. In vitro such adsorption is not followed by hemolysis or by phagocytosis of red cells, but in vivo it has been reported to be associated with intravascular hemolysis.

The absorption of IgG-containing immune complexes to platelets is also the cause of drug-induced thrombocytopenia. Quinine, quinidine, digitoxin, gold, meprobamate, chlorothiazide, rifampin, and the sulfonamides have been reported to cause this type of drug-induced thrombocytopenia.

2. Drug Adsorption Mechanism

This mechanism proposes that the adsorbed drug functions as hapten and the RBC as carrier, and an immune response against the drug ensues. The antibodies, usually IgG, are present in high titers and may activate complement after binding to the drug adsorbed to the red cells, inducing hemolysis (Fig. 24.3) or phagocytosis. Penicillin (when administered in

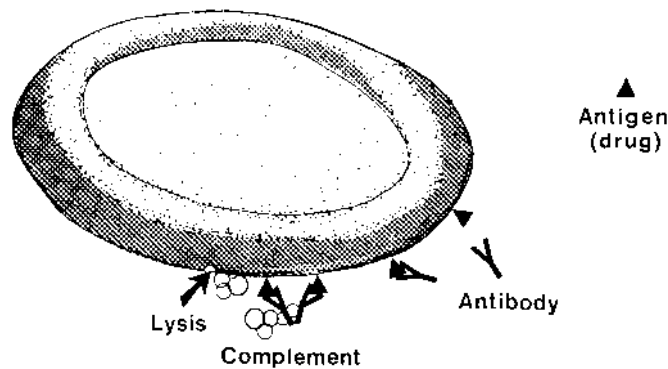

Fig. 22.3 Diagrammatic representation of the pathogenesis of drug-induced hemolytic anemia as a consequence of adsorption of a drug to the red cell membrane.

high doses by the intravenous route) and cephalosporins can induce this type of hemolytic anemia. Some cephalosporins (such as cephalothin) also have been shown to modify the red cell membrane that becomes able to adsorb proteins nonspecifically, a fact that can lead to a positive direct Coombs' test but not to hemolytic anemia.

3. Autoimmunity Induction Mechanism

The drug most implicated in this form of drug-induced hemolytic anemia is α -methyl dopa (Aldomet). Ten to 15% of the patients receiving the drug will have a positive Coombs' test, and 0.8% of the patients develop clinically evident hemolytic anemia. It is particularly interesting from the pathogenic point of view in that it is indistinguishable from a true warm autoimmune hemolytic anemia.

α -Methyl dopa is unquestionably the trigger for this type of anemia, but the antibodies are of the IgG1 isotype and react with Rh antigens. It is believed that the drug changes the membrane of red cell precursors, causing the formation of antibodies reactive with a modified Rh precursor. Once formed, the anti-red cell antibodies will react in the absence of the drug as true autoantibodies.

Other drugs such as L-dopa, procainamide, and some nonsteroidal anti-inflammatory drugs can also act by this mechanism. Both α -methyl dopa and L-dopa also stimulate the production of antinuclear antibodies.

D. Treatment

Blood transfusions may be necessary in emergency situations but are made difficult when autoantibodies to red cell antigens are widely represented in the population. The serum from a patient with cold or warm-type AIHA typically agglutinates all the red cells in an antibody identification panel. It is most important to determine if there are clinically significant underlying alloantibodies that may be masked by autoantibody. The patient's red cells may be pretreated in a manner to enhance removal of autoantibody from the serum. After one or more autoadsorptions, the adsorbed serum may be used for alloantibody detection and cross-matching.

Glucocorticoids are the first line of treatment in patients with symptomatic warm AIHA. Other immunosuppressive drugs can be tried in patients not responding to glucocorticoids. Splenectomy can be useful in individuals who do not respond to glucocorticoids, when there is a marked predominance of red cell sequestration in the spleen. In such cases splenectomy leads to a longer half-life of the patient's red cells.

Glucocorticoids and splenectomy are generally ineffective in treating cold agglutinin disease. Patients should be kept warm, especially their extremities. If transfusions are to be administered, an approved blood warmer should be used immediately prior to transfusion.

In cases of drug-induced hemolytic anemia the offending drug should be withdrawn and hemolysis should resolve.

Case 22.2 Revisited

- 1. The two most probable causes of this patient's hemolytic anemia were warm autoimmune hemolytic anemia and drug-induced hemolytic anemia. It is important to distinguish between the two because the treatments differ significantly. The history of hypertension and treatment with α -methyldopa should alert the physician to the possibility of a drug-induced hemolytic anemia. Laboratory tests usually do not differentiate between the two conditions because the reactivity of the antibodies is virtually identical.*
- 2. Warm-type hemolytic anemia is an autoimmune condition, which can present itself as the only manifestation of autoimmunity or as part of the constellation of a systemic autoimmune disease. The autoantibodies are of broad specificity, reacting with public erythrocyte antigens expressed by almost every individual. Drug-induced hemolytic anemia can be caused by antibodies directed to the drug, due either to previous adsorption of the drug to the red cell or to adsorption of preformed antigen-antibody complexes to the red cell, or (as is the case in hemolytic anemia associated with α -methyldopa) by anti-red cell antibodies identical to those detected in true autoimmune hemolytic anemia. How α -methyldopa causes the production of these antibodies is the object of speculation. It is believed that the drug may alter the conformation of the Rh complex on the red cell membrane, triggering the synthesis of antibodies that cross-react with unchanged Rh substances. Thus, once induced, the autoantibody recognized the red cell rather than α -methyldopa, and withdrawal of the drug may not result in immediate improvement.*
- 3. In all cases of drug-induced hemolytic anemia it is important to stop the administration of the drug as soon as the diagnosis is established. In the case of α -methyldopa-induced hemolytic anemia the improvement will be gradual, because the autoantibodies react with the red cells, rather than with the drug. However, the antibody titers will decrease with time, and after a point their concentration may be still sufficient to cause a positive direct antiglobulin test but not to cause significant anemia. In contrast, treatment of true autoimmune hemolytic anemia is rather more complex, involving administration of steroids and, in cases not responding to steroids, splenectomy and/or administration of immunosuppressive drugs.*

SELF-EVALUATION

Questions

Choose the one best answer.

- 24.1 A direct Coombs' test using antisera to IgG is almost always positive in:
- A. Females with circulating anti-D antibodies
 - B. Newborns with Rh hemolytic disease
 - C. Patients with cold hemagglutinin disease
 - D. Patients with α -methyl-dopa-induced hemolytic anemia
 - E. Patients with warm-type autoimmune hemolytic anemia
- 24.2 The pathogenesis of penicillin-induced hemolytic anemia involves:
- A. Drug adsorption to red cells and reaction with antipenicillin antibodies
 - B. Emergence of a neo-antigen on the red cell membrane
 - C. Formation of soluble IC, adsorption to red cell membranes, and complement activation or phagocytosis.
 - D. Nonspecific adsorption and activation of complement components
 - E. None of the above
- 24.3 Which of the following drugs induces the production of autoantibodies that react with red cell antigens expressed by most individuals?
- A. α -Methyl-dopa
 - B. Cephalosporin
 - C. Penicillin
 - D. Phenacetin
 - E. Quinidine
- 24.4 The destruction of Rh-positive erythrocytes after exposure to IgG anti-D antibodies is due to:
- A. Complement activation
 - B. Fc γ R-mediated phagocytosis
 - C. CR1-mediated phagocytosis
 - D. CR3-mediated phagocytosis
 - E. A combination of Fc γ R and CR1-mediated phagocytosis
- 24.5 In a patient with penicillin-induced hemolytic anemia, you should be concerned with the induction of a similar situation if prescribing:
- A. Aminoglycosides
 - B. Aspirin
 - C. Cephalosporins
 - D. Quinidine
 - E. Sulfonamides
- 24.6 An A, Rh-negative female is unlikely to be sensitized by a first Rh-positive baby if the:
- A. Baby is B, Rh-positive
 - B. Baby is A, Rh-positive
 - C. Baby is O, Rh-positive
 - D. Father is A, Rh-positive
 - E. Father is B, Rh-positive

- 24.7 The major cross-match is used to detect antibodies in:
- A. The donor's red cells
 - B. The donor's serum
 - C. The recipient's cells
 - D. The recipient's serum
 - E. Both donor's and recipient's sera
- 24.8 The reason why the Coombs' test is *not* used for the diagnosis of cold agglutinin disease (CAD) is that the:
- A. Disease is diagnosed by the cold agglutinin test
 - B. Red cells from patients with CAD autoagglutinate at 37°C
 - C. Red cells lyse spontaneously at room temperature
 - D. Red cell-bound IgM does not activate the complement system
 - E. Results are always negative
- 24.9 The reason why it is often difficult to transfuse patients with warm AIHA is that the antibodies in the patient's serum:
- A. Are complement-fixing
 - B. Are polyspecific and react with many different red cell antigens
 - C. Are present in very high titers
 - D. React at body temperature
 - E. React with "public" red cell antigens
- 24.10 A large majority of fatal transfusion reactions result from:
- A. Allergic reactions
 - B. Anti-IgA antibodies
 - C. Antibodies to HLA antigens
 - D. Bacterial contamination of transfused blood
 - E. Human error

Answers

- 24.1 (B) Rh hemolytic disease is, by definition, due to IgG antibodies that cross the placenta and bind to the newborn's erythrocytes, where they will be easily detected by a direct Coombs' test using anti-IgG antibodies.
- 24.2 (A)
- 24.3 (A) α -Methyldopa (Aldomet) induces a very unique type of hemolytic anemia in which the antibodies react with red cell antigens of the Rh complex and not to the drug itself.
- 24.4 (B) IgG anti-D antibodies do *not* cause complement fixation after binding to the red cell membrane because the D antigen molecules are too separated to allow the IgG molecules to form the duplets essential for complement activation.
- 24.5 (C) There can be cross-reaction between penicillin and the cephalosporins; both groups of antibiotics belong to the β -lactam group and therefore share part of their structure.
- 24.6 (A) The maternal anti-A and anti-B isoagglutinins will function as a natural anti-red cell antibody, destroying incompatible fetal red cells before there is an opportunity to induce the anti-D immune response. The paternal blood group is irrelevant, except for the baby's inheritance of a given blood group.

- 24.7 (D)
- 24.8 (A) The patient's red cells may autoagglutinate and lyse, but usually at low temperatures, and definitely not at 37°C. The direct Coombs' test using anti-C3 antibodies can be positive, but the cold agglutinin test is preferred because when positive at a high titer in a symptomatic patient, it establishes the specific diagnosis of cold hemagglutinin disease.
- 24.9 (E) The main problem when transfusions are needed for patients with AIHA is the difficulty in finding cells that are not agglutinated by the patient's serum. This is due to the fact that the autoantibodies react with "public" red cell antigens, i.e., antigens that almost every individual carries on his or her erythrocytes.
- 24.10 (E) Human error is the most frequent cause; bacterial contamination of transfused blood is the second most frequent cause of fatal transfusion reactions.

BIBLIOGRAPHY

- Brostoff, J., Scadding, G. K., Male, D., and Roitt, I. M. *Clinical Immunology*. Gower Med. Publ., London, 1991.
- Chaudhuri, A., Zbrzezna, V., Polyakova, J., Pogo, A. O. Hesselgesser, J., and Horuk, R. Expression of the Duffy antigen in K562 cells. Evidence that it is the human erythrocyte chemokine receptor. *J. Biol. Chem.* 269:7835–7838, 1994.
- Jeter, E. K., and Spivey, M. A. *Introduction to Transfusion Medicine: A Case Study Approach*. American Association of Blood Banks, Bethesda, 1996.
- Harmening, D. E. *Modern Blood Banking and Transfusion Practices*, 4th ed. F. A. Davis Co., Philadelphia, 1999.
- Menitove, J. E. Transfusion practices in the 1990s. *Ann. Rev. Med.* 42:297, 1991.
- Mollison, P. L., Engelfriet, C. P., and Contreras, M. *Blood Transfusion in Clinical Medicine*, 10th ed. Blackwell Science Ltd, Oxford, 1997.
- Petz, L. D., and Garraty, G. *Acquired Immune Hemolytic Anemias*. Churchill/Livingston, Inc., New York, 1980.
- Petz, L.D., Swisher, S., Kleinman, S., et al., eds. *Clinical Practice of Transfusion Medicine*, 3rd ed. Churchill Livingstone, New York, 1996.
- Rossi, E. C., Simon, T. L., Moss, G. E., and Gould, S. A. eds. *Principles of Transfusion Medicine*, 2nd ed. William & Wilkins, Baltimore, 1996.
- Silberstein, L. E., ed. *Molecular and Functional Aspects of Blood Group Antigens*. American Association of Blood Banks, Bethesda, MD, 1995.
- Wells, J. V., and Isbister, J. P. Hematologic diseases. In *Basic and Clinical Immunology*, 9th ed. (D. P. Stites, A. I. Terr, and T. G. Parslow, eds). Lange, Norwalk, CT, 1997, pp. 493–512.

23

Immune Complex Diseases

Gabriel Virella and George C. Tsokos

I. INTRODUCTION

The formation of circulating antigen-antibody (Ag.Ab) complexes is one of the natural events that characterize the immunological response against soluble antigens. Normally, immune complexes (IC) formed by soluble proteins and their respective antibodies are promptly phagocytized and eliminated from circulation without any detectable adverse effects on the host. However, there are well-characterized clinical and experimental situations in which it has been proven that IC play a pathogenic role.

In the late 1800s and early 1900s, passive immunization with equine antisera was a common therapy for severe bacterial infections. It was often noted that 1–2 weeks after administration of the horse antisera, when the symptoms of acute infection had often disappeared, the patient would start to complain of arthralgias, exanthematous rash, and had proteinuria and an abnormal urinary sediment, suggestive of glomerulonephritis. Von Pirquet coined the term serum sickness to designate this condition.

Several decades later, Germuth, Dixon, and coworkers carried out detailed studies in rabbits on which serum sickness was induced by injection of single doses of heterologous proteins. As summarized in Figure 23.1, after the lag time necessary for antibody production, soluble immune complexes were detected in serum, serum complement levels decreased, and the rabbits developed glomerulonephritis, myocarditis, and arthritis. The onset of disease coincided with the disappearance of circulating antigen, while free circulating antibody appeared in circulation soon after the beginning of symptoms.

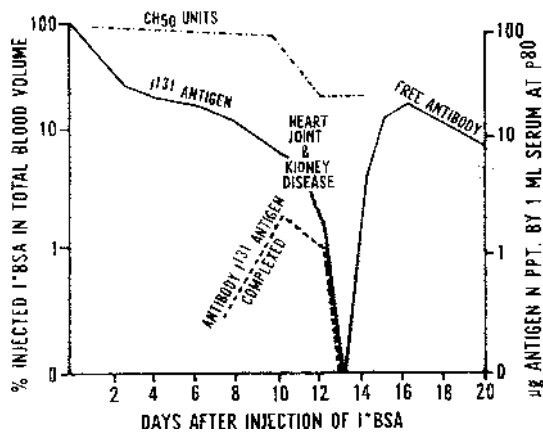

Fig. 23.1 Diagrammatic representation of the sequence of events that takes place during the induction of acute serum sickness in rabbits. Six days after injection of radiolabeled BSA, anti-BSA antibodies start being produced and form complexes with the antigen, which is eliminated rapidly with the circulation. The maximal concentration of immune complexes shortly precedes a decrease in complement levels and the appearance of histological abnormalities on the heart, joints, and kidney. After the antigen is totally eliminated, the antibody becomes detectable and the pathological lesions heal without permanent sequelae. (Reproduced with permission from Cochrane, C. G., and Koffler, D. *Adv. Immunol.* 16:185, 1973.)

Both the experimental one-shot serum sickness and human serum sickness are usually transient and will leave no permanent sequelae. However, if the organism is chronically exposed to antigen (as in chronic serum sickness), irreversible lesions will develop.

II. PHYSIOPATHOLOGY OF IMMUNE COMPLEX DISEASE

The formation of an immune complex does not have direct pathological consequences. The pathogenic consequences of immune complex formation depend on the ability of those immune complexes to:

- Form a stable bond with a circulating cell or to leave the intravascular compartment and become tissue-fixed
- Activate the complement system
- Interact with cells able to release enzymes and mediators involved in inflammation

All of these properties are related to the physicochemical characteristics of immune complexes (Table 23.1).

A. Physicochemical Characteristics of Immune Complexes

Size, affinity of the Ag.Ab reaction, and class and subclass of antibodies involved in immune complex formation are among the most important determinants of the pathogenic significance of IC.

Very large Ag.Ab aggregates containing IgG1 or IgG3 antibodies will activate complement very effectively but are usually nonpathogenic. This is due to a combination of

Table 23.1 Antigen Antibody
Characteristic that Affect the Pathogenicity
of Immune Complexes

Antibody
Class
Valence
Affinity for Fc receptors
Ability to bind and activate complement
Affinity
Charge
Amount
Antigen
Size
Valence
Chemical composition
Charge
Amount

facts: very avid ingestion and degradation by phagocytic cells and difficulty in diffusing across the endothelial barrier. In contrast, very small complexes (Ag1.Ab1-3), even when involving IgG1 and IgG3 antibodies, are able to diffuse easily into the extravascular compartment, but are usually nonpathogenic because of their inability to activate complement. Actually, the most potentially pathogenic IC are those of intermediate size (Ag2-3.Ab2-6), particularly when involving complement-fixing antibodies (IgG1, IgG3) of moderate to high affinity. However, a main question that needs to be answered is how these IC diffuse into the subendothelial space.

B. Immune Complex Formation and Cell Interactions

1. *Circulating Immune Complexes*

IC formed in the circulation may be deposited in various tissues, where they cause inflammation and tissue damage. Characteristically, multiple organs and tissues may be affected and the clinical paradigms are diseases such as serum sickness and systemic lupus erythematosus. The interaction of IC with cells able to release mediators of inflammation appears to be considerably enhanced if the IC are surface-bound, rather than soluble. This immobilization of immune complexes along vessel walls is likely to be mediated by:

1. C3 receptors, such as those located on the glomerular epithelium
2. C1q receptors, expressed by endothelial cells
3. Fc receptors, expressed on the renal interstitium and by damaged endothelium
4. Affinity of some antigen moieties in IC for specific tissues, such as that of DNA for glomerular basement membrane and collagen

2. *Formation of Immune Complexes In Situ*

Direct injection of antigen into a tissue will result in local IC formation with circulating antibody. Examples include the Arthus reaction (antigen injected into the dermis binds circulating antibody) and hypersensitivity pneumonitis (antigen inhaled forms IC with circulating antibody).

Other types of IC formed *in situ* include those formed when antibodies react with antigens present on the cell surface membrane of circulating or tissue cells. Immune complexes formed on cell membranes can lead to the destruction of the cell, either by promoting phagocytosis or by causing complement-mediated lysis. This mechanism is responsible for the development of various immune cytopenias.

Autoantibodies may also bind to basement membrane antigens, as in Goodpasture's syndrome, or may react with an antigen that has become adsorbed to a basement membrane due to charge interactions, such as seems to be the case of DNA, which binds to basement membrane collagen. The formation of IC in synovial membranes may also result from a two-step *in situ* reaction between monomeric, freely diffusible autoantibodies and synovial membrane antigens.

3. Adsorption and Transfer of Immune Complexes

Circulating IC can bind to platelets and red cells. Human platelets express Fc receptors, specific for all IgG subclasses and CR4, which binds the C3dg fragment of C3. Red blood cells (RBC) express CR1, through which C3b-containing IC can be bound. In addition, IC can bind to RBC through nonspecific interactions of low affinity, which do not require the presence of complement. Immune complex binding to RBC is believed to be an important mechanism for clearance of soluble IC from the systemic circulation. Experimental work in primates and metabolic studies of labeled IC in humans show that RBC-bound IC are maintained in the intravascular compartment until they reach the liver, where they are presented to phagocytic cells. The phagocytic cells have Fc receptors able to bind the IC with greater affinity than the red cells; as a consequence, the IC are removed from the RBC membrane, while the red cells remain undamaged (Fig. 23.2).

C. Tissue Deposition of IC

Our understanding of how immune complexes induce inflammation and tissue damage is still very incomplete, particularly in cases where the tissue damage is believed to result from the extravascular deposition of circulating immune complexes. A major obstacle to such deposition is the endothelial barrier, which is poorly permeable even to intermediate-sized immune complexes. How this barrier is overcome remains an unanswered question. Another question that has not been fully answered is what determines the preferential deposition of IC in specific tissues.

Deposited IC are frequently found around the small vessels of the skin, particularly in the lower limbs, the kidney glomeruli, the choroid plexus, and the joints. It is likely that regional factors may influence the selectivity of IC deposition. For example, the preferential involvement of the lower limbs in IC-related skin vasculitis may result from the simple fact that the circulation is slowest and the hydrostatic pressure highest in the lower limbs. On the other hand, the frequent involvement of the kidney in IC-associated disease may be a consequence of the existence of C3b receptors in the renal epithelial cells, Fc receptors in the renal interstitium, and a collagen-rich structure (the basement membrane), which can also be involved in nonspecific interactions.

In some cases, *in situ* deposition of IC may be a two-step process: first the antigen may diffuse across the endothelium and become associated with extravascular structures. Monomeric antibody, equally diffusible, may later become associated with the immobilized antigen. The best example for this sequence is SLE-associated nephritis: DNA be-

Immune Complex Diseases

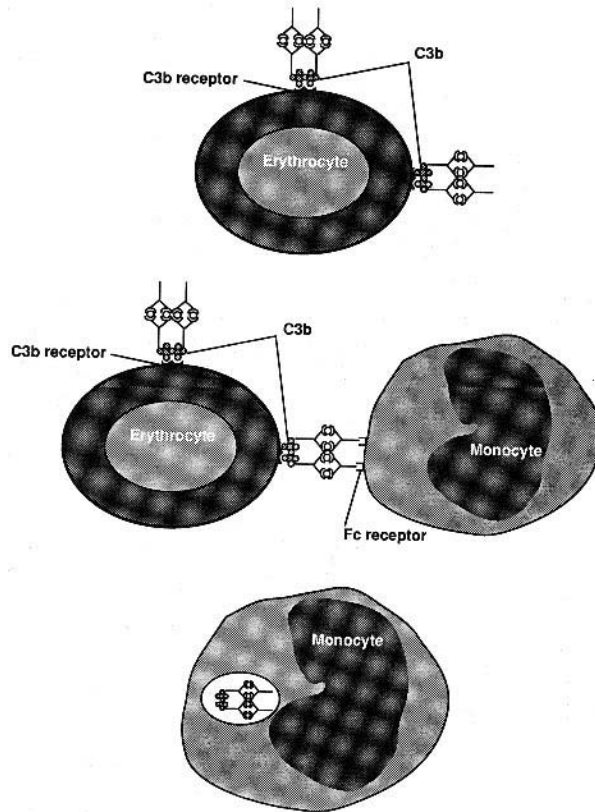

Fig. 23.2 Diagrammatic representation of the protective role of erythrocytes against the development of immune complex disease. Erythrocytes can adsorb circulating IC through C3b receptors or through nonspecific interactions. RBC-adsorbed IC persist in circulation until the IC are stripped from the RBC surface by phagocytic cells expressing Fc receptors, which bind the IC with greater avidity. Once taken up by phagocytic cells, the IC are degraded, and this uptake is responsible for their disappearance from circulation.

comes associated with the glomerular basement membrane, and anti-DNA antibodies cross the endothelial barrier and become associated with DNA at the basement membrane level.

Any pathogenic sequence involving the deposition of circulating IC has to take into account increased vascular permeability in the microcirculation, allowing the diffusion of small- to medium-sized soluble IC to the subendothelial spaces (Fig. 23.3). The initial step is likely to be the activation of monocytes or granulocytes by immobilized IC, resulting in the release of vasoactive amines and cytokines. Receptor-mediated interactions involving Fc receptors or complement receptors on endothelial cells could play the initiating role by immobilizing IC at the level of the microvasculature. The retention of soluble IC diffusing through the endothelium in the kidney could be mediated by C3b receptors of the renal epithelial cells or by Fc receptors in the renal interstitium. The mechanisms involved in selective retention of soluble IC in other tissues, such as the skin and choroid plexus, are poorly understood.

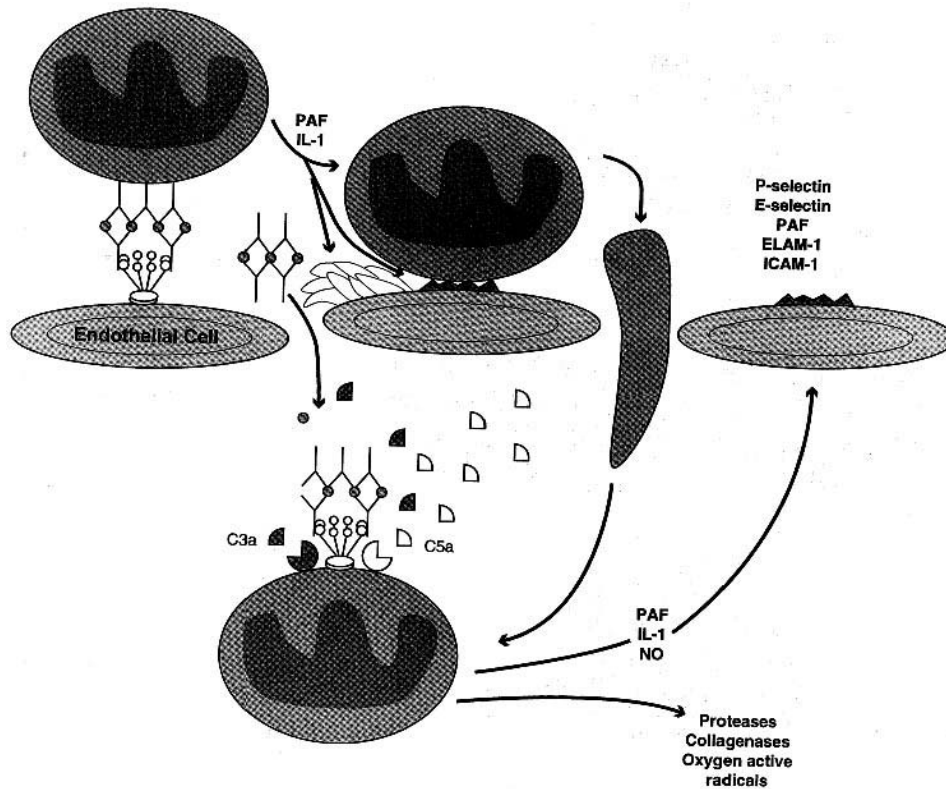

Fig. 23.3 The initial stages of circulating immune complex deposition require a sequence of events that enables circulating IC and inflammatory cells to cross the endothelial barrier. In this representation of such a hypothetical sequence, the first event is the binding of circulating IC containing IgG antibodies and associated C1q to C1q receptors on the endothelial cell. The immobilized IC are then able to interact with circulating cells expressing Fc γ receptors, such as PMN leukocytes. Such interaction results in PMN activation and release of mediators, such as platelet-activating factor (PAF) and IL-1. These two mediators have a variety of effects: PAF induces vasodilatation and activates platelets, which form aggregates and release vasoactive amines. The resulting increased vascular permeability allows circulating IC to cross the endothelial barrier. IL-1 activates endothelial cells and induces the expression of selectin molecules that interact with glycoproteins and sialoglycoproteins on the leukocyte membrane. This interaction slows down PMNs along the endothelial surface, a phenomenon known as “rolling.” As endothelial cells continue to receive activating signals, they start expressing membrane-associated PAF, which interacts with PAF receptors on neutrophils, ICAM-1, which interacts with leukocyte integrins of the CD11/CD18 family, and VCAM-1, which interacts with VLA (very late antigen)-1, upregulated on PMN leukocytes as a consequence of the occupancy of Fc receptors. This promotes firm adhesion of leukocytes to endothelial cells. At the same time the IC that diffuse to the subendothelial space activate complement and generate chemotactic factors, such as C5a and C3a. Adherent PMN leukocytes are attracted to the area and insinuate themselves between endothelial cells, reaching the area of IC deposition. Interaction with those extravascular IC with associated C3b delivers additional activation signals to already primed granulocytes, resulting in the release of metalloproteinases (including proteases and collagenases), oxygen active radicals, and nitric oxide. These compounds can cause tissue damage and can further increase vascular permeability, and in doing so contribute to the perpetuation of an inflammatory reaction.

D. Inflammatory Circuits Triggered by Immune Complexes

The development of inflammatory changes after extravascular formation or deposition of immune complexes is not observed in experimental animals depleted of neutrophils or complement. Activated macrophages and the soluble compounds released as a consequence of their activation also play important roles (Table 23.2).

Complement components play a significant role as opsonins and chemotactic factors, while activated granulocytes can release a wide variety of proteolytic enzymes that mediate tissue damage.

IC containing IgM, IgG1 and/or IgG3 antibodies, able to activate the complement system by the classical pathway, are believed to have the greatest pathogenic potential. Activation of the complement cascade results in the generation of chemotactic and pro-inflammatory fragments, such as C3a and C5a (see Chapter 9). These complement components have strong pro-inflammatory effects, mediated by a variety of mechanisms:

- C5a increases vascular permeability directly as well as indirectly (by causing the release of histamine and vasoactive amines from basophils and mast cells).
- C5a enhances the expression of the CD11/CD18 complex on neutrophil membranes, increasing their adhesiveness to endothelial cells.
- C5a and C3a are chemotactic for neutrophils, attracting them to the area of IC deposition and stimulating their respiratory burst and release of granule constituents.

The combination of chemotaxis, increased adherence, and increased vascular permeability plays a crucial role in promoting extravascular emigration of leukocytes. It needs to be stressed that the inflammatory process triggered by immune complexes is characteristically associated with extravascular granulocyte infiltrates. The emigration of neutrophils and other granulocytes is regulated by a series of interactions with endothelial cells, known as the adhesion cascade. This cascade involves the following sequence of events:

1. The initial event involves the upregulation of selectins (P-selectin and E-selectin) on endothelial cells, which can be caused by a variety of stimuli (e.g., histamine, thrombin, bradikinin, leukotriene C4, free oxygen radicals, or cytokines). The consequence of this upregulation is the slowing down (rolling) and

Table 23.2 Elements Involved in Immune Complex–Mediated Immunopathology

A. Cells

Polymorphonuclear leukocytes—PMN-depleted animals do not develop arthritis or Arthus reaction.

Monocytes/macrophages—monocyte depletion in experimental glomerulonephritis decreases proteinuria.

B. Soluble factors (circulating and released locally)

Complement fragments—complement-depleted animals develop less severe forms of serum sickness.

Lymphokines/cytokines—corticosteroids reduce interleukin release and have beneficial effects in the treatment of immune complex disease.

Lysosomal enzymes—the main mediators of PMN-induced tissue damage.

Prostaglandins—important mediators of the inflammatory reaction; their synthesis is inhibited by aspirin and most nonsteroidal anti-inflammatory agents.

loose attachment of leukocytes (expressing a third selectin, L-selectin, which binds to membrane oligosaccharides on endothelial cells). These initial interactions are unstable and transient.

2. The endothelial cells, in response to persistent activating signals, express platelet-activating factor (PAF) and ICAM-1 on the membrane. Neutrophils express constitutively a PAF receptor that allows rolling cells to interact with membrane-bound PAF.
3. The interaction of neutrophils with PAF, as well as signals received in the form of chemotactic cytokines such as IL-8 (which can also be released by endothelial cells), activate neutrophils and induce the expression of the following integrins: CD11a/CD18, LFA-1, and related molecules, and very late antigen-4, and VLA-4.
4. The interaction between integrins expressed by neutrophils and molecules of the immunoglobulin superfamily expressed by endothelial cells (ICAM-1 and related antigens bind LFA-1 and related molecules; VCAM-1 binds VLA-4) causes firm adhesion (sticking) of inflammatory cells to the endothelial surface, which is an essential step leading to their extravascular migration. VLA-4 is also expressed on the membrane of lymphocytes and monocytes, and its interaction with endothelial VCAM-1 allows the recruitment of these cells to the site of inflammation.
5. The interactions between integrins and their ligands are important for the development of vasculitic lesions in patients with systemic lupus erythematosus and other systemic autoimmune disorders and of purulent exudates in infection sites. As discussed in Chapter 13, patients with genetic defect in the expression of CD18 and related cell adhesion molecules (CAMs) fail to form abscesses because their neutrophils do not express these molecules and fail to migrate.
6. The actual transmigration of leukocytes into the subendothelial space seems to involve yet another set of CAMs, particularly one member of the immunoglobulin superfamily known as PECAM (platelet endothelial cell adhesion molecule), which is expressed both at sites of intercellular junction and on the membranes of leukocytes. PECAM-1 interacts with itself, and its expression is upregulated on both endothelial cells and leukocytes by a variety of activating signals.
7. The egression of leukocytes from the vessel wall is directed by chemoattractant molecules released into the extravascular space and involves diapedesis through endothelial cell junctions.

As leukocytes begin to reach the site of immune complex formation or deposition, they continue to receive activating signals. Their activation brings about the release of additional chemotactic factors and continuing upregulation of CAMs on endothelial cells, the efflux of phagocytic cells to the subendothelial space will intensify, and the conditions needed for self-perpetuation of the inflammatory process are created. All polymorphonuclear leukocytes express Fc γ receptors and C3b receptors that mediate their binding and ingestion of IC. This process is associated with activation of a variety of functions and with the release of a variety of cytokines, enzymes, and other mediators. One of the mediators released by activated neutrophils is platelet-activating factor, which will promote the self-perpetuation of the inflammatory process by:

- Increasing vascular permeability (directly or as a consequence of the activation of platelets, which release vasoactive amines)

Inducing the upregulation of the CD11/CD18 complex on neutrophils
Inducing monocytes to release IL-1 and TNF α , which activate endothelial cells and promote the upregulation of adhesion molecules (E and P selectins) and the synthesis of PAF and IL-8

Furthermore, as granulocytes try to engulf large IC aggregates or immobilized IC, they become activated and release their enzymatic contents, including metalloproteinases with protease and collagenase activity and oxygen active radicals. These compounds can damage cells, digest basement membranes and collagen-rich structures, and contribute to the perpetuation of the inflammatory reaction by causing direct breakdown of C5 and C3 and generating additional C5a and C3b. The formation of C3b promotes activation of the alternative pathway, thus continuing to amplify the pro-inflammatory reaction. As the inflammatory reaction continues to intensify, clinical manifestations emerge. The clinical manifestations of immune complex disease depend on the intensity of the inflammatory reaction and on the tissue(s) predominantly affected by IC deposition.

III. HOST FACTORS THAT INFLUENCE THE DEVELOPMENT OF IMMUNE COMPLEX DISEASE

The development of immune complex disease in experimental animals is clearly dependent on host factors. If several rabbits of the same strain, age, weight, and sex are immunized with identical amounts of a heterologous protein by the same route, only a fraction of the immunized animals will form antibodies, and of those, only some will develop immune complex disease. The magnitude of the response primarily depends on genetic factors. The extent of tissue involvement is likely to depend on the general characteristics of the antibodies produced (such as affinity, complement-binding ability, capacity to interact with cell receptors) as well as on the functional state of the RES of the animal.

The affinity and number of available Fc γ receptors on professional phagocytic cells (PMN leukocytes, monocytes, and macrophages) are important in the expression of IC disease. If IC are predominantly taken up by those cells in tissues where they abound, such as the liver and spleen, the likelihood of developing tissue inflammation is limited. Support for the importance of Fc-mediated clearance of IC as a protective mechanism was obtained in experiments in which the Fc receptors were blocked. This resulted in decreased IC clearance and increased pathogenicity.

Patients with systemic lupus erythematosus and rheumatoid arthritis have decreased ability to clear antibody-sensitized red cells, indicating a general inability to clear circulating IC. Some patients with lupus nephritis have a distinct Fc γ RII allele expression. It is speculated that the abnormal allele is functionally deficient and that the lack of clearance of IC may then favor glomerular deposition.

The ability to interact with complement receptors may also be an important determinant of pathogenicity. C1q, C3b, C3c, and C3d are readily detected in IC. This may allow IC to bind to cells expressing the corresponding complement receptors. As mentioned above, binding of IC to CR1 expressed on the surface membrane of red cells facilitates their clearance for the circulation (see above). In patients with SLE and other IC diseases, the number of CR1 on the surface of red cells is decreased and this may contribute to decreased IC clearance. This decreased CR1 expression has been claimed to be genetically determined in SLE. However, it is possible that the decrease may not be numerical, but func-

tional. In other words, in patients with high concentrations of circulating IC CR1 may be saturated and this may result in blocking of the receptors by IC causing a decrease in the number of available receptors.

IV. DETECTION OF SOLUBLE IMMUNE COMPLEXES

Many techniques have been proposed for the detection of soluble immune complexes. In general these techniques are based either on the physical properties (e.g., precipitation with polyethylene glycol (PEG) or precipitation at cold temperatures) or on the biological characteristics of the IC. The latter techniques make use of various properties of IC such as their ability to bind C1q or their binding to cells that express CR1 and CR2 (Raji cell assay). Table 23.3 lists those assays that have achieved wider use, some of which will be discussed below.

A. Detection of Cryoglobulins

Circulating IC are often formed in antigen excess, with low-affinity antibodies, and remain soluble at room temperature. However, if the serum containing these IC is cooled to 4°C for about 72 hours, the stability of the antigen-antibody reaction increases and eventually there is sufficient cross-linking to result in the formation of large aggregates, which precipitate spontaneously (Fig. 23.4). Because antibodies are the main constituents of these cold precipitates, and because antibodies are globulins, the precipitated proteins are designated as cryoglobulins. Serum separated from blood drawn, clotted, and centrifuged at 37°C is used for detection of cryoglobulins. The proper characterization of a cryoprecipitate requires redissolution of the precipitated proteins at 37°C, followed by their immunochemical characterization (Fig. 23.5). The immunochemical characterization allows us to classify cryoglobulins classified in two major types:

1. Monoclonal cryoglobulins, containing immunoglobulin of one single isotype and one single light-chain class.
2. Mixed cryoglobulins, containing two or three immunoglobulin isotypes, one of which (usually IgM) can be a monoclonal component (with one single light-chain type and one single heavy-chain class), while the remaining immunoglobulins are polyclonal. Complement components (C3, C1q) can also be found in the cryoprecipitates containing mixed cryoglobulins.

Table 23.3 Most Commonly Used Screening Tests for Soluble IC

A. Based on thermosolubility
cryoprecipitation
B. Based on differential PEG solubility
Measurement of PEG-induced turbidity
Assay of total protein in PEG precipitates
Assay of IgG in PEG precipitates
C. Based on interactions with complement
Solid-phase C1q binding assay
D. Based on IC-cell interactions
Raji cell assay

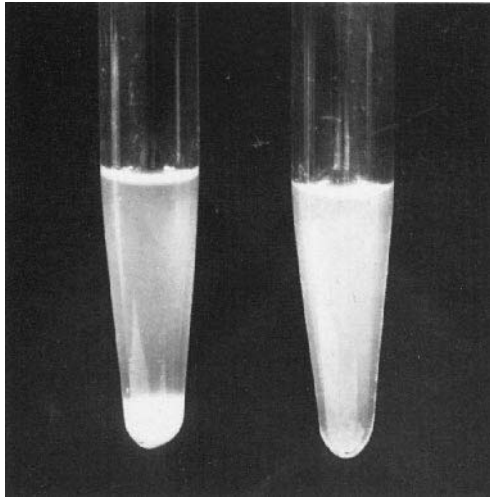

Fig. 23.4 Cryoglobulin screening. Two test tubes were filled with sera from a patient (left) and a healthy volunteer (right). After 48 hours at 4°C, a precipitate is obvious in the patient's serum but is not present in the control.

Monoclonal cryoglobulins are usually detected in patients with plasma cell malignancies and in some cases of idiopathic cryoglobulinemia. Monoclonal cryoglobulins are essentially monoclonal proteins with abnormal thermal behavior, and their existence has no correlation with immune complex formation or any special diagnostic significance besides the possibility of creating conditions favorable for the development of the hyperviscosity syndrome (see Chapter 27).

Mixed cryoglobulins, on the contrary, represent cold-precipitable immune complexes. One of the immunoglobulins present in the precipitate (usually the monoclonal

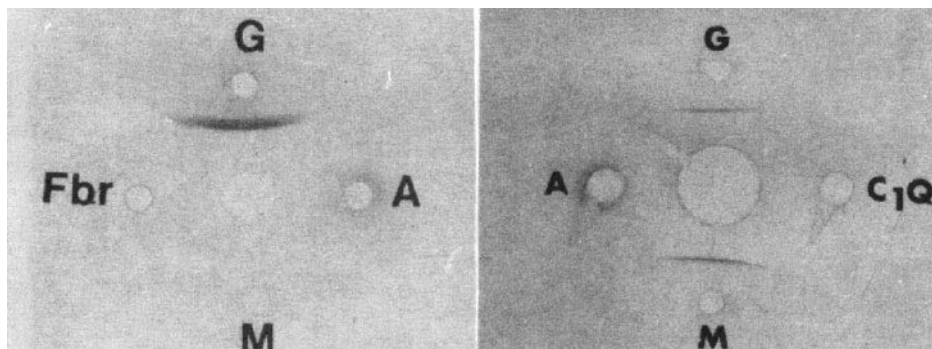

Fig. 23.5 Characterization of two washed cryoglobulins. In both studies, the washed and redissolved cryoglobulin was placed on the center well and four different antisera in the surrounding wells. The cryoglobulin studied on the left reacted with anti-IgG (G) only and was classified as a monoclonal cryoglobulin; the one studied on the right reacted with anti-IgG (G) and anti-IgM (M) and was classified as a mixed cryoglobulin.

component) is an antibody that reacts with the other immunoglobulin(s) that constitute the cryoglobulin. The most frequent type of mixed cryoglobulin is IgM-IgG, in which IgM is a "rheumatoid factor." It is believed that, at least in some cases, the IgM antibody is directed to determinants expressed by IgG antibodies bound to their corresponding antigens (Fig. 23.6). Evidence supporting the involvement of infectious agents in the formation of mixed cryoglobulins has been obtained by identifying antigens and/or antibodies in the cryoprecipitates, particularly hepatitis viruses or antigens derived from them.

B. Techniques Based on the Precipitation of Soluble Immune Complexes with Polyethylene Glycol

Low concentrations of PEG (3–4%) cause preferential precipitation of IC relative to monomeric immunoglobulins. For IC screening purposes, a dilution of patient's serum and PEG are mixed, and the turbidity of the sample is measured after adequate incubation; a direct correlation can be established between the degree of turbidity and the concentration of IC in the serum. Other assays involve the incubation of mixtures of PEG and sera until a precipitate is obtained, and then total protein, IgG, or C1q is measured in the precipitate. This technique is also frequently used as the initial step in immune complex isolation protocols.

C. Assays Based on Interactions with Complement

One of the most widely used techniques for general screening of IC is based on the binding of C1q. The original method employed purified ^{125}I -labeled C1q as a tracer for soluble IC precipitated with either a second antibody (anti-human IgG) or polyethylene glycol. A solid-phase technique was later introduced, which proved to be equally simple but consid-

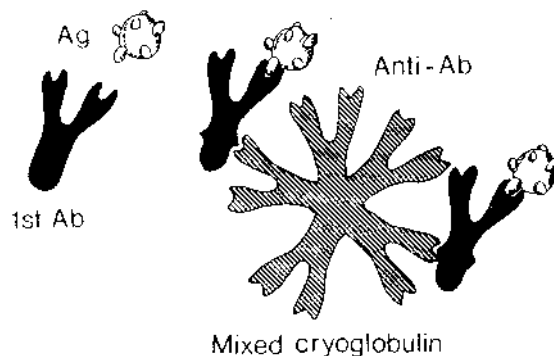

Fig. 23.6 Diagrammatic representation of the pathogenesis of mixed cryoglobulins. Initially, an antimicrobial antibody (for example) of the IgG class is produced. This antibody, a consequence of binding to the antigen, exposes a new antigenic determinant, which is recognized by an IgM antiglobulin. The combination of this IgM with the first IgG antibody and the microbial antigen constitutes the mixed cryoglobulin. Viral antigens and corresponding antibodies (e.g. HBsAg and anti-HBsAg) have been characterized in cryoprecipitates from patients with mixed cryoglobulins, both with and without a history of previous viral hepatitis. It is believed that this mechanism, antiviral IgG combined with an IgM antibody, accounts for over 50% of the cases of essential or idiopathic cryoglobulinemia (cryoglobulinemia appearing in patients without evidence of any other disease).

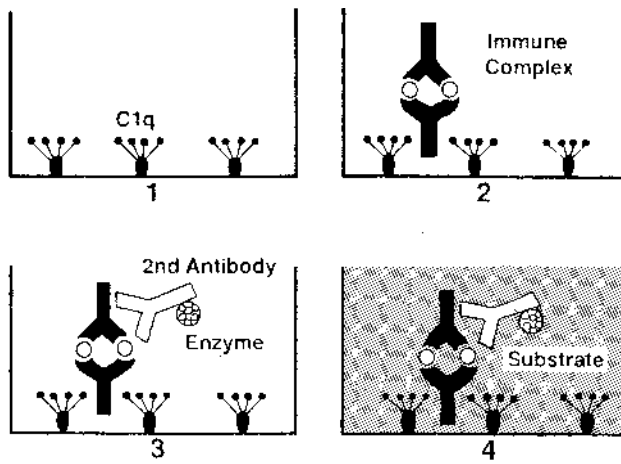

Fig. 23.7 Diagrammatic representation of the principle of the solid-phase C1q binding assay. Purified C1q is immobilized by adsorption to a solid phase. IC containing IgG antibodies will bind to the immobilized C1q. After washing off unbound proteins, an enzyme-labeled anti-IgG antibody is added to the solid phase. This antibody will bind to the immobilized immune complexes. After washing off unbound, labeled antibody, a colorless substrate will be added to the solid phase. The substrate is broken down into a colored compound, and the intensity of the color is directly proportional to the concentration of labeled antibody bound to the solid phase, which in turn is proportional to the concentration of IC bound to C1q.

erably more precise and reproducible. In this technique purified C1q is immobilized in the wells of a microtiter plate, and when an IC-containing sample is added to the C1q-coated well the IC contained in the added sample will be bound to the immobilized C1q. To determine whether IC are bound to C1q, enzyme-labeled antihuman IgG antibodies are added to the wells; their retention on the plate is directly proportional to the IC captured by the immobilized C1q (Fig. 23.7).

D. Specific Immune-Complex-Screening Tests

The detection of IC through their antigen or antibody moieties is conceptually very attractive. Indeed, the probability of obtaining false-positive results is considerably reduced when specific tests are used. The main difficulties with this approach are the wide variety of antigen-antibody systems involved and the lack of knowledge concerning the precise antigen-antibody systems involved in given patient. However, in some cases it has been possible to detect specific antigens and/or antibodies in cryoprecipitates, PEG precipitates, or other IC-enriched fractions obtained from patient sera, and such studies are very valuable in establishing the etiology of specific types of IC disease.

V. THE ROLE OF IMMUNE COMPLEXES IN HUMAN DISEASE

A. Classification of Immune Complex Diseases

Immune complexes have been implicated in human disease either through demonstration in serum or through identification in tissues where lesions are found. Most often the anti-

Table 23.4 A Classification of Immune Complex Diseases According to the Antigen Involved

1. ICD involving endogenous antigens
Immunoglobulin antigens, e.g., rheumatoid arthritis, hypergammaglobulinemic purpura
Nuclear antigens, e.g., systemic lupus erythematosus
Specific cellular antigens, e.g., tumors, autoimmune diseases
Modified lipoproteins, e.g., atherosclerosis
2. ICD involving exogenous antigens
Medicinal antigens, e.g., serum sickness, drug allergy
Environmental antigens
Inhaled, e.g., extrinsic alveolitis
Ingested, e.g., dermatitis herpetiformis
Antigens from infectious organisms
Viral, e.g., chronic hepatitis B and C, HIV/AIDS
Bacterial, e.g., poststreptococcal glomerulonephritis, subacute endocarditis, leprosy, syphilis
Protozoan, e.g., malaria, trypanosomiasis
Helminthic, e.g., schistosomiasis, onchocerciasis
3. ICD involving unknown antigens
Most forms of chronic immune complex glomerulonephritis, vasculitis with or without eosinophilia, and many cases of mixed cryoglobulinemia

body moiety of the immune complex is detected, and knowledge about the antigens involved is still very fragmentary. However, one of the most common classifications of IC disease, proposed by a WHO-sponsored committee, is based on the nature of the antigens involved (Table 23.4).

B. Clinical Expression of IC Disease

The clinical expression of IC disease depends on the target organs where the deposition of IC predominates:

The kidney is very frequently affected (systemic lupus erythematosus, mixed cryoglobulinemia, chronic infections, poststreptococcal glomerulonephritis, purpura hypergammaglobulinemica, serum sickness, etc.), usually with glomerulonephritis as the predominating feature.

The joints are predominantly affected in rheumatoid arthritis.

The skin is affected in cases of serum sickness, mixed cryoglobulinemia, and vasculitis.

The large vessels are affected by the subendothelial formation of antigen-antibody complexes containing oxidized low-density lipoprotein and the corresponding antibodies, leading to the development or progression of atherosclerosis.

The lungs are affected in extrinsic alveolitis.

The reasons why the target organs can vary from disease to disease are not clear. In some cases, such as in extrinsic alveolitis, the route of exposure to the antigen is a major determinant for the involvement of the lungs. The kidneys, due to their physiological role and to the existence of C3 and Fc receptors in different anatomical structures, appear to be an ideal organ for IC trapping. In rheumatoid arthritis, IC appear to be present not only in

the circulation, but also to be present (and probably formed) in and around the joints, and although they do not appear to be the initiating factor for the disease, their potential for perpetuating the inflammatory lesions is unquestionable. Finally, the reasons why some IC are trapped in the skin, leading to vasculitis and other dermatological manifestations, are unknown.

VI. THERAPEUTIC APPROACHES TO IMMUNE COMPLEX DISEASE

The most common types of therapy in immune complex disease are based on four main approaches:

1. Eradication of the source of persistent antigen production (e.g., infections, tumors).
2. Turning off the inflammatory reaction (using corticosteroids and nonsteroidal agents).
3. Suppression of antibody production using immunosuppressive drugs such as cyclophosphamide, azathioprine, or cyclosporine. This is the mainstay of IC disease treatment, particularly when autoimmune reactions are on its basis.
4. Removal of soluble IC from the circulation by plasmapheresis, a procedure that consists of the removal of blood (up to 5 L each time), separation and reinfusion of red cells, and replacement of the patient's plasma by normal plasma or plasma-replacing solutions. Plasmapheresis appears most beneficial when associated with the administration of immunosuppressive drugs; by itself, it can even induce severe clinical deterioration, perhaps related to changes in the immunoregulatory circuits. The main drawbacks of plasmapheresis are its high cost (derived from the sophisticated equipment used and from the cost of plasma and plasma-replacing products) and the fact that it can only be adequately performed in a well-equipped medical center.

In the last few years there has been considerable interest in applying emerging basic concepts on the pathogenesis of inflammation on the treatment of a variety of conditions in which IC formation or deposition may play an important role. Three major approaches have been tried:

1. Blocking critical cytokines, such as TNF. This has been done either with monoclonal antibodies reacting with pro-inflammatory cytokines, with cytokine receptor antagonists, or with recombinant cytokine receptors. A soluble TNF-receptor-Fc fusion protein, which blocks the effects of TNF, has been approved by the FDA for use in rheumatoid arthritis.
2. Interruption of the interaction between leukocyte integrins and endothelial cell adhesion molecules. Humanized anti-CAM-1 (and other cell-cell interaction-facilitating molecules) as well as soluble forms of these molecules have been successfully tested in animal models.
3. Inhibition of the complement activation cascade using soluble forms of regulatory proteins (C1 inhibitor, MCP, DAF, CR1) and antifactor antibodies (anti-C5 antibody) with the goal of inhibiting the production of C3a and C5a (see Chapter 9).

SELF-EVALUATION

Questions

Choose the one *best* answer.

- 23.1 A patient injected with horse antirattlesnake venom serum complains of general weakness, headaches, muscular and joint pains, and notices that his urine is darker in color 10 days after the injection. A urine test shows increased elimination of proteins. Laboratory tests show normal immunoglobulin levels and low serum C4 and C3. The most likely cause for this clinical situation is:
- A. Delayed hypersensitivity to horse proteins
 - B. Deposition of antigen-antibody complexes made of horse proteins and human immunoglobulins
 - C. Deposition of antigen-antibody complexes made of snake venom proteins and horse antibody
 - D. Immediate hypersensitivity to snake venom
 - E. Systemic reaction to snake venom released after the effects of the antitoxin have disappeared
- 23.2 The binding of IC to RBC is believed to play a physiological role by:
- A. Causing cold agglutination
 - B. Causing hemolysis
 - C. Delivering IC to the RES
 - D. Promoting tissue deposition of IC
 - E. Shortening red cell half-life
- 23.3 Which of the following soluble mediators is released by activated PMN leukocytes and contributes to the migration of neutrophils towards an inflamed tissue?
- A. C5a
 - B. IL-1
 - C. IL-8
 - D. Platelet-activating factor
 - E. TNF
- 23.4 The effects of C5a include all of the following except:
- A. Chemotaxis
 - B. Degranulation of basophils and mast cells
 - C. Induction of PAF synthesis by endothelial cells
 - D. PMN aggregation
 - E. Vasodilation
- 23.5 Which one of the following procedures or measures is useful for the treatment of immune complex disease?
- A. Administration of antihistaminic drugs
 - B. Blocking phagocyte Fc receptors with intravenous gammaglobulin
 - C. Inducing neutropenia with cytotoxic drugs
 - D. Lowering complement levels
 - E. Plasmapheresis

- 23.6 All of the following are considered as possible manifestations of IC disease *except*:
- A. Extrinsic alveolitis
 - B. Glomerulonephritis
 - C. Immune hemolytic anemia
 - D. Type I cryoglobulinemia
 - E. Vasculitis
- 23.7 An example of IC disease involving exogenous antigens is:
- A. Hypergammaglobulinemic purpura
 - B. Malaria-associated glomerulonephritis
 - C. Rheumatoid arthritis
 - D. Sjögren's syndrome
 - E. Systemic lupus erythematosus-associated glomerulonephritis
- 23.8 Factors associated with increased risk of development of immune complex disease include all of the following *except*:
- A. Blockade of the RES
 - B. Formation of immune complexes at antigen excess
 - C. Involvement of IgG1 and IgG3 in the formation of IC
 - D. Release of vasoactive substances
 - E. Strong immune response against the offending antigen

Questions 23.9 and 23.10 refer to the following case: A 36-year-old woman with history of drug abuse, hepatitis C, and treatment with IFN- α (6 months ago) presents with recent proven streptococcal throat infection, low-grade fever, malaise, migratory joint pains affecting predominantly the knees and elbows, and a nonblanching maculopapular rash distributed over her lower extremities and back.

- 23.9 The most likely diagnosis for this patient is:
- A. Infectious arthritis
 - B. Postinfectious vasculitis
 - C. Rheumatic fever
 - D. Rheumatoid arthritis
 - E. Thrombocytopenic purpura
- 23.10 Which of the following tests would give the most valuable information about the pathogenesis of this disease?
- A. ASO titer
 - B. Cryoglobulin assay
 - C. Hepatitis C virus serologies
 - D. Liver biopsy
 - E. Liver enzymes

Answers

- 23.1 (B) This is a classical scenario for serum sickness. The horse antivenom serum will initially neutralize the poison and promote its elimination, but enough horse serum proteins will be left in circulation to induce an immune response. As soon as antivenom protein antibodies are secreted, antigen-antibody complexes will be formed, and their deposition will cause pathological symptoms, namely glomerulonephritis that is reflected by hematuria and proteinuria.

- 23.2 (C) RBC-bound IC are kept in the intravascular compartment until taken up by the phagocytic cells of the RES. This, in general, is believed to be a physiological protective function.
- 23.3 (D) Of the five listed mediators, only PAF is released in large concentrations by neutrophils. Of the two, PAF is the only one involved in promotion of neutrophil-EC interactions, which is the essential first step for the migration of neutrophils towards areas of tissue inflammation.
- 23.4 (C) IL-1 and TNF trigger the synthesis of platelet-activating factor (PAF) by endothelial cells.
- 23.5 (E) Plasmapheresis has been used with some success in the treatment of very severe IC disease, as a way to induce a quick reduction of circulating IC levels. The induction of neutropenia or complement depletion reduces the severity of IC disease in experimental animals, but would be rather risky in humans. Blocking phagocyte Fc receptors is likely to have adverse effects by prolonging the persistence of IC in circulation.
- 23.6 (D) Type I (monoclonal) cryoglobulinemia is not an expression of IC disease, but rather the laboratory expression of a peculiar tendency for some rare monoclonal proteins to form self-aggregates at cold temperatures.
- 23.7 (B) Malaria, such as many other chronic infections, can be associated with glomerulonephritis secondary to the deposition of IC formed by *Plasmodium* antigens and the corresponding antibodies. Thus, it can be considered as an example of IC disease involving exogenous antigens.
- 23.8 (E) A strong immune response is usually associated with formation of medium to large complement-fixing IC, which are rapidly taken up by phagocytic cells, promoting rapid elimination of the antigen without apparent consequences for the host.
- 23.9 (B) The development of a nonblanching maculo-papular rash in a patient with hepatitis C is highly suggestive of postinfectious vasculitis secondary to the deposition of antigen-antibody complexes. Neither rheumatic fever nor infectious arthritis is usually associated with vasculitis; rheumatoid arthritis has no relationship either with viral hepatitis or with streptococcal infections, and affects predominantly the smaller joints on the hands.
- 23.10 (B) Around 45% of patients with hepatitis C have mixed cryoglobulinemia that manifests with malaise, arthritis, and skin vasculitis secondary to the deposition of immune complexes which contain viral antigens, rheumatoid factor, and anti-virus C antibodies. Thus, the finding of a mixed cryoglobulin, indicating the presence of circulating immune complexes, has direct relevance to the understanding of the pathogenesis of the pathological process that results in vasculitis and inflammatory arthritis.

BIBLIOGRAPHY

Bielory, L., Gascon, P., Lawley, T. J., Young, N. S., and Frank, M. M. Human serum sickness: A

- prospective analysis of 35 patients treated with equine anti-thymocyte globulin for bone marrow failure. *Medicine* 67:40, 1988.
- Argenbright, L. W., and Barton, R. W. Interactions of leukocyte integrins with intercellular adhesion molecule 1 in the production of inflammatory vascular injury in vivo. The Shwartzman reaction revisited. *J. Clin. Invest.* 89:259, 1992.
- Collins, T. Adhesion molecules and leukocyte emigration. *Sci. Med.* 2 (6):28–37, 1995.
- Dinant, H. J., and Dijckmans, B. A. New therapeutic targets for rheumatoid arthritis. *Pharmacy World Sci.* 21:49, 1999.
- Fleishman, R. M. Early diagnosis and treatment of rheumatoid arthritis for improved outcomes: focus on etamcept, a new biological response modifier. *Clin. Therp.* 21:1429, 1999.
- Hebert, L. A. The clearance of immune complexes from the circulation of man and other primates. *Am. J. Kidney Dis.* XVII (3):352, 1991.
- Lopes-Virella, M. F., and Virella, G. The immunology of atherosclerosis. *Diabetes Ann.* 11:81, 1998.
- Luster, A. D. Chemokines-chemotactic cytokines that mediate inflammation. *N. Engl. J. Med.* 338:436, 1998.
- Mulligan, M. S., Miyasaka, M., and Ward, P. A. Protective effects of combined adhesion molecule blockade in models of acute lung injury. *Proc. Assoc. Am. Phy.* 108:198, 1996.
- Nityanand, S., Holm, G., and Lefvert, A. K. Immune complex mediated vasculitis in hepatitis B and C infections and the effect of anti-viral therapy. *Clin. Immunol. Immunopath.* 82:250, 1997.
- Oppenheimer-Marks, N., and Lipsky, P. E. Adhesion molecules as targets for the treatment of autoimmune diseases. *Clin. Immunol. Immunopath.* 79:203, 1996.
- Tsai, J.-F., Margolis, H. S., Jeng, J. E., et al. Immunoglobulin- and hepatitis B surface antigen-specific circulating immune complexes in chronic hepatitis B virus infection. *Clin. Immunol. Immunopath.* 86:246, 1998.
- Tsokos G. C. Lymphocytes, cytokines, inflammation, and immune trafficking. *Curr. Opin. Rheumatol.* 7:376, 1995.
- Zimmerman, G. A., Prescott, S. M., and McIntyre, T. M. Endothelial cell interactions with granulocytes: Tethering and signaling molecules. *Immunol. Today* 13:93, 1992.

24

Immune System Modulators

Philip D. Hall, Jean-Michel Goust, and Gabriel Virella

I. INTRODUCTION

A. Immune System Modulators

These are agents, principally drugs, that adjust the activity of a patient's immune response, either up or down, until a desired level of immunity is reached. The principal targets of immune modulation are the specific components of the immune response, T and B-lymphocyte clones, which can hopefully be selectively "fine-tuned" in their function to promote the better health of the patient. Three general clinical scenarios dominate the immunomodulation landscape:

1. Immunosuppressive therapies, utilized when specific T and B lymphocytes of the patient's immune system have become activated against the patient's own body organs, such as in autoimmune diseases (see Chapters 17–19) or in organ transplantation (see Chapter 25)
2. Induction of hyporesponsiveness or tolerance, which has the advantage of targeting the undesirable immune response rather than inducing a generalized immunosuppression. In some cases, the effect of hyposensitization is truly immunomodulatory, shifting the response from pathogenic to protective or indifferent, as in the case of hyposensitization of patients with IgE-mediated hypersensitivity (see Chapter 21).
3. A third modulator option is to attempt to boost the overall B- and T-lymphocyte function of the patient (Immunopotential). This can be accomplished either by actively stimulating the patient's own immune system to higher

performance levels through immunization techniques or by passively introducing protective immune system components from outside sources, such as gamma globulin (see Chapter 29) or hematopoietic growth factors, into the patient's body.

B. Anti-Inflammatory Drugs

The effects of these drugs do not focus upon the function of T and B lymphocytes but are rather directed toward changing the function of the nonspecific inflammatory components of the immune system, mononuclear phagocytes, polymorphonuclear granulocytes, natural killer (NK) cells, and mast cells. These cells play an essential role in the elimination of infectious agents (see Chapters 13 and 14) and are also the key to inflammatory processes associated with anti-infectious responses, autoimmunity, or hypersensitivity, which can have devastating effects for the patient.

II. IMMUNOSUPPRESSION

A. Introduction

At present, suppression of the immune response is the most efficacious therapy in most autoimmune diseases, in the control of transplant rejection, and in other situations in which the immune system plays a significant pathogenic role. Most of the currently used immunosuppressive drugs have a generalized, nonspecific suppressive effect. Some immunosuppressants have effects practically limited to either humoral or cell-mediated immunity, but they still lead to generalized immunosuppression. More recently, a variety of new biological agents have been tried in different immunosuppressive regimens, including monoclonal antibodies to T cells and their subsets, immunotoxins, IL-2-toxin conjugates, anti-idiotypic antibodies, etc., with the goal of developing more specific and effective therapies (see Chapters 25 and 26). In many cases these agents are still in the early stages of evaluation, and it is too soon to issue definite judgments about their usefulness. It is, however, unquestionable that they are the prototypes of approaches that will be more and more used in the near future.

B. Immunosuppressive Drugs: Pharmacological and Immunological Aspects

A variety of drugs, ranging from glucocorticoids to cytotoxic drugs, have been used for the purpose of suppressing undesirable immune responses. While many of these drugs are loosely termed "immunosuppressive," they differ widely in their mechanisms of action, toxicity, and efficacy. The exact mechanisms of action of immunosuppressive drugs are difficult to determine, partly because the physiology of the immune response has not yet been completely elucidated. The targets of immunosuppressive therapies are rather diverse and, depending on the agents, may include phagocytosis and antigen-processing by macrophages; antigen recognition by lymphocytes; proliferation and/or differentiation of lymphocytes; production of cytokines; immune effector mechanisms, including the production and release of cytotoxic leukocytes, antibodies, and/or delayed hypersensitivity mediators.

1. Hormones

The major agents in this group of substances are the glucocorticoid hormones of the adrenal complex cortex and their synthetic analogs (glucocorticoids or corticosteroids, such as prednisone and methylprednisolone). The mechanisms of actions of glucocorticoids are still being defined, but they can be divided into three major effects.

Induction of Apoptosis. At certain dosage levels, treatment with glucocorticoids may produce a rapid and profound lymphopenia. This is particularly true in cases of lymphocytic leukemia, and it is a consequence of the induction of apoptosis. The molecular mechanism of glucocorticoid-induced apoptosis hinges on the activation of an endonuclease, which is normally inactive due to its association to a protein. This effect, like all other cellular effects of glucocorticoids, including the induction of apoptosis, requires association with a glucocorticoid cytoplasmic receptor. The glucocorticoid-receptor complex is translocated to the nucleus, where it binds to regulatory DNA sequences (glucocorticoid-responsive elements). At the genetic level, two possibilities have been suggested to account for the enhancement of apoptotic processes based on experimental observations:

1. Downregulation of the synthesis of the protein that inactivates the endonuclease responsible for DNA breakdown
2. Activation of an ICE-like protease that degrades the endonuclease-inactivating protein

Downregulation of Cytokine Synthesis. The administration of glucocorticoids is followed by a general downregulation of cytokine synthesis. This effect is secondary to the inhibition of nuclear binding proteins that activate the expression of cytokine genes. Two mechanisms (not mutually exclusive) have been proposed (Fig. 24.1).

1. After combining with the glucocorticoid cytoplasmic receptor, the glucocorticoid-receptor complex is translocated to the nucleus, where it prevents the association of AP-1 with promoter sequences controlling the expression of cytokine genes.
2. The translocated glucocorticoid-receptor complex binds to the promoter of the inhibitory protein that regulates the activity of NF κ B (I κ B; see Chapters 4 and 11) and induces its expression. The synthesis of abnormally high levels of I κ B results in the inactivation of NF κ B, thus neutralizing a second nuclear-binding protein that enhances the expression of cytokine genes.

Anti-Inflammatory Effects. The anti-inflammatory effect of glucocorticoids is probably the most significant from the pharmacological point of view. Several actions of glucocorticoids combine to induce this anti-inflammatory effect:

1. Downregulation of the synthesis of pro-inflammatory cytokines.
2. Reduced expression of CAMs on the vessel wall, partly as a consequence of the downregulation of cytokine synthesis (pro-inflammatory cytokines upregulate CAM expression) and partly as a consequence of a direct downregulation of the expression of the genes encoding those molecules. The modulation of CAM expression has a marked effect on leukocyte traffic. Neutrophils and T lymphocytes are predominantly affected and remain sequestered on the bone marrow and lymph nodes, impairing their ability to generate both specific immune responses and nonspecific inflammatory responses.
3. The synthesis of phospholipase A₂ is downregulated due to the binding of the glucocorticoid-receptor complex to a DNA glucocorticoid-responsive element

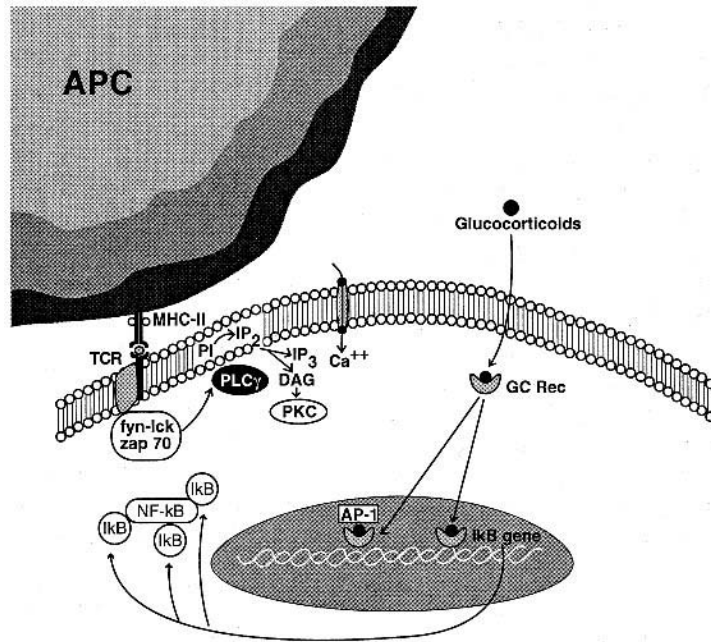

Fig. 24.1 Diagrammatic representation of the mechanism of action responsible for the downregulation of cytokine synthesis by glucocorticoids. Once internalized in the cytoplasm, glucocorticoids combine with their receptor and the complex is translocated to the nucleus, where it interacts with the nuclear binding protein AP-1, preventing its interaction with cytokine gene enhancers and with a glucocorticoid-responsive element that upregulates the expression of the I κ B gene. The excess of I κ B protein prevents the activation of NF- κ B, another nuclear binding protein, which normally activates the expression of cytokine genes (see Chapters 4 and 11).

that has a negative effect on the expression of the phospholipase A₂ gene. Consequently, the synthesis of leukotrienes, prostaglandins, and platelet-activating factor is also downregulated.

4. The nitric oxide synthase gene is also downregulated; thus, the release of nitric oxide is reduced, eliminating its vasodilator effect.
5. In contrast, glucocorticoids upregulate the expression of lipocortin-1, a protein that has anti-inflammatory effects in part due to its ability to inactivate preformed phospholipase A₂.

Nonsteroidal Anti-inflammatory Drugs. Nonsteroidal anti-inflammatory drugs (NSAIDs) are totally unrelated to the corticosteroid family but share certain anti-inflammatory properties. The anti-inflammatory potency of the NSAID family appears to directly correlate with their ability to inhibit prostaglandin and thromboxane synthesis from arachidonic acid by inhibiting the enzyme cyclooxygenase (COX). There are two isoforms of the COX enzyme. COX-1 is constitutively expressed in most cells, while COX-2 is induced in inflamed tissue only. The anti-inflammatory properties of both selective and nonselective NSAIDs appear to be related to their inhibition of COX-2. Some of the adverse effects of the nonselective NSAIDs (e.g., gastrointestinal and renal toxicity) may be related to the inhibition of COX-1.

NSAIDs include a large number of prescription and over-the-counter (OTC) drugs. Common examples of the nonselective COX-1 and -2 inhibitors include aspirin, ibuprofen,

indomethacin, naproxen, and ketorolac. There are currently only two FDA-approved selective COX-2 inhibitors, celecoxib and rofecoxib. NSAIDs do not appear to modulate cytokine release or to alter T- and B-lymphocyte cell trafficking, and thus have virtually no immunosuppressive effects.

2. Alkylating Agents and Antimetabolites

Several commonly used immunosuppressants fit into this category. They can be generically classified into two large groups: cell-cycle specific and cell-cycle nonspecific. The choice between the two types of immunosuppressants is based both on clinical experience and on their characteristics. For example, for the treatment of autoimmune diseases that form abnormal immune humoral- and cell-mediated immune responses, the goal is to turn off the proliferating autoreactive lymphocytes, and cell-cycle-specific agents with the ability to block DNA synthesis are utilized. On the other hand, plasma cell malignancies are difficult to treat with cell-cycle-specific agents, because the majority of antibody-producing plasma cells are not in cycle, but rather in a prolonged G₁ or “G₀” state. In this case, cell-cycle-nonspecific agents are most likely to be effective.

Cell-cycle-specific agents cause cell death by interfering with different parts of the cell division cycle. This group includes the antimetabolites methotrexate, azathioprine, and 6-mercaptopurine (6-MP), which appear to act only on cells in the S-phase, when DNA is actively synthesized. Two newer compounds, mycophenolate mofetil and leflunomide, are also included in this group.

Methotrexate, a folic acid analog, binds to and inhibits dihydrofolate reductase, thus blocking the formation of the DNA nucleotide thymidine. It is most active against cells in the S-phase of the cell cycle. T lymphocytes, after appropriate antigen stimulation, begin to proliferate and enter the S-phase of the cell cycle. Therefore, methotrexate is used to block lymphocyte proliferation. Unfortunately, methotrexate also targets other rapidly dividing cells (e.g., bone marrow, gastrointestinal tract, hair follicles), leading to its common side effects (agranulocytosis and other consequences of bone marrow suppression, diarrhea and other gastrointestinal symptoms secondary to mucosal damage, and alopecia). Methotrexate is commonly used to treat NSAID-refractory rheumatoid arthritis and malignancies (e.g., breast cancer and acute lymphoblastic leukemia).

Azathioprine has been used in solid organ transplantation since 1963. After absorption, azathioprine is metabolized by hepatic and RBC glutathione to 6-mercaptopurine. Intracellularly, 6-MP is converted to form thiopurine ribonucleosides and nucleotides that inhibit purine synthesis by both the de novo pathway and salvage pathway and thereby inhibit the proliferation of T and B lymphocytes. Azathioprine was commonly used with cyclosporine and prednisone as the “standard” regimen for prevention of solid organ transplant rejection. More recently mycophenolate has been taking its place in these combinations (see below). In addition, azathioprine is used to treat Crohn’s disease. 6-MP is mainly used in combination with methotrexate as part of maintenance therapy for acute lymphoblastic leukemia in children.

Mycophenolate mofetil (MMF, Cellcept) also inhibits lymphocyte proliferation. It acts as a reversible inhibitor of inosine monophosphate dehydrogenase, thus interfering with the de novo pathway of guanine nucleotide synthesis and subsequent DNA replication. T and B lymphocytes are highly dependent on the de novo pathway for the generation of guanosine nucleotides whereas other cells can use the salvage pathway. Thus, mycophenolate affects T and B lymphocytes with some degree of selectivity over other types

Table 24.1 Summary of Effects of Drugs with Alkylating and Antimetabolite Activity^a

Effect	Cyclophosphamide	Azathioprine and 6-MP	Methotrexate
Reduced primary immune response	++	++	++
Reduced secondary immune response	++	±	+
Reduced immune complexes	++	0	0
Anti-inflammatory effect	+	++	+
Mitostatic effect	++	++	++
Reduced delayed hypersensitivity	++	+	+
Suppression of passive transfer of cellular immunity	++	±	±
Lymphopenia	++	±	±
Facilitation of tolerance induction	++	+	+

^a On the basis of a combination of experimental and clinical data.

of cells. Mycophenolate is used clinically in prophylaxis of organ rejection in solid organ transplantation.

Leflunomide, recently approved by the U.S. FDA, also hinders the proliferation of lymphocytes by inhibiting a different enzyme, dihydro-orotate dehydrogenase. This is a key enzyme in de novo pyrimidine synthesis, and activated T lymphocytes primarily synthesize pyrimidines by this de novo pathway. In three randomized trials, leflunomide appears to exhibit efficacy similar to sulfasalazine (a NSAID) and methotrexate in patients with active rheumatoid arthritis.

Alkylating agents such as cyclophosphamide or radiation therapy, although able to kill cells in cycle to a greater degree than cells not in cycle, can also kill nondividing cells.

The three classical cytotoxic drugs, cyclophosphamide, azathioprine and methotrexate, all suppress primary and secondary humoral immune responses, delayed hypersensitivity, skin graft rejection, and autoimmune disease in animals. However, some striking differences in the mechanism of action of these three agents have become apparent (Table 24.1).

In studies of the effects of cyclophosphamide, methotrexate, and 6-MP on antibody production in mice, one can compare the dose that kills 5% of the animals within one week (LD_5) with the dose required to reduce the antibody response of the mice by a factor of 2 (inhibitory dose; ID_2); a therapeutic index (TI) can be calculated, which is defined as the ratio of the two doses (LD_5/ID_2). Cyclophosphamide has the highest therapeutic index, followed by methotrexate and 6-MP (Table 24.2).

Table 24.2 Therapeutic Indices of Cytotoxic Agents Inhibiting Antibody Production

Agent	LD_5^a	ID_2^b	TI ^c
Cyclophosphamide	300.0	50.0	6.0
Methotrexate	6.3	1.25	5.0
6-Mercaptopurine	240.0	100.0	2.4

^a LD_5 dose (in mg/kg) killing 5% of animals within one week.

^b ID_2 dose (in mg/kg) lowering antibody titer to $1/2^2$.

^c Therapeutic index = LD/ID .

Sharply different effects of azathioprine and cyclophosphamide on humoral antibody production have also been demonstrated, using flagellin as a test antigen. There was a significant suppression of antibody response to flagellin in cyclophosphamide-treated patients, while the responses of azathioprine-treated patients did not differ significantly from those of nontreated control patients. Several investigators have also shown that cyclophosphamide can decrease the production of anti-DNA antibodies in both NZB mice and humans. This suggests that cyclophosphamide can inhibit an ongoing immune response, whereas azathioprine and 6-MP cannot. This, of course, is the situation that one faces in the treatment of patients with autoimmune disease, since the relevant immune responses are already established by the time that they are recognized and treated. In patients with systemic lupus erythematosus (SLE), cyclophosphamide treatment can reverse the deposition of immune complexes in the dermo-epidermal junction (which correlates with renal disease), whereas steroid therapy alone does not.

Studies of the effects of these drugs on cellular immunity have shown that all three depress cellular immunity. However, comparative studies show a greater effect with cyclophosphamide. While both cyclophosphamide and methotrexate are more effective than 6-MP in suppressing a PPD skin test in experimental animals, only cyclophosphamide depletes thymus-dependent areas of the lymph nodes. The *in vitro* response of lymphocytes to PHA and other mitogens is likewise inhibited only by cyclophosphamide. In addition, tolerance induction is much easier to achieve in mice treated with cyclophosphamide than with azathioprine or methotrexate.

3. Inhibitors of Signal Transduction: Cyclosporine A, Tacrolimus, and Sirolimus

These compounds are fungal metabolites with immunosuppressive properties. Structurally they are macrocyclic compounds; cyclosporin A (CsA) is a macrocyclic peptide, while Tacrolimus and Sirolimus are macrocyclic lactones (macrolides). All are virtually devoid of toxicity for leukocyte precursors and, hence, do not cause leukopenia or lymphopenia. Their molecular mechanism of action depends on their binding to cytoplasmic proteins involved in the process of signal transduction essential for lymphocyte activation and/or proliferation (Fig. 24.2). Because of their ability to bind immunosuppressive compounds, these proteins are collectively known as immunophilins.

Cyclosporine A is cyclic undecapeptide obtained from *Tolypocladium inflatum*. It has a uniquely selective effect on T lymphocytes, suppressing humoral T-dependent responses and cell-mediated immune responses. Its mechanism of action involves high-affinity binding to cyclophilin. The CsA-cyclophilin complex, in turn, binds and inactivates calcineurin. This protein, upon activation, acquires phosphatase proteins and activates NF-AT, a nuclear binding protein involved in the control of the expression of the IL-2 gene and other cytokine genes (see Chapter 11) by dephosphorylation. As a consequence of the inactivation of calcineurin, Ca^{2+} -associated T-cell activation pathways, such as those triggered by anti-CD3 antibodies or the occupancy of the TcR, are inhibited and there is a general downregulation of the production of IL-2, interferon- γ , IL-3, IL-4, GM-CSF, and TNF. The expression of the CD40 ligand is also downregulated.

Helper (CD4⁺) T lymphocytes are the chief cellular target for CsA; T cells with suppressor activity, on the other hand, appear to proliferate at higher rates. This differential effect is reflected in humans by a reversal of the CD4/CD8 ratio rates and by a relative increase in suppressor lymphocyte function. However, the activation of cytotoxic T lymphocytes is also inhibited, apparently due to both the lack of stimulatory signals pro-

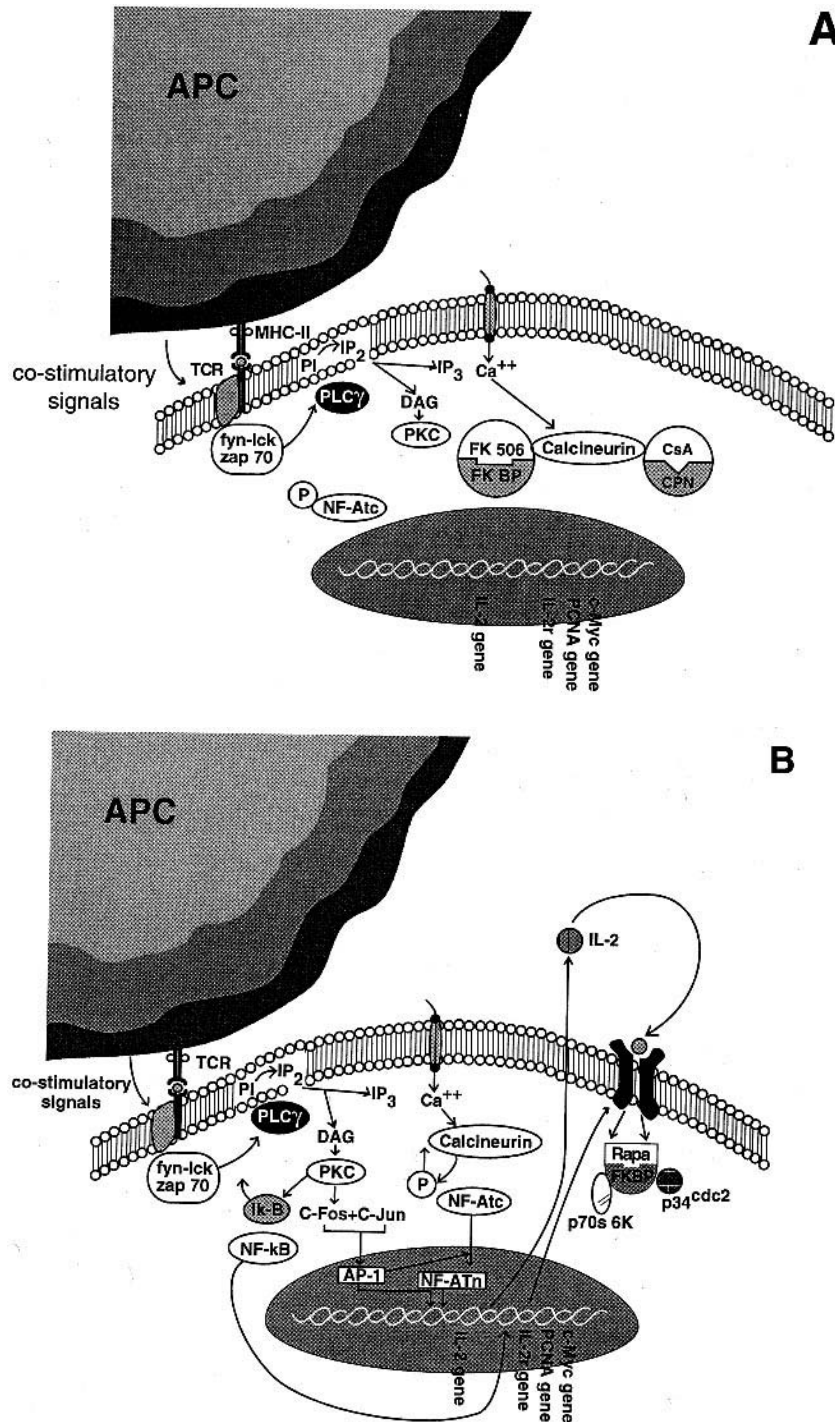

Fig. 24.2 Diagrammatic representation of the mechanism of action of the inhibitors of signal transduction. The main steps in the T-cell activation signaling cascade can be seen in Fig. 11.3. (A) Mechanism of action of cyclosporin A and of tacrolimus (FK506). These compounds associate with cytoplasmic targets and the resulting complexes bind and inactivate calcineurin. (B) The effect of rapamycin. This macrolide combines with the same cytoplasmic protein as tacrolimus and the complex interrupts the signal transduction from IL-2 and IL-4 receptors, blocking the progress of the T cell from G1 to S.

vided by IL-2 and interferon- γ and to a direct inhibitory effect on cytotoxic T-cell precursors.

CsA has a remarkable ability to prolong graft survival. In experimental animals, even short courses of CsA can result in significant prolongation of kidney graft survival, suggesting that the drug facilitates the development of low dose tolerance. In humans, used in conjunction with azathioprine or mycophenolate and corticosteroids, it reduces the number of rejection episodes in renal transplantation, even in patients with cytotoxic antibodies and receiving poorly matched organs. It also induces a substantially longer survival of kidney, liver, and especially heart transplants, and reduces the incidence and severity of graft-versus-host disease in bone marrow transplantation. Recent observations suggest that the long-term immunosuppression achieved with associations of low-dose CsA, steroids, and azathioprine or mycophenolate may be preferable to long-term administration of high doses of CsA, at least in patients with kidney transplants.

The main advantages of CsA as an immunosuppressant are its selective effect on T lymphocytes and its excellent steroid-sparing effect. The dosages of steroids necessary to achieve effective immunosuppression are considerably lower when steroids are used with CsA than when they are associated to other immunosuppressive drugs. As a result, the incidence of infection is substantially reduced, although cytomegalovirus infections are relatively common in CsA-treated patients. On the other hand, CsA has many serious side effects, including nephrotoxicity, a major concern in patients with kidney grafts. The renal toxicity is frequently associated with hypertension, which in turn has a negative impact in all patients, especially in those receiving a heart transplant. Other side effects include hypercholesterolemia, hypertriglyceridemia, hirsutism, headaches, fine tremors, gingival hyperplasia, pancreatitis, and electrolyte abnormalities. Accelerated atherosclerosis, probably secondary to therapy-related hypercholesterolemia and hypertriglyceridemia, has been observed in heart transplant recipients surviving for over 2 years, but the mechanism responsible for this complication is not clear. Finally, after long-term administration of CsA, by itself or in combination with other immunosuppressive agents (e.g., antilymphocyte globulin), there is an increased incidence of lymphoproliferative syndromes, most of them of B-cell lineage, probably resulting from the uncontrolled proliferation of the Epstein-Barr virus.

Tacrolimus (Prograf, FK506) is produced by a different fungus (*Streptomyces tsukubaensis*). Its mechanism of action is similar to that of CsA but is 10–100 times more active. The cytoplasmic target of tacrolimus is a different protein, known as FKBP (FK506 binding protein). The tacrolimus-FKBP complex has an effect very similar to that of the cyclophilin-CsA complex—inhibiting calcineurin and preventing the activation of NF-AT. Not surprisingly, the cellular effects of FK506 and CsA are almost identical.

Clinically, tacrolimus has been mainly used to date in liver transplantation. It was first used to reverse rejection in patients unresponsive to other immunosuppressive agents. Its later use as primary immunosuppressant followed and resulted in improved patient survival. Its side effects are similar to those of CsA. Neurotoxicity (including rare cases of severe irreversible encephalopathy), gastrointestinal intolerance, and infections (particularly by cytomegalovirus) are the most prominent complications of its use.

Sirolimus (Rapamycin, Rapamune), from *Streptomyces hygroscopicus*, is structurally similar to tacrolimus but has a different intracellular target and different pharmacological properties. Sirolimus binds two proteins: FKBP, the same cyclophilin bound by tacrolimus, and the FKBP-sirolimus-associated protein (FRAP). The complex formed by cyclophilin, FKBP, and FRAP does not interact with calcineurin, but rather with other cellular targets, which are inactivated. The best characterized targets are two kinases, p70 ri-

bosomal protein S6 kinase and p34^{cdc2}. These enzymes appear to be activated by the interaction of IL-2 and IL-4 with their respective receptors and are required for cells to progress through the replication cycle.

While CsA and FK506 inhibit the transition of lymphocytes from G₀ to G₁, sirolimus inhibits cell division later in G₁, prior to entry into the S-phase. Also, sirolimus inhibits both Ca²⁺-dependent and -independent activation pathways, does not inhibit IL-2 synthesis, but inhibits the response of IL-2- and IL-4-sensitive cell lines to exogenous IL-2 or IL-4. Because of the different mechanism of action, sirolimus is effective even when added 12 hours after in vitro mitogenic stimulation of T cells, while CsA and FK506 are only effective when added to the cultures no later than 3 hours after the mitogen.

In addition to its FDA-approved indication in combination with cyclosporine and prednisone for the prevention of organ rejection after a kidney transplant, sirolimus is still under active investigation in solid organ transplants.

4. Blockers of MHC-II Expression

Two groups of drugs have received considerable attention for their previously unsuspected immunosuppressive and anti-inflammatory properties:

- a. The antimalarial drugs chloroquine and hydroxychloroquine are widely used in the treatment of rheumatoid arthritis and other inflammatory diseases, and are also being evaluated for the treatment of graft-vs.-host disease. These drugs interfere with normal lysosomal functions, increasing the lysosomal pH, inhibiting several steps in the antigen-processing reaction and thus reducing the expression of MHC-II—peptide complexes. This in turn decreases CD4 T-cell activation and downregulates the immune response. These drugs also appear to decrease the synthesis of pro-inflammatory cytokines by mononuclear leukocytes and promote lymphocyte apoptosis.
- b. Statins, such as lovastatin, pravastatin, and atorvastatin, are HMG-CoA reductase inhibitors widely used as lipid-lowering agents. These drugs (especially atorvastatin) inhibit the synthesis of the transactivational promoter for MHC-II, so that the increase in expression of MHC-II molecules seen after stimulation with interferon- γ is completely inhibited. Besides the potentially useful application in atherosclerosis, in which both the lipid-lowering and immunosuppressive/anti-inflammatory effects are beneficial, the statins are being evaluated for their potential benefits in rheumatoid arthritis and multiple sclerosis.

5. Immunosuppressive Polyclonal Antibody Preparations

Polyclonal antibody preparations are commonly used to treat corticosteroid-resistant acute rejection episodes in solid organ transplant recipients. Currently, there are two preparations commercially available: antithymocyte globulin (equine antiserum) and thymoglobulin (rabbit antiserum) (Table 24.3). Both antisera are prepared by injecting human T lymphocytes into either a horse or a rabbit. The serum from these animals is then harvested and sterilized prior to administration into patients. Unfortunately, these preparations contain not only antibodies directed against T lymphocytes but also against neutrophils, erythrocytes, and platelets. Therefore, patients treated with antilymphocyte globulin or with

Table 24.3 Immunosuppressive Antibody Preparations in Clinical Use

Product	Antigen	Source	Preparation	Comments
Antithymocyte globulin (ATGAM)	Human thymocytes	Equine	Polyclonal	Cross-reacts with neutrophils (neutropenia), RBCs (anemia), and platelets (thrombocytopenia)
Thymoglobulin	Human thymocytes	Rabbit	Polyclonal	Adverse effects similar to ATGAM
Muromonab CD3 (OKT3)	Human CD3	Murine	Monoclonal	Immune response against antibody limits retreatment
Daclizumab (Zenapax)	IL-2 receptor, α -subunit (CD25)	Recombinant	Monoclonal	Recombinant antibodies suppress the human immune response more efficiently and are less immunogenic than murine mAbs
Basiliximab (Simulect)				

thymoglobulin may experience clinically significant neutropenia, anemia, and thrombocytopenia. In addition, these preparations may cause serum sickness, because even in immunosuppressed patients heterologous proteins are so immunogenically potent that they end up eliciting a humoral immune response.

6. *Immunosuppressive Monoclonal Antibodies and Other Biological Response Modifiers*

Several types of monoclonal antibodies have been used with the purpose of suppressing the immune response. Two basic types of mechanisms of action seem to be involved: blocking of co-stimulatory signals and delivery of downregulating signals. While murine monoclonal antibodies trigger immune responses that result in loss of efficiency and, in some cases, clinical manifestations of serum sickness, humanized (chimeric) monoclonal antibodies (hybrid molecules containing the variable regions of a murine monoclonal antibody and the Fc regions of a human immunoglobulin) are considerably less immunogenic.

Monoclonal Antibodies That Block Co-stimulatory Signals. Anti-CD2 monoclonal antibodies have been shown to induce prolonged graft survival in experimental animals. Its mechanism of action was initially thought to involve blocking of the CD2/LFA-3 interaction. However, it is also possible that these monoclonal antibodies deliver downregulating signals to T cells.

Soluble CTLA-4, CTLA4-Ig, anti-CD80/86 monoclonal antibodies, and anti-CD40L have been shown to have immunosuppressive properties, particularly in animal models of autoimmune diseases. The immune suppressive effect is secondary to the blockage of the activation signals mediated by the CD80/86-CTLA-4 interaction or by the CD40-CD40L(CD 154) interaction. CTLA-4 Ig is a fusion protein containing the extracellular domain of CTLA-4 and the Fc region of a human immunoglobulin. It has a longer half-life and is more effective than CTLA-4. Its mechanism of action involves inhibition of IL2-R

gene expression and block of cell division, causing T cells to remain at G_0 . A therapeutic trial of CTLA-4 Ig in patients with psoriasis resulted in clinical improvement in 60–80% of the subjects.

Monoclonal Antibodies That Deliver Inhibitory Signals. Several different monoclonal antibodies against T-cell markers (particularly anti-CD3, muromonab CD3) (Table 24.3) have been successfully used to treat acute graft rejection episodes (see Chapter 25). Muromonab CD3 appears to promote the destruction of T lymphocytes by ADCC. Also, the binding of muromonab CD3 to the CD3 protein on T lymphocytes causes the internalization of the complex and anergy of the T lymphocyte (Fig. 24.3).

The major limitation in the clinical use of muromonab CD3 is development of human antimurine antibodies. Clinically significant antibody titers to murine immunoglobulins occur in >50% of patients treated with a full course of muromonab CD3.

Monoclonal Antibodies That Block the Interleukin-2 Receptor. Daclizumab (Zenapax) and basiliximab (Simulect) are chimeric monoclonal antibodies directed against the IL-2 receptor. Chimeric antibodies consist of murine CDR regions of an antibody incorporated into a human IgG molecule. The alpha chain of the IL-2 receptor is an ideal candidate for immunosuppression because it is minimally expressed on resting T cells and significantly upregulated in activated T lymphocytes. Therefore, basiliximab and daclizumab target mostly activated T lymphocytes. The proposed mechanism of action is the saturation of IL-2 receptors, thereby inhibiting IL-2-driven proliferation, but this may prove to be an oversimplistic explanation. Both basiliximab and daclizumab are used as prophylaxis for acute rejection in renal transplantation but are being investigated in other organ types (e.g., liver, bone marrow) and for reversal of acute rejection episodes.

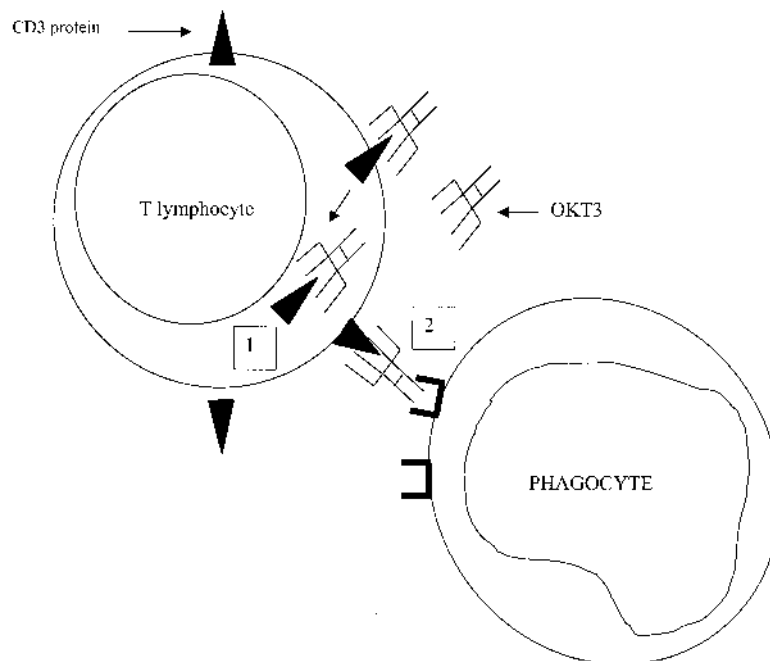

Fig. 24.3 Mechanisms of action of OKT3. (1) OKT3 binds to CD3 on T lymphocytes, which is then internalized, thus rendering the T lymphocyte anergic. (2) OKT3 opsonizes T lymphocytes, thus allowing their recognition by phagocytes.

C. Use of Immunosuppressive Drugs in Hypersensitivity and Autoimmune Diseases

1. Glucocorticoids

Glucocorticoid administration can be life-saving in certain acute disorders, such as bronchial asthma and autoimmune thrombocytopenic purpura and can induce significant improvement in chronic warm autoantibody hemolytic anemia, autoimmune chronic active hepatitis, autoimmune thrombocytopenic purpura, systemic lupus erythematosus, and a variety of chronic hypersensitivity conditions. Steroids are also part of most immunosuppressive regimens used for preventing the rejection of transplanted organs.

2. Cytotoxic Agents and Cyclosporin A

Many nonneoplastic diseases either proven or presumed to be immunologically mediated have been treated with cytotoxic drugs. Results of controlled trials of azathioprine, methotrexate, and cyclophosphamide suggest that these cytotoxic drugs, when given in sufficient quantity, may be capable of suppressing disease activity and eliminate the need for long-term therapy with steroids.

Methotrexate is the most effective second-line drug for rheumatoid arthritis not controlled by NSAIDs. Methotrexate not only alleviates the signs and symptoms of rheumatoid arthritis, but also may increase the hemoglobin and decrease the erythrocyte sedimentation rate (ESR) in patients. Methotrexate is usually given in weekly oral doses.

Cyclophosphamide has been demonstrated to be the only effective means of achieving immunosuppression (and sometimes clinical cure) in certain steroid-resistant diseases, such as Wegener's granulomatosis. Cyclophosphamide is also the drug of choice for the treatment of lupus glomerulonephritis and other vasculitides (see Chapters 18 and 23). Interestingly, cyclophosphamide is better tolerated if given as monthly intravenous pulses rather than daily by mouth.

Azathioprine has also been used in the treatment of patients with SLE. Controlled studies demonstrated a number of beneficial effects, i.e., an increase in creatinine clearance, a decrease in proteinuria, and a decrease in mortality. However, a decrease in glomerular cell proliferation has been noted in renal biopsies of SLE patients receiving azathioprine and upon discontinuation of treatment severe exacerbations of the disease have been reported.

Cyclosporin A has not been as widely used in the treatment of autoimmune disorders as azathioprine, methotrexate, and cyclophosphamide, with the exception of type I (insulin-dependent) diabetes and myasthenia gravis. In these conditions, considerable clinical improvement may be seen while cyclosporine is being administered, but relapses occur as soon as it is suspended.

Combinations of glucocorticoids and cytotoxic agents have been used in most diseases that were classically treated with glucocorticoids alone, and although controlled trials are still required to assess overall benefit in many of these diseases, it should be stated that their major advantage may be the possibility of reducing the dose of steroids when such drugs are added to corticosteroid therapy—the previously mentioned “steroid-sparing” effect.

D. Adverse Consequences of Prolonged Immunosuppression

Bone marrow suppression is the most common toxicity with cytotoxic drugs, such as methotrexate, azathioprine, 6-mercaptopurine, and mycophenolate mofetil.

The degree of bone marrow suppression observed with cytotoxic drugs is usually dose-related and can be modulated by dose changes, although in rare cases the bone marrow failure may become irreversible. Usually if a patient's white blood count (WBC) falls below 3000 cells/mm³, any of these drugs should be stopped until the WBC increases to 3000 cells/mm³ and reinstated at a lower dose.

When neutropenia develops, severe infections are likely to develop; these infections are extremely difficult to treat, often being the cause of death. For this reason, neutropenia is considered as the most serious side effect of immunosuppression, and continuous monitoring of white cell count is essential in patients treated with these drugs. The availability of recombinant G-CSF and GM-CSF provides the means to considerably shorten the period of neutropenia (see below).

Infections are another common adverse effect in patients treated with all types of cytotoxic or immunosuppressive drugs. This is a consequence of global immunosuppression, as reflected by the patient's frequent inability to mount a primary immune response after adequate immunization. Two main features characterize the infections of immunosuppressed patients:

1. They usually involve low-grade pathogens or opportunistic microorganisms not usually associated with clinical disease.
2. The extent and distribution of the infection are unusual, differing from those commonly observed in noncompromised hosts.

Because the depression of cellular immunity is the goal pursued when these drugs are used, the patients become more vulnerable to viral infections, such as herpes simplex and varicella, which may disseminate with a fatal outcome. The incidence of herpes zoster (shingles) is increased, but the course of the disease is similar to that seen in otherwise normal individuals. The impairment of cell-mediated immunity is also probably responsible for the frequency and severity of opportunistic infections with mycobacteria, viral (e.g., cytomegalovirus, herpes simplex, varicella-zoster), parasitic (e.g., *Pneumocystis carinii*, toxoplasmosis), and fungal infections (e.g., *Candida* sp. and *Aspergillus* sp.). Those infections are much more likely to disseminate during immunosuppressive treatment. Systemic candidiasis, measles encephalitis, measles retinitis, progressive multifocal leukoencephalopathy, and cerebral toxoplasmosis are just a few examples of atypical infections almost exclusively seen in immunocompromised patients (see Chapters 29 and 30).

An increased incidence of neoplasms is a major concern in patients chronically immunosuppressed. Although the precise role of the immune system in eliminating neoplastic clones in a normal individual is not clear, the incidence of malignancies is clearly elevated in patients receiving immunosuppressive drugs. The most frequently seen malignancies in immunosuppressed patients after solid organ transplantation include basal cell carcinoma, Kaposi's sarcoma, carcinoma of the vulva and perineum, non-Hodgkin's lymphoma, squamous cell carcinoma, and hepatobiliary carcinoma. Also, the location and pattern of spread of those malignancies is unusual. For example, primary central nervous system lymphoma is associated with congenital, acquired, or iatrogenic immunodeficiency states (e.g., immunosuppression after a solid organ transplant). The highest incidence of central nervous system lymphoma occurs in patients with AIDS (1.9–6% of the cases in different series). Azathioprine-based immunosuppressant regimens administered post-solid organ transplantation are associated with the highest incidence of cutaneous malignancies. In contrast, posttransplant high-intensity immunosuppressive regimens, especially those

including antilymphocyte antibody preparations (e.g., OKT3, ATGAM), are associated with non-Hodgkin's lymphoma. Reactivated Epstein-Barr virus (EBV) infections are believed to cause non-Hodgkin's lymphoma in immunocompromised patients because transforming proteins encoded by integrated EBV genomes are expressed in the malignant cells. Interestingly, the incidence of the most common cancers (e.g., breast, lung, prostate, and colon) is not increased in immunosuppressed patients.

Other side effects are secondary to the toxicity of these drugs (particularly those with cytotoxic properties) over rapidly dividing cells and include hair loss or alopecia, loss of gonadal function, bloody diarrhea, as well as constitutional symptoms (e.g., nausea, vomiting, anorexia, malaise, etc.), chromosomal changes, and teratogenic effects.

E. Cytokine Modifiers

A new group of biological response modifiers (BRMs) has emerged from efforts to manipulate the immune response using soluble receptors and receptor antagonists to block undesirable effects of pro-inflammatory cytokines. After limited success in sepsis, soluble tumor necrosis factor receptors (sTNFRs) and interleukin-1 receptor antagonists (IL-1RA) are actively being investigated in rheumatoid arthritis.

1. *TNF Antagonists*

As discussed above, disease-modifying antirheumatic drugs (e.g., methotrexate) do not directly treat the underlying pathophysiology, but rather cause the death of all actively dividing lymphocytes. Although the underlying cause of rheumatoid arthritis is unknown, increasing evidence implicates both interleukin-1 (IL-1) and tumor necrosis factor (TNF) in the inflammatory and destructive manifestations of rheumatoid arthritis. Although increased concentrations of both IL-1 inhibitors and sTNFRs are detected in the serum and synovial fluid of patients with rheumatoid arthritis, concentrations of IL-1 and TNF exceed concentrations of their inhibitors.

sTNFRs exist in two forms, 55 kDa (Type B, sTNFR I) and 75 kDa (Type A, sTNFR II), and act primarily as inhibitors of TNF by preventing TNF from binding to the membrane-bound TNFRs (Fig. 24.4). The same effect can be obtained, at least theoretically, with both monoclonal antibodies against TNF. Therapeutically, both monoclonal antibodies against TNF and recombinant sTNFRs have been utilized in clinical trials. To increase the biological activity and half-life of sTNFR II, a recombinant protein was developed by combining the sTNFR II with the Fc portion of human IgG₁ to form TNFR:Fc (etanercept). In several clinical trials etanercept has been shown to cause significant clinical improvement in patients with rheumatoid arthritis not observed with placebo-treated controls.

Infliximab, an IgG1 murine-human chimeric monoclonal TNF antibody, binds to and neutralizes TNF (Fig. 24.4). Administration of infliximab in conjunction with methotrexate reduces the signs and symptoms of rheumatoid arthritis to a greater extent than methotrexate alone.

High levels of expression of TNF have been observed in the mucosal and lamina propria cells in patients with active Crohn's disease. In patients with moderate to severe Crohn's disease not responding to conventional therapy, infliximab reduces Crohn's disease activity index scores and reduces the number of draining enterocutaneous fistulas. A limitation to infliximab is the fact that after prolonged administration patients develop antibodies against the murine portion of infliximab.

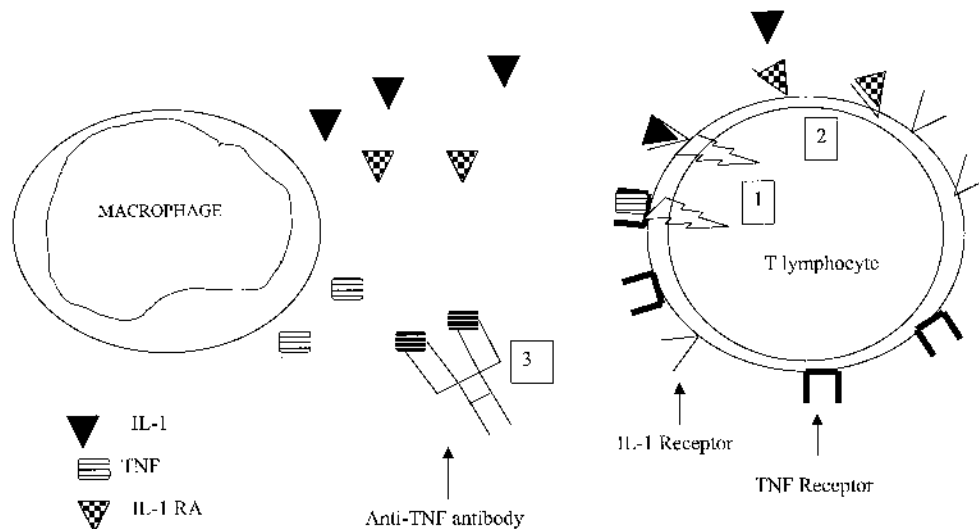

Fig. 24.4 Macrophages produce IL-1 and TNF, which deliver activating signals to T lymphocytes (1,2). Interleukin-1 receptor antagonist (IL-1 RA) binds to the IL-1 receptor to block IL-1-induced activation (3). The anti-TNF antibody (infliximab) or soluble TNF receptor (etanercept) binds TNF and prevents it from reaching its receptor.

2. *IL-1 Antagonists*

A delicate balance between IL-1 and IL-1RA exists in rheumatoid arthritis. An excess of IL-1 leads to disease progression. It is estimated that only 5% of IL-1 receptors need to be bound by IL-1 to stimulate the cell. Therefore, an excess of IL-1RA is required to block IL-1 and modify the disease process.

Recombinant human IL-1 receptor antagonist (IL-1RA) is actively being investigated in rheumatoid arthritis as a modulator of IL-1. When it binds to the IL-1 receptor, IL-1RA does not stimulate the receptor, but blocks IL-1 from stimulating the receptor (Fig. 24.4). Considering the positive results obtained with separate administration of TNF and IL-1 antagonists, one can anticipate trials combining modulators of IL-1 and TNF in the treatment of refractory rheumatoid arthritis.

III. IMMUNOPOTENTIATION

Many compounds and biological substances have been used in attempts to restore normal immune system function in clinical conditions in which it is believed to be functionally altered. All of these types of therapeutic interventions fall under the general designation of immunopotentialiation, which can be defined as any type of therapeutic intervention aimed at restoring the normal function of the immune system.

A. Biological Response Modifiers

These include a variety of soluble compounds that allow the various elements of the immune system to communicate with one another. This communication network allows for

“upregulation” and coordination of immune responses when needed and “downregulation” of immune responses when no longer needed by the host.

1. Structure

All BRMs have a surprising degree of structural similarity to one another; this is felt to be reflective of an early gene reduplication event, which occurred as the immune system of mammals evolved.

2. Function

The BRMs appear to form a very delicate network of communication signals between the four principal mononuclear leukocyte subsets that participate in the immune response. We still do not completely understand how these interactions occur; however, the release of these signals appears to be different from hormones. Hormones tend to act at a site far distant from the original cell that secreted the signal; in contrast, BRMs appear to work in the immediate vicinity of the cell type that secretes them. The timing of the release of BRMs coupled with the intensity of their secretion appears to provide the overall balance of signals required to orchestrate the immune response.

3. Cellular Sources

The most significant sources of BRM compounds are lymphocytes, macrophages, and dendritic cells. T lymphocytes produce a wide range of BRMs, including:

1. Interleukin-2 (IL-2), which induces the proliferation of T lymphocytes, B lymphocytes, and NK cells. IL-2 is also capable of upregulating the tumor-killing capabilities of CD8⁺ T lymphocytes and NK cells.
2. Interleukin-3 (IL-3), a growth factor for stem cells in the bone marrow that stimulates the production of many types of leukocytes from the bone marrow when needed.
3. Interleukin-4 (IL-4), the main determinant of T_H2 differentiation; it also stimulates B lymphocytes to proliferate and induces the synthesis of IgE antibodies.
4. Interleukin-5 (IL-5), which has chemotactic and activating properties for eosinophils.
5. Interleukin-10 (IL-10), which downregulates the synthesis of other interleukins and turns-off both T_H1 and T_H2 activities.
6. Granulocyte-macrophage colony-stimulating factor (GM-CSF), which stimulates the bone marrow to produce both granulocytes and monocytes. It also appears capable of upregulating the spontaneous killing capability of monocytes.
7. γ -Interferon (IFN γ), the main mediator responsible for the activation of monocytes and macrophages, which is also released by activated NK cells.

Natural killer cells also secrete a series of BRMs, particularly α -interferon (IFN- α), an antiviral agent that promotes the activation of NK lymphocytes in vitro. IFN- α is also secreted by monocytes, macrophages, and many other cell types, but its main source has been recently identified as being the lymphoid-derived dendritic cells (DC2). In addition to its antiviral and NK-activating properties, α -interferon appears capable of directly inhibiting the growth of certain types of tumor cells, such as the cells that proliferate in hairy cell leukemia (see Chapter 27), chronic myeloid leukemia, and melanoma.

Mononuclear phagocytes (monocytes and macrophages) share with NK lymphocytes the ability to secrete α -interferon. In addition, they secrete several types of interleukins and cytokines. Some of them (IL-6, IL-8, and TNF) are also produced by T lymphocytes.

1. Interleukin-1 (IL-1), also produced by other antigen-presenting cells, including B lymphocytes, promotes the early phases of the B- and T-lymphocyte-activation processes.
2. Interleukin-6 (IL-6), which promotes B-lymphocyte differentiation and immunoglobulin secretion.
3. Interleukin-8 (IL-8), a chemotactic factor for T lymphocytes and neutrophils.
4. Interleukin-12 (IL-12), responsible for the activation and differentiation of T_H1 lymphocytes.
5. Tumor necrosis factor (TNF) has a variety of effects, particularly causing the death of certain types of tumor cells.
6. Two types of hematopoietic factors, G-CSF and M-CSF. M-CSF promotes the production and activation of monocytes, and G-CSF stimulates the production of granulocytes from stem cells in the bone marrow.

4. Clinical Applications

Of the interleukins, interleukin-2 has been the most widely used. High-dose IL-2 induces a response in 15% of patients with disseminated melanoma and renal cell carcinoma. Despite the low response rate, the excitement regarding high-dose IL-2 centers on the duration of responses. Seven percent of these responses are complete and very durable, with median duration exceeding 40 months. Unfortunately, high-dose IL-2 is associated with severe side effects (e.g. hypotension, fluid retention, renal failure, and mental status changes), which necessitate administration in the hospital. Lower doses of IL-2 that can be administered safely on an outpatient basis are being extensively investigated in experimental immune reconstitution protocols in AIDS patients (see Chapter 30) and to treat melanoma and renal cell carcinoma. Interleukin-12 has also been used in AIDS patients with the goal of enhancing the differentiation of T_H1 cells, although to a more limited extent.

Interferon- γ has been extensively studied as an immunomodulator, particularly in patients with chronic granulomatous disease (see Chapter 13).

Interferon- α induces antiviral, antitumor, and immunomodulatory effects. It activates their target cells by first binding to specific interferon receptors on the cell surface. The binding of interferon- α induces a signaling cascade, the end result of which is to induce the synthesis of several effector proteins (e.g., 2',5'-oligo-A synthetase, Mx protein, and protein kinase). The upregulation of these effector proteins is important in its antiviral response but may also play a role in its antitumor response. The antitumor activity of interferon- α may also involve oncogene modulation (e.g., c-myc, c-fos) and induction of proteins (e.g., indolamine 2,3-dioxygenase) that inhibit macromolecule synthesis essential for tumor cell survival. Interferon- α also has indirect effects by activating macrophages and natural killer cells and upregulating expression of cell surface proteins (e.g., HLA class I, B7, and ICAM-1) on tumor cells.

Although the exact mechanism of action of interferon- α in oncology is not well defined (i.e., direct antiproliferative vs. immunomodulatory effect), this BRM is extensively used in the chronic phase of chronic myeloid leukemia, as adjuvant therapy after surgery in patients with a high risk of recurrence from melanoma, and for the treatment of AIDS-related Kaposi's sarcoma and follicular lymphomas. Interferon- α is also used clinically to

treat chronic hepatitis B and C. Despite the numerous dosage regimens used in clinical practice, the universal side effects associated with interferon- α therapy are fatigue, flu-like symptoms (i.e., fever and chills, headache), and myalgias.

Interferon- β , like interferon- α , exhibits antiviral, antiproliferative, and immunomodulatory activity. Interferon- β is effective in reducing the severity and frequency of exacerbations of multiple sclerosis.

Randomized trials using the hematopoietic growth factors granulocyte colony-stimulating factor (G-CSF, filgrastim) or GM-CSF (sargramostim) postmyelosuppressive chemotherapy demonstrated their ability not only to accelerate neutrophil recovery but also to reduce the frequency and severity of infections, mainly bacterial, and to decrease antibiotic use (Table 24.4). AIDS patients also develop neutropenia, due either to the viral infection itself (by unknown mechanisms) or as side effects of antiretroviral or other antimicrobial drugs. The administration of G-CSF or GM-CSF to these patients may also be

Table 24.4 FDA-Approved Recombinant Hematopoietic Growth Factors

Cytokine	Generic (trade) name	Source	Maturation	Clinical uses
Granulocyte-colony stimulating factor (G-CSF)	Filgrastim (Neupogen)	Monocytes/macrophages, bone marrow stromal cells ^a	Neutrophils	Stimulate neutrophil recovery s/p myelosuppressive chemotherapy; adjunct to antibiotics in severe infections ^c
Granulocyte-macrophage colony stimulating factor (GM-CSF)	Sargramostim (Leukine)	T-lymphocytes, monocytes, bone marrow stromal cells	Neutrophils, monocytes, eosinophils	Stimulate neutrophil recovery s/p myelosuppressive chemotherapy; adjunct to vaccines ^c , adjunct to antibiotics in severe infections ^c
Interleukin-11 (IL-11)	Oprelvekin (Neumega)	Bone marrow stromal cells, liver	Megakaryocytes, B-lymphocytes ^b , neutrophils ^b	Stimulate platelet recovery s/p myelosuppressive chemotherapy
Erythropoietin	Erythropoietin (Procrit, Epogen)	Kidney, liver	RBCs	Stimulate RBC production in patients with anemia of chronic disease (e.g., ESRD ^d , anemia secondary to cancer or its treatment, anemia associated with HIV infection)

^a Bone marrow stromal cells include fibroblasts and endothelial cells.

^b In clinical trials, IL-11 does not significantly increase the recovery of neutrophils after myelosuppressive chemotherapy. Its effect on B lymphocytes in vivo is unknown.

^c Actively under clinical investigation.

^d End-stage renal disease.

beneficial. The ability of G-CSF and GM-CSF to prevent infections is due to two effects: accelerated generation of neutrophils in the bone marrow and enhanced activity of neutrophil function.

There is a strong correlation between the nadir of the neutrophil count and length of neutropenia from the chemotherapy with risk of bacterial infections. Typically, a neutrophil count lower than 500 cells/mm^3 puts a patient at increased risk of infection. However, the length of neutropenia also is critical. Patients with prolonged neutropenia status postchemotherapy (i.e., ≥ 1 week) are much more at risk for an infection than patients with a short period of neutropenia (i.e., < 1 week). In randomized trials, administration of G-CSF or GM-CSF after myelosuppressive chemotherapy has blunted the neutrophil nadir and shortened the period of neutropenia as compared to placebo.

Both G-CSF and GM-CSF improve neutrophil function (phagocytosis, chemotaxis, and superoxide production). Based on this information, both G-CSF and GM-CSF are being investigated as complementary therapy to antibiotics for the treatment of infectious diseases, such as severe foot ulcers in diabetics. In addition, human GM-CSF is the principal growth factor for the proliferation, maturation, and migration of dendritic cells and macrophages. Dendritic cells and macrophages play a critical role in antigen presentation for primary and secondary T-lymphocyte responses. Furthermore, GM-CSF increases the expression of MHC class II, CD80/86 co-stimulatory molecules and cell-adhesion molecules (e.g., ICAM-1) on antigen-presenting cells. Given this critical role of GM-CSF in the proliferation and maturation of dendritic cells and macrophages, the possible use of GM-CSF as a vaccine adjuvant has been investigated. Studies in laboratory animals demonstrated increased antibody production using GM-CSF as an adjuvant. Preliminary results of GM-CSF in conjunction with either the hepatitis B or influenza vaccine in humans are encouraging, but further evaluation is necessary.

Two other hematopoietic growth factors available clinically are interleukin-11 and erythropoietin (Table 24.4). Platelets are fragments of megakaryocytes that, like all blood cells (e.g., RBCs, neutrophils), are derived from the pluripotent hematopoietic stem cell. The commitment of a pluripotent hematopoietic stem cell toward a megakaryocyte is subject to several influences, one of which is hematopoietic growth factors, namely interleukin-11, thrombopoietin, and interleukin-3. In patients receiving chemotherapy that causes clinically significant thrombocytopenia, recombinant interleukin-11 significantly shortened the period of thrombocytopenia (platelet count $< 50,000/\mu\text{L}$) and the number of platelet transfusions compared to placebo. It is important to note that most patients who receive myelosuppressive chemotherapy get not only thrombocytopenia but also neutropenia. Interleukin-11 has minimal effect on neutrophils, and, therefore, it is not uncommon to give patients with severe myelosuppression secondary to chemotherapy both recombinant IL-11 and G-CSF. In addition, patients with anemia associated to myelosuppression (tumor-induced, virus-induced, or iatrogenically induced) may benefit from erythropoietin. Erythropoietin stimulates the production of RBCs from the pluripotent hematopoietic stem cell.

Several BRMs have been used as primary or adjunct agents in the treatment of a variety of malignancies, with variable effects (see Chapter 26). There have also been many attempts to use BRMs to boost cellular immunity in immunodeficient patients, often with negative or conflicting results.

B. Intravenous Immunoglobulins

The administration of gammaglobulin as a way to transfer passive immunity to immunodeficient patients is the oldest type of immunotherapy. Earlier preparations were adminis-

tered intramuscularly, but later, to circumvent the limitations (e.g., painful injections, inconsistent absorption) of intramuscular immunoglobulin (IMiG), intravenous immunoglobulin (IVIg) was introduced into clinical practice in the early 1980s. IVIg consists of concentrated polyclonal immunoglobulins, >90% IgG, prepared from pooled plasma collected from donors. In patients with a primary (e.g., common variable immunodeficiency) or secondary humoral immune deficiency (e.g., chronic lymphocytic leukemia), IVIg provides restoration of circulating IgG concentrations. The clinical benefit of restoring IgG concentrations with IVIg is decreased infections and hospitalization of these patients.

Besides providing passive immunity, IVIg can also modulate the immune response. IVIg modulates the immune response by multiple mechanisms. Common uses of IVIg and the proposed mechanism of actions of IVIg are outlined in Table 24.5.

In many autoimmune disorders, an antibody directed against normal tissues (i.e., autoantibody) binds to tissue and activates complement and antibody-dependent cellular cytotoxicity (ADCC). For example, in idiopathic thrombocytopenia purpura (ITP), an autoantibody against platelets causes immune destruction of the platelets. IVIg can modulate the autoantibody response by (1) saturating Fc receptors on phagocytes (e.g., neutrophils, macrophages) and preventing the engulfment of the autoantibody-coated platelets and by (2) providing the patient with an anti-idiotypic antibody against the autoantibody. The anti-idiotypic antibody binds the autoantibody in the variable region and prevents it from binding to its antigen—in this example, platelets (Fig. 24.5). Also, the anti-idiotypic antibodies

Table 24.5 Common Uses for Intravenous Immunoglobulins

Disease	Proposed mechanism of action	Comments
Primary immunodeficiencies ^a	Replacement of IgG	Standard of care; FDA-approved
Chronic lymphocyte leukemia	Replacement of IgG	FDA-approved; used in individuals with multiple hospitalizations per year due to infections
Pediatric HIV infections	Replacement of IgG	FDA-approved
Status post–allogeneic BMT ^b	Replacement of IgG; immunomodulation	FDA-approved; ↓ CMV ^c infections; ↓ acute graft-versus-host disease
Idiopathic thrombocytopenia purpura	Immunomodulation	FDA-approved; second-line therapy for patients failing corticosteroids
Kawasaki syndrome	Immunomodulation	FDA-approved; used in conjunction with high-dose aspirin to decrease coronary artery abnormalities
Guillain-Barré syndrome	Immunomodulation	An alternative to plasma exchange for severe forms
Autoimmune hemolytic anemia	Immunomodulation	Second-line therapy for patients failing steroids
CIPD ^d	Immunomodulation	An alternative to plasma exchange

^a Common variable immunodeficiency (CVID) and congenital humoral immunodeficiencies (e.g., X-linked agammaglobulinemia, autosomal recessive agammaglobulinemia).

^b Blood marrow transplantation.

^c Cytomegalovirus.

^d Chronic inflammatory demyelinating polyneuropathy.

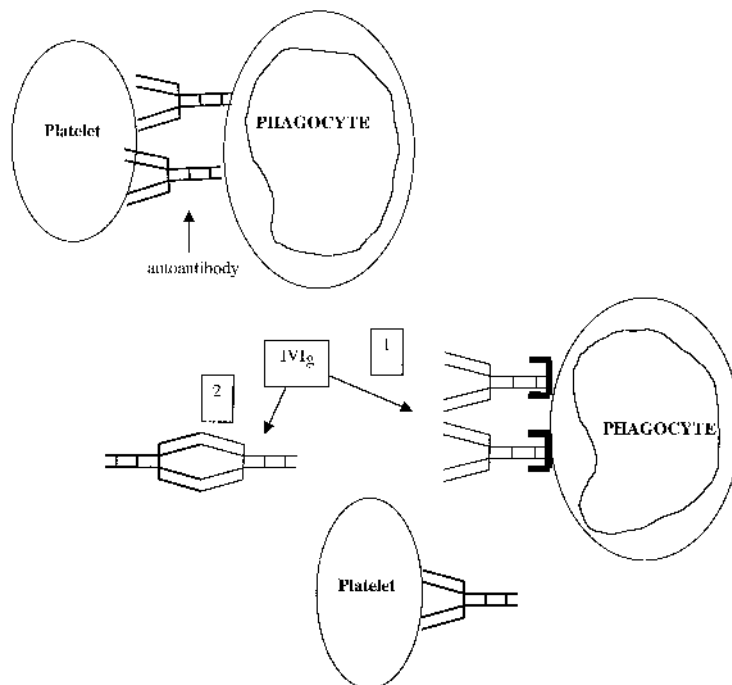

Fig. 24.5 In ITP, an autoantibody directed against platelets opsonizes platelets. Opsonized platelets are destroyed by phagocytes. The therapeutic effect of IVIg can be explained by two possible mechanisms interfering with phagocytic destruction. (1) IVIg can saturate the Fc receptors on phagocytes (e.g., macrophages) so that the macrophage cannot recognize the opsonized platelet. (2) IVIg contains anti-idiotypic antibodies specific for the platelet autoantibody and will block the reaction of the antibody with the platelets.

in IVIg may bind the surface immunoglobulin on B lymphocyte producing the autoantibody. The binding of anti-idiotypic to the surface immunoglobulin in combination with the binding of IVIg to the Fc receptor on B lymphocyte may induce apoptosis of the B lymphocyte and block autoantibody production (Fig. 24.6). Recently, IVIg has been shown to contain antibodies that bind to and block the Fas receptor, thus interrupting the delivery of apoptotic signals to cells with upregulated Fas. IVIg has been shown to inhibit Fas-mediated cell death both *in vitro* and *in vivo*. The clinical applications of this property have yet to be defined.

C. Active Immunization as an Immunomodulating Intervention

Active immunization can be used for prevention of infectious diseases, as discussed in detail in Chapter 12, or to enhance the immunological defenses in patients already infected. The immunotherapeutic use of vaccines has been the object of experimental protocols in two areas:

1. *HIV infection.* The administration of low doses of killed HIV vaccine is currently being tried in HIV-positive individuals, with the goal of stimulating the activity of T_H1 helper lymphocytes, believed to be essential for the differentiation of cytotoxic T lymphocytes with antiviral activity (see Chapter 30).

2. *Cancer.* Anticancer vaccines have been the object of considerable interest and are also the object of ongoing trials (see Chapter 26).

Vaccines to stimulate resistance against antibiotic-resistant bacteria are also under development.

D. Dialyzable Leukocyte Extracts and Transfer Factor

In a series of classical experiments, Lawrence showed that the injection of an extract of lymphocytes from a tuberculin-positive donor to a tuberculin-negative recipient resulted in acquisition of tuberculin reactivity by the latter. Lawrence coined the term transfer factor to designate the unknown agent responsible for transfer of tuberculin sensitivity. Transfer factor has been used episodically to treat a variety of conditions, and the best results appear to have been obtained in the treatment of chronic mucocutaneous candidiasis, a rare form of cell-mediated immunodeficiency (see Chapter 29). Because no properly controlled trials have ever been performed with transfer factor, and because its chemical nature remains unknown, its place in immunotherapy remains marginal.

E. Thymic Hormones

Immunotherapeutic applications of thymic hormones have received increasing attention in recent years. Many peptides with thymic hormone-like activity have been isolated and de-

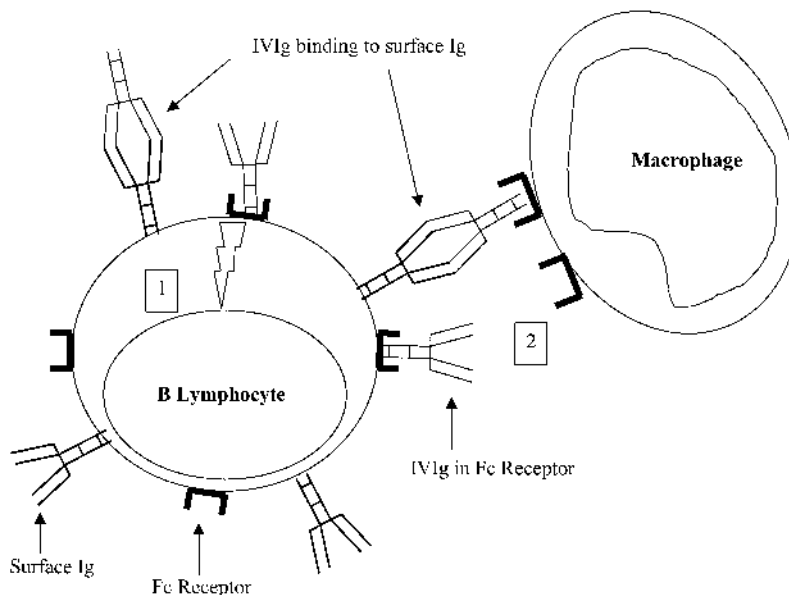

Fig. 24.6 Alternative mechanisms of action for IVIg are based on immunomodulatory effects of IVIg. (1) Anti-idiotypic antibodies contained in IVIg would recognize surface immunoglobulin in autoantibody-producing B cells. In conjunction, IVIg binds to the Fc receptor on B lymphocytes. The simultaneous cross-linking of surface immunoglobulins and Fc receptors results in the delivery of an inhibitory signal to the B lymphocyte. (2) Binding of anti-idiotypic antibodies contained in IVIg to the surface immunoglobulin on autoantibody-producing B lymphocytes may lead to their elimination by phagocytic cells.

scribed, including thymosin, *facteur thymique serique* (FTS, serum thymic factor), and thymopoietin. Although better characterized than transfer factor, the successful therapeutic applications of thymic hormones remain the domain of anecdotal reports. For that reason, thymic hormones have never been recognized as clinically useful.

F. Bacterial and Chemical Immunomodulators

A variety of killed bacteria, several substances of bacterial origin, and chemical compounds have been used with the goal of activating the immune system in a variety of clinical conditions in which such activation should be beneficial.

1. Bacterial Immunomodulators

Bacille Calmette-Guérin (BCG) and *Corynebacterium parvum* have been extensively used for their adjuvant therapy in therapeutic protocols aimed at stimulating antitumoral immunological mechanisms (see Chapter 26). At the cellular level, these bacteria appear mainly to activate macrophages.

2. Chemical Immunomodulators

Levamisole is an antihelminthic drug used in veterinary medicine that has been found to have immunostimulant properties. In some animal diseases it causes an apparent increase in host resistance to tumor cells. It acts on the cellular arm of the immune system and can restore impaired cell-mediated immune responses to normal levels but fails to hyperstimulate the normal functioning immune system. Thus, it shows true immunomodulatory activity.

In humans, levamisole has been reported to restore delayed hypersensitivity reactions in anergic cancer patients and to be of some benefit in the treatment of aphthous stomatitis, rheumatoid arthritis, systemic lupus erythematosus, viral diseases, and chronic staphylococcal infections. In patients with resected colorectal carcinomas, the administration of levamisole in conjunction with 5-fluorouracil decreased the frequency of relapses.

Isoprinosine (Inosine Praboronex, ISO) is a synthetic immunomodulatory drug recently approved for clinical use in the United States. It appears to be effective in a wide variety of viral diseases. This is probably due to the fact that this compound has both antiviral and immunostimulating properties. As far as its effects on the immune system, isoprinosine potentiates cell-mediated immune responsiveness *in vivo*, and a major factor in its effectiveness against viral infections appears to be its ability to prevent the depression of cell-mediated immunity that has been shown to occur during viral infection and to persist for four to six weeks thereafter.

The clinical efficacy of ISO has been well documented in double-blind trials. Its administration results in striking decreases in both the duration of infection and severity of symptoms in a whole host of viral diseases, including viral influenza, rhinovirus infections, herpes simplex infections, herpes zoster, viral hepatitis, rubella, and viral otitis. Of particular interest are the results of ISO therapy in subacute sclerosing panencephalitis (SSPE), a progressive disease due to a chronic measles virus infection, which results in complete debilitation and eventual death of the patient. ISO has been reported to halt the progression of SSPE in 80% of the patients when given in stages I and II of the disease, provided it is administered for at least 6 months. Indeed, ISO is the only agent to date with documented beneficial effects in SSPE patients.

SELF-EVALUATION

Questions

Choose the one *best* answer.

- 24.1 The immunosuppressive effect of cyclosporin A is best explained by its:
- A. Ability to block calcineurin activation
 - B. Ability to induce lymphocyte apoptosis
 - C. Cytotoxic effect on CD8⁺ cells
 - D. Inhibition of signal transduction from the IL-2 receptor
 - E. Suppression of bone marrow lymphocytopoiesis
- 24.2 Which of the following side effects of cytotoxic drugs has the greatest clinical impact?
- A. Anorexia
 - B. Alopecia
 - C. Fatigue
 - D. Nausea and vomiting
 - E. Neutropenia
- 24.3 The lymphocytopenia seen a few hours after administration of a large dose of prednisone to a patient with lymphocytic leukemia is due to:
- A. Activation of cytotoxic cells
 - B. Bone marrow depression
 - C. Massive lymphocyte apoptosis
 - D. Redistribution of peripheral blood lymphocytes
 - E. Stimulation of NK-cell activity
- 24.4 Which one of the following types of malignancies is characteristic of chronically immunosuppressed patients?
- A. Breast cancer
 - B. Colon carcinoma
 - C. Disseminated melanoma
 - D. Lymphocytic leukemia
 - E. Lymphoproliferative syndromes
- 24.5 The clinical effects of isoprinosine in patients with viral infections are explained by the following effect(s):
- A. Inhibition of viral replication
 - B. Potentiation of cell-mediated immunity
 - C. Potentiation of humoral immunity
 - D. Potentiation of humoral immunity and inhibition of viral replication
 - E. Potentiation of cellular immunity and inhibition of viral replication
- 24.6 Which one of the listed infectious agents is *least* likely to be unusually frequent as a cause of opportunistic infections in patients with depression of cell-mediated immunity caused by chronic immunosuppressive therapy?
- A. *Pneumocystis carinii*
 - B. *Aspergillus fumigatus*
 - C. *Staphylococcus aureus*
 - D. *Mycobacterium tuberculosis*
 - E. Herpes zoster virus
- 24.7 Which of the following immunomodulatory drugs downregulates the expression of cell adhesion molecules on endothelial surfaces proximal to an inflammatory site?

- A. Aspirin
 - B. Cyclophosphamide
 - C. Ibuprofen
 - D. Indomethacin
 - E. Prednisolone
- 24.8 Which of the following therapies is indicated in a child with humoral immunodeficiency?
- A. Dialyzable leukocyte extract
 - B. Thymosin
 - C. Interleukin-2
 - D. Intravenous gammaglobulin
 - E. Interferon- γ
- 24.9 A patient receiving chemotherapy for treatment of non-Hodgkin's lymphoma develops fever that does not respond to antibiotics and positive blood cultures for *Candida albicans*. His total leukocyte count is $950/\mu\text{L}$. Which one of the following biological response modifiers is most likely to be useful in this patient?
- A. GM-CSF
 - B. Interferon- γ
 - C. Interleukin-3
 - D. Interleukin-8
 - E. Transfer factor
- 24.10 The pursuit of cytotoxic regimens with a steroid-sparing effect is motivated by the:
- A. Need to increase the doses of steroids for more complete immunosuppression
 - B. Need to avoid side effects associated to high dosages of steroids
 - C. Synergism between steroids and cytotoxic drugs
 - D. Protective effect that steroids have relative to the side effects of cytotoxic drugs
 - E. Protective effect that cytotoxic drugs have relative to the side effects of steroids

Answers

- 24.1 (A) Cyclosporin A binds to cyclophilin and the complex prevents the activation of calcineurin. Because of the inactivation of calcineurin, NF κ B remains phosphorylated, does not translocate to the nucleus, and the activation pathway leading to IL-2 synthesis is interrupted.
- 24.2 (E) All the listed side effects can be seen during administration of cytotoxic drugs, but neutropenia is the most serious because the infections secondary to neutropenia are very difficult to treat.
- 24.3 (C) A large dose of steroids leads to a pronounced decrease in the lymphocyte counts of patient with T-lymphocytic leukemia secondary to the induction of apoptosis in the proliferating cells.
- 24.4 (E) Two types of tumors predominate above all in immunosuppressed patients: epithelial carcinomas and lymphoproliferative syndromes, particularly B-cell lymphomas. The lymphomas have often atypical locations, such as intracerebral.

- 24.5 (E) Isoprinosine combines two potentially beneficial effects in viral infections: it inhibits viral replication, while at the same time it seems to prevent the depression of cell-mediated immunity that is often associated with viral infections.
- 24.6 (C) The depression of cell-mediated immunity is associated mainly with viral and opportunistic infections, as well as with increased severity of infections by intracellular parasites such as *M. tuberculosis*. Pyogenic infections, such as those caused by *S. aureus*, will be a serious problem in the neutropenic patient, but not in patients with depressed cell-mediated immunity.
- 24.7 (E) Of the listed drugs, only four have anti-inflammatory properties (cyclophosphamide is strictly immunosuppressive), and of the four, only prednisolone, a glucocorticoid, is able to downregulate the expression of cell-adhesion molecules.
- 24.8 (D) The preferred immunotherapy in a child with humoral immunodeficiency is intravenous injection of human gammaglobulin, which will passively transfer antibodies to most common pathogens to the deficient child.
- 24.9 (A) GM-CSF will stimulate production of all granulocytes and monocytes. It has been used with some success in patients with neutropenia or with agranulocytosis (lack of all types of granulocytes).
- 24.10 (B) Although steroids can effectively induce a suppression of the immune response, this requires large doses for prolonged periods of time, and the side effects can be life threatening. Thus, the association of steroids with other immunosuppressants allows the use of lower doses of the combined drugs, reducing the side effects of all. Steroid-sparing effect is a term that specifically refers to the decrease of steroid doses due to their association to other immunosuppressive drugs.

BIBLIOGRAPHY

- Armitage, J. O. Emerging applications of recombinant human granulocyte-macrophage colony stimulating factor. *Blood* 92:4491–4508, 1998.
- Auphan, N., DiDonato, J. A., Rosette, C., et al. Immunosuppression by glucocorticoids: Inhibition of NF- κ B activity through induction of I κ B synthesis. *Science* 270:286, 1995.
- Bames, P. J., and Adcock, I. Anti-inflammatory actions of steroids: Molecular mechanisms. *TIPS* 14:436, 1993.
- Bierer, B. Mechanisms of action of immunosuppressive agents: Cyclosporin A, FK506, and rapamycin. *Proc. Ass. Am. Phys.* 107:28, 1995.
- Braun, W., Kallen, J., Mikol, V., et al. Three dimensional structure and actions of immunosuppressants and their immunophilins. *FASEB J.* 9:63, 1995.
- Brooks, P. M., and Day, D. O. Nonsteroidal antiinflammatory drugs—differences and similarities. *N. Engl. J. Med.* 324:1716, 1991.
- Campion, G. V., Lebsack, M. E., Lookabaugh, J., et al. Dose-range and dose-frequency study of recombinant human interleukin-1 receptor antagonist in patients with rheumatoid arthritis. *Arthritis Rheum* 39:1092–1101, 1996.
- Fox, R. I. Mechanism of action of hydroxychloroquine as an anti-rheumatic drug. *Semin. Arthritis Rheum.* 23(suppl 2):82–92, 1993.

- Gough, A., Clapperton, M., Rolando, N., Poster, A. V. M., Philpott-Howard, J., and Edmonds, M. E. E. Randomised placebo-controlled trial of granulocyte-colony stimulating factor in diabetic foot infection. *Lancet* 350:855–859, 1997.
- Hall, P. D. Immunomodulation with intravenous immunoglobulin. *Pharmacotherapy* 13:564–573, 1993.
- Hassner, A., and Adelman, D. C. Biologic response modifiers in primary immunodeficiency disorders. *Ann. Intern. Med.* 115:294, 1991.
- Kwak, B., Mulhaupt, F., Myit, S., Mach, F. Statins as a newly recognized type of immunomodulator. *Nature Med.* 12:1399–402, 2000.
- Montague, J. W., and Cidlowski, J. A. Glucocorticoid-induced death of immune cells: Mechanism of action. *Curr. Top. Microbiol. Immunol.* 200:51, 1995.
- Moreland, L. W., Schiff, M. H., Baumgartner, S. W., et al. Etanercept therapy in rheumatoid arthritis, a randomized, controlled trial. *Ann. Intern. Med.* 130:478–486, 1999.

25

Transplantation Immunology

Gabriel Virella, Richard Knight, and Jonathan Bromberg

I. INTRODUCTION

The replacement of defective organs with transplants was one of the impossible dreams of medicine for many centuries. Its realization required a multitude of important steps: surgical asepsis, development of surgical techniques of vascular anastomosis, understanding of the cellular basis of the rejection phenomena, and introduction of drugs and antisera effective in the control of rejection.

By the early 1970s tissue and organ transplantation emerged as a major area of interest for surgeons and physicians. Kidney and bone marrow transplants have become routine in most industrialized countries and lead in frequency, followed by liver, heart, pancreas, lung, and small bowel transplants, in order of decreasing frequency. Transplantation of trachea and extremities are still in experimental development. Transplant of other tissues and organs will certainly follow.

The success of an organ transplant is a function of several variables. However, the major determinant of acceptance or nonacceptance (rejection) of a technically perfect graft is the magnitude of the immunologically mediated response against the graft. The likelihood of acceptance or rejection is closely related to the extent of genetic differences between the donor and recipient of the graft. While transplantation of organs between animals of the same inbred strain or between homozygous (syngeneic) twins is successful and does not elicit an immune rejection response, transplants between distantly related individuals (allogenic) or across species barriers (xenogeneic) are always rapidly rejected. Thus, in humans, genetic diversity between individuals is currently the main obstacle to successful transplantation.

However, there has been significant progress in the development of new immunosuppressive drugs and administration regimens that has had a very significant impact on transplantation outcome. For example, the half-life of kidneys transplanted from a living donor increased from 12.7 years in 1988 to 35.9 years in 1996, and the half-life of cadaveric kidneys increased from 11.0 to 19.5 years during the same period. This was not a consequence of better donor-recipient matching, but rather a reflection of better medical management.

II. DONOR-RECIPIENT MATCHING

Prevention of rejection is more desirable than trying to treat established rejection and is achieved by careful matching of donor and recipient and by manipulation of the recipient's immune response. Avoidance of antigenic differences between the donor and recipient is a crucial factor for the success of a transplant. Although many different antigenic systems show allotypic variation, in transplantation practice only the ABO blood groups and the HLA system are routinely typed.

ABO incompatibility is generally considered an insurmountable obstacle to transplantation since it leads to an accelerated rejection response, called hyperacute rejection (see below), probably because A and B antigens are expressed on vascular endothelium. However, some groups have reported successful grafting of HLA-compatible but ABO-incompatible organs after removing anti-A and/or anti-B isohemagglutinins by plasmapheresis or by extracorporeal immunoadsorption. In extremely urgent cases of liver transplantation, ABO matching is sometimes ignored, and reasonable graft function and survival can be seen.

HLA matching is done routinely with the goal of matching donor and recipient as well as possible. However, the practical significance of HLA matching varies depending on the organ to be transplanted. In kidney transplantation HLA matching is considered important, since there is a positive correlation between the number of HLA antigens common to the donor and recipient and the survival of the transplanted kidney. When grafting kidneys from living relatives, HLA-identical sibling grafts have the best outcome, followed by haploidentical grafts, which in turn do better than two haplotype-incompatible grafts (Fig. 25.1). Cadaveric transplants matched for HLA-A, B, and DR achieve survivals similar to those obtained with transplants between two haplotype-matched living related individuals. Data demonstrating that kidney transplants matched only for HLA-B and HLA-DR have an excellent outcome (83% graft survival at 12 months) support the significance of MHC-II typing. MHC class II matching appears also to be important for survival of pancreatic grafts.

It is also important to check for cytotoxic antibodies in the recipient's serum directed against the donor's lymphocytes, as this could be a sign that the recipient is already immune to a potential donor. This is achieved by means of a test called a cross-match. The recipient's serum is tested against lymphocytes from the potential donor(s) and against a cell panel of known phenotypes. This test is useful to prevent rapid rejection of the grafted tissue or organ, as discussed later in this chapter.

In bone marrow transplantation HLA typing is also very important, but this type of transplant presents a special problem in that it is necessary to avoid both the rejection of the grafted tissue by the host and the damage of host tissue by the transplanted lymphocytes, a phenomenon called graft-versus-host disease (see later in this chapter). A living relative of the recipient is therefore usually the preferred donor, and by order of preference an identical twin, an HLA-identical sibling (with six identical specificities for HLA-A, B, and DR),

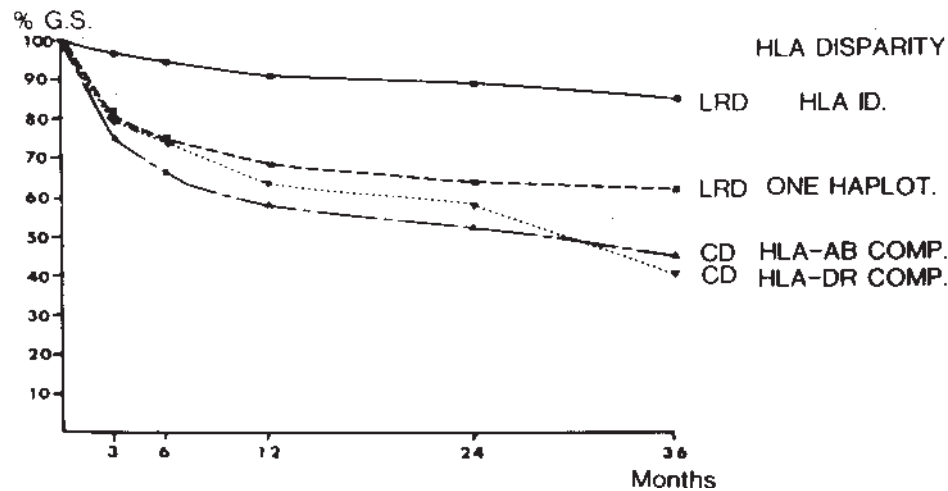

Fig. 25.1 Cumulative graft survival of living related donor (LRD) and cadaveric donor (CD) transplants. (Reproduced with permission from Flatmark and Thorsby, *Transplant. Proc.* 14:61, 1982.)

or an haplotype-identical relative (with three identical specificities for HLA-A, B, and DR) is selected. Mixed lymphocyte cultures can be also used to try to avoid the graft-versus-host reaction, which could emerge even in HLA-identical siblings due to incompatibilities in nontested minor antigenic systems. Cultures are set up by mixing the recipient's lymphocytes with lymphocytes from potential donors. A well-matched donor-recipient pair should react minimally to one another in these cultures.

In the case of liver transplantation, HLA matching is *not* important for graft acceptance and survival. This unexpected finding may be due to the remarkable regenerative capacity of the liver. HLA matching is also not generally performed in the case of heart, lung, and small bowel transplantation, because of the scarcity of available donor organs.

III. GRAFT REJECTION

Graft rejection is the consequence of an immune response mounted by the recipient against the graft as a consequence of the incompatibility between tissue antigens of the donor and recipient. Cells that express class II MHC antigens (such as passenger leukocytes in the case of solid organ transplants) play a major role in sensitizing the immune system of the recipient. The sensitization of alloreactive helper T lymphocytes from the recipient is followed by their clonal expansion, which in turn is the cause of multiple immunological and inflammatory phenomena, some mediated by activated T lymphocytes and others mediated by antibodies, which eventually result in graft rejection.

Rejection episodes are traditionally classified as hyperacute, acute, and chronic, based primarily on the time elapsed between transplantation and the rejection episode.

A. Hyperacute (Early) Rejection

This occurs usually within the first few hours posttransplantation and is mediated by preformed antibodies against ABO or MHC antigens of the graft. It is also possible that antibodies directed against other alloantigens such as vascular endothelial antigens may also

play a role in this type of rejection. Once the antibodies bind to the transplanted tissues, rejection can be caused either by activation of the complement system, which results in the chemotactic attraction of granulocytes and the triggering of inflammatory circuits, and/or by antibody-dependent cellular cytotoxicity (ADCC).

A major pathological feature of hyperacute rejection is the formation of massive intravascular platelet aggregates leading to thrombosis, ischemia, and necrosis. The formation of platelet thrombi probably results from several factors, including release of platelet-activating factor (PAF) from immunologically damaged endothelial cells and/or from activated neutrophils.

Hyperacute rejection episodes are untreatable and result in graft loss. With proper cross-matching techniques, this type of rejection should be almost 100% avoidable. However, it must be noted here that the major limitation to xenogeneic transplantation (e.g., pig to human) is hyperacute rejection by antibodies to cellular antigens that all humans make, even prior to any known exposure to xenogeneic tissues (natural antibodies).

B. Acute Rejection

Acute rejection occurs mostly in the first few days or weeks after transplantation. Up to 70% of graft recipients experience one or more acute rejection episodes. When taking place in the first few days after grafting, it may correspond to a secondary (second set) immune response, implying that the patient had been previously sensitized to the HLA antigens present in the organ donor (as a consequence of a previous transplant, pregnancy, or blood transfusions). When occurring past the first week after grafting, it usually corresponds to a primary (first set) response.

Acute rejection is predominantly mediated by T lymphocytes, and controversy has arisen concerning the relative importance of CD8⁺ cytotoxic lymphocytes vs. helper CD4⁺ lymphocytes. Most likely, both subsets play important roles.

In rejected organs, the cellular infiltrates contain mostly monocytes and T lymphocytes of both helper and cytotoxic phenotypes and lesser frequencies of B lymphocytes, NK cells, neutrophils, and eosinophils. All these cells have the potential to play significant roles in the rejection process. CD4⁺ helper T lymphocytes are believed to play the key role, because of their release of cytokines involved in cell-mediated inflammatory reactions. Interleukin-2 and IL-4 promote the expansion of CD8⁺ lymphocytes and B cells, interferon- γ enhances the expression of MHC class II antigens in the graft, and chemotactic interleukins, such as IL-8 (also released by activated monocytes and macrophages), attract lymphocytes and granulocytes to the transplanted organ.

In most cases acute rejection, if detected early, can be reversed by increasing the dose of immunosuppressive agents or by briefly administering additional immunosuppressants. However, this simple approach is complicated by the uncertainties that often surround the diagnosis of rejection.

The initial diagnosis of acute rejection is usually based on clinical suspicion. Abnormal laboratory studies or functional deterioration of the grafted organ are the main bases for considering the diagnosis of acute rejection. Confirmation usually requires a biopsy of the grafted organ. There are established histological criteria for the identification of an acute rejection reaction in transplanted organs. A hallmark finding in graft undergoing acute rejection is a heavy mononuclear cell infiltration of the affected organ or tissue. The predominance of mononuclear cells indicates that acute rejection falls into the general category of delayed hypersensitivity reactions.

Since biopsy is an invasive procedure with potential complications and pitfalls, several approaches to the noninvasive diagnosis of rejection have been attempted. Particular attention has been directed to the measurement of cytokines and other substances released by activated T lymphocytes, such as IL-2, in serum and in urine (in the case of renal transplants). However, these tests have been found to be lacking in sensitivity and specificity.

C. Delayed or Chronic Rejection

This type of rejection is characterized by an insidiously progressive loss of function of the grafted organ. Recent data show a positive correlation between the number of HLA incompatibilities and the progression of chronic rejection, which is difficult to control by any type of therapy.

It is not certain if chronic rejection is a unique process or if it represents the final common pathway of multiple injuries occurring over a protracted period of time, including acute rejection episodes, infection, and atherosclerosis. Actually, the functional deterioration associated with chronic rejection seems to be due to both immune and nonimmune processes.

The immune component of chronic rejection is believed to cause vascular endothelial injury. A variety of cells, such as granulocytes, monocytes, and platelets have an increased tendency to adhere to injured vascular endothelium. The expression of PAF on the membrane of endothelial cells may be one of the major factors determining the adherence of neutrophils and platelets, both types of cells having PAF receptors on their membranes. On the other hand, a variety of interleukins and soluble factors are released by activated leukocytes at the level of the damaged vessel walls, including IL-1 and platelet-derived growth factor (PDGF). A layer of platelets and fibrin covers the damaged endothelium, while proliferating fibroblasts and smooth muscle cells can be found in the subendothelial space. The end result is a proliferative lesion in the vessels as a consequence of the inflammatory nature of the process, which progresses towards fibrosis and occlusion.

Case 25.1

A 45-year-old white male with glomerulonephritis underwent a cadaveric renal transplant. The renal allograft was functional within 24 hours of transplantation, and over the next 3 postoperative days the patient's creatinine dropped from 10.2 to 1.7 mg/dL. The patient recuperated from the operation well and was discharged from the hospital on the 5th postoperative day. He returned to the hospital 4 days later complaining of fever, malaise, decreased urine output, weight gain, and increased blood pressure. Laboratory investigation revealed a creatinine that had risen to 3.2 mg/dL. Percutaneous renal biopsy was obtained and pathological examination of the tissue revealed a prominent interstitial lymphocytic infiltrate with tubular necrosis. The patient was treated with high-dose intravenous glucocorticoids for 3 days. During this time the fever abated, urine output rose, and creatinine decreased to 2.2. The patient was discharged in good clinical condition with stable and acceptable renal function. He continued to do well with maintenance doses of prednisone, mycophenolic acid, and cyclosporine until approximately 8 weeks after transplant, when he presented with fevers, malaise, diffuse abdominal pain, bloody stools, and shortness of breath. Chest x-ray revealed a fine reticular interstitial infiltrate of the lungs, and blood gas analysis showed hypoxia while breathing room air. Physical examination revealed rhonchi and diminished transmission of breath sounds on both sides of the thorax, more accentuated on the bases, minimal hepatosplenomegaly, and a diffusely tender abdomen. Occult blood was detected in the stools.

*What was the most likely cause of functional deterioration soon after the transplant?
Were the symptoms 8 weeks after the transplant related to the same process that affected the patient 6 weeks earlier?
Should any tests be ordered to clarify the patient's later complaints?
What therapeutic options would you consider?*

IV. IMMUNOSUPPRESSION

The ideal transplantation should take place between genetically identical individuals. This is only possible in the rare event of transplantation between identical twins. Thus, the success of clinical transplantation depends heavily on the use of nonspecific immunosuppressive agents that, by decreasing the magnitude of immunological rejection responses, prolong graft survival. Current immunosuppression in transplanted patients is achieved by the use of cytotoxic/immunosuppressant drugs and biological response modifiers, such as antilymphocyte antibodies.

A. Chemical Immunosuppression

Several drugs are currently used to induce immunosuppression including glucocorticoids, antimetabolites, cyclosporin A and tacrolimus (FK507).

1. Glucocorticoids

These are used to treat and prevent rejection. They have multiple effects on the immune system, including lymphocyte apoptosis, inhibition of antigen-driven T-lymphocyte proliferation, inhibition of IL-1 and IL-2 release, and inhibition of chemotaxis. Because of the side effects associated with the use of glucocorticoids in relatively large doses for long periods of time (as required in transplantation), they are usually administered together with other immunosuppressant drugs, allowing the reduction of steroid doses below levels causing major side effects.

2. Antimetabolites

These are mostly used in the prevention of rejection episodes. All these agents inhibit DNA replication, lymphocyte proliferation, and the expansion of antigen-reactive clones of lymphocytes.

Azathioprine (Imuran) undergoes metabolic conversion into 6-mercaptopurine, which inhibits purine nucleotide synthesis and prevents lymphocyte proliferation (both T and B). Mycophenolate mofetil (CellCept) is converted to mycophenolic acid, which is an inhibitor of inosine monophosphate dehydrogenase, a participant in guanosine nucleotide synthesis. This agent has virtually replaced azathioprine as a maintenance immunosuppressant. Cyclophosphamide (Cytosan) is an alkylating agent that modifies DNA and prevents lymphocyte replication. This drug is rarely used in solid organ transplantation.

3. Calcineurin Inhibitors

Cyclosporin A (Sandimmune, Neoral) is used in the prevention and treatment of rejection. Its introduction in 1983 had a marked impact on the survival of transplanted organs, which

increased by at least 20–30% in the case of kidney and heart grafts. The revival of interest in heart transplants in the last two decades was a direct consequence of the availability of cyclosporin A (CsA), and the success of liver transplants is also directly related to the use of this drug. CsA is particularly helpful in the prevention of rejection, usually administered in association with glucocorticoids, because of its steroid-sparing effect.

The effects of CsA are mainly related to the inhibition of activity of transcriptional activators controlling the expression of IL-2 and other lymphokine genes in helper T cells, thus curtailing the onset of both cellular and humoral immune responses.

CsA itself has marked toxicity. It is nephrotoxic (problematic in patients receiving kidney transplants, in which it will be necessary to differentiate between acute rejection and CsA toxicity) and causes hypertension. Monitoring of circulating cyclosporine levels is essential to minimize the toxic effects of this drug.

Tacrolimus (Prograf, FK506) has a mechanism of action similar to CsA, but it is able to reverse rejection episodes in patients unresponsive to other immunosuppressive agents. Tacrolimus is used in a fashion similar to cyclosporine in combination with glucocorticoids and antimetabolites. It also has toxic effects including nephrotoxicity and neurotoxicity.

4. *Rapamycin (Sirolimus, Rapamune)*

This is a unique compound that is structurally similar to Prograf, but its mechanism of action seems to be related to cell cycle inhibition. It is currently occasionally used instead of Cellcept or Imuran.

B. Biological Response Modifiers

This group includes a variety of biological compounds that have been found to be useful in the prevention and treatment of graft rejection.

1. *Antithymocyte and antilymphocyte Globulins*

These were among the earliest successful therapeutic agents used in the management of graft rejection. These reagents are gammaglobulin fractions separated from the sera of animals (rabbits, goats, or horses) injected with human thymic lymphocytes or human peripheral blood lymphocytes. They are very effective in the prevention and reversal of rejection episodes, and their mechanism of action is related to the destruction or inhibition of recipient lymphocytes. Their main drawbacks have been related to difficulty in obtaining standardized preparations, reactivity with other cell types, and frequent sensitization of the patients, which often leads to serum sickness when the globulins are administered repeatedly.

2. *Anti-T-Cell Monoclonal Antibodies*

These antibodies, derived from mouse B cells and directed against human T cells, particularly those reacting with the CD3 marker (OKT3), have been extensively used in the management of transplanted patients. Their mechanism of action is not entirely clear. OKT3 has been reported to cause depletion of CD3⁺ T lymphocytes, and it is likely that the depletion is due to complement-mediated lysis, opsonization, and ADCC. OKT3 also causes down-modulation of CD3 on the cell surface of otherwise viable T cells and may induce T-cell anergy.

These antibodies are predominantly used for the treatment of acute rejection. In addition, some groups use the monoclonal antibody as “induction” treatment at the time of transplantation to prevent rejection. As with antilymphocyte and antithymocyte globulins, the possibility of using monoclonal antibodies to treat repeated episodes of rejection is limited by the sensitization of the patients receiving the antibody. It must be noted that in spite of concomitant immunosuppression, up to 30% of patients become sensitized to various antibody preparations. However, changing to a different monoclonal antibody can meet with success in hypersensitive patients.

Besides serum sickness, monoclonal and polyclonal antibodies can cause what is known as the *cytokine syndrome*, which presents with fever, chills, headaches, vomiting, diarrhea, muscle cramps, and vascular leakage and vascular transudation. Experiments and data suggest that the syndrome is caused by massive interleukin release from T cells activated as a consequence of the binding of these antibodies to the lymphocyte membrane.

Both monoclonal and polyclonal antilymphocyte antibody preparations are strongly immunosuppressive, so the risk of developing life-threatening infections or non-Hodgkin’s lymphomas is markedly higher in patients treated with them (see below). As a result, treatment with these agents usually does not exceed 14 days, and repeated courses of antibody treatment are usually contraindicated.

3. Other Monoclonal Antibodies

Anti-IL-2R monoclonal antibodies (Daclizumab, Simulect, Zenapax) are also approved for use in transplantation for the prevention of rejection. A study published in early 2000 reported that induction therapy with one of these antibodies prior to heart transplantation reduced the frequency and severity of rejection.

AntiCD154 monoclonal antibodies have been used successfully to prevent rejection of kidney allografts in nonhuman primates. The animals received humanized antibodies for up to 5 months. No additional therapy was given, and the grafts were not rejected, even after discontinuation of the monoclonal antibody. These experimental studies are certainly encouraging and may open the door to human protocols.

The problem of sensitization can be minimized when genetically engineered monoclonal antibodies containing the binding site of a murine monoclonal antibody and the constant regions of a human immunoglobulin are used. These “humanized” or chimeric monoclonals can be administered for more prolonged periods of time without sensitization occurring. However, they are considerably more expensive.

C. Total Lymphoid Irradiation

Irradiation of those areas of the body where the lymphoid tissues are concentrated is almost exclusively used to prepare leukemic patients for bone marrow transplantation. In this circumstance, irradiation combines two potential benefits: the elimination of malignant cells and the ablation of the immune system. Another immunosuppressive effect of irradiation is due to the greater radiosensitivity of helper T cells, resulting in the survival and predominance of suppressor/cytotoxic T cells among the residual lymphocyte population after irradiation.

Transplantation preconditioning protocols with total lymphoid irradiation have met with some impressive success: the patients are reported to require very low doses of maintenance immunosuppressive drug, and in a few cases it has been possible to withdraw the immunosuppressive drugs completely.

D. The Transfusion Effect: Stem Cells and Microchimerism

Although blood transfusions were generally avoided in potential transplant recipients due to the fear of sensitization to HLA, blood group, and other antigens, several groups reported in the early 1980s that kidney graft survival was longer in patients who had received blood prior to transplantation (Fig. 25.2). This led to attempts to precondition transplant recipients with multiple pretransplant transfusions. Several interesting observations were recorded during these attempts.

1. The effect is more pronounced if MHC-II-expressing cells are included in the transfusion. Thus, the administration of whole blood, packed cells, or buffy coat is more efficient than the administration of washed red cells in improving graft survival.
2. The protection can be induced with a few donor-specific transfusions but usually requires multiple random transfusions. This probably reflects a MHC-specific effect that is obviously easier to achieve when the transfused cells have the same MHC as the graft.
3. The transfusion effect is delayed—usually seen about 2 weeks after a donor-specific transfusion. Following transfusion there is a depression of cellular immunity, which, according to some studies, seems to become more accentuated and longlasting with repeated transfusions.

The concept that emerged from these studies was that the transfusion protocols induce a state of at least partial tolerance to the graft. Among the several mechanisms proposed to explain the transfusion effect, three deserve special mention:

1. According to the some authors, pretransplant transfusion would sensitize the patient against MHC antigens of the transplanted tissue. In some patients these are

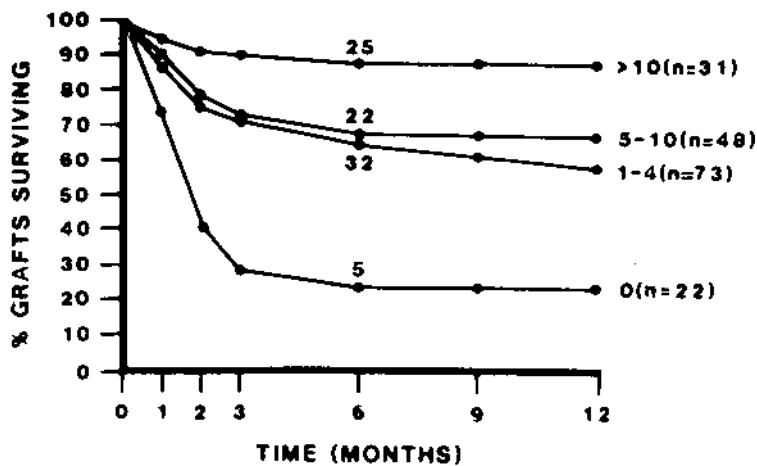

Fig. 25.2 Actuarial kidney graft survival rates according to the number of transfusions received before transplantation. Numbers of transfusions are indicated at the end of each curve, and numbers of patients are given in parentheses. Numbers of graft survivals for each group at 6 months are as indicated. Number of patients at risk at 6 months are indicated. p (weighted regression analysis) was <0.0001 at 3, 6, and 12 months, indicating that the improvement in graft outcome was dependent upon an increased number of pretransplant transfusions. (Reproduced with permission from Opelz, Graver and Terasaki. *Lancet* i:1223, 1981.)

cytotoxic antibodies that preclude transplantation. In others, the MHC antibodies could function as enhancing antibodies by two mechanisms: (1) blocking the immunogenic sites on MHC molecules, thus inhibiting the initiation of the rejection reaction, and (2) binding to complexes of cells expressing the nonself alloantigen and host cells recognizing alloantigen and promoting the phagocytosis and destruction of the cellular complex via Fc-mediated opsonization

2. Other groups suggest that the administration of blood transfusions may also transfer donor-derived hematopoietic stem cell precursors. This could lead to the establishment of a low level of donor-derived cells within the recipient bone marrow and peripheral blood and result in a state of microchimerism. The microchimeric state could then induce tolerance to the donor tissues and, consequently, result in improved graft survival. The induction of microchimerism, however, can be more efficiently achieved by partial ablation of the host immune system followed by transplant of the donor's bone marrow transplantation. However, at this time is not clear whether such aggressive protocols have any practical advantages over the simple administration of donor hematopoietic cells.
3. Another possible mechanism leading to a state of unresponsiveness to the MHC antigens of a graft is a lack of delivery of co-stimulatory signals to the responding cells of the recipient. This scenario is facilitated by the fact that the patients receive high doses of immunosuppressive agents. The lack of co-stimulation of presensitized T lymphocytes responding to the grafted tissue could result in apoptosis of the responding cells, i.e., in the deletion of clones reactive against the grafted tissue.

Pretransplant transfusions have been very much abandoned, because with improvements in matching and immunosuppression protocols, the transfusion effect became less and less evident. However, there is considerable interest in developing protocols using stem cell administration as a way to induce a more complete tolerance state that could allow suspension or significant dose reduction of immunosuppressive drugs.

E. Immunosuppression Side Effects

Effective long-term immunosuppression is inevitably associated with a state of immunoincompetence. Two major types of complications may result from this.

1. Opportunistic Infections

The immunosuppressed patient is susceptible to a wide variety of infections, particularly caused by infectious agents that are not often seen as pathogens in immunocompetent individuals, such as cytomegalovirus, herpesviruses (Epstein-Barr virus, herpes simplex virus, varicella-zoster virus), *Pneumocystis carinii*, *Toxoplasma gondii*, and fungi (e.g., *Candida albicans*). Cytomegalovirus (CMV) infections are particularly ominous because this virus can further interfere with the host's immune competence and may also trigger rejection in a nonspecific way.

The incidence of infections in transplant patients can be reduced by prophylactic therapy with intravenous gammaglobulin, which is part of most post-bone marrow transplant protocols, since those patients are probably the most profoundly immunosuppressed. Bone marrow and solid organ transplant patients also usually receive prophylactic antibiotics such as trimethoprim-sulfamethoxazole (for *Pneumocystis*, urinary tract infections,

pneumonia, and cholangitis prophylaxis), ganciclovir or acyclovir (for herpes and CMV prophylaxis), and clotrimazole or fluconazole (for *Candida* prophylaxis).

2. *Malignancies*

Either as a consequence of the oncogenic properties of some immunosuppressive agents or as a consequence of disturbed immunosurveillance, the incidence of malignancies is significantly increased in transplant patients. In patients with survival times following transplantation of 10 years or longer, the frequency of skin cancer (squamous or basal cell carcinoma) may be up to 40%, although the lesions are no more invasive than in normal individuals. An additional 10% may develop other types of malignancies, including EBV-associated, posttransplant lymphoproliferative disorder (PTLD).

The reasons for the predominance of skin cancer and PTLD among transplant patients may relate to the inability of the immune system to respond to papillomaviruses and Epstein-Barr virus (EBV), which are etiological agents for these malignancies, respectively. Some of these PTLD are reversible with interruption or reduction of immunosuppressive therapy, while others are true malignant lymphomas that may spread to areas usually spared in nontransplanted patients, such as the brain.

Common cancers such as colon, lung, and breast are seen no more frequently in transplant patients than in the normal population. This suggests that immune surveillance is *not* important for most common cancers.

3. *Other Side Effects*

The most widely used immunosuppressive agents have specific side effects that may have a significant negative impact on the quality of life of transplanted patients. Glucocorticoids can cause, among other side effects, obesity, insulin-resistant diabetes, cataracts, avascular necrosis of the femoral head, and thinning of the skin. Antimetabolites are associated with decreased blood counts and bone marrow depression. Cyclosporine and tacrolimus cause hypertension, nephrotoxicity, and neurotoxicity.

The use of combinations of different immunosuppressive drugs usually reduced the incidence and degree of side effects, because each drug that is part of the combination can be used at relatively well-tolerated doses. However, the ultimate goal of transplantation researchers is to develop protocols that would not require maintenance immunosuppression.

V. GRAFT-VERSUS-HOST REACTION

Whenever a patient with a profound immunodeficiency (primary, secondary, or iatrogenic) receives a graft of an organ rich in immunocompetent cells, there is a risk that a graft versus host GVH reaction may develop. GVH reactions are a significant problem in infants and children with primary immunodeficiencies in whom a bone marrow transplant is performed with the goal of reconstituting the immune system, as well as in adults receiving a bone marrow transplant as part of a therapeutic protocol for aplastic anemia or for a hematopoietic malignancy. Small bowel, heart-lung, and even liver transplantation rank second in risk of causing GVH reactions, since these organs have a substantial amount of lymphoid tissue. In contrast, transplantation of organs such as the heart and kidneys, poor in endogenous lymphoid tissue, very rarely results in GVH reaction. The probability of de-

veloping graft-versus-host disease (GVHD) is greatest in the 2-month period immediately following transplantation.

A. Pathogenesis

Two elements are essential for the development of a GVH reaction: the immune system of the recipient needs to be severely compromised, and the transplanted organ or tissue needs to contain viable immunocompetent cells. The deficiency of the immune system may be congenital or acquired. For example, patients receiving bone marrow transplants receive cytotoxic and immunosuppressive therapy, and their immune system is completely or partially destroyed to avoid rejection of the transplanted bone marrow.

When a graft containing immunocompetent cells is placed into an immunoincompetent host, the transplanted cells can recognize as nonself the host antigens. In response to these antigenic differences, the donor T lymphocytes become activated, proliferate, and differentiate into helper and effector cells that attack the host cells and tissues, producing the signs and symptoms of GVH disease. The crucial role played by the donor T cells in GVHD is demonstrated by the fact that their elimination from a bone marrow graft avoids the reactions (see below). However, as the GVH reaction evolves and reaches its highest intensity, the majority of the cells infiltrating the different tissues affected by the GVH reaction are of host origin and include T and B lymphocytes as well as monocytes and macrophages. The proliferation of host cells is probably a result of the release of high concentrations of non-specific mitogenic and differentiation factors by activated donor T lymphocytes.

However, it must be noted that several groups have reported findings suggesting that a low grade GVH reaction may actually accelerate bone marrow engraftment.

B. Pathology

The initial proliferation of donor T cells takes place in lymphoid tissues, particularly in the liver and spleen (leading to hepatomegaly and splenomegaly). Later, at the peak of the proliferative reaction, the skin, liver, and intestinal walls are heavily infiltrated leading to severe skin rashes or exfoliative dermatitis, hepatic insufficiency, and severe diarrhea or even intestinal perforation. The splenic involvement results in a loss of function not unlike that seen in splenectomized patients. The patients often develop *Streptococcus pneumoniae* bacteremia, and antibiotic prophylaxis may be necessary.

C. Treatment

All immunosuppressive drugs used in the prevention and treatment of rejection have been used for treatment of the GVH reaction. In addition, thalidomide, the tranquilizer drug that achieved notoriety due to its teratogenic effects, has been used successfully for the control of chronic GVH reaction unresponsive to traditional immunosuppressants, and it may become an extremely useful drug in the future.

D. Prevention

Once a GVH reaction is initiated, its control may be extremely difficult. Thus, great emphasis is placed on preventing GVH reactions. Besides the administration of immunosuppressive drugs, other approaches have been tried with variable success.

T-cell depletion of the graft can be achieved by pretreatment of the bone marrow with antilymphocyte/thymocyte immunoglobulin or with monoclonal antibodies reacting with T cells (e.g., anti-CD3) and can reduce significantly the incidence of GVH reactions. The major problem with this approach is that the transplantation of T-cell-depleted bone marrow into immunosuppressed adults may result in a persistent state of severe immunodeficiency. These data suggest that the T cells facilitate the engraftment of the donor stem cells within the host bone marrow, although the mechanism for this is not understood. In addition, a low-grade, controllable GVHD is often associated with better outcomes in leukemic patients, perhaps as a result of the elimination of leukemic cells by the grafted lymphocytes (graft-versus-leukemia effect).

Autologous stem cell transplantation using purified CD34⁺ cells and allogeneic umbilical cord stem cell transplantation (stem cells obtained from cord blood after delivery) is also associated with a lower risk of GVH reactions. Umbilical cord stem cell transplantation is also associated with reduced graft-versus-leukemia effect and a higher frequency of relapse.

Case 25.1 Revisited

The initial deterioration of kidney function seen 2 weeks after the graft would most likely correspond to a first-set acute rejection, but the possibility that cyclosporine toxicity was causing the symptoms could not be immediately ruled out. The findings on the biopsy, however, were typical of acute rejection, and treatment with large doses of glucocorticoids, or “pulse” steroids was instituted

The clinical deterioration seen 8 weeks after the transplant was obviously systemic in nature. GVH reaction was not a very likely possibility because of its very infrequent association with kidney grafts. A systemic CMV infection was suspected and confirmed by bronchoscopic biopsy, which revealed cells with intranuclear inclusion bodies on interstitial cells, colonoscopy with colonic biopsies of superficial ulcers of the right colon, which also revealed cells with intranuclear inclusions, and blood cultures that were positive for CMV virus.

A systemic CMV infection in an immunosuppressed patient requires energetic antiviral therapy. The patient was started on intravenous ganciclovir and had a reduction in the dosage of his immunosuppressive drugs. Over the course of the next 2 weeks he gradually improved and resolved his lung and colon pathology.

SELF-EVALUATION

Questions

Choose the one *best* answer.

- 25.1 Which one of the following organ or tissue transplants is LEAST likely to cause a graft-versus-host reaction?
- A. Bone marrow
 - B. Heart-lungs
 - C. Kidney
 - D. Liver
 - E. Small intestine
- 25.2 A 25-year-old female with chronic renal failure received a renal transplant. She was given cyclosporin A, steroids, and mycophenolate mofetil and ap-

peared to be recovering uneventfully for the first 2 weeks. At day 18 post-transplant the level of serum creatinine jumped from 2.1 to 3.5 mg/dL. A renal biopsy was obtained and showed heavy peritubular mononuclear cell infiltrates. Which one of the following events is most likely to have triggered this cellular reaction in the transplanted kidney?

- A. Complement activation by antigraft antibodies
 - B. Recognition of cell-bound IgG antibodies by large granular lymphocytes
 - C. Release of chemokines from activated T lymphocytes
 - D. Release of LTB₄ from activated monocytes
 - E. Release of PAF from activated PMN
- 25.3 A major complication resulting from the use of monoclonal anti-CD3 antibodies in the treatment of graft rejection is:
- A. Graft-versus-host reaction
 - B. Neutropenia
 - C. Non-Hodgkin's lymphomas
 - D. Urinary tract infections
 - E. Serum sickness
- 25.4 The major pathogenic factor(s) in hyperacute graft rejection is (are):
- A. Anti-Rh antibodies
 - B. Killer (K) lymphocytes
 - C. Natural killer cells
 - D. Predifferentiated cytotoxic T lymphocytes
 - E. Preformed cytotoxic antibodies
- 25.5 Athymic nude mice are transplanted with bone marrow from genetically unrelated and immunocompetent Balb/c donor mice. Identify in the following chart the most likely combination of results seen in the grafted mice.

B.M. Graft	Systemic effects
A. Rejected	None
B. Rejected	Splenomegaly, diarrhea, wasting
C. Accepted	None
D. Accepted	Splenomegaly, diarrhea, wasting
E. Accepted	Lymphomas, infections

- 25.6 Which of the following is the main risk associated with bone marrow transplant to an infant with lack of functional T-cell differentiation?
- A. B-cell replacement without T-cell replacement
 - B. Development of autoimmune hemolytic anemia
 - C. Lack of correction of the defect due to rejection of the graft
 - D. T-cell replacement without B-cell replacement
 - E. Uncontrolled proliferation of alloreactive donor T lymphocytes
- 25.7 The main problem facing surgeons trying to perform xenogeneic transplants is:
- A. Scarcity of suitable sources for the grafts
 - B. Technical difficulties associated with the size of the organs
 - C. Development of chronic rejection after a few months
 - D. Severe hyperacute rejection
 - E. Ethical problems

For questions 25.8 through 25.10, choose the best lettered heading. Each lettered heading may be used once, more than once, or not at all.

- A. Bone marrow transplant
 - B. Heart transplant
 - C. Kidney transplant
 - D. Liver transplant
 - E. Thymus transplant
- 25.8 Donor-recipient matching involves mixed lymphocyte cultures of potential donors and recipient
- 25.9 HLA typing does not affect graft acceptance and survival
- 25.10 Requires extensive pregraft immunosuppression

Answers

- 25.1 (C) The likelihood of developing a GVH reaction is minimal when solid organs with minimal endogenous lymphoid tissue are grafted, such as the kidney and the heart. However, the likelihood increases in a heart-lung transplant due to the lung-associated lymphoid tissues.
- 25.2 (C) A reaction appearing 18 days after graft could represent a first set acute rejection or a manifestation of drug toxicity. The massive mononuclear cell infiltrate observed in the kidney biopsy is indicative of a cell-mediated reaction, such as it is classically associated with first set acute rejection. The main cause for the accumulation of mononuclear cells is the release of chemokines by activated lymphocytes involved in the rejection of the grafted organ.
- 25.3 (C) Although many complications may result from the use of mouse monoclonal anti-CD3 antibodies in the treatment and prevention of rejection episodes due to the profound immunosuppression associated with their use and to their heterologous nature, a major life-threatening complication is the induction of EBV-related non-Hodgkin's B-cell lymphomas and posttransplant lymphoproliferative disorders. Serum sickness is usually reversible and can be avoided by suspending the administration of anti-CD3, but malignant lymphomas continue to develop.
- 25.4 (E)
- 25.5 (D) Athymic mice will lack T cells and will not be able to reject the graft, but the grafted T cells will be able to mount a graft-versus-host response, and the three major manifestations are splenomegaly, diarrhea, and wasting. Lymphomas and infections are more prevalent in immunocompromised animals, but not as a consequence of the bone marrow transplant.
- 25.6 (E) While a successful bone marrow graft should be curative for a patient with ADA deficiency, the main problem is the possible development of an uncontrolled GVH reaction due to the proliferation of grafted T cells recognizing alloantigens in the donor's tissues as nonself.
- 25.7 (D) Humans have preformed antibodies reactive with tissues from a variety of species, including those most often considered as possible organ sources. Those preformed antibodies cause hyperacute rejection.

- 25.8 (A) Proper donor-recipient matching is very important in bone marrow transplantation, where it is equally important to avoid rejection and the GVH reaction. MLC of the recipient's mononuclear cells with mononuclear cells from potential donors are often performed to complement the HLA-matching data.
- 25.9 (D) The outcome of liver transplant is not affected by HLA matching, perhaps because of the high regenerative capacity of the liver, which may render it resistant to rejection.
- 25.10 (A) When a bone marrow graft is performed, the long-term goal is to have transplanted bone marrow repopulated by the recipient's bone marrow. To achieve this goal, it is essential to ablate the recipient's immune system as completely as possible.

BIBLIOGRAPHY

- Beniaminovitz, A., Itescu, S., Lietz, K., et al. prevention of rejection in cardiac transplantation by blockade of the interleukin-2 receptor with a monoclonal antibody. *N. Eng. J. Med.* 342:613, 2000.
- Bromberg, J. S., and Grossman, R. A. Care of the organ transplant recipient. *J. Am. Board Fam. Pract.* 6:563, 1993.
- Cicciarelli, J., and Terasaki, P. Matching cadaver transplants achieve graft survivals comparable to living related transplants. *Transpl. Proc.* 23:1284, 1991.
- Ettenger, R., and Ferstenberg, L. B. Basic Immunology of transplantation. *Perspect. Pediatr. Pathol.* 14:9, 1991.
- Fugle, S. Immunophenotypic analysis of leukocyte infiltration in the renal transplant. *Immunol. Lett.* 29:143, 1991.
- Hariharan, S., Johnson, C. P., Bresnahan, B. A., et al. Improved graft survival after renal transplantation in the United States, 1988 to 1996. *N. Engl. J. Med.* 342:605, 2000.
- Hisanga, M., Hundrieser, J., Boker, K., et al. Development, stability, and clinical correlations of allogeneic microchimerism after solid organ transplantation. *Transplantation* 61:40, 1996.
- Kirk, A. D., Burkly, L. C., Batty, D. S., et al. Treatment with humanized monoclonal antibody against CD154 presents acute renal allograft rejection in human primates. *Nature Med.* 5:686, 1999.
- McDiarmid, S. V., Farmer, D. A., Goldstein, L. I., et al. A randomized prospective trial of steroid withdrawal after liver transplantation. *Transplantation* 60:1443, 1995.
- Parr, M. D., Messino, M. J., and McIntyre, W. Allogeneic bone marrow transplantation: Procedures and complications. *Am. J. Hosp. Pharm.* 48:127, 1991.
- Sollinger, H. W. Mycophenolate mofetil for the prevention of acute rejection in primary cadaveric renal allograft recipients. *Transplantation* 60:225, 1995.
- Waldmann, H. Transplantation tolerance-where do we stand? *Nature Med.* 5:1245, 1999.

26

Tumor Immunology

Sebastiano Gattoni-Celli

I. INTRODUCTION

In the first half of the twentieth century, a group of prominent scientists interested in the genetics of cancer developed inbred strains of mice, some of which were characterized by a high frequency of various neoplasias, including mammary tumors and leukemias. The investigators' objective was to mate mice from these strains with mice from low-frequency strains, and from the distribution of the characteristic cancer phenotype, they were hoping to understand the genetic factors underlying the susceptibility and resistance to the disease. However, in the course of developing inbred stocks of high cancer frequency, a genetic background was inadvertently created that allowed the multiplication of endogenous, cancer-causing retroviruses; in turn, this made identification of the viruses possible. A second unforeseen consequence of these crossing and tumor transplantation studies among different mouse strains was the discovery of the loci associated with the major histocompatibility complex (MHC), a discovery that has shaped and directed the progress of immunology to the present day.

Additional studies and clinical observations led to the development in the 1950s of the concept of immune surveillance, a term coined to describe natural immunological resistance against cancer. Although studies conducted with immunodeficient mice have mostly supported the idea that the main purpose of T-cell-mediated cellular immunity is to protect against viral and other infections, the immunosurveillance hypothesis provided an important conceptual framework for the field of tumor immunology. For instance, it is well known that renal transplant patients undergoing treatment with immunosuppressive agents exhibit a significant increase in skin cancers, especially on sites of the body exposed to UV-

containing sunlight, suggesting that immunosurveillance does play a role in protecting humans against special types of tumors, including virally induced warts.

The lack of clear evidence that immune surveillance plays a major role in protecting humans from the most common forms of cancer does not imply that human tumors express no tumor antigens nor that they are insensitive to destruction by immunological means. As a matter of fact, an increasing body of experimental evidence indicates that a variety of human cancers express tumor-associated antigens, some of which may serve as targets for cancer immunotherapy. Moreover, additional experimental evidence suggests that tumors may exercise immunosuppressive effects on the host, indirectly confirming that a healthy immune response can help the host in controlling cancer growth and spread.

II. IMMUNOGENICITY OF TUMORS

The immunogenicity of tumors has been a major topic of debate for several decades. In a seminal study on the immune response induced by spontaneous tumors, it was reported that none of 27 spontaneous murine tumors tested exhibited any detectable immunogenicity. However, the results of this study contrasted with the well-documented observation that rodent tumors induced by chemical carcinogens can elicit an immune response that causes rejection of tumor grafts in syngeneic animals. It is now accepted that even spontaneously occurring tumors induced in laboratory animals can be immunogenic when tested under appropriate experimental conditions.

Similarly, it was initially assumed that human cancers are less immunogenic than murine tumors; however, additional experimental work has shown that many human cancers are antigenic, even when the host immune response does not appear to prevent tumor progression. Some of the discrepancies between animal studies and human studies may result from experimental limitations. For example, it has been argued that only through transplantation of tumors might one be able to clearly demonstrate immunogenicity of certain human cancers. Obviously, such experiments cannot be performed.

A. Rejection antigens

Rejection antigens were originally defined as those responsible for the induction of an effective immunity against murine tumors induced by the chemical carcinogen methylcholanthrene (MCA). Similar observations were subsequently made with other chemical carcinogens, and, interestingly, rejection antigens appear to differ among different carcinogens and also among different animals given the same carcinogen; in other words, they seem to be unique to each individual tumor.

These observations suggested that a mutational mechanism, not necessarily directed to the same genetic target, might have been responsible for the generation of antigenic entities easily recognized by the host immune response. At the same time, it was shown that tumor rejection was mostly mediated through the cellular arm of the immune system (T cells). *In vitro* studies utilizing cancer-specific T cells also revealed that the recognition of antigenic entities by lymphocytes did not necessarily correlate with tumor rejection *in vivo*.

These experimental results led to the important conclusion that antigenicity and immunogenicity are not synonyms; in other words, antigenicity of a tumor *per se* may not be sufficient to ensure rejection of the same tumor. At the end of this chapter we will discuss

how this fundamental distinction is relevant to current immunotherapeutic approaches to human cancer.

B. Tumor-Associated Antigens

The realization from animal studies that antigens expressed by chemically induced tumors were unique gave the impression that any potential approach to cancer immunotherapy in humans might have been hopeless. However, later studies also indicated that virally induced as well as spontaneous neoplasms, including human cancers, did express shared tumor antigens, raising the possibility that immunotherapeutic approaches to human cancer could be devised and tested. However, it is important to point out that unique rejection antigens were easily identified by virtue of their ability to induce tumor rejection, suggesting that their individuality correlated with immunogenicity. On the other hand, shared tumor antigens, commonly known as tumor-associated antigens, were identified by different means, since they could not generally induce a measurable immune response directed against the tumor.

Given the practical impossibility of utilizing unique antigens for devising realistic immunotherapeutic approaches for cancer, it is important to fully understand the nature of tumor-associated shared antigens and the biology of any immune response directed against them in order to devise immunotherapeutic strategies for cancer that have a realistic chance of success in a clinical setting.

The mutant *ras* oncogene–encoded proteins and the mutant *p53* suppressor gene–encoded proteins represent important examples of shared tumor-associated antigens that have undergone mutational changes. In both cases, the mutational changes provide the cell with a growth advantage that eventually results in neoplastic growth; however, there is very little evidence that epitopes derived from the mutated regions of each protein are strongly immunogenic. In other words, these tumor-associated antigens do not represent tumor-rejection antigens.

These observations also suggest that environmental carcinogens may be responsible for the mutational changes that occur in spontaneous tumors and that these changes are not very different in nature and mechanism of induction from the mutations that are induced in experimental and murine tumors by well-studied chemical carcinogens like MCA. Therefore, rejection antigens are probably the result not of qualitative differences among mutations induced in chemically induced tumors versus spontaneous ones; rather, the large number of mutations found in chemically induced tumors obtained following the exposure of experimental animals to a large dose of carcinogen results in strong immunogenicity.

Additional examples of mutational changes possibly induced by environmental conditions are genomic rearrangements resulting in fusion proteins whose expression strongly correlates with the malignant phenotype. For instance, the epidermal growth factor receptor (EGF-R) gene undergoes an internal deletion in 40% of malignant glioblastomas, and the resulting altered gene product triggers growth of these tumor cells (unstoppable by current treatments). Since the mutated protein can be recognized by specific monoclonal antibodies, new treatments based on this observation may be tested in the near future for this uniformly lethal condition. At the present time it is not clear whether any tumor-associated antigens resulting from mutational changes like the ones discussed above will provide an effective target for immune-based treatments of those cancers that express them.

Normal cellular proteins overexpressed in certain cancers represent a second group of tumor-associated antigens. Several of these proteins have been identified and character-

ized in great detail in human melanoma, which represents possibly the best-studied tumor from an immunological perspective because of the extensive clinical and biological evidence that the host immune response can have a measurable impact on the natural course of this disease.

Examples of melanoma-associated, overexpressed tumor antigens are MART-1, GP100, and tyrosinase. These gene products are also lineage-specific, meaning that their expression appears to be limited to the melanocyte lineage, and their overexpression correlates with neoplastic development.

The MAGE family of melanoma antigens represents a separate set of melanoma-associated antigens that result from overexpression of normal cellular genes. These proteins are not lineage-specific, being normally expressed only in testes, but they are tumor-specific, because they are often overexpressed not only in melanoma, but also in several other epithelial cancers.

Lineage-specific and MAGE-type tumor-associated antigens have become the object of considerable interest, since the results of several recent clinical studies suggest that well-defined epitopes derived from these antigens when injected in conjunction with incomplete Freund adjuvant into select patients with melanoma could induce measurable biological and sometimes even clinical responses.

Additional studies have led to the identification of lineage-specific antigens in non-melanoma cancer types. The primary example is the carcinoembryonic antigen (CEA), which tends to be overexpressed in most adenocarcinomas of the gastrointestinal tract. An-

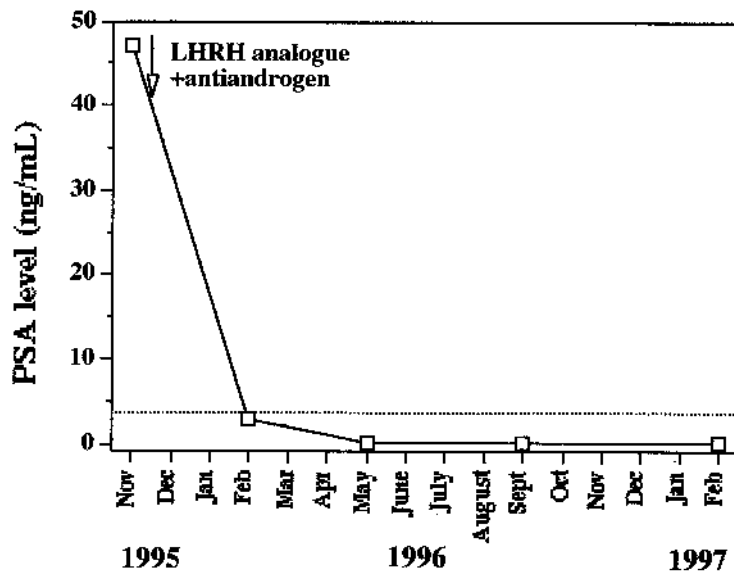

Fig. 26.1 Longitudinal evolution of PSA levels in a patient with prostate carcinoma. The tumor was diagnosed in November 1995, and shortly thereafter the patient was placed on medical therapy with a combination of a nonsteroidal antiandrogen and a luteinizing hormone-releasing analog. Three months later the level of PSA had decreased below the upper limit of normality (indicated by the dotted line) and decreased even further. The patient remained clinically tumor-free after stopping therapy in September 1999 until his death from an unrelated cause 4 months later.

other important example is the prostate-specific antigen (PSA), a protease expressed by prostate gland cells that becomes elevated in hypertrophic or cancerous prostate. A third example is the alpha-fetoprotein (AFP), which becomes elevated in patients with cancer of the liver or testes. These tumor-associated antigens are often overexpressed and may provide useful markers for monitoring the course of disease, since they may be measured in serum (Fig. 26.1).

Overexpression of the human epidermal growth factor receptor 2 (EGFR-2), also known as HER-2/neu, is observed in some breast and ovarian cancers, and its presence correlates with a more aggressive disease. It is worth noting that a monoclonal antibody against this molecule is currently approved for treating breast cancers overexpressing HER-2. The idiotype of the surface immunoglobulin in B-cell malignancies also constitutes a lineage-specific tumor-associated antigen, which is also unique and therefore clonal in nature. Clinical studies utilizing monoclonal antibodies to target B-cell idiotypes are currently being tested and show some promise.

III. EFFECTOR MECHANISMS IN CANCER IMMUNITY

Immunological studies performed in animals developing experimental tumors following exposure to MCA and other chemical carcinogens clearly showed that the immunity directed against rejection antigens is T-cell-mediated, since it can be transferred among mice within the same strain through the intravenous injection of immune cells, but not through the transfer of immune serum. Tumor-specific cytotoxic T cells (CTL) are generally MHC-restricted CD8⁺ lymphocytes, because they kill target tumor cells through recognition of an antigenic epitope bound to an appropriate MHC-I molecule expressed on the surface of the tumor cell. Additional data suggest that CD4⁺ lymphocytes are crucial to the development of CD8⁺ CTL.

Active CD8⁺ CTL can be derived from the peripheral blood of cancer patients by propagating the cells in the presence of interleukin-2 (IL-2) under special conditions of appropriate antigenic stimulation, which over time appear to expand the CD8⁺ component capable of expressing tumor-specific CTL activity. In extensive studies conducted at the Surgery Branch of the National Cancer Institute, it has been shown that tumor-infiltrating lymphocytes (TIL) obtained by expanding lymphocyte populations present in surgically resected melanoma lesions often represent an enriched population of CTL capable of recognizing and killing autologous tumor cells. Taken together, these observations led to clinical studies in which melanoma patients were treated by infusion of IL-2 and their own TIL, which had been expanded *ex vivo* to large numbers (10^{11} – 10^{13}). The results of these studies showed that some patients did benefit from these experimental treatments.

Monoclonal antibodies have been extensively utilized in studies aimed at finding out whether antibody-mediated immunity plays any significant role in anticancer immunity. Although there is very little evidence that antibodies are relevant to controlling tumor growth and spread, recent laboratory and clinical studies have revealed some surprising facts. Often cancer patients have in their serum antibodies that specifically recognize antigens expressed or released by their own tumors. These antibodies have led to the identification of several new tumor-associated antigens, and their possible clinical relevance is currently being evaluated. Moreover, several monoclonal antibodies are being assessed as therapeutics for a number of human cancers, and one of them, as previously discussed, is

currently approved for treatment of breast cancers overexpressing the HER-2 gene. Therefore, it is important to realize that, while antibodies in general may not play a major role in natural antitumor immunity, appropriately engineered monoclonal antibodies targeting certain tumor-associated antigens may represent important therapeutic tools against some types of cancer. The results of these clinical studies also suggest that successful approaches to immunotherapy utilizing either monoclonal antibodies or lymphocytes are not necessarily aimed at restoring what may be defective in the host immune response of the cancer patient. What these immunotherapeutic interventions seem to achieve is the mobilization of antitumoral immunological processes, mediated either by cells or by proteins, to specifically destroy autologous tumor cells.

Natural killer (NK) cells are a special subset of lymphocytes capable of killing tumor cells by a less specific mechanism than the one utilized by HLA-restricted CTL. NK cells preferentially recognize target cells that are low or nonexpressors of MHC molecules, a phenotype frequently exhibited by tumor cells as a way to avoid recognition by host CTL. Activation of NK cells can be achieved *in vitro* by propagating and expanding them in the presence of IL-2. These lymphokine-activated killer (LAK) cells have been utilized in clinical studies similar to those using the combination of TIL/IL-2; however, their lack of specificity supports the conclusion that HLA-restricted CTL are the most effective killers of autologous tumor cells.

Cytokines have been intensely studied because of their ability to modulate an extensive array of immune functions. We will discuss only IL-2 and the granulocyte-macrophage colony-stimulating factor (GM-CSF), since these two immuno-augmenting cytokines are of major importance not only for tumor immunology, but also for immunotherapeutic approaches that have shown some real promise in recent clinical studies.

IL-2 is a well-known activator of T-cell immunity, mostly by stimulating helper T cells to proliferate following their interaction with antigen-presenting cells (APCs); in turn, activated helper T cells (T_H1 cells) allow for the subsequent stimulation and proliferation of CTL, which will be ultimately responsible for destroying the target tumor cells. The key role played by IL-2 in the activation and maturation of the cell-mediated immune response explains to a large extent why IL-2 has become an approved drug for immunotherapy of melanoma and renal cell cancer. It is reasonable to expect that the uses of IL-2 may be expanded to other forms of cancer and possibly to AIDS immunotherapy.

GM-CSF was identified more recently than IL-2, and only after its discovery was it realized that one key function of this cytokine is the activation of APCs. In a seminal study aimed at comparing the immunogenicity of tumor cells engineered to express a wide variety of cytokines, it was shown that GM-CSF-expressing cells inactivated by irradiation and injected as a cancer vaccine into appropriate animal hosts were able to protect vaccinated animals from challenge with a lethal dose of unmodified tumor cells. Moreover, it was also shown that this kind of vaccination had some efficacy in a therapeutic setting, one in which vaccinated animals already carried a tumor burden. The results of this work helped refocus the attention of tumor immunologists on APCs as the central element of an effective immune response. In other words, APCs appear to explain the difference discussed at the beginning of this chapter between antigenicity and immunogenicity, insofar as they could confer immunogenicity to antigenic entities that would have otherwise been not only ineffective, but counterproductive to tumor immunity (see below). These animal studies also prompted a number of human clinical studies utilizing autologous tumor cells, either engineered to produce GM-CSF or simply mixed with it, as therapeutic vaccines for various forms of cancer.

IV. FACTORS AFFECTING TUMOR IMMUNOGENICITY

Tumor cells present antigenic epitopes bound to MHC molecules expressed on their cell surface (signal 1), but they do not express co-stimulatory molecules (signal 2), a prerogative of APC. It is now well established that expression of signal 1 in the absence of signal 2 may lead to tolerance and anergy of potential effector cells; therefore, one would expect that the size of the tumor burden may correlate with the degree of immunosuppression observed in a cancer patient. Clinical experience has confirmed this supposition, leading to the general consensus that immunotherapeutic modalities may be more appropriate for patients exhibiting a small tumor burden, as well as for patients in remission (e.g., following curative surgery) in whom immunotherapy is administered as an adjuvant to prevent recurrence of the cancer.

It is also well established that tumor cells release a number of factors/cytokines that can be immunosuppressive like TGF- β , IL-10, several prostaglandins, etc. Obviously, an increasing tumor burden would worsen the immunosuppression mediated by these factors.

It is generally assumed that tumor heterogeneity, both phenotypic and genotypic, is the result not only of intrinsic genomic instability associated with the cancer phenotype, but also the result of selective pressures that favor anaplastic variants with a more aggressive growth pattern. It is entirely plausible that some of these variants may result from immune selection: immune escape refers to the ability of progressing tumors to avoid recognition and killing by the host immune response. For instance, the level of expression of MHC-I molecules by a large variety of tumors is generally lower than in the normal tissue counterpart. Since tumor-associated antigenic epitopes are recognized by CTL only when bound to the extracellular portion of MHC molecules, downregulated expression of MHC-I would render recognition and killing of tumor cells by CTL more problematic, if not impossible. Consistent with this concept is the well-documented observation that, in many cases, sections of metastatic human tumors exhibit selective loss of individual HLA class I antigens (e.g., HLA-A2), which are prevalent in the general population, and for which it has been demonstrated the binding of a large number of immunogenic peptides derived from tumor-associated antigens. Decreased immunogenicity of human tumors may also result from the loss of antigenic expression itself, because the gene products corresponding to most human tumor-associated antigens do not play any direct role in the development of the malignant phenotype. Antigen loss variants have been demonstrated in biopsy specimens from metastatic human tumors.

Immunosuppression of cancer patients can be specific for the autologous tumor or extend to other aspects of the immune response, as in the case of a decreased reactivity to standard viral or bacterial recall antigens. This more generalized type of immunosuppression is often the consequence of treating patients with anticancer agents such as chemotherapeutic drugs or ionizing radiation, since neutrophils and lymphocytes are highly susceptible to these agents. These are important considerations when trying to assess the potential efficacy of immunotherapeutic regimens administered to patients who have previously undergone extensive chemotherapy or radiation therapy. Another negative factor to consider is age, which is also associated with a generalized decline of some immune responses. Since cancer most often strikes older people, a weaker immune response may make them somewhat more vulnerable to the disease and less likely to benefit from immunotherapy.

V. IMMUNOTHERAPY

The beginning of immunotherapy dates back more than 100 years when it was observed that intratumoral application of bacteria was associated with a strong inflammatory response and, at times, regression of neoplastic lesions. For quite some time, some clinical investigators attempted a type of nonspecific immunotherapy based on the administration of inactivated/attenuated bacteria. The favorite formulation became known as the complete Freund adjuvant, made of attenuated tuberculosis bacilli (bacille Calmette-Guérin, or BCG) mixed with mineral oil (incomplete Freund adjuvant). This formulation, generally administered intradermally or subcutaneously, was effective at eliciting a strong delayed-type hypersensitivity (DTH) response; however, the same formulation is often toxic since it can produce local necrosis and ulcerations.

In an attempt to generate a response that was specific for each tumor, cell-based vaccines became objects of intense study. Tumor vaccines can be autologous (made of the patient's own tumor cells) or allogeneic (made of a mixture of tumor cells not from the patient). At least in principle, autologous tumor cell vaccines are specific but available only in limited amount, while allogeneic vaccines can be produced in large quantities, but are not as patient-specific. Allogeneic vaccines are generally made of several established cell lines with the objective of encompassing a wide variety of antigenic specificities for each particular tumor type. Cell-based cancer vaccines appear to be more effective when combined with BCG or complete Freund adjuvant, strongly suggesting that the antigenic specificity of the vaccine and the adjuvant effect might work together to enhance the immunogenicity of the antigens associated with the tumor cells.

We now understand that the problem of translating our knowledge of tumor immunology into effective immunotherapy centers on the need to provide appropriate and long-lasting co-stimulatory help at the site of tumor growth in order to accomplish and sustain effective antitumor response.

It is not the purpose of this review to discuss the many current immunotherapeutic modalities being tested in ongoing clinical studies. Time will tell which approaches will become accepted clinical practice because of their relative success. Rather, it may be more relevant to discuss current trends in cancer immunotherapy.

As previously mentioned, IL-2 is now approved for treatment of metastatic melanoma and renal cell cancer. Numerous attempts are being tested in the clinic to increase the therapeutic efficacy of IL-2 by combining it with specific antigenic complexes as discussed below.

Tumor vaccines have been the object of numerous trials to determine the feasibility of stimulating the antitumoral immune response by active immunization with a variety of antigens, ranging from killed tumor cells to purified tumor antigens. In the most recent studies, synthetic antigenic epitopes (peptides) specific for certain types of cancer are being formulated with incomplete Freund's adjuvant and given in combination with IL-2. The obvious goal of these protocols is to stimulate the host immune response to recognize those tumor-associated antigenic complexes and subsequently promote the destruction of autologous tumor cells. The role of IL-2 is to stimulate proliferation and activation of helper and cytotoxic T cells. The administration of these therapeutic synthetic vaccines is repeated several times during each treatment protocol to help establish a sustained anticancer immune response.

An alternative approach to increase the efficiency of tumor vaccines has been to engineer tumor cells to express and release GM-CSF. This approach attempts to activate the host antitumor response at the site of injection by recruiting APCs to the site of vaccine

injection, where the expression of tumor-associated antigens may be optimal, as if the therapeutic vaccine were a “school” to “educate” the immune response to recognize and subsequently kill autologous tumor cells located at other sites in the body. Histological analysis of metastatic lesions in many patients enrolled in these experimental studies has confirmed the general validity of this approach, since numerous lesions are heavily infiltrated by lymphocytes and often have extensive areas of hemorrhagic necrosis.

Another approach to increase the immunogenicity of a tumor is called *heterogenization*, which can be achieved in a variety of ways, including infecting tumor cells with a virus, transfecting tumor cells with foreign MHC class I or II molecules, or fusing tumor cells with various allogeneic cells. The purpose of heterogenization is to force the host immune response to recognize tumor-associated antigens in the context of allogeneic MHC class I or II molecules or in proximity to strong foreign antigens. The allogeneic/foreign antigen would provide a strong co-stimulatory signal to affect an anti-tumor response.

More recently, autologous dendritic cells have been expanded *ex vivo* from cancer patients or normal volunteers and pulsed with appropriate tumor-specific antigenic epitopes before reinfusion into the patient. What all these different approaches have in common is to confer immunogenicity to autologous tumor-associated antigens in order to stimulate an immune response that may bring measurable clinical benefits.

A totally different approach to tumor immunotherapy is to use monoclonal antibodies. Some of the antibodies used in tumor immunotherapy are specific for molecular structures generally expressed on the cell surface of certain tumors (e.g., HER-2 in breast cancer, anti-CD20 in B-cell lymphomas). Others are equivalent to anti-idiotypic antibodies, which represent surrogate antigens since they bear the internal image of a tumor antigen. The mechanism of action of these antibodies is not entirely clear, because antibody-induced tumor regressions sometimes occur weeks after treatment, suggesting that antibody-mediated tumor lysis may not be the only effector mechanism.

VI. CONCLUSION

As the understanding of tumor biology and of antitumoral effector mechanisms increases, immunotherapeutic modalities are becoming more and more widely studied and accepted as an integral part of the field of cancer therapy. So far, success has been very limited, but immunotherapy is likely to become a progressively more important element in the therapeutic armamentarium of oncologists. The full realization of its apparent potential, however, will require much more experimental work to improve our understanding of the factors influencing the outcome of immunotherapeutic interventions and extensive clinical trials to judge the clinical impact of the new procedures.

SELF-EVALUATION

Questions

Choose the one *best* answer.

- 26.1 Which of the following immunotherapeutic agents has been approved for use in metastatic melanoma?
 - A. GM-CSF
 - B. Interferon- γ

- C. Interleukin-2
 - D. Interleukin-6
 - E. MART-1 monoclonal antibodies
- 26.2 High serum levels of carcinoembryonic antigen (CEA) are detected in:
- A. Metastatic prostate carcinoma
 - B. Patients with hepatitis
 - C. Patients with hepatoma
 - D. Patients with adenocarcinoma of the colon
 - E. Pregnant women
- 26.3 Which of the following is the most important effector mechanism in antitumoral immunity?
- A. ADCC effector cells
 - B. Antitumor antibodies
 - C. Cytotoxic CD8⁺ T cells
 - D. NK cells
 - E. T_H1 helper T cells
- 26.4 Which of the following cytokines has been shown to activate antigen-presenting cells?
- A. IL-1
 - B. IL-2
 - C. GM-CSF
 - D. Lymphotoxin- α
 - E. Interferon- α
- 26.5 The lack of immune response against most tumors is likely to be a result of:
- A. Downregulation of MHC-I expression
 - B. Generalized immunosuppression induced by growing neoplasm
 - C. Lack of delivery of co-stimulating signals to T_H0 cells by tumor cells
 - D. Lack of expression of tumor-associated antigens on the tumor cell membrane
 - E. Tolerance against tumor-associated antigens
- 26.6 The purpose of using heterogenized tumor cells obtained by fusing tumor cells with allogeneic cells in immunization protocols is to:
- A. Create a cell able to deliver more than one activating signal to tumor-specific T_H0 cells
 - B. Increase the survival of the tumor cells after reintroducing them in the patient
 - C. Induce a rejection reaction of the host against the hybrid cells
 - D. Induce the synthesis of protective cytokines (e.g., IL-2) in the host
 - E. Sensitize the allogeneic cells against the tumor
- 26.7 Which of the following is a consequence of the reduced expression of MHC-I molecules by tumor cells?
- A. Recognition by NK cells
 - B. Escape from ADCC-mediated antitumor responses
 - C. Induction of a strong T_H2 response
 - D. Lack of delivery of co-stimulating signals to CD8⁺ T cells
 - E. Lack of stimulation of T_H1 cells

For Questions 26.8 to 26.20, choose the one lettered heading best corresponding to the description given. Each lettered heading may be used once, more than once, or not at all.

- A. α -Fetoprotein (AFP)
 - B. Carcinoembryonic antigen
 - C. Both
 - D. Neither
- 26.8 Elevated serum levels are found in patients with prostate carcinoma
- 26.9 Elevated serum levels are found in patients with liver carcinoma
- 26.10 Useful in the management of patients with cancer

Answers

- 26.1 (C) IL-2 has been approved for the treatment of metastatic melanoma and renal cell carcinoma.
- 26.2 (D) Most patients with adenocarcinoma of the colon have high levels of CEA in circulation. Germ cell teratocarcinoma and hepatocellular carcinoma are the diseases associated with the highest concentrations of circulating α -fetoprotein, which may also be increased in patients with hepatitis and during pregnancy. CEA elevations may also occur in alcoholic cirrhosis. A different tumor-associated antigen (PSA) is associated with prostate carcinoma.
- 26.3 (C) Tumor-specific CD8⁺ T cells seem to play the most important role in the immunological elimination of tumor cells. T_H1 cells are likely to play a significant role in promoting the differentiation of tumor-specific CD8⁺ T cells but are not effector cells by themselves. The significance of NK cells has been somewhat discredited by the lack of consistent success of trials using IL-2-activated NK cells (LAK cells).
- 26.4 (C) Of the listed cytokines, only GM-CSF has been shown to activate APCs. Interferon- γ and IL-12 also have activating effects on at least some types of APCs, but interferon- α does not share those properties.
- 26.5 (C) Malignant cells express a variety of tumor-derived peptides and antigens on their membrane, but they lack the ability to deliver co-stimulatory signals to T_H0 cells that may react with them. The downregulation of MHC-I expression may also play a role, but this is not so much a general characteristic of tumors as it is the lack of effective antitumoral immune responses.
- 26.6 (A) If tumor cells can be manipulated in vitro to become able to deliver co-stimulatory signals, they should become effective immunizing agents. In the case of a hybrid formed between a tumor cell and an allogeneic cell, it is quite possible that these cells may induce a rejection reaction, but that in itself would not induce antitumoral immunity, it would only lead to the elimination of the hybrid cells.
- 26.7 (A) The activation of NK cells is dependent on the lack of an inhibitory signal delivered by the recognition of autologous MHC-I/peptide complex. If these complexes cease to be expressed, NK cells will be activated (see Chapter 11). MHC-I peptide complexes are also recognized by CD8⁺ cytotoxic T cells, but not by helper T cells of any type. The role of MHC-I with relation to CD8⁺ T-cell stimulation is to deliver the antigen-specific signal, not a co-stimulating signal. ADCC reactions are not related to MHC expression.

- 26.8 (D) The tumor-associated antigen elevated in prostate carcinoma is PSA.
 26.9 (A)
 26.10 (C) All tumor-associated antigens can be useful in the follow-up of patients with the tumors with which they are associated.

BIBLIOGRAPHY

- Disis, M. L., and Cheever, M. A. Oncogenic proteins as tumor antigens. *Curr. Opin. Immunol.* 8:637, 1996.
- Dranoff, G., Jaffee, E., Lazenby, A., et al. Vaccination with irradiated tumor cells engineered to secrete murine granulocyte-macrophage colony-stimulating factor stimulates potent, specific, and long-lasting anti-tumor immunity. *Proc. Natl. Acad. Sci. USA* 90:3539, 1993.
- Hewitt, H. B., Blake, E. R., and Walder, A. S. A critique of the evidence for active host defense against cancer, based on personal studies of 27 murine tumors of spontaneous origin. *Br. J. Cancer* 33:241, 1976.
- Kawakami, Y., Robbins, P. F., Wang, P. F., et al. The use of melanosomal proteins in the immunotherapy of melanoma. *J. Immunother.* 21:237, 1998.
- Oesterling, J. E. Prostate-specific antigen: a critical assessment of the most useful tumor marker for adenocarcinoma of the prostate. *J. Urol.* 145:907, 1991.
- Old, L. U., Boyse, E. A., Clarke, D. A., and Carswell, E. A. Antigenic properties of chemically-induced tumors. *Ann. NY Acad. Sci.* 101:80, 1962.
- Prehn, R. P., and Main, J. M. Immunity to methylcholanthrene-induced sarcomas. *J. Natl. Cancer Inst.* 18:769-778, 1957.
- Ravikumar, T. S., and Steele, G. D., Jr. Modern immunotherapy of cancer. *Adv. Surg.* 24:41, 1991.
- Restifo, N. R. Recombinant anticancer vaccines. *Sci. Am. Cancer* 2:16, 1996.
- Rosenberg, S. A. Adoptive cellular therapy in patients with advanced cancer. *Biol. Ther. Cancer Updates* 1(1):1, 1991.
- Rosenberg, S. A., Yang, J. C., Schwartzentruber, D. J., et al. Immunologic and therapeutic evaluation of a synthetic peptide vaccine for the treatment of patients with metastatic melanoma [see comments]. *Nature Med.* 4:321, 1998.
- Schreiber, H. Tumor immunology. In *Fundamental Immunology*, 4th ed. (William E. Paul, ed.). Lippincott-Raven, New York, 1999, p. 1237.
- Smith, M. E., Bodmer, W. F., Bodmer, J. G. Selective loss of HLA-A,B,C locus products in colorectal adenocarcinoma. *Lancet* 1:823, 1988.
- Soiffer, R., Lynch, T., Mihm, M., et al. Vaccination with irradiated autologous melanoma cells engineered to secrete human granulocyte-macrophage colony-stimulating factor generates potent antitumor immunity in patients with metastatic melanoma. *Proc. Natl. Acad. Sci. USA* 95:13141, 1998.
- Stevenson, H. C., ed. *Adoptive Cellular Immunotherapy of Cancer*. Marcel Dekker, NY, 1989.
- Tsang, K. Y., Zaremba, S., Nieroda, C. A., et al. Generation of human cytotoxic T cells specific for human carcinoembryonic antigen epitopes from patients immunized with recombinant vaccinia-CEA vaccine. *J. Natl. Cancer Inst.* 87:982, 1995.
- Van den Eynde, B. J., and Boon, T. Tumor antigens recognized by T lymphocytes. *Int. J. Clin. Lab. Res.* 27:81, 1997.

27

Malignancies of the Immune System

Gabriel Virella and Jean-Michel Goust

I. INTRODUCTION

Lymphocytes are frequently affected by neoplastic mutations, perhaps as a consequence of their intense mitotic activity. Lymphocyte malignancies can be broadly classified into B-cell and T-cell malignancies. B-cell malignancies (or dyscrasias) can be identified by the production of abnormal amounts of homogeneous immunoglobulins (or fragments thereof) resulting from the monoclonal proliferation of immunoglobulin-secreting B cells or plasma cells or by specific cell markers. T-cell malignancies (or dyscrasias) are usually identified through specific cell markers.

II. B-CELL DYSCRASIAS

Malignant proliferation of immunoglobulin-producing cells usually produce abnormally homogeneous immunoglobulins that are designated as monoclonal proteins (Fig. 27.1). The conditions associated with detection of monoclonal proteins are generically designated as monoclonal gammopathies, plasma cell dyscrasias, or B-cell dyscrasias (from the Greek *dyskrasis*, meaning “bad mixture,” often used to designate hematological disorders affecting one particular cell line).

Monoclonal proteins or paraproteins, in practical terms, are defined by the fact that they are constituted by large amounts of identical molecules, carrying one single heavy-chain class and one single light-chain type, or, in some cases, by isolated heavy or light

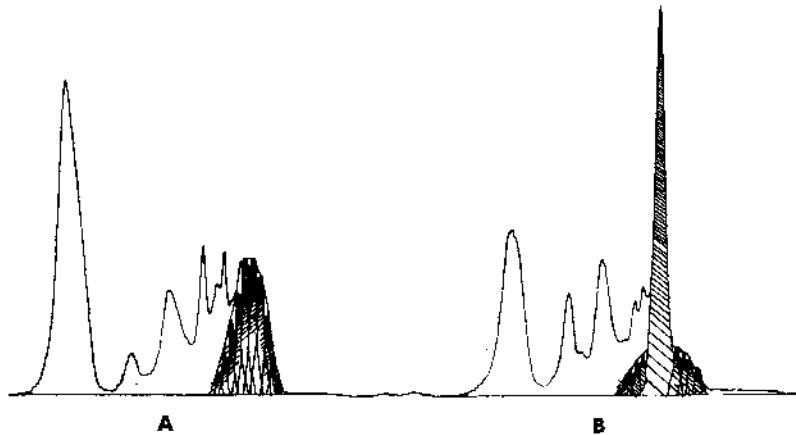

Fig. 27.1 Concept of monoclonal gammopathy: In normal sera or reactive plasmacytosis, the gammaglobulin fraction is made up of the sum of a large number of different antibodies, each of which is produced by a different plasma cell clone (A); if a B-cell clone escapes normal proliferation control and expands, the product of this clone, made up of millions of structurally identical molecules, will predominate over all other clonal products and appear on the electrophoretic separation as a narrow-based, homogeneous peak in the gammaglobulin fraction (B).

chains of a single type. It must be noted that monoclonal proteins may be detected in patients without overt signals of malignancy (some mutations may lead to clonal expansion without uncontrolled cell proliferation).

A. Diagnosis of B-Cell Dyscrasias

In general, the diagnosis of a B-cell dyscrasia relies on the demonstration of a monoclonal protein. Secreted paraproteins are detected by a combination of methods.

1. Initial screening usually involves the electrophoretic separation of serum and urine from the suspected case (Fig. 27.2). To be sure that urinary proteins are not overlooked because of their low concentration, the urine sample must be concentrated.
2. Electrophoretic studies must usually be supplemented by immunoelectrophoresis or by immunofixation. These studies are essential in order to characterize the paraproteins as containing one of the five possible classes of immunoglobulins and one of the two possible types of light chains (Fig. 27.3), necessary criteria to confirm the monoclonal nature of a suspected electrophoretic spike.
3. The diagnosis of some specific B-cell dyscrasias, such as light-chain disease (a variant of multiple myeloma characterized by the synthesis of large amounts of homogeneous light chains), Waldenström's macroglobulinemia, or the heavy-chain diseases, depends on the immunochemical characterization of the paraprotein.
4. In some instances, plasma cell dyscrasias do not result in the secretion of paraproteins. In rare cases of multiple myeloma, for example, the neoplastic mutation alters the synthetic process so profoundly that no paraproteins are produced (nonsecretory myeloma).

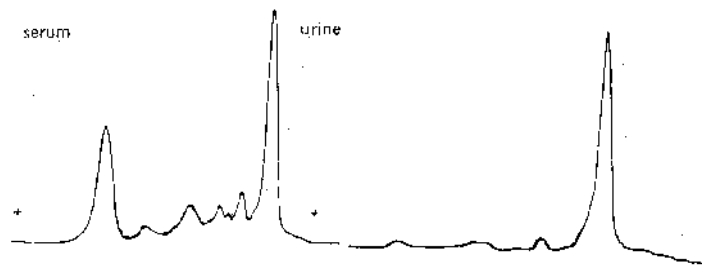

Fig. 27.2 Electrophoresis of serum and urine proteins from a patient with multiple myeloma. The serum, shown on the left, depicts a very sharp peak in the gammaglobulin region, with a base narrower than that of albumin, corresponding to an IgG monoclonal component. The urine, shown on the right, indicates a sharp fraction in the gamma region with only traces of albumin, meaning that the monoclonal peak is constituted by proteins smaller than albumin, able to cross the glomerular filter. This monoclonal protein in the urine was constituted by free κ type light chains (κ type Bence Jones protein).

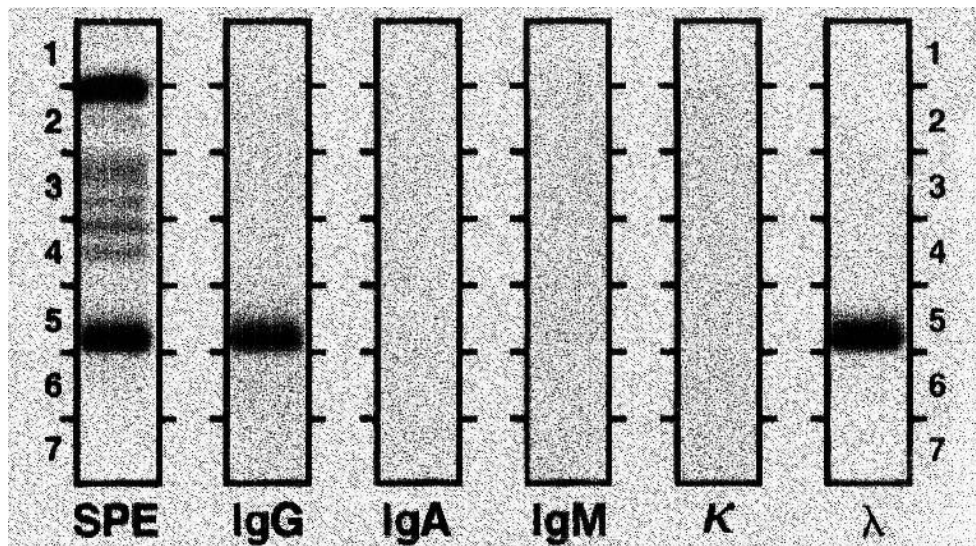

Fig. 27.3 Immunoblot of the serum protein of a patient with multiple myeloma. The lane labeled SPE was fixed and stained after electrophoresis and shows a homogeneous fraction in the gamma globulin region, near the bottom part of the separation region. The remaining lanes were blotted with the following antisera: anti-IgG, anti-IgA, anti-IgM, anti- κ chains, and anti- λ chains. Notice that the antisera specific for IgG and for λ chains reacted with the homogeneous fraction, which therefore was identified as an IgG λ monoclonal protein. (Immunoblot courtesy of Dr. Sally Self, Department of Pathology and Laboratory Medicine, Medical University of South Carolina.)

5. B-lymphocyte malignancies may also not be associated with the synthesis of monoclonal proteins. Chronic lymphocytic leukemias are B-cell malignancies in more than 90% of the cases, but only one third show paraproteins; the remainder have monoclonal cell surface immunoglobulins only. B-cell acute lymphocytic leukemias show rearrangements of their immunoglobulin heavy-chain genes in chromosome 14, and the malignant cells may synthesize μ chains, but those remain intracytoplasmic and there is no detectable monoclonal protein in serum or urine.

In the majority of cases, the finding of a monoclonal protein in a laboratory test does not give a very precise diagnostic indication. For example, the isolated finding of homogeneous free light chains (Bence Jones protein) in the urine may correspond to one of the following B-cell dyscrasias: (1) light-chain disease; (2) chronic lymphocytic leukemia; (3) lymphocytic lymphoma; or (4) “benign” or “idiopathic” monoclonal gammopathy. The precise diagnosis depends on a combination of clinical and laboratory data, as discussed in detail later in this chapter.

Case 27.1

A 55-year-old woman was admitted with progressive weakness, malaise, fatigue, and loss of vision. She also felt short of breath after climbing one flight of stairs. She claimed that for the previous 3 months she had experienced a progressive loss of bilateral vision, which she described as progressive blurring, to the point that she could hardly walk around unassisted. She had also lost 5 pounds since she started feeling sick and had noticed easy gum bleeding after brushing her teeth. She had also experienced three episodes of nose bleeding in the last few weeks.

Her past medical history included two normal pregnancies, diffuse rheumatic pains for the last year, and an episode of pneumonia 6 months ago.

Physical examination showed the patient to be thin, with normal vital signs. Examination of the head showed pale conjunctival mucosae. Fundoscopy showed irregularly dilated, tortuous veins, with flame-shaped retinal hemorrhages and “cotton wool” exudates in both eyes. Ear, nose, and throat appeared normal. Neck examination revealed no abnormalities. No lymph nodes were palpable. Chest and abdominal examination were within normal limits. Pelvic and neurological examination also showed no abnormalities.

Serum protein electrophoresis—abnormal spike in the gamma region, which was typed by immunofixation as IgA kappa. Serum immunoglobulin levels—IgG: 340 mg/dL; IgA: 5800 mg/dL; IgM: 47 mg/dL. Complete blood count—RBC: $3.8 \times 10^6/\mu\text{L}$ (normal 4.2–5.4); WBC: $5.9 \times 10^3/\mu\text{L}$ (normal 4.8–10.8); normal differential; erythrocyte hemoglobin: 8.9 g/dL (normal 12.0–16.0). X-ray survey of the skeleton: multiple osteolytic lesions in the skull, femur, humerus, pelvis, spine, and ribs.

This case raises several questions:

- Why did this patient present with weakness, easy fatigue, and loss of vision?*
- What is the significance of the fundoscopic abnormalities and exaggerated mucosal bleeding?*
- What is the nature of the osteolytic lesions seen in the bone?*
- What is the diagnosis of this condition?*
- What is the best treatment for this patient?*

C. Physiopathology of B-Cell Dyscrasias

1. Direct Pathological Consequences of Malignant B-Cell Proliferation

Depending on the type of proliferating B cell, patients may present:

Enlargement of lymph nodes, spleen, and liver, as seen in lymphomas and some leukemias.

Leukemic invasion of peripheral blood, characteristic of B-cell leukemias.

Compressive and obstructive symptoms resulting from the proliferation of plasma cells in soft tissues. Oro-pharyngeal plasmocytomas often lead to obstructive symptoms. Heavy-chain-producing intestinal lymphomas, when grossly nodular, can lead to intestinal obstruction.

Intestinal malabsorption, typical of α -chain disease, resulting from extensive infiltration of the intestinal submucosa by malignant B cells, causing total disruption of the normal submucosal architecture.

2. General Metabolic Disturbances

General metabolic disturbances are responsible for some major pathological manifestations of B-cell dyscrasia, such as bone destruction, renal insufficiency, anemia, and secondary immunodeficiency.

Bone destruction does not result directly from B-cell proliferation but rather from osteoclast hyperactivity induced by an activating cascade triggered by the malignant B cells. The initial event is believed to be the exaggerated synthesis of IL-1 and/or lymphotoxin- α by transformed plasma cells. These cytokines activate osteoblasts and/or stromal cells and induce the secretion of IL-6, which acts as a growth factor for plasma cells and as an activating factor for osteoclasts. However, there is experimental evidence suggesting that other cytokines, including IL-1 and macrophage colony-stimulating factor (M-CSF), both produced by neoplastic plasma cells, also have activating effects on osteoclasts.

Renal insufficiency can result from a diversity of factors, such as hypercalcemia (secondary to bone reabsorption), hyperuricemia, deposition of amyloid substance in the kidney, clogging of glomeruli or tubuli with paraprotein (favored by dehydration), and plasmocytic infiltration of the kidney.

Anemia (normochromic, normocytic) is frequent and is basically due to decreased production of red cells. A moderate shortening of red cell survival is also common.

A paradoxical feature of B-cell malignancies is the secondary immunodeficiency that develops in patients that often have marked increases in their concentrations of circulating immunoglobulins. This is particularly obvious in patients with multiple myeloma, who have an increased tendency for pyogenic infections. In reality, if the levels of residual normal immunoglobulins are measured, they are found to be low. Also, these patients show decreased antibody production after active immunization. The depression of the immune response in patients with multiple myeloma appears to be multifactorial.

1. In IgG myeloma, the large amounts of IgG secreted by the malignant cells are likely to have a feedback effect, depressing normal IgG synthesis (see Chapter 6).
2. A more general mechanism of suppression of the humoral response seems to be mediated by phagocytic monocytes (and to a lesser extent T cells). The immunosuppressor properties of these cells can be demonstrated by co-culturing peripheral blood mononuclear leukocytes from normal donors and from

myeloma patients. The co-culture results in impairment of the function of the normal B lymphocytes.

- Other abnormalities that may contribute to the predisposition to infections are defects in neutrophil responses and impairment of $Fc\gamma$ receptor functions in phagocytes, which are more likely to be present in patients with renal failure. Anemia also seems to predispose to infections, for unknown reasons.

In chronic lymphocytic leukemia, in addition to a depression of humoral immunity (milder than that seen in multiple myeloma), there is a depression of T-cell counts and function. Viral and fungal infections, as well as cases of disseminated infection after administration of live attenuated viral vaccines, have been reported in patients with this type of leukemia.

3. Serum Hyperviscosity

Some plasma cell dyscrasias may present with a constellation of symptoms known as the hyperviscosity syndrome. This is a direct result of serum hyperviscosity, caused by high concentrations of monoclonal proteins. Serum viscosity increases with protein concentration. IgM and polymeric IgA, due to their molecular complexity and high intrinsic viscosity, lead to disproportionate increases of blood viscosity (Fig. 27.4). Not surprisingly, the hyperviscosity syndrome is a frequent manifestation of Waldenström's macroglobulinemia, a B-cell dyscrasia defined by the synthesis of monoclonal IgM. However, the hyperviscosity syndrome is also observed in multiple myeloma patients, mainly in those with IgA paraproteins, and occasionally in IgG myeloma, when the concentrations of IgG are very high. The symptoms of serum hyperviscosity are related to high protein concentration,

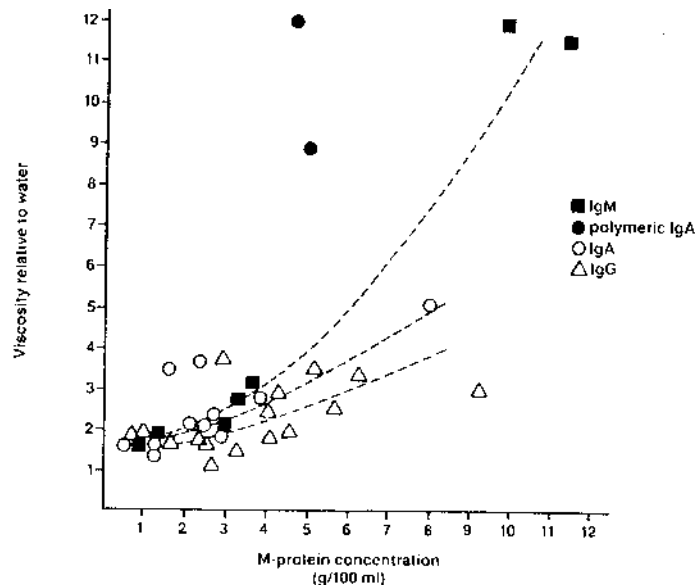

Fig. 27.4 Plot of relative serum viscosity vs. monoclonal protein concentration in sera containing IgG, IgA, and IgM monoclonal proteins. The highest viscosity values were determined in sera containing IgM or polymeric IgA monoclonal proteins.

Table 27.1 Clinical Manifestations of the Hyperviscosity Syndrome

Ocular
Variable degrees of vision impairment
Fundoscopic changes
Dilation and tortuosity of retinal veins (“string-of-sausage” appearance)
Retinal hemorrhage and “cotton-wool” exudates
Papilledema
Hematological
Mucosal bleeding (oral cavity, nose, gastrointestinal tract, urinary tract)
Prolonged bleeding after trauma or surgery
Neurological
Headaches, somnolence, coma
Dizziness, vertigo
Seizures, EEG changes
Hearing loss
Renal
Renal insufficiency (acute or chronic) due to
(a) clogging of the glomerular vessels with paraprotein and
(b) diminished concentrating and diluting abilities
Cardiovascular
Congestive heart failure secondary to expanded plasma volume

Source: Modified from Bloch, K. J., and Maki, D. G. *Sem. Hematol.* 10:113, 1974.

expanded plasma volume, and sluggishness of circulation. Table 27.1 lists the main signs and symptoms of the syndrome. Typical fundoscopic changes are shown in Figure 27.5.

4. Pathological Consequences of the Immunological Activity of a Paraprotein

Most paraproteins have unknown and inconsequential antibody activities, but in some exceptional cases the reactivity of a monoclonal protein may be directly responsible for some of the manifestations of the disease.

Cold Agglutinin Disease. Cold agglutinin disease results from the synthesis of large concentrations of monoclonal IgM (IgM κ in more than 90% of the cases) with cold agglutinating properties. Those monoclonal cold agglutinins react with the “I” antigen expressed by the erythrocytes of all normal adults, and the reactivity is only evident at temperatures below normal body temperature. Usually, the sera suspected to contain them are tested at 4°C on a direct hemagglutination test using O-positive red cells as antigens. For these reasons, these autoantibodies are known as cold agglutinins. Monoclonal cold agglutinins can be detected:

1. In cases of IgM-producing B-cell malignancy (Waldenström’s macroglobulinemia, see below), when the IgM paraprotein behaves as a cold agglutinin. The titers of cold agglutinins in such cases are very high, and usually the patient will have symptoms attributable to the cold agglutinin.
2. In patients with symptomatic cold agglutinin disease associated to high titers of a monoclonal cold agglutinin in which there is no evidence of B-cell dyscrasia other than the presence of a monoclonal anti-I antibody and an increase in the numbers of lymphoplasmocytic cells in the bone marrow.

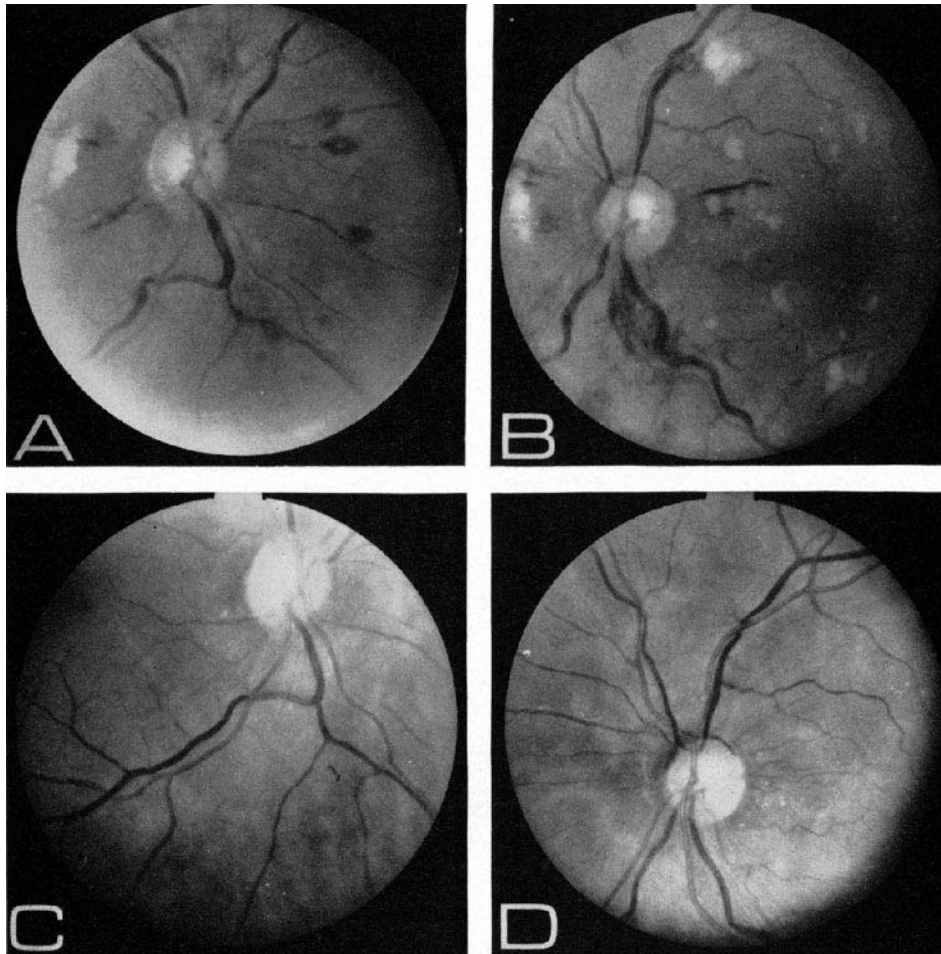

Fig. 27.5 Fundoscopic examination of a patient with hyperviscosity syndrome. (A and B) Pictures obtained from the right and left eyes, respectively, at the time of admission. Flame-shaped hemorrhages, “cotton-wool” exudates, and irregular dilation of retinal veins are evident. (C and D) Pictures obtained from the same eyes after 5 months of therapy, showing total normalization. (From Virella, G., et al. Polymerized monoclonal IgA in two patients with myelomatosis and hyperviscosity syndrome. *Br. J. Haematol.* 30:479, 1975. Reproduced with authorization of the publisher.)

The clinical manifestations of cold agglutinin disease fall into two categories:

1. Cold-induced hemolytic anemia, which is usually mild, but in some severe cases can be intense enough to lead to acute renal failure
2. Cold-induced ischemia, due to massive intracapillary agglutination in cold-exposed areas

Hyperlipidemia. A pronounced increase in serum lipid and lipoprotein levels can often be detected in patients with monoclonal gammopathies, and in some cases the monoclonal protein has antibody activity to lipoproteins. It has been demonstrated that the binding of antibodies to the lipoprotein molecules alters the uptake and intracellular processing of the lipoprotein, resulting in hyperlipidemia and in increased accumulation of cholesterol in macrophages.

D. Clinical Presentations of B-Cell Dyscrasias

1. Multiple Myeloma

The most frequent clinical symptoms of multiple myeloma are (1) bone pain and “spontaneous” or “pathological” fractures, (2) malaise, headaches, or other symptoms related to hyperviscosity, (3) weakness and anemia, (4) repeated infections, and (5) renal failure.

In some cases, anemia is the leading feature, and the diagnosis is established when the cause of anemia is investigated. Hemoglobin levels below 7.5 g/dL are usually associated with poor prognosis. Other cases are first seen in a rheumatology outpatient clinic, due to “bone pains.” If there is advanced bone destruction the diagnosis may be prompted by a fracture after minimal trauma (known as “pathological” fractures). Symptoms related to hyperviscosity (see Table 27.1) may also lead to hospitalization.

Repeated infections and renal failure, which usually occur in advanced stages of the disease, are among the most frequent causes of death but rarely constitute the presenting symptoms. Infection is associated with an increased risk of death, and the prognosis for a multiple myeloma patient with renal failure, particularly when his blood urea nitrogen exceeds 80 mg/dL, is also poor.

Several parameters have been found to be associated with rapidly growing myelomas and poor prognosis. In general, these parameters reflect the magnitude of the malignant cell population and its degree of dedifferentiation and include:

- Heavy plasma cell infiltration of the bone marrow (>30%)
- Numerous lytic bone lesions
- Bence Jones proteinuria
- Low hemoglobin (<11 g/L)
- Expression of myeloid cell markers and the CALLA antigen on the membrane of the malignant plasma cells
- Expression of the *c-myc* gene
- High serum levels of β_2 -microglobulin, thymidine kinase, and neopterin

Laboratory Diagnosis. A typical case of multiple myeloma will present at least two elements of the following diagnostic triad: (1) bone lesions, (2) monoclonal protein in serum and/or urine, and (3) bone marrow plasmacytosis.

Bone lesions are typically osteolytic (appear in the x-ray as punched-out areas without peripheral osteosclerosis) and multiple (several punched-out areas appear in the same bone and can be seen in a number of bones in the same patient) (Fig. 27.6). Practically all bones can be affected. In advanced cases, pathological fractures can occur in the long bones, skull, or spinal column. Rarely, a single bone lesion may be detected in one patient; however, such a “solitary bone plasmacytoma” is in fact rarely solitary, and bone marrow aspiration will reveal diffuse plasmacytosis in most cases. Exceptionally, a patient with monoclonal gammopathy and diffuse plasmacytosis can present with no evident bone lesions or with generalized osteoporosis.

A monoclonal protein in serum and/or urine can be detected in 98% of the cases of multiple myeloma if proper techniques are used. The distribution of monoclonal proteins among the different immunoglobulin classes closely parallels the relative proportions of those immunoglobulins in normal serum: 60–70% of the proteins are typed as IgG, 20–30% as IgA, 1–2% as IgD, and, very rarely, one monoclonal protein can be typed as IgE. A single light-chain type is found in these paraproteins. For example, IgG paraproteins can be either κ or λ . The finding of a heterogeneous increase in IgG or any other immunoglobulin (i.e., an increase of both IgG κ and IgG λ molecules) is not compatible with a diagnosis of multiple myeloma.

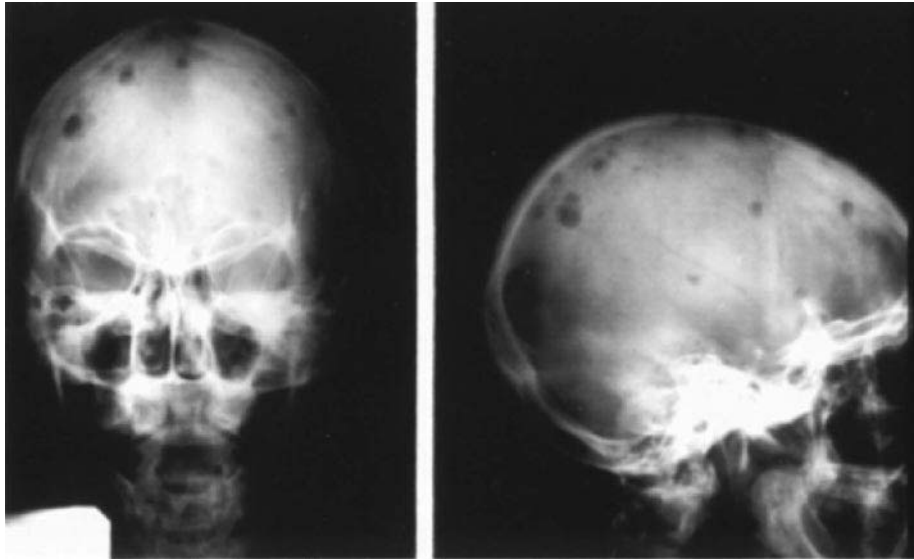

Fig. 27.6 X-ray of the skull of a patient with multiple myeloma showing typical osteolytic lesions. (Courtesy of Dr. S. Richardson.)

In the urine, the most frequent finding is the elimination of free light chains, κ or λ (Bence-Jones proteins) (see Fig. 27.7). These light chains are usually found in addition to a monoclonal immunoglobulin detectable in serum, but in about 20–30% of patients with multiple myeloma the only abnormal proteins to be found are the free monoclonal light chains in the urine. Some authors give the designation of light-chain disease to the form of multiple myeloma in which the paraprotein consists of free light chains.

Very rarely (about 2% of cases) no monoclonal paraprotein is detected in the serum or urine of a patient with a typical clinical picture of multiple myeloma. This situation is designated as nonsecretory myeloma. In most nonsecretory myelomas, immunofluorescence studies have demonstrated intracellular monoclonal proteins that are not secreted into the extracellular spaces. Nonsecretory myelomas have a very poor prognosis.

Bone marrow plasmacytosis is the third element of the diagnostic triad for multiple myeloma. Bone marrow aspirates show increased numbers of plasma cells with a more or less mature appearance (Fig. 27.8). The plasma cell infiltration can be massive, with sheets of plasma cells occupying the bone marrow. However, it must be stressed that an increase in the number of plasma cells in the bone marrow, even when associated with morphological aberrations, is not sufficient to differentiate between malignant and reactive plasma cell proliferation. The differential diagnosis between malignant and reactive plasma cell proliferation should be based on the immunochemical characteristics of the patient's immunoglobulins. While a patient with a malignant B-cell dyscrasia will show either a monoclonal protein or low immunoglobulin levels (if it is a case of nonsecretory myeloma), reactive plasmacytosis is invariably associated with a polyclonal increase of immunoglobulins.

Management. The management of a patient with a monoclonal gammopathy rests on a decision about whether the malignancy is dormant or aggressive. Multiple myeloma is, in the vast majority of cases, an aggressive malignancy, and its management is usually

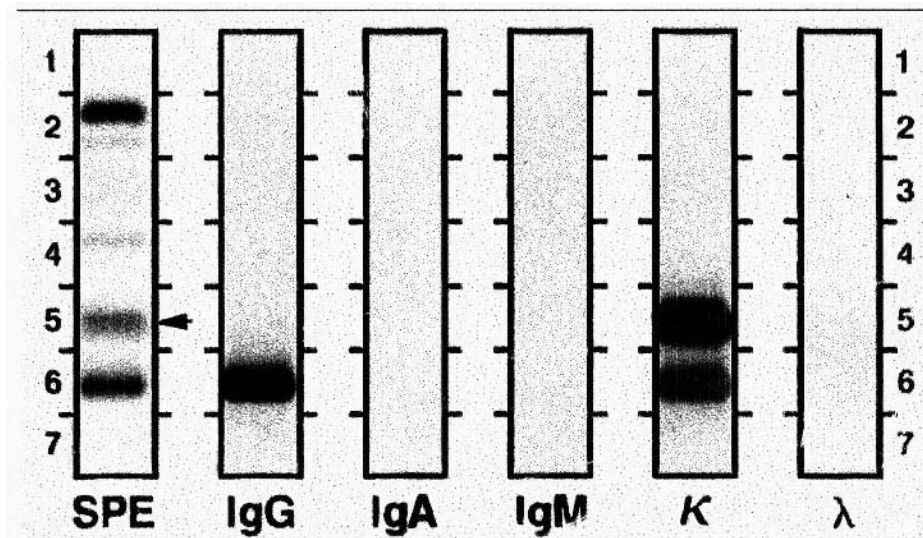

Fig. 27.7 Immunoblot study of the urinary proteins of a patient with multiple myeloma. The serum protein electrophoresis (SPE, left lane) of the urine reveals several proteins, including albumin (top) and two homogeneous fractions (bottom), suggesting a moderate degree of kidney insufficiency. The bottom fraction on SPE reacted both with an antiserum specific for IgG heavy chains and anti- κ chains, and is thus identifiable as complete IgG κ . The second homogeneous protein seen in SPE (arrow) reacted only with anti- κ chains. Thus, this fraction is identifiable as free κ chains (Bence Jones protein, κ type). (Immunoblot courtesy of Dr. Sally Self, Department of Pathology and Laboratory Medicine, Medical University of South Carolina.)

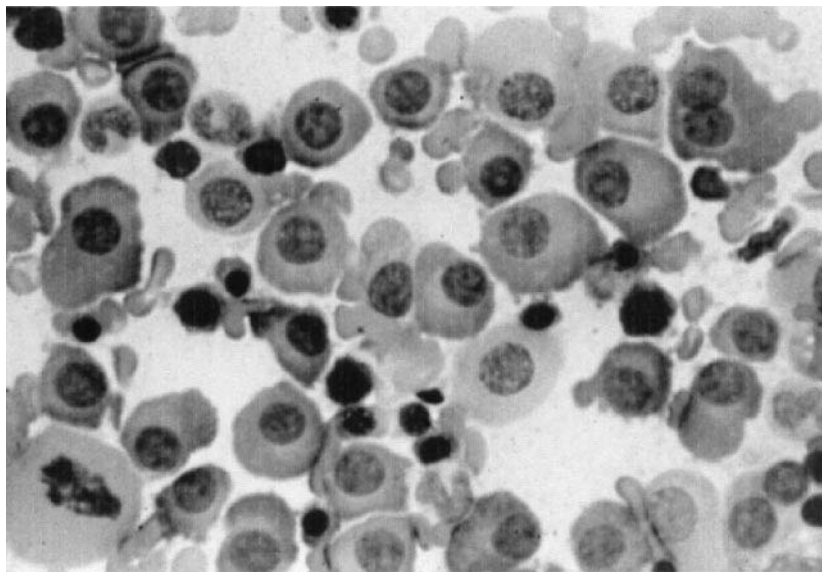

Fig. 27.8 Plasma cell infiltration of the bone marrow in a patient with multiple myeloma. Note the binucleated plasma cell in the upper right corner of this picture.

based on staging. Staging depends on a variety of parameters indicating early stages versus full-blown or terminal stages, including:

1. A high labeling index, usually determined by counting the number of plasma cells that show bright nuclear staining with a fluorescent monoclonal antibody to 5-bromo-2-deoxyuridine. This enzyme becomes associated with the DNA of actively proliferating cells, and its visualization is considered indicative of an aggressive tumor.
2. Other markers associated with aggressive tumors include high levels of (a) β_2 -microglobulin—produced and shed by actively proliferating plasma cells, (b) thymidine kinase—another enzyme involved in DNA synthesis which is released by dividing cells, (c) IL-6, the main cytokine proposed to mediate plasmacytoma cell growth, and (d) C-reactive protein—a direct reflection of the levels of IL-6, since this interleukin stimulates C-reactive protein synthesis.

A combination of assays for the labeling index and β_2 -microglobulin levels is believed to give the best indication of the degree of aggressiveness of a multiple myeloma.

Chemotherapy is the standard treatment for multiple myeloma. Classically treatment consisted of the administration of a combination of melphalan and prednisone in intermittent high dosage cycles. Recently, combination chemotherapy regimens (including these two drugs plus several others, such as vincristine, nitrosourea, cyclophosphamide, and doxorubicin) have gained favor with more complete and durable responses. Even higher rates of remission can be obtained with administration of several chemotherapeutic agents followed by autologous bone marrow or stem cell transplantation. The preferred approach is to obtain stem cells ($CD34^+$) from the peripheral blood after an initial administration of large doses of cytotoxic drugs (particularly cyclophosphamide) plus GM-CSF and use those cells to reconstitute the immune system after more extensive ablation of the bone marrow.

Biological response modifiers have gained popularity in recent years. Administration of interferon- α as maintenance therapy after a favorable response is obtained with chemotherapy has been reported to extend the duration of relatively symptom-free periods. In vitro experiments suggest that interferon- γ inhibits the IL-6-induced growth of some myeloma cell lines and that retinoic acid (an agent known to induce the redifferentiation of malignant cells) depresses the expression of IL-6 receptors on other myeloma cell lines. However, the therapeutic value of these two compounds is still questionable.

Plasmapheresis, which consists of replacing the patient's plasma by normal plasma or a plasma-replacing solution, is indicated in cases with hyperviscosity. The reduction of viscosity secondary to the reduction in the circulating levels of monoclonal protein caused by chemotherapy takes time, and the rapid correction of hyperviscosity may be essential for proper management. The rapidly beneficial effects of plasmapheresis are illustrated in Fig. 27.4, which shows the normalization of retinal changes observed after plasmapheresis.

Other supportive measures include hemodialysis or peritoneal dialysis in cases with renal insufficiency, and antibiotic therapy and prophylactic administration of gammaglobulin in patients with recurrent infections.

2. Plasma Cell Leukemia

Plasma cell leukemia is the designation applied to cases in which large numbers of plasma cells can be detected in the peripheral blood (exceeding 5–10% of the total white blood cell

count). Besides the leukemic picture in the peripheral blood, the remaining clinical and laboratory features of plasma cell leukemia are usually indistinguishable from those of multiple myeloma. The prognosis is generally poor; this may reflect a higher degree of dedifferentiation on the part of malignant plasma cells that abandon their normal territory.

3. “Benign” or “Idiopathic” Monoclonal Gammopathies

The designation of benign or idiopathic monoclonal gammopathy (monoclonal gammopathy of undetermined significance, MGUS) is used when a monoclonal protein is found in an asymptomatic individual or in a patient with a disease totally unrelated to B-lymphocyte or plasma cell proliferation (solid tumors, chronic hepatobiliary disease, different forms of non-B-cell leukemia, rheumatoid arthritis, etc.).

Scandinavian authors conducting extensive population studies have given an average figure for the incidence of idiopathic monoclonal gammopathies of about 1%, by far the most common form of B-cell dyscrasia. The incidence seems to increase in the elderly, up to about 20% in 90-year-old and older individuals.

The clinical significance of the finding of a benign or idiopathic monoclonal gammopathy lies in the need to make a differential diagnosis with a malignant B-cell dyscrasia in its early stages. Several criteria for the differential diagnosis between benign and malignant plasma cell dyscrasias have been proposed (Table 27.2).

A good practical rule is to assume that any monoclonal gammopathy detected unexpectedly during the investigation of a condition not clearly related to a B-cell malignancy, or during screening of a normal population (particularly in individuals of advanced age), should be considered as benign until proven otherwise. The best attitude in such cases is to withhold cytotoxic therapy and follow the patients closely, every 3–6 months, measuring the amount of paraprotein; malignant cases show a progressive increase, whereas in benign cases the levels remain stable. Patients with benign gammopathy have to be observed at least yearly after the first 2 years of follow-up, since there are documented cases of malignant evolution after 5 or more years of “benign” behavior.

Table 27.2 Laboratory Features Proposed for Differentiation Between Malignant and Idiopathic Monoclonal Gammopathies

Feature	Benign	Malignant
Paraprotein	Complete molecule; little or no Bence Jones protein	Bence Jones proteinuria >0.6 g/day
Normal immunoglobulins	Conserved	Depressed
Serum paraprotein	<1 g/100 mL	>1 g/100 mL
Serum albumin	>3 g/100 mL	<3 g/100 mL
Hemoglobin	>10 g/100 mL	<10 g/100 mL
Serum urea	<80 mg/100 mL	>80 mg/100 mL
Serum β_2 -microglobulin	<700 μ g/100 mL	>700 μ g/100 mL
Nonspecific proteinuria	Absent	Present
Numbers of B cells in peripheral blood	Normal	Decreased
Labeling index	Normal	Increased

4. Waldenström's Macroglobulinemia

Waldenström's macroglobulinemia, a malignancy of lympho-plasmacytoid cells associated with increased levels of macroglobulins, was first described by a Swedish physician, Dr. Jan Waldenström. The macroglobulins were later defined as IgM monoclonal proteins. Thus, the diagnosis of Waldenström's macroglobulinemia requires proof of the existence of a monoclonal IgM protein in the patient's serum.

Clinical features. Waldenström's macroglobulinemia is clinically characterized by a constellation of symptoms that include weakness and anemia, hyperviscosity-related symptoms (Table 27.1), diffuse osteoporosis, hepatomegaly, splenomegaly, and lymphadenopathy.

Symptoms suggestive of multiple myeloma, such as bone pain or "spontaneous" fractures, are rare. The immunosuppression is also milder than in multiple myeloma. Hypercalcemia, leukopenia, thrombocytopenia, and azotemia are rarely seen. Renal insufficiency, when present, is usually a manifestation of serum hyperviscosity and can be reversed by plasmapheresis and/or peritoneal dialysis.

Diagnosis. The two main diagnostic features of Waldenström's macroglobulinemia are the presence of an IgM monoclonal protein and the pleomorphic infiltration of the bone marrow with plasma cells, lymphocytes, and lympho-plasmacytic cells.

Management. Waldenström's macroglobulinemia is a disease of old age and frequently follows a benign course. The most common life-threatening complications result from serum hyperviscosity. In such cases, repeated plasmapheresis is often sufficient to keep the patient asymptomatic, avoiding the use of cytotoxic drugs and their side effects. Cytotoxic therapy may be required, due to the severity of the symptoms or the impossibility of keeping the patient on repeated plasmapheresis. Chlorambucil (leukeran) is the drug of choice, usually given in a continuous low dosage.

5. The Heavy-Chain Diseases

Some B-cell dyscrasias are associated with the exclusive production of heavy chains (or fragments thereof) or with the synthesis of abnormal heavy chains that are not assembled as complete immunoglobulin molecules and are excreted as free heavy chains. Both types of abnormality can be on the basis of a heavy-chain disease. The heavy-chain diseases are classified according to the isotype of the abnormal heavy chain as γ , α , μ , and δ (one single case of δ chain disease has been reported, and ϵ chain disease has yet to be described).

α -Chain Disease. This is the most common and best defined heavy-chain disease. It affects patients in all age groups, even children, and is more frequent in the Mediterranean countries, particularly affecting individuals of Jewish or Arab ancestry.

Clinically it is indistinguishable from the so-called Mediterranean-type abdominal lymphoma, characterized by diarrhea and malabsorption unresponsive to gluten withdrawal, with progressive wasting and death. Intestinal x-ray changes are suggestive of diffuse infiltration of the small intestine such as thickened mucosal folds. Intestinal biopsy reveals diffuse infiltration of the submucosa by reticulo-lymphocytic cells.

Diagnosis relies on the demonstration of free alpha chains, usually in serum. Routine electrophoresis usually fails to show a monoclonal component, but immunoelectrophoresis shows an abnormal IgA arc that does not react with antisera specific for light chains

γ -Chain Disease. This was the first form of heavy-chain disease discovered. Clinically, it appears as a lymphoma with lymphadenopathy, splenomegaly, and hepatomegaly. Bone marrow and lymph node biopsies show lympho-plasmocytic proliferation. The diag-

nosis is based on the immunochemical demonstration of free γ chains in the serum and/or urine.

μ -Chain Disease. This variant of heavy-chain disease is less frequent than either γ or α heavy-chain diseases, and clinically it is indistinguishable from chronic lymphocytic leukemia or lymphocytic lymphoma, with marked Bence Jones proteinuria and small amounts of free μ chains detectable in the serum and sometimes also in the urine.

Case 27.1 Revisited

The history of progressive weakness, malaise, fatigue, with shortness of breath after climbing one flight of stairs in 55-year-old woman is suggestive of anemia, supported by the observation of pale conjunctival mucosae. The anemia of multiple myeloma has an obscure etiology and is neither hemolytic nor secondary to iron deficiency.

Progressive loss of vision with bilateral retinal changes (irregularly dilated, tortuous veins, with flame-shaped retinal hemorrhages and "cotton wool" exudates) is very suggestive of serum hyperviscosity, which is also associated with increased bleeding tendencies. Serum hyperviscosity causes venous stasis with exudation and bleeding in the retinal capillaries, which leads to progressive vision impairment.

In a patient with serum hyperviscosity, the main differential diagnosis is between multiple myeloma and Waldenström's macroglobulinemia, since this last disease is frequently associated with the hyperviscosity syndrome. The finding of osteolytic lesions, a very high level of IgA and low IgM strongly indicate multiple myeloma as the most likely diagnosis. Additional laboratory tests in this patient revealed a monoclonal protein of gamma mobility, characterized as predominantly polymeric IgA, normal urine proteins, a serum viscosity of 13.2 relative to distilled water (normal <2), and extensive plasma cell infiltrates in the bone marrow. All these findings were compatible with the diagnosis of multiple myeloma and hyperviscosity syndrome.

The patient was treated with plasmapheresis (two to three sessions a week in each of which 300–500 mL of plasma were exchanged) and cyclophosphamide. A marked clinical improvement of all symptoms related to serum hyperviscosity was seen soon after plasmapheresis was initiated, and repeated measurements of serum viscosity showed normalization after one month of combined therapy. After 1 1/2 months of combined therapy, plasmapheresis was stopped and the patient continued to be treated with cyclophosphamide. Fundoscopy revealed normalization of the retina after 5 months of treatment.

III. LEUKEMIAS AND LYMPHOMAS

A. Nomenclature

The malignant proliferation of leukocytes can be classified by a variety of criteria. One first important distinction is made between leukemia and lymphoma.

Leukemia refers to any malignant proliferation of leukocytes in which the abnormal cell population can be easily detected in the peripheral blood and in the bone marrow. Leukemias may involve any type of hematopoietic cell, including granulocytes, red cells, and platelets. Leukemias are often classified as acute or chronic, based on their clinical evolution and morphological characteristics that are closely related.

Acute leukemias follow a very rapid progression towards death if left untreated. Many immature and atypical cells can be seen in the peripheral blood of patients with acute

leukemias. Chronic leukemias have a more protracted evolution; differentiated cells predominate in the peripheral blood of patients with chronic leukemia.

Leukemic states may evolve from a chronic form to an acute disease, and the type of proliferating cell may also change during the course of the disease. For example, transition from a chronic granulocytic stage to an acute and very often fatal lymphoblastic leukemia is characteristic of chronic myelocytic leukemia.

Lymphoma refers to localized lymphocyte malignancies, often forming solid tumors, predominantly affecting the lymph nodes and other lymphoid organs. Lymphomas are always lymphocytic malignancies.

B. Classification

All malignant proliferations of cells identifiable as lymphocytes are classified as either T- or B-cell malignancies, based on a variety of characteristics:

- Identification of the malignant cells as immunoglobulin-producing cells allows their classification as B-cell malignancies.

- Cell membrane markers are widely used to classify malignant lymphocyte proliferations.

- Molecular genetic procedures may be used to determine whether the heavy-chain genes or the T-cell-receptor genes are rearranged in a malignant lymphocyte population.

Case 27.2

A 48-year-old black male who worked as a graphic designer emigrated from Jamaica 33 years ago. He was referred to the dermatology clinic of the university hospital for investigation of an atypical dermatitis, fever, and nonproductive cough. His main complaint was of a progressive skin rash that his family doctor did not know how to manage. The patient claimed that he noticed the first skin lesions 3 months earlier and started coughing more than usual 2 weeks prior to the time he sought medical attention. He also referred a weight loss of 19 lb. in 2 months. The erythematous lesions initially were very small and barely noticeable but had been spreading very fast during the last 2 weeks. Physical examination showed an underweight male in no acute distress. Blood pressure was 136/65, pulse 98/min., respiration 30/min., temperature 101.9°F (38.3°C). A generalized skin rash sparing very few areas of the body was seen. The skin was red, thickened, and infiltrated, feeling like cardboard at the touch. In addition, two skin ulcers were seen. One, on the forearm, had an approximate diameter of 1 inch and the second, on the lateral aspect of his right thigh, was larger, with a diameter of 2.5 inches. During physical examination, it was noted that pressure of the sixth and seventh ribs, on the right side, caused severe pain. On questioning about the chest pain, the patient referred that it had started suddenly 2 days earlier, when he was trying to lift a suitcase. He also noticed that after that, coughing caused pain. Two lymph nodes the size of a cherry were felt on the right side of the neck, four lymph nodes were felt in the left axilla (the largest about 1 inch in diameter), and three smaller nodes were felt in the right axilla. All nodes were firm, smooth, nontender, and mobile under the skin. Diffuse rhonchi were audible in both lungs. The liver was nontender and palpated 3 inches below the costal margin. The rest of the examination was normal. A chest x-ray showed bilateral diffuse interstitial infiltrates, severe osteoporosis of the ribs and vertebrae, and a fracture of the 6th and 7th ribs on the right. A CBC and differential

revealed (normal values in parentheses) $RBC = 2.9 \times 10^6/\mu L$ ($4.4\text{--}5.5 \times 10^6/\mu L$), hemoglobin of 7.3 g/dL (13.3–16.0 g/dL), WBC of 23,000 μL ($4.0\text{--}10.5 \times 10^3/\mu L$) with 37% lymphocytes (20–45%). Lymphocyte subpopulations were as follows: $CD3^+$: 86% ($60 \pm 10\%$); $CD4^+$: 88% ($40 \pm 10\%$); $CD8^+$: 12% ($15 \pm 10\%$); $CD1^+$: 0% (0%); Tdt^+ : 0% (0%); $CD25^+$: 28% (<1%); $CD4, CD25^+$: 26% (<1%). Serum calcium was 2.2 mg/dL (8.5–10.6 mg/dL). Serum immunoglobulins: IgG: 500 mg/dL (600–1300); IgA: 48 mg/dL (60–300); IgM: 21 mg/dL (30–150).

This case raises several questions:

What is the most likely diagnosis?

What test should be done to confirm the most likely diagnosis?

What is the nature of the patient's skin rash?

Why did the patient develop rib fractures with minimal trauma?

What is the meaning of the large percentage of $CD25^+$ cells?

What is the meaning of the bilateral diffuse interstitial infiltrates seen on the chest x-ray?

C. Chronic Lymphocytic Leukemia

Chronic lymphocytic leukemia is, in the vast majority of cases, a B-cell malignancy and has many features in common with Waldenström's macroglobulinemia: it is a disease of old age, often with a relatively benign course. Central to its pathogenesis seems to be an overexpression of the *bcl-2* gene, which inhibits apoptosis.

Clinical symptoms are often absent or very mild. Malaise, fatigue, or enlargement of the lymphoid tissues felt by the patient are the most frequent presenting complaints. Physical diagnosis shows enlargement of the lymph nodes, spleen, and liver. Viral infections, such as herpes and herpes zoster, and fungal infections are frequent in these patients, pointing to a T-cell deficiency, which is confirmed by the finding of reduced numbers of T cells and reduced responses to T-cell mitogens. The prognosis is determined by the frequency of severe opportunistic infections.

Diagnosis requires confirmation of the lymphocytic nature of the proliferating cells. This can be done by conventional morphology, but to prove that the proliferating cells are B lymphocytes, additional tests are required, such as:

Detection of monoclonal immunoglobulins in serum and/or urine. Bence Jones proteins can be detected in the concentrated urine of approximately one third of the patients. Rarely, IgM monoclonal proteins may be detected in serum. Most patients are hypogammaglobulinemic.

Detection of cell-associated immunoglobulins. About 98% of the patients carry monoclonal IgM on the membrane of the leukemic cells. In some cases, cytoplasmic retention of immunoglobulins can also be demonstrated.

Identification of B-cell membrane markers. The membrane markers of the leukemic cells are identical to those of mature B cells, with the following exceptions: CD11a/18 and CD22 are not expressed, while CD5 (see Chapter 10) is expressed in over 85% of the cases.

C. Hairy Cell Leukemia

Hairy cell leukemia is a malignancy of uncertain classification, predominantly affecting elderly males. The clinical presentation is nonspecific, and includes malaise, fatigue, and

frequent infectious episodes. The physical examination usually shows splenomegaly and sometimes generalized lymphadenopathy. The diagnosis is based on the finding of atypical lymphocytes with numerous finger-like (or hairy) projections in the peripheral blood defining the disease (which derives its name from the morphological characteristics of the abnormal lymphocytes). The abnormal cells have mixed characteristics. On the one hand they express membrane immunoglobulins, often of several isotypes, and synthesize monotypic heavy and light chains, suggesting a B-lymphocyte origin. However, after mitogenic stimulation, the abnormal lymphocytes may express the CD2 and CD3 membrane markers characteristic of T lymphocytes. On the other hand, they have monocyte/macrophage functions and markers including phagocytic properties, the ability to produce and release lysozyme and peroxidase, and the presence of intracellular tartrate-resistant acid phosphatase. These findings have been interpreted as indicating the proliferation of B-cell precursor cells sharing monocytic and T-cell markers and functions, malignant chimeric cells with multiple lineages, or malignant lymphocytes with aberrant gene expression. Without additional data it is impossible to decide which of these possibilities is more likely to reflect accurately the nature of the malignant proliferation in this type of leukemia.

Interferon- α is therapeutically useful (sometimes inducing permanent remissions) in hairy cell leukemia. This seems to result from a direct antiproliferative effect that is attributed to the ability of interferon- α to promote redifferentiation of malignant cells, stopping their uncontrolled multiplication.

D. Acute Lymphocytic Leukemias

Acute lymphocytic leukemias are those acute leukemias in which the malignant cells seen in the peripheral blood are immature lymphocytes (lymphoblasts). These leukemias usually have a very poor prognosis. Death usually occurs as a consequence of the massive lymphocytic proliferation in the bone marrow, where the proliferating cells overwhelm and smother the normal hematopoietic cells.

1. Classification

With the introduction of monoclonal antibodies directed against T- and B-cell markers, it was determined that the large majority (about 95%) of acute lymphocytic leukemia are B-cell-derived because the proliferating cells express the CD19 and CD20 B cell markers. The remaining 5% of these leukemias are of the T-cell type.

2. Enzymatic Markers of Acute Lymphocytic Leukemia

The expression of enzymes of the purine salvage pathway is altered in acute lymphocytic leukemia. Adenosine deaminase (ADA) is often overexpressed. In patients with increased ADA, 2-deoxycorformycin, a drug that specifically inhibits ADA, has remarkable therapeutic effects. Terminal deoxynucleotidyl transferase (Tdt) is not expressed by adult lymphocytes but is reexpressed by about 80% of all cases of this type of leukemia; it constitutes a useful marker because its levels fall during remission and increase again before a clinically apparent relapse.

3. B-Cell Acute Lymphocytic Leukemia

In most cases the malignant cells do not express membrane immunoglobulins, do not have intracellular immunoglobulins, have rearranged heavy-chain genes, and express the com-

mon acute lymphocytic leukemia antigen (CALLA). CALLA is present in the majority of non-T, non-B acute lymphocytic leukemia lymphocytes, almost always expressed in association with a B-cell marker such as the CD19 or CD20 antigen. CALLA is also expressed by the lymphoblasts seen during the blastic crisis of patients with chronic myelocytic leukemia (CML); these lymphoblasts also express B-cell markers such as the CD20 antigen, establishing their identity as B-cell precursors. When the blast cells seen in the blastic crisis of a patient with CML are CALLA⁺ and CD20⁺, the crisis responds well to chemotherapy; when none of these markers is expressed, survival is limited to a few days. In acute lymphocytic leukemia CALLA positivity identifies patients with a more favorable prognosis. On the other hand, acute lymphocytic leukemia in which the leukemic cells express membrane or cytoplasmic immunoglobulins has very poor prognosis, and patients survive less than a year unless very aggressively treated.

Monoclonal anti-CALLA antibodies have been used therapeutically in acute lymphocytic leukemia with disappointing results. A sharp decrease in leukemic cell counts is observed after administration of antibody, but this effect is usually of short duration since the CALLA⁺ lymphocytic population is soon replaced by a CALLA⁻ population (antigenic modulation) not affected by further administration of antibody. Also, the prolonged administration of monoclonal anti-CALLA of murine origin leads to the development of antimouse immunoglobulin antibodies, which cause rapid elimination of anti-CALLA antibodies from the patient's circulation and may also cause serum sickness.

4. T-Cell Acute Lymphocytic Leukemia

This type of leukemia usually has a worse prognosis than B-cell acute lymphocytic leukemia (patients with T-cell acute lymphocytic leukemia have a less than 20% probability of remaining in remission for more than 2 years). Chromosomal abnormalities involving the T-cell receptor genes have been observed in at least 40% of the T-cell leukemias. One of the most frequent is a translocation of the area of chromosome 14, which carries the α gene of the T-cell receptor to the area of chromosome 8, which has the *c-myc* gene. Equally frequent is a translocation of the area of chromosome 7 that contains the β chain of the T cell receptor to chromosome.

Three distinct subgroups of leukemic processes can be defined in the group of T-cell acute lymphocytic leukemia depending on the expression of T-cell membrane markers (Table 27.3):

1. The first and largest group includes cases in which the proliferating T cells express the CD5 and CD2 markers. The malignant cell is, therefore, an early T-cell

Table 27.3 Classification of T-Cell Acute Lymphocytic Leukemia According to Membrane-Associated Markers Recognized by Monoclonal Antibodies

Patient group	Marker					
	CD5	CD2	CD3	CD4	CD8	CD1
1	+	+	-	-	-	-
2	+	+	+	+ ^a	+ ^a	+
3	+	+	+	+ ^b	+ ^b	-

^a CD4 and CD8 are co-expressed by the malignant cells.

^b The malignant cells express *either* CD4 *or* CD8, but not both.

precursor that mutated before the full rearrangement of the T-cell receptor genes so that the CD3 molecule is not expressed.

2. The second group is constituted by cases in which the proliferating cells have reached a later stage of T-cell differentiation. The malignant cells express CD3, co-express both CD4 and CD8 markers, and are also positive for the CD1 marker, indicating an aberrant reversal of a partially differentiated T lymphocyte to an earlier ontogenic stage.
3. The third group is constituted by cases with proliferating mature T cells, sharing markers (CD4 or CD8, in association with both CD2 and CD3) with the lymphocytes normally found in the peripheral blood and lymphoid organs.

Because of the relative rarity of T-cell acute lymphocytic leukemia, it has not yet been possible to establish whether any of the subgroups of this disease has a worse prognosis than that of T-cell acute lymphocytic leukemia in general.

5. *T-Cell Leukemia Associated to HTLV-I*

This type of T-cell leukemia has a very unique geographic distribution, closely associated to the first identified human retrovirus (Human T-cell lymphotropic virus-I, or HTLV-I), which is very prevalent in Japan and the Caribbean basin (where the rates of infection reach endemic proportions); the virus has also been reported, although with lower frequency, in the southern United States.

HTLV-I-associated T-cell leukemia develops 10–20 years after infection with the virus. This very long latency period and the fact that T-acute lymphocytic leukemia is only seen in a fraction of the HTLV-I-infected individuals (4–5% of the seropositive individuals) suggests that malignant transformation does not result exclusively from the viral infection. However, the nature of the additional cofactors leading to leukemic transformation is unknown.

HTLV-I is an exogenous retrovirus, fully able to replicate and to be transmitted horizontally. Its genome contains a transforming gene, *tax*, whose gene product modifies the nuclear binding protein NF κ B, leading to the permanent overexpression of IL-2 receptors (CD25) in the infected cells. This has several consequences:

1. This type of T-cell leukemia is easily distinguishable by the fact that the proliferating cells are easily labeled with anti-CD25 monoclonal antibodies.
2. IL-2 stimulates the growth of the leukemic T cells in long-term culture.
3. Some patients have malignant T cells that not only express CD25 but also release high concentrations of IL-2, leading to an autocrine circuit of T-cell proliferation.
4. Other interleukin-coding genes are also activated, including the one coding for IL-1 β , which directly or indirectly causes osteoclast activation. As a consequence of osteoclast activation, bone resorption and hypercalcemia are prominent in these patients.

Secondary immunosuppression may develop in patients with HTLV-I leukemia. Several factors contribute to the state of immunosuppression. IL-2 receptors are shed from the membrane of the leukemic cells and can be detected in high concentrations in the circulation. Soluble IL-2 receptors diffuse into the extracellular spaces and adsorb the IL-2 that is necessary for the activation of normal T cells, causing a functional deficiency of this interleukin. In addition, The proliferating CD4⁺ cells function as suppressor-inducers and turn on cells with suppressor activity.

Clinical presentations include skin and bone changes. On the skin, erythroderma and skin ulceration are the most common manifestations and are associated with a dense lymphocytic infiltration of the dermis and epidermis. It is believed that increased venous permeability, probably caused by an increased local concentration of IL-2 and other interleukins, are responsible for the formation of cellular infiltrates, which, in turn, interfere with proper oxygenation of tissues, leading to localized ischemia and necrosis. Osteoclast activation causes excessive bone resorption leading to hypercalcemia, and spontaneous fractures may develop. Reflecting the state of immunodeficiency common in these patients, opportunistic infections involving organisms such as *Pneumocystis carinii* pneumonia are relatively frequent.

6. Other HTLV-I-Related Lymphomas

Sézary Syndrome and mycosis fungoides are cutaneous T-cell lymphomas that have also been related to HTLV-I infection.

Sézary syndrome is an exfoliative erythroderma with generalized lymphadenopathy and circulating atypical cells with a characteristic multilobulated nucleus (Sézary cells). The skin is the original site of malignant cell proliferation, and the phase of cutaneous lymphoma can last many years with little evidence of extracutaneous dissemination. The leukemic evolution is associated with the invasion of the peripheral by malignant cells. The malignant cells infiltrating the skin or circulating in the blood are CD4⁺ and behave functionally as helper T cells when mixed in vitro with T-cell-depleted lymphocytes from a normal donor and antigenically stimulated.

Mycosis fungoides is clinically similar to the cutaneous phase of the Sézary syndrome, and the infiltrating cells in the skin are also CD4⁺. No leukemic stage seems to develop in patients afflicted with the disease. However, the lymphocytes from patients with mycosis fungoides suppress the response of normal allogeneic T and B cells.

7. Epstein-Barr Virus-Associated B-Cell Lymphomas

Burkitt's Lymphoma. Burkitt's lymphoma (BL), endemic in certain areas of Africa and sporadic in the United States, has been characterized as a B-cell lymphoma expressing monotypic surface IgM. Burkitt's lymphoma is epidemiologically linked to infection of the B lymphocytes with the Epstein-Barr virus (EBV). The malignant B cells in BL usually express a single EBV gene product, the nuclear antigen EBNA-1, which is essential for establishment of latency, but has no known transforming properties. It is possible that the EBV infection has as its main role promoting a state of active B-cell proliferation that may favor the occurrence of the translocations involving the region of chromosome 8 coding for *c-myc*.

B-Cell Lymphomas in Immunocompromised Patients. B-cell lymphomas are frequently detected in immunodeficient or iatrogenically immunosuppressed patients, and in almost all cases there is evidence of association with EBV. In those cases, a variety of viral-coded proteins are expressed on the malignant cells, including six different nuclear antigens and three different membrane proteins. Of the proteins coded by nuclear antigens, EBNA-2 protein has immortalizing properties, transactivating the cyclin-2 gene and others, EBNA-LP impairs the function of the products of two tumor-suppressor genes, p53 and the retinoblastoma gene product, and the latent membrane protein 1 (LMP-1) is considered as a transforming gene whose activity seems to be mediated by the activation of a Ca²⁺/calmodulin-dependent protein kinase.

Hodgkin's Disease. EBV genomes and gene products can be detected in a significant number of Hodgkin's disease lymph node biopsies. More significant is the fact that LMP-1 is among the expressed proteins.

Case 27.2 Revisited

The presentation of a native of the Caribbean basin with an erythematous-ulcerative skin rash, pneumonia, and leukocytosis with a marked increase of the CD4 population and of double staining CD4-CD25 lymphocytes, with osteoporosis and hypercalcemia, is typical for an HTLV-I-associated T-cell leukemia.

The most informative test from the diagnostic point of view would be a serological assay for anti-HTLV-I antibodies, which was positive in this patient. In addition, biopsies of the ulcerative skin lesions and enlarged lymph nodes were compatible with lymphoma. The cells infiltrating the biopsed lymph node were identified as CD4⁺, CD25⁺. Peripheral blood lymphocytes showed a vigorous mitogenic response to IL-2, circulating levels of soluble IL-2 receptors were high (1000 IU/mL, normal < 277 U/mL), and the blood levels of parathormone were normal.

The skin rash was due to a dense lymphocytic infiltration of the dermis and epidermis, secondary to increased venous permeability, probably caused by elevated local concentrations of IL-2 and other interleukins. The intense cellular infiltrate interferes with proper oxygenation of tissues, and the resulting ischemia leads to localized necrosis.

Transformed CD4⁺ cells produce IL-1 β and other less well-defined mediators that activate osteoclasts, and induce bone resorption and hypercalcemia. Because of the loss of calcium the bones become fragile and may break with minimal trauma.

ATLL is a malignancy of mature CD3⁺, CD4⁺ T cells caused by the HTLV-I virus. The virus has a transforming gene (tax), which becomes overexpressed, and the protein coded by that gene modifies cellular transactivating proteins, such as NF κ B, increasing their activity. As a consequence, the transformed cells overexpress IL-2 receptors and are able to proliferate spontaneously by using their own IL-2 (whose synthesis is also enhanced by the tax gene product) as a growth factor.

*The bilateral interstitial infiltrates suggest a pneumonitic process, which could be due to viruses or fungi, such as *Pneumocystis carinii*. *P. carinii* is one of the most prevalent causes of opportunistic pneumonia in immunocompromised individuals. This patient was immunocompromised, as shown by his very low levels of circulating immunoglobulins. In addition, lymphocyte mitogenic responses to PHA and ConA were depressed, revealing a functional impairment of cell-mediated immunity. Examination of a broncho-alveolar lavage sample was positive for the typical silver-staining cysts of *P. carinii*.*

SELF-EVALUATION

Questions

Choose the one *best* answer.

- 27.1 HTLV-I induces a T-cell leukemia in which the proliferating cells permanently overexpress:
- c-myc* mRNA
 - CALLA antigen
 - CD5
 - CD25
 - Terminal deoxynucleotidyl transferase (Tdt)

- 27.2 Which of the following is the most common immune abnormality in patients with chronic lymphocytic leukemia?
- A. Bence-Jones proteinuria
 - B. Expansion of CALLA⁺ T lymphocytes
 - C. High levels of free IL-2 receptors in circulation
 - D. IgM gammopathy
 - E. Low levels of serum immunoglobulins
- 27.3 Which of the following lymphocytic malignancies is the result of uncontrolled expansion of transformed T lymphocytes?
- A. Acute lymphocytic leukemia
 - B. Burkitt's lymphoma
 - C. Chronic lymphocytic leukemia
 - D. Hairy cell leukemia
 - E. Sézary syndrome
- 27.4 What is the diagnostic significance of the finding of Bence Jones protein in the urine?
- A. None
 - B. Rules out a diagnosis of benign gammopathy
 - C. The patient has a B-cell dyscrasia
 - D. The patient has a nonsecretory forms of multiple myeloma
 - E. The patient must have multiple myeloma
- 27.5 What is the diagnostic significance of the finding of a polyclonal increase of serum immunoglobulins?
- A. A diagnosis of B-cell dyscrasia can be ruled out.
 - B. A diagnosis of multiple myeloma can be ruled out.
 - C. In a patient with multiple myeloma this is a good prognosis indicator.
 - D. The patient may have Waldenström's macroglobulinemia.
 - E. The patient may suffer from one of the heavy-chain diseases.
- 27.6 Which of the following is associated with poor prognosis in a patient with acute B-cell lymphocytic leukemia?
- A. 8:14 chromosomal translocation
 - B. Expression of the CALLA antigen
 - C. Expression of the CD5 marker
 - D. Expression of the CD19 marker
 - E. Positive staining for intracytoplasmic immunoglobulins
- 27.7 The distinction between multiple myeloma and reactive plasmocytosis can be readily based on the:
- A. Characterization of the gammopathy as monoclonal or polyclonal
 - B. Levels of serum immunoglobulins
 - C. Number of plasma cells in the bone marrow
 - D. Quantitative assay of light chains in the urine
 - E. Results of a skeletal x-ray survey
- 27.8 The most reliable criterion for differentiation between benign and malignant B-cell dyscrasias is:
- A. Age of the patient
 - B. Levels of normal immunoglobulins
 - C. Levels of serum albumin, hemoglobin, and urea
 - D. Presence of Bence Jones proteinuria
 - E. Progressive increase of paraprotein levels

- 27.9 Which of the following would be an unexpected finding in Waldenström's macroglobulinemia?
- Anemia
 - Hypercalcemia
 - Increased numbers of plasma cells, lymphocytes, and lympho-plasmacytic blastic forms in the bone marrow
 - Increased serum viscosity
 - Normal or near-normal levels of IgG
- 27.10 A 59-year-old man has been complaining of weakness, repeated pulmonary infections, and "rheumatic" pains for 2 years. He has been hospitalized because he broke his right humerus falling from a chair. Serum immunoglobulins are: IgG: 600 mg/100 mL; IgA: 450 mg/100 mL; IgM: 200 mg/100 mL. The patient eliminates 2 g of protein daily in the urine. Which of the following tests will be most useful for diagnosis?
- Determination of serum viscosity
 - Quantitative assay of urinary light chains
 - Serum calcium levels
 - Serum electrophoresis and/or immunoblotting
 - Urine electrophoresis and/or immunoblotting

Answers

- 27.1 (D) In individuals with HTLV-I, the leukemic process is characterized by the permanent expression of the IL-2 receptor (CD25).
- 27.2 (E) Most patients are hypogammaglobulinemic. Bence Jones proteinuria is detected in about one third of the patients, but IgM monoclonal proteins are detected very rarely. The transformed lymphocytes are of the B lineage and express CD5, but not CALLA. High levels of soluble IL-2 receptors are seen in HTLV-I-associated T-cell leukemia, but not in chronic lymphocytic leukemia.
- 27.3 (E) The Sézary syndrome is a malignancy of helper T cells.
- 27.4 (C) Bence Jones proteinuria is most often associated with multiple myeloma but can also be seen in patients with other types of B-cell malignancies and even in patients without evidence of malignant B-cell proliferation. But it can always be considered as proof of the existence of a B-cell dyscrasia.
- 27.5 (B) In some cases of lymphocytic lymphoma, a malignant, monoclonal, B-cell proliferation may exist in association with a reactive plasmacytosis leading to the simultaneous presence of a monoclonal protein and polyclonal hypergammaglobulinemia. This is not seen in multiple myeloma, in which the residual nonmonoclonal immunoglobulins are always normal or reduced in their levels.
- 27.6 (E)
- 27.7 (A) Reactive plasmacytosis is associated with polyclonal gammopathy while multiple myeloma is characterized by a monoclonal gammopathy. The numbers of plasma cells in the bone marrow can be identical in both cases, and even atypical forms can be seen in patients with reactive plasmacytosis. A skeletal x-ray survey may be normal or show

- nonspecific osteoporosis in patients with multiple myeloma, and the finding of osteolytic bone lesions is not unique to multiple myeloma.
- 27.8 (E) No other parameter is as reliable.
- 27.9 (B) Hypercalcemia is usually seen in multiple myeloma, as a consequence of disseminated osteolysis; in Waldenström's macroglobulinemia there is as a rule no appreciable increase of serum calcium.
- 27.10 (E) Since the serum appears not to contain a monoclonal protein (normal to low-normal immunoglobulin levels), but proteinuria is definitely increased, the best approach would be to characterize the urinary proteins, looking for a Bence Jones protein. The quantitative assay of light chains in the urine is not as reliable as the characterization of the light chains as monoclonal by a combination of electrophoretic and immunochemical techniques.

BIBLIOGRAPHY

- Barlogie B., Jagannath, S., Vesole, D., et al. Autologous and allogeneic transplants for multiple myeloma. *Semin. Hematol.* 32:31, 1995.
- Bartl, R., Frisch, B., Diem, H., et al. Histologic, biochemical, and clinical parameters for monitoring multiple myeloma. *Cancer* 68:2241, 1991.
- Barton, B. E. IL-6: Insights into novel biological activities. *Clin. Immunol. Immunopath.* 85:16, 1997.
- Bataille, R. New insights in the clinical biology of multiple myeloma. *Semin. Hematol.* 34(Suppl. 1):23, 1997.
- Bataille, R., Chappard, D., Marcelli, C., et al. Recruitment of new osteoblasts and osteoclasts is the earliest critical event in the pathogenesis of human multiple myeloma. *J. Clin. Invest.* 88:62, 1991.
- Borden, E. C. Innovative treatment strategies for non-Hodgkin's lymphoma and multiple myeloma. *Semin. Oncol.* 21(Suppl. 14):14, 1994.
- Camilleri-Broet, S., Davi, F., Feuillard, J., et al. High expression of latent membrane protein 1 of Epstein-Barr virus and BCL-2 oncoprotein in acquired immunodeficiency syndrome-related primary brain lymphomas. *Blood* 86:432, 1995.
- Dimopoulos, M. A., and Alexanian R. Waldenström's macroglobulinemia. *Blood* 83:1452, 1994.
- Ferland, J. P., and Brouet, J. C. Marrow transplantation for myeloma. *Annu. Rev. Med.* 46:299, 1995.
- Jarrett, R. F. Viruses and Hodgkin's disease. *Leukemia* 7 (Suppl. 2):S78, 1993.
- Joshua, D. E., Brown, R. D., and Gibson, J. Prognostic factors in myeloma: What they tell us about the pathophysiology of the disease. *Leuk. Lymphoma* 15:375, 1994.
- Klein, B. Cytokine, cytokine receptors, transduction signals, and oncogenes in human multiple myeloma. *Semin. Hematol.* 32:4, 1995.
- Kyle, R. A. Newer approaches to the management of multiple myeloma. *Cancer* 72 (Suppl. 11):3489, 1993.
- Kyle, R. A. The monoclonal gammopathies. *Clin. Chem.* 40:2154, 1994.
- Niedobitek, G., Agathangelou, A., Rowe, M., et al. Heterogeneous expression of Epstein-Barr virus latent proteins in endemic Burkitt's lymphoma. *Blood* 86:659, 1995.
- Oken, M. M. Standard treatment for multiple myeloma. *Mayo Clin. Proc.* 69:781, 1994.
- Rozman, C., and Montserrat, E. Chronic lymphocytic leukemia. *N. Engl. J. Med.* 333:1052, 1995.
- Seymour, J. F. Malignancy-associated hypercalcemia. *Sci. Am. Sci. Med.* 2:48, 1995.

28

Diagnosis of Immunodeficiency Diseases

Gabriel Virella and John Sleasman

I. INTRODUCTION

Immunodeficiency diseases and syndromes are the cause of significant mortality and morbidity, as well as a source of extremely valuable information about the physiology of the human immune system. Most immunodeficient patients have secondary forms of immunodeficiency, caused either by pathological conditions that affect the immune system or by the administration of therapeutic compounds with immunosuppressive effects.

A functional defect of the immune system is suspected when a patient has unusual frequency of infections with common or opportunistic microorganisms, complications after the administration of attenuated vaccines (see Fig. 28.1), unusually severe infections, or failure to eradicate infections with antibiotics to which the microorganisms are sensitive.

A good history, careful work-up of the infectious episodes, and a thorough physical examination are essential for the initial evaluation of a suspected immunodeficiency, providing useful clues about the type of immunodeficiency (Table 28.1). Obtaining family history is equally important. Early death of older siblings suffering from repeated infectious episodes is often the only way to document the hereditary character of a congenital immunodeficiency.

Once an immunodeficiency is suspected, investigations need to be undertaken with the purpose of documenting the immunodeficiency state. Known causes of secondary immunodeficiency need to be ruled out (Table 28.2) and, if present, therapy will be directed at their elimination, whenever possible. If a diagnosis of primary immunodeficiency



Fig. 28.1 *Vaccinia gangrenosa* reaction in a 6-month old child with combined immunodeficiency. Note the extensive gangrenous and necrotic lesion with satellite poxes around the gangrenous lesion, which eventually spread to the face and buttocks. (Reproduced with permission from Good, R. A., et al., *Prog. Allergy* 6:187, 1962.)

ciency is made, it will be important to define the degree of compromise of the different mechanisms of immunological defense—cellular immunity, humoral immunity, phagocytosis, and complement in order to select the most effective type of therapy. Finally, the definitive diagnosis needs to be established, and in patients with primary immunodeficiency, this often involves identification of the genetic abnormality underlying the disease.

II. DIAGNOSTIC STUDIES

Investigation of an immunodeficiency is a step-by-step procedure in which tests are ordered to confirm clinical impressions or the results of previous tests. The initial evaluation may involve simple assays such as a white blood cell count with leukocyte differential, immunoglobulin assay, isohemagglutinin titers, lymphocyte subpopulation counts, an NBT test for phagocytic function, and a CH50 for complement activity. Depending on the results of this initial evaluation and on the clinical impression as to the nature of the immunodeficiency, further tests should be ordered so as to obtain the best possible definition of the nature and degree of immunodeficiency. The purpose of the evaluation is twofold: to learn more about the human immune system and to classify the immunodeficiency into a major category, if possible, to allow a more rational approach to therapy and long term management.

Table 28.1 Clues About the Nature of an Immunodeficiency Disease Derived from History, Physical Examination, and General Diagnostic Procedures

Predominant infections	Physical examination findings	Type of immunodeficiency
Repeated pyogenic infections (tonsillitis, otitis, pneumonia, disseminated impetigo)	Peripheral lymph nodes and tonsils are atrophic	B-lymphocyte deficiency
Severe mycotic infection; development of active infection after administration of a live virus vaccine		T-lymphocyte deficiency
Neonatal tetany with cardiac malformations, mongoloid facies, severe viral and mycotic infections	Lack of thymic shade on x-ray	DiGeorge syndrome
Abscess-forming infection with low-grade pathogens (<i>Staphylococcus epidermidis</i> , <i>Serratia marcescens</i> , <i>Aspergillus</i> sp.)	Scars from previous bone, liver, or soft tissue abscesses; draining lymphadenitis; hepatosplenomegaly	Neutrophil deficiency
Repeated infections with <i>Neisseria</i> sp.		Complement deficiency
Persistent infection of the lungs, diffuse mucosal moniliasis, chronic diarrhea, and wasting early in life	Growth retardation; other associated congenital abnormalities	Severe combined immunodeficiency

III. DIAGNOSTIC EVALUATION OF HUMORAL IMMUNITY

When a humoral immunodeficiency is suspected, it is usual to start with the simplest procedures and to proceed to more sensitive and complex tests as needed.

A. Quantitative Assay of Immunoglobulins and Antibodies

1. Determination of Serum Immunoglobulin Levels

This is the most frequently performed screening test for humoral immunity. Usually it is sufficient to assay the three major immunoglobulin classes (IgG, IgA, and IgM) since there is no proof that deficiencies of IgD or IgE might have any pathological consequences. However, in interpreting immunoglobulin levels in children, it is very important to remember that normal values vary with age, as shown in Table 28.3.

Table 28.2 Causes of Secondary Immunodeficiency

Malnutrition
Systemic disorders
Immunoglobulin hypercatabolism
Excessive loss of immunoglobulins
Renal insufficiency
Extensive burns
Drug-induced
Cytotoxic drugs
Glucocorticoids
Antimalarial agents
Captopril
Carbamazepine
Fenclonofac
Gold salts
Phenytoin
Sulfasalazine
Alcohol, cannabinoids, opiates
Surgery
Malignancies
B-cell and plasma cell malignancies
Immunodeficiency with thymoma
Non-Hodgkin's lymphoma
Infectious diseases
HIV
Congenital rubella
Congenital CMV infection
Congenital toxoplasmosis
Epstein-Barr virus

Table 28.3 Normal Values for Human Immunoglobulins^a

Age	IgG	IgA	IgM
Newborn	636–1606	0	6–25
1–2 months	250–900	1–53	20–87
4–6 months	196–558	4–73	27–100
10–12 months	294–1069	16–84	41–150
1–2 years	345–1210	14–106	43–173
3–4 year	440–1135	21–159	47–200
5–18 year	630–1280	33–200	48–207
8–10 year	608–1572	45–236	52–242
>10 yr.	639–1349	70–312	57–352

^a In mg/dL, as determined by immunonephelometry in the Department of Laboratory Medicine, Medical University of South Carolina.

Table 28.4 Ig Levels in Immune Deficiency^a

Patient	IgG	IgA	IgM	Interpretation
A	850	2.8	128	IgA deficiency
B	1990	39.4	145	IgA deficiency
C	131	28.2	Traces	Severe hypogammaglobulinemia
D	690	16.0	264	IgA deficiency
E	154	60.0	840	Hyper IgM syndrome

^a In mg/dL.

Immunoglobulin assay is a fundamental element in the classification of immunodeficiencies (Table 28.4). A quantitative depression of one or more of the three major immunoglobulin isotypes is considered as compatible with a diagnosis of humoral immunodeficiency. If all immunoglobulin classes are depressed, the condition is designated as hypogammaglobulinemia. If the depression is very severe and the combined levels of all three immunoglobulins are below 200 mg/dL, the patient is considered as having severe hypogammaglobulinemia or agammaglobulinemia. When only one or two immunoglobulin classes are depressed, we designate the condition as dysgammaglobulinemia.

IgG subclasses can also be quantitated, and the results of the assay may reveal subclass deficiencies. Total IgG concentration might be normal to slightly depressed, and one or two of the minor subclasses may be deficient. Particular attention has been given to IgG2 subclass deficiency, which may be associated to infections with bacteria with polysaccharide capsules.

2. Determination of Common Antibodies

Not infrequently the assay of serum immunoglobulins may fail to support a clinical diagnosis of humoral immunodeficiency. The next step may be the assay of antibodies that are found in most normal individuals, either as a result of normal exposure to the antigen or as a result of vaccination:

- Anti-A and anti-B isohemagglutinin titers
- Anti-streptolysin O titer
- Anti-tetanus toxoid antibody concentration
- Anti-*Haemophilus influenzae* polysaccharide antibody concentration
- Antibodies to common viruses (mumps, measles, polio)

Abnormally low levels of one or more of these antibodies will support a diagnosis of humoral immunodeficiency, providing that exposure to the corresponding antigens can be unquestionably documented. The determination of preformed antibodies to common organisms and agents used in routine immunizations is mainly indicative of past immunoreactivity and may not provide useful information in cases where the deficiency is more subtle or when the immunodeficiency is of recent onset, when the first function to be lost is the ability to mount a primary immune response.

3. Determination of Antibodies Against Infectious Agents Known to Infect the Patient

The need to identify the etiological agents in patients with recurrent and unusual infections cannot be overstressed. Besides providing very useful treatment for the selection of the

most adequate antimicrobial(s), it allows one to carry out the most informative test for the diagnosis of a humoral immunodeficiency, i.e., the assay of antibodies against the infectious agent. If the patient fails to produce antibodies, the diagnosis is obvious.

In some patients, all investigations might be inconclusive except for the measurement of antibodies to the infecting microorganism(s), which might reveal an "antigen-selective" immunodeficiency. Unfortunately, proper microbiological studies are seldom done in patients with suspected humoral immunodeficiency, and adequate assays for antibodies to some common organisms (e.g., staphylococci) are not commonly available.

4. *Quantitation of Antibodies After Antigenic Challenge*

This is the ideal approach to the investigation of the humoral immune response, since it determines very specifically the ability of the patient to sustain a functional antibody response after adequate challenge. This type of investigation can be carried out with two different perspectives:

1. To determine whether a patient is able to develop an immune response
2. To determine whether a patient can synthesize antibodies against a specific, infecting microorganism

The antigens chosen for this investigation should meet the following criteria: lack of risk for the patient; availability of techniques for the measurement of the corresponding antibodies; and adequacy of the antigen for the purpose in mind. For evaluation of primary immune responsiveness, for example, one needs to use an antigen to which the individual has never been exposed. In immunodeficient children for whom good records of previous immunizations and infections are available, any component or killed vaccine (never live attenuated) to which there has been no previous exposure can be used. That may not be possible if the child has been fully immunized. In that case, and in the case of most adults, proteins extracted from lower animals, such as keyhole limpet hemocyanin or bacteriophage, are the best alternatives.

Immunization with bacteriophage has been used extensively by some groups. Both the evolution of antibody levels (Fig. 28.2) and the clearance of the injected phage (significantly delayed in immunodeficiency patients) can be followed with very sensitive techniques to determine if antibodies are synthesized and whether or not there is an effective immune elimination of the bacteriophage. Phage immunization has been carried out by several groups in different countries and has been proven to be a harmless procedure. At this point, the main problem preventing the widespread use of this approach is the need for development of phage-inactivation assays for the measurement of the antiphage antibody response, which is beyond the capabilities of many clinical diagnostic laboratories.

The evaluation of the secondary immune response does not raise as many problems, but it is less informative, since the capacity to initiate a primary immune response seems to be the first (and sometimes the only) function affected by immunosuppressive agents or in diseases associated with immunosuppression. Diphtheria and tetanus toxoids are frequently used to assess the ability to mount a humoral response because these are strongly immunogenic proteins, their use has only minimal risk for the patient, and specific antibodies can be assayed by a variety of techniques, such as enzyme immunoassay.

Given the lack of information concerning normal values for these antibodies and the fact that the abnormality searched for is the lack of an active response rather than a low

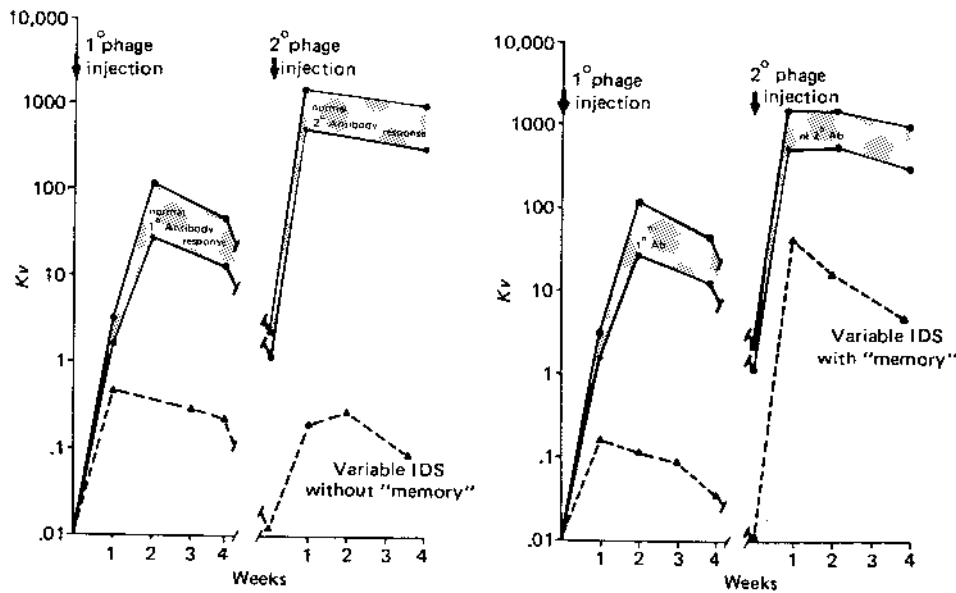

Fig. 28.2 Primary and secondary responses to bacteriophage ØX 174 in a patient with a variable immunodeficiency syndrome. The shaded area between the solid lines indicates the range for normal responses. The patient's response is the interrupted line. The patient studied on the left panel showed a definite but diminished antibody response; the secondary response was not greater than the primary—no memory/amplification occurred. The immunoglobulin class of antibody in both primary and secondary responses was entirely IgM. The patient studied on the right panel showed greater response to secondary immunization than to primary (memory/amplification) although both were diminished in comparison to the normal range. The immunoglobulin class of the secondary response was entirely IgM. (Reproduced with permission from Wedgewood, Ochs, and Davis, *Birth Defects: Original Article Series 11:331*, 1975.)

level of antibody, the best approach is to collect blood for baseline study prior to a booster with the corresponding antigen and repeat the study with a sample collected 2–3 weeks later. Following this protocol, we detected active responses in all but two of a group of children randomly selected from the population of a rural county of South Carolina (Fig. 28.3). The existence of normal nonresponders needs to be considered when evaluating a patient suspected of having an immunodeficiency.

An interesting example of the application of tetanus toxoid immunization is the follow-up of the immune response after a bone marrow graft. Patients receiving bone marrow grafts are given large doses of immunosuppressive drugs before the graft, hoping to avoid rejection, and continue to be immunosuppressed after the graft to avoid a graft-versus-host reaction (see Chapter 28). When the evolution of the patient is uneventful, the immunosuppressive drugs are stopped, and the patient is then immunized for tetanus toxoid to determine whether the immune system regains its ability to mount an active immune response. As illustrated in Figure 28.4, this recovery may only be observed several months after the suspension of immunosuppressive therapy. It needs to be noted that the immunoglobulin levels may be normal while the patient shows a complete lack of response to immunization.

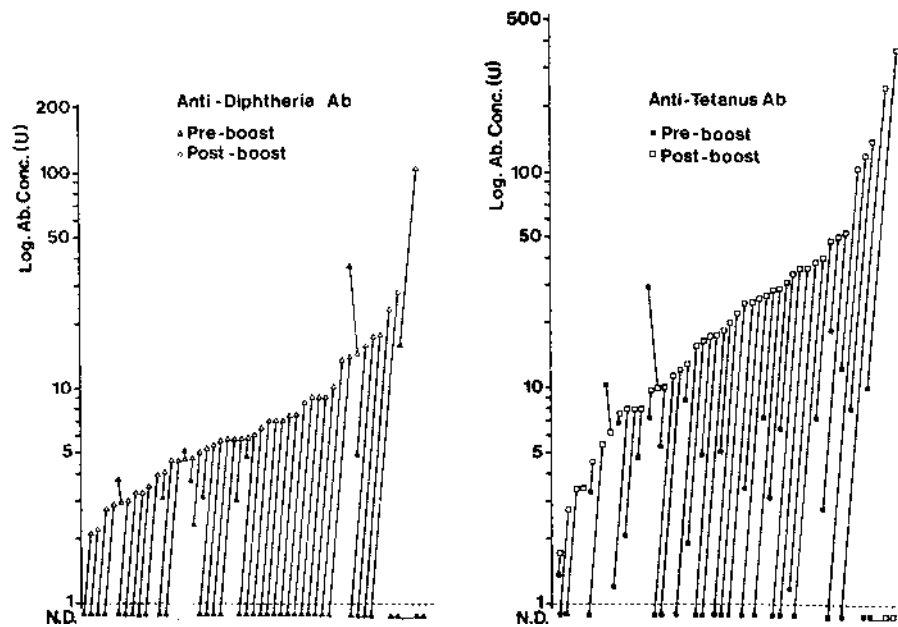

Fig. 28.3 Pre- and postboost antibody titers to diphtheria and tetanus toxoid determined in 46 healthy children between 16 and 33 months of age. (Reproduced with permission from Virella, G., Fudenberg, H. H., Kyong, C. U., Pandey, J. P., and Galbraith, R. M. *Z. Immunitätsforsch.* 155:80, 1978.)

Challenge with polysaccharide vaccines (such as the *Haemophilus influenzae* or the *Streptococcus pneumoniae* vaccines) will indicate whether a patient has the ability to develop an immune response to T-independent antigens. This is a possibility that needs to be specifically investigated in cases of Wiskott-Aldrich syndrome and of IgG₂ subclass deficiency, in which patients often show subnormal response to polysaccharides.

B. Analysis of B-Lymphocyte Membrane Markers

The finding of an immunoglobulin deficiency or of the inability to mount a humoral immune response does not give many clues as to the pathogenesis of the defect. Besides the possibility of dealing either with a primary or a secondary immunodeficiency, which implies the need to investigate known causes of secondary immunodeficiency, primary humoral immunodeficiencies may result from a variety of defects, such as absence or lack of differentiation of B cells, defects in intracellular synthesis, assembly, or secretion of immunoglobulins, hyperactivity of suppressor cells, deficient helper T-cell function, etc. (discussed in greater detail Chapter 29). One important parameter to determine is the distribution of lymphocyte subpopulations.

The number of B lymphocytes in the peripheral blood can be determined by counting peripheral blood lymphocytes with membrane immunoglobulins. Isolated mononuclear cells are incubated with fluorescein-labeled anti-immunoglobulin antibodies (aggregate-free or, preferably, F(ab')₂ fragments of antibodies recognizing light chains, common to all immunoglobulins). The actual counting of B lymphocytes can be done manually, using a fluorescence microscope, or by flow cytometry.

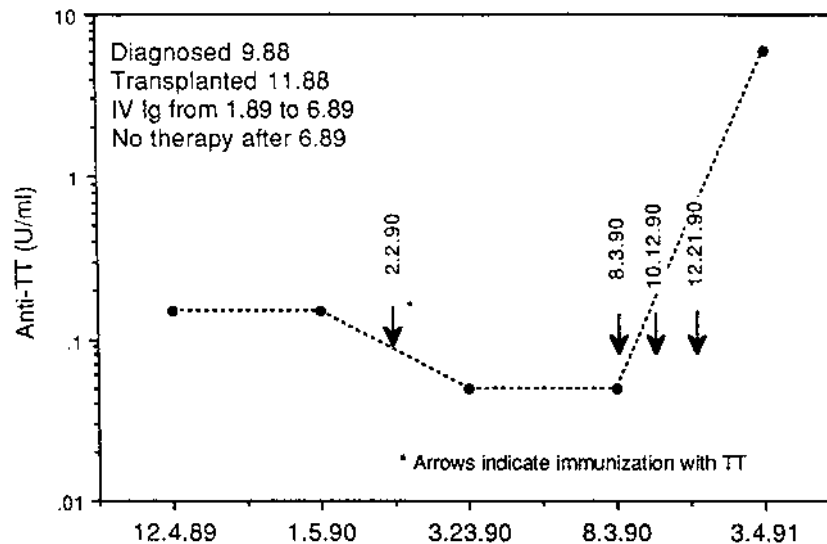

Fig. 28.4 Graphic representation of a longitudinal study of the serum levels of anti-tetanus toxoid (anti-TT) antibodies in a patient who received a bone marrow graft in December 1988. The patient received intravenous gammaglobulin from January to June 1989 as anti-infectious prophylaxis. The clinical evolution was excellent, and all therapy (immunosuppressive and immunoprophylactic) was discontinued in June 1989. The first assay of anti-TT antibody in December 1989 showed that the patient had low levels of antibody (0.15 U/mL). A first immunization with TT in February 1990 was followed by a paradoxical decrease of anti-TT antibody concentration. Only after three additional boosters were given between August and February of 1991 was there a significant increase in anti-TT antibody concentration. At that time, the patient could be judged as immunologically recovered.

With the introduction of monoclonal antibodies, the B-cell count is usually determined by calculating the percentage of peripheral blood lymphocytes with specific B-lymphocyte markers (CD19, CD20). The proportion of lymphocytes identifiable as B cells in the peripheral blood by such techniques is between 4 and 10%, corresponding to a range of 96–421 CD19⁺ cells/ μ L. If the number of B cells in the peripheral blood is significantly depressed, the immunodeficiency is most likely to result from lack of B-cell differentiation. Such lack of B-cell differentiation is the rule in infantile agammaglobulinemia (see Chapter 29).

The first technique to identify and enumerate B lymphocytes was based on the fact that these cells have immunoglobulin (Ig) molecules attached to their membranes. The assay is essentially based on the incubation of as described earlier in this chapter.

The number of CD4⁺ helper T lymphocytes in the peripheral blood is also a critical parameter that needs to be determined. Although the correspondence between membrane markers and function is not perfect, the enumeration of cells expressing CD4 is believed to be an adequate assessment of the number of helper T cells. Very low numbers of CD4⁺ lymphocytes are a major hallmark of the acquired immunodeficiency syndrome, in which humoral immunity (particularly the ability to mount a primary immune response) is severely compromised (see Chapter 30).

The determination of the number of T cells expressing the CD40 ligand (CD40L, gp39), one of the membrane molecules involved in T-B cell interactions and signaling, is critical for the diagnosis of the hyper-IgM syndrome (see Chapter 29).

C. Study of Differentiation of B Cells In Vivo

The best approach is to look for germinal centers and immunoglobulin-producing cells in a lymph node biopsy from an area draining the site where an antigenic challenge has been carried out a week earlier (e.g., with diphtheria or tetanus toxoids). The main drawback is the need for surgical excision of a lymph node, which often may be quite difficult to localize. An alternative recommended by some groups is to perform a rectal biopsy and look for the presence of germinal centers in the submucosa, as evidence for the normal differentiation of B cells in the peri-intestinal tissues.

D. Investigation of B-Cell Function In Vitro

The investigation of B-cell function in vitro requires separation of peripheral blood lymphocytes (PBL) and their stimulation with substances known to induce the proliferation and/or differentiation of B lymphocytes. Several substances have been used as B-cell mitogens, including pokeweed mitogen (PWM), *Staphylococcus aureus* (SA), and *Salmonella paratyphi* B (SPB). Of all these mitogens, pokeweed mitogen, a plant lectin that induces proliferation and differentiation of T and B lymphocytes, is the most widely used for B-cell stimulation in vitro. The effects of this mitogen on B lymphocytes are T-cell-dependent, but when immunoglobulin synthesis is used as the endpoint, the assay measures PWM-induced functional differentiation of B lymphocytes (Fig. 28.5).

IV. DIAGNOSTIC EVALUATION OF CELL-MEDIATED IMMUNITY

It is traditional to designate as cell-mediated immunity (CMI) the complex network of interrelated cellular reactions often resulting in the production and release of soluble factors that appear to mediate the cooperation between different mononuclear cell populations and the expression of a variety of lymphocyte effector functions. A variety of tests, some performed in vivo and others in vitro, have been shown to correlate with different parameters or functions believed to depend primarily on lymphocyte stimulation and activation and, in some cases, to reflect the adequacy of immune responses primarily mediated by T lymphocytes.

A. In Vivo Testing of Delayed-Type Hypersensitivity

Delayed hypersensitivity responses, discussed in greater detail in Chapter 20, are primarily mediated by T lymphocytes, and thus can be considered as manifestations of an hyperstimulation of cell-mediated immunity. Using controlled conditions, it is possible to challenge individuals with antigens known to cause this type of reactions as a way to explore their cell-mediated immunity. The two classical approaches to measure delayed-type hypersensitivity (DTH) responses in vivo are skin testing and induction of contact sensitivity.

Skin testing, first described by Koch in 1891, is based on eliciting a secondary response to an antigen to which the patient was previously sensitized. A small amount of sol-

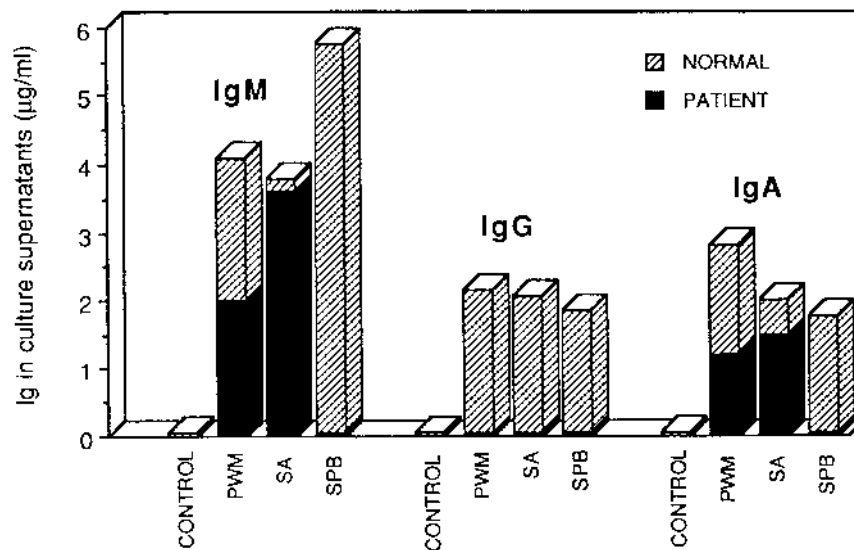

Fig. 28.5 Study of the differential stimulation of PBL isolated from a patient with common variable immunodeficiency and from a normal control with three B-cell mitogens: pokeweed mitogen (PWM), *S. aureus* (SA), and *Salmonella paratyphi* B (SPB). The levels of immunoglobulin M, G, and A measured on 7-day culture supernatants are shown by open bars for the control and closed bars for the patient. The patient's PBL responded with IgM and IgA production to stimulation with pokeweed mitogen and *S. aureus* but failed to respond to *Salmonella paratyphi* B. The induction of immunoglobulin secretion in vitro by PWM and *S. aureus* is believed to be T-dependent, while SPB is believed to induce immunoglobulin synthesis without T-cell help. Thus, the results show two significant abnormalities in the response of this patient's B cells: first, it was not possible to stimulate B cells without T-cell help; second, even when stimulated, the patient's B cells failed to produce IgG, pointing to a defect in the switch mechanism.

uble antigen is injected intradermally on the extensor surface of the forearm. The antigens used are usually microbial in origin [e.g., purified protein derivative (PPD) of tuberculin, tetanus toxoid, mumps antigens, and a variety of fungal extracts, including candidin (from *Candida albicans*), coccidioidin (from *Coccidioides immitis*), and histoplasmin (from *Histoplasma capsulatum*)].

The area of the skin receiving the injection is observed for the appearance of erythema and induration, which are measured at 24 and 48 hours. The designation of delayed hypersensitivity is based on comparison with a totally different type of skin reactions that develop a matter of minutes after antigen inoculation, last only for a few hours, and are characterized by erythema and localized swelling, but without induration (immediate hypersensitivity reactions; discussed in Chapters 20 and 21). A positive skin test is usually considered to be associated with an area of induration greater than 10 mm in diameter. If no reaction is observed, the test may be repeated with a higher concentration of antigen. Because the capacity to demonstrate a delayed hypersensitivity reaction may persist for long periods of time, a positive skin test may indicate either past exposure or a current infection.

If a patient has no reaction after being tested with a battery of antigens, it is assumed that a state of anergy exists. Anergy can be caused by immunological deficiencies or

infections (such as measles or chronic disseminated tuberculosis), but it can also be the result of errors in the technique of skin testing.

Although these tests have the theoretical advantage of testing the function of the T-cell system in vivo, they meet with a variety of problems:

Poor reproducibility due to the difficulty in obtaining consistency among different sources and batches of antigens and variations in the technique of inoculation among different investigators.

The interpretation of negative tests has to be carefully weighed. Negative results after challenge with antigens to which there is no record of previous exposure can always be questioned, while a negative result with an antigen extracted from a microbial agent that has been documented as causing disease in the patient has a much stronger diagnostic significance, implying a functional defect in cell-mediated immunity.

B. Analysis of T-Lymphocyte Membrane Markers

The availability of monoclonal antibodies specific for a wide variety of lymphocyte membrane molecules and the development of flow cytometry-based assays has resulted in the possibility of enumerating T lymphocytes, and their subpopulations using fluorescent-labeled monoclonal antibodies are used to detect the different T-lymphocyte antigens. The determination of these parameters is particularly important in the study of patients suspected of having a primary or secondary immunodeficiency affecting the T-lymphocyte system. The normal distribution of lymphocyte subpopulations in a normal adult is shown in Table 28.5. Quantitative abnormalities may range from complete absence or pronounced deficiency of all T cells, as detected with CD3 antibodies, to lack of CD4⁺ T cells.

C. Enumeration of NK Cells

Phenotyping of NK cells with monoclonal antibodies (see Chapters 10 and 15) is the most popular parameter to assess this cell subpopulation in a clinical context. However, the precise phenotype associated with a fully activated NK cell has not been established, and the enumeration of the resting NK cell population may not be very informative.

Table 28.5 Distribution of the Major Human Lymphocyte Subpopulations in Peripheral Blood, as Determined by Flow Cytometry^a

CD marker	Lymphocyte subpopulation	Normal range (%)	Normal range, cells/ μ L (absolute count)
CD19, CD20	B lymphocytes	4–20	96–421
CD3	T lymphocytes	62–85	700–2500
CD2	T lymphocytes; NK cells	70–88	840–2800
CD4	Helper T cells	34–59	430–1600
CD8	Cytotoxic T cells	16–38	280–1100

^a Values obtained at the Flow cytometry laboratory, Department of Pathology and Laboratory Medicine, Medical University of South Carolina.

D. Functional Assays

There are limitations to the interpretation of numerical data, given the very loose correlation between membrane markers and biological function. However, numerical data are simpler and cheaper to obtain than functional data, which usually requires cell isolation and which is obtained in conditions that are anything but physiological (see Chapter 15).

1. Mitogenic Stimulation Assays

Human lymphocytes can be stimulated *in vitro* by specific antigens or by mitogenic substances. Although testing the response to specific antigens should be the preferred approach to the study of lymphocyte function, the likelihood of success in such studies is limited by the fact that very few T cells (and even fewer B cells) in the peripheral blood will carry specific receptors for any antigen, even if the individual has already developed a memory response to that particular antigen. In contrast, mitogenic responses are easier to elicit, because the mitogenic substances are able to stimulate nonspecifically large numbers of peripheral blood lymphocytes, and therefore lymphocyte proliferation becomes much easier to detect. Some of the most commonly used lymphocyte mitogens are listed in Table 28.6.

Several parameters can be used to determine whether T cells respond adequately to mitogenic stimulation. The simplest one is the measurement of the incorporation of tritiated thymidine into the mitogen-stimulated lymphocytes. In the stage of blastogenic transformation there is active DNA synthesis, and if tritiated thymidine [$^3\text{H-Tdr}$] is added to the culture at the peak of proliferation (usually after 72 hours of incubation with the mitogen), significant incorporation of $^3\text{H-Tdr}$ will be measured. For this to be a true indication of T-lymphocyte response, it is essential to use mitogens that stimulate exclusively T cells, such as phytohemagglutinin (PHA), concanavalin A (ConA), and Immobilized anti-CD3 monoclonal antibodies. PWM stimulates both B cells and T cells and, therefore, cannot be used to differentiate the mitogenic response of B and T lymphocytes, if $^3\text{H-Tdr}$ incorporation is used as the endpoint.

2. Response to Antigenic Stimulation

The study of the response of lymphocytes to antigenic stimulation *in vitro* is functionally more relevant than the study of mitogenic responses. However, even in the best possible circumstances, i.e., when the antigen can be recognized by T lymphocytes, which predominate in peripheral blood, and the lymphocyte donor has developed memory to the antigen in question, the proportion of cells responding to stimulation is likely not to exceed 0.1%, and the proportion of responding B lymphocytes is even lower.

Table 28.6 Lymphocyte Mitogens

Mitogen	T lymphocyte	B lymphocyte
Phytohemagglutinin (PHA)	+	–
Concanavalin A (ConA)	+	–
Anti-CD3 monoclonal antibody	+	–
Pokeweed mitogen (PWM) ^a	+	+

^a PWM is mainly a T-cell mitogen, inducing also B-cell proliferation and differentiation through the release of soluble factors by T cells.

The probability of obtaining a measurable response can be increased if the lymphocytes are stimulated with antigens to which the lymphocyte donor has been previously exposed and the cultures are incubated with the antigen for 5–7 days prior to addition of ^3H -Tdr.

The elicitation of B-lymphocyte responses *in vitro* is considerably more difficult. Most studies in which positive results have been reported have used heterologous red cells or tetanus toxoids as antigens. The *in vitro* response to tetanus toxoid is easier to elicit using peripheral blood mononuclear cells separated from donors who had received a booster 1–3 weeks earlier. Usually the incubation periods in studies of B-cell activation have to be increased even further, up to 9–11 days.

3. Cytokine Assays

Since one of the most biologically significant consequences of T-lymphocyte activation is the release of cytokines, it is not surprising that immunologists have used cytokine measurements as indices of T-cell activation. This is usually achieved using enzymeimmunoassays that incorporate monoclonal antibodies to specific cytokines or their receptors.

1. IL-2 and IL-2 receptor (CD25) assay. The assay of IL-2 by EIA is probably the method of choice for the evaluation of the functional response of helper T cells. Secreted IL-2 can be detected 24 hours after mitogenic stimulation. Low or absent release of IL-2 has been observed in a variety of immunodeficiency states, particularly in patients with AIDS. It is also a good parameter to follow longitudinally when the effects of a drug or substance over the immune system are being studied, as illustrated in Figure 28.6. CD25 expression, on the other hand, is a characteristic shared by activated T and B cells. It can be used to identify activated B cells or T cells when the simultaneous expression of CD25 and specific T- or B-cell markers are determined.

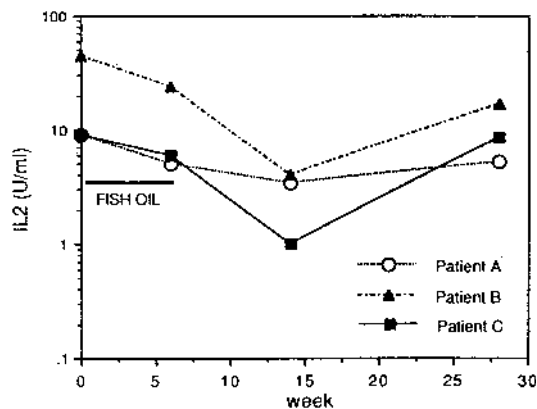

Fig. 28.6 Longitudinal study of the release of IL-2 by peripheral blood lymphocytes stimulated with pokeweed mitogen in three volunteers who ingested 8 g/day of a fish oil extract for 6 weeks (as indicated by the horizontal bar in the figure). The release of IL-2 was reduced in the three volunteers at the end of the 6 weeks of dietary supplementation with fish oil, but the reduction became more accentuated at week 15. By week 30, IL-2 release was back to normal in patient C but still depressed in patients A and B. (Based on results published by Virella, G., Fourspring, K., Hyman, B., Haskill-Stroud, R., Long, L., Virella, I., La Via, M., Gross, A. U., and Lopes-Virella, M. *Clin. Immunol. Immunopathol.* 61:161, 1991.)

2. Enzymoimmunoassays for IL-4, IL-5, IL-6, IL-10, IL-12, GM-CSF, TNF, LT- α , and interferon- γ are also available, and their judicious use allows to obtain a more complete picture of the functional response of T lymphocytes. For example, predominant release of IL-4, IL-5, and IL-10 is characteristic of T_H2 responses, while predominant release of GM-CSF and interferon- γ is characteristic of T_H1 responses.

V. DIAGNOSTIC EVALUATION OF PHAGOCYtic CELL FUNCTION

Phagocytic cell function tests have been discussed in detail in Chapter 13. Basically, three sets of tests are commonly used to evaluate a possible phagocytic cell deficiency. A complete blood count with differential is essential because the most common phagocytic cell deficiency is iatrogenically induced neutropenia (see Chapter 30). The expression of CD11/18 markers on neutrophil and monocyte cell membranes is the most efficient way to rule out adhesion molecule deficiencies, which are extremely rare (see Chapter 29). Finally, one of the variants of the tests used to measure the superoxide burst after ingestion of opsonized particles, such as the NBT reduction assay, is used to investigate chronic granulomatous disease, by far the most common form of primary phagocytic cell deficiency.

VI. DIAGNOSTIC EVALUATION OF COMPLEMENT FUNCTION

Complement deficiencies are usually screened by assays of complement activity, such as the CH50 assay. A low value on a CH50 assay indicates that there is an abnormality somewhere along the classical pathway. Quantitative assays for individual complement components can be used to pinpoint the exact component that is deficient in any particular patient.

VII. MOLECULAR GENETIC STUDIES

The notable progress that has taken place in the last decade in our understanding of the molecular basis of several immune deficiency diseases has resulted in the fact that in most cases (as discussed in Chapter 29) definitive diagnosis requires identification of the genetic abnormality in each individual patient.

SELF-EVALUATION

Questions

Choose the one *best* answer.

- 28.1 Which of the following tests would you consider as the least adequate for the characterization of an immunodeficiency affecting predominantly T lymphocytes?
 - A. Assay of cytokines released after mitogenic stimulation
 - B. Enumeration of CD3⁺ cells
 - C. Enumeration of CD4⁺ cells
 - D. Mitogenic response to pokeweed mitogen
 - E. Skin tests with common microbial antigens

- 28.2 Which of the following tests gives more significant information concerning T-lymphocyte function?
- A. Number of CD4/CD25 (IL-2 receptor)⁺ cells
 - B. Number of CD3⁺ cells
 - C. Release of IL-2 after mitogenic stimulation
 - D. Tritiated thymidine incorporation by anti-CD3–stimulated mononuclear cells
 - E. Tritiated thymidine incorporation by PHA-stimulated mononuclear cells
- 28.3 In an infant that suffers from repeated bacterial infections and fails to form specific antibodies after initial immunization with DTP, it is important to:
- A. Determine the serum levels of IL-6
 - B. Enumerate CD19⁺ lymphocytes in the peripheral blood
 - C. Enumerate the proportion of CD25⁺ B lymphocytes
 - D. Give another DTP booster and repeat antibody determinations
 - E. Measure the concentrations of circulating immunoglobulins
- 28.4 Which of the following procedures is preferred for the evaluation of the ability of a patient to mount a secondary immune response?
- A. Determination of antibody titers to measles pre- and postadministration of a booster injection
 - B. Determination of antibody titers to tetanus toxoid pre- and postadministration of a booster injection
 - C. Phage immunization
 - D. Quantitative assay of serum immunoglobulin levels (G, A, and G)
 - E. Titration of isohemagglutinins
- 28.5 A 21-year-old female is seen as an outpatient due to a history of repeated chronic pyogenic infections. Preliminary investigations show that the patient's blood group is O but has no detectable isoagglutinins; her immunoglobulin levels are strongly depressed, but her peripheral blood contains 89 CD19⁺ cells/ μ L. Which one of the following tests would be the *least* useful for the characterization of this patient's immunodeficiency?
- A. Measurement of ³H-Tdr incorporation by peripheral blood mononuclear cells after stimulation with PHA
 - B. Determination of anti-*S. pneumoniae* antibody levels before and after a booster with Pneumovax
 - C. Enumeration of T-lymphocyte subpopulations
 - D. Measurement of the humoral response to keyhole limpet hemocyanin (KLH)
 - E. Study of the ability of the patient's lymphocytes to secrete immunoglobulins in vitro after stimulation with PWM
- 28.6 A 4-year-old boy has had recurrent pneumonia since 3 months of age. Bacterial examinations have been repeatedly positive for *Haemophilus influenzae*. Immunoglobulin levels are: IgG: 400 mg/dL; IgA: 40 mg/dL; IgM: 50 mg/dL. Which of the following do you expect to give the most useful information?
- A. Assay of antibodies to tetanus and diphtheria toxoids prior to and 3 weeks after a DTP booster
 - B. Assay of secretory IgA
 - C. Determination of antibody titers to *Haemophilus influenzae* capsular polysaccharide
 - D. Study of the primary immune response to a bacteriophage
 - E. Titration of isohemagglutinins

- 28.7 In a normal 6-month-old child you expect to see:
- A. A concentration of IgG close to that of an adult because of the persistence in circulation of maternally transferred IgG
 - B. A total immunoglobulin concentration (IgG + IgA + IgM) below 200 mg/dL
 - C. IgM as the quantitatively predominant serum immunoglobulin
 - D. Lower levels of all immunoglobulin classes relative to normal adult levels
 - E. Undetectable IgA
- 28.8 All of the following are adequate antigens for use in evaluating the humoral immune response of a suspected immune deficiency except:
- A. Bacteriophage ØX174
 - B. Diphtheria and/or tetanus toxoids
 - C. Keyhole limpet hemocyanin (KLH)
 - D. Oral polio vaccine
 - E. *S. typhi* vaccine
- 28.9 In a 4-year-old child with a history of repeated pyogenic infections caused by bacteria with polysaccharide-rich capsules, which of the following deficiency(ies) should be investigated?
- A. IgA deficiency
 - B. IgG1 deficiency
 - C. IgG2 deficiency
 - D. IgA and IgG2 deficiency
 - E. IgG and IgA2 deficiency
- 28.10 The earliest functional evidence of secondary (or acquired) immunodeficiency in most individuals is:
- A. A depression in the peripheral lymphocyte count
 - B. A depression of serum immunoglobulin levels
 - C. An antigen-specific immune deficiency
 - D. Lack of capacity to initiate a primary immune response
 - E. Loss of immunological memory

Answers

- 28.1 (D) The mitogenic response pokeweed mitogen involves both B and T lymphocytes.
- 28.2 (C) A CD3 count only gives indication about the total number of T lymphocytes but is not informative about their function. The co-expression of CD25 (IL-2 receptor) by CD4⁺ cells is typical of activated helper T lymphocytes but does not prove whether the labeled cells are functionally competent. The mitogenic responses to PHA and anti-CD3 only give an indication about the general ability of T cells to proliferate in response of different types of stimulation. IL-2 release is probably the major determinant of the initial expansion of T cells (particularly of the T_H0 subpopulation) during an immune response and, therefore, is a better index of the functional status of T lymphocytes than any other of the listed alternatives.
- 28.3 (B) Although repeating the immunization could be considered, in a child with repeated bacterial infections and apparently impaired humoral immunity, the assay of circulating B cells could rapidly help establish a

- diagnosis of B-lymphocyte deficiency, which could explain the infections and lack of response to immunization.
- 28.4 (B) Toxoids are fully adequate for this purpose; attenuated vaccines, on the contrary, should always be avoided. Phage neutralization, the technique needed to evaluate the effects of phage immunization, is not available in most medical centers.
- 28.5 (A) All the tests listed are relevant in the investigation of a patient with circulating B cells that apparently fail to differentiate into antibody-producing cells except the test for the mitogenic response to PHA. This test gives information about the ability of T cells to respond to mitogenic stimulation, but not about their functional differentiation (e.g., the ability to release co-stimulatory or inhibitory cytokines).
- 28.6 (C) When a patient suffers from repeated infectious bouts caused by one given microorganism, the most informative studies of humoral immunity are those measuring the response to the infecting agent.
- 28.7 (D)
- 28.8 (D) Live, attenuated vaccines should be avoided in immunodeficient patients unless the risks are outweighed by potential benefits, which is not the case when an investigation of immune responsiveness is being carried out.
- 28.9 (D) Combined IgA and IgG2 deficiency is frequently associated to increased frequency of infections with encapsulated pyogenic bacteria.
- 28.10 (D)

BIBLIOGRAPHY

- Barclay, A. N., et al. *The Leukocyte Antigen Facts Book*. Academic Press, Oxford (U.K.), 1993.
- Conley, M. E., Notarangelo, L. D., and Eizioni, A. Diagnostic criteria for primary immunodeficiencies. *Clin. Immunol.* 93:190–197, 1999.
- Denny, T. N., and Oleske, J. M. Flow cytometry in pediatric immunologic diseases. *Clin. Immunol. Newslett.* 11:65, 1991.
- Gergen, P., McQuillan, G. M., Kiely, M., Ezzati-Rice, T. M., Sutter R. W., and Virella, G. Serologic immunity to tetanus in the U.S. population: Implications for national vaccine programs. *N. Engl. J. Med.* 332(12):761–766, 1995.
- Hanson, L. Å., Söderstrom, R., Nilssen, D. E., Theman, K., Björkander, J., Söderström, T., Karlsson, G., and Brandtzaeg, P. IgG subclass deficiency with or without IgA deficiency. *Clin. Immunol. Immunopathol.* 61 (part 2):S70, 1991.
- Rose, N. R., de Macario, E. C., Fahey, J. L., Friedman, H., and Penn, G. M. (Eds.). *Manual of Clinical Immunology*, 4th ed., Am. Soc. Microbiol., Washington, DC, 1992.
- Virella, G., and Hyman, B. Quantitation of anti-tetanus and anti-diphtheria antibodies by enzymeimmunoassay: Methodology and applications. *J. Clin. Lab. Anal.* 5:43, 1991.
- WHO Scientific Group on Immunodeficiency. Primary immunodeficiency diseases. *Clin. Immunol. Immunopathol.* 28:450, 1983.

29

Primary Immunodeficiency Diseases

Gabriel Virella and John Sleasman

I. INTRODUCTION

Primary immunodeficiencies can be classified by a variety of criteria, such as the main limb of the immune system affected, the spectrum of infections, their primary or secondary nature, and, in the case of hereditary primary immunodeficiencies, their mechanism of genetic transmission (Table 29.1). A simplified classification of the most important primary immunodeficiency diseases is given in Table 29.2.

Case 29.1

A 23-year-old female was admitted with a clinical diagnosis of bacterial pneumonia. She complained of rigors and chills, productive cough, and shortness of breath. Personal history was remarkable for repeated episodes of pneumonia since 8 years of age, with hospitalizations at 8, 16, 21, 22 (at 5 months of an otherwise uneventful pregnancy), and 24 years of age for pulmonary infections, which were treated with antibiotics. At 9 years of age, she was successfully treated for pulmonary tuberculosis. At 12, she had an episode of generalized pyoderma. She received the usual childhood immunizations without complications. She had chickenpox at 3 years of age, with normal evolution. Physical examination revealed a sick-looking female, with a temperature of 102.5°F (39.2°C), pulse of 85/min, respiration of 26/min, BP 120/80. Chest percussion revealed signs of consolidation on the lower right hemithorax. Auscultation of the same area revealed rhonchi and rales, with dulled breath sounds. A chest x-ray showed consolidation of the right lower lobe. CBC and differential showed RBC of 3,600,000/ μ L, hemoglobin of 12 g/L, WBC of 12,800/ μ L with

Table 29.1 Criteria for Classification of Immunodeficiency States

By range
Broad spectrum
Restricted (“antigen-selective”)
By etiology
Primary
Secondary
By limb of the immune system predominantly affected
Humoral immune deficiencies
Cellular immune deficiencies
Combined immune deficiencies
Phagocyte dysfunction syndromes
Complement deficiencies
By mechanism of transmission
Genetically transmitted
X-linked
Autosomal recessive
Autosomal dominant
Sporadic

60% neutrophils, ESR of 122 mm/hr. Lymphocyte subpopulations were: CD3⁺ lymphocytes: 1200/μL; CD4⁺ lymphocytes: 620/μL; CD8⁺ lymphocytes: 575/μL; CD20⁺ lymphocytes: 390/μL. Serum immunoglobulin concentrations were: IgG: 80 mg/dL; IgA, IgM, and IgD: not detectable. A sputum culture was positive for *Haemophilus influenzae*.

This case raises several questions:

What arm of the immune system appears to be most severely involved in this patient?

Is the patient's child at risk for developing this disease?

Should any other tests be run to clarify the pathogenesis of this condition?

What complications are most likely to develop in this patient?

What is the best therapy for this case?

II. HUMORAL IMMUNODEFICIENCIES

Humoral immunodeficiencies are those in which antibody synthesis is predominantly impaired. The general characteristics of the most important primary immunodeficiencies included in this group are summarized in Table 29.3. Patients with primary humoral immune deficiency generally do not develop clinical symptoms until after the first 6–12 months of life and the disappearance of maternally derived IgG. Most frequently these patients develop recurrent sinopulmonary infections with bacterial pathogens such as *Haemophilus influenzae* and *Streptococcus pneumoniae*. Deficiency in secretory IgA leads to chronic gastrointestinal illness with parasitic infections such as *Giardia* sp.

A. Transient Hypogammaglobulinemia of Infancy

This disorder is an accentuation of a normal physiological phenomenon. As maternal IgG is catabolized, with a half-life of approximately one month, infantile IgG levels are mainly

Table 29.2 Classification of Primary Immunodeficiency Diseases**Humoral immunodeficiencies**

1. *Lack of B-lymphocyte development*
Infantile hypogammaglobulinemia (Bruton-Janeway syndrome)
2. *Abnormal immunoregulation*
Transient hypogammaglobulinemia of infancy
Hyper-IgM syndrome
3. *Variable or undetermined pathogenesis*
Common variable, unclassifiable immunodeficiency
Selective IgA deficiency
Antigen-specific deficiencies

Cellular (T-cell) immunodeficiencies

1. *Lack of thymic development*
Congenital thymic aplasia (DiGeorge syndrome)
2. *Undetermined pathogenesis*
Chronic mucocutaneous candidiasis

Combined immunodeficiencies

1. *Lack of stem cell development*
Severe combined immunodeficiency (Swiss-type agammaglobulinemia)
Nezelof syndrome
2. *Enzymatic deficiency*
ADA deficiency
3. *Deficient DNA repair*
Immunodeficiency with ataxia-telangiectasia
4. *Impaired antigen presentation*
Bare lymphocyte syndrome
MHC-II deficiency syndrome
5. *Helper T-cell deficiency*
Primary
Secondary to IL-2 deficiency
4. *Undetermined pathogenesis*
Immunodeficiency with eczema and thrombocytopenia (Wiskott-Aldrich syndrome)

Complement deficiencies

1. Early component deficiencies
2. C3 deficiency
3. Factor H and factor I deficiencies
4. Late component deficiencies

Phagocytic deficiencies

1. Chronic granulomatous disease
2. Myeloperoxidase deficiency
3. Chédiak-Higashi syndrome
4. Job's syndrome

dependent on the rate of antibody production. Any delay in B-cell development results in low levels of immunoglobulins for age. All infants have lower levels of IgG and IgA when compared to adults. The nadir of IgG occurs between 3 and 6 months of age.

Most patients are seen because of an increased frequency and/or severity of bacterial infections. Low-for-age circulating immunoglobulin levels is the diagnostic hallmark. Differentiation with more severe forms of humoral immunodeficiencies is usually based on

Table 29.3 Main Characteristics of Primary Humoral Immune Deficiencies

Characteristic	Infantile agammaglobulinemia	Common variable immunodeficiency	Hyper-IgM syndrome	Transient hypogammaglobulinemia of infancy	IgA deficiency
Genetics	Usually X-linked	Variable	Usually X-linked	?	?
Molecular basis	Lack of Bruton's tyrosine kinase (Btk)	Variable, ill defined	Lack of CD40 ligand on T-cells (gp39)	Unknown	Unknown
Lymphoid tissues	Lack of development of B-cell territories (follicles)	Follicular necrobiosis, reticulum cell hyperplasia	Normal	Normal	Normal
B lymphocytes	Very low to absent	Normal numbers, abnormal differentiation or function	Normal numbers	Normal numbers	Normal numbers
Serum immunoglobulins	Very low	Low to very low levels	Low IgG and IgA, high IgM	Low for age	Low to undetectable IgA
Infections	Bacterial (pyogenic)	Bacterial, parasitic (<i>Giardia</i>)	Bacterial	Bacterial	Bacterial (particularly when associated to IgG2 deficiency)
Treatment	Gamma globulin IV	Gamma globulin IV	Gamma globulin IV	Gamma globulin IV (if necessary)	Gamma globulin IV (when associated to IgG2 deficiency)

functional tests and enumeration of B cells. Lymphocyte mitogenic responses and antibody response to challenge with toxoids are usually normal. Peripheral blood B lymphocytes are usually normal in number; in most cases, a deficiency of helper T-cell function appears to be responsible for the delay in immunoglobulin synthesis. Antigen-specific antibody production following infection or immunization is normal.

Most infants do not require therapy. Severe cases with recurrent infections can be treated with intravenous gammaglobulin until the child's immunoglobulin levels normalize. With time, most children will develop normal immune function.

B. Infantile Agammaglobulinemia (Bruton-Janeway Syndrome)

This is the prototype of “pure” B-cell deficiency. The disease is predominately transmitted as an X-linked trait. The defective gene is located on Xq21.2–22, the locus coding for the B-cell progenitor kinase or Bruton’s tyrosine kinase (Btk). Patients may have mutations at different sites within the locus resulting either in the lack of synthesis of the kinase or in the synthesis of an inactive form of the kinase.

Btk plays an important role in B-cell differentiation and maturation and is also part of the group of tyrosine kinases involved in B-cell signaling in adult life. Most mutations affecting Btk are associated with infantile agammaglobulinemia, but some patients with similar mutations have mild forms of immunodeficiency with variable levels of immunoglobulin production. These findings suggest that B-cell differentiation may depend on additional, not yet identified cofactors.

Some forms of autosomal recessive infantile agammaglobulinemia have deletions of genes encoding parts of either the V region or of the C μ region. Such deletions are associated with a total lack of differentiation of B lymphocytes, similar to the defect seen in patients with Btk deficiency.

1. Clinical Presentation

Infectious symptoms usually begin early in infancy as maternally acquired IgG disappears. The patients most commonly suffer from repeated infections caused by common pyogenic bacteria (*Streptococcus pneumoniae*, *Neisseria meningitidis*, and *Haemophilus influenzae*) of the sinopulmonary system. Pyoderma, purulent conjunctivitis, pharyngitis, purulent arthritis, otitis media, sinusitis, and bronchitis are common clinical findings. Severe life-threatening infections, such as pneumonia, empyema, meningitis, and septicemia, are also frequently seen. Chronic obstructive lung disease and bronchiectasis develop as a consequence of repeated bronchopulmonary infections in untreated older patients. Chronic diarrhea and malabsorption caused by infections with *Giardia lamblia* are seen more frequently in these patients than in the general population. Arthritis of the large joints develops in about 30–35% of the cases and is sometimes associated with infection by *Ureaplasma urealyticum*. Agammaglobulinemic patients are at risk of developing paralytic polio after vaccination with the attenuated polio vaccine. They also are at risk of developing chronic viral meningoencephalitis, usually caused by echovirus.

2. Diagnosis

The diagnosis of agammaglobulinemia requires the quantitative assay of immunoglobulin levels. The serum levels for the three major immunoglobulins (IgG, IgA, and IgM) are greater than 2 SD below the normal level for children of the same age, although in infants low levels of IgG may be masked by the presence of maternal antibody. Usually the sum of the three major immunoglobulin isotypes is less than 100 mg/dL and electrophoresis fails to show a gamma globulin peak.

Definitive diagnosis requires at least one of the following: (1) detection of Btk mutations, (2) absence of Btk mRNA on Northern blot analysis of neutrophils or monocytes, (3) lack of Btk protein in monocytes or platelets, or (4) maternal male relatives with less than 2% CD19⁺ B cells.

The lack of B lymphocytes in peripheral blood (<2% of the circulating lymphocytes are CD 19⁺) is one of the most important laboratory features of the disease, not shared by

the most frequent cases of hypogammaglobulinemia, common variable immunodeficiency (see below). Histological examination of lymphoid tissues shows lack of germinal centers and secondary follicles in lymph nodes and peri-intestinal lymphoid tissues. Plasma cells are absent both from peripheral lymphoid tissues and from bone marrow. Adenoids, tonsils, and peripheral lymph nodes are hypoplastic. The thymus has normal structure, and the T-cell–dependent areas in peripheral lymphoid organs are normally populated. Normal numbers of B-cell precursors can be demonstrated in the bone marrow, indicating that the basic defect is a maturation block, restricted to B-cell development. Peripheral blood lymphocyte counts are usually normal, T-lymphocyte counts are normal or elevated, T-lymphocyte subsets are normal, and T-lymphocyte function is also normal.

Predictably, B-cell function is depressed. Isohemagglutinins are undetectable and the patients fail to produce antibodies after active immunization. Live, attenuated vaccines should be avoided in these patients.

3. *Therapy*

The primary strategy in therapy of infantile agammaglobulinemia is the prevention of infections. These children should not receive immunizations containing live, attenuated viruses (polio, measles, mumps, rubella, and varicella). Infections should be treated early and aggressively with antibiotics. Infections are best prevented by regular (monthly) infusions of intravenous gammaglobulin (IVIg). IVIg consists of purified polyclonal human IgG obtained from the pooled plasma of healthy blood donors. IgA and IgM, which can cause anaphylactoid reactions, are removed. Viruses that can be transmitted by blood transfusions are inactivated by detergent to minimize the risks of infection. IVIg penetrates mucosal surfaces and crosses the blood-brain barrier poorly. Infections of the gastrointestinal tract sometimes require the use of human or bovine colostrum or oral gamma globulin. Viral infections in the central nervous system may require infusions with intraventricular gamma globulin.

C. **Common, Variable, Unclassified Immunodeficiency (“Acquired” Hypogammaglobulinemia)**

This designation includes the most common form of hypogammaglobulinemia diagnosed in adults. The disorder is heterogeneous in presentation, with variable age of onset (usually after 2 years of age, most frequently between 15 and 35 years of age) and patterns of inheritance. The clinical signs and symptoms are similar to X-linked agammaglobulinemia.

1. *Physiopathology*

A panel of experts who met under the auspices of the World Health Organization (WHO) in 1983 recognized several variants of common variable immunodeficiency.

1. Most variants of “acquired hypogammaglobulinemia” have normal or increased numbers of B lymphocytes in peripheral blood, but the B cells remain immature and do not respond adequately to *in vivo* stimulation.
2. T-cell function appears deficient in most cases, with abnormally low proliferative responses to T-cell mitogens. T-cell receptor stimulation is followed by reduced release of interleukins and reduced expression of CD40L (CD159). Thus, lack of proper T-cell help seems responsible for the lack of B-lymphocyte responses.
3. In some patients the defect seems to result from excessive suppressor T-lymphocyte activity.

2. *Clinical Presentation*

Sinopulmonary infections, primarily sinusitis, and bacterial pneumonia are the predominant infections. Chronic obstructive pulmonary disease and bronchiectasis are frequent complications. Intestinal giardiasis is common and in some patients can lead to malabsorption. Opportunistic infections involving *P. carinii*, mycobacteria, viruses, and other fungi are more frequent in these patients. Clinical features that differentiate common variable immunodeficiency from infantile agammaglobulinemia and other forms of hypogammaglobulinemia are the increased incidence of autoimmune disease and malignancy among these patients. There is a high frequency of autoimmune cytopenias, pernicious anemia, arthritis, inflammatory arthritis, sprue, and polymyositis. Malignancy, particularly of the gastrointestinal lymphoid system, and nodular lymphoid hyperplasia at the intestinal tract are also common clinical manifestations.

3. *Diagnosis*

Serum immunoglobulin levels are variably depressed. In general the levels of IgG are 2 SD or more below the normal level for age. The aggregate level of the three major immunoglobulin isotypes is usually below 300 mg/dL. The patients lack isohemagglutinins and fail to produce specific antibodies after immunization or infection. In contrast to what is observed in infantile agammaglobulinemia, these patients have, as noted, normal or increased numbers of B lymphocytes in peripheral blood, and those B cells can often be stimulated *in vitro* to produce immunoglobulins. Lymphoid tissues and tonsils, lymph nodes and spleen may be enlarged. Lymph node biopsies show morphological changes including necrobiosis of the follicles (also seen in the spleen) and/or reticular cell hyperplasia (which may be the major contributing factor for the development of lymphadenopathy and splenomegaly and in some patients seem to evolve into lymphoreticular malignancies).

4. *Treatment*

Overall, therapy is similar to that for infantile agammaglobulinemia. Special emphasis should be directed toward preventing pneumonia and progression to bronchiectasis. IVIg should be administered at a dose and frequency to maintain total IgG levels of greater than 600 mg/dL at all times.

D. **Selective Immunoglobulin A Deficiency**

IgA deficiency is the most common immunodeficiency. The frequency estimates of IgA deficiency vary according to the criterion used to define it and with the sensitivity of the methods used to measure IgA. An individual is considered IgA deficient when his or her concentration of serum IgA is below 7 mg/dL, as measured by routine methods for immunoglobulin assay (such as radial immunodiffusion or immunonephelometry). Defined by this criterion, IgA deficiency is diagnosed with a frequency of approximately 1 out of 600–800 normal Caucasian individuals.

1. *Physiopathology*

IgA deficiency appears to be a heterogeneous entity from the pathogenic point of view. In some cases phenotypic studies of circulating B cells show patterns similar to those of cord

blood B lymphocytes, suggesting a differentiation abnormality, sometimes reflected by a defect in secretion of intracytoplasmic IgA. In other cases there is evidence for immunoregulatory defects, such as:

Predominant synthesis of IgG1 and IgG3 antibodies to pneumococcal polysaccharides, even when the serum levels of IgG2 are normal (IgM and IgG2 are the immunoglobulin isotypes of antipolysaccharide antibodies in humans).

Longitudinal variations in IgA levels, which may fluctuate widely, from very low to normal and back to very low.

Anti-IgA antibodies reacting with isotypic or allotypic determinants of IgA can be detected in about one third of the patients, usually in low titers. However, when present in high titers (>80 when measured by passive hemagglutination), anti-IgA antibodies can cause hypersensitivity and possibly fatal reactions upon transfusion of IgA-containing blood products. Anti-IgA antibodies may contribute to the perpetuation of the IgA deficiency. The administration of radio-labeled IgA to patients with anti-IgA antibodies is followed by its rapid elimination from the circulation (in a matter of hours). More significantly, a comparison of the levels of residual IgA in patients with and without anti-IgA antibodies demonstrated that those with antibodies have the lowest levels.

2. Clinical Presentation

Most cases of IgA deficiency are asymptomatic. Patients with combined IgA and IgG2 deficiency may present with recurrent sinus infections caused by bacteria with polysaccharide capsules. Infections with *Giardia lamblia* are more frequent in patients with IgA deficiency than in individuals with normal IgA levels. As in patients with agammaglobulinemia, this parasitic infection may lead to chronic diarrhea and malabsorption.

Abnormal immune reactivity is not unusual in IgA-deficient individuals. Many IgA-deficient individuals have antibodies to food proteins, which in most cases appear to be of no consequence. But IgA deficiency can also be associated with "autoimmune" disorders such as pernicious anemia and rheumatoid arthritis.

3. Diagnosis

Diagnosis is based on IgA assay. A patient older than 4 years with less than 7 mg/dL of serum IgA, normal levels of IgG and IgM, with no other primary or secondary immune deficiency fulfills the clinical and laboratory criteria for the diagnosis of selective IgA deficiency. Patients with other forms of primary immune deficiency such as ataxia-telangiectasia can also have selective IgA deficiency.

4. Therapy

Treatment is usually targeted to relieve symptoms, using antibiotics as needed for infections and treating allergies and sinus inflammation. Replacement therapy with IVIg for IgA deficiency is not recommended, because only small amounts of IgA are present in commercial gamma globulins and may cause adverse reactions. Administration of intravenous gamma globulin is indicated in patients with combined IgA and IgG2 deficiency or in IgA-deficient patients who fail to produce antibodies to bacterial polysaccharides. These patients should receive IVIg preparations with very low IgA content to avoid hypersensitivity reactions due to IgA antibodies.

IgA antibodies should be assayed in any known IgA-deficient patient considered for elective transfusion with IgA-containing blood products. If found, the blood bank should be notified so that steps can be taken to make sure that any blood transfused to the patient is IgA-depleted or a blood product or gamma globulin preparation depleted of IgA. IgA-depleted blood transfusions can be achieved by obtaining compatible blood from a healthy IgA-deficient donor or by extensively washing red cells to remove IgA-containing plasma. Patients should be educated about their increased risk of reactions to blood products.

E. X-Linked Hyper-IgM Syndrome

This syndrome is characterized by an inability of B cells to undergo immunoglobulin class switch resulting in low levels of IgG, IgA, and IgD in association to an elevation of IgM. In 70% of cases the disease is X-linked. Symptoms develop during the first 5 years of life.

1. Genetics and Physiopathology

The X-linked hyper-IgM syndrome usually involves a mutation of the CD40 ligand (CD40L, CD159) gene, located on Xq26-27. As a consequence, T cells do not express CD40L and the signals mediated by CD40L-CD40 interactions are not delivered. This signal is essential for B-lymphocyte differentiation and switching from IgM synthesis to the synthesis of other immunoglobulin classes. In addition to the failure to switch from IgM to IgG (IgA, IgE) synthesis during an immune response, germinal centers do not differentiate in the peripheral lymphoid tissues.

Other patients with hyper-IgM syndrome do express CD40L. In those patients, the molecular defect is believed to involve the second message systems, which transduce activation signals after CD40L-CD40 interaction (mediated by the JAK-STAT and by the TRAF-MAK kinase pathways).

2. Clinical Presentation

These patients suffer from increased frequency of pyogenic infections, similar to those affecting patients with infantile agammaglobulinemia. There is also an associated finding of neutropenia that increases the predisposition for pyogenic and other opportunistic infections. In addition to recurrent bacterial infections, patients carry an increased risk for *Pneumocystis carinii* pneumonia, cryptosporidium-related diarrhea, and aplastic anemia secondary to parvovirus B19 infection. Autoantibodies are common. Other increased risks for these patients are lymphoproliferative syndromes, cancers of the biliary system, and biliary cirrhosis.

3. Diagnosis

The association of normal or high IgM levels with low IgG and IgA levels is a significant diagnostic clue. The numbers of T and B cells are normal or elevated. T-cell proliferative responses after mitogenic stimulation are normal, but the activated T cells do not express CD40L. B cells also respond to mitogenic stimulation, but produce IgM only. Definitive diagnosis of X-linked hyper-IgM syndrome requires either detection of a mutation in the CD40L gene or identification of maternal male relatives with confirmed diagnosis of this immunodeficiency.

4. Therapy

IVIg is used to correct the antibody deficiency associated with hyper-IgM syndrome. Patients should be closely monitored for the development of autoimmunity and malignancy. Neutropenia has been corrected with the use of granulocyte colony-stimulating factors (G-CSF) and with bone marrow transplantation.

F. Antigen-Selective Immune Deficiencies

Those are immunodeficiencies in which the affected patients fail to produce antibodies following a challenge with a specific antigen, while exhibiting normal immune responses to most other antigens.

1. Physiopathology

Two basic mechanisms can, at least theoretically, underlie antigen-specific immune deficiencies:

“Holes” in the immunoglobulin repertoire of the responding T-cell receptor implying that no binding sites for a given antigen are available either at the T- or at the B-cell level. Considering that immunogenic proteins are complex molecules with a variety of different epitopes, it is difficult to envisage how this mechanism could be involved. In the case of polysaccharides, simpler in structure and presenting a limited number of epitopes to the immune system, the hypothesis is more plausible.

Inefficient antigen presentation to helper T cells, implying that the nonresponse is a consequence of the lack of MHC-II molecules with adequate sites for binding of key peptides derived from antigen processing. This mechanism would apply only to T-dependent responses.

2. Clinical Presentation

Antigen-selective immune deficiencies are often undiagnosed and often asymptomatic. For example, using tetanus toxoid as immunogen, one can detect about 1 in 100 individuals whose humoral response is consistently low or undetectable, and the same is probably true with other immunogens. Patients who suffer from antigen-selective immune deficiencies and who have frequent infections are often misdiagnosed because most of the tests to evaluate the immune system are normal. In some symptomatic cases, one or more of the IgG subclasses may be deficient. IgG2 deficiency can be associated with infections by polysaccharide-encapsulated bacteria such as *Streptococcus pneumoniae* and *Haemophilus influenzae*.

3. Diagnosis

The diagnosis is based on the failure to demonstrate the production of specific antibody following challenge by infection or immunization.

4. Therapy

Replacement of antibody deficiency can be achieved with IVIg. Specific humanized monoclonal antibodies may be used to treat this disorder in the future.

III. CELLULAR IMMUNODEFICIENCIES

Are those in which cell-mediated immunity is predominantly impaired. The general characteristics of the common primary cellular immunodeficiencies are summarized in Table 29.4.

Table 29.4 Main Characteristics of Primary Cellular and Combined Immune Deficiencies

Characteristic	Thymic aplasia (DiGeorge syndrome)	Severe continued immune deficiency	MHC deficiencies	IL-2 synthesis deficiency
Genetics	Not inherited	Variable	?	?
Molecular basis	Chromosomal deletion (22q11)	1. Deficient IL-2 (4,7) receptor γ chain 2. Deficient ZAP-70 kinase 3. ADA deficiency 4. RAG mutations	Lack of expression of MHC-I (bare lymphocyte syndrome) or MHC-II	CD4 T-cell deficiency; defects in signal transduction
Lymphoid tissues	Thymic aplasia; depletion of T-cell areas	Thymic aplasia; general atrophy of lymphoid organs	Normal	Normal
T lymphocytes	Low to very low	Very low	Normal to low (low CD4 counts in MHC-II deficiency)	Low CD4 count in some cases
B lymphocytes	Normal numbers; deficient function	Low or undetectable	Normal numbers, deficient function	Normal numbers
Serum immuno- globulins	Low levels	Low levels	Low levels	Low levels
Infections	Viral, bacterial	All types, with chronic or persistent evolution	All types	Bacterial (opportunistic and pyogenic)
Treatment	Fetal thymus transplant	Bone marrow graft; PEG-ADA, gene therapy therapy	Gamma globulin IV (if pyogenic infections predominate)	Gamma globulin IV (if pyogenic infections predominate)

A. Congenital Thymus Aplasia (DiGeorge Syndrome)

DiGeorge syndrome can be considered as the paradigm of a pure T-cell deficiency. Although DiGeorge syndrome is a congenital immunodeficiency, in most cases it is not hereditarily transmitted. It is believed to be caused by an intrauterine infection prior to the 8th week of life, possibly of viral etiology.

1. Etiology and Pathogenesis

The underlying genetic abnormality in these patients is microdeletions of chromosomal region 22q11.2. These deletions result in defective embryogenesis of the 3rd and 4th pharyngeal pouches at 6–8 weeks of fetal life, leading to deficient development of the thymus and parathyroids. Conotruncal cardiac defects (including truncus arteriosus, tetralogy of Fallot, interrupted aortic arch, or aberrant right subclavian artery) and facial dysmorphism are also characteristic of the disease.

2. Clinical Presentation

The main clinical features include persistent hypocalcemia, often associated with neonatal tetany, abnormalities of the heart and large vessels, facial dysmorphism, mental subnormality, and frequent infectious episodes often involving viral or fungal agents, although bacterial and protozoan infections can also affect these patients. Most common manifestations are pneumonia, chronic mucocutaneous candidiasis, diarrhea, and failure to thrive.

3. Diagnosis of Immunological Abnormalities

A hallmark finding is the absence or extreme reduction in size of the thymic image on a MRI. T cells are characteristically reduced in numbers (500/ μ L CD3⁺ T cells), and there is poor to null response of peripheral blood mononuclear cells to T-cell mitogens such as PHA. However, in some patients there are residual T lymphocytes and/or partial thymus functions (partial DiGeorge syndrome). In these cases, if the patient can be kept alive for a number of years, a slow development of immune functions may take place. The numbers of B lymphocytes in peripheral blood are normal in patients with DiGeorge syndrome and humoral immunity is not severely impaired, as a rule. Some patients may have low levels of immunoglobulins and increased frequency of viral and bacterial infections, probably due to lack of T-cell help. Definitive diagnosis requires the presence of two out of three other abnormalities besides T-cell deficiency, including conotruncal cardiac defects, persistent hypocalcemia, or deletion of chromosome 22q11.2.

4. Therapy

Patients with residual T lymphocytes have a good chance of slow but progressive normalization of immune functions. These patients may only require supportive treatment.

The best treatment for complete DiGeorge syndrome is the transplantation of a fetal thymus obtained after less than 14 weeks of gestation to avoid graft-versus-host (GVH) disease. Difficulties in obtaining fetal tissues have resulted in other, less satisfactory approaches being more frequently used, including antibiotic prophylaxis with sulfamethoxazole-trimethoprim to prevent infections by *Pneumocystis carinii*, bone marrow transplantation (more likely to cause GVH reactions), and administration of intravenous gamma globulin if antibody deficiency is also present. If heart surgery is performed before

correction of the immune deficiency, the blood used for replacement should be irradiated to eliminate heterologous lymphocytes, potentially able to cause GVH reaction in an immune-deficient recipient.

B. Chronic Mucocutaneous Candidiasis

Some patients with chronic infection of skin and mucosae with *Candida albicans* have been shown to have a selective deficiency of cell-mediated immunity. There is selective deficiency to *Candida* antigens following delayed-type hypersensitivity skin testing and in vitro lymphocyte proliferation responses. T-lymphocyte functions are otherwise normal when tested with other antigens and mitogens. The humoral response to *C. albicans* is also normal. Some of these patients develop endocrinopathies affecting the parathyroid glands, adrenals, thyroid, and endocrine pancreas. Alopecia aerata is also common.

Administration of oral antimycotic agents and symptomatic treatment of endocrine abnormalities are available therapies.

IV. COMBINED IMMUNODEFICIENCIES

Combined are those in which both cell-mediated immunity and humoral immunity are impaired. The general characteristics of this group are summarized in Table 29.4.

A. Severe, Combined Immunodeficiency

Severe, combined immunodeficiency (SCID) is a group of heterogeneous disorders associated with lack of both T- and B-cell function. Most forms are due to an inheritable disorder, which can be inherited as an X-linked recessive form or as an autosomal recessive form.

1. Pathogenesis

There are three predominant pathogenic mechanisms in SCID:

1. Mutation of recombinase-activating genes (RAG) 1, 2, and/or 3, genes that control the V(D)J recombination essential for the differentiation of membrane immunoglobulins and T-cell receptors (see Chapters 7 and 10). These patients lack both T and B cells, because those two cell populations cannot fully differentiate in the absence of their defining antigen receptors. Those patients are severely immune compromised. Inheritance is autosomal recessive.
2. Deficiencies in T-Cell Signaling. The most common form of SCID is X-linked and is due to a mutation in the γ chain of the IL-2 receptor (IL-2R γ c or γ c). This cell surface protein transduces signals delivered by the occupancy of several interleukin receptors, including those for IL-2, IL-4, IL-7, IL-11, and IL-15. Mutations in IL-2R γ c result in absent downstream cell surface signaling through the JAK/STAT signal transduction cascade, a critical component of interleukin-induced T-cell activation. A nearly identical SCID phenotype is observed in an autosomal recessive defect resulting from a mutation in JAK-3, the downstream protein from IL-2R γ c. Children with these forms of SCID have no circulating mature CD3⁺ T cells because of maturation arrest of T-cell development within the thymus. B cells are present in normal numbers but are nonfunctional, presumably due to a lack of T-helper cell function. NK cell numbers and function are also deficient.

Zap-70 is a critical intracytoplasmic protein for the transmission of activation signals through the T-cell receptor (see Chapters 4 and 11). Mutations in Zap-70 render this protein nonfunctional, and as a result T-cell activation is blocked. These children's T cells fail to proliferate in vitro when activated by mitogens. T-cell enumeration in Zap-70 deficiency reveals normal numbers of CD3⁺ and CD4⁺ T cells but low numbers of CD8⁺ T cells.

3. Deficiencies of purine salvage enzymes. The most common of these disorders are adenosine deaminase (ADA) and purine nucleoside phosphorylase (PNP) deficiencies. ADA catabolizes the deamination of adenosine and 2'-deoxyadenosine. Therefore, the lack of ADA causes the intracellular accumulation of these two compounds. 2'-Deoxyadenosine is phosphorylated intracellularly, and the activity of the phosphorylating enzyme is greater than the activity of the dephosphorylating enzyme. Consequently, there is a marked accumulation of deoxyadenosine triphosphate (deoxyATP), which has a feedback inhibition effect on ribonucleotide reductase, an enzyme required for normal DNA synthesis. As a consequence, DNA synthesis will be greatly impaired, and no cell proliferation will be observed after any type of stimulation. In addition, 2'-deoxyadenosine is reported to cause chromosome breakage, and this mechanism could be the basis for the severe lymphopenia observed in these patients. The reason why lymphocytes are predominantly affected over other cells that also produce ADA in normal individuals is that immature T cells are among those cells with higher ADA levels (together with brain and gastrointestinal tract cells).

2. Clinical Presentation

In all forms of SCID symptoms start very early in life, usually by 4 months of age. Survival beyond the first year of life is rare without aggressive therapy. Frequent clinical presentations include persistent infections of the lungs, often caused by opportunistic agents such as *Pneumocystis carinii*, severe mucocutaneous candidiasis, chronic, untractable diarrhea, failure to thrive, and runting. In most cases physical examination shows absence of all lymphoid tissues: atrophic tonsils, very small or undetectable lymph nodes, signs of pulmonary infection, evidence of poor physical development, and oral thrush. A chest x-ray will reveal absent thymic shadow, bony abnormalities of the ribs in patients with ADA deficiency. Approximately 20% of infants with SCID will develop graft-versus-host disease as a consequence of the transplacental transfer of T lymphocytes. The maternal T lymphocytes that enter the fetal circulation are not destroyed because of the infant's deficient cell-mediated immunity. The maternal T cells can proliferate in the skin, gastrointestinal tract, and liver. Symptoms of graft-versus-host disease include rash, jaundice, hepatitis, and chronic diarrhea. Severe cases of graft-versus-host disease are often fatal. Children with SCID and other T-cell deficiencies can also develop graft-versus-host disease following blood transfusions containing viable mononuclear cells. Children with SCID carry an increased risk of malignancy, particularly lymphomas positive for the Epstein-Barr virus.

3. Diagnosis

The laboratory parameters seen in the various forms of SCID can be found in Chapter 28. In most forms these patients have very low lymphocyte counts. In X-linked SCID more than 75% of the residual lymphocyte population are CD19⁺ B cells, while CD3⁺ T cells and CD16/56⁺ NK cells usually represent less than 10% and 2% of the residual population,

respectively. The deficiency in cell-mediated immunity is reflected by negative skin tests, delayed rejection of allogeneic skin grafts, and lack of response of cultured mononuclear cells to T-cell mitogens and anti-CD3 monoclonal antibodies. Neutropenia can also be seen in some patients. In cases of ZAP-70 deficiency, lymphocyte counts may be normal or close to normal, but the T lymphocytes do not respond to stimulation.

Immunoglobulins are usually low (levels more than 2SD below the normal level for age) but in some cases can be normal or irregularly affected. B cells and plasma cells are low or undetectable in ADA deficiency and RAG deficiency. In all forms of SCID antibody responses are very low to absent.

The definitive diagnosis and identification of the cause of SCID often requires evaluation at the molecular level. Many forms of SCID can be diagnosed by molecular analysis of the genes or gene products. The diagnosis of ADA deficiency can be made through enzymatic analysis of red blood cells, lymphocytes, fibroblasts, amniotic cells, fetal blood, or chorionic villous samples.

4. Therapy

Children with SCID and other defects in T-cell function should not receive immunizations with live attenuated vaccines. Prophylaxis with trimethoprim-sulfamethoxazole to prevent *Pneumocystis carinii* pneumonia is indicated. If blood transfusions are necessary, they should receive irradiated blood products from donors who test negative for viral infections such as cytomegalovirus. Exposure to all pathogens should be limited, although implementation is not easy (as reflected by the term “bubble baby”).

All forms of SCID can be corrected with a bone marrow transplantation from an HLA-matched sibling. The graft is usually successful, but there is a risk for the development of GVH disease. If an HLA-matched sibling is not available, alternative strategies include the grafting of haploidentical, T-cell-depleted bone marrow cells from a parent, an HLA-matched unrelated bone marrow donor, or umbilical cord blood leukocytes from an unrelated donor. The risk for GVH disease is greater in any of those modalities. GVH disease is usually prevented with the administration of immunosuppressive drugs following transplant.

ADA deficiency can be effectively treated by the administration of bovine ADA plus polyethylene glycol (PEG). The addition of PEG results in decreased immunogenicity and increased half-life of the bovine ADA.

It must be noted that ADA deficiency was the first human disease to be successfully treated by gene therapy. The protocol involves harvesting peripheral blood T lymphocytes from the patients, transfecting the ADA gene using a retrovirus vector, expanding the transfected cells in culture, and readministering them to the patient. In the first treated patient, normal peripheral blood T-lymphocyte counts and clinical improvement were seen after several such infusions. The infusions need to be periodically repeated, since the ADA⁺ T-lymphocyte population eventually declines. The normalization of T-cell counts probably reflects the fact that the transfected ADA⁺ cells will produce excess ADA, which will diffuse into genetically deficient cells unable to synthesize it. The therapeutic value of gene therapy in ADA deficiency, however, is limited because all patients have to continue receiving PEG-ADA to maintain a relatively symptom-free status.

Successful gene therapy of SCID secondary to IL-2R γ c deficiency was reported early in 2000. Two children with this form of immunodeficiency received their own CD34⁺ stem cells after ex vivo transfection of the defective gene by means of a murine

retroviral vector. In contrast with ADA gene therapy, the patients with IL2R γ c deficiency have shown long-term immune reconstitution, lasting for 10 months at the time of publication. The recovery of immune functions in these two children was basically complete—T, B, and NK cell counts and function became undistinguishable from those of normal age-matched controls, and so did the capacity of mounting antigen-specific responses.

B. Other Forms of Combined Immune Deficiency

1. Combined Immunodeficiency with Immunoglobulins (*Nezelof Syndrome*)

Clinically, this situation is very similar to those cases of SCID in which variable numbers of B lymphocytes and variable levels of immunoglobulins can be assayed. There is no well-defined pattern of inheritance. The evolution is usually more benign than in more severe forms of SCID, with survivals up to the teens.

2. Immunodeficiency with Ataxia-Telangiectasia

Genetics and Physiopathology. Ataxia-telangiectasia is genetically transmitted by an autosomal inheritance pattern. It is believed that the disease may result from a deficiency of DNA repair enzymes, as suggested by the high frequency of lymphoreticular malignancies. In addition, the enzyme defect seems to result in a generalized defect in tissue maturation, affecting many tissues, but with particular significance the brain capillary vessels. Persistently increased levels of serum α -fetoprotein and carcinoembryonic antigen in many patients with this disease support this last postulate.

Clinical Presentation. The initial symptoms are of progressive cerebellar ataxia beginning in early childhood associated with insidiously developing telangiectasia (first appearing as a dilation of the conjunctival vessels). The capillary abnormalities are systemically distributed and involve the cerebellum, causing the motor difficulties characteristic of ataxia. In late childhood, recurrent sinobronchial infections start to manifest, leading to bronchiectasis.

Associations of thymic hypoplasia, T-cell deficiency, and low immunoglobulin levels characterize this immunodeficiency. Low or undetectable IgA is reported in 80% of the patients.

The prognosis is poor and there is no effective therapy. Correction of the immune deficiency through bone marrow transplant does not alter the course of central nervous system deterioration. Death usually occurs before puberty, most frequently as a consequence of lymphoreticular malignancies or of the rupture of telangiectatic cerebral blood vessels.

3. IL-2 Synthesis Deficiency

Combined immunodeficiency associated with a deficiency in IL-2 synthesis and IL-2 receptor can be seen in patients with congenital deficiency of CD4⁺ cells as well as in patients with normal numbers of CD4⁺ cells.

Genetics and Physiopathology. In patients with congenital deficiency of CD4⁺ cells, the defect of IL-2 production and IL-2 receptor expression is a direct consequence of the lack of differentiation of this lymphocyte subpopulation. At least in one case of CD4⁺ deficiency, the CD4 gene was identified in the patient's cells, although no transcription products could be detected. Thus, the defect may result either from minor gene alterations, undetectable by our current methodologies, or from lack of transcriptional activation of a normal gene.

In patients with normal numbers of CD4⁺ T cells, the defect can be found in a mutated IL-2 gene or in the system of second messenger molecules and transacting proteins (particularly NF-AT), which mediate the activation of cellular genes after antigenic or mitogenic stimulation.

Clinical Presentation. In general the affected children have a very early onset of symptoms and suffer from both opportunistic and bacterial infections. Immunoglobulin levels tend to be decreased, and antibody responses after active immunization are subnormal.

Diagnosis. In cases of CD4⁺ deficiency these cells are absent or detected in very low numbers. In cases due to abnormalities of the IL-2 gene or due to abnormalities in the signaling pathway that leads to expression of the IL-2 gene, the number of CD4⁺ cells may be normal. However, the peripheral blood lymphocytes fail to proliferate and to release IL-2 after stimulation with T-cell mitogens, antigens, or CD3 monoclonal antibodies. Definitive diagnosis requires investigation of the molecular defects underlying the disease.

4. Deficient Expression of MHC Molecules

The lack of expression of either MHC-I or MHC-II molecules is associated with combined immunodeficiency.

The bare lymphocyte syndrome (MHC-I deficiency) is characterized by a deficient expression of HLA-A, B, and C markers and absence of β_2 -microglobulin on lymphocyte membranes. In one family the defect has been localized to a mutation of one of the genes coding for one of the transporters associated with antigen processing (TAP-2), essential for proper intracellular assembly of the MHC-I molecules (see Chapter 4).

Although some patients with this syndrome may be asymptomatic, most suffer from infections. In some cases, the infection pattern involving fungi and *Pneumocystis carinii* is consistent with combined immunodeficiency; in other patients, the symptoms are mainly due to infections with pyogenic bacteria. The link between lack of expression of MHC class I markers and humoral immunodeficiency is unclear.

Laboratory findings include lymphopenia, poor mitogenic responses, low immunoglobulin levels, and lack of antibody responses. B cells are usually detected, but plasma cells are absent.

MHC class II deficiency is inherited as an autosomal recessive trait, apparently resulting in abnormal transcription regulation of the MHC genes. It is associated with a severe form of combined immunodeficiency, with absent cellular and humoral immune responses after immunization. These patients have low number of CD4⁺ helper T lymphocytes, which results in lack of differentiation of B lymphocytes into antibody-producing cells. This syndrome provides strong support for the theory suggesting that the interaction between double-positive CD4⁺, CD8⁺ thymocytes and MHC-II molecules is the essential stimulus for the differentiation of CD4⁺ helper T lymphocytes.

The patients often have protracted diarrhea, secondary to infections with *Candida albicans* or *Cryptosporidium parvum*, leading to malabsorption and failure to thrive. Pulmonary infections are also frequent. Residual cytotoxic T-cell function is reflected by the ability of these children to reject grafted cells and tissues. The prognosis is very poor. Death tends to occur before the second decade of life unless the deficiency is corrected by bone marrow transplant.

Laboratory findings include normal counts of CD3⁺ lymphocytes associated to low numbers of CD4⁺ cells. The expression of MHC-II molecules in monocytes and/or B cells is absent or very low (less than 5% of normal). Definitive diagnosis requires molecular studies to characterize the responsible gene mutations.

5. *Immunodeficiency with Thrombocytopenia and Eczema (Wiskott-Aldrich Syndrome)*

Genetics and Pathogenesis. This is another immune disorder with an X-linked recessive pattern of inheritance. The associated gene has been located to Xp11.23, which encodes the protein known as Wiskott-Aldrich syndrome protein (WASP). This protein is expressed by hematopoietic cells and appears to play a role in actin polymerization and cytoskeleton arrangement. The mutations are associated with either lack of synthesis or with synthesis of an abnormal WASP. In the absence of functional WASP hematopoietic cells demonstrate abnormal size, shape, and function that is most apparent in platelets and lymphocytes. Platelets are small in size, aggregate poorly, and are sequestered and destroyed in the spleen. T lymphocytes are also smaller than normal and show disorganization of the cytoskeleton and loss of microvilli. Directed traffic of cytokines and expression of co-stimulatory molecules (see Chapters 4 and 11) are likely to be affected.

Clinical Presentation. Eczema, thrombocytopenia, and frequent infections characterize the Wiskott-Aldrich syndrome. Most frequently the infections are caused by viruses, such as herpes simplex, varicella-zoster, and molluscum contagiosum. Increased frequency of infections with encapsulated pyogenic bacteria, such as *Streptococcus pneumoniae*, *Neisseria meningitidis*, and *Haemophilus influenzae*, can also be seen. Later in life patients can suffer from all types of opportunistic infections, reflecting a deterioration of both cell-mediated and humoral immune functions. There is an increased frequency of autoimmune diseases, particularly autoimmune hemolytic anemia and rheumatoid arthritis. Hemorrhage is the most frequent cause of death, but some children develop opportunistic infections or lymphoreticular malignancies that can have a fatal evolution.

Laboratory Findings. The finding of profound thrombocytopenia with small-sized platelets very early in life is often the first clinical sign of Wiskott-Aldrich syndrome. Platelets are characterized as small and dysmorphic. Definitive diagnosis requires either molecular studies revealing mutations of the WASP gene or absence of the WASP mRNA or WASP protein in peripheral blood lymphocytes.

Several laboratory abnormalities are characteristic of this immune deficiency. These include low IgM levels (the levels of the other immunoglobulin isotypes may be low, normal, or elevated) and failure to respond to polysaccharide vaccines or to immunizations with neoantigens such as bacterial phage ϕ x174 (see Chapter 28). Lymphocyte count and function are normal in early infancy, but deficient mitogenic and mixed lymphocyte culture responses develop over time.

Therapy. Thrombocytopenia improves following splenectomy. The immunological defects can be corrected by bone marrow transplantation. Replacement therapy with intravenous gamma globulin has been used in some patients.

V. PHAGOCYtic CELL DEFICIENCIES

Cell findings in patients with phagocytic disorders include infections of soft tissues, cellulitis, and chronic recurrent lymphadenitis. Recurrent abscesses in organs such as lung, liver, and bone are also frequent. Commonly these infections are due to *Staphylococcus* sp., *Pseudomonas* sp., *Candida* sp., and *Aspergillus* sp. Chronic or recurrent oral ulcers, poor wound healing, periodontal disease, and delayed separation of the umbilical cord are early hallmarks of deficiencies in phagocytic cell function or numbers. Phagocytic function

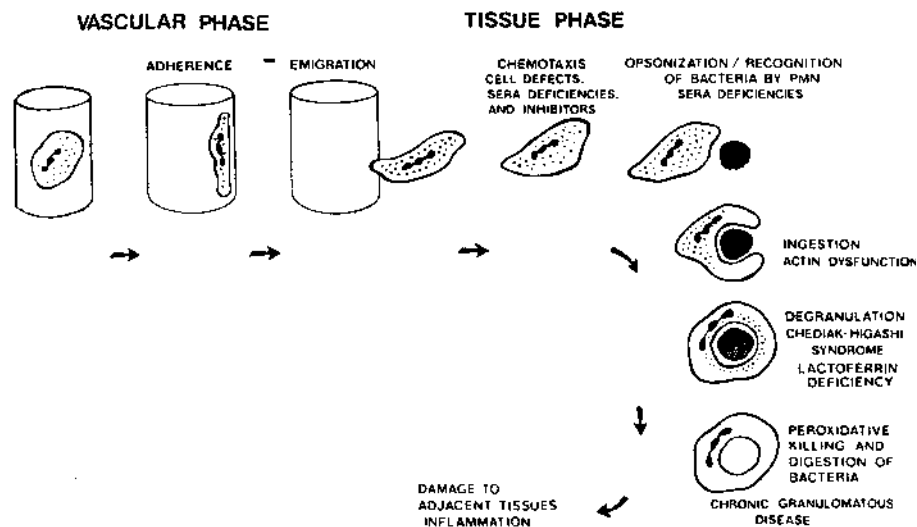

Fig. 29.1 Diagrammatic representation of the major primary functional derangements of neutrophils characterized in humans. (Reproduced with permission from Wolach, B., Baehner, R. L., and Boxer, L. A., *Israel J. Med. Sci.* 18:897, 1982.)

dysfunction can result from either quantitative or qualitative defects in phagocytic cells. Figure 29.1 diagrammatically illustrates the aspects of PMN function that can be affected in different pathological situations.

A. Disorders of Leukocyte Adherence

The most common among these very rare disorders is the lack of expression of the CD11/CD18 complex, which affects phagocytic cells and T lymphocytes. This disease is inherited as an autosomal recessive trait. Initial clinical manifestations include delayed separation of the umbilical cord and chronic leukocytosis. During childhood, these individuals suffer from repeated pyogenic infections and, with less frequency, fungal infections. Severe necrotizing gingivitis and periodontal disease is common.

B. Job's Syndrome (Hyper-IgE Syndrome)

Chronic severe atopic dermatitis, very high levels of serum IgE, and recurrent staphylococcal infections of the lungs and cutaneous abscesses characterize this syndrome. Inheritance is often autosomal dominant. Other types of pyogenic infections, particularly of the upper airways, and chronic candidiasis can also be present.

The mechanism of this disease has not been well defined. A defect of monocyte chemotaxis has been reported in most patients, but the severity is quite variable. It is unlikely that this is the primary defect leading to immune deficiency. The high levels of IgE correspond, at least in part, to the production of IgE anti-*S. aureus* antibodies. In contrast, IgA antibodies to *S. aureus* are abnormally low, and other indices of humoral immune function (responses to toxoid boosters and to in vitro stimulation with PWM) are also depressed.

C. Chronic Granulomatous Disease

Chronic granulomatous disease (CGD), although rare, is the most frequent primary phagocytic cell deficiency. The majority of cases are inherited as an X-linked trait, but autosomal recessive inheritance is involved in 25–35% of the cases.

The molecular basis of CGD is heterogeneous. The X-linked form is the result of a mutation in the heavy-chain (91 kDa) phosphoprotein (alphox) of cytochrome B244. Molecular genetic studies have shown that in about half of the cases of X-linked CGD there is a failure to express mRNA for the alphox protein and in the remainder of cases, mRNA is present but there is a failure to transport or properly insert the protein in the cytoplasmic membrane. The remaining cases of CGD are inherited as autosomal recessive traits, involving other cytochrome proteins such as P47, p67, or the light chain (22 kDa) of cytochrome B.

All of the cytochrome B deficiencies result in a lack of functional oxidase at the cell membrane level. There is a failure to generate superoxide and H_2O_2 , and consequently, intracellular killing is defective. Both types of professional phagocytic cells (PMN leukocytes and monocytes) are affected.

The killing defect leads to infections with catalase-positive organisms such as Staphylococci, *Serratia marscecens*, *Klebsiella* sp., *Aerobacter* sp., *Salmonella* sp., *Chromobacterium violaceum*, *Pseudomonas cepacia*, *Nocardia* sp., and *Aspergillus* sp. Catalase-negative organisms (such as *Streptococcus pneumoniae*) do not usually cause infections in these patients. The lack of involvement of catalase-negative organisms results from the fact that when ingested by phagocytic cells they continue to generate H_2O_2 that they cannot degrade. The H_2O_2 generated by the bacteria progressively accumulates in the phagosome, eventually reaching bactericidal levels.

The clinical manifestations are dominated by recurrent bacterial and fungal infections. The most frequent infection sites are the lungs, lymph nodes, liver, skin, and soft tissues. The infections are characterized by the formation of microabscesses and noncaseating granulomas. Suppurative lymphadenitis, pyoderma, pneumonia with suppurative complications, liver abscesses, osteomyelitis, and severe periodontal disease are among the most frequently seen infections. Generalized lymphadenopathy and hepatosplenomegaly are frequently found on physical examination. Because the infectious agents are often sequestered within leukocytes or walled-off in granulomas, it is common for blood or tissue cultures to be negative. Most patients have elevated levels of the major immunoglobulins (hypergammaglobulinemia).

Diagnosis is usually confirmed by abnormal results in one of the variations of the NBT reduction test (see Chapter 13).

Infections are treated with antimicrobials chosen on the basis of susceptibility studies if bacteria have been recovered from infection sites. Prophylactic administration of trimethoprim-sulfamethoxazole is generally recommended. Interferon- γ administration has been found to result in a decrease in the frequency of infectious episodes in some patients with CGD. Early trials suggested that interferon- γ enhanced the neutrophil respiratory burst and that the effect was more pronounced in patients with the autosomal variants of CGD.

The identification of the genes coding for the different molecular components of the oxidase system has led to trials of gene therapy by using retroviral vectors to insert the gp91 cytochrome B299 gene into the patient's CD34⁺ stem cells. It is hoped that when these cells are returned to the patient it will result in the emergence of oxidase-positive phagocytic cells.

D. Chédiak-Higashi Syndrome

This rare disease is due to abnormalities in the cytoplasmic granules involved in the formation of the phagosome leading to impaired killing of certain microorganisms. It is believed that the primary defect may be in the regulation of membrane activation. The PMN leukocytes are able to ingest microorganisms, but the cytoplasmic granules tend to coalesce into giant secondary lysosomes, with reduced enzymatic contents, that are inconsistently delivered to the phagosome. As a consequence, intracellular killing is slow and inefficient. NK cell function has also been reported to be impaired.

1. *Clinical Manifestations*

Mucocutaneous albinism, recurrent neutropenia, unexplained fever, and peripheral neuropathy characterize patients with this syndrome. Many patients develop hepatosplenomegaly and lymphadenopathy associated with recurrent bacterial and viral infection, fever, and prostration. End-stage disease is associated with a poor prognosis.

2. *Diagnosis*

The finding of morphological abnormalities in PMN leukocytes (giant lysosomes) supports the diagnosis. Phagocytic cells killing tests show impaired intracellular killing.

3. *Treatment*

Infections are treated symptomatically with antibiotics. Ascorbic acid administration has been shown to increase bactericidal activity in some patients. This improvement may be related to an effect of ascorbic acid on membrane fluidity, which is abnormally high in the patient's PMN leukocytes and is normalized by ascorbic acid.

VI. COMPLEMENT DEFICIENCIES

Deficiencies of virtually all components of the complement cascade have been reported. Clinical findings associated with complement deficiencies are highly variable and dependent on the location of the defect within the complement cascade. Symptoms range from an increased risk for the development of autoimmune disease to recurrent infections. The deficiencies can be grouped as early-component (C1, C2, and C4) deficiencies, late-component (C5 to C9) deficiencies, C3 deficiency, and defects in the alternative complement cascade. The characteristics of these groups are summarized in Table 29.5.

A. Early Component Deficiencies

Deficiencies of C1, C2, and C4 can be asymptomatic, can be associated with predisposition to infections, or, most frequently, can be associated with clinical symptoms suggestive of autoimmune disease. C2 and C4 deficiencies are inherited as an autosomal co-dominant trait and are often associated with a syndrome mimicking systemic lupus erythematosus (SLE), although the clinical evolution is more benign and renal dysfunction is less frequent. Patients with homozygous C2 or C4 deficiency often have associated defects in factor B. Recurrent viral and bacterial infections are common. Persistent levels of circulating immune complexes are often found in patients with C2 or C4 deficiency, probably as a result

Table 29.5 Main Characteristics of Primary Complement Deficiencies Using Common Variable Immunodeficiency as a Term of Reference

Characteristic	Common variable immune deficiency	Early complement component deficiencies		Late complement component deficiencies
			C3 deficiency	
Genetics	Variable	Autosomal codominant	Autosomal recessive	Variable
Molecular basis	Variable, ill defined	Lack of synthesis	Lack of synthesis	Lack of synthesis
Lymphoid tissues	Follicular necrobiosis, reticulum cell hyperplasia	Normal	Normal	Normal
B lymphocytes	Normal numbers, abnormal differentiation or function	Normal	Normal	Normal
Serum immunoglobulins	Low to very low levels	Normal to high	Normal to high	Normal to high
Infections	Bacterial, parasitic (<i>Giardia</i>)	Pyogenic bacteria	Pyogenic bacteria	Capsulated bacteria, esp. <i>N. meningitidis</i>
Autoimmunity	Rheumatoid arthritis	SLE-like syndrome	Vasculitis, glomerulo nephritis	None

of altered dynamics of immune complex clearance. As a result of low levels of C2 or C4 and due to the interruption in the activation sequence, these patients do not generate normal amounts of C3b.

B. C3 Deficiency

Primary C3 deficiency is a rare condition, transmitted as an autosomic recessive trait. Patients with C3 deficiency have an inability to opsonize antigens and suffer from recurrent pyogenic infections from early in life, with a clinical picture similar to that of X-linked infantile agammaglobulinemia with normal B- and T-cell function. This is not surprising, given the pivotal role played by C3 in complement activation and in opsonization of microbial agents. Furthermore, C3-deficient patients may present manifestations of immune complex disease, such as glomerulonephritis and vasculitis.

Factor I (C3b inactivator) and factor H deficiencies result in a deficiency of C3 secondary to a fourfold increase in the catabolic rate of this complement component. Patients are prone to recurrent pyogenic infections, particularly with encapsulated bacteria such as *S. pneumoniae* and *N. meningitidis*. They are also prone to the development of immune complex disease. "Anaphylactoid" reactions secondary to the spontaneous generation of C3a are also frequently observed in these patients.

C. Late Component Deficiencies

Deficiencies of C5, C6, C7, C8, and C9, complement compounds that make up the membrane attack complex, have been reported to be associated with increased frequency of infections, most commonly due to bacteria with polysaccharide-rich capsules such as *Neisseria* sp.

Case 29.1 Revisited

The prevalence of bacterial infections (pneumonia, pyoderma) caused by classic pyogenic organisms (e.g., Haemophilus influenzae) is strongly suggestive of humoral immunodeficiency. The lack of adverse reactions after the usual childhood immunizations, which include several attenuated viruses, and the uneventful course of chickenpox strongly indicates that cell-mediated immunity is probably normal.

The clinical spectrum of the humoral immunity deficiency, apparent integrity of cell-mediated immunity, normal numbers of B lymphocytes, and age of onset (in later childhood) points to a diagnosis of variable immunodeficiency. The pattern of inheritance is variable but in this case is most likely autosomal recessive. Male and female children have an equal chance of carrying the same disease. Diagnosis would be impossible in the neonatal and early infancy period, since any child born to this mother would be severely hypogammaglobulinemic and likely to suffer from bacterial infections. Also, the onset of disease could be delayed for several years.

Two types of tests could be valuable in this patient: the assay of anti-H. influenzae antibodies (was negative), and a lymphocyte transformation assay, measuring IL-2 release after stimulation with PHA and anti-CD3 monoclonal antibodies. Patients with common variable immunodeficiency often show abnormal mitogenic responses, low gp39 expression, and subnormal IL-2 release after T-cell mitogenic stimulation, suggesting that the basis of the disease is lack of T-cell help.

As in infantile agammaglobulinemia, chronic obstructive lung disease and bronchiectasis are likely to develop as a consequence of having repeated bronchopulmonary infections.

The best treatment for this condition is the administration of intravenous gamma globulin. The periodicity of administration needs to be established for each individual patient, based on the longitudinal variation in serum immunoglobulin levels and on the duration of the symptom-free period after gamma globulin administration. In most cases, administrations of IV gamma globulin need to be repeated every 3–4 weeks.

SELF-EVALUATION

Questions

Choose the one *best* answer.

- 29.1 What is the most frequent clinical presentation of IgA deficiency?
- A. Anaphylactic reactions due to IgA antibodies
 - B. Diarrhea and malabsorption
 - C. No specific symptoms
 - D. Pyogenic infections involving capsulated bacteria
 - E. Upper respiratory infections

- 29.2 Gamma globulin administration is *not* indicated in cases of:
- Combined IgA/IgG2 deficiency
 - Common, variable immunodeficiency (“acquired” agammaglobulinemia)
 - Infantile agammaglobulinemia
 - Isolated IgA deficiency
 - Transient hypogammaglobulinemia of infancy

Questions 29.3 and 29.4 refer to the following case history: A previously healthy 6-month-old boy suddenly fell ill with a life-threatening *Pneumocystis carinii* pneumonia. WBC were 5200/ μ L (15% neutrophils, 70% lymphocytes). Serum immunoglobulin levels were IgG: 120 mg/dL; IgA: undetectable; IgM: 1100 mg/dL; isoagglutinin A titer: 16; CD3⁺ lymphocytes in peripheral blood: 1100/ μ L; CD19⁺ lymphocytes in peripheral blood: 80/ μ L; mitogenic responses of T lymphocytes to stimulation with PHA and monoclonal antibody to CD3 were within normal limits. PWM stimulation of mononuclear cells was followed by the release of 2 μ g of IgM/10⁶ cells at day 7; no IgG was detected.

- 29.3 The most likely diagnosis in this case is:
- Common, variable immunodeficiency
 - Hyper-IgM syndrome
 - IgA deficiency
 - Infantile agammaglobulinemia (Bruton’s disease)
 - Neutropenia
- 29.4 The molecular basis of the immunodeficiency affecting this patient is:
- Abnormal differentiation of granulocytes
 - Deficiency of the ZAP tyrosine kinase
 - Deficient release of IL-2 by activated T cells
 - Lack of Bruton’s tyrosine kinase
 - Lack of interaction between CD40 and CD40L
- 29.5 An IgA-deficient patient is scheduled for surgery and in the preoperative work-up found to be A, Rh-positive and to have a high titer of IgA antibodies. The best medical management for this patient if a blood transfusion became necessary would be infusion of:
- A, Rh-positive blood from an IgA-deficient donor
 - AB, Rh-positive blood
 - O, Rh-positive blood
 - Frozen plasma
 - Packed A, Rh-positive red cells
- 29.6 Which one of the following investigations would you rank with the *lowest* priority in a patient found to have a level of serum IgA of less than 10 mg/dL?
- Assay of IgG subclasses
 - Determination of IgA antibodies
 - Enumeration of lymphocyte subsets
 - Measurement of antibody levels to common antigens
 - Study of the response to active immunization with toxoids and polysaccharides

In Questions 29.7–29.10 match each word or phrase with the lettered heading most closely related to it. Each lettered heading may be selected once, more than once, or not at all.

- A. Adenosine deaminase deficiency
 - B. C6 deficiency
 - C. Common, variable immunodeficiency
 - D. DiGeorge syndrome
 - E. Infantile agammaglobulinemia
- 29.7 Absence of CD19⁺ lymphocytes, normal CD3⁺ lymphocytes
- 29.8 Associated with frequent infections with *Neisseria* sp.
- 29.9 CD19⁺ lymphocytes normal or elevated in number, total serum immunoglobulin concentration under 300 mg/dL
- 29.10 Patients often have cardiac abnormalities and facial dysmorphism

Answers

- 29.1 (C) Most IgA-deficient patients are asymptomatic; infections are more frequently seen when IgA deficiency is associated with IgG2 deficiency; anti-IgA antibodies are relatively rare.
- 29.2 (D) In isolated IgA deficiency gamma globulin, administration is not likely to be beneficial because the commercial gamma globulin preparations contain very little IgA, and even if IgA was administered its relative short half-life would result in its rapid disappearance from circulation.
- 29.3 (B) The presentation of opportunistic infections in a young boy with low to undetectable levels of IgG, IgA IgD, and IgE and high levels of IgM is diagnostic of the X-linked form of the hyper-IgM syndrome. T-cell mitogenic responses are normal, but B lymphocytes do not switch from IgM to IgG synthesis.
- 29.4 (E) The X-linked form of the hyper-IgM syndrome is caused by the lack of expression of CD40. This prevents the signaling of B lymphocytes normally mediated by CD40-CD40 ligand (CD40L) interactions, and the mutual stimulation of T and B cells is impaired. As a consequence, the release of cytokines involved in B-cell differentiation is also impaired, and the patient's B cells fail to differentiate into IgG-producing plasma cells.
- 29.5 (A) In the presence of high titers of IgA antibody, the possibility that IgA-containing blood products may cause a serious transfusion reaction needs to be considered. Ideally, IgA-deficient A, Rh-positive blood should be used. If this is not possible, extensively washed and packed A, Rh⁺ cells should be used (packed, not washed red cells contain at least 20% plasma).
- 29.6 (C) There is no evidence that IgA deficiency is associated with an imbalance of lymphocyte subpopulations. All other investigations would be useful to define the extent of the patient's immunodeficiency.
- 29.7 (E) In contrast to what is seen in patients with common, variable immunodeficiency, infants with infantile agammaglobulinemia have a marked depression or absence of B cells in the peripheral blood.
- 29.9 (B) *Neisseria* infections are characteristically frequent in patients with deficiency of the late complement components (C5–C9).

- 29.9 (C) Patients with common, variable immunodeficiency have normal to elevated counts of CD19⁺ lymphocytes. However, due to a variety of defects, some intrinsic to the B cells and some affecting regulatory T cells, their humoral immune responses are severely impaired. A reflection of that fact is that total serum immunoglobulin concentrations (calculated adding the concentrations of IgG, IgA, and IgM) are markedly depressed, usually under 300 mg/dL.
- 29.10 (D) Infants with the DiGeorge syndrome have combined aplasia of the thymus and parathyroids and other congenital abnormalities of the facial bones, heart and large vessels.

BIBLIOGRAPHY

- Advances in Primary Immunodeficiency (The Jeffrey Modell Immunodeficiency Symposium). *Clin. Immunol. Immunopath.* 76 (no. 3, part 2):S145, 1995.
- Cavazzana-Calvo, M., Hacein-Bey, S., de Saint Basile, G., et al. Gene therapy of human severe combined immunodeficiency (SCID)-X1 disease. *Science* 288:669, 2000.
- Chandra, R. K. Cellular and molecular basis of nutrition-immunity interactions. *Adv. Exp. Med. Biol.* 262:13, 1990.
- Conley, M. E., Notarangelo, L. D., and Eizioni, A. Diagnostic criteria for primary immunodeficiencies. *Clin. Immunol.* 93:190–197, 1999.
- Cunningham-Rundles, C. Clinical and immunologic analysis of 103 patients with common variable immunodeficiency. *J. Clin. Immunol.* 9:22, 1989.
- MacCarthy, L., Gaspar, H. B., Wang, Y-C., Katz, F., Thompson, L., Layton, M., Jones, A. M., and Kinnon, C. Absence of expression of the Wiskott-Aldrich syndrome protein in peripheral blood cells of Wiskott-Aldrich syndrome patients. *Clin. Immunol. Immunopath.* 88:22–27, 1998.
- Ochs, H. D. The Wiskott-Aldrich syndrome. *Semin. Hematol.* 35:332, 1998.
- Rosen, F. S., Cooper, M. D., and Wedgwood, R. J. P. The primary immunodeficiencies. *N. England J. Med.* 333:431, 1995.
- Virella, G. Humoral immunity, and complement. In *Infections in Immunocompromised Infants and Children*, Patrick, C. C., Ed. Churchill-Livingstone, New York, 1992.
- WHO Scientific Group. Primary immunodeficiency diseases. *Clin. Exp. Immunol.* 99 (Suppl. 1), 1995.
- Yocum, M. W., and Kelso, J. M. Common variable immunodeficiency: The disorder and the treatment. *Mayo Clin. Proc.* 66:83, 1991.
- Zhou, Z., Huang, R., Danon, M., et al. IL-10 production in common variable immunodeficiency. *Clin. Immunol. Immunopath.* 86:298, 1998.

30

AIDS and Other Acquired Immunodeficiency Diseases

Gabriel Virella

I. INTRODUCTION

Many factors influencing the function of the immune system can lead to variable degrees of immunoincompetence. Infections, exposure to toxic environmental factors, physical trauma, and therapeutic interventions can all be associated with immune dysfunction (see Table 30.1). In some cases the primary disease that causes the immunodeficiency is very obvious, while in others a high degree of suspicion is necessary for its detection. The pathogenic mechanisms are very clear in some cases and totally obscure in others. The following is a brief summary of some of the most common secondary immunodeficiencies, followed by a more detailed discussion of the acquired immunodeficiency syndrome (AIDS).

Case 30.1

A 30-year-old male is seen by his family physician with a 3-week history of headaches, dry cough, and shortness of breath with exertion that was increasingly severe and a 40-lb. weight loss over 6 months. He was noted to have a fever of 100.5°F and clear lungs. He became more dyspneic and was seen 3 days later with cough productive of white sputum and severe dyspnea with exertion. Arterial blood gases showed a PO_2 of 38 mmHg. He started noting difficulty swallowing solid food at that time. On physical exam he was a thin male in no apparent distress sitting in bed. Vital signs were: temperature 100°F, pulse 100/min, respiration 28/min, BP 116/84, weight 110 lb. There were white plaques on the tongue and buc-

Table 30.1 Causes of Secondary Immunodeficiency

Malnutrition
Systemic disorders
Immunoglobulin hypercatabolism
Excessive loss of immunoglobulins
Renal insufficiency
Extensive burns
Drug-induced
Cytotoxic drugs
Glucocorticoids
Antimalarial agents
Captopril
Carbamazepine
Fenclonofac
Gold salts
Phenytoin
Sulfasalazine
Alcohol, cannabinoids, opiates
Surgery
Malignancies
B-cell and plasma cell malignancies
Immunodeficiency with thymoma
Non-Hodgkin's lymphoma
Infectious diseases
HIV
Congenital rubella
Congenital CMV infection
Congenital toxoplasmosis
Epstein-Barr virus

*cal mucosa that could be removed with a tongue depressor. There was an occasional wheeze but otherwise clear lung fields. He was noted to become dyspneic with conversation or walking across the room. The WBC count was 10,000 / μ L with 86% neutrophils and 5% lymphocytes. Hemoglobin was 11.7 g/dL, and hematocrit was 34%. Chest x-ray showed diffuse granular opacities over both lung fields. Sputum Gram stain and culture were negative. A broncho-alveolar lavage examination was positive for *Pneumocystis carinii*.*

This case raises several questions:

What type of immunodeficiency could be affecting this patient?

Is there evidence for another infection besides pneumonia?

What test(s) should be ordered to investigate the status of the immune system?

Is the patient at risk for any other type of infection?

What therapeutic and prophylactic measures should be taken?

II. SECONDARY IMMUNODEFICIENCIES

A. Immunodeficiency Associated with Malnutrition

Immunodeficiency secondary to malnutrition has been reported in association with generalized malnutrition or in association with vitamin, mineral, and trace element deficiencies.

Severe protein-calorie malnutrition is primarily associated with a depression of cell-mediated immunity. Different groups have reported anergy, low T-lymphocyte counts, depressed lymphocyte reactivity to PHA, and depressed cytokine release in malnourished populations. In kwashiorkor, which is due to a combination of protein-calorie malnutrition and deficiency in trace elements and vitamins, the degree of immunodeficiency seems to be more profound. Affected children seem to have a delayed maturation of the B-cell system and often have low levels of mucosal IgA, without apparent clinical reflection. Efforts to study the humoral immune response to active immunization have yielded variable results. The complement system and neutrophil functions have been reported as depressed, but the phagocytic impairment is mild and depressed complement levels seem to be primarily a result of consumption as a consequence of infections.

Several causes for the immune deficiency associated with malnutrition have been suggested, including general metabolic depression, thymic atrophy with low levels of thymic factors, depressed numbers of helper T lymphocytes (which could account for the variable compromise of humoral immunity), and impaired cytokine release. A practical consideration to bear in mind is that malnourished children should not be vaccinated with live, attenuated vaccines, which are generally contraindicated in immunodeficient patients.

B. Immunodeficiency Associated with Zinc Deficiency

The significance of zinc deficiency for the normal functioning of the immune system is underlined by observations performed in patients with acrodermatitis enteropathica, a rare congenital disease in which diarrhea and malabsorption (affecting zinc, among other nutrients) play a key pathogenic role. Affected patients often present with epidermolysis bullosa and generalized candidiasis, associated with combined immunodeficiency that can be corrected with zinc supplementation.

Secondary zinc deficiency are considerably more frequent and can develop as a consequence of low meat consumption, high-fiber diet, chronic diarrhea, chronic kidney insufficiency, anorexia nervosa and bulimia, alcoholism, diabetes, psoriasis, hemodialysis, parenteral alimentation, etc. The depletion caused by these conditions does not seem to be severe enough to cause symptomatic immunodeficiency, but it may be one of several factors adversely affecting the immune system.

The basis for the depression of cell-mediated immunity in zinc deficiency is not fully known, but it has been proposed that zinc may be essential for the normal activity of cellular protein kinases involved in signal transduction during lymphocyte activation.

C. Immunodeficiency Associated with Vitamin Deficiencies

Several vitamin deficiencies are associated with and are presumably the cause of abnormalities of the immune response, particularly when associated with protein-calorie malnutrition. The molecular mechanisms underlying these deficiencies have not been defined. Deficiencies of pyridoxine, folic acid, and vitamin A are usually associated with cellular immunodeficiency. Panthotenic acid deficiency is usually associated with a depression of the primary and secondary humoral immune responses. Vitamin E deficiency is associated with a combined immunodeficiency.

D. Immunodeficiency Associated with Renal Failure

Patients with renal failure have depressed cell-mediated immunity, as reflected in cutaneous anergy, delayed skin graft rejection, lymphopenia, and poor T-lymphocyte responses

to mitogenic stimulation. Humoral immunity can also be affected, particularly in patients with the nephrotic syndrome, who may lose significant amounts of IgG in their urine. Several factors seem to contribute to the depression of cell-mediated immunity in patients with renal failure:

1. Release of a soluble suppressor factor, as shown by experiments demonstrating that plasma or serum from uremic patients suppresses the mitogenic responses of normal lymphocytes *in vitro*. The responsible factors have a molecular weight less than 20,000, and it has been suggested that methylguanidine and “middle molecules” (molecular weight 1200) are responsible. These molecules can be isolated from uremic sera and have been shown to suppress *in vitro* mitogenic responses of normal T lymphocytes.
2. In dialyzed patients there is a paradoxical activation of the immune system, which results in excessive and unregulated release and consumption of IL-2, resulting in decreased bioavailability of this cytokine.
3. Fc-mediated phagocytosis is impaired in patients with severe renal failure, perhaps secondary to increased levels of endogenous glucocorticoid levels. There is also evidence of a compromise of the capacity of monocytes to function as antigen-presenting cells. These abnormalities are reproducible when normal monocytes are incubated with uremic serum. Dialysis may accentuate the problem as a consequence of complement activation in the dialysis membranes, which causes a poorly understood downregulation of the expression of CAMs by phagocytic cells.
4. Patients with chronic renal failure secondary to autoimmune diseases are often treated with immunosuppressive drugs that further compromise the immune system.

E. Burn-Associated Immunodeficiency

Bacterial infections are a frequent and severe complication in burn patients, often leading to death. Several factors may contribute to the incidence of infections in burned patients, including the presence of open and infected wounds, a general metabolic disequilibrium, and a wide spectrum of immunological abnormalities.

Depressed neutrophil function is a major factor contributing to the lowered resistance to infection. Defective chemotaxis and reduced respiratory burst are the most prominent abnormalities. Several factors may contribute to this depression:

1. Exaggerated complement activation (mostly by proteases released in injured tissues) causes the release of large concentrations of C5a, which may disturb proper chemotactic responses and cause massive activation of granulocytes. When the already activated granulocytes reach the infected tissues, they may no longer be responsive to additional stimulation.
2. Bacterial endotoxin, prostaglandins, and β -endorphins have been suggested as additional factors that adversely affect phagocytic cell functions. The involvement of prostaglandins has been supported by studies in experimental animals, in which administration of cyclooxygenase blockers normalizes phagocytic cell functions.
3. Another contributing factor seems to be the low opsonizing power of the burn blister fluid, which has very low levels of both complement and immunoglobulins.

Impairment of cell-mediated immunity is suggested by a prolongation of skin homograft survival and depressed delayed-hypersensitivity responses. Laboratory studies show have documented low responses to mitogenic stimuli and depressed mixed lymphocyte culture reactions. A major functional abnormality of T lymphocytes isolated from burned patients is their depressed release of IL-2 after mitogenic stimulation. This depression may be secondary to the release of immunosuppressive factors by the burned tissues, including a 10 kDa glycopeptide, a 1000 kDa lipid-protein complex, and PGE₂, released by overactive monocytes, which causes an increase of intracellular cAMP in T cells, resulting in an inhibition of cell proliferation.

F. Iatrogenically Induced Immune Deficiencies

A wide range of therapeutic interventions has been shown to cause functional depression of the immune system. At the top of the list is the administration of cytotoxic/immunosuppressive drugs (see Chapter 24), but many other medical procedures have unexpected effects on the immune system.

1. Neutropenia

The reduction of the total number of neutrophils is the most frequent cause of infection due to defective phagocytosis. Although there are rare congenital forms of neutropenia of variable severity, most frequently neutropenia is secondary to a variety of causes (see Table 30.2). Administration of cytotoxic drugs is almost inevitably followed by neutropenia (see Chapter 24), but a variety of drugs of other groups may cause idiosyncratic neutropenia with variable frequency.

2. Postsurgery Immunodeficiency

Both surgery and general anesthesia are associated with transient depression of immune functions, affecting the mitogenic responses of PBL, cutaneous hypersensitivity, and antibody synthesis. Multiple factors seem to contribute to the depression of the immune system (Fig. 30.1):

A transient severe lymphopenia can occur in the immediate postoperative period. Exaggerated release of PGE₂, due to the posttraumatic activation of inflammatory cells, depresses T-lymphocyte and accessory cell functions.

Table 30.2 Causes of Neutropenia

Congenital
Secondary (acquired)
Depressed bone marrow granulocytosis
Drug-induced
Tumor invasion
Nutritional deficiency
Unknown cause (idiopathic)
Peripheral destruction of neutrophils
Autoimmune (Felty's syndrome ^a)
Drug-induced

^a An association of rheumatoid arthritis, splenomegaly, and neutropenia.

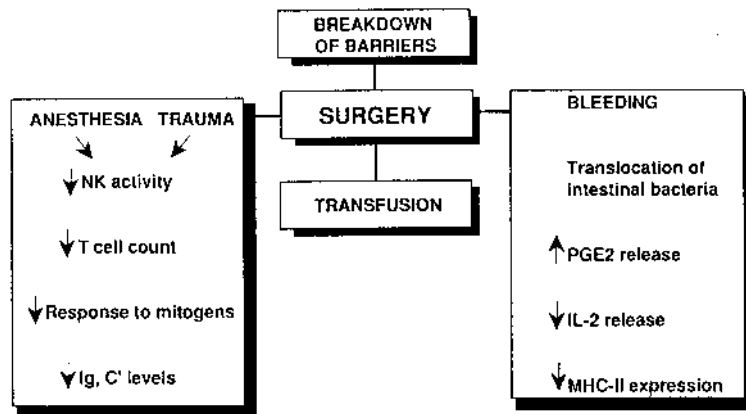

Fig. 30.1 Diagrammatic representation of the different factors contributing to the immune suppression associated with surgery.

Blood loss can be associated with a reduction of IL-2 release by activated T lymphocytes and of MHC-II expression by accessory cells and with reduced B-lymphocyte responses to antigenic stimulation.

Transfusions have a poorly understood immunosuppressive effect.

Anesthesia and administration of opiates (as painkillers) can lead to a depression of phagocytic cell functions and to a reduced activity of NK cells.

Complete normalization of immune function may take 10 days (for mitogenic responses) to a month (for delayed hypersensitivity reactions and the humoral immune response).

It also needs to be kept in mind that postsurgical infection is facilitated by a variety of factors associated with surgery, which even in its simplest form is traumatic to the patient. For example, the surgical incision disrupts the integrity of the skin, a very important barrier against infection. Special types of surgery, such as intestinal surgery, promote spreading of bacteria from a highly contaminated organ into surrounding tissues. The introduction of intravenous lines and catheters, often associated with surgical procedures, opens new routes for the penetration of opportunistic agents. Severe blood loss during surgery can cause massive entrance of intestinal bacteria into the portal circulation and, subsequently, into the systemic circulation (phenomenon known as *bacterial translocation*). If one adds a depressed immune system to these factors, it is easy to understand the clinical significance of postsurgical infection.

3. Splenectomy

Splenectomy deserves special reference as a cause of immune depression. The removal of the spleen represents the loss of an important filtration organ, very important for the removal of circulating bacteria. In addition, the spleen plays a significant role in recruiting immunocytes in the initial phases of the immune responses. Splenectomized patients are weakly responsive to polysaccharides, and if we add this fact to the inability to remove bacteria, particularly those with polysaccharide capsules, from circulation, it is easy to understand why splenectomized patients are prone to severe septicemia. The most

commonly offending organisms include *Streptococcus pneumoniae* (50% of the cases), *Haemophilus influenzae*, and *Neisseria meningitidis*—all of them pyogenic bacteria with antiphagocytic polysaccharide capsules. Other organisms involved as frequent causes of infection in splenectomized patients include *Staphylococcus aureus* and group A *Streptococcus*. It has also been demonstrated that about one third of the cases of human infection by *Babesia*, an intracellular sporozoan, have occurred in splenectomized patients.

Similar defects are noticed in patients with sickle cell anemia, who develop splenic atrophy as a consequence of repeated infections and fibrosis (autosplenectomy). Noteworthy is the fact that patients with sickle cell anemia are particularly prone to develop salmonella bacteremia involving strains of *Salmonella enteritidis*, which do not disseminate in the blood stream of normal individuals. This allows *S. enteritidis* to spread to organs other than the intestine, namely the bones (*S. enteritidis* is the most frequent cause of osteomyelitis in patients with sickle cell anemia).

4. Thymectomy

Thymectomy is frequently done in neonates with congenital heart disease to ensure proper surgical access. It is generally believed that thymectomy after birth has few (if any) effects on the development of the immune system of humans, and there is no conclusive evidence suggesting otherwise.

G. Immunosuppression Associated with Drug Abuse

There is considerable interest in defining the effects of drug abuse on the immune system. Unfortunately, most data concerning the immunological effects of drugs of abuse are based on in vitro experiments or on studies carried out with laboratory animals, which may or may not reflect the in vivo effects of these compounds in humans.

1. Alcohol

Chronic alcoholism is associated with a depression of CMI, but it could be argued that factors other than ethanol consumption, such as malnutrition and vitamin deficiencies, could be the major determinants of the impairment of the immune system. A direct effect of ethanol is supported by animal experiments, in which both T-lymphocyte functions and B-lymphocyte responses to T-dependent antigens are compromised after 8 days of ethanol administration.

2. Cannabinoids

There is little concrete evidence for an immunosuppressive effect of cannabinoids in humans, except for depressed results in in vitro T-lymphocyte function tests and an increased incidence of herpes genitalis among young adults who use cannabinoids. In laboratory animals, cannabinoid administration predominantly affects T- and B-lymphocyte functions, increases the sensitivity to endotoxin, and increases the frequency of infections by intracellular agents, such as *Listeria monocytogenes*. However, the conditions of administration of these compounds to laboratory animals are rather different from the conditions surrounding their use as recreational drugs.

3. Opiates

Cocaine has been shown to have direct effects on human T lymphocytes in vitro, but the required concentrations greatly exceed the plasma levels measured in addicts. The results of studies carried out in addicts have been contradictory.

Intravenous heroin use is associated with a high frequency of infections. In many instances, the infection (thrombophlebitis, soft tissue abscesses, osteomyelitis, septic arthritis, hepatitis B and D, and HIV) seems clearly related to the use of infected needles, but in other cases (bacterial pneumonia, tuberculosis), the infection could result from a depression of the immune system. However, to date no conclusive evidence supporting a depressive effect of heroin over the immune system has been published

H. Immunosuppression Associated with Infections

A wide variety of infectious agents have acquired the ability to thwart the immune system in a variety of ways and, in doing so, ensuring their ability to survive in the host for at least the time necessary for their replication.

1. Bacterial Infections

Disseminated mycobacterial infections are often associated with a state of anergy. The patients fail to respond to the intradermal inoculation of tuberculin and other antigens, and their in vitro lymphocyte responses to PHA and to mycobacterial antigens are depressed. The mechanisms leading to anergy are poorly understood and probably involve more than a single factor:

An increased production of IL-10 and IL-4 could reduce the activity of T_H1 helper lymphocytes, thus depressing cell-mediated immunity.

Mycobacteria infect phagocytic monocytes, and intracellular infection is associated with a depression of both the antigen-presentation capacities and the ability to deliver co-stimulatory signals to T lymphocytes (for example, the expression of CD80/86 is depressed). In addition, infected monocytes/macrophages may release nitric oxide, which inactivates lymphocytes in the proximity of the infected cells.

The release of soluble immunosuppressor compounds has been demonstrated for several bacteria. Several different substances, including enzymes (ribonuclease and asparaginase), exotoxins (such as staphylococcal enterotoxins), and other proteins, have been shown to have immunosuppressive properties, although probably their effects are limited to reducing the specific anti-infectious immune response. The staphylococcal enterotoxins are part of a group of bacterial proteins known as superantigens (see Chapter 14) in vitro most superantigens have stimulatory properties, but when administered in vivo they induce generalized immunosuppression (perhaps as a consequence of indiscriminate nonspecific T-cell activation).

2. Parasitic Infections

Parasitic infections due to protozoa seem to be often associated with suppression of the immune response to the parasite itself. In some cases, however, there is evidence of the induction of a more generalized state of immunosuppression. For example, acute infections with *Trypanosoma cruzi* are associated with CMI depression that can be easily reproduced

in laboratory animals. In both humans and experimental animals, there is a reduced expression of IL-2 receptors, which can be interpreted as resulting from a downregulation of T_H1 cells, either by cytokines or by suppressor compounds released by the parasite. Similar mechanisms seem to account for the generalized immunosuppression observed in experimental animals infected with *Toxoplasma*, *Schistosoma*, *Leishmania*, and *Plasmodia*.

3. Viral Infections

The AIDS epidemic has certainly focused our attention on the interplay between viruses and immunity. However, HIV is certainly not the only virus able to interfere with the immune system. A classical example is the development of a transitory state of anergy during the acute stage of measles, first reported by Von Pirquet in 1908. With the advent of modern immunology this observation was revisited. We now know that during the 3–4 weeks following the acute phase of measles, patients show lymphopenia, and the residual population of peripheral blood lymphocytes shows poor responses to mitogens and antigens such as PHA and *Candida albicans*. The cause of this state of anergy is the release of viral proteins by infected cells that have immunosuppressive properties. A viral nucleoprotein interacts with the FcγR on dendritic cells, and viral envelope glycoproteins interact with the viral hemagglutinin receptor, CD46. The combined effect of the interactions of the viral proteins with their cellular receptors is impaired function of dendritic cells, reduced release of IL-12, and loss of mitogen-induced and antigen-specific T-cell proliferation.

Other viruses, such as cytomegalovirus (CMV) and the rubella virus, can cause immunosuppression. CMV mainly depresses the specific response to the virus, while the rubella virus induces a generalized immunosuppression, similar to that caused by the measles virus. Viruses can also release suppressor factors (Herpes simplex virus secretes a protein similar to IL-10, which can downregulate cytokine release by activated T lymphocytes) and interfere with antigen presentation (adenovirus infection is associated with a depressed expression of MHC-I molecules). However, patients infected with these viruses do not develop generalized immunosuppression, so it seems likely that the significance of these mechanisms is mostly related to promoting conditions favorable for the persistence of the infection.

III. THE ACQUIRED IMMUNODEFICIENCY SYNDROME

AIDS was recognized as a novel clinical entity in 1981–82, when the association of severe immunodepression with increased incidence of *Pneumocystis carinii* pneumonia and Kaposi's sarcoma in homosexual men was first recognized as representing possible variations in the spectrum of a new immunodeficiency disease.

The infectious nature of the syndrome was established in 1983 when Drs. Françoise Barre-Sinoussi and J. C. Chermann, at the Pasteur Institute in Paris, isolated a new retrovirus from the lymph node of a patient with disseminated lymphadenopathy and other symptoms that usually precede the development of AIDS. The new virus was initially named LAV (lymphadenopathy-associated virus) and later received the designation of human immunodeficiency virus (HIV).

Two major variants of HIV have been identified. HIV-1, the first to be isolated, exhibits remarkable genetic diversity, and the different variants have been grouped into

seven different families or clades, differing by 30–35% in their primary structures. HIV-2, prevalent in West Africa, was isolated a few years later. HIV-2 is less virulent than HIV-1, rarely causes full-blown AIDS syndrome, and is not spreading as widely and rapidly as HIV-1.

A. General Characteristics of HIV

HIV-1 and -2 are retroviruses that belong to the Lentiviridae family. Structurally are constituted by two identical strands of (+)RNA associated with matrix proteins, a double protein capsid, and a lipid envelope with inserted glycoproteins. The genome includes the usual retroviral genes:

- gag*, which codes for structural proteins
- pol*, which codes for the reverse transcriptase. In its native form or after fragmentation the *pol* gene product has several enzymatic activities:
 - polymerase
 - ribonuclease
 - endonuclease (integrase, ligase)
- env*, which codes for envelope glycoproteins

In addition, the HIV genome codes for a protease and several regulatory proteins. A gene located at the *gag-pol* junction encodes the protease. The gene is read at a different frame than the structural proteins, and the protease cuts itself free from the large polypeptide chain generated from cell-expressed viral RNA and proceeds to further split the remaining of the polyprotein precursor into several other proteins and peptides. The genes coding for regulatory proteins include:

1. *tat* (transactivator of transcription). Its product, protein p16, binds to a region near the 5' end of a nascent viral RNA strand known as TAR (transactivator response sequence) and promotes full and effective transcription of that strand. Soluble Tat protein (p16) is released by infected cells and taken up by both infected and noninfected cells. When taken up by infected cells it promotes viral genome expression; in noninfected cells it mainly induces transcription of cellular genes, creating ideal conditions for infection of the cell. In low concentrations, it also induces the expression of *bcl-2*, thus protecting the infected cell from apoptosis, an important step to insure full replication. Finally, Tat protein has immunosuppressive effects on noninfected T cells.
2. *rev* (regulator of expression of viral proteins). Encodes for a second protein, p19, which promotes the expression of HIV-1 structural proteins by directing unspliced or single spliced viral mRNA to perinuclear clusters where translation takes place.
3. *nef* (negative expression factor, 25–27 kDa) was believed to have a downregulating effect on viral expression based on in vitro observations; this view has been revised and several important biological properties have been attributed to Nef:

Downregulates MHC-I and CD4 expression facilitating the evasion from the immune response.

Blocks signal transduction pathways by inactivating $p56^{lck}$, a CD4-associated tyrosine kinase whose activity is essential for the activation of

p59^{fyn} and Zap kinase. Thus, the signaling cascade triggered by TcR occupation in CD4⁺ cells is interrupted.

Promotes viral replication.

Finally, several structural proteins result from the expression of the *gag* gene. These proteins are designated by letters designating their general composition (p = protein; gp = glycoprotein) and numbers indicating their molecular weight in kilodaltons (17, 24, 41, 120, 160).

Glycoprotein (gp160) is the major envelope glycoprotein and is composed of a transmembrane segment (gp41) noncovalently bound to the external major glycoprotein (gp120), highly immunogenic. It contains a number of separate regions that are immunogenic, some conserved and others highly variable, and a region that binds to the CD4 molecule. gp41 is believed to be analogous to the fusion-inducing proteins of paramyxovirus. Penetration of HIV into a cell requires initial attachment through the CD4-gp120 interaction, followed by interaction of gp120 with a chemokine receptor (see below) and fusion mediated by gp41 interacting with a possible third receptor, yet to be characterized. It is also believed that the fusion protein may mediate penetration in some cells lacking CD4.

p24 and p17 form the inner core and the outer layer of the viral capsid, respectively. p66, p51 and p31 have enzymatic activity (p66 and 51 have reverse transcriptase properties, while p31 is an endonuclease/ligase).

p6 and p7 are small nucleic-acid-binding proteins.

The major structural proteins and the peptides derived from them are immunogenic and are recognized by the different components of the immune system of infected patients.

B. Epidemiology of HIV/AIDS

By the end of 1999 it was estimated that 34.3 million people had been infected with HIV worldwide, 5.8 million during 1998 alone. Of those new cases, 4 million occurred in austral Africa and 1.2 million cases in South and Southeast Asia, the two hot foci of the epidemic at this time. During the same period, 21,419 new cases of HIV infection occurred in the United States and Puerto Rico. By the end of 1999, the cumulative figure for AIDS cases in the United States exceeded 730,000, of which about 60% had died. In the United States, the total number of HIV-infected individuals, including those who have and have not yet developed AIDS, is estimated to exceed 370,000.

The main modes of transmission of HIV in the United States are summarized in Table 30.3, and the distribution of adult AIDS cases by exposure group is summarized in Table 30.4. In the United States, the type of sexual contact with the greatest risk is male to male, followed by male to female and female to male. Heterosexual transmission is considerably more common in third world countries but is on the rise in the United States. Factors associated with increased risk of venereal transmission include receptive anal intercourse, IV drug-using partner, presence of genital ulcers, and multiple partners.

Vertical transmission is a major problem in underdeveloped countries where antiretrovirals are not generally available. The infection is most frequently acquired intrapartum (about two thirds of cases). Intrauterine transmission is next in frequency. It usually takes place late in pregnancy, and the infection is acquired either transplacentally or as a

Table 30.3 Main Modes of HIV Transmission

Sexual contact
Sharing of needles and syringes among intravenous drug users
Mother to child (transplacental, perinatal, or by breast-feeding)
Blood and blood products ^a
Transplantation of infected organs ^a

^a Transmission by blood, blood products, and organ transplantation is currently highly unlikely because of the screening of blood in blood banks and for the requirement that organ donors have to be HIV negative. Furthermore, all potential donors who engage in high-risk activities are asked not to donate or to self-defer.

consequence of prolonged rupture of the amniotic membranes. The risk of transplacental or perinatal transmission is directly related to the magnitude of the viral load. Transmission by breast-feeding is estimated to range between 5 and 12% of babies nursing from HIV-positive mothers, and the risk is directly related to the viral load and the duration of breast-feeding. As a general rule, HIV-infected women are advised to avoid breast-feeding.

C. HIV and the Immune System

The primary cellular targets of HIV are CD4⁺ cells, particularly the helper T cells. Most infected CD4⁺ lymphocytes co-express the CD45RO marker, considered as activated or memory helper T lymphocytes. It thus appears that activated CD4⁺ T cells are most susceptible to infection, but productive infection of resting CD4⁺ T cells has also been demonstrated. The infection of these cells involves several steps:

- The initial interaction of HIV and CD4⁺ cells involves specific regions of gp120 and the CD4 molecule. It is believed that that interaction results in a conformational change of gp120, which allows gp120 to interact with a co-receptor.
- Two β -chemokine receptors play the role of principal co-receptors. One, CCR-5 is the receptor for three chemokines: RANTES and macrophage inhibitory proteins 1 α (MIP-1 α) and 1 β (MIP-1 β). CCR-5 is expressed primarily by macrophages. The second, CXCR-4 (fusin), is expressed primarily by T lymphocytes.
- The interaction between CD120 and the co-receptor molecules results in exposure of the fusogenic domain of gp41, which can then interact with the cell membrane. This, in turn, results in the fusion of the membrane and the viral envelope and penetration of the nucleocapsid into the cytoplasm.

Table 30.4 Adult AIDS Cases by Exposure Group, 1999

Homosexual or bisexual men (33%)
Heterosexual intravenous drug users (16%)
Homosexual or bisexual IV drug users (5%)
Heterosexual contact cases (16%)
Recipients of blood, blood components, or organ transplants (1%)
Other/risk not reported or identified (23%)

Different HIV strains seem to show different co-receptor specificities. Macrophage-tropic HIV strains (which predominate in the early stages of infection) use CCR-5 as co-receptors. CD4 lymphotropic strains use CXCR-4 as co-receptors. Some strains that can infect both CD4 T lymphocytes and macrophages use CCR5 to infect macrophages, and a third chemokine receptor, CCR2b, to infect lymphocytes. Mucosal transmission involves the infection of both submucosal CD4⁺ T cells and Langerhans cells, followed by rapid spread to the regional lymph nodes, where it propagates to other CD4⁺ cells, including helper T cells, macrophages, and dendritic cells. When the virus is directly introduced into the blood stream, it will most likely be filtered in the spleen, where its ultimate fate will depend on its affinity for the different co-receptors mentioned above.

During HIV infection, the expression of co-receptors may be upregulated in cell populations that normally do not express them and that may allow HIV to infect those cell populations. However, some cell populations infected by HIV (e.g., intestinal cells) are not known to express CD4. The infection of mucosal epithelial cells is believed to be acquired from infected T cells and probably involves penetration through alternative receptors.

Once HIV enters a cell, its RNA is reverse transcribed and the resulting DNA integrates into the host genome, where its expression seems to depend on cellular activation. Several mechanisms of T-cell activation leading to enhanced replication of integrated HIV have been proposed:

- Infected macrophages and CD4⁺ lymphocytes are activated by concurrent infections (venereal or not).

- Some viral components may act as superantigens, interacting directly with the V β regions of specific types of T-cell receptors, consequently activating those cells.

- Dendritic cells in the submucosa and lymphoid tissues appear to bind HIV to their surface without becoming infected. Thus, the activation of HIV-carrying dendritic cells could lead to clustering with noninfected T cells, which would receive activating signals and HIV virus from the dendritic cells.

- Tumor necrosis factor (TNF) and interleukin-6 (IL-6) have the capacity to activate HIV replication in monocytes and T lymphocytes. In T lymphocytes, TNF induces the synthesis of a DNA-binding protein that binds to a nuclear factor κ B (NF κ B) site on the HIV-LTR, activating the expression of the integrated genome. A significant correlation between the levels of circulating viral RNA and of TNF and its soluble receptors supports the intimate relationships between TNF release and HIV genome expression. As for the source of the TNF, there is evidence suggesting that HIV-infected macrophages release increased amounts of TNF and IL-6.

As HIV replicates, a vigorous anti-HIV immune response is elicited. A strong humoral immune response against HIV can be detected in most patients. Neutralizing antibodies, which inhibit the infectivity of free HIV *in vitro*, directed against epitopes of gp120 and gp41, can be demonstrated. Also potentially protective are ADCC-promoting antibodies, which react with gp160 expressed on the membrane of infected cells. The rate of progression to AIDS and the mortality rate are considerably higher in individuals lacking neutralizing antibodies. However, neutralizing antibodies do not prevent infected individuals from eventually developing AIDS, in part due to the high frequency of mutations in gp120, which result in the developing of mutants not neutralized by previously existing antibodies. It has also been reported that the virus *in vivo* does not expose the immunodominant regions of gp120, thus reducing the ability of antibodies to react with the viral particles. It

has also been suggested that patients may develop enhancing antibodies. These antibodies react with gp41 and promote HIV infectivity by an unknown mechanism. In some studies, the presence of HIV-enhancing antibodies appears to be correlated with progression towards AIDS. Thus, the general consensus is that the humoral response elicited by HIV does not eliminate the infection and does not prevent evolution to AIDS.

Cell-mediated immune responses involve MHC–I–restricted CD8⁺ T lymphocytes, which recognize a variety of epitopes in *gag*, *env*, *nef*, and *pol* HIV proteins, expressed in association with MHC-I proteins. Cell-mediated cytotoxic reactions seem to be especially prominent in HIV-positive individuals who remain asymptomatic for prolonged periods of time. CD8 lymphocytes are also able, at least in vitro, to release cytokines (particularly RANTES, MIP- α and β , and a recently discovered interleukin, IL-16), which appear to act by blocking the chemokine co-receptors used by HIV to penetrate noninfected CD4⁺ cells. In addition, a soluble factor released by CD8⁺, CD28⁺ T cells inhibits the replication of integrated HIV. Thus, cell-mediated immunity seems able to either block infection or reduce viral replication to levels tolerated by the immune system.

Most HIV-infected patients develop AIDS at a time in which there is still evidence of a strong antiviral antibody response. Several factors may contribute to the “escape” of HIV from the immune response mounted by the patient:

HIV mutates at a much faster rate than most other viruses. This is due to the fact that the reverse transcriptase is error-prone and lacks copy-editing capabilities. The mutations affecting the epitopes of gp120 against which neutralizing antibodies are directed represent a selective advantage to the mutant, able to avoid recognition by the preformed antibodies.

The virulence of HIV may change during the course of the infection (e.g., emergence of syncytia-inducing strains).

HIV causes downregulation of HLA-A and HLA-B expression without affecting the expression of HLA-C and HLA-E. In this way the infected cells may escape detection by cytotoxic T lymphocytes but are not affected by NK cells.

Humoral immune responses are relatively inefficient in eliminating viral-infected cells. ADCC and lysis of viral-infected cells after exposure to antibody and complement have been observed in vitro, but it is questionable that these may be significant defense mechanisms in vivo.

As the infection persists and progresses, there is a steady decline in the numbers of CD4⁺ cells (Fig. 30.2). This T-cell depletion affects predominantly the CD4, CD45RO⁺ population and is the direct cause of the profound immunodepression seen in AIDS patients. HIV has been shown to be able to infect T-lymphocyte precursors. A major consequence of the infection of these targets is a significant decrease in the ability to repopulate the peripheral CD4 T-lymphocyte pool under attack by HIV. The result of excessive loss and lack of production of CD4 cells is a marked decrease in their absolute numbers.

Several factors have been suggested to account for the depletion of CD4⁺ T cells.

1. Direct cytotoxicity caused by virus replication is believed to be the most important cause of T-cell death. Accumulation of unintegrated DNA in the cytoplasm of infected cells is associated with vigorous HIV replication and cell death.
2. The cross-linking of CD4 molecules by gp120 is believed to prime T lymphocytes for apoptosis. In this case, active infection may not be essential, since apoptosis-primed T cells can undergo apoptosis when activated by some other stimulus, at least in vitro.

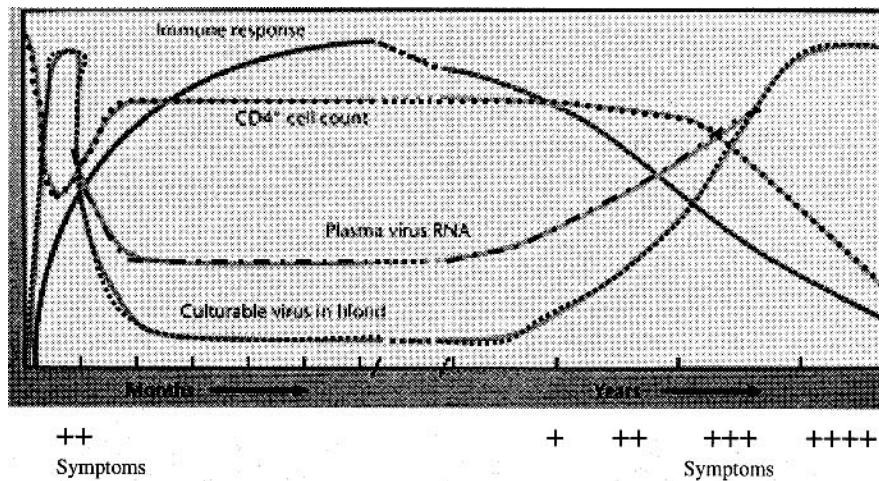

Fig. 30.2 Diagrammatic representation of the longitudinal evolution of laboratory parameters during the course of an untreated HIV infection. (Adapted from Saag et al., 1996.)

3. The expression of gp120 with unique sequences of the V_1 to V_2 and of the V_3 regions of gp120 on the membrane of infected T cells facilitates the formation of syncytia by interaction and fusion with the membranes of noninfected cells expressing CD4. The formation of syncytia allows direct cell-cell transmission of the virus and contributes to the reduction in the number of viable T cells. The emergence of strains with the syncytia-inducing sequences in infected patients is usually a late event in the course of an HIV infection, and associated with a faster progression to AIDS (median of 23 months), in part because these HIV strains are more apt to infect CD4 T-cell precursors.
4. The immune response against viral-infected T cells (mediated both by cytotoxic T cells and by ADCC mechanisms) may also contribute to CD4⁺ T-cell depletion.
5. Co-infection of HIV-infected T cells with other microorganisms, such as cytomegalovirus or *Mycoplasma fermentans*, has synergistic effects in the induction of viral replication and cell death.

Several other factors beyond the depletion of CD4⁺ cells seem to contribute to the state of marked immunodepression associated with full-blown AIDS:

1. A reduction of the TcR β variable region repertoire on T cells, reducing the number of antigens to which the patient can mount an adequate immune response.
2. An imbalance of the T_H1 and T_H2 subsets seems to precede the evolution towards AIDS. Several factors may contribute to this dysfunction, particularly lack of expression of CD80/86 by HIV-infected APCs. The lack of co-stimulatory signals involving CD80/86 and CD28 blocks T_H1 differentiation and leads to predominant T_H2 activity. T_H2 cells release IL-4 and IL-10, which further down-regulate T_H1 cells as well as the release of suppressor cytokines by CD8⁺ T lymphocytes. It must be noted that clear evidence for predominant T_H2 activity in patients evolving towards symptomatic HIV infection has not been substantiated by a variety of investigators.

3. Release of soluble gp120 by infected cells. Soluble gp120 binds to CD4 and may block the interaction of this molecule with MHC-II antigens, therefore preventing the proper stimulation of helper T cells by antigen-presenting cells.
4. Immune complexes involving viral antigens and the corresponding antibodies may also play a role in depressing immune responses. For example, binding of gp120:anti-gp120 complexes to CD4⁺ molecules of normal lymphocytes results in blocking T-cell activation via the TcR.
5. Infected monocytes are functionally abnormal, unable to perform chemotaxis, synthesize cytokines, and present antigens to helper T cells.
6. Of note is the fact that humoral immune responses become severely dysfunctional in patients with AIDS. These patients are unable to respond to antigenic challenges, while at the same time producing a variety of autoantibodies (including antinuclear autoantibodies and autoantibodies directed against platelets and lymphocytes). The synthesis of autoantibodies is probably a consequence of a state of permanent polyclonal activation of the B-cell system, probably as a result of increased release of IL-6 by activated APC and T cells. At the same time, the de novo induction of protective immune responses is compromised by the lack of adequate T-cell help.

In contrast with the cytotoxic effect of HIV infection on activated T cells, the infection of resting memory T cells, monocytes, macrophages, and related cells is not cytotoxic, and the infected cells become HIV reservoirs. Monocytes, macrophages, and related cells undergo chronic productive infection and perpetuate the infection in lymphoid tissues (lymph nodes and peri-intestinal lymphoid tissue). In contrast, HIV does not replicate on resting memory T cells. These cells can harbor the virus for long periods of time, are not affected by antiretroviral therapy, but are able to support HIV replication when activated.

D. Natural History of an HIV Infection

In the early stages of the infection, the virus appears to replicate at a very low level, and both a transient decrease of total CD4⁺ cells and a rise in circulating HIV-infected CD4⁺ T cells may be detected. As early as 5–10 days after infection, infectious viral particles, viral mRNA, as well as soluble p24 protein can be detected in the circulation (Fig. 30.2). The concentration of circulating p24 usually peaks 10–20 days after infection and remains detectable until seroconversion (i.e., the point of time when free anti-HIV antibody becomes measurable in the patient's serum). There is anecdotal evidence suggesting that some individuals may completely eliminate the virus from their organisms, particularly children from infected mothers. This, however, seems to be a very exceptional event.

HIV-positive patients remain asymptomatic for variable periods of time, often exceeding 10–15 years (the average length of the asymptomatic period is currently of 14 years). During that period of time the virus replicates actively, and integrated and soluble viral genomes continue to be detectable by several nucleic acid–amplification techniques (Table 30.5). There is a marked difference between the amount of circulating viral RNA (viral load) and the number of recoverable infectious particles, suggesting either that most infected cells die before viral assembly is completed or that the viral progeny is predominantly constituted by defective particles.

A steady state for CD4⁺ cells is reached in which the number of dying CD4⁺ T cells is roughly equivalent to the number of CD4⁺ T cells differentiated in the primary lymphoid

Table 30.5 Techniques for the Assay of the Number of HIV Genome Copies in Plasma

AMPLICOR assay
Uses RT to obtain a cDNA and PCR to amplify cDNA
Sensitivity: 40 copies/mL
Nucleic acid–based sequence amplification assay (NASBA)
Uses a mixture of RT and RNA polymerase to convert RNA into cDNA and copy the cDNA back into RNA
Sensitivity: 80 copies/mL
Branched DNA assay (QUANTIPLEX)
Uses branched DNA to detect a “captured” HIV RNA fragment
Sensitivity: 50 copies/mL

tissues. There is evidence suggesting that the rate of CD4⁺ cell differentiation does not change during the asymptomatic stages of the disease, but it declines, eventually, when the regenerative capacity of the bone marrow becomes critically impaired as a consequence of the infection of stem cells.

Understanding why some HIV-infected individuals are long-term survivors while others develop AIDS rather swiftly is a major priority in AIDS research. At this point it appears as if both host and microbial factors are involved.

1. On the host side, the genetic constitution of the individual may be critical. Differences in MHC repertoire and transport-associated proteins are emerging as related to the evolution of HIV infection. For example, it has been found that the HLA-B*5701 allele is associated with nonprogressive infection. The reason for this is not totally clear, but it may be related to the quality of the immune response elicited by immunogenic peptides presented in association with that particular HLA-B allele. Genetic variants in the chemokine receptor structure have also been linked to the duration of the asymptomatic phase. As a rule, individuals homozygous for mutant forms of CCR5 lacking a 32-base-pair segment (CCR5 Δ 32) remain free of infection; heterozygous individuals for CCR5 Δ 32 who become infected tend to be slow progressors. Also probably under genetic control is the development of a strong cytotoxic reaction directed against viral-infected cells, a major correlate of long-term survival in most HIV-infected individuals.
2. The mode of exposure to HIV may also play a significant role. Mucosal exposure to low virus loads seems to induce protective CMI at the mucosal level, and the individuals may remain seronegative in spite of repeated exposures.
3. On the virus side, some long-term survivors seem to be infected by strains of reduced pathogenicity, which replicate less effectively and are associated with lower viral loads.

All the factors associated with long-term survival have an effect on viral load. Indeed, there is an inverse correlation between the number of HIV-1 RNA copies in plasma and the duration of the asymptomatic period. It has been reported that only 8% of HIV-infected patients with less than 4350 copies of viral RNA/mL of plasma at the time of diagnosis developed AIDS after 5 years of follow-up. In other words, low virus loads are associated with prolonged survival. The monitoring of viral load and CD4⁺ lymphocyte counts is considered as the best approach for the follow-up of HIV-infected patients (Fig. 30.2), as well as for monitoring the effects of antiretroviral therapy.

E. Clinical Stages of HIV Infection

When the infection is left to follow its natural course, most HIV-infected patients will develop AIDS. The asymptomatic period that precedes the diagnosis of AIDS may extend for several years, and the onset of clinical manifestations of AIDS may be gradual or abrupt. Many alternative classifications of the clinical stages of HIV-induced disease have been proposed, one of which is as follows:

- Acute retroviral infection (usually a mononucleosis-like syndrome)
- Asymptomatic (no symptoms with the exception of the presence of lymphadenopathy)
- Early symptomatic (non-life-threatening infections, chronic or intermittent symptoms)
- Late symptomatic (increasingly severe symptoms; life-threatening infections; malignancies)
- Advanced (high frequency of “opportunistic infections”; increased death risk)

1. Acute Illness Associated with Seroconversion

The typical incubation time is estimated to be 2–4 weeks between exposure and onset of symptoms. Viremia occurs at that time and virus transmission can take place before antibodies are detected. The clinical picture is similar to infectious mononucleosis or flu-like. Fever, sore throat, myalgias, headache, malaise, and a maculopapular rash are the most predominant symptoms. Although these symptoms may be rather frequent (it is estimated that 53–93% of patients present them), their lack of specificity leads to frequent misdiagnoses on the part of both the patient and the physician. Most patients recover completely from the acute infection, although in some headaches and adenopathy may persist.

The results of enzyme immunoassays for HIV antibody during this stage are often negative. Seroconversion usually occurs 6 weeks after infection (antibodies to gp120 and gp41 are usually detected first, followed by antibodies to p24). Thus, if a patient suspected of being infected with HIV is seronegative, but definitely classified as belonging to a high-risk group, the serological studies should be repeated after 6 additional weeks. In rare cases, seroconversion can be significantly delayed (sometimes for one year or longer).

With the availability of highly effective therapy, there is a strong current of opinion emphasizing the need for early diagnosis so that therapy can be instituted well before the immune system is affected by the infection. Rapid diagnosis of HIV infection can be best achieved by detection of viral RNA by PCR. This is also the best available approach to diagnosis in a child born from an HIV⁺ mother, because the child may be falsely positive in serological assays for several months due to the transplacental transfer of maternal antibody.

2. Asymptomatic Infection

The patient remains seropositive with minimal or no symptoms (diffuse reactive lymphadenopathy and headache may be present at this stage) for variable periods of time (9–11 years on average, probably 20 years in some individuals). Considerable interest has been focused on the study of laboratory parameters that may be associated with the progression of HIV-infected individuals towards clinically significant immunodeficiency. The determi-

nation of the viral load is considered the most reliable parameter for prognostic evaluation of any given patient. The CD4 count should also be followed closely, as an index of the degree of immunocompromise.

It is important at this asymptomatic stage to evaluate the patient for other diseases that may be seen in HIV-infected patients, such as syphilis, hepatitis B, and tuberculosis, and treat any such condition that may be diagnosed. Prophylactic measures to avoid infections known to occur with increased frequency in HIV⁺ patients are also indicated:

Chemoprophylaxis of tuberculosis with Isoniazid and immunoprophylaxis of influenza and pneumococcal pneumonia.

Toxoplasma serology is also recommended, since it may help screen the patients at risk for developing severe toxoplasmosis at later stages of the disease. Eight to 16% of HIV-infected individuals in urban areas have serological evidence of infection with *Toxoplasma gondii*; of those, 30–50% will develop toxoplasmosis as their degree of immunosuppression increases, the percentage rising to 80% when CD4 counts drop consistently below 100/mm³.

In HIV⁺ females, biannual PAP smears are recommended due to increased frequency of infection with papillomaviruses, which in turn is related to the development of cervical carcinoma.

3. Early Symptomatic HIV Infection

Fever, night sweats, fatigue, chronic diarrhea, and headache in the absence of any specific opportunistic disease in a previously asymptomatic HIV⁺ patient mark the transition towards symptomatic disease. Diarrhea in these patients is most likely due to direct infection of the GI mucosa by the HIV virus. Disseminated lymphadenopathy, believed to represent a reactive response of all the nodal elements, is prominent in some patients and less obvious in others. Both T- and B-cell populations are expanded, and virus is not present in the reactive B lymphocytes.

Mucosal candidiasis is a frequent presenting symptom. In adult men, oral candidiasis is very rare other than in HIV-positive patients. In HIV-positive women, recurrent vaginal candidiasis is a frequent cause for seeking medical attention.

Kaposi's sarcoma may also be a relatively early presentation. It is caused by a virus of the herpes family (human herpesvirus 8, HHV-8). Infections with this virus in HIV⁺ patients seems to be associated with exaggerated release of IL-6, IL-1, TNF, and oncostatin M by activated macrophages, which would act synergistically in promoting the development of the vascular proliferative lesions typical of the tumor.

With time, anergy and other laboratory evidence of immunodeficiency may develop, and some opportunistic infections may start affecting these patients, particularly recurrent mucosal candidiasis, oral leukoplakia (often asymptomatic), upper and lower respiratory tract infections, and periodontal disease.

4. Late Symptomatic and Advanced HIV Disease

With the progressive decline of CD4⁺ counts, the risk for development of opportunistic infections increases. The onset of opportunistic infections is considered as the clinical hallmark for diagnosis of full-blown AIDS.

F. Acquired Immunodeficiency Syndrome

The designation of acquired immunodeficiency syndrome (AIDS) is applied when an HIV-positive patient presents one or more of the following features:

1. Opportunistic infections (Table 30.6). Of particular concern among opportunistic infections are *Pneumocystis carinii* pneumonia, whose frequency increases significantly when the CD4⁺ lymphocyte count falls below 200/mm³, and toxoplasmosis, which in AIDS patients often affects the brain. With lower CD4 counts (<100/mm³) infections with *Mycobacterium avium-intracellulare*, cytomegalovirus, esophageal candidiasis, cryptococcal pneumonitis and meningitis, recurrent herpes simplex, and wasting disease are increasing in frequency.
2. Progressive wasting syndrome (known as “slim disease” in Africa) in adults and failure to thrive in infected infants, probably related to the exaggerated release of TNF (cachectin) by activated macrophages.
3. Unusually frequent or severe infections not considered as opportunistic, such as recurrent bacterial pneumonia or pulmonary tuberculosis. Recurrent bacterial infections are the most common infectious presentation of AIDS in infants and children. In women, recurrent vaginal candidiasis is a very frequent presentation (presenting symptom in 24–71% of the cases, depending on the series).
4. Specific neoplastic diseases, such as Kaposi’s sarcoma, non-Hodgkin’s lymphoma, and invasive cervical carcinoma.
5. Neuropsychiatric diseases such as encephalopathy (dementia) and progressive multifocal leukoencephalopathy (due to reactivation of an infection with the Jakob-Creutzfeld (JC) virus) or significant developmental delays or deterioration in children.
6. Lymphocytic interstitial pneumonitis in infants and children.
7. A CD4⁺ cell count below 200/mm³.

Table 30.6 Opportunistic Infections Characteristically Associated with AIDS

<i>Pneumocystis carinii</i> pneumonia
Chronic cryptosporidiosis or isosporiasis causing untractable diarrhea
Toxoplasmosis
Extraintestinal strongyloidosis
Candidiasis (oral candidiasis is common as a prodromal manifestation and is considered as a marker of progression towards AIDS; esophageal, bronchial, and pulmonary candidiasis are pathognomonic)
Cryptococcosis
Histoplasmosis
Infections caused by atypical mycobacteria, such as <i>M. avium-intracellulare</i>
Pulmonary and extrapulmonary tuberculosis (often resistant to therapy)
Disseminated cytomegalovirus infection (may affect the retina and cause blindness)
Disseminated herpes simplex infection
Multidermatomal herpes zoster
Recurrent <i>Salmonella</i> bacteremia
Progressive multifocal leukoencephalopathy
Invasive nocardiosis

The diagnosis of AIDS needs to be supported by evidence of HIV infection, such as positive serological tests, isolation of the virus, or detection of viral genomic material by PCR.

G. Serological Diagnosis of HIV Infection

The initial screening of anti-HIV antibodies is done by an enzyme-linked immunoassay test (EIA) using HIV antigens obtained either from infected cells or by recombinant technology. Since this is a screening test, its cut-off (particularly when used to screen blood in blood banks) is set for maximal sensitivity, since it is preferable to discard some blood units that test false positive than to transfuse contaminated units with low antibody titers that escape detection.

Any positive result on ELISA needs to be confirmed, first by repeating the EIA to rule out errors or technical problems. If the repeat test is positive, the result should be confirmed primarily by Western blot (immunoblot). A Western blot is considered positive if antibodies to structural proteins (e.g., p24), enzymes (gp41), and envelope glycoproteins (gp41 or gp120) are simultaneously detected. The accuracy of the combined tests (EIA and Western blot) is better than 99.5%.

H. Therapy

No other viral disease has been the object of the intense pharmacological research that has resulted in giant strides in the management of HIV-infected patients in industrialized countries. Starting from the often-disappointing experience with single use of reverse transcriptase inhibitors, the addition of new drugs to our armamentarium has proven that antiretroviral therapy can have a beneficial impact on the evolution of HIV infections.

1. Antiretroviral Agents

The antiretroviral agents currently in use can be divided into several different pharmacological groups, acting at different levels of the viral-replication cycle (Fig. 30.3).

1. Reverse transcriptase inhibitors, which can be subclassified into three groups:

Nucleoside analogs, including zidovudine (azidodeoxythymidine, ZDV, AZT), the most widely used antiviral agent for treatment of HIV infections, and several other compounds [zalcitabine (2',3'-dideoxycytidine, ddC), didanosine (2',3'-dideoxyinosine, ddl), stavudine (2',3'-didehydro-3' deoxythymidine, d4T), lamivudine (2'-deoxy-3'-thiacytidine, 3TC), and abacavir (ABC)]. These compounds are phosphorylated by cellular thymidine kinases and are taken up preferentially by the HIV reverse transcriptase. DNA transcription is blocked by at least two mechanisms: binding to the reverse transcriptase, which blocks its active site, and termination of DNA synthesis when the activated nucleosides are incorporated into nascent viral DNA and block further elongation.

Nucleotide analogs, such as adefovir, are compounds that will terminate DNA elongation upon incorporation into nascent DNA chains. These drugs are still in the clinical trial stage.

Nonnucleoside reverse transcriptase inhibitors (NNRTI), such as nevirapine, delavirdine, and efavirenz. These compounds bind to a hydrophobic pocket of the reverse transcriptase at a site different from the active site but still block the activity of the enzyme by steric hindrance. Because of the different binding

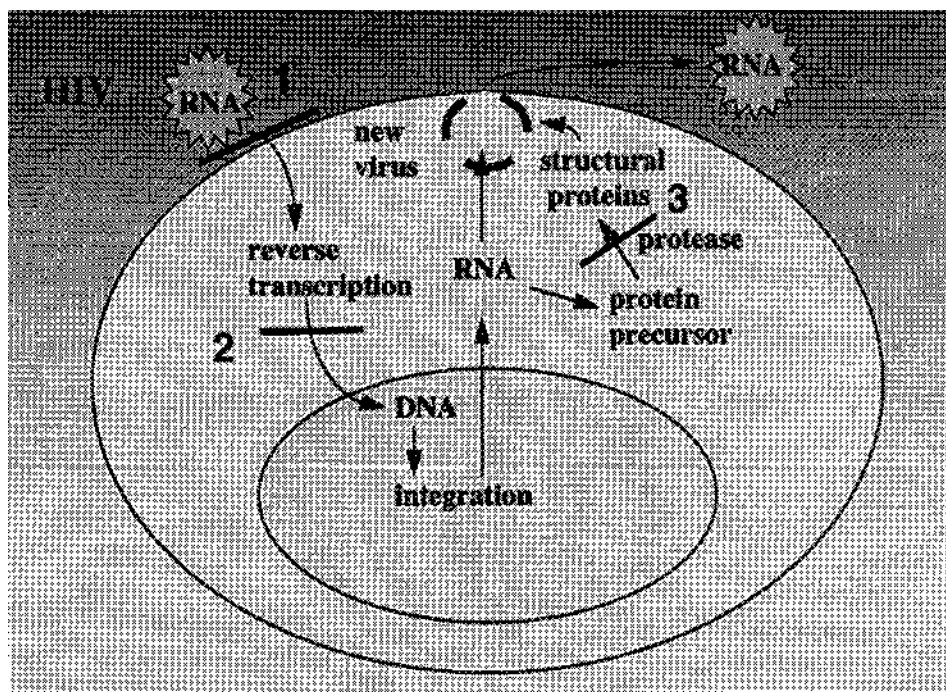

Fig. 30.3 Diagrammatic representation of the HIV life cycle and the points of action of antiretroviral agents. The first antiretrovirals introduced were the reverse transcriptase inhibitors, which block the first step of viral replication after the virus has penetrated into a competent cell (2). The next generation of antiretrovirals was the protease inhibitors, which prevented the processing of viral proteins, a step essential for the assembly of viral progeny (3). Agents able to prevent the penetration of HIV into competent cells (1) are currently being evaluated.

sites, strains of HIV resistant to nucleoside reverse transcriptase inhibitors are not cross-resistant to NNRTIs.

2. Protease inhibitors, such as saquinavir, ritonavir, indinavir, nelfinavir, and amprenavir. These are synthetic, nonhydrolyzable synthetic peptides that compete as substrates for the HIV protease. HIV-infected cells exposed to these compounds accumulate *gag* polyprotein precursors that are not cleaved due to the inhibition of protease activity. This results in cell death.
3. Inhibitors of viral penetration. Several compounds have been tested for the treatment of HIV infections by preventing HIV penetration in noninfected cells. Anti-CD4 antibodies were the first to be tried, without success. Chemokine receptor blockers and synthetic peptides such as T-20 (pentafuside), which block the interaction of gp41 with the plasma membrane, are under evaluation (Fig. 30.4).
4. Hydroxyurea, a ribonucleotide reductase, has been shown to have synergistic antiretroviral effects when given in association with ddI. Hydroxyurea inhibits the formation of deoxynucleoside-5'-triphosphates (including dATP) required for reverse transcription of viral RNA. At the same time, ddI is converted into ddATP, which is taken up by the reverse transcriptase instead of dATP and blocks DNA chain elongation. Questions about its effectiveness and safety have yet to be fully answered.

Administration of three or more different antiretrovirals, known as highly active antiretroviral therapy (HAART), is the current standard recommendation for HIV therapy. Most combinations include two reverse transcriptase inhibitors with different binding sites in the polymerase (e.g., ZDV and 3TC). The rationale for the association is to combine nucleoside analogs that require different HIV mutations for resistance to develop. The probability of emergence of a double mutant polymerase retaining functional activity is relatively low. The third drug can be a protease inhibitor or a nonnucleoside reverse transcriptase inhibitor.

If and when resistant strains emerge after combination therapy with two RT inhibitors and a protease inhibitor, there are limited options left for the patient in question. For this reason some groups advocate using three RT inhibitors (two nucleoside analogs and a nonnucleoside RT inhibitor) to initiate therapy in a previously untreated patient, saving the protease inhibitors for use when resistance to the initial therapy develops.

HAART in any of its modalities induces remarkable reductions in viral load after 12 weeks of administration—very frequently below the detection level of the most sensitive assays in compliant patients (the desirable goal of therapy). The reduction in viral load is usually associated with increases in CD4⁺ T-cell counts, averaging 120–150 over the pre-treatment levels after the first months of therapy. In addition, several immune function parameters show improvement after combination therapy: skin test reactivity, mitogenic responses, IFN γ and IL-2 synthesis, CD28 expression (by both CD4⁺ and CD8⁺ cells). At the same time, IL-6 and TNF levels decrease, reflecting a lower degree of T-cell activation.

The increase in CD4 T-cell numbers (affecting both 45RA and 45RO subpopulations) is usually not associated with an immediate increase in the repertoire of TcR V β regions. In fact, the immediate expansion of CD4 T cells seems to involve the residual memory and naïve T-cell clones that survived the effects of HIV infection. Progressive, but slow, increases in CD4 counts are often seen during years. Recovery of normal T-cell counts may take 6 or more years, assuming HIV replication is suppressed during that period. It is noteworthy that when HAART succeeds in reducing the viral load to undetectable

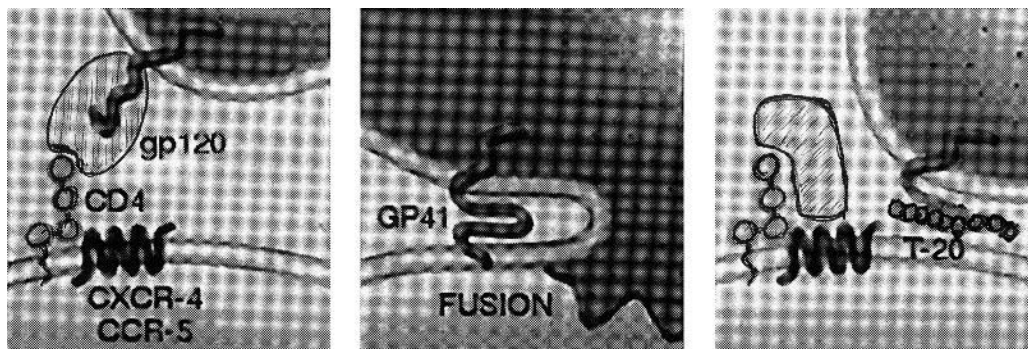

Fig. 30.4 Diagrammatic representation of the point of action of T-20, a peptide inhibitor of HIV penetration. The penetration of HIV into a competent cell involves several steps. First, gp120 interacts with CD4 and with a chemokine co-receptor (CxCR-4 or CCR-5). These interactions result in the exposure of fusogenic domains in gp41 otherwise sterically hindered by gp120. The functional activation of gp41, in turn, results in the fusion of the viral envelope with the plasma membrane, required for the intracellular release of the viral nucleocapsid. This process can be blocked by compounds that bind to the chemokine co-receptors or by compounds, such as T-20, that bind to gp41. (Adapted from Dynamics of HIV infection: a special report. *Sci Med* 5:36, 1998.)

levels, HIV-specific CD4 and CD8 responses remain depressed, suggesting that specific HIV immunity not only requires regeneration of lymphocyte pools, but also antigenic exposure. Some groups advocate periodic interruptions of antiretroviral therapy to allow for a burst of HIV replication, which may then induce specific immunity, but the real therapeutic value of these protocols is yet to be established.

In spite of all these limitations, patients successfully treated with any modality of HAART are able to mount immune responses when properly immunized and show both a decrease in the frequency of opportunistic infections and a remarkable significant reduction in mortality. These beneficial effects are observed even in the absence of a complete regeneration of the TcR repertoire (it has been estimated that effective immune responses can be generated with 10% of the original TcR repertoire).

Effective HAART is not associated with emergence of mutant viruses. Interruption of treatment is usually followed by the reemergence of the original viral strains characterized before this type of therapy was initiated. In patients who develop strong anti-HIV cytotoxic responses during HAART, suspension of therapy is not immediately followed by increase in viral load. Some of these patients have maintained undetectable HIV loads for up to 24 months after therapy interruption. Whether these cases represent examples of complete eradication of HIV after combination therapy has yet to be reported. There is concern that the infection of microglial cells in the brain, macrophages/dendritic cells in the lymphoid tissues, and long-lived resting memory cells may not be efficiently eliminated by current antiretroviral therapy.

2. Indications for Antiretroviral Therapy and Problems Encountered on Its Implementation

Therapy is unquestionably indicated for symptomatic HIV-positive patients, even if not fulfilling the AIDS diagnostic criteria, and for HIV-infected patients with viral loads greater than 30,000, irrespective of CD4 counts and clinical symptoms. However, there are very many controversial areas. Some groups advocate treatment as early as possible, irrespective of the viral load, in the hope of eradicating the virus. Others advocate treatment of all patients with CD4 counts below 300/ μ L, irrespective of the viral load. On the other hand, some specialists feel that it is reasonable to withhold antiretroviral therapy in HIV-positive patients with stable CD4 counts in excess of 300/ μ L and stable viral loads, below 10,000 copies/mL.

The treatment with multiple drug combinations, including those needed to treat or prevent opportunistic infections (see below), raises serious problems, such as cost, compliance, and drug interactions. The fact that cost may reach tens of thousands of dollars per year is a major limiting factor worldwide, even in the United States among those patients who lack medical insurance. Compliance is made difficult not only by the number of drugs involved, but also by the complicated administration schedules. While some drugs may be taken on alternate days, others have to be taken every 4 hours. Some should be taken on an empty stomach, others after a fatty meal. Also, the side effects may be so distressing that some patients cannot tolerate the therapy.

Drug interactions become a very significant problem when multiple potent drugs are simultaneously administered. The interactions happen at many different levels. For example, not all combinations of antiretroviral drugs are adequate; some can interfere with each other and reduce the efficiency of the treatment. AZT and high doses of TMP/SMX should not be administered at the same time because both drugs can cause bone marrow depres-

Table 30.7 Guidelines for Use of Zidovudine (AZT) in Pregnancy

During pregnancy
AZT, 200 mg p.o. TID
Begin after 14 weeks of gestation
During delivery
AZT, 2 mg/kg IV over 1 hr
Thereafter, AZT, 1 mg/kg by continuous infusion until delivery
Neonatal
Oral AZT syrup, 2 mg/kg q 6 h × 6 weeks
Can give AZT IV if p.o. not possible

Notes: Give AZT during delivery even if patient has had none during pregnancy. Give AZT to neonate even if mother has had none.

sion. Some protease inhibitors inhibit the effect of tuberculostatics. Some members of the azole group of antifungal drugs reduce the metabolic elimination of protease inhibitors. Detailed knowledge of potential drug interactions is essential for the proper treatment of these patients.

3. *Prevention of Materno-Fetal Transmission*

The risk of materno-fetal transmission of HIV is estimated to be around 25–30%, with a direct correlation with the viral load of the infected mother. The risk can be reduced by a variety of antiretroviral regimens that should contain ZDV (see Table 30.7). Zidovudine by itself, when give according to the guidelines shown in Table 30.6, reduces the risk of HIV transmission to about 8%. Further reductions (to about 2%) are possible by using HAART or by delivering the baby elective C-section.

4. *Resistance to Antiretrovirals*

The high mutation rate of HIV associated with the selective pressure exerted by antiretrovirals results in the rapid emergence of resistant strains. The likelihood of such strains emerging is reduced when several antiretrovirals are used in combination and the patient complies with the prescribed schedule of administration. To better decide what antiretrovirals to use, particularly when trying to decide the most adequate combination of antiretrovirals to be given to a patient who has developed resistance, two basic methods of determining antiretroviral susceptibility of HIV have been introduced. One is a phenotypic assay, based on testing the ability of HIV isolated from a given patient to replicate in permissive cells in the presence of different antiretrovirals. The other approach is a genotypic test, which consists of analyzing the nucleic acid of a patient's isolate to determine the presence of mutations known to be associated with resistance to different antiretrovirals (Fig. 30.5). Neither approach is perfect, because the sensitivity is such that viral populations representing less than 20% of the total HIV load will not be detected.

5. *Ancillary Therapies*

Treatment and prophylaxis of life-threatening opportunistic infections is essential and often needs to take place before HAART is initiated. Treatment and prevention of infection by *Pneumocystis carinii* with trimethoprim-sulfamethoxazole has a major impact in the

	41	50	65	67	69	70	74	75	115	151	184	215	219	333	
ddI															ddI
d4T															d4T
3TC															3TC
ZDV															ZDV
Abacavir															Abacavir
ddC															ddC
Adefovir															Adefovir
	41	50	65	67	69	70	74	75	115	151	184	215	219	333	

Fig. 30.5 Diagrammatic representation of the different mutations in the HIV reverse transcriptase associated with resistance to nucleoside and nucleotide reverse transcriptase inhibitors. The shaded boxes represent substitutions associated with resistance to specific drugs; dark color represents a higher degree of resistance than light color. Notice that mutations affecting position 151 of the reverse transcriptase result in resistance to all nucleoside and nucleotide HIV reverse transcriptase inhibitors. (Adapted from Gene Chart. Beverly Hills, CA: Academy of Continuing Education Programs, 1999.)

management of patients with overt AIDS. Those patients may also benefit from chemoprophylaxis of infections due to *Toxoplasma gondii*, mycobacteria, *Candida albicans*, *Cryptococcus neoformans*, and cytomegalovirus. Passive immunoprophylactic administration of intravenous gamma globulin to prevent pyogenic infections is mainly indicated in infantile AIDS.

Biological response modifiers have also been widely used in patients with AIDS, with a variety of goals. Erythropoietin and granulocyte colony-stimulating factor (G-CSF) have been administered to patients with neutropenia or red cell aplasia secondary to the administration of ZDV to promote the proliferation of red cell and neutrophil precursors. Interferon- α has been approved for administration to patients with Kaposi's sarcoma. Interleukin-2 and interleukin-12 are being evaluated for the capacity to accelerate the restoration of immune functions in AIDS patients. High doses of IL-2 induce increases in CD4 counts in patients in which antiretrovirals have significantly reduced the viral load, but the side effects are considerable. Lower doses are better tolerated but not as effective. In either modality, the beneficial effects of IL-2 can be detected for several weeks after administration.

One of the potential adverse effects of IL-2 administration would be to activate infected resting T cells and promote viral replication. Recent reports from Clifford Lane and A. Fauci's groups at the NIH suggest that this may actually allow eradication of HIV in patients receiving HAART therapy. The induction of viral replication in infected cells that otherwise would remain dormant long-term reservoirs of the virus may allow their elimination by the joint effects of antiretroviral compounds and the immune system.

Another avenue explored by several groups trying to boost the immune system of HIV⁺ individuals is the immunization of infected patients with the purpose of accelerating the immune reconstitution of patients successfully treated with HAART. Killed HIV, gp120-depleted HIV, recombinant envelope subunits, and recombinant canary pox vaccines have been used for that purpose. These vaccines have been reported to increase the

number of mitogen-responsive T cells in peripheral blood; the canary pox vaccine induces cytotoxic T cells in 50–70% of the recipients. Recent reports also suggest that a Tat vaccine may be worth developing. Antibodies to the Tat protein have several potentially useful effects, such as reducing the level of HIV replication and transmission and preventing some of the immunosuppressive effects of the virus. In a monkey model this vaccine reduced HIV viremia to undetectable levels and prevented CD4⁺ T-cell decrease.

I. Immunoprophylaxis

A great effort is underway to develop a vaccine against HIV. Different groups are exploring a variety of approaches. Attenuated vaccines, based on creating genetically engineered strains lacking some crucial genes so that the resulting virus causes a harmless infection, have been tried successfully with simian immunodeficiency virus (SIV) and an attenuated vaccine may be field-tried soon. Inactivated vaccines have not been shown to induce protective antiviral immunity in animal trials using SIV. However, there has been considerable interest in using killed vaccines to prevent the emergence of clinical disease. It has been proposed that vaccination with low doses of killed HIV boosts T_H1 responses and favors the development of cell-mediated cytotoxicity. However, the evaluation of the efficacy of this approach is complicated by the fact that the endpoint for evaluation is the disease-free interval, rather long and variable. Recombinant viral particles made by inserting HIV glycoprotein genes in vaccinia virus or canary poxvirus genomes, for example, have been shown to induce neutralizing antibodies in animals. These vaccines seem to be the most prone to stimulate the differentiation of HIV-specific MHC-I–restricted cytotoxic lymphocytes. Component vaccines have been prepared using isolated gp120, polymerized gp120, or gp120 peptides representing more conserved regions (such as the CD4-binding domain). Recently, Tat protein vaccines have been proposed, with the rationale that antibodies to this protein will prevent the intercellular transactivation of HIV replication mediated by soluble Tat protein. Finally, DNA vaccines also appear to induce HIV-specific MHC-I–restricted cytotoxic lymphocytes and have been found to induce protection in primates.

In spite of all these attempts, progress in the development of an effective HIV vaccine has been slow. Difficulties in evaluation of candidate vaccines, due to the relative inadequacy of animal models and the lack of adequate indices of protection in humans, have slowed down progress. Most commonly, the assessment of the efficacy of a vaccine is based on the assay of protective antibodies. However, antibodies are not truly protective in the case of HIV; in most cases the antibodies induced by gp120 do not neutralize primary HIV isolates.

All evidence points to the fact that an efficient vaccine should stimulate the differentiation of HIV-specific cytotoxic T lymphocytes, which may be the only way to eliminate viral-infected cells, which apparently can be involved in the transmission of HIV infection. Certain conserved epitopes of gp120, gp41, and of the Gag protein appear more effective in inducing T-cell-mediated immunity. A trial with a recombinant vaccinia virus expressing a gag epitope demonstrated that it effectively induces CD8⁺ cells with cytotoxic activity specifically directed to it. Other poxviruses, such as canary pox, have also been shown to be effective vectors from the point of view of inducing cytotoxic responses. A problem unique to this approach is that the assessment of cell-mediated cytotoxicity is much more laborious and expensive than the assessment of humoral immunity.

Case 30.1 Revisited

The onset of *Pneumocystis carinii* in a previously healthy young adult with low T-cell count and evidence suggestive of mucocutaneous candidiasis should raise the possibility of the diagnosis of AIDS.

Two important tests should be immediately ordered in this patient: (1) because of the lymphopenia during an acute infection, a lymphocyte subpopulation profile should be ordered; and (2) because of the suspected diagnosis of AIDS, HIV serologies should also be ordered. This patient had a profound $CD4^+$ lymphocyte deficiency ($4/\mu L$) and was HIV-positive both by EIA and by Western blot.

A patient with profound depression of the $CD4^+$ lymphocyte count is at risk for all types of infections by pathogenic and opportunistic agents, including bacteria, viruses, fungi, and parasites. This patient has mucosal candidiasis at the time of diagnosis and developed a systemic infection with *Mycobacterium avium-intracellulare* soon thereafter.

At the time of diagnosis the most pressing issue was the *Pneumocystis carinii* pneumonia, which was treated with IV sulfamethoxazole-trimethoprim (SMZ-TMP). At the same time, oral fluconazole was started to control the mucosal candidiasis. Antiretroviral therapy was delayed until the patient could be placed on a maintenance dose of SMZ-TMP, because of the combined risk of bone marrow depression that is associated to the simultaneous administration of antiretrovirals (particularly ZDV and SMZ-TMP in high doses, as required in a case of *Pneumocystis carinii* pneumonia). The diagnosis of disseminated infection with *Mycobacterium avium-intracellulare* was followed by administration of clarithromycin and ethambutol. After the resolution of the acute infections that affected this patient, he was placed on HAART plus chemoprophylaxis with a combination of SMZ-TMP, clarithromycin, and fluconazole, and was instructed to receive periodical *S. pneumoniae* and influenza immunizations. Prevention of infections has resulted in prolonged survival for patients with AIDS.

SELF-EVALUATION

Questions

Choose the one *best* answer.

- 30.1 A pediatrician asks for an immunological work-up of cellular immunity in a 3-year-old child who has been acutely ill with measles in the past few days. Skin tests with candidin, SK-SD, PPD, and mumps antigen are negative. Mitogenic responses to PHA, conA, monoclonal anti-CD3 antibody, measles antigen, and tetanus toxoid are depressed. IL-2 release after stimulation of mononuclear cells with PHA is undetectable. In your report to the referring physician you will state that:
- No conclusion is possible.
 - The patient has no immune abnormality.
 - The patient has primary cell-mediated immunodeficiency.
 - The results are difficult to interpret; blood should be collected as soon as possible to repeat in vitro studies.
 - There is a depression of cell-mediated immunity that could be secondary to the viral infection; the studies should be repeated in 4 weeks.

- 30.2 Which one of the following mechanisms is unlikely to contribute to the immunodepression associated with symptomatic HIV infection?
- A. Formation of soluble immune complexes involving gp120 and anti-gp120 antibodies
 - B. Formation of syncytia involving infected and uninfected CD4⁺ T lymphocytes
 - C. Hyperactivity of CD8⁺ cells with suppressor activity
 - D. Immunological elimination of HIV-infected T lymphocytes
 - E. Release of soluble gp120 from infected cells
- 30.3 A patient with chronic pulmonary tuberculosis, who had had a strongly positive reaction to tuberculin, becomes tuberculin-negative and at that time also has negative skin tests to tuberculin, coccidioidin, and candidin. On the basis of this observation, you can state that the patient most likely:
- A. Has a generalized cellular immune deficiency
 - B. Is in a state of anergy associated with chronic active tuberculosis
 - C. Is unable to respond to polysaccharides
 - D. Needs to be vaccinated against tetanus
 - E. Needs further evaluation of his or her cell-mediated immunity
- 30.4 A 20-year-old woman is found to be HIV-positive at week 6 of her first pregnancy. Which of the following courses of action is best in such a situation?
- A. Administration of ZDV to the mother from week 14 until delivery, and to the newborn during the first 6 weeks of life
 - B. Administration of ZDV to the newborn during the first 6 weeks of life and avoidance of breastfeeding
 - C. Administration of ZDV to the mother from week 14 until delivery and to the newborn during the first 6 weeks of life, and avoidance of breastfeeding
 - D. Administration of nevirapine, 3TC, and indinavir to the mother from week 14 until delivery, and to the newborn during the first 6 weeks of life
 - E. Administration of ZDV, 3TC, and indinavir to the mother from week 14 until delivery, administration of ZDV to the newborn during the first 6 weeks of life, and avoidance of breastfeeding
- 30.5 A week before the predicted delivery date, the woman described above breaks water. However, her contractions are weak and labor induction is not effective. Which of the following measures may be indicated to reduce the risk of materno-fetal transmission?
- A. Adding a fourth antiretroviral to the patient's regimen
 - B. Bed rest
 - C. C-section
 - D. Passive administration of anti-HIV antibodies
 - E. Vaginal extraction
- 30.6 Which of the following assays is commonly used to estimate the viral load in an HIV-infected patient?
- A. CD4⁺ T-cell counts
 - B. Determination of the proportion of infected cells in a lymph-node biopsy
 - C. PCR amplification of cDNA obtained by reverse transcription of viral RNA
 - D. Quantitative assay of soluble viral antigens in the plasma
 - E. Viral culture of the peripheral blood

- 30.7 Which of the following is a major characteristic of the immunodeficiency associated to splenectomy?
- A. Inability to eliminate intracellular pathogens
 - B. Increased incidence and severity of pneumococcal infections
 - C. Low IgM levels
 - D. Progressive deterioration of the immune system
 - E. Transient depression of the humoral immune response
- 30.8 Which of the following is a feature found in most patients who show long-term survival after HIV infection?
- A. High IgG anti-HIV antibody titers
 - B. High levels of interleukin-6 (IL-6)
 - C. Lack of expression of HIV co-receptors
 - D. Infection with nonreplicating HIV strains
 - E. Sustained high numbers of HIV-specific cytotoxic T cells
- 30.9 Which of the following compartments of the immune system is most profoundly impaired in a patient with severe protein-calorie malnutrition?
- A. Antibody response to common childhood vaccines
 - B. Antibody response to polysaccharide antigens
 - C. Cell-mediated immunity
 - D. Complement activity
 - E. Phagocytosis
- 30.10 Which of the following substances is believed to play a primary role in inducing a transient state of immunodeficiency affecting mostly T cells after surgery?
- A. Hemoglobin
 - B. Interleukin-2
 - C. Methylguanidine
 - D. Pain killers
 - E. Prostaglandin E₂ (PGE₂)

Answers

- 30.1 (E) A compromise of cell-mediated immunity is frequently seen during the acute phase of measles. The defect is reversible, and the immunological parameters should normalize at the end of the convalescence period.
- 30.2 (C) CD8⁺ cells are not directly infected by the HIV virus. Their differentiation into functional cytotoxic cells is compromised by the lack of help from CD4⁺ cells. There is no evidence for the increased activity of any cell population with suppressor functions in HIV-infected patients.
- 30.3 (B) Negative skin tests in a patient with chronic tuberculosis are likely to correspond to a state of anergy. The second most likely possibility would be that the patient had a depressed CMI that had preceded the development of tuberculosis, but this possibility can be ruled out by the fact that the patient was tuberculin-positive in the earlier stages of his disease.

- 30.4 (E) The woman should receive the best possible treatment, i.e., highly active antiretroviral therapy with a combination of three drugs. Until new recommendations are used, ZDV should be included as one of the drugs given to the mother. The recommendation for the newborn, on the other hand, is to administer ZDV for the first 6 weeks of life, starting at birth.
- 30.5 (C) Most cases of infantile HIV are acquired perinatally, and rupture of the amniotic membranes is known to increase the risk of materno-fetal transmission. Under the circumstances it is essential to reduce the time of potential fetal exposure. C-section is the safest way to accomplish that end.
- 30.6 (C) The viral load is commonly determined using one of several assays that amplify circulating viral RNA and allow its precise determination as number of genome copies/mL.
- 30.7 (B)
- 30.8 (E) Several factors have been found to be associated with long-term survival after HIV infection, including mutations of the cytokine co-receptors used by HIV to infect CD4⁺ T cells. However, this is a rare condition, present in a very small minority of long-term survivors. The most common feature of those patients is a strong cytotoxic response of their T cells against HIV-infected cells.
- 30.9 (C) All other listed immune functions and response may be variably affected, but none is as consistently abnormal as the parameters of cell-mediated immunity.
- 30.10 (E) An excessive release of PGE₂ is believed to cause a temporary suppression of cell-mediated immunity after surgery. Hemorrhage and blood transfusion may also have suppressive effects, but not directly related to the presence of hemoglobin in circulation. Painkillers (particularly the opiates) have been reported to affect NK cell function and phagocytosis, but T cells are apparently not affected.

BIBLIOGRAPHY

- Brand, J.-M., Kirchner, H., Poppe, C., and Schmucker, P. The effects of general anesthesia on human peripheral immune cell distribution and cytokine production. *Clin. Immun. Immunopath.* 83:190, 1997.
- Chandra, R. K. Nutrition and the immune system: an introduction. *Am. J. Clin. Nutr.* 66:460S, 1997.
- Chun, T.-W., Engel D., Mizell, S. B., et al. Effect of interleukin-2 on the pool of latently infected, resting the CD4⁺ T-cells in HIV-1-infected patients receiving highly active anti-retroviral therapy. *Nature Med.* 5:651, 1999.
- Cohen, O. J., and Fauci, A. J. Benchmarks for antiretroviral therapy. *J. Clin. Invest.* 105:709, 2000.
- Connors, M., Kovacs, J. A., Krevat, S., et al. HIV infection induces changes in CD4⁺ T-cell phenotype and depletions within the CD4⁺ T-cell repertoire that are not immediately restored by antiviral or immune-based therapies. *Nature Med.* 3:533, 1997.
- Eisestein, T. K., and Hillburger, M. E. Opioid modulation of immune responses: effects on phagocyte and lymphoid cell populations. *J. Neuroimmunol.* 83:36, 1998.

- Goulder, P. J. R., and Walker, B. D. The great escape—AIDS viruses and immune control. *Nature Med.* 5:1233, 1999.
- Grieco, M., and Virella, G. Acquired immunodeficiency syndrome. In *Principles and Practice of Medical Therapy in Pregnancy*, 3rd. ed. (Gleicher N., ed.). Appleton & Lange, Stamford, CT, 1998.
- Harris, B. H., and Gelfand, J. A. The immune response to trauma. *Semin. Pediatr. Surg.* 4:77, 1995.
- Hulsewe, K. W. E., Van Acker, B. A. C., von Meyenfeldt, M. F., and Soeters, P. B. Nutritional depletion and dietary manipulations: effects on the immune response. *World J. Surg.* 23:536, 1999.
- Kilby, J. M., Hopkins, S., Venetta, T. M., et al. Potent suppression of HIV-1 replication in humans by T-20, a peptide inhibitor of gp41-mediated virus entry. *Nature Med* 4:1232, 1998.
- Marie, J. C., Kehren, J., Trescol-Biémont, M.-C., et al. Mechanism of measles virus-induced suppression of inflammatory immune responses. *Immunology* 14:69, 2001.
- McMichael, A. J., and Hanke, T. Is an HIV vaccine possible? *Nature Med.* 5:612, 1999.
- Migueles, S. A., Sabbaghian, M. S., Shupert, W. L., et al. HLA B*5701 is highly associated with restriction of virus replication in a subgroup of HIV-infected long term nonprogressors. *Proc. Nat. Acad. Sci. USA* 97:2709, 2000.
- Ortiz, G. M., Nizon, D. F., Trkola, A., et al. HIV-1-specific immune responses in subjects who temporarily contain virus replication after discontinuation of highly active antiretroviral therapy. *J. Clin. Invest* 113, 1999.
- Saag, M. S., Holodniy, M., Kuritzkes, D. R., et al. HIV viral load markers in clinical practice. *Nature Med.* 2:625, 1996.
- Sparkes, B. G. Immunological response to thermal injury. *Burns* 23:106, 1997.
- Van de Perre, P. Transmission of human immunodeficiency virus type 1 through breast-feeding. How can it be prevented? *J. Infect. Dis.* 179 (Suppl. 3):S405, 1999.
- Zahng, A.-Q., Schuler, T., Zupanic, M., et al. Sexual transmission and propagation of SIV and HIV in resting and activated CD4⁺ T cells. *Science* 286:1353, 1999.

Index

- Abnormal consequences, of immune response, 271–273
 - antigen-antibody complexes, 272
 - autoimmunity, 273
 - bacterial “superantigens,” 271–272
 - postinfectious tissue damage, 272–273
 - cross-reactions with tissue antigens, 273
 - immune complex-induced inflammation, 272–273
 - immune destruction, infected cells, 273
- ABO system, 431–432
- Acanthosis nigricans, 350
- Accessory cells, 51–76
- Acellular vaccines, 236
- Acquired hypogammaglobulinemia, 578–579
 - clinical presentation, 579
 - diagnosis, 579
 - physiopathology, 578
 - therapy, 579
- Acquired immunodeficiencies, 600–607
 - burn-associated immunodeficiency, 602–603
 - causes of, 600
 - with drug abuse, 605–606
 - alcohol, 605
 - cannabinoids, 605
 - opiates, 606
 - iatrogenically induced immune deficiencies, 603–605
 - neutropenia, 603
 - causes of, 603
 - postsurgery immunodeficiency, 603–604
 - splenectomy, 604–605
 - thymectomy, 605
- [Acquired immunodeficiencies]
 - with infections, 606–607
 - bacterial infections, 606
 - parasitic infections, 606–607
 - viral infections, 607
 - AIDS, 607–626
 - with malnutrition, 600–601
 - with renal failure, 601–602
 - with vitamin deficiencies, 601
 - with zinc deficiency, 601
- Acquired immunodeficiency syndrome (AIDS), 607–626
 - ancillary therapies, 623–625
 - antiretroviral agents, 619–622
 - asymptomatic infection, 616–617
 - case example, 626
 - HIV, 608–609
 - clinical stages of, 616–617
 - early symptomatic, 617
 - epidemiology of, 609–610
 - immune system, 610–614
 - late symptomatic, advanced, 617
 - natural history of, 614–615
 - serological diagnosis of, 619
 - immunoprophylaxis, 625
 - materno-fetal transmission, 623
 - resistance, to antiretrovirals, 623
 - seroconversion, acute illness associated with, 616
 - therapy, 619–625
- Acquired tolerance, tolerogenic conditions, 315–317
- Acrodermatitis enteropathica, 601
- Activated macrophages, 251–252

- Acute lymphocytic leukemias, 546–550
 B-cell acute lymphocytic leukemia, 546–547
 classification, 546
 enzymatic markers of acute lymphocytic leukemia, 546
 T-cell acute lymphocytic leukemia, 547–548
 T-cell leukemia associated with HTLV-1, 548–549
- Acute-phase reactants, 261
- ADCC (*see* Antibody-dependent cellular cytotoxicity)
- Addison's disease, 344–345
- Adenosine deaminase (ADA), 173, 546
 in acute lymphocytic leukemia, 546
 deficiency, 286
 thymocyte expression of, 173
- Adherence, phagocytic, 252
- Adjuvants, 55–56, 226
- Affinity constant, 122
- Affinity maturation, 110, 231
- AFP (α -fetoprotein), 521
- Agammaglobulinemia, infantile, 577–578
 clinical presentation, 577
 diagnosis, 577–578
 therapy, 578
- Agglutination, 286–289
 antigen-antibody reactions, 127–128
 bacterial agglutination, 286–287
 hemagglutination, 288–289
 of inert particles coated with antigen, antibody, 287
- Alcohol, immunodeficiency, 605
- Alkylating agents, 478
- Allelic exclusion, immunoglobulins, 113
- Allergens, 415
- Allergic encephalomyelitis, experimental, 333
- Alloantigens, 38–39, 56
- Allotypes, 110–112
- Alpha-chain disease, 542
- Alternative complement pathway, 146–149
 amplification loop, sequence of activation of, 147–148
 biological significance of, 148–149
- ANA (antinuclear antibodies), 363–365, 383
- Anamnestic response (*see* Immune response, secondary)
- Anaphylaxis
 clinical manifestations, 411–412
 morbidity/mortality, 412
 passive cutaneous, 399
- Anaphylotoxins, 146
- Anemia
 autoimmune hemolytic, warm antibody type, 444–446
 hemolytic
 autoimmune, 400
 drug-induced, 446–448
 immune, 444–449
 pernicious, 350–351
- Anergic clones, co-stimulation of, 324–325
- Angioedema, hereditary, 152–153
- Ankylosing spondylitis
 HLA-B27 and, 46, 333
 MHC and, 45, 46
- Antibody, 4–5
 diversity, genetic basis of, 109–110
 natural, 262–264
 protective role of, 264–266
 anti-infectious humoral response, factors influencing effectiveness of, 266
 humoral immune response, 264
 quantitative assay of, 557–562
 specificity, 120–121
- Antibody-combining site, immunoglobulin, 86–87
- Antibody-dependent anti-infectious effector mechanisms, 264–266
- Antibody-dependent cellular cytotoxicity (ADCC)
 natural killer cells and, 14, 217–218
 protective role, 4, 265
 target cell elimination, 101
- Anticardiolipin antibodies, 387
- Anticollagen antibodies, rheumatoid arthritis, 383
- Antigen-antibody complexes, 272
- Antigen-antibody reactions, 119–134
 affinity, 121–123
 antibody specificity, 120–121
 avidity, 123–124
 biological consequences of, 128–130
 complement activation, 129
 Fc-receptor-mediated cell activation, 129
 neutralization, 129–130
 opsonization, 128
 characteristics of, 119–125
 cross-reactions, 124–125
 meta-aminobenzene sulfonic acid, antigens tested with immune serum for, 120
 types of, 125–128
 agglutination, 127–128
 precipitation, 125–127

- Antigen-selective immune deficiencies, 582
 - clinical presentation, 582
 - diagnosis, 582
 - physiopathology, 582
- Antigenic determinants, 52–53
 - immunoglobulin molecules, 110–112
 - allotypes, 110–112
 - heavy-chain V-region allotype, 112
 - immunoglobulin A heavy-chain allotypes, 112
 - immunoglobulin E heavy-chain allotypes, 112
 - immunoglobulin heavy-chain allotypes, 111–112
 - K-type light-chain allotypes, 112
 - idiotypes, 110
 - isotypes, 110
- Antigenic stimulation, response to, 304
- Antigenicity, immunogenicity and, 51–52
- Antigens, 4–5, 51–76
 - bacterial, recombinant, 236
- Anti-idiotypic antibodies, 329
- Anti-immunoglobulin antibodies
 - diagnostic specificity of, rheumatoid arthritis, 381
 - pathogenic role, 382
 - physiological role of, 381
- Anti-infectious defense mechanisms,
 - nonspecific, 259–262
 - acute phase reaction, 261–262
 - complement system activation, 260–261
 - constitutive nonspecific defense mechanisms, 259–260
 - inducible nonspecific responses, 260
 - natural killer cells, 262
 - phagocytosis, 260
 - T lymphocytes, 262
- Anti-inflammatory drugs, 474
- Antilymphocyte globulins, 507
- Antimetabolites, 477–479, 506
- Antinuclear antibodies, rheumatoid arthritis, 383
- Anti-T-cell monoclonal antibodies, 507–508
- Arthritis, rheumatoid, 377–396
 - anti-immunoglobulin antibodies
 - diagnostic specificity of, 381
 - physiological role of, 381
 - anticollagen antibodies, 383
 - antigen presentation, dendritic cells, 386–387
 - antinuclear antibodies, 383
 - autoantibodies in, 380–383
- [Arthritis]
 - B-cell precursors, RF-producing plasmablasts, phenotype, 382
 - B cells, as local amplifiers of autoimmune response, 387
 - case study, 377–378, 391–392
 - cell-mediated immunity abnormalities in, 385–388
 - genetic factors, 388
 - genetic factors in, 383–385
 - hormonal factors, 388–389
 - human leukocyte antigen associations, 383
 - DR4 subtypes, 383–385
 - initiating factors, 389–390
 - localized disease
 - clinical presentation, 378
 - pathological manifestations of, 378–379
 - pathogenesis, 388–390
 - pathological aspects of, 378–380
 - precipitating factors, 389
 - predisposing factors, 388–389
 - related diseases, 380
 - rheumatoid factor
 - anti-immunoglobulin antibodies, 380–382
 - methods used for detection of, 380
 - pathogenic role, 382
 - self-perpetuating mechanisms, 389
 - seronegative rheumatoid arthritis, 382
 - synovium macrophages, 387–388
 - systemic involvement
 - clinical presentation, 379
 - pathological manifestations, 379
 - T lymphocytes, 385–386
 - therapy, 390–392
 - biological response modifiers, 391
 - disease-modifying drugs, 390
 - glucocorticoids, 390
 - nonsteroidal anti-inflammatory drugs, 390
 - reinduction of tolerance, 391
- Arthus reaction, 403
- Asthma, bronchial (*see* Bronchial asthma)
- Ataxia-telangiectasia, immunodeficiency with, 588
 - clinical presentation, 588
 - genetics and physiopathology, 588
- Attenuated vaccines, 238–239
 - recombinant organisms, 238–239
- Autoantibody, 326–327
 - in autoimmune diseases, 326–327
 - detection, 292

- [Autoantibody]
 - in rheumatoid arthritis, 380–383
 - in systemic lupus erythematosus, 363–365
- Autoimmune diseases
 - of blood cells, 356–357
 - classification of, 325–326
 - of gastrointestinal tract, 350–353
 - hemolytic anemia, 400, 444–446
 - warm antibody type, 444–446
 - hypersensitivity, immunosuppressive drugs
 - in, 485
 - major histocompatibility complex, 44–47
 - of neuromuscular system, 353–356
 - neutropenia, 356
 - onset of, 329–333
 - abnormal immunoregulation, 329
 - anti-idiotypic antibodies, 329
 - environmental factors, 331–332
 - genetic factors, 329–331
 - molecular mimicry, 332
 - of pancreas, 345–350
 - pathophysiology of, 326–328
 - of thyroid gland, 341–344
 - treatment of, 334–336
 - use of immunosuppressive drugs in, 485
- Autoimmunity, 273, 325–334
 - activated T lymphocytes, 328
 - animal models, 333–334
 - diabetes, 334
 - experimental allergic encephalomyelitis, 333
 - systemic lupus erythematosus, 334
 - autoantibodies, 326–327
 - immune complexes, 328
 - tolerance and, 313–340
- Azathioprine (Imuran)
 - clinical applications, 485, 506
 - immunosuppression, 477
- AZT (*see* Zidovudine)
- Bacillus Calmette-Guérin (BCG), 55, 239, 496
- Bacterial agglutination, 286–287
- Bacterial antigens, recombinant, 236
- Bacterial infections, immunodeficiency, 606
- Bacterial polysaccharides, 236
- Bacterial “superantigens,” 271–272
- Bare lymphocyte syndrome, 589
- Basement membrane autoantibodies, 401
- Basophils
 - IgE affinity, 88, 400
 - mediator-release, 424, 425
 - morphology, 17
- B-cell abnormalities, systemic lupus erythematosus, 367
- B-cell activation, humoral immune response, 226–227
- B-cell acute lymphocytic leukemia, 546–547
- B-cell anergy
 - models for, 318–319
 - reversibility of, 319
- B-cell autoimmune response, amplifiers of, rheumatoid arthritis, 387
- B-cell dyscrasias, 529–543
 - case study, 532, 543
 - clinical presentations, 537–543
 - cold agglutinin disease, 535–536
 - diagnosis, 530–532
 - heavy-chain diseases, 542–543
 - alpha-chain disease, 542
 - gamma-chain disease, 542–543
 - mu-chain disease, 543
 - hyperlipidemia, 536
 - idiopathic monoclonal gammopathies, 540–541
 - metabolic disturbances, 533–534
 - multiple myeloma, 537–540
 - laboratory diagnosis, 537–538
 - management, 538–540
 - physiopathology, 533–536
 - plasma cell leukemia, 540
 - serum hyperviscosity, 534–535
 - Waldenstrom’s macroglobulinemia, 541–542
 - clinical features, 541
 - diagnosis, 541
 - management, 541–542
- B-cell function, in diagnosis, 564
- B-cell precursors, RF-producing plasmablasts, phenotype, rheumatoid arthritis, 382
- B-cell proliferation, differentiation, 212–213
- B-cell stimulation, persistent, prolonged retention of antigen and, consequences of, 231
- B-cell, T-cell, cooperation, immunoglobulin E-mediated hypersensitivity, 417–418
- Biliary cirrhosis, primary, 351
- Biological response modifiers, 507–508
 - for rheumatoid arthritis, 391
- Blocking antibodies, 423
- Blood cells
 - autoimmune diseases of, 356–357

- [Blood cells]
 - autoimmune neutropenia, 356
 - idiopathic thrombocytopenic purpura, 356–357
 - peripheral, receptors on, 151
- Blood groups, 431–433
- Blood transfusion
 - reactions, 437–440
 - serological principles of, 434–437
- Blood types, laboratory determination of, 434
- B lymphocyte (B cell)
 - antigen processing, 210–211
 - clonal deletion, models for, 319
 - membrane markers, in diagnosis, 562–564
 - ontogeny, 167–172
 - B-cell activation
 - regulation, surface molecules involved in, 169–172
 - surface molecules involved in, 169–171
 - B-cell maturation, 168–169
 - isotype switching, 168
 - B-lineage subpopulations, developmental order of, 167–168
 - downregulation, autoreactive B cells, 172
 - downregulatory molecules on B cells, 171–172
 - ontogenic development, immunoglobulin synthesis, 169
 - response, stimulation of, by T-dependent antigen, 68–72
 - T lymphocytes, differentiation of, 166–167
- B memory cells, differentiation of, 230
- Bone marrow
 - hematopoiesis, 161
 - plasmacytosis, 538
 - pleomorphic infiltration, 541
 - suppression, 485–487
 - transplantation, 502–503, 511–512
- Brambell's receptor theory, 99
- Bronchial asthma
 - case example, 412–413
 - characteristics, 413
 - drug therapy, 424–426
 - morbidity/mortality, 412
 - type I hypersensitivity and, 399
- Bronchial hyperresponsiveness, prevention/reduction, 426
- Bruton-Janeway syndrome, 577–578
 - clinical presentation, 577
 - diagnosis, 577–578
 - therapy, 578
- Burn-associated immunodeficiency, 602–603
- Bursa of Fabricius, 11
- C1
 - activation of, 137
 - septic shock, 154
- C2a, 138, 153
- C3
 - activation, inactivation of, 149
 - deficiency, 594
- C3b
 - in alternative pathway, 146–147
 - in classical complement pathway, 140, 141
- C3 convertase, 140
- C5, 140, 144, 147
- C5a, 144, 146, 459
- Calcineurin inhibitors, 506–507
- CALLA (common acute lymphocytic leukemia antigen), 547
- Carrier molecules, 52
- Cancer (*see also* Malignancies; Tumor)
 - immunity, effector mechanisms, 521–522
 - immunopotential, 495
- Candidiasis, chronic mucocutaneous, 585
- Cannabinoids, immunodeficiency, 605
- CD4
 - B-lymphocyte activation and, 227
 - expression, 175
 - as subpopulation marker, 179
 - thymocyte selection and, 176, 177
 - T-lymphocyte activation and, 62–63
 - T-lymphocyte–APC interaction and 195
- CD8
 - expression, 180
 - as a marker, 179
 - T-lymphocyte activation and, 62–63
- CD8+ cytotoxic T lymphocytes, 213–217
 - apoptosis, 215–217
 - characteristics of, 214
 - conjugation, 214–215
 - simulation of, 213–214
 - target cell destruction, 214–217
- CellCept (mycophenolate mofetil), 506
- Cell-mediated hypersensitivity reaction
 - systemic consequences, 407–408
 - T-cell activation, 193–207
 - T-cell helper
 - humoral immune response, 210–213
 - subsets, regulatory roles, 208–209
- CD86, 171

- Cell-mediated immunity, 5–6, 193–224
 - CD8+ cytotoxic T lymphocytes, 213–217
 - diagnostic evaluation, 564–569
 - cytokine assays, 568–569
 - delayed-type hypersensitivity, *in vivo* testing of, 564–566
 - mitogenic stimulation assays, 567
 - natural killer cells, 13–14, 566
 - response to antigenic stimulation, 567–568
 - T-lymphocyte membrane markers, 566
 - T-lymphocyte mitogens, 567
- helper T lymphocytes, in inflammatory responses, 209–210
- inactivation, T-cell responses, 207–208
- mucosal levels, 233
- natural killer cells, 217–218
- protective role of, 266–268
 - lymphocyte-mediated cytotoxicity, 267
 - macrophages, lymphocyte-mediated activation of, 267–268
 - regulatory cells, 218–220
- Cells in immune response, 11–30
 - adhesion molecules, ligands, 26–27
 - granulocytes, 14–15
 - lymph nodes, 17–19
 - anatomical organization, 17–18
 - physiological role, 18–19
 - lymphocyte traffic, 23–28
 - cell adhesion molecules, 25
 - lymphocyte recirculation, extravascular migration, 23–25
 - regulation of, 25–28
 - lymphocytes, 11–13
 - lymphoid tissues, organs, 16–23
 - monocytes, 14
 - mucosal-associated lymphoid tissues, 21–23
 - natural killer cells, 13–14
 - plasma cells, 13
 - spleen, 19–20
 - anatomical organization, 19
 - physiological role, 19
 - T lymphocytes, distribution of, 17
 - thymus, 20–21
 - anatomical organization, 20
 - physiological role, 20–21
- Cells in immune system, overview, 3–4
- Cellular immunodeficiencies, 583–585
- CFA (complete Freund's adjuvant), 55, 226
- Chediak-Higashi syndrome, 593
 - clinical manifestations, 593
- [Chediak-Higashi syndrome]
 - diagnosis, 593
 - treatment, 593
- Chemical immunosuppression, 506–507
 - rapamune, 507
 - sirolimus, 507
- Chemokine receptor family, 206
- Chemotaxis
 - migration to extravascular compartment, 245–247
 - phagocytic, 252–253
- Chimerism, 313
- Cholangitis, autoimmune (primary biliary cirrhosis), 342, 351
- Chronic active hepatitis, 352–353
- Chronic granulomatous disease, 592
- Chronic mucocutaneous candidiasis, 585
- Chronic primary hypoadrenalism, 344–345
- Circulating immune complexes, 455
- Circulation
 - lymphatic, 24–25
 - systematic, 25
- Cirrhosis, biliary, primary, 351
- Class I major histocompatibility complex molecules, 34
- Class II major histocompatibility complex molecules, 35–36
- Clonal deletion
 - B lymphocyte, models for, 319
 - negative selection and, 175–176
 - T lymphocyte
 - mechanisms of, 321
 - models for, 321–322
 - tolerance and, 314
 - transfusion effect and, 509
- Clonal expansion, 60–61
- Clonal regeneration, 324
- Clonal restriction, 60–61
- Clone, 61
- Cloning, 165
- Clq binding assay, 464–465
- Clusters of differentiation (CD), 165–166
- Cold agglutinin disease, 446, 535–536
- Combined immunodeficiency, 585–590
 - with immunoglobulins, 588
- Common acute lymphoblastic leukemia antigen (CALLA), 546–547
- Compatibility testing, 435
- Complement activation
 - exaggerated, pathology with, 152–154
 - immunoglobulins, 99–100
- Complement deficiencies, 156

- Complement fixation, 289–290
- Complement function, diagnostic evaluation of, 569
- Complement levels, in disease, 155–156
- Complement receptors, human cell membranes, 150–152
- Complement system, 135–160
 - activation of, 136
 - alternative complement pathway, 146–149
 - biological significance of, 148–149
 - alternative pathway/amplification loop, sequence of activation of, 147–148
 - amplification loop, alternative pathway, activation sequence, 147–148
 - angioedema, hereditary, 152–153
 - C3, activation, inactivation of, 149
 - classical complement pathway, 136–146
 - activation of, by antigen-antibody complexes, 136–146
 - anaphylatoxins, 146
 - C1 activation, 137
 - cascade, initiation of, 137
 - chemotactic factors, 146
 - early stages
 - C1 to C3, 137–141
 - regulatory mechanisms of, 141
 - immune adherence, 141–143
 - late stages, C1 and C3, 144–146
 - phagocytosis, 141–143
 - complement activation, exaggerated, pathology with, 152–154
 - complement levels, in disease, 155–156
 - complement deficiencies, 156
 - hypocomplementemia, clearance of immune complexes, 155–156
 - complement receptors, human cell membranes, 150–152
 - function of, 136
 - lectin pathway, complement activation, 149–150
 - microbial anticomplementary mechanisms, 156
 - pancreatitis, 154
 - paroxysmal nocturnal hemoglobinuria, 153–154
 - peripheral blood cells, receptors on, 151
 - proteolytic enzymes, 149
 - pulmonary distress syndrome, 154
 - pulmonary vascular leukostasis, hemodialysis and, 154
 - septic shock, C1-INH depletion and, 154
 - [Complement system]
 - synthesis, metabolism, complement components, 135–136
 - trauma, 154
 - Complement receptor (CR), in immune complex development, 461–462
 - Complete Freund's adjuvant (CFA), 55, 226
 - Component vaccines, 236–238
 - bacterial polysaccharides, 236
 - conjugate vaccines, 236–237
 - DNA vaccines, 237–238
 - inactivated toxins, 236
 - mixed component vaccines, 236
 - recombinant bacterial antigens, 236
 - synthetic peptide vaccines, 237
 - viral component vaccines, 237
 - Congenital thymus aplasia, (DiGeorge syndrome) 584–585
 - clinical presentation, 584
 - diagnosis of immunological abnormalities, 584
 - etiology and pathogenesis, 584
 - therapy, 584–585
 - Conjugate vaccines, 236–237
 - Contact hypersensitivity in humans, 407
 - Coombs test
 - direct, 434, 435, 439, 444–445, 445
 - indirect, 434–435
 - Copolymer-1 (COP-1; copaxone), 355–356
 - Counterimmunoelectrophoresis, 280
 - C-reactive protein, 260
 - Cromolyn, 426
 - Cross-immunization, 324
 - Cross-match
 - for blood transfusion, 435–436
 - for bone marrow transplantation, 502–503
 - Cross-reactions
 - antibody-antigen, 124–125
 - with tissue antigens, postinfectious 273
 - Cryoglobulinemia, essential or idiopathic, 464
 - Cryoglobulins, 462–464
 - Cyclosporin A, 485
 - Cytokine modifiers, 487–488
 - Cytokines
 - assays, 568–569
 - biological activity, 201–202
 - cytokine receptors, in plasma, urine, assay of, 304–305
 - in lymphocyte ontogeny, 161–162
 - proinflammatory, 200–202, 201–202, 407–408

[Cytokines]

- released by T_H1, T_H2 lymphocytes, 71
- sources, cellular, 201–202
- targets, 201–202

Cytotoxic agents, 485

Cytotoxic antibodies, 509–510

Cytotoxic effector cells, assays for, 305–306

Cytotoxic reactions, 400–402

- autoimmune hemolytic anemia, 400
- Goodpasture's syndrome, 401
- nephrotoxic nephritis, 401–402

Cytotoxic T lymphocytes, major

- histocompatibility complex restriction of, 40–41

DAF (decay-accelerating factor), 145–146

Dead cells, phagocytosis of, 252

Degranulation, phagocytic, 254

Delayed hypersensitivity reactions, 6, 405–408

- cell-mediated, systemic consequences of, 407–408

contact hypersensitivity in humans, 407

experimental studies, 405–406

- effector mechanisms, 406
- induction, 405–406

homograft rejection, 407

Jones-Mote reaction, 407

role of T lymphocytes in, 209

tuberculin test, 405

in vivo testing of, 564–566

Dendritic cells

- antigen presentation, rheumatoid arthritis, 386–387

lymphocyte ontogeny, 183

Diabetes, 345–349

autoimmunity, 334

genetic factors, 347–348

pathogenesis, 345–347

Diagnosis

immunodeficiency diseases, 555–572

- B-lymphocyte membrane markers, 562–564

cell-mediated immunity, diagnostic evaluation, 564–569

cytokine assays, 568–569

delayed-type hypersensitivity, in vivo testing of, 564–566

mitogenic stimulation assays, 567

natural killer cells, 566

response to antigenic stimulation, 567–568

[Diagnosis]

T-lymphocyte membrane markers, 566

T-lymphocyte mitogens, 567

complement function, diagnostic evaluation of, 569

humoral immunity, diagnostic evaluation, 557

immunoglobulins, antibodies,

- quantitative assay of, 557–562

molecular genetic studies, 569

phagocytic cell function, diagnostic evaluation of, 569

serum immunoglobulin levels, 557–559

immunoserology, 279–301

agglutination, 286–289

bacterial agglutination, 286–287

hemagglutination, 288–289

of inert particles coated with antigen, antibody, 287

complement fixation, 289–290

enzyme immunoassay, 299–301

immunofluorescence, 290–297

autoantibody detection, 292

flow cytometry, 293–297

cytoplasmic staining, 296

DNA analysis, 296

sorting, 296–297

surface staining, 293–296

in microbiology, 291–292

quantitative immunofluorescence assays, 292

tissue-fixed antigen-antibody complex detection, 292–293

precipitation assays, 280–286

counterimmunoelectrophoresis, 280

double diffusion method, 280

immunoelectrophoresis, 283

immunofixation, 283

immunonephelometry, 282–283

quantitative immunoelectrophoresis, 282

radial immunodiffusion, 280–282

western blot, 283–286

radioimmunoassay, 297–299

lymphocyte function, laboratory tests for assessment of, 301–307

antigenic stimulation, response to, 304

cytokines, cytokine receptors, in plasma, urine, assay of, 304–305

cytotoxic effector cells, assays for, 305–306

mitogenic stimulation assays, 302–303

- [Diagnosis]
 - mixed lymphocyte reaction, 307
 - mononuclear cells, isolation of, 302
 - tetramer assays, 304
 - phagocytic cell function, laboratory tests
 - for assessment of, 301
- Dialyzable leukocyte extracts, 495
- DiGeorge syndrome (congenital thymic aplasia), 584–585
 - clinical presentation, 584
 - diagnosis of immunological abnormalities, 584
 - etiology and pathogenesis, 584
 - therapy, 584–585
- Direct hemagglutination, 434
- Discrimination, self vs. nonself, 6–7
- Disodium cromoglycate, 426
- Disulfide bonds, reduction of,
 - immunoglobulin, 78–80
- DNA polymorphisms, immunoglobulins,
 - restriction fragment length polymorphisms, 112–113
- DNA vaccines, 237–238
- Donor-recipient matching, 502–503
- Double diffusion, 280
- Downregulation
 - autoreactive B cells, B-lymphocyte ontogeny, 172
 - immune response, 322–324
 - mucosal tolerance, 323–324
 - anti-idiotypic immune responses, 324
 - suppressor T lymphocytes, 323
- Downregulatory molecules on B cells, B-lymphocyte ontogeny, 171–172
- Drug-induced disorders
 - hemolytic anemia induced by, 446–448
 - autoimmunity induction mechanism, 448
 - drug adsorption mechanism, 447–448
 - immune complex mechanism, 447
 - immunodeficiency from, 605–606
 - alcohol, 605
 - cannabinoids, 605
 - opiates, 606
- ECF-A (eosinophil chemotactic factors of anaphylaxis), 421
- E heavy-chain allotypes, immunoglobulin, 112
- Early component deficiencies, 593–594
- Eczema, thrombocytopenia,
 - immunodeficiency with, 590
 - clinical presentation, 590
 - genetics and pathogenesis, 590
- [Eczema]
 - laboratory findings, 590
 - therapy, 590
- ELAM-1 (endothelial-leukocyte adhesion molecule-1: E-selectin), 26
- Encephalomyelitis, allergic, experimental, 333
- Endogenous antigens, 56
- Endothelial-leukocyte adhesion molecule-1 (ELAM-1; E-selectin), 26
- Environment, control, in immediate hypersensitivity prevention, 423
- Environmental factors
 - in onset of autoimmune diseases, 331–332
 - in systemic lupus erythematosus, 370–371
- Enzyme immunoassay, 299–301
- Eosinophil chemotactic factors of anaphylaxis (ECF-A), 421
- Eosinophilic cationic protein, 423
- Eosinophils
 - in cytotoxic reactions, 265
 - functions, 15
 - in immediate hypersensitivity, 422–423
- Epitope (*see* Antigenic determinants)
- Epstein-Barr virus-associated B-cell lymphomas, 549–550
 - B-cell lymphomas, in immunocompromised patients, 549
 - Burkitt's lymphoma, 549
 - Hodgkin's disease, 550
- Equivalence, 126
- Erythroblastosis fetalis, 440–443 (*see also* Hemolytic disease of newborn)
 - case study, 440
 - clinical presentation, 441
 - epidemiology, 441
 - immunological diagnosis, 442
 - mechanisms of sensitization, 441
 - pathogenesis, 440–441
 - prevention, 442
- Erythropoietin, 624
- E-selectin (endothelial-leukocyte adhesion molecule), 26
- Exogenous antigens, 56
- Experimental studies, 405–406
 - allergic encephalomyelitis, 333
 - effector mechanisms, 406
 - induction, 405–406
- Extravascular hemolytic reactions, 438
- Fab fragment, 78, 79, 80
- F(ab')₂ fragment, 80

- Fabricsius, bursa of, 11–12
 Fc fragment, 79, 80
 Fc receptor
 cell activation mediated by, 129
 immunoglobulins
 binding to, 100–102
 types of, 100
 Felty's syndrome, 380, 391
 Fixation, complement, 289–290
 FKBP, 482
 FK506 (tacrolimus), 482
 Flow cytometry, 293–297
 cytoplasmic staining, 296
 DNA analysis, 296
 Follicles, lymphoid (nodules), 17, 18
 Fractional turnover rate, of immunoglobulins, 98
 Frameshift mutations, 110

 Gamma-chain disease, 542–543
 Gamma globulin
 intravenous
 for humoral immunodeficiencies, 578
 for idiopathic thrombocytopenic purpura, 357
 Gammopathies, monoclonal, idiopathic, 540–541
 Gastrointestinal tract, autoimmune diseases of, 350–353
 G-CSF (granulocyte colony-stimulating factor), 490, 624
 Glomerulonephritis, in systemic lupus erythematosus, 369–370
 Glucocorticoids, 485, 506
 anti-inflammatory effects, 475–476
 clinical applications, 485
 for graft rejection prevention, 474
 for idiopathic thrombocytopenia purpura, 357
 for immediate hypersensitivity, 426
 for multiple sclerosis, 355
 for rheumatoid arthritis, 390
 GM allotype (IgG heavy-chain allotypes), 111–112, 114
 Goiter, diffuse toxic or exophthalmic (Graves' disease), 341–343
 Goodpasture's syndrome, 401
 Graft rejection, 503–506 (*see also* Graft-versus-host reaction; Transplantation)
 acute rejection, 504–505
 case study, 505–506

 [Graft rejection]
 delayed, chronic rejection, 505
 hyperacute (early) rejection, 503–504
 Graft-versus-host reaction, 511–513
 case study, 513
 pathogenesis, 512
 pathology, 512
 prevention, 512–513
 treatment, 512
 Granulocytes, 14–15
 in immune complex diseases, 461–462
 in immune complex-induced hypersensitivity, 403
 Granulocyte colony-stimulating factor (G-CSF), 490, 624
 Granulomatous disease, chronic, 592
 Granulomatous reactions, T-cell hypersensitivity and, 209–210
 Graves' disease, 341–343
 Gut-associated lymphoid tissue (GALT)
 antigenic stimulation, 233
 distribution, 16
 Peyer's patches, 22, 23, 24
 tonsils, 22

 Hairy cell leukemia, 545–546
 Haplotypes, 39, 40, 112
 Haptens, 52
 Hashimoto's disease, 342–344
 Hay fever, 399
 Heavy-chain allotypes
 immunoglobulin, 111–112
 V-region, 112
 immunoglobulin A, 112
 immunoglobulin E, 112
 Heavy-chain diseases, 542–543
 alpha-chain disease, 542
 gamma-chain disease, 542–543
 mu-chain disease, 543
 Heavy chains, light chains, immunoglobulin, structural, antigenic heterogeneity of, 81–82
 Helper T lymphocytes
 activation of, 62–66
 antigen presentation to, MHC-II, 41
 cell subsets, regulatory roles, 208–209
 humoral immune response, 210–213
 in inflammatory responses, 209–210
 major histocompatibility complex, antigen presentation to, 41
 T_H1, T_H2 subsets, regulatory roles, 208–209

- [Helper T lymphocytes]
 - T_H1, T_H2 subpopulations, signals involved in control of differentiation of, 72
- Hemagglutination, 288–289
- Hemodialysis, pulmonary vascular leukostasis and, 154
- Hemoglobinuria, nocturnal, paroxysmal, 153–154
- Hemolytic anemia
 - autoimmune, 400
 - drug-induced, 446–448
- Hemolytic disease of newborn, 440–443
 - case study, 440, 443
 - clinical presentation, 441
 - epidemiology, 441
 - immunological diagnosis, 442
 - mechanisms of sensitization, 441
 - pathogenesis, 440–441
 - prevention, 442
 - treatment, 442–443
- Hepatitis, 352–353
 - chronic, active, 352–353
- Hepatitis B vaccine, 237
- Hepatocytes, IgA transport, 94
- Hereditary angioneurotic edema, 152–153
- Heterozygosity, major histocompatibility complex, 43
- HEV (high endothelium venules), 24, 27
- HGPRT (hypoxanthine guanine phosphoribosyl transferase), 165
- High endothelium venules (HEV) , 24, 27
- Hinge region, 84–85
- Histamine, 420
- Histocompatibility antigen (*see* Human leukocyte antigens)
- Homograft rejection, 407
- Hormones
 - in rheumatoid arthritis, 388–389
 - in systemic lupus erythematosus, 370
 - thymic, immunopotential, 495–496
- Human aggregate-free globulin (HAGG), 317
- Human immunodeficiency virus, 608–609
 - ancillary therapies, 623–625
 - antiretroviral agents, 619–622
 - asymptomatic infection, 616–617
 - clinical stages of, 616–617
 - early symptomatic, 617
 - epidemiology of, 609–610
 - immune system, 610–614
 - immunopotential, 494
 - immunoprophylaxis, 625
 - late symptomatic, advanced, 617
- [Human immunodeficiency virus]
 - natural history of, 614–615
 - resistance, to antiretrovirals, 623
 - serological diagnosis of, 619
 - therapy, 619–625
- Human leukocyte antigens, 33
 - classes, 33–34
 - genes, gene products
 - classification, 33–37
 - detection of, 33–37
 - structure, 33–37
 - identification, 36–37
- Humoral immune response, 264
 - anamnestic response, 230–231
 - diagnostic evaluation, 557
 - immunization, 234–240
 - immunogens, 225–227
 - B-cell activation, 226–227
 - deliberate immunization, 226
 - exposure to natural immunogens, 225–226
 - mucosal humoral immune response, 232–234
 - primary immune response, 227–229
 - T-cell help and, 210–213
- Humoral immunodeficiencies, 574–583
- Hyper-immunoglobulin E syndrome, 591
- Hyper-immunoglobulin M syndrome, X-linked, 581–582
 - clinical presentation, 581
 - diagnosis, 581
 - genetics and physiopathology, 581
 - therapy, 582
- Hyperlipidemia, 536
- Hypersensitivity
 - autoimmune diseases, immunosuppressive drugs in, 485
 - cytotoxic reactions, 400–402
 - autoimmune hemolytic anemia, 400
 - Goodpasture's syndrome, 401
 - nephrotoxic nephritis, 401–402
 - delayed hypersensitivity reactions, 6, 405–408
 - cell-mediated, systemic consequences of, 407–408
 - contact hypersensitivity in humans, 407
 - experimental studies, 405–406
 - effector mechanisms, 406
 - induction, 405–406
 - homograft rejection, 407
 - Jones-Mote reaction, 407
 - tuberculin test, 405

- [Hypersensitivity]
 - diseases, use of immunosuppressive drugs
 - in, 485
 - immediate (*see* Type I hypersensitivity reactions)
 - immune complex-induced hypersensitivity reactions, 402–405
 - Arthus reaction, 403
 - serum sickness, 404–405
 - immunoglobulin E-mediated, 411–430
 - case study, 413, 426–427
 - drug therapy, 424–426
 - early, late phases in type I hypersensitivity, 420–423
 - eosinophils, in late phase, 422–423
 - genetic control, immunoglobulin E synthesis, 416–417
 - immunoglobulin E antibodies, 414–418
 - quantitative assay, 414–415
 - skin tests, 415–416
 - interaction of immunoglobulin E with cell surface receptors, 418–420
 - pathogenesis, 413–423
 - prevention, 423–424
 - T-B cell cooperation in, 417–418
 - reactions, 397–410
 - type I hypersensitivity reactions, 398–400
 - clinical expression, 399
 - historical overview, 398–399
 - pathogenesis, 400
- Hyperviscosity syndrome, 534, 535, 536
- Hypoadrenalism, primary, chronic, 344–345
- Hypocomplementemia, clearance of immune complexes, 155–156
- Hypogammaglobulinemia
 - acquired, 578–579
 - clinical presentation, 579
 - diagnosis, 579
 - physiopathology, 578
 - therapy, 579
 - of infancy, transient, 574–576
- Hyposensitization, 423–424
- Iatrogenically induced immune deficiencies, 603–605
 - neutropenia, 603
 - causes of, 603
 - postsurgery immunodeficiency, 603–604
 - splenectomy, 604–605
 - thymectomy, 605
- ICA (anti-islet cell antibodies), 345
- IDDM (*see* Insulin-dependent diabetes mellitus)
- Idiopathic monoclonal gammopathies, 540–541
- Idiopathic thrombocytopenic purpura, 356–357
- Idiotypes, 110
- Ig (*see* Immunoglobulin)
- IL (*see* Interleukins)
- IL-2 receptors, expression, 195–196
- Immediate hypersensitivity (*see* Type I hypersensitivity reactions)
- Immune complex diseases, 453–472
 - adsorption, transfer of immune complexes, 456
 - classification, immune complex disease, 465–466
 - clinical expression, 466–467
 - immune complex formation, cell interactions, 455–456
 - circulating immune complexes, 455
 - physicochemical characteristics, 454–455
 - physiopathology, 454–461
 - soluble immune complexes, detection of, 462–465
 - cryoglobulins, 462–464
 - interactions with complement, 464–465
 - polyethylene glycol, precipitation of soluble immune complexes, 464
 - specific immune-complex-screening tests, 465
 - therapeutic approaches to, 467
- Immune complex-induced hypersensitivity reactions, 402–405
 - Arthus reaction, 403
 - serum sickness, 404–405
- Immune complex-induced inflammation, postinfectious, 272–273
- Immune complexes, systemic lupus erythematosus, 368–369
- Immune elimination, 231
- Immune hemolytic anemias, 444–449
 - autoimmune hemolytic anemia, 444–446
 - case study, 444, 449
 - cold agglutinin disease, 446
 - diagnosis, 444–446
 - drug-induced hemolytic anemia, 446–448
 - autoimmunity induction mechanism, 448
 - drug adsorption mechanism, 447–448
 - immune complex mechanism, 447
 - treatment, 448–449
- Immune recognition, 60–61

- Immune response
 - abnormal consequences of, 271–273
 - antigen-antibody complexes, 272
 - autoimmunity, 273
 - bacterial “superantigens,” 271–272
 - postinfectious tissue damage, 272–273
 - cross-reactions with tissue antigens, 273
 - immune complex-induced inflammation, 272–273
 - immune destruction, infected cells, 273
 - induction of, 51–76
 - antigen processing, presentation, 62
 - antigen receptor, on T lymphocytes, B lymphocytes, 61–62
 - cytotoxic T lymphocytes, antigen presentation, activation of, 66–68
 - factors associated with, 54–56
 - helper T lymphocytes, activation of, 62–66
 - immune recognition, clonal restriction, expansion, 60–61
 - MHC complex and, 40–44
 - primary, 249
 - antigen fate and, 231–232
 - description of, 227–229
 - secondary, 230–231
 - antigen fate and, 231, 232
 - sequence of events in, 228
 - stages of, 2–3, 3
- Immune system modulators, 473–500
 - anti-inflammatory drugs, 474
 - cytokine modifiers, 487–488
 - hypersensitivity, autoimmune diseases, immunosuppressive drugs in, 485
 - immunopotential, 488–496
 - active immunization, 494–495
 - bacterial, chemical immunomodulators, 496
 - biological response modifiers, 488–492
 - dialyzable leukocyte extracts, 495
 - intravenous immunoglobulins, 492–494
 - thymic hormones, 495–496
 - immunosuppression, 474–488
 - drugs, 474–484
 - prolonged immunosuppression, adverse consequences of, 485–487
- Immunization, 234–240
 - attenuated vaccines, 238–239
 - recombinant organisms, 238–239
 - historical background, 234–235
 - [Immunization]
 - immunotherapeutic agents, vaccines as, 240
 - recommended immunizations, 239–240
 - types of vaccines, 235–238
 - component vaccines, 236–238
 - bacterial polysaccharides, 236
 - conjugate vaccines, 236–237
 - DNA vaccines, 237–238
 - inactivated toxins, 236
 - mixed component vaccines, 236
 - recombinant bacterial antigens, 236
 - synthetic peptide vaccines, 237
 - viral component vaccines, 237
 - killed vaccines, 236
- Immunoblotting (*see* Immunofixation)
- Immunodeficiency
 - acquired, 600–607
 - with ataxia-telangiectasia, 588
 - clinical presentation, 588
 - genetics and physiopathology, 588
 - with thrombocytopenia, eczema, 590
 - clinical presentation, 590
 - genetics and pathogenesis, 590
 - laboratory findings, 590
 - therapy, 590
- Immunodeficiency diseases
 - diagnosis, 555–572
 - B-lymphocyte membrane markers, 562–564
 - cell-mediated immunity, diagnostic evaluation, 564–569
 - cytokine assays, 568–569
 - delayed-type hypersensitivity, *in vivo* testing of, 564–566
 - mitogenic stimulation assays, 567
 - natural killer cells, 566
 - response to antigenic stimulation, 567–568
 - T-lymphocyte membrane markers, 566
 - T-lymphocyte mitogens, 567
 - complement function, diagnostic evaluation of, 569
 - humoral immunity, diagnostic evaluation, 557
 - immunoglobulins, antibodies, quantitative assay of, 557–562
 - molecular genetic studies, 569
 - phagocytic cell function, diagnostic evaluation of, 569
 - serum immunoglobulin levels, 557–559

- [Immunodeficiency diseases]
 - primary, 573–598
 - cellular immunodeficiencies, 583–585
 - combined immunodeficiencies, 585–590
 - humoral immunodeficiencies, 574–583
 - phagocytic cell deficiencies, 590–593
- Immunodiffusion, radial, 280–282
- Immunoelectrophoresis, 283
 - quantitative, 282
- Immunofixation, 283
- Immunofluorescence, 290–297
 - autoantibody detection, 292
 - flow cytometry, 293–297
 - cytoplasmic staining, 296
 - DNA analysis, 296
 - sorting, 296–297
 - surface staining, 293–296
 - in microbiology, 291–292
 - quantitative immunofluorescence assays, 292
 - tissue-fixed antigen-antibody complex detection, 292–293
- Immunogenicity, 51–52
 - characteristics of, 54
- Immunoglobulin A, 87–88
 - deficiency, selective, 579–581
 - clinical presentation, 580
 - diagnosis, 580
 - physiopathology, 579–580
 - therapy, 580–581
 - subclasses, 82
 - secretory, 87–88
 - biosynthesis of, 94
 - transport, 95
- Immunoglobulin D, 88
- Immunoglobulin E, 88
 - hypersensitivity mediated by, 411–430
 - case study, 413, 426–427
 - drug therapy, 424–426
 - early, late phases in type I hypersensitivity, 420–423
 - eosinophils, in late phase, 422–423
 - genetic control, immunoglobulin E synthesis, 416–417
 - immunoglobulin E antibodies, 414–416
 - quantitative assay, 414–415
 - response, 416, 417–418
 - skin tests, 415–416
 - interaction of immunoglobulin E with cell surface receptors, 418–420
- [Immunoglobulin E]
 - pathogenesis, 413–423
 - prevention, 423–424
 - T-B cell cooperation in, 417–418
- Immunoglobulin G (IgG)
 - characteristics, 81
 - complement-binding sequences, 129
 - functional topography, 78
 - half-life, 97
 - placental transfer, 99
 - proteolytic digestion, 78
 - structural model, 78–79
 - structure, 83
 - subclasses, 81–82
- Immunoglobulin M, 87
- Immunoglobulin molecules, immunoglobulin
 - heavy-chain allotypes, 111–112
- Immunoglobulin superfamily, 26
- Immunoglobulin structure, 77–92
 - antibody-combining site, 86–87
 - characteristics of immunoglobulins, 81
 - disulfide bonds, reduction of, 78–80
 - domains, 82–85
 - heavy, light chains, structural, antigenic heterogeneity of, 81–82
 - immunoglobulin A, 87–88
 - subclasses, 82
 - immunoglobulin D, 88
 - immunoglobulin E, 88
 - immunoglobulin M, 87
 - immunoglobulin superfamily of proteins, 85–86
 - proteolytic digestion, 78
 - prototype immunoglobulin molecule, 77–80
 - regions, 82–85
 - variable, constant, 82–84
 - subclasses, 82
- Immunoglobulins, 93–104
 - biological properties, 98–102
 - complement activation, 99–100
 - Fc receptors
 - binding to, 100–102
 - types of, 100
 - placental transfer, 99
 - biosynthesis, 93–96
 - combined immunodeficiency with, 588
 - genetics, 105–118
 - allelic exclusion, 113
 - allotypes, 114
 - antibody diversity, genetic basis of, 109–110

- [Immunoglobulins]
 - antigenic determinants, immunoglobulin molecules, 110–112
 - allotypes, 110–112
 - heavy-chain V-region allotype, 112
 - immunoglobulin A heavy-chain allotypes, 112
 - immunoglobulin E heavy-chain allotypes, 112
 - immunoglobulin heavy-chain allotypes, 111–112
 - K-type light-chain allotypes, 112
 - idiotypes, 110
 - isotypes, 110
 - diseases, 114
 - DNA polymorphisms, restriction fragment length polymorphisms, 112–113
 - gene rearrangement, 105–109
 - GM allotypes, immunoglobulin subclass concentrations, 114
 - immune response, 114
 - restriction fragment length polymorphisms, 112–113
 - immunoglobulins, 112–113
 - intravenous, 492–494
 - metabolism, 96–98
 - quantitative assay of, 557–562
- Immunohematology, 431–452
 - ABO system, 431–432
 - autoimmune hemolytic anemia, warm
 - antibody type, 444–446
 - blood groups, 431–433
 - blood transfusion
 - reactions, 437–440
 - serological principles of, 434–437
 - blood types, laboratory determination of, 434
 - cold agglutinin disease, syndrome, 446
 - drug-induced hemolytic anemia, 446–448
 - extravascular hemolytic reactions, 438
 - hemolytic disease of newborn, 440–443
 - immune hemolytic anemias, 444–449
 - immunological diagnosis, 442
 - intravascular hemolytic reactions, 437–438
 - nonhemolytic immune transfusion
 - reactions, 439–440
 - reagents, 434
 - Rh system, 432
 - sensitization, mechanisms of, 441
 - tube testing, alternatives to, 437
- Immunonephelometry, 282–283
- Immunophilins, 479
- Immunopotential, 488–496
 - active immunization, 494–495
 - bacterial immunomodulators, 496
 - biological response modifiers, 488–492
 - cellular sources, 489–490
 - clinical applications, 490–492
 - function, 489
 - structure, 489
 - cancer, 495
 - chemical immunomodulators, 496
 - dialyzable leukocyte extracts, 495
 - transfer factor, 495
 - HIV infection, 494
 - intravenous immunoglobulins, 492–494
 - thymic hormones, 495–496
- Immunoserology, 279–301
 - agglutination, 286–289
 - bacterial agglutination, 286–287
 - hemagglutination, 288–289
 - of inert particles coated with antigen, antibody, 287
 - complement fixation, 289–290
 - enzyme immunoassay, 299–301
 - immunofluorescence, 290–297
 - autoantibody detection, 292
 - flow cytometry, 293–297
 - cytoplasmic staining, 296
 - DNA analysis, 296
 - sorting, 296–297
 - surface staining, 293–296
 - in microbiology, 291–292
 - quantitative immunofluorescence assays, 292
 - tissue-fixed antigen-antibody complex detection, 292–293
 - precipitation assays, 280–286
 - counterimmunoelectrophoresis, 280
 - double diffusion method, 280
 - immunoelectrophoresis, 283
 - immunofixation, 283
 - immunonephelometry, 282–283
 - quantitative immunoelectrophoresis, 282
 - radial immunodiffusion, 280–282
 - western blot, 283–286
 - radioimmunoassay, 297–299
- Immunosuppression, 474–488, 506–511
 - biological response modifiers, 507–508
 - anti-T-cell monoclonal antibodies, 507–508
 - antihymocyte, antilymphocyte globulins, 507

- [Immunosuppression]
 - chemical immunosuppression, 506–507
 - antimetabolites, 506
 - calcineurin inhibitors, 506–507
 - glucocorticoids, 506
 - rapamune, 507
 - rapamycin, 507
 - sirolimus, 507
 - side effects, 510–511
 - malignancies, 511
 - opportunistic infections, 510–511
 - total lymphoid irradiation, 508
 - transfusion effect, 509–510
- Immunosuppressive drugs, 474–484
 - alkylating agents, 477–479
 - anti-inflammatory effects, 475–476
 - antimetabolites, 477–479
 - apoptosis, induction of, 475
 - co-stimulatory signals, monoclonal
 - antibodies blocking, 483–484
 - cyclosporine A, 479–482
 - cytokine synthesis, downregulation of, 475
 - glucocorticoids, 475–477
 - immunosuppressive monoclonal antibodies, 483–484
 - immunosuppressive polyclonal antibody preparations, 482–483
 - inhibitory signals, monoclonal antibodies delivering, 484
 - interleukin-2 receptor, monoclonal
 - antibodies blocking, 484
 - nonsteroidal anti-inflammatory drugs, 476–477
 - sirolimus, 479–482
 - tacrolimus, 479–482
- Immunotherapeutic agents, vaccines as, 240
- Inactivated toxins, 236
- Inactivation of T-cell responses, 207–208
- Induction of immune response, factors
 - associated with, 54–56
 - adjuvants, use of, 55–56
 - antigen administration, method, 55
 - genetic background, 55
- Ineffective immune responses, 269–270
- Infantile agammaglobulinemia, 577–578
 - clinical presentation, 577
 - diagnosis, 577–578
 - therapy, 578
- Infection
 - immunodeficiency, 606–607
 - bacterial infections, 606
 - parasitic infections, 606–607
- [Infection]
 - viral infections, 607
 - AIDS, 607–626
 - immunosuppressive effects of, 270–271
- Infectious agents, immune elimination of, 5–6
- Inflammation
 - cell-mediated immunity and, 267–268
 - helper T-lymphocyte role in, 209–210
 - immune-complex-induced, 272–273
 - immune reactions and, 28
- Ingestion, phagocytic, 253–254
- Insulin-dependent diabetes mellitus (IDDM)
 - DQ molecules and, 44
 - MHC markers, 347–348
 - pancreatic tissue and, 342
 - pathogenesis, 345–346
- Insulinitis, 346
- Integrins, 25, 26, 28
- Intercellular adhesion molecules, (ICAMs)
 - extravascular emigratin of leukocytes and, 459
 - functions, 25, 26, 172
 - interaction with LFA-1, 215
- Interleukins (ILs), 1
 - biological effects, 203
 - cellular sources, 203
 - central nervous system effects, 203
 - hematopoietic effects, 205
 - vascular effects, 202–203
- Interleukin-1 antagonists, 488
- Interleukin-2 synthesis deficiency, 588–589
 - clinical presentation, 589
 - diagnosis, 589
 - genetics and physiopathology, 588–589
- Interleukins, released by T_H1, T_H2
 - lymphocytes, 71
- Intracellular infectious agents, immune elimination of, 5–6
- Intracellular killing, phagocytic cells and, 249–251
- Intravascular hemolytic reactions, 437–438
- Intravenous immunoglobulins, 492–494
- Intrinsic association constant, 122
- Irradiation, lymphoid, total, 508
- Ischemia, cold-induced, 536
- Isoniazide, induction of systemic lupus-like syndrome, 371
- J chain, 87
- Job's syndrome, 591
- Jones-Mote reaction, 407

- Kernicterus, 441
- K-type light-chain allotypes, immunoglobulin molecules, 112
- Killed vaccines, 236
- Killing assays, phagocytic function, 255–256
- KM allotypes (K-type light-chain allotypes), 112, 114
- Kupffer's cells, 23

- Langerhans cells, 14
- Late complement component deficiencies, 595
- LATS (long-acting thyroid stimulator), 342
- Lectin pathway, complement activation, 149–150
- Leukemia, 543–550
 - defined, 543–544
 - hairy cell, 545–546
 - lymphocytic
 - acute, 546–550
 - B-cell acute lymphocytic leukemia, 546–547
 - classification, 546
 - enzymatic markers of acute lymphocytic leukemia, 546
 - T-cell acute lymphocytic leukemia, 547–548
 - T-cell leukemia associated with HTLV-1, 548–549
 - chronic, 545
 - plasma cell, 540
- Leukocyte common antigen (LCA; CD45), 180–181
- Leukocyte extracts, dialyzable, 495
- Leukocyte function antigen (LFA) 1 (CD11a)
 - functions
 - interaction with ICAM-1
- Leukocyte markers, lymphocyte ontogeny, 187–190
- Leukocytes
 - adherence, disorders of, 591
 - polymorphonuclear
 - macrophages, comparison, 251
 - monocytes, comparison, 251
 - physiology of, 245–251
- Leukostasis, vascular, pulmonary, hemodialysis and, 154
- Light-chain allotypes, immunoglobulin, K-type, 112
- Light-chain disease, 530, 538

- Light chains, heavy chains, immunoglobulin, structural, antigenic heterogeneity of, 81–82
- Linkage disequilibrium, 39
- Liver, autoimmune diseases of, 350–353
- Long-acting thyroid stimulator (LATS), 342
- L-selectin (leukocyte adhesion molecule-1), 26
- LTB4 (leukotriene B4), 421
- Lupoid hepatitis, 352
- Lupus erythematosus, systemic, 334
- Lymph nodes
 - anatomical organization, 16,18
 - circulation, 19
 - physiological role, 18–19
- Lymphocyte diversity, ontogeny, study of, 163–166
 - genetic approaches, 166
 - lymphocyte membrane markers, 163–166
 - CD nomenclature, 165–166
 - monoclonal antibodies, 164–165
- Lymphocyte function, laboratory assessment, 301–307
 - antigenic stimulation, response to, 304
 - cytokines, cytokine receptors, in plasma, urine, assay of, 304–305
 - cytotoxic effector cells, assays for, 305–306
 - mitogenic stimulation assays, 302–303
 - mixed lymphocyte reaction, 307
 - mononuclear cells, isolation of, 302
 - tetramer assays, 304
- Lymphocyte ontogeny
 - B-lymphocyte ontogeny, 167–172
 - B-cell activation
 - regulation, surface molecules involved in, 169–172
 - surface molecules involved in, 169–171
 - B-cell maturation, 168–169
 - isotype switching, 168
 - B-lineage subpopulations, developmental order of, 167–168
 - downregulatory molecules on B cells, 171–172
 - ontogenic development, immunoglobulin synthesis, 169
 - cytokines, in lymphocyte ontogeny, 161–162
 - dendritic cells, 183
 - leukocyte markers, 187–190
 - membrane markers, 161–192

- [Lymphocyte ontogeny]
 - natural killer cells, 181–183
 - activation, 183
 - inhibitory molecules, 182–183
 - ontogeny, 181–182
 - receptors, 182–183
 - ontogeny, by opposing signaling events,
 - regulation of, 162
 - stem cell differentiation, 161
- T lymphocyte
 - B lymphocyte
 - differentiation, 166–167
 - coreceptors, 166
 - gene arrangement, 166
 - receptors, selection of, 166–167
 - differentiation of, 166–167
 - ontogeny, 173–181
 - coreceptors, 175
 - markers, T-cell activation, 180–181
 - inhibition of, 181
 - membrane markers, mature T lymphocytes, 179–181
 - pre-T lymphocytes
 - enzymatic activity in, 173
 - markers, 173
 - receptor selection, 175–178
 - negative selection, 175–176
 - positive selection, 176–178
 - T-cell differentiation after birth, 178
 - TcR genes, rearrangement of, 173–175
 - TcR structure, 178–179
- Lymphocytes, 11–13, 51–76 (*see also* B lymphocyte; T lymphocyte)
 - cell-mediated immunity and, 5–6
- Lymphocytic leukemia
 - acute, 546–550
 - B-cell acute lymphocytic leukemia, 546–547
 - classification, 546
 - enzymatic markers of acute lymphocytic leukemia, 546
 - T-cell acute lymphocytic leukemia, 547–548
 - T-cell leukemia associated with HTLV-1, 548–549
 - chronic, 545
- Lymphoid development, during fetal life, 162–163
- Lymphoid irradiation, total, 508
- Lymphoid organs, 16, 17
- Lymphoid tissues, 16, 17
- Lymphomas, 543–550
 - Epstein-Barr virus-associated B-cell lymphomas, 549–550
 - B-cell lymphomas, in immunocompromised patients, 549
 - Burkitt's lymphoma, 549
 - Hodgkin's disease, 550
 - Mediterranean-type abdominal, 542
- Lymphotoxin (tumor necrosis factor- β), 202
- Mac-1 (CD11b), 26–27
- MAC (membrane attack complex), 144–145
- Macroglobulinemia, Waldenstrom's, 541–542
 - clinical features, 541
 - diagnosis, 541
 - management, 541–542
- Macrophages, 14
 - comparison of polymorphonuclear leukocytes and, 251
 - lymphocyte-mediated activation, 267–268
 - physiology of, 251–252
- Macrophage chemotactic protein (MCP), 204, 267
- Macrophage inflammatory proteins (MIPs), 204, 219–220
- Major histocompatibility complex, 31–50
 - antigens
 - classes, characteristics of, 34
 - complexity, 43
 - structure of, 34–36
 - class I MHC molecules, 34
 - class II MHC molecules, 35–36
 - binding, immune response and, 42
 - cellular distribution, MHC antigens, 37
 - chromosomal localization, arrangement, MHC genes, 37–38
 - classification, human leukocyte antigen genes, gene products, 33–37
 - cytotoxic T lymphocytes, MHC restriction of, 40–41
 - deficient expression of molecules, 589–590
 - detection of human leukocyte antigen genes, gene products, 33–37
 - disease associations, 44–47
 - autoimmune diseases, 44–47
 - malaria, 44
 - expression, regulation of, 41–42
 - genetics, 38–40
 - helper T lymphocytes, antigen presentation to, MHC-II, 41
 - heterozygosity, 43

- [Major histocompatibility complex]
 - human leukocyte antigens, 33
 - classes, 33–34
 - identification, human leukocyte antigen antigens, 36–37
 - immune response and, 40–44
 - MHC-II diversity, 42
 - overview, 33
 - peptide-carrying proteins, 43–44
 - restriction, cytotoxic T lymphocytes, 40–41
 - restrictive role, MHC-CD interactions, 42
 - structure, human leukocyte antigen genes, gene products, 33–37
- Major histocompatibility complex-CD
 - interactions, restrictive role, 42
- Major histocompatibility complex-II
 - diversity, 42
 - helper T lymphocytes, antigen presentation to, 41
- Malaria, major histocompatibility complex, 44
- Malignancies (*see also* Cancer; Tumor)
 - B-cell dyscrasias, 529–543
 - immune system, 529–554
 - leukemias, 543–550
 - lymphomas, 543–550
- Malignant transformation, natural killer cells, 218
- Malnutrition, immunodeficiency, 600–601
- MALT (mucosa-associated lymphoid tissues), 21–22
- Mannose-binding protein, 260
- Mannose receptors, 260
- Mast cells
 - Fcε receptors, 88
 - mediator-release, 424, 425
 - tissue-fixed, 15
 - type I hypersensitivity and, 400
- Masugi nephritis (*see* Nephrotoxic nephritis)
- Materno-fetal transmission, HIV, 623
- MCP (macrophage chemotactic protein), 204, 267
- M-CSF (monocyte colony-stimulating factor), 490
- Measles, 270
- Mediterranean-type abdominal lymphoma, 542
- Membrane attack complex (MAC), 144–145
- Membranoproliferative glomerulonephritis, 327
- Memory, immunological, 2, 13
- Memory cells, expanded population of, consequences of existence of, 230
- 6-Mercaptopurine (6-MP), 477, 478, 479
- Meta-aminobenzene sulfonic acid, antigens tested with immune serum for, 120
- Metanilic acid, 120
- Methotrexate, 477, 478
- α-Methyl dopa-induced hemolytic anemia, 447, 448–449
- Microbial anticomplementary mechanisms, 156
- Microchimerism, 510
- β2-Microglobulin, 34
- MIF (migration-inhibition factor), 200, 204, 267
- Migration-inhibition factor (MIF), 200, 204, 267
- MIP (macrophage inflammatory protein), 204
- Mitogenic stimulation assays, 302–303, 567
- Mixed component vaccines, 236
- Mixed lymphocyte reaction, 307
- Molecular genetic studies, 569
- Molecular mimicry, in onset of autoimmune diseases, 332
- Monoclonal antibodies, production, 164–165
- Monoclonal immunoglobulins, 81
- Monoclonal gammopathies, idiopathic, 540–541
- Monoclonal proteins (paraproteins), 529, 537
- Monocytes, 14
 - comparison of polymorphonuclear leukocytes and, 251
 - physiology of, 251–252
- Mononuclear cells, isolation of, 302
- Mu-chain disease, 543
- Mucocutaneous candidiasis, chronic, 585
- Mucosa-associated lymphoid tissues (MALT), 21–22
- Mucosal humoral immune response, 232–234
- Mucosal immunity
 - passive transfer, 233–234
 - physiological significance of, 234
- Mucosal levels
 - cell-mediated immune mechanisms, 233
 - humoral immunity at, 233
- Mucosal tolerance, 323–324
 - anti-idiotypic immune responses, 324
- Multiple myeloma, 537–540
 - clinical features, 77, 537
 - laboratory diagnosis, 537–538
 - management, 538–540
- Multiple sclerosis, 354–356
- Myasthenia gravis, 353–354
- Mycophenolate mofetil (CellCept), 506

- Myelin basic protein (MBP), 354
 Myocarditis, autoimmune, 332
- Narcolepsy, 45, 47
 Natural antibodies, 262–264
 Natural killer cells, 13–14, 217–218, 262, 566
 activation of, 217–218
 antibody-dependent cellular cytotoxicity, 218
 lymphocyte ontogeny, 181–183
 activation, 183
 inhibitory molecules, 182–183
 ontogeny, 181–182
 receptors, 182–183
 target recognition by, 217–218
 viral infection, malignant transformation, 218
- Nephritis, nephrotoxic, 401–402
 lupus, 327
 nephrotoxic or Masugi, 401–402
 Nephrotoxic nephritis, 401–402
 Neuromuscular systems, autoimmune diseases of, 353–356
 multiple sclerosis, 354–356
 myasthenia gravis, 353–354
- Neutropenia, 603
 autoimmune, 356
 causes of, 356, 603
- Neutrophil count, phagocytic function and, 252
- Newborn, hemolytic disease of, 440–443
 Nezelof syndrome, 588
 NK cells (*see* Natural killer cells)
 Nocturnal hemoglobinuria, paroxysmal, 153–154
 Nonhemolytic immune transfusion reactions, 439–440
 Nonsecretory myeloma, 530, 538
 Nonself discrimination, *vs.* self discrimination, 6–7
 Nonspecific anti-infectious defense
 mechanisms, 259–262
 acute phase reaction, 261–262
 complement system activation, 260–261
 constitutive nonspecific defense mechanisms, 259–260
 inducible nonspecific responses, 260
 leukocyte chemotaxis, 261–262
 natural killer cells, 262
 phagocytosis, 260
 T lymphocytes, 262
- Nonsteroidal anti-inflammatory drugs (NSAIDs), rheumatoid arthritis, 390
 Nuclear factor-kappa B (NF- κ B), 65, 69, 197, 198
 Nuclear factor of activated T cells (NF-AT), 69, 197, 198
 Nucleoside analogs, 619
- OKT3, 507
 Ontogeny
 natural killer cells, 181–182
 study approaches, 163–166
 T lymphocytes, 173–181
- Opiates, immunodeficiency, 606
 Opportunistic infections, with immunosuppression, 510–511
 Opsonins, 100, 129, 264
 Opsonization, antigen-antibody reactions, 128
 Organ-specific autoimmune diseases, 341–360
 Addison's disease, 344–345
 blood cells, autoimmune diseases of, 356–357
 autoimmune neutropenia, 356
 idiopathic thrombocytopenic purpura, 356–357
 chronic active hepatitis, 352–353
 gastrointestinal tract, autoimmune diseases of, 350–353
 liver, autoimmune diseases of, 350–353
 neuromuscular systems, autoimmune diseases of, 353–356
 multiple sclerosis, 354–356
 myasthenia gravis, 353–354
 neutropenia, causes of, 356
 pancreas, autoimmune diseases of, 345–350
 acanthosis nigricans, 350
 diabetes mellitus, 345–349
 development of, pathogenic events leading to, 349
 genetic factors, 347–348
 pathogenesis, 345–347
 immunotherapy, 349–350
 pernicious anemia, 350–351
 primary biliary cirrhosis, 351
 thyroid gland, autoimmune diseases of, 341–344
 Graves' disease, 341–343
 Hashimoto's disease, 342–344
- Ouchterlony technique, precipitation assay, 280
 Overlap syndrome, 362–363

- Oxidative burst, phagocytic function and, 254–255
- PAF (platelet-activating factor), 421, 422, 459–460
- Pancreas, autoimmune diseases of, 345–350
 acanthosis nigricans, 350
 diabetes mellitus, 345–349
 development of, pathogenic events leading to, 349
 genetic factors, 347–348
 pathogenesis, 345–347
 immunotherapy, 349–350
- Pancreatitis, 154
- Paper disk radioimmunosorbent test (PRIST), 414
- Paraproteins (monoclonal proteins), 529–530, 535
- Parasitic infections, immunodeficiency, 606–607
- Paroxysmal nocturnal hemoglobinuria, 153–154
- Passive transfer, mucosal immunity, 233–234
 of anaphylactic reactions, 398–399
- Penicillin-induced hemolytic anemia, 447
- Peptide-carrying proteins, major
 histocompatibility complex, 43–44
- Peptide vaccines, synthetic, 237
- Perforins, 13, 215
- Periarteriolar lymphatic sheath, of spleen, 19
- Peripheral blood cells, receptors on, 151
- Pernicious anemia, 350–351
- Persistent B-cell stimulation, prolonged
 retention of antigen and,
 consequences of, 231
- Peyer's patches, 22, 23, 24
- PGE2 (prostaglandin E2), 387
- Phagocytic cell, 245–278
 activated macrophage, 251–252
 chemotaxis, migration to extravascular compartment, 245–247
 deficiencies, 590–593
 intracellular killing, 249–251
 macrophage
 comparison of polymorphonuclear leukocytes and, 251
 physiology of, 251–252
 monocyte
 comparison of polymorphonuclear leukocytes and, 251
 physiology of, 251–252
- [Phagocytic cell]
 phagocytic function, laboratory evaluation of, 252–256
 adherence, 252
 chemotaxis, migration, 252–253
 degranulation, 254
 ingestion, 253–254
 killing assays, 255–256
 neutrophil count, 252
 oxidative burst, measurement of, 254–255
 phagocytosis, 247–249, 252
 polymorphonuclear leukocytes, physiology of, 245–251
- Phagocytosis, 141–143, 247–249, 260
- PKC (protein kinase C), 65, 196
- Placental transfer, immunoglobulins, 99
- Plasma cell dyscrasias, 529
- Plasma cell leukemia, 540
- Plasma cells
 differentiatin, 8, 11
 immunoglobulin synthesis, 77, 93
 morphology, 12, 13
 submucosal, 94
 switching, 107
 ultrastructure, 94
- Platelet-activating factor (PAF), 421, 422, 459–460
- PMN (*see* Polymorphonuclear leukocytes)
- Pokeweed mitogen (PWM), 302, 303
- Polyimmunoglobulin receptor (poly-IgR), 94–94, 95
- Polymorphonuclear leukocytes
 macrophages, comparison, 251
 monocytes, comparison, 251
 physiology of, 245–251
- Polysaccharides, bacterial, 236
 immunogenicity, 54
- Postinfectious tissue damage, 272–273
 cross-reactions with tissue antigens, 273
 immune complex-induced inflammation, 272–273
 immune destruction, infected cells, 273
- Postsurgery immunodeficiency, 603–604
- Prausnitz-Kustnner reaction, 399
- Precipitation, antigen-antibody reactions, 125–127
- Precipitation assays, 280–286
 counterimmunoelectrophoresis, 280
 double diffusion method, 280
 immunoelectrophoresis, 283
 immunofixation, 283

- [Precipitation assays]
 - immunonephelometry, 282–283
 - quantitative immunoelectrophoresis, 282
 - radial immunodiffusion, 280–282
 - western blot, 283–286
- Pricipitin curve, 125
- Primary biliary cirrhosis, 351
- Primary hypoadrenalism, chronic, 344–345
- Primary immunodeficiency diseases, 573–598
 - cellular immunodeficiencies, 583–585
 - combined immunodeficiencies, 585–590
 - humoral immunodeficiencies, 574–583
 - phagocytic cell deficiencies, 590–593
- Prolonged immunosuppression, adverse
 - consequences of, 485–487
- Prolonged retention of antigen, B-cell
 - stimulation and, consequences of, 231
- Properdin, 148
- Prostaglandin E2 (PGE2), 387, 603
- Prostate-specific antigen (PSA), 520–521
- Proteasome, 66
- Protein kinase C (PKC), 65, 196
- Proteins
 - fractionation, 77
 - immunogenicity, 54
- Proteolytic digestion, immunoglobulin, 78
- Proteolytic enzymes, 149
- Prototype immunoglobulin molecule, 77–80
- Prozone, 127
- P-selectin, 202
- Pulmonary distress syndrome, 154
- Pulmonary vascular leukostasis, hemodialysis and, 154
- Pyrogenic factor, 407–408

- Quantitative immunoelectrophoresis, 282
- Quantitative immunofluorescence assays, 292

- Radial immunodiffusion, 280–282
- Radioallergosorbent test (RAST), 415–416
- Radioimmunoassay, 297–299
- RAG gene products, 110
- RANTES, 204, 267
- Rapamune, 507
- Rapamycin, 507
- Rapid diagnosis tests, 287
- Recombinant bacterial antigens, 236
- Recommended immunizations, 239–240
- Regulatory cells
 - immune response, 218–220
 - nature of, 219
- Reiter's syndrome, 45, 46
- Rejection (*see* Transplantation)
- Renal failure, immunodeficiency, 601–602
- Restriction fragment length polymorphisms (RFLP), immunoglobulins, 112–113
 - genetics, 112–113
- Rh system, 432
 - antigens of, 432
- Rheumatic fever, acute, 331–332
- Rheumatic heart disease, 331
- Rheumatoid arthritis, 377–396
 - anti-immunoglobulin antibodies
 - diagnostic specificity of, 381
 - physiological role of, 381
 - anticollagen antibodies, 383
 - antigen presentation, dendritic cells, 386–387
 - antinuclear antibodies, 383
 - autoantibodies in, 380–383
 - B-cell precursors, RF-producing
 - plasmablasts, phenotype, 382
 - B cells, as local amplifiers of
 - autoimmune response, 387
 - case study, 377–378, 391–392
 - cell-mediated immunity abnormalities in, 385–388
 - genetic factors, 388
 - genetic factors in, 383–385
 - hormonal factors, 388–389
 - human leukocyte antigen
 - associations, 383
 - DR4 subtypes, 383–385
 - initiating factors, 389–390
 - localized disease
 - clinical presentation, 378
 - pathological manifestations of, 378–379
 - pathogenesis, 388–390
 - pathological aspects of, 378–380
 - precipitating factors, 389
 - predisposing factors, 388–389
 - related diseases, 380
 - rheumatoid factor
 - anti-immunoglobulin antibodies, 380–382
 - methods used for detection of, 380
 - pathogenic role, 382
 - self-perpetuating mechanisms, 389
 - seronegative rheumatoid arthritis, 382
 - synovium macrophages, 387–388
 - systemic involvement
 - clinical presentation, 379
 - pathological manifestations, 379

- [Rheumatoid arthritis]
 - T lymphocytes, 385–386
 - therapy, 390–392
 - biological response modifiers, 391
 - disease-modifying drugs, 390
 - glucocorticoids, 390
 - nonsteroidal anti-inflammatory drugs, 390
 - reinduction of tolerance, 391
- Rheumatoid factor
 - anti-immunoglobulin antibodies, 380–382
 - methods used for detection of, 380
 - pathogenic role, 382
- Rh immune globulin, 442
- Scatchard plot, 122–123
- Scleroderma, 383
- Sclerosing panencephalitis (SSPE), 496
- Secondary immunodeficiencies, 600–607
 - burn-associated immunodeficiency, 602–603
 - causes of, 600
 - with drug abuse, 605–606
 - alcohol, 605
 - cannabinoids, 605
 - opiates, 606
 - iatrogenically induced immune deficiencies, 603–605
 - neutropenia, 603
 - causes of, 603
 - postsurgery immunodeficiency, 603–604
 - splenectomy, 604–605
 - thymectomy, 605
 - with infections, 606–607
 - bacterial infections, 606
 - parasitic infections, 606–607
 - viral infections, 607
 - AIDS, 607–626
 - with malnutrition, 600–601
 - with renal failure, 601–602
 - with vitamin deficiencies, 601
 - with zinc deficiency, 601
- Secretory component (SC), 87–88, 94–95
- Sedimentation coefficient, 77
- Selectins
 - E (endothelial-leukocyte adhesion molecule), 26, 202
 - L (leukocyte adhesion molecule-1), 26
 - P, 202
- Selective immunoglobulin A deficiency, 579–581
 - clinical presentation, 580
 - diagnosis, 580
- [Selective immunoglobulin A deficiency]
 - physiopathology, 579–580
 - therapy, 580–581
- Self discrimination, vs. nonself discrimination, 6–7
- Septic shock, C1-INH depletion and, 154
- Seroconversion, HIV, acute illness associated with, 616
- Seronegative rheumatoid arthritis, 382
- Serum immunoglobulin levels, in diagnosis, 557–559
- Serum sickness, 404–405
- Severe, combined immunodeficiency, 585–588
 - clinical presentation, 586
 - diagnosis, 586–587
 - pathogenesis, 585–586
 - therapy, 587–588
- Sézary syndrome, 549
- Sirolimus, 479–482, 507
- Slow-reacting substance of anaphylaxis (SRS-A), 400, 421, 422
- Soluble immune complexes, detection of, 462–465
- Somatic mutations, affinity maturation and, 110
- Specific defenses, overview, 2
- Spleen, 19
- Splenectomy, 604–605
- Stages of immune response, 2–3
- Stem cell differentiation, lymphocyte ontogeny, 161
- Subacute sclerosing panencephalitis, 273
- Superantigens, bacterial, 271–272
- Suppressor T lymphocytes, 323
- Surface staining, 293–296
- Swiss-type agammaglobulinemia, 585–588
- Sympathetic ophthalmia, 332
- Synovium macrophages, rheumatoid arthritis, 387–388
- Synthetic peptide vaccines, 237
- Systemic lupus erythematosus, 334, 361–376
 - case study, 361, 371–372
 - clinical manifestations, 362–363
 - course, 362
 - diagnosis, 362
 - genetic factors, 366–367
 - glomerulonephritis, 369–370
 - immune complexes in, 368–369
 - immune response abnormalities, 367–368
 - B-cell abnormalities, 367
 - T-cell abnormalities, 367–368

- [Systemic lupus erythematosus]
 immunological abnormalities in, 363–366
 autoantibodies, 363–365
 diagnostic value of autoantibodies, 366
 pathogenic role of autoantibodies in SLE, 365
 nonimmune factors influencing course of, 370–371
 environmental factors, 370–371
 hormonal effects, 370
 overlap syndromes, 362–363
 pathogenesis of, 366–372
 treatment, 372–373
- Tacrolimus (Prograf; FK506), 479–482
- T-cell abnormalities, systemic lupus erythematosus, 367–368
- T-cell activation, 193–207
 antigen-derived peptide recognition, by T-cell receptors, 193–194
 CD4+T lymphocytes, 195–200
 central nervous system effects, 203
 chemokines, 200–207
 co-stimulatory signals, 194–195, 200
 cytokines, 200–207, 203–204
 hematopoiesis, 205
 interleukin-1, 203
 interleukin-2
 autocrine, paracrine effects of, 199
 binding, 199–200
 gene expression, 195–199
 receptor, 199
 synthesis, 199–200
 interleukins, 201–202
 pro-inflammatory cytokines, 200–203
 T-lymphocyte proliferation, 199–200
 TcR occupancy, 195–199
 vascular effects, 202–203
- T-cell acute lymphocytic leukemia, 547–548
- T-cell anergy, mechanisms of, 321–322
- T-cell/B-cell, cooperation, immunoglobulin E-mediated hypersensitivity, 417–418
- T-cell-dependent, T-independent antigens, 59–60
- T-cell-independent antigens, characteristics of immune response to, 60
- T-cell leukemia associated with HTLV-1, 548–549
- T-cell receptor
 genes, T-lymphocyte ontogeny, rearrangement of, 173–175
 structure, T-lymphocyte ontogeny, 178–179
- TcR (*see* T-cell receptor)
- T-dependent antigens, in humoral immune response, 210
- T-dependent areas, 17, 18
- Terminal deoxyribonucleotidyl transferase (Tdt)
 in acute lymphocytic leukemias, 547
 flow cytometry detection, 295
- Tetramer assays, 304
- Thalidomide, 512
- T_H2 lymphocytes, interleukins released by, 71
- T_H2 subpopulations, signals involved in control of differentiation of, 72
- Thrombocytopenia, immunodeficiency with, eczema, 590
 clinical presentation, 590
 drug-induced, 447
 genetics and pathogenesis, 590
 in idiopathic thrombocytic purpura, 356
 laboratory findings, 590
 therapy, 590
- Thrombocytopenic purpura, idiopathic, 356–357
- Thymectomy, 605
- Thymic hormones, 495–496
 immunopotential, 495–496
- Thymus aplasia, congenital, 584–585
 clinical presentation, 584
 diagnosis of immunological abnormalities, 584
 etiology and pathogenesis, 584
 therapy, 584–585
- Thyroid gland, autoimmune diseases of, 341–344
 Graves' disease, 341–343
 Hashimoto's disease, 342–344
- Thyroiditis, autoimmune (Hashimoto's thyroiditis), 342, 343–344
- Thyroid receptor antibodies, 342
- Thyroid-stimulating immunoglobulin (TSI), 342
- Thyrotoxicosis (Graves' disease), 341–343
- T-independent antigens, in humoral immune response, 210
- Tissue-fixed antigen-antibody complex detection, 292–293
- Tissues in immune response, 11–30
 adhesion molecules, ligands, 26–27
 B lymphocytes, distribution of, 17
 cells of immune system, macrophages, 14
 lymph nodes, 17–19
 anatomical organization, 17–18
 physiological role, 18–19

- [Tissues in immune response]
 - lymphocyte traffic, 23–28
 - cell adhesion molecules, 25
 - homing, 25–28
 - lymphocyte recirculation, extravascular migration, 23–25
 - regulation of, 25–28
 - lymphocytes, distribution of, 17
 - lymphoid tissues, organs, 16–23
 - mucosal-associated lymphoid tissues, 21–23
 - spleen, 19–20
 - anatomical organization, 19
 - physiological role, 19
 - thymus, 20–21
 - anatomical organization, 20
 - physiological role, 20–21
- T lymphocytes (T cells), 262
 - anergy, models for, 321
 - B-cell cooperation, in antibody responses, 56–59
 - B-lymphocyte differentiation, 166–167
 - coreceptors, 166
 - gene arrangement, 166
 - receptors, selection of, 166–167
 - helper
 - activation of, 62–66
 - antigen presentation to, MHC-II, 41
 - cell subsets, regulatory roles, 208–209
 - humoral immune response, 210–213
 - in inflammatory responses, 209–210
 - major histocompatibility complex,
 - antigen presentation to, major histocompatibility complex–II, 41
 - T_H1, T_H2 subpopulations (subsets),
 - regulatory roles, 208–209
 - T_H1, T_H2 subpopulations, signals
 - involved in control of differentiation of, 72
 - membrane markers, 566
 - mitogens, 567
 - ontogeny, 173–181
 - coreceptors, 175
 - markers, T-cell activation, 180–181
 - inhibition, 181
 - membrane markers, mature T lymphocytes, 179–181
 - pre-T lymphocyte
 - enzymatic activity in, 173
 - markers, 173
 - receptor selection, 175–178
 - negative selection, 175–176
 - positive selection, 176–178
 - T-cell differentiation after birth, 178
- [T lymphocytes (T cells)]
 - TcR genes, rearrangement of, 173–175
 - TcR structure, 178–179
 - rheumatoid arthritis, 385–386
 - tolerance models, 320–322
 - clonal deletion
 - experimental models, 320–322
 - mechanisms of, 321
 - T-cell anergy, mechanisms of, 321–322
- Tolerance
 - acquired, 315–317
 - autoimmune diseases, treatment, 334–336
 - autoimmunity, 325–334
 - B-cell anergy
 - models for, 318–319
 - reversibility of, 319
 - B-lymphocyte clonal deletion, models for, 319
 - characteristics of, 314–315
 - defined, 314–315
 - downregulation of immune response, 322–324
 - mechanisms of, 318
 - experimental approaches, 318
 - models, 318–320
 - reinduction of, rheumatoid arthritis, 391
 - termination of, 324–325
 - transgenic mice, 318
- Tolerogenic conditions, 315–317
- Tonsils, 22
- Total lymphoid irradiation, 508
- Transfusion
 - effect, 509–510
 - nonhemolytic immune reactions, 439–440
 - reactions, 437–440
 - serological principles of, 434–437
- Transforming growth factor- β (TGF- β), 219–220
- Transgenic mice models
 - B-lymphocyte tolerance, 317
 - T-lymphocyte tolerance, 320–322
- Transient hypogammaglobulinemia of infancy, 574–576
- Transplantation
 - immunology, 501–516
 - donor-recipient matching, 502–503
 - graft rejection, 503–506
 - acute rejection, 504–505
 - case study, 505–506
 - delayed or chronic rejection, 505
 - hyperacute (early) rejection, 503–504
 - graft-*versus*-host reaction, 511–513
 - case study, 513

- [Transplantation]
 - pathogenesis, 512
 - pathology, 512
 - prevention, 512–513
 - treatment, 512
- immunosuppression, 506–511
 - biological response modifiers, 507–508
 - anti-T-cell monoclonal antibodies, 507–508
 - antihymocyte, antilymphocyte globulins, 507
 - other monoclonal antibodies, 508
 - chemical, 506–507
 - antimetabolites, 506
 - calcineurin inhibitors, 506–507
 - glucocorticoids, 506
 - rapamycin, 507
 - side effects, 510–511
 - malignancies, 511
 - opportunistic infections, 510–511
 - total lymphoid irradiation, 508
 - transfusion effect, 509–510
 - rejection
 - antigens, 518–519
 - overview, 6
- Tuberculin test, 405
- Tumor immunology, 517–528
 - cancer immunity, effector mechanisms, 521–522
 - immunogenicity of tumors, 518–521
 - immunotherapy, 524–525
 - rejection antigens, 518–519
 - tumor-associated antigens, 519–521
- Tumor necrosis factor, 200–201, 202, 490, 611
- Type I hypersensitivity reactions, 398–400
 - clinical expression, 399
 - historical overview, 398–399
 - pathogenesis, 400
- Type II hypersensitivity (*see* Cytotoxic reactions)
- Type III hypersensitivity (*see* Immune complex-induced hypersensitivity reactions)
- Type IV hypersensitivity reactions (*see* Delayed hypersensitivity reactions)
- Urticaria, 399
- Uveitis, acute anterior, 46
- V-region allotype, heavy-chain, immunoglobulin molecules, 112
- Vaccines
 - attenuated, 238–239
 - recombinant organisms, 238–239
 - types of, 235–238
 - component vaccines, 236–238
 - bacterial polysaccharides, 236
 - conjugate vaccines, 236–237
 - DNA vaccines, 237–238
 - inactivated toxins, 236
 - mixed component vaccines, 236
 - recombinant bacterial antigens, 236
 - synthetic peptide vaccines, 237
 - viral component vaccines, 237
 - killed vaccines, 236
- Vascular leukostasis, pulmonary, hemodialysis and, 154
- VCAMs (vascular intercellular adhesion molecules), 26, 28, 460
- VDJ segment, 106–108
- Viral component vaccines, 237
- Viral infection (*see also under* specific infection)
 - immunodeficiency, 607
 - AIDS, 607–626
 - natural killer cells, malignant transformation, 218
- Vitamin deficiencies, 601
- V-region genes, 109
- Waldenstrom's macroglobulinemia, 541–542
 - clinical features, 541
 - diagnosis, 541
 - management, 541–542
- Western blot, 283–286
- Wiskott-Aldrich syndrome, 590
 - clinical presentation, 590
 - genetics and pathogenesis, 590
 - laboratory findings, 590
 - therapy, 590
- X-linked hyper-immunoglobulin M syndrome, 581–582
 - clinical presentation, 581
 - diagnosis, 581
 - genetics and physiopathology, 581
 - therapy, 582
- Yersinia pseudotuberculosis*, 46
- ZAP70 kinase, 196, 586
- Zidovudine, 623
- Zinc deficiency, 601