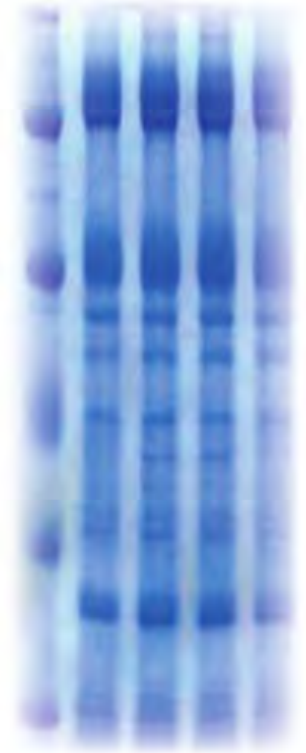
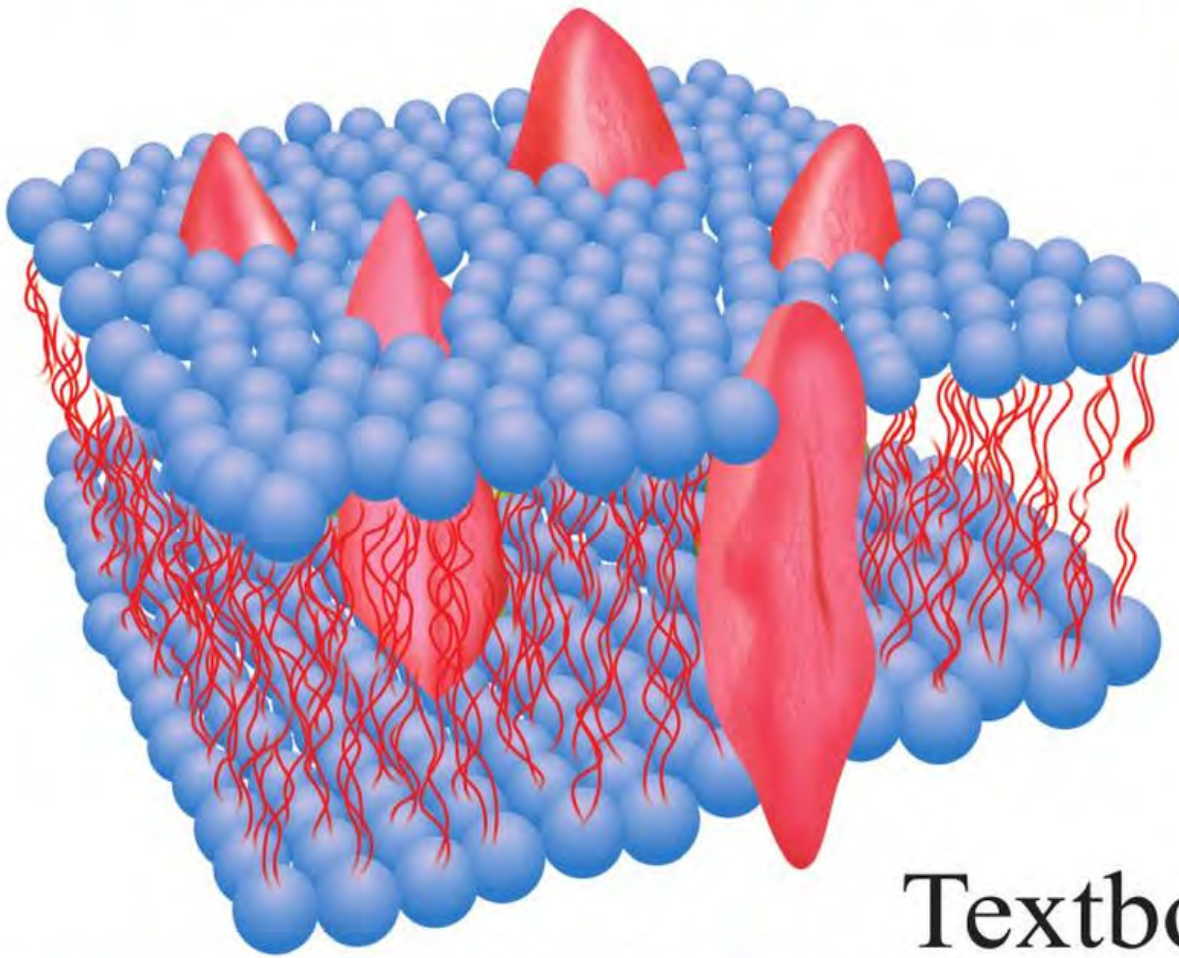


**Free online access to**

Additional Clinical Cases, Key Concepts & Image Bank



Textbook of  
**BIOCHEMISTRY**  
*for Medical Students*

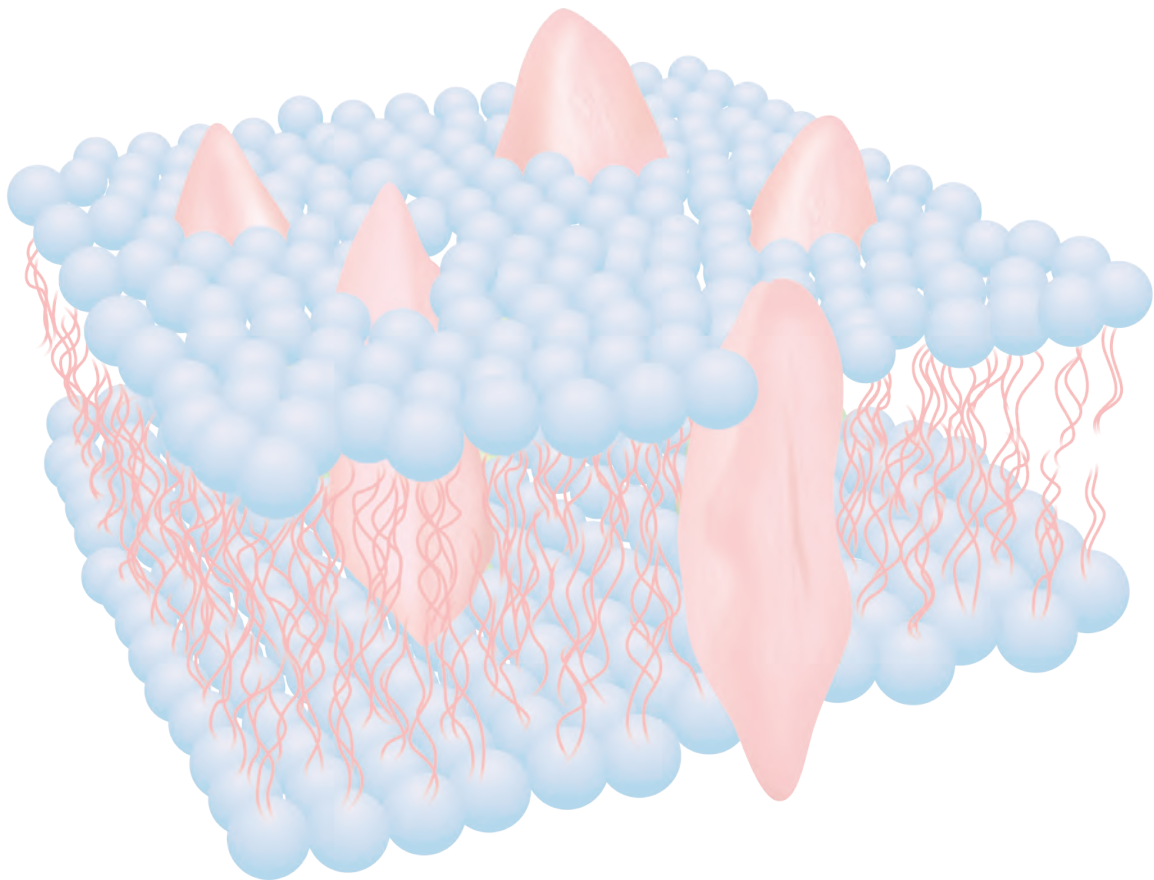
**S E V E N T H   E D I T I O N**

**DM Vasudevan**  
**Sreekumari S • Kannan Vaidyanathan**

**JAYPEE**

**With Free!**  
**Revision Exercises Booklet**

Textbook of  
**BIOCHEMISTRY**





# Textbook of **BIOCHEMISTRY** *for Medical Students* (Seventh Edition)

Free online access to

Additional Clinical Cases, Key Concepts & Image Bank

**DM Vasudevan** MBBS MD FAMS FRCPath

Distinguished Professor  
Department of Biochemistry  
College of Medicine, Amrita Institute of Medical Sciences  
Kochi, Kerala, India

*Formerly*

Principal, College of Medicine  
Amrita Institute of Medical Sciences, Kerala, India  
Dean, Sikkim Manipal Institute of Medical Sciences  
Gangtok, Sikkim, India

**Sreekumari S** MBBS MD

Professor and Head  
Department of Biochemistry  
Sree Gokulam Medical College and Research Foundation  
Thiruvananthapuram, Kerala, India

**Kannan Vaidyanathan** MBBS MD

Professor and Head  
Department of Biochemistry  
Pushpagiri Institute of Medical Sciences and Research Center  
Thiruvalla, Kerala, India



**JAYPEE BROTHERS MEDICAL PUBLISHERS (P) LTD**

New Delhi • London • Philadelphia • Panama





## Jaypee Brothers Medical Publishers (P) Ltd

### Headquarters

Jaypee Brothers Medical Publishers (P) Ltd  
4838/24, Ansari Road, Daryaganj  
New Delhi 110 002, India  
Phone: +91-11-43574357  
Fax: +91-11-43574314  
Email: [jaypee@jaypeebrothers.com](mailto:jaypee@jaypeebrothers.com)

### Overseas Offices

J.P. Medical Ltd  
83, Victoria Street, London  
SW1H 0HW (UK)  
Phone: +44-2031708910  
Fax: +02-03-0086180  
Email: [info@jpmedpub.com](mailto:info@jpmedpub.com)

Jaypee-Highlights Medical Publishers Inc  
City of Knowledge, Bld. 237, Clayton  
Panama City, Panama  
Phone: +507-301-0496  
Fax: +507-301-0499  
Email: [cservice@jphmedical.com](mailto:cservice@jphmedical.com)

Jaypee Medical Inc  
The Bourse  
111 South Independence Mall East  
Suite 835, Philadelphia, PA 19106, USA  
Phone: + 267-519-9789  
Email: [joe.rusko@jaypeebrothers.com](mailto:joe.rusko@jaypeebrothers.com)

Jaypee Brothers Medical Publishers (P) Ltd  
17/1-B Babar Road, Block-B, Shaymali  
Mohammadpur, Dhaka-1207  
Bangladesh  
Mobile: +08801912003485  
Email: [jaypeedhaka@gmail.com](mailto:jaypeedhaka@gmail.com)

Jaypee Brothers Medical Publishers (P) Ltd  
Shorakhute, Kathmandu  
Nepal  
Phone: +00977-9841528578  
Email: [jaypee.nepal@gmail.com](mailto:jaypee.nepal@gmail.com)

Website: [www.jaypeebrothers.com](http://www.jaypeebrothers.com)  
Website: [www.jaypeedigital.com](http://www.jaypeedigital.com)

© 2013, DM Vasudevan, Sreekumari S, Kannan Vaidyanathan

All rights reserved. No part of this book may be reproduced in any form or by any means without the prior permission of the publisher.

**Inquiries for bulk sales may be solicited at:** [jaypee@jaypeebrothers.com](mailto:jaypee@jaypeebrothers.com)

This book has been published in good faith that the contents provided by the authors contained herein are original, and is intended for educational purposes only. While every effort is made to ensure accuracy of information, the publisher and the authors specifically disclaim any damage, liability, or loss incurred, directly or indirectly, from the use or application of any of the contents of this work. If not specifically stated, all figures and tables are courtesy of the authors. Where appropriate, the readers should consult with a specialist or contact the manufacturer of the drug or device.

### **Textbook of Biochemistry for Medical Students**

*First Edition:* 1995  
*Second Edition:* 1998  
*Third Edition:* 2001  
*Fourth Edition:* 2004  
*Fifth Edition:* 2007  
*Sixth Edition:* 2010  
*Seventh Edition:* **2013**

ISBN 978-93-5090-530-2

Printed at

## **Dedicated to**

*With humility and reverence,  
this book is dedicated  
at the lotus feet of the Holy Mother,  
Sri Mata Amritanandamayi Devi*

*"Today's world needs people who express goodness in their words and deeds. If such noble role models set the example for their fellow beings, the darkness prevailing in today's society will be dispelled, and the light of peace and non-violence will once again illumine this earth. Let us work together towards this goal".*

**—Mata Amritanandamayi Devi**



# Preface to the Seventh Edition

---

We are glad to present the Seventh edition of the *Textbook of Biochemistry for Medical Students*. Now, this textbook is entering the 19th year of existence. With humility, we may state that the medical community of India has warmly received the previous editions of this book. The Medical Council of India has accepted it as one of the standard textbooks. We are happy to note that this book has also reached in the hands of medical students of neighboring countries of Nepal, Pakistan, Bangladesh, Sri Lanka, etc. and also to distant countries in Africa and Europe. We are very proud to report that the Textbook has a Spanish edition, with wide circulation in the Central and South America. Apart from the medical community, this book has also become popular to other biological group of students in India. In retrospect, it gives immense satisfaction to note that this book served the students and faculty for the past two decades.

We are bringing out the new edition of the textbook every 3 years. A major addition of this edition is the incorporation of clinical case studies in almost all chapters. We hope that this feature will help the students to identify the clinical relevance of the biochemistry. Further, chapters on clinical chemistry have been extensively updated and clinically relevant points were further added. Rapid progress has been made in the area of molecular biology during past few years, and these advances are to be reflected in this book also. The major change in this Seventh edition is that advanced knowledge has been added in almost all chapters, clinical case studies have been added in relevant chapters; and a few new chapters were added. The print fonts and font size have also been changed for better readability.

From the First edition onwards, our policy was to provide not only basic essentials but also some of the advanced knowledge. About 30% contents of the previous editions were not required for a student aiming for a minimum pass. A lot of students have appreciated this approach, as it helped them to pass the postgraduate (PG) entrance examinations at a later stage. However, this asset has paved the way for a general criticism that the extra details are a burden to the average students. Especially, when read for the first time, the student may find it difficult to sort out the essential minimum from the desirable bulk. In this Seventh edition, advanced topics are given in small prints. In essence, this book is composed of three complementary books. The bold printed areas will be useful for the student at the time of revision just before the examinations; regular printed pages are meant for an average first year MBBS student and the fine printed paragraphs are targeted to the advanced students preparing for the PG entrance.

Essay questions, short notes, multiple choice questions and viva voce type questions are given as a separate book, but free of cost. These questions are compiled from the question papers of various universities during the last decade. These questions will be ideal for students for last-minute preparation for examinations. We are introducing the online study material, which provides concepts of major topic as well as clinical case studies. This shall be updated through the year. Hence, students are advised to check the web page at regular intervals.

A textbook will be matured only by successive revisions. In the preface for the First edition, we expressed our desire to revise the textbook every 3 years. We were fortunate to keep that promise. This book has undergone metamorphosis during each edition. Chemical structures with computer technology were introduced in the Second edition. Color printing has been launched in the Third edition. The Fourth edition came out with multicolor printing. In the Fifth edition, the facts were presented in small paragraphs, so as to aid memory. In the Sixth edition, figures were drastically increased. In this Seventh edition, about 100 case studies are added. In this book, there are about



1100 figures, 230 tables and 200 boxes (perhaps we could call it as illustrated textbook of biochemistry), altogether making the book more student-friendly. The quality of paper is also improved during successive editions.

We were pleasantly surprised to receive many letters giving constructive criticisms and positive suggestions to improve the textbook. These responses were from all parts of the country (we got a few such letters from African and European students also). Such contributors include Heads of Departments, very senior professors, middle level teachers and mostly postgraduate students. We have tried to incorporate most of those suggestions, within the constraints of page limitations. In a way, this book thus became multi-authored, and truly national in character. This is to place on record, our deep gratitude for all those “pen-friends” who have helped us to improve this book. The first author desires more interaction with faculty and students who are using this textbook. All are welcome to communicate at his e-mail address <[dmvasudevan@yahoo.co.in](mailto:dmvasudevan@yahoo.co.in)>

As indicated in the last edition, the first author is in the process of retirement, and would like to reduce the burden in due course. A successful textbook is something like a growing institution; individuals may come and go, but the institution will march ahead. Therefore, we felt the need to induce younger blood into the editorial board. Thus, a third author has been added in the Sixth edition, so that the torch can be handed over smoothly at an appropriate time later on. In this Seventh edition, the first author has taken less responsibility in editing the book, while the third author has taken more effort.

The help and assistance rendered by our postgraduate students in preparing this book are enormous. The official website of Nobel Academy has been used for pictures and biographies of Nobel laureates. Web pictures, without copyright protection, were also used in some figures. The remarkable success of the book was due to the active support of the publishers. This is to record our appreciation for the cooperation extended by Shri Jitendar P Vij (Group Chairman), Mr Ankit Vij (Managing Director) and Mr Tarun Duneja (Director-Publishing) of M/s Jaypee Brothers Medical Publishers (P) Ltd, New Delhi, India.

We hope that this Seventh edition will be friendlier to the students and be more attractive to the teachers. Now this is in your hands to judge.

*“End of all knowledge must be building up of character”*

—**Mahatma Gandhi**

**DM Vasudevan  
Sreekumari S  
Kannan Vaidyanathan**

# Preface to the First Edition

---

There are many textbooks of biochemistry written by Western and Indian authors. Then what is the need for yet another textbook? Putting this question to ourselves, we have waited for many years before embarking on this project. Most Western textbooks do not emphasize nutrition and such other topics, which are very vital to an Indian student. While Indian authors do cover these portions, they sometimes neglect the expanding fields, such as molecular biology and immunochemistry. Thus, during our experience of more than 25 years in teaching, the students have been seen compelled to depend on different textbooks during their study of biochemistry. We have tried to keep a balance between the basic essentials and the advanced knowledge.

This book is mainly based on the MBBS curriculum. However, some advanced portions have also been given in almost all chapters. These areas will be very beneficial to the readers preparing for their postgraduate entrance examinations.

Chapters on diabetes, cancer and AIDS are included in this book. During their clinical years, the students are going to see such cases quite more often, hence knowledge of applied biochemistry of these diseases will be very helpful. The authors, themselves medical graduates, have tried to emphasize medical applications of the theoretical knowledge in biochemistry in almost all the chapters.

A few questions have been given at the end of most of the chapters. These are not comprehensive to cover all the topics, but have been included only to give emphasis to certain points, which may otherwise be left unnoticed by some students.

We are indebted to many persons in compiling this textbook. We are highly obliged to Dr ANP Ummerkutty, Vice-Chancellor, University of Calicut, for his kind gesture of providing an introduction. Dr M Krishnan Nair, Research Director, Veterinary College, Trichur, has provided his unpublished electron micrographs for this book. Dr MV Muraleedharan, Professor of Medicine, and Dr TS Hariharan, Professor of Pharmacology, Medical College, Thrissur, have gone through the contents of this book. Their valuable suggestions on the applied aspects of biochemistry have been incorporated. Two of our respected teachers in biochemistry, Professor R Raghunandana Rao and Professor GYN Iyer (both retired) have encouraged this venture. Professor PNK Menon, Dr S Gopinathan Nair, Assistant Professor, Dr Shyam Sundar, Dr PS Vasudevan and Mr K Ramesh Kumar, postgraduate students of this department, have helped in collecting the literature and compiling the materials. Mr Joby Abraham, student of this college has contributed the sketch for some of the figures. Professor CPK Tharakan, retired professor of English, has taken great pains to go through the entire text and correct the usage of English. The secretarial work has been excellently performed by Mrs Lizy Joseph. Many of our innumerable graduate and postgraduate students have indirectly contributed by compelling us to read more widely and thoroughly.

Our expectation is to bring out the new edition every 3 years. Suggestions to improve the contents are welcome from the teachers.

*"A lamp that does not glow itself cannot light another lamp"*

—**Rabindranath Tagore**

**DM Vasudevan  
Sreekumari S**



## SECTION A: Chemical Basis of Life

- 1. Biochemical Perspective to Medicine** 3  
*Biomolecules 4; Study of metabolic processes 5; Stabilizing forces in molecules 5; Water: the universal solvent 6; Principles of thermodynamics 7; Donnan membrane equilibrium 8*
- 2. Subcellular Organelles and Cell Membranes** 10  
*Subcellular organelles 10; Nucleus 10; Endoplasmic reticulum 11; Golgi apparatus 12; Lysosomes 12; Peroxisomes 13; Mitochondria 13; Plasma membrane 14; Specialized membrane structures 16; Transport mechanisms 17*
- 3. Amino Acids: Structure and Properties** 24  
*Classification of amino acids 24; Properties of amino acids 27; General reactions of amino acids 29; Peptide bond formation 31*
- 4. Proteins: Structure and Function** 33  
*Structure of proteins 34; Study of protein structure 39; Physical properties of proteins 41; Precipitation reactions of proteins 41; Classification of proteins 42; Quantitative estimation 44*
- 5. Enzymology: General Concepts and Enzyme Kinetics** 47  
*Classification of enzymes 48; Co-enzymes 49; Mode of action of enzymes 51; Michaelis-Menten theory 53; Fischer's template theory 53; Koshland's induced fit theory 53; Active site or active center of enzyme 54; Thermodynamic considerations 54; Enzyme kinetics 55; Factors influencing enzyme activity 56; Specificity of enzymes 65; Iso-enzymes 66*
- 6. Chemistry of Carbohydrates** 69  
*Nomenclature 69; Stereoisomers 70; Reactions of monosaccharides 73; Disaccharides 76; Polysaccharides 78; Heteroglycans 79; Mucopolysaccharides 80; Glycoproteins and mucoproteins 81*
- 7. Chemistry of Lipids** 83  
*Classification of lipids 83; Fatty acids 84; Saturated fatty acids 85; Unsaturated fatty acids 85; Trans fatty acids 86; Neutral fats 87; Phospholipids 89*

## SECTION B: General Metabolism

- 8. Overview of Metabolism** 97  
*Experimental study of metabolism 97; Metabolism 98; Metabolic profile of organs 99*
- 9. Major Metabolic Pathways of Glucose** 105  
*Digestion of carbohydrates 105; Absorption of carbohydrates 106; Glucose metabolism 107; Glycolysis 108; Metabolic fate of pyruvate 115; Gluconeogenesis 117*
- 10. Other Metabolic Pathways of Glucose** 123  
*Glycogen metabolism 123; Degradation of glycogen (glycogenolysis) 124; Glycogen synthesis (glycogenesis) 125; Glycogen storage diseases 128; Hexose monophosphate shunt pathway 129; Oxidative phase 130; Non-oxidative phase 130; Glucuronic acid pathway of glucose 134; Polyol pathway of glucose 135*



<b>11. Metabolic Pathways of Other Carbohydrates</b>	<b>137</b>
<i>Fructose metabolism 137; Galactose metabolism 138; Metabolism of alcohol 140; Metabolism of amino sugars 142; Glycoproteins 142</i>	
<b>12. Metabolism of Fatty Acids</b>	<b>147</b>
<i>Digestion of lipids 147; Absorption of lipids 148; Beta oxidation of fatty acids 151; Oxidation of odd chain fatty acids 154; Alpha oxidation 155; Omega oxidation 155; De novo synthesis of fatty acids 156; Synthesis of triacylglycerols 160; Metabolism of adipose tissue 161; Fatty liver and lipotropic factors 162; Metabolism of ketone bodies 163; Ketosis 164</i>	
<b>13. Cholesterol and Lipoproteins</b>	<b>169</b>
<i>Biosynthesis of cholesterol 170; Plasma lipids 173; Chylomicrons 175; Very low density lipoproteins 176; Low density lipoproteins 177; High density lipoprotein 179; Free fatty acid 181; Formation of bile acids 182</i>	
<b>14. MCFA, PUFA, Prostaglandins and Compound Lipids</b>	<b>184</b>
<i>Monounsaturated fatty acids 185; Polyunsaturated fatty acids 186; Eicosanoids 188; Prostaglandins 188; Synthesis of compound lipids 191</i>	
<b>15. General Amino Acid Metabolism (Urea Cycle, One Carbon Metabolism)</b>	<b>196</b>
<i>Digestion of proteins 196; Formation of ammonia 200; Disposal/detoxification of ammonia 203; Urea cycle 203; One-carbon metabolism 207</i>	
<b>16. Simple, Hydroxy and Sulfur-containing Amino Acids (Glycine, Serine, Methionine, Cysteine)</b>	<b>210</b>
<i>Glycine 210; Creatine and creatine phosphate 211; Serine 213; Alanine 215; Threonine 215; Methionine 216; Cysteine 217; Cystinuria 219; Homocystinurias 220</i>	
<b>17. Acidic, Basic and Branched Chain Amino Acids (Glutamic Acid, Aspartic Acid, Glutamine, Asparagine, Lysine, Arginine, Nitric Oxide, Valine, Leucine, Isoleucine)</b>	<b>223</b>
<i>Glutamic acid 223; Glutamine 224; Glutamate transporters 225; Aspartic acid 226; Asparagine 226; Arginine 226; Nitric oxide 227; Polyamines 229; Branched chain amino acids 230</i>	
<b>18. Aromatic Amino Acids (Phenylalanine, Tyrosine, Tryptophan, Histidine, Proline) and Amino Acidurias</b>	<b>232</b>
<i>Phenylalanine 232; Tyrosine 233; Phenylketonuria 236; Alkaptonuria 237; Albinism 238; Hypertyrosinemias 239; Tryptophan 239; Histidine 243; Proline and hydroxyproline 244; Aminoacidurias 245</i>	
<b>19. Citric Acid Cycle</b>	<b>247</b>
<i>Regulation of citric acid cycle 253</i>	
<b>20. Biological Oxidation and Electron Transport Chain</b>	<b>255</b>
<i>Redox potentials 256; Biological oxidation 256; Enzymes and co-enzymes 257; High energy compounds 258; Organization of electron transport chain 260; Chemiosmotic theory 263</i>	
<b>21. Heme Synthesis and Breakdown</b>	<b>270</b>
<i>Structure of heme 270; Biosynthesis of heme 271; Catabolism of heme 276; Hyperbilirubinemias 279</i>	
<b>22. Hemoglobin (Structure, Oxygen and Carbon Dioxide Transport, Abnormal Hemoglobins)</b>	<b>283</b>
<i>Structure of hemoglobin 283; Transport of oxygen by hemoglobin 284; Transport of carbon dioxide 287; Hemoglobin derivatives 289; Hemoglobin (globin chain) variants 290; Thalassemias 293; Myoglobin 294; Anemias 295; Hemolytic anemia 295</i>	

## SECTION C: Clinical and Applied Biochemistry

<b>23. Clinical Enzymology and Biomarkers</b>	<b>301</b>
<i>Clinical enzymology 301; Creatine kinase 302; Cardiac troponins 303; Lactate dehydrogenase 303; Alanine amino transferase 305; Aspartate amino transferase 305; Alkaline phosphatase 305; Prostate specific antigen 306; Glucose-6-phosphate dehydrogenase 307; Amylase 307; Lipase 308; Enolase 308</i>	
<b>24. Regulation of Blood Glucose; Insulin and Diabetes Mellitus</b>	<b>311</b>
<i>Regulation of blood glucose 311; Reducing substances in urine 316; Hyperglycemic hormones 322; Glucagon 322; Diabetes mellitus 323; Acute metabolic complications 326</i>	

<b>25. Hyperlipidemias and Cardiovascular Diseases</b>	<b>334</b>
<i>Atherosclerosis 334; Plasma lipid profile 336; Risk factors for atherosclerosis 336; Prevention of atherosclerosis 339; Hypolipoproteinemias 341; Hyperlipidemias 342</i>	
<b>26. Liver and Gastric Function Tests</b>	<b>346</b>
<i>Functions of liver 346; Clinical manifestations of liver dysfunction 348; Studies on malabsorption 359</i>	
<b>27. Kidney Function Tests</b>	<b>361</b>
<i>Renal function tests 361; Abnormal constituents of urine 364; Markers of glomerular filtration rate 366; Markers of glomerular permeability 371; Tests for tubular function 373</i>	
<b>28. Plasma Proteins</b>	<b>378</b>
<i>Electrophoresis 378; Albumin 380; Transport proteins 382; Acute phase proteins 383; Clotting factors 385; Abnormalities in coagulation 386</i>	
<b>29. Acid-Base Balance and pH</b>	<b>390</b>
<i>Acids and bases 390; Buffers 392; Acid-base balance 393; Buffers of the body fluids 393; Respiratory regulation of pH 395; Renal regulation of pH 395; Cellular buffers 397; Disturbances in acid-base balance 397</i>	
<b>30. Electrolyte and Water Balance</b>	<b>407</b>
<i>Intake and output of water 407; Osmolality of extracellular fluid 408; Sodium 411; Potassium 413; Chloride 416</i>	
<b>31. Body Fluids (Milk, CSF, Amniotic Fluid, Ascitic Fluid)</b>	<b>420</b>
<i>Milk 420; Cerebrospinal fluid 421; Amniotic fluid 422; Ascitic fluid 423</i>	
<b>32. Metabolic Diseases</b>	<b>424</b>
<i>Prenatal diagnosis 424; Newborn screening 427; Laboratory investigations to diagnose metabolic disorders 427</i>	
<b>33. Free Radicals and Antioxidants</b>	<b>433</b>
<i>Clinical significance 436</i>	
<b>34. Clinical Laboratory; Quality Control</b>	<b>439</b>
<i>Reference values 439; Preanalytical variables 440; Specimen collection 441; Quality control 443</i>	
<b>35. General Techniques for Separation, Purification and Quantitation</b>	<b>446</b>
<i>Electrophoresis 446; Chromatography 448; Radioimmunoassay 452; ELISA test 453; Colorimeter 455; Autoanalyzer 457; Mass spectrometry 458</i>	

## SECTION D: Nutrition

<b>36. Fat Soluble Vitamins (A, D, E, K)</b>	<b>463</b>
<i>Vitamin A 464; Vitamin D (cholecalciferol) 469; Vitamin E 473; Vitamin K 474</i>	
<b>37. Water Soluble Vitamins - 1 (Thiamine, Riboflavin, Niacin, Pyridoxine, Pantothenic Acid, Biotin)</b>	<b>477</b>
<i>Thiamine (vitamin B<sub>1</sub>) 477; Riboflavin (vitamin B<sub>2</sub>) 479; Niacin 480; Vitamin B<sub>6</sub> 482; Pantothenic acid 484; Biotin 485</i>	
<b>38. Water Soluble Vitamins - 2 (Folic Acid, Vitamin B<sub>12</sub> and Ascorbic Acid)</b>	<b>488</b>
<i>Folic acid 488; Vitamin B<sub>12</sub> 491; Choline 494; Inositol 495; Ascorbic acid (vitamin C) 495; Rutin 499; Flavonoids 499</i>	
<b>39. Mineral Metabolism and Abnormalities</b>	<b>502</b>
<i>Calcium 502; Phosphorus 511; Magnesium 512; Sulfur 513; Iron 514; Copper 520; Iodine 521; Zinc 522; Fluoride 522; Selenium 522; Manganese 523; Molybdenum 523; Cobalt 523; Nickel 523; Chromium 523; Lithium 524</i>	

40. **Energy Metabolism and Nutrition** 527  
*Importance of carbohydrates 530; Nutritional importance of lipids 531; Importance of proteins 532; Protein-energy malnutrition 534; Obesity 536; Prescription of diet 538*
41. **Detoxification and Biotransformation of Xenobiotics** 544  
*Phase one reactions 545; Phase two reactions; conjugations 546; Phase three reactions 548*
42. **Environmental Pollution and Heavy Metal Poisons** 550  
*Corrosives 550; Irritants 551; Heavy metal poisons 551; Pesticides and insecticides 553; Occupational and industrial hazards 553; Air pollutants 553*

## SECTION E: Molecular Biology

43. **Nucleotides: Chemistry and Metabolism** 559  
*Biosynthesis of purine nucleotides 563; Uric acid 566; Gout 566; De novo synthesis of pyrimidine 569*
44. **Deoxyribonucleic Acid: Structure and Replication** 574  
*Structure of DNA 574; Replication of DNA 578; DNA repair mechanisms 582*
45. **Transcription** 587  
*Ribonucleic acid 587; Transcription process 589*
46. **Genetic Code and Translation** 596  
*Protein biosynthesis 596; Translation process 599*
47. **Control of Gene Expression** 608  
*Mutations 612; Classification of mutations 612; Cell cycle 614; Regulation of gene expression 616; Viruses 620*
48. **Recombinant DNA Technology and Gene Therapy** 624  
*Recombinant DNA technology 624; Vectors 626; Gene therapy 629; Stem cells 631*
49. **Molecular Diagnostics and Genetic Techniques** 633  
*Hybridization and blot techniques 633; Polymerase chain reaction 638; Mutation detection techniques 641*

## SECTION F: Hormones

50. **Mechanisms of Action of Hormones and Signaling Molecules** 649
51. **Hypothalamic and Pituitary Hormones** 659  
*Hypothalamic neuropeptides 659; Hormones of anterior pituitary 660*
52. **Steroid Hormones** 664  
*Adrenal cortical hormones 664; Sex hormones 669*
53. **Thyroid Hormones** 672
54. **Gut Hormones** 678

## SECTION G: Advanced Biochemistry

55. **Immunochemistry** 685  
*Structure of immunoglobulins 687; Paraproteinemias 690; Complement system 691; Immunodeficiency states 692*

<b>56. Biochemistry of AIDS and HIV</b>	<b>699</b>
<i>The human immunodeficiency virus 701; Anti-HIV drugs 703</i>	
<b>57. Biochemistry of Cancer</b>	<b>705</b>
<i>Oncogenic viruses 707; Oncogenes 709; Tumor markers 713; Anticancer drugs 716</i>	
<b>58. Tissue Proteins in Health and Disease</b>	<b>720</b>
<i>Collagen 720; Elastin 723; Muscle proteins 724; Lens proteins 727; Prions 727; Biochemistry of aging 730</i>	
<b>59. Applications of Isotopes in Medicine</b>	<b>732</b>
<i>Isotopes 733; Radioactivity 733; Biological effects of radiation 738</i>	
<b>60. Signal Molecules and Growth Factors</b>	<b>740</b>
<b>Appendices</b>	<b>747</b>
<b>Index</b>	<b>763</b>





# SECTION A

---

## Chemical Basis of Life

- Chapter 1 Biochemical Perspective to Medicine
- Chapter 2 Subcellular Organelles and Cell Membranes
- Chapter 3 Amino Acids: Structure and Properties
- Chapter 4 Proteins: Structure and Function
- Chapter 5 Enzymology: General Concepts and Enzyme Kinetics
- Chapter 6 Chemistry of Carbohydrates
- Chapter 7 Chemistry of Lipids



# CHAPTER 1

## Biochemical Perspective to Medicine

### Chapter at a Glance

The reader will be able to answer questions on the following topics:

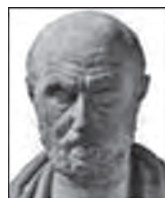
- History of biochemistry
- Ionic bonds
- Hydrogen bonding
- Hydrophobic interactions
- Principles of thermodynamics
- Donnan membrane equilibrium

Biochemistry is the language of biology. The tools for research in all the branches of medical science are mainly biochemical in nature. The study of biochemistry is essential to understand basic functions of the body. This study will give information regarding the functioning of cells at the molecular level. How the food that we eat is digested, absorbed, and used to make ingredients of the body? How does the body derive energy for the normal day to day work? How are the various metabolic processes interrelated? What is the function of genes? What is the molecular basis for immunological resistance against invading organisms? Answer for such basic questions can only be derived by a systematic study of biochemistry.

Modern day medical practice is highly dependent on the laboratory analysis of body fluids, especially the blood. The disease manifestations are reflected in the composition of blood and other tissues. Hence, the demarcation of abnormal from normal constituents of the body is another aim of the study of biochemistry.

The word chemistry is derived from the Greek word "chemi" (the black land), the ancient name of Egypt. Indian medical science, even from ancient times, had identified the metabolic and genetic basis of diseases. Charaka, the great master of Indian Medicine, in his treatise (circa 400 BC) observed that *madhumeha* (diabetes mellitus) is produced by the alterations in the metabolism of carbohydrates and fats; the statement still holds good.

Biochemistry has developed as an offshoot of organic chemistry, and this branch was often referred as "physiological chemistry". The term "Biochemistry" was coined by Neuberg in 1903 from Greek words, bios (= life) and chymos (= juice). One of the earliest treatises in biochemistry was the "Book of Organic Chemistry and its Applications to Physiology and Pathology", published in 1842 by Justus von Liebig



Hippocrates  
460–377 BC



Charaka  
400 BC



Sushruta  
500 BC



(1803–73), who introduced the concept of metabolism. The "Textbook of Physiological Chemistry" was published in 1877 by Felix Hoppe-Seyler (1825–95), who was Professor of Physiological chemistry at Strausbourg University, France. Some of the milestones in the development of the science of biochemistry are given in Table 1.1.

The practice of medicine is both an art and a science. The word "doctor" is derived from the Latin root, "docere", which means "to teach". Knowledge devoid of ethical background may sometimes be disastrous! Hippocrates (460 BC to 377 BC), the father of modern medicine articulated "the Oath". About one century earlier, Sushruta (?500 BC), the great Indian surgeon, enunciated a code of conduct for the medical practitioners, which is still valid. He proclaims: "You must speak only truth; care for the good of all living beings; devote yourself to the healing of the sick even if your life be lost by your work; be simply clothed and drink no intoxicant; always seek to grow in knowledge; in face of God, you can take upon yourself these vows."

Biochemistry is perhaps the most rapidly developing discipline in medicine. No wonder, the major share of Nobel prizes in medicine has gone to research workers engaged in biochemistry. Thanks to the advent of DNA recombinant technology, genes can now be transferred from one person to another, so that many of the genetically determined diseases are now amenable to gene therapy. Many genes, (e.g. human insulin gene) have already been transferred to microorganisms for large scale production of human insulin. Advances in genomics like RNA interference for silencing of genes and creation of transgenic animals by gene targeting of embryonic stem cells are opening up new vistas in therapy of diseases like cancer and AIDS. It is hoped that in future, the physician will be able to treat the patient, understanding his genetic basis, so that very efficient "designer medicine" could cure the diseases.

**TABLE 1.1: Milestones in history of Biochemistry**

Scientists	Year	Landmark discoveries
Rouelle	1773	Isolated urea from urine
Lavoisier	1785	Oxidation of food stuffs
Wohler	1828	Synthesis of urea
Berzelius	1835	Enzyme catalysis theory
Louis Pasteur	1860	Fermentation process
Edward Buchner	1897	Extracted enzymes
Fiske and Subbarao	1926	Isolated ATP from muscle
Lohmann	1932	Creatine phosphate
Hans Krebs	1937	Citric acid cycle
Avery and Macleod	1944	DNA is genetic material
Lehninger	1950	TCA cycle in mitochondria
Watson and Crick	1953	Structure of DNA
Nirenberg	1961	Genetic code in mRNA
Holley	1963	Sequenced gene for tRNA
Khorana	1965	Synthesized the gene
Paul Berg	1972	Recombinant DNA technology
Kary Mullis	1985	Polymerase chain reaction
	1990	Human genome project started
	2000	Draft human genome
	2003	Human genome project completed
ENCODE	2012	ENCyclopedia Of DNA Elements

The large amount of data, especially with regard to single nucleotide polymorphisms (SNPs) that are available, could be harnessed by "Bioinformatics". Computers are already helping in drug designing process. Studies on oncogenes have identified molecular mechanisms of control of normal and abnormal cells. Medical practice is now depending more on the science of Medical Biochemistry. With the help of Human genome project (HGP) the sequences of whole human genes are now available; it has already made great impact on medicine and related health sciences.

## BIOMOLECULES

More than 99% of the human body is composed of 6 elements, i.e. oxygen, carbon, hydrogen, nitrogen, calcium and phosphorus. Human body is composed of about 60% water, 15% proteins, 15% lipids, 2% carbohydrates and 8% minerals. Molecular structures in organisms are built from 30 small precursors, sometimes called the alphabets of biochemistry. These are 20 amino acids, 2 purines, 3 pyrimidines, sugars (glucose and ribose), palmitate, glycerol and choline.

In living organisms, biomolecules are ordered into a hierarchy of increasing molecular complexity. These biomolecules are covalently linked to each other to form macromolecules of the cell, e.g. glucose to glycogen, amino acids to proteins, etc. Major complex biomolecules are proteins, polysaccharides, lipids and nucleic acids. The macromolecules associate with each other by noncovalent forces to form supramolecular systems, e.g. ribosomes, lipoproteins.



Lavoisier  
1743–1794



Berzelius  
1779–1848



Friedrich  
Wohler  
1800–1882



Justus von Liebig  
1803–1873



Frederick  
Donnan  
1870–1956



Louis Pasteur  
1822–1895



Johannes van  
der Waals  
NP 1910,  
1837–1923



Albert Lehninger  
1917–1986

Finally at the highest level of organization in the hierarchy of cell structure, various supramolecular complexes are further assembled into cell organelle. In prokaryotes (e.g. bacteria; Greek word "pro" = before; karyon = nucleus), these macromolecules are seen in a homogeneous matrix; but in eukaryotic cells (e.g. higher organisms; Greek word "eu" = true), the cytoplasm contains various subcellular organelles. Comparison of prokaryotes and eukaryotes are shown in Table 1.2.

## STUDY OF METABOLIC PROCESSES

Our food contains carbohydrates, fats and proteins as principal ingredients. These macromolecules are to be first broken down to small units; carbohydrates to monosaccharides and proteins to amino acids. This process is taking place in the gastrointestinal tract and is called digestion or **primary metabolism**. After absorption, the small molecules are further broken down and oxidized to carbon dioxide. In this process, NADH or FADH<sub>2</sub> are generated. This is named as **secondary or intermediary metabolism**. Finally, these reducing equivalents enter the electron transport chain in the mitochondria, where they are oxidized to water; in this process energy is trapped as ATP. This is termed **tertiary metabolism**. Metabolism is the sum of all chemical changes of a compound inside the body, which includes synthesis (anabolism) and breakdown (catabolism). (Greek word, kata = down; ballein = change).

## STABILIZING FORCES IN MOLECULES

### Covalent Bonds

Molecules are formed by sharing of electrons between atoms (Fig. 1.1).

### Ionic Bonds or Electrostatic Bonds

Ionic bonds result from the **electrostatic attraction between two ionized groups of opposite charges** (Fig.1.2). They are formed by transfer of one or more

**TABLE 1.2: Bacterial and mammalian cells**

	<i>Prokaryotic cell</i>	<i>Eukaryotic cell</i>
Size	Small	Large; 1000 to 10,000 times
Cell wall	Rigid	Membrane of lipid bilayer
Nucleus	Not defined	Well defined
Organelles	Nil	Several; including mitochondria and lysosomes

electrons from the outer most orbit of an electropositive atom to the outermost orbit of an electronegative atom. This transfer results in the formation of a 'cation' and an 'anion', which get consequently bound by an ionic bond. Common examples of such compounds include NaCl, KBr and NaF.

With regard to protein chemistry, positive charges are produced by epsilon amino group of lysine, guanidium group of arginine and imidazolium group of histidine. Negative charges are provided by beta and gamma carboxyl groups of aspartic acid and glutamic acid (Fig.1.3).

### Hydrogen Bonds

These are formed by **sharing of a hydrogen between two electron donors**. Hydrogen bonds result from electrostatic

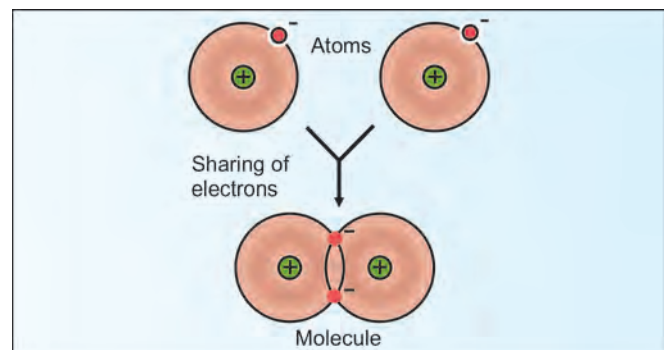


Fig. 1.1: Covalent bond

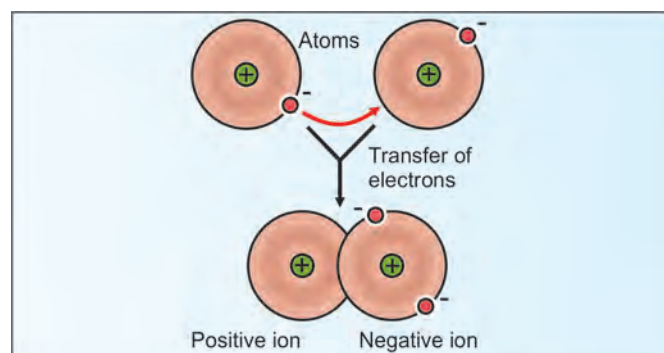


Fig. 1.2: Ionic bond

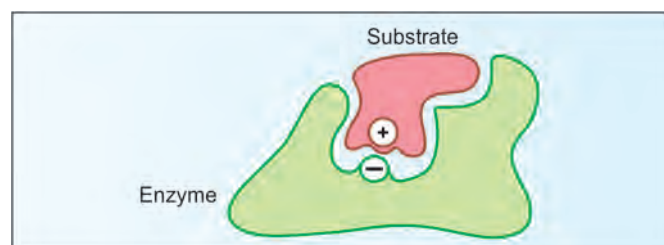


Fig. 1.3: Ionic bonds used in protein interactions

attraction between an electronegative atom and a hydrogen atom that is bonded covalently to a second electronegative atom. Normally, a hydrogen atom forms a covalent bond with only one other atom. However, a hydrogen atom covalently bonded to a donor atom, may form an additional weak association, the hydrogen bond with an acceptor atom. In biological systems, both donors and acceptors are usually nitrogen or oxygen atoms, especially those atoms in amino ( $\text{NH}_2$ ) and hydroxyl (OH) groups.

With regard to protein chemistry, hydrogen releasing groups are  $\text{NH}$  (imidazole, in dole, peptide);  $\text{OH}$  (serine, threonine) and  $\text{NH}_2$  (arginine, lysine). Hydrogen accepting groups are  $\text{COO}^-$  (aspartic, glutamic)  $\text{C}=\text{O}$  (peptide); and  $\text{S-S}$  (disulphide). The DNA structure is maintained by hydrogen bonding between the purine and pyrimidine residues.

### Hydrophobic Interactions

Non-polar groups have a tendency to associate with each other in an aqueous environment; this is referred to as hydrophobic interaction. These are formed by interactions between nonpolar hydrophobic side chains by eliminating water molecules. The force that causes hydrophobic molecules or nonpolar portions of molecules to aggregate together rather than to dissolve in water is called the 'hydrophobic bond' (Fig.1.4). This serves to hold lipophilic side chains of amino acids together. Thus non-polar molecules will have minimum exposure to water molecules.

### Van Der Waals Forces

These are very weak forces of attraction between all atoms, due to oscillating dipoles, described by the Dutch physicist

Johannes van der Waals (1837–1923). He was awarded Nobel prize in 1910. These are short range attractive forces between chemical groups in contact. Van der Waals interactions occur in all types of molecules, both polar and non-polar. The energy of the van der Waals interaction is about 1 kcal/mol and are unaffected by changes in pH. This force will drastically reduce, when the distance between atoms is increased. Although very weak, van der Waals forces collectively contribute maximum towards the stability of protein structure, especially in preserving the non-polar interior structure of proteins.

## WATER: THE UNIVERSAL SOLVENT

Water constitutes about 70 to 80 percent of the weight of most cells. The hydrogen atom in one water molecule is attracted to a pair of electrons in the outer shell of an oxygen atom in an adjacent molecule. The structure of liquid water contains hydrogen-bonded networks (Fig. 1.5).

The crystal structure of ice depicts a tetrahedral arrangement of water molecules. On melting, the molecules get much closer and this results in the increase in density of water. Hence, liquid water is denser than solid ice. This also explains why ice floats on water.

Water molecules are in rapid motion, constantly making and breaking hydrogen bonds with adjacent molecules. As the temperature of water increases toward  $100^\circ\text{C}$ , the kinetic energy of its molecules becomes greater than the energy of the hydrogen bonds connecting them, and the gaseous form of water appears. The unique properties of water make it the most preferred medium for all cellular reactions and interactions.

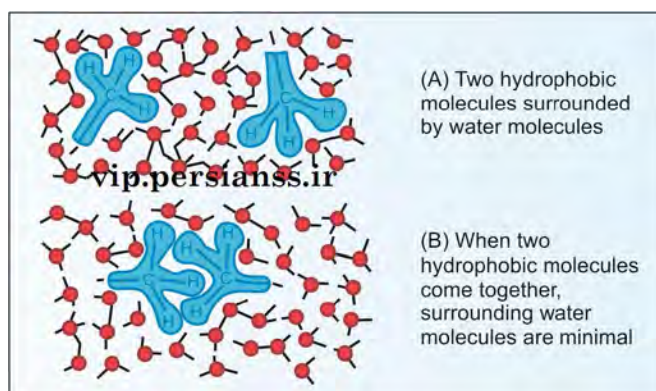


Fig. 1.4: Hydrophobic interaction

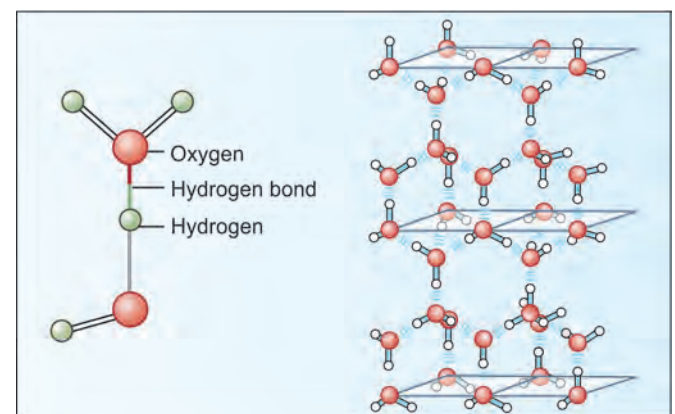


Fig. 1.5: Water molecules hydrogen bonded



- Water is a polar molecule. Molecules with polar bonds that can easily form hydrogen bonds with water can dissolve in water and are termed “hydrophilic”.
- It has immense hydrogen bonding capacity both with other molecules and also the adjacent water molecules. This contributes to cohesiveness of water.
- Water favors hydrophobic interactions and provides a basis for metabolism of insoluble substances.

Water expands when it is cooled from 4° C to 0° C, while normally liquids are expected to contract due to cooling. As water is heated from 0° C to 4° C, the hydrogen bonds begin to break. This results in a decrease in volume or in other words, an increase in density. Hence, water attains high density at 4° C. However, above 4° C the effect of temperature predominates.

## PRINCIPLES OF THERMODYNAMICS

Thermodynamics is concerned with the flow of heat and it deals with the relationship between heat and work. **Bioenergetics**, or biochemical thermodynamics, is the study of the energy changes accompanying biochemical reactions. Biological systems use chemical energy to power living processes.

### First Law of Thermodynamics

**The total energy of a system, including its surroundings, remains constant.** Or,  $\Delta E = Q - W$ , where Q is the heat absorbed by the system and W is the work done. This is also called the **law of conservation of energy**. If heat is transformed into work, there is proportionality between the work obtained and the heat dissipated. A system is an object or a quantity of matter, chosen for observation. All other parts of the universe, outside the boundary of the system, are called the surrounding.

### Second Law of Thermodynamics

**The total entropy of a system must increase if a process is to occur spontaneously.** A reaction occurs spontaneously if  $\Delta E$  is negative, or if the entropy of the system increases. **Entropy (S)** is a measure of the degree of randomness or disorder of a system. Entropy becomes maximum in a system as it approaches true equilibrium. **Enthalpy** is the heat content of a system and **entropy** is that fraction of enthalpy which is not available to do useful work.

### A closed system approaches a state of equilibrium.

Any system can spontaneously proceed from a state of low probability (ordered state) to a state of high probability (disordered state). The entropy of a system may decrease with an increase in that of the surroundings. The second law may be expressed in simple terms as  $Q = T \times \Delta S$ , where Q is the heat absorbed, T is the absolute temperature and  $\Delta S$  is the change in entropy.

## Gibb's Free Energy Concept

The term free energy is used to get an equation combining the first and second laws of thermodynamics. Thus,  $\Delta G = \Delta H - T\Delta S$ , where  $\Delta G$  is the change in free energy,  $\Delta H$  is the change in enthalpy or heat content of the system and  $\Delta S$  is the change in entropy. **The term free energy denotes a portion of the total energy change in a system that is available for doing work.**

For most biochemical reactions, it is seen that  $\Delta H$  is nearly equal to  $\Delta E$ . So,  $\Delta G = \Delta E - T\Delta S$ . Hence,  $\Delta G$  or free energy of a system depends on the change in internal energy and change in entropy of a system.

## Standard Free Energy Change

It is the free energy change under standard conditions. It is designated as  $\Delta G^0$ . The standard conditions are defined for biochemical reactions at a pH of 7 and 1 M concentration, and differentiated by a priming sign  $\Delta G^{0'}$ . It is directly related to the equilibrium constant. Actual free energy changes depend on reactant and product.

Most of the reversible metabolic reactions are near equilibrium reactions and therefore their  $\Delta G$  is nearly zero. The net rate of near equilibrium reactions are effectively regulated by the relative concentration of substrates and products. The metabolic reactions that function far from equilibrium are irreversible. The velocities of these reactions are altered by changes in enzyme activity. A highly exergonic reaction is irreversible and goes to completion. Such a reaction that is part of a metabolic pathway, confers direction to the pathway and makes the entire pathway irreversible.

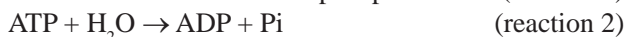
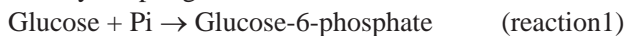
Laws of thermodynamics have many applications in biology and biochemistry, such as study of ATP hydrolysis, membrane diffusion, enzyme catalysis as well as DNA binding and protein stability. These laws have been used to explain hypothesis of origin of life.

### Three Types of Reactions

- A reaction can occur spontaneously when  $\Delta G$  is negative. Then the reaction is **exergonic**. If  $\Delta G$  is of great magnitude, the reaction goes to completion and is essentially irreversible.
- When  $\Delta G$  is zero, the system is at **equilibrium**.
- For reactions where  $\Delta G$  is positive, an input of energy is required to drive the reaction. The reaction is termed as **endergonic**. (Examples are given in Chapter 5).

Similarly a reaction may be *exothermic* ( $\Delta H$  is negative), *isothermic* ( $\Delta H$  is zero) or *endothermic* ( $\Delta H$  is positive).

Energetically unfavourable reaction may be driven forward by coupling it with a favourable reaction.



Reaction 1 cannot proceed spontaneously. But the 2nd reaction is coupled in the body, so that the reaction becomes possible. For the first reaction,  $\Delta G^0$  is +13.8 kJ/mole; for the second reaction,  $\Delta G^0$  is -30.5 kJ/mole. When the two reactions are coupled in the reaction 3, the  $\Delta G^0$  becomes -16.7 kJ/mole, and hence the reaction becomes possible. Details on ATP and other high-energy phosphate bonds are described in Chapter 20.

Reactions of **catabolic** pathways (degradation or oxidation of fuel molecules) are usually exergonic. On the other hand, **anabolic** pathways (synthetic reactions or building up of compounds) are endergonic. Metabolism constitutes anabolic and catabolic processes that are well co-ordinated.

### DONNAN MEMBRANE EQUILIBRIUM

When two solutions are separated by a membrane permeable to both water and small ions, but when one of the compartments contains impermeable ions like proteins, distribution of permeable ions occurs according to the calculations of Donnan.

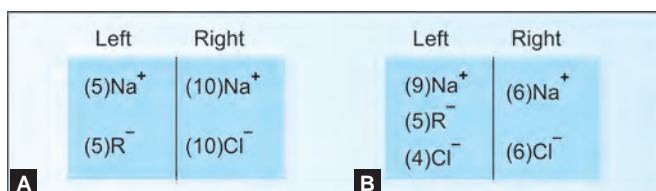


Fig. 1.6: Donnan membrane equilibrium

In Figure 1.6, the left compartment contains NaR, which will dissociate into Na<sup>+</sup> and R<sup>-</sup>. Then Na<sup>+</sup> can diffuse freely, but R<sup>-</sup> having high molecular weight cannot diffuse. The right compartment contains NaCl, which dissociates into Na<sup>+</sup> and Cl<sup>-</sup>, in which case, both ions can diffuse freely.

Thus, if a salt of NaR is placed in one side of a membrane, at equilibrium

$$\text{Na}^+ \times \text{R}^- \times \text{H}^+ \times \text{OH}^- = \text{Na}^+ \times \text{OH}^- \times \text{H}^+$$

To convey the meaning of the mathematical values, a hypothetical quantity of each of the ion is also incorporated in brackets. Initially 5 molecules of NaR are added to the left compartment and 10 molecules of NaCl in the right compartment and both of them are ionized (Fig.1.6A). When equilibrium is reached, the distributions of ions are shown in Figure 1.6B. According to Donnan's equilibrium, the products of diffusible electrolytes in both the compartments will be equal, so that

$$[\text{Na}^+]_L \times [\text{Cl}^-]_L = [\text{Na}^+]_R \times [\text{Cl}^-]_R$$

If we substitute the actual numbers of ions, the formula becomes

$$9 \times 4 \text{ in left} = 6 \times 6 \text{ in right}$$

Donnan's equation also states that the electrical neutrality in each compartment should be maintained. In other words the number of cations should be equal to the number of anions, such that

$$\text{In left} \quad : \text{Na}^+ = \text{R}^- + \text{Cl}^-; \text{ substituting: } 9 = 5 + 4$$

$$\text{In right} \quad : \text{Na}^+ = \text{Cl}^-; \text{ substituting: } 6 = 6$$

The equation should also satisfy that the number of sodium ions before and after the equilibrium are the same; in our example, initial Na<sup>+</sup> in the two compartments together is 5 + 10 = 15; after equilibrium also, the value is 9 + 6 = 15. In the case of chloride ions, initial value is 10 and final value is also 4 + 6 = 10.

**In summary**, Donnan's equations satisfy the following results:

- The products of diffusible electrolytes in both compartments are equal.
- The electrical neutrality of each compartment is maintained.
- The total number of a particular type of ions before and after the equilibrium is the same.
- As a result, **when there is non-diffusible anion on one side of a membrane, the diffusible cations are more, and diffusible anions are less, on that side.**

## Clinical Applications of the Equation

1. The total concentration of solutes in plasma will be more than that of a solution of same ionic strength containing only diffusible ions; this provides the net osmotic gradient (see under Albumin, in Chapter 28).
2. **The lower pH values within tissue cells** than in the surrounding fluids are partly due to the concentrations of negative protein ions within the cells being higher than in surrounding fluids.
3. **The pH within red cells** is lower than that of the surrounding plasma is due, in part, to the very high concentration of negative non-diffusible hemoglobin ions. This will cause unequal distribution of  $H^+$  ions with a higher concentration within the cell.
4. **The chloride shift** in erythrocytes as well as higher concentration of chloride in CSF are also due to Donnan's effect.
5. **Osmolarity of body fluid** compartments and sodium concentration will follow Donnan equation.
6. **Different steps of water purification** employ the same principle and may be cited as an example of industrial application of the equation.

# CHAPTER 2

## Subcellular Organelles and Cell Membranes

### Chapter at a Glance

The reader will be able to answer questions on the following topics:

- Nucleus
- Endoplasmic reticulum
- Golgi apparatus
- Lysosomes
- Mitochondria
- Plasma membrane
- Transport mechanisms
- Simple and facilitated diffusion
- Ion channels
- Active transport
- Uniport, symport and antiport

### SUBCELLULAR ORGANELLES

Cells contain various organized structures, collectively called as cell organelles (Fig.2.1). When the cell membrane is disrupted, either by mechanical means or by lysing the membrane by Tween-20 (a lipid solvent), the organized particles inside the cell are homogenized. This is usually carried out in 0.25M sucrose at pH 7.4. The organelles could then be separated by applying differential centrifugal forces (Table 2.1). Albert Claude got Nobel prize in 1974 for fractionating subcellular organelles.

### Marker Enzymes

Some enzymes are present in certain organelles only; such specific enzymes are called as marker enzymes (Table 2.1). After centrifugation, the separated organelles are identified by detection of marker enzymes in the sample.

### NUCLEUS

1. It is the most prominent organelle of the cell. All cells in the body contain nucleus, except mature RBCs in circulation. The uppermost layer of skin also may not possess a readily identifiable nucleus. In some cells, nucleus occupies most of the available space, e.g. small lymphocytes and spermatozoa.



Albert  
Claude  
NP 1974  
1899–1983



Camillo  
Golgi  
NP 1906  
1843–1926



Christian  
de Duve  
NP 1974  
b.1917



George  
Palade  
NP 1974  
1912–2008

- Nucleus is surrounded by two membranes—the inner one is called perinuclear membrane with numerous pores (Fig. 2.2) and the outer membrane is continuous with membrane of endoplasmic reticulum.
- Nucleus contains the **DNA**, the chemical basis of genes, which governs all the functions of the cell. The very long DNA molecules are complexed with proteins to form chromatin and are further organized into **chromosomes**.
- DNA replication and RNA synthesis (transcription) are taking place inside the nucleus.
- In some cells, a portion of the nucleus may be seen as lighter shaded area; this is called **nucleolus** (Fig. 2.2).

This is the area for RNA processing and ribosome synthesis. The nucleolus is very prominent in cells actively synthesizing proteins. Gabriel Valentine in 1836 described the nucleolus.

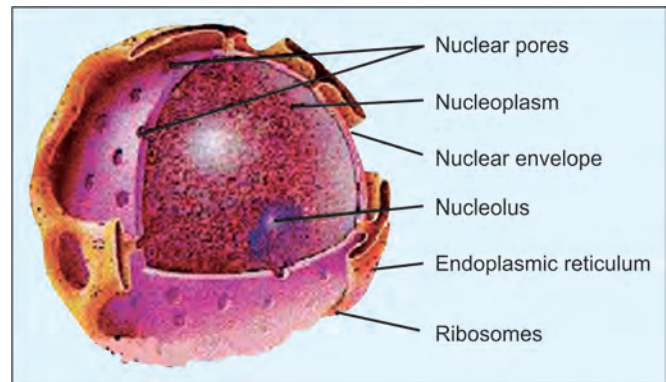
- Vesicular transport across membrane is by endocytosis and exocytosis. Importin and exportin proteins are involved, and it is helped by RanGAP proteins.

## ENDOPLASMIC RETICULUM (ER)

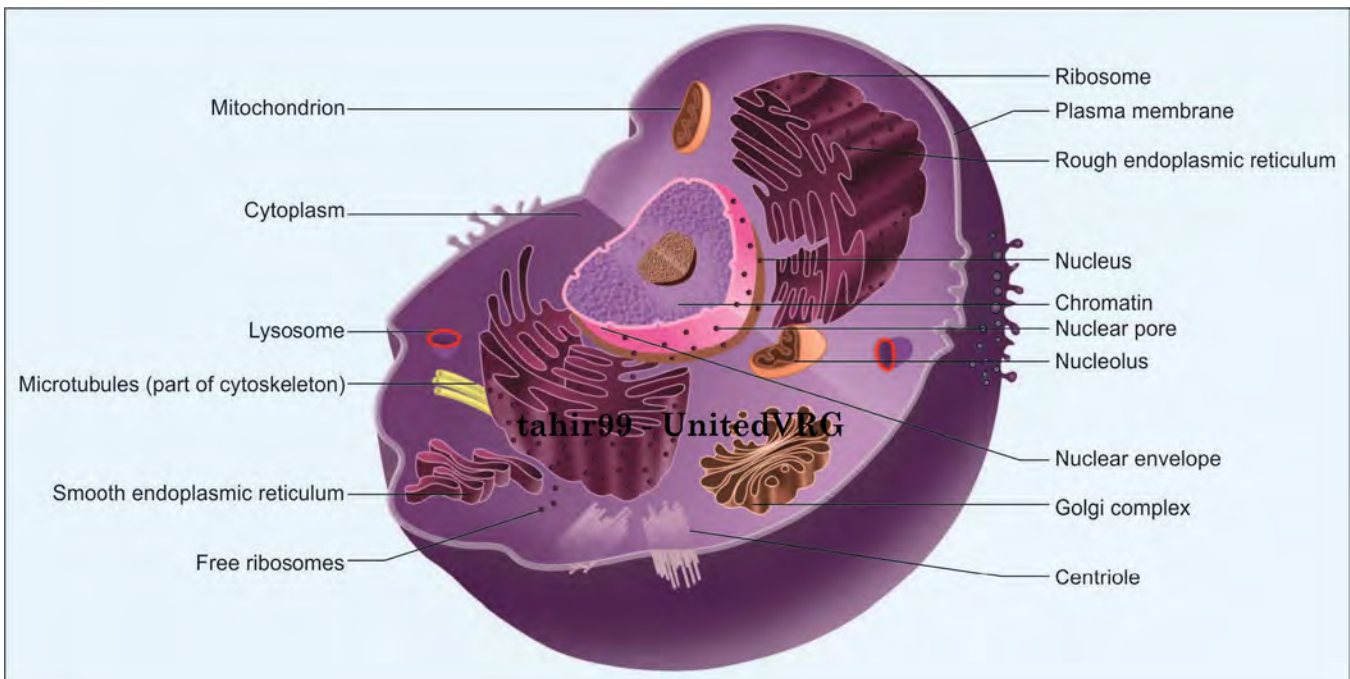
- It is a network of interconnecting membranes enclosing channels or cisternae, that are continuous from outer nuclear envelope to outer plasma membrane.

**TABLE 2.1:** Separation of subcellular organelles

Subcellular organelle	Pellet formed at the centrifugal force of	Marker enzyme
Nucleus	600–750 x g, 10 min	
Mitochondria	10,000–15,000 x g, 10 min	Inner membrane: ATP Synthase
Lysosome	18,000–25,000 x g, 10 min	Cathepsin
Golgi complex	35,000–40,000 x g, 30 min	Galactosyl transferase
Microsomes	75,000–100,000 x g, 100 min	Glucose-6-phosphatase
Cytoplasm	Supernatant	Lactate dehydrogenase



**Fig. 2.2:** Nucleus



**Fig. 2.1:** A typical cell



Under electron microscope, the reticular arrangements will have railway track appearance (Fig. 2.1). George Palade was awarded Nobel prize in 1974, who identified the ER.

- This will be very prominent in cells actively synthesizing proteins, e.g. immunoglobulin secreting plasma cells. The proteins, glycoproteins and lipoproteins are synthesised in the ER.
- Detoxification of various drugs is an important function of ER. **Microsomal cytochrome P-450** hydroxylates drugs, such as benzpyrine, aminopyrine, aniline, morphine, phenobarbitone, etc.
- According to the electron microscopic appearance, the ER is generally classified into **rough and smooth** varieties. The rough appearance is due to ribosomes attached to cytoplasmic side of membrane where the proteins are being synthesized.
- When cells are fractionated, the complex ER is disrupted in many places. They are automatically reassembled to form microsomes.
- ERGIC** (Endoplasmic reticulum - Golgi intermediate compartment): The synthesized protein pass through this compartment before going to the cis Golgi.

## GOLGI APPARATUS

- Camillo Golgi described the structure in 1898 (Nobel prize 1906). The Golgi organelle is a network of flattened smooth membranes and vesicles. It may be considered as the converging area of endoplasmic reticulum (Fig. 2.1).
- While moving through ER, carbohydrate groups are successively added to the nascent proteins. These glycoproteins reach the Golgi area.
- Golgi apparatus is composed of **cis, medial and trans** cisternae.
 

Glycoproteins are generally transported from ER to cis Golgi (proximal cisterna), then to medial Golgi (intermediate cisterna) and finally to trans Golgi (distal cisterna) for temporary storage. Trans Golgi is particularly abundant with vesicles containing glycoproteins. Newly synthesized proteins are sorted first according to the sorting signals available in the proteins. Then they are packaged into transport vesicles having different types of coat proteins. Finally they are transported into various destinations; this is an energy dependent process.
- Main function of Golgi apparatus is protein sorting, packaging and secretion.
- The finished products may have any one of the **following destinations**:
  - They may pass through plasma membrane to the surrounding medium. This forms continuous

secretion, e.g. secretion of immunoglobulins by plasma cells.

- They reach plasma membrane and form an integral part of it, but not secreted.
- They form a secretory vesicle, where these products are stored for a longer time. Under appropriate stimuli, the contents are secreted. Release of trypsinogen by pancreatic acinar cells and release of insulin by beta cells of Langerhans are cited as examples.
- The synthesized materials may also reach lysosome packets.
- Golgi bodies are fragmented during mitosis, but get reorganized by interaction with microtubules. Connective tissue disorders like **Sjogren's syndrome** are found to be associated with anti-golgi antibodies.

## LYSOSOMES

- Discovered in 1950 by Christian de Duve (Nobel prize 1974), lysosomes are tiny organelles. Solid wastes

### Box 2.1: Clinical applications of lysosomes

- In **gout**, urate crystals are deposited around knee joints (see Chapter 39). These crystals when phagocytosed, cause physical damage to lysosomes and release of enzymes. Inflammation and arthritis result.
- Following cell death, the lysosomes rupture releasing the hydrolytic enzymes which bring about **postmortem autolysis**.
- Lysosomal proteases, **cathepsins** are implicated in **tumor metastasis**. Cathepsins are normally restricted to the interior of lysosomes, but certain cancer cells liberate the cathepsins out of the cells. Then cathepsins degrade the basal lamina by hydrolyzing collagen and elastin, so that other tumor cells can travel out to form distant metastasis.
- There are a few genetic diseases, where lysosomal enzymes are deficient or absent. This leads to accumulation of lipids or polysaccharides (see Chapters 10 and 14).
- Silicosis results** from inhalation of silica particles into the lungs which are taken up by phagocytes. Lysosomal membrane ruptures, releasing the enzymes. This stimulates fibroblast to proliferate and deposit collagen fibers, resulting in fibrosis and decreased lungs elasticity.
- Inclusion cell (I-cell) disease** is a rare condition in which lysosomes lack in enzymes, but they are seen in blood. This means that the enzymes are synthesized, but are not able to reach the correct site. It is shown that mannose-6-phosphate is the marker to target the nascent enzymes to lysosomes. In these persons, the carbohydrate units are not added to the enzyme. Mannose-6-phosphate deficient enzymes cannot reach their destination (protein targeting defect).

of a township are usually decomposed in incinerators. Inside a cell, such a process is taking place within the lysosomes. They are bags of enzymes. Clinical applications of lysosomes are shown in Box 2.2.

- Endocytic vesicles and phagosomes are fused with lysosome (primary) to form the **secondary lysosome** or digestive vacuole. Foreign particles are progressively digested inside these vacuoles. Completely hydrolyzed products are utilized by the cell. As long as the lysosomal membrane is intact, the encapsulated enzymes can act only locally. But when the membrane is disrupted, the released enzymes can hydrolyze external substrates, leading to tissue damage.
- The lysosomal enzymes have an optimum pH around 5. These enzymes are:
  - Polysaccharide hydrolyzing enzymes (alpha-glucosidase, alpha-fucosidase, beta-galactosidase, alpha-mannosidase, beta-glucuronidase, hyaluronidase, aryl sulfatase, lysozyme)
  - Protein hydrolyzing enzymes (cathepsins, collagenase, elastase, peptidases)
  - Nucleic acid hydrolyzing enzymes (ribonuclease, deoxyribonuclease)
  - Lipid hydrolyzing enzymes (fatty acyl esterase, phospholipases).

## PEROXISOMES

- The peroxisomes have a granular matrix. They are of 0.3–1.5  $\mu\text{m}$  in diameter. They contain peroxidases and catalase. They are prominent in leukocytes and platelets.
- Peroxidation of **polyunsaturated fatty acids** in vivo may lead to hydroperoxide formation,  $\text{R-OOH} \rightarrow \text{R-OO}\cdot$ . The free radicals damage molecules, cell membranes, tissues and genes. (see Chapter 33).
- Catalase and peroxidase** are the enzymes present in peroxisomes, which will destroy the unwanted peroxides and other free radicals.

Clinical applications of peroxisomes are shown in Box 2.2.

### Box 2.2: Peroxisomal deficiency diseases

- Deficiency of peroxisomal matrix proteins can lead to adrenoleukodystrophy (ALD) (Brown-Schilder's disease) characterized by progressive degeneration of liver, kidney and brain. It is a rare autosomal recessive condition. The defect is due to insufficient oxidation of very long chain fatty acids (VLCFA) by peroxisomes (see Chapter 14).
- In Zellweger syndrome, proteins are not transported into the peroxisomes. This leads to formation of empty peroxisomes or peroxisomal ghosts inside the cells. Protein targeting defects are described in Chapter 46.
- Primary hyperoxaluria is due to the defective peroxisomal metabolism of glyoxalate derived from glycine (see Chapter 16).

## MITOCHONDRIA

- They are spherical, oval or rod-like bodies, about 0.5–1  $\mu\text{m}$  in diameter and up to 7  $\mu\text{m}$  in length (Fig. 2.1). Erythrocytes do not contain mitochondria. The tail of spermatozoa is fully packed with mitochondria.
- Mitochondria are the **powerhouse of the cell**, where energy released from oxidation of food stuffs is trapped as chemical energy in the form of ATP (see Chapter 20). Metabolic functions of mitochondria are shown in Table 2.2.
- Mitochondria have two membranes. The inner membrane convolutes into folds or cristae (Fig. 2.3). The inner mitochondrial membrane contains the enzymes of **electron transport chain** (see Chapter 20). The fluid matrix contains the enzymes of citric acid cycle, urea cycle and heme synthesis.
- Cytochrome P-450** system present in mitochondrial inner membrane is involved in steroidogenesis (see Chapter 52). **Superoxide dismutase** is present in cytosol and mitochondria (see Chapter 33).
- Mitochondria also contain **specific DNA**. The integral inner membrane proteins, are made by mitochondrial protein synthesizing machinery. However, the majority of proteins, especially of outer membrane are synthesized under the control of cellular DNA. The division of mitochondria is under the command of mitochondrial DNA. Mitochondrial ribosomes are different from cellular ribosomes. **Antibiotics** inhibiting bacterial protein synthesis do not affect cellular processes, but do inhibit mitochondrial protein biosynthesis (see Chapter 45).

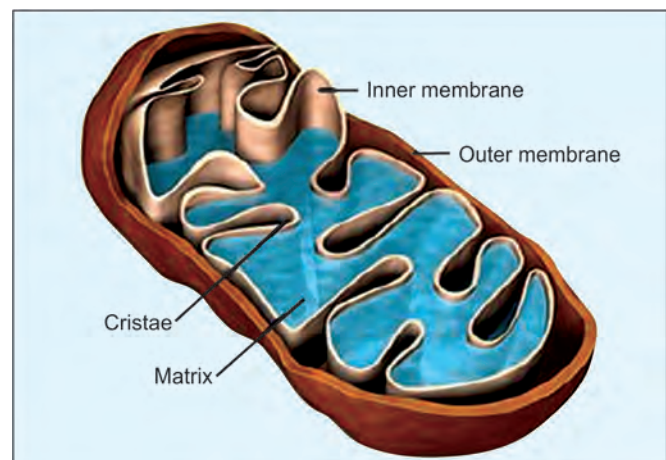


Fig. 2.3: Mitochondria

- Mitochondria play a role in triggering apoptosis (see Chapter 47).
- Taking into consideration such evidences, it is assumed that mitochondria are parasites, which entered into cells at a time when multicellular organisms were being evolved. These parasites provided energy in large quantities giving an evolutionary advantage to the cell; the cell gave protection to these parasites. This perfect symbiosis, in turn, evolved into a cellular organelle of mitochondria.
- Mitochondria are continuously undergoing fission and fusion, resulting in mixing of contents of mitochondrial particles. Specific fission and fusion proteins have been identified and abnormalities in some of these proteins are implicated in diseases like Charcot-Marie-Tooth disease.
- New evidence suggests a role for mitochondria in the genesis of systemic inflammatory response. The mitochondrial particles released from damaged tissue may evoke an antigenic response from the immune system.
- A summary of functions of organelles is given in Table 2.2 and Box 2.3.

## PLASMA MEMBRANE

- The plasma membrane separates the cell from the external environment. It has highly selective permeability properties so that the entry and exit of compounds are regulated. The cellular metabolism is in turn influenced and probably regulated by the membrane. The membrane is metabolically very active.

**TABLE 2.2: Metabolic functions of subcellular organelles**

Nucleus	DNA replication, transcription
Endoplasmic reticulum	Biosynthesis of proteins, glycoproteins, lipoproteins, drug metabolism, ethanol oxidation, synthesis of cholesterol (partial)
Golgi body	Maturation of synthesized proteins
Lysosome	Degradation of proteins, carbohydrates, lipids and nucleotides
Mitochondria	Electron transport chain, ATP generation, TCA cycle, beta oxidation of fatty acids, ketone body production, urea synthesis (part), heme synthesis (part), gluconeogenesis (part), pyrimidine synthesis (part)
Cytosol	Protein synthesis, glycolysis, glycogen metabolism, HMP shunt pathway, transaminations, fatty acid synthesis, cholesterol synthesis, heme synthesis (part), urea synthesis (part), pyrimidine synthesis (part), purine synthesis

- The enzyme, nucleotide phosphatase (5' nucleotidase) and alkaline phosphatase are seen on the outer part of cell membrane; they are therefore called **ecto-enzymes**.
- Membranes are mainly made up of lipids, proteins and small amount of carbohydrates. The contents of these compounds vary according to the nature of the membrane. The carbohydrates are present as glycoproteins and glycolipids. Phospholipids are the most common lipids present and they are amphipathic in nature. Cell membranes also contain cholesterol.

## Fluid Mosaic Model

The lipid bilayer was originally proposed by Davson and Danielli in 1935. Later, the structure of the biomembranes was described as a fluid mosaic model (Singer and Nicolson, 1972).

- The phospholipids are arranged in bilayers with the polar head groups oriented towards the extracellular side and the cytoplasmic side with a hydrophobic core (Fig. 2.4A). The distribution of the phospholipids is such that choline containing phospholipids are mainly in the external layer and ethanolamine and serine containing phospholipids in the inner layer. Gerd Binnig and Heinrich Rohrer introduced the scanning electron microscopy in 1981 by which the outer and inner layers of membranes could be visualized separately. They were awarded Nobel prize in 1986.
- Each leaflet is 25 Å thick, with the head portion 10 Å and tail 15 Å thick. The total thickness is about 50 to 80 Å.
- The lipid bilayer shows free lateral movement of its components, hence the membrane is said to be fluid in nature. Fluidity enables the membrane to perform endocytosis and exocytosis.
- However, the components do not freely move from inner to outer layer, or outer to inner layer (flip-flop movement is restricted). During apoptosis (programed cell death), flip-flop movement occurs.

This flip-flop movement is catalyzed by enzymes. **Flippases** catalyze the transfer of amino phospholipids across the membrane. **Floppases** catalyze the outward directed movement, which is

### Box 2.3: Comparison of cell with a factory

Plasma membrane	: Fence with gates; gates open when message is received
Nucleus	: Manager's office
Endoplasmic reticulum	: Conveyer belt of production units
Golgi apparatus	: Packing units
Lysosomes	: Incinerators
Vacuoles	: Lorries carrying finished products
Mitochondria	: Power generating units



ATP dependent. This is mainly seen in the role of ABC proteins mediating the efflux of cholesterol and the extrusion of drugs from cells. The MDR associated p-glycoprotein is a floppase.

- E. The **cholesterol** content of the membrane alters the fluidity of the membrane. When cholesterol concentration increases, the membrane becomes less fluid on the outer surface, but more fluid in the hydrophobic core. The effect of cholesterol on membrane fluidity is different at different temperatures. At temperature below the  $T_m$ , cholesterol increases fluidity and there-by permeability. At temperatures above the  $T_m$ , cholesterol decreases fluidity.

In spur cell anemia and alcoholic cirrhosis, membrane studies have revealed the role of excess cholesterol. The decrease in membrane fluidity may affect the activities of receptors and ion channels. This has been implicated in conditions like LCAT deficiency, Alzheimer's disease and hypertension.

Fluidity of cellular membranes responds to variations in diet and physiological states. Increased release of reactive oxygen species (ROS), increase in cytosolic calcium and lipid peroxidation have been found to adversely affect membrane fluidity. Anesthetics may act changing membrane fluidity.

- F. The nature of the fatty acids also affects the fluidity of the membrane, the more **unsaturated cis fatty acids** increase the fluidity.

The fluidity of the membrane is maintained by the length of the hydrocarbon chain, degree of unsaturation and nature of the polar head groups. Trans fatty acids (TFA) decrease the fluidity of membranes due to close packing of hydrocarbon chains. Cis double bonds create a kink in the hydrocarbon chain and have a marked effect on fluidity. Second OH group of glycerol in membrane phospholipids is often esterified to an unsaturated fatty acid, monounsaturated oleic or polyunsaturated linoleic, linolenic or arachidonic.

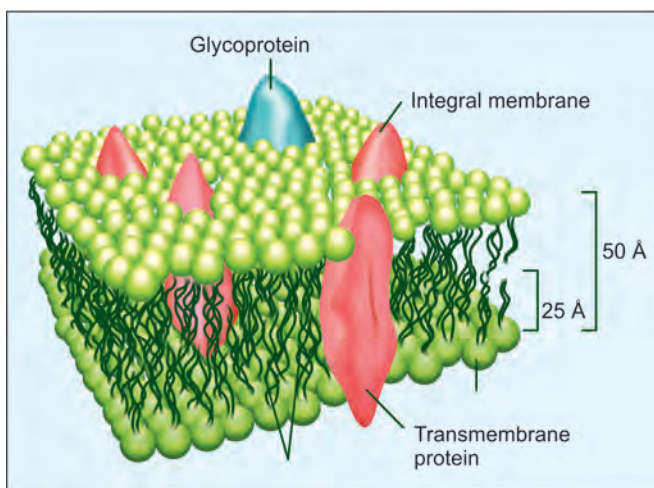


Fig. 2.4A: The fluid mosaic model of membrane

The nature of fatty acids and cholesterol content varies depending on diet. A higher proportion of PUFA, which increases the fluidity favors the binding of insulin to its receptor, a trans-membrane protein.

The lipids making up components of membranes are of three major classes that includes glycerophospholipids, sphingolipids, and cholesterol. Sphingolipids and glycerophospholipids constitute the largest percentage of the lipid weight of biological membranes. Proteins that are found associated with membranes can also be modified by lipid attachment (lipoproteins). The lipid portion of a lipoprotein anchors the protein to the membrane either through interaction with the lipid bilayer directly or through interactions with integral membrane proteins. Lipoproteins associated with membranes contain one of three types of covalent lipid attachment. The lipids are isoprenoids such as farnesyl and geranyl residues, fatty acids such as myristic and palmitic acid, and glycosylphosphatidyl inositol (GPI).

## Membrane Proteins

- A. **The peripheral proteins** exist on the surfaces of the bilayer (Fig. 2.4B). They are attached by ionic and polar bonds to polar heads of the lipids.

- B. **Anchoring of proteins to lipid bilayers:** Several peripheral membrane proteins are tethered to the membranes by covalent linkage with the membrane lipids. Since the lipids are inserted into the hydrophobic core, the proteins are firmly anchored. A typical form of linkage is the one involving phosphatidyl inositol which is attached to a glycan. This glycan unit has ethanolamine, phosphate and several carbohydrate residues. This glycan chain includes a glucose covalently attached to the C terminus of a protein by ethanolamine and to the phosphatidyl inositol by glucosamine. The fatty acyl groups of the phosphatidyl inositol diphosphate (PIP<sub>2</sub>) are firmly inserted into the lipid membrane thus anchoring the protein. This is referred to as glycosyl phosphatidyl inositol (GPI) anchor.

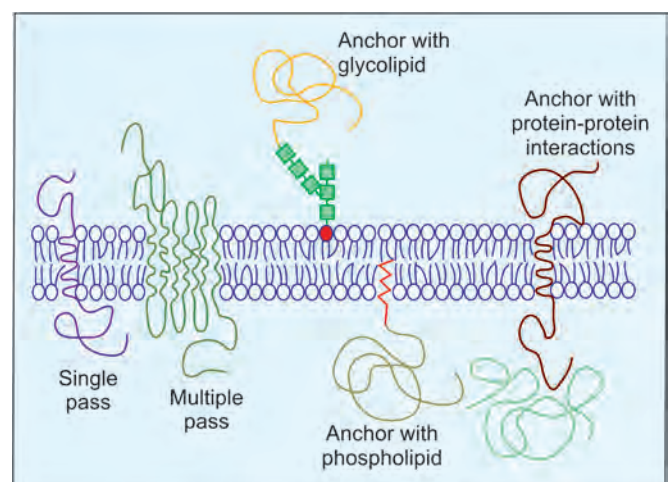


Fig. 2.4B: Proteins are anchored in membrane by different mechanisms

- C. **Microdomains on membranes:** GPI anchored proteins are often attached to the external surface of plasma membrane at microdomains called **lipid rafts**. They are areas on the membrane having predominantly glycosphingolipids and cholesterol. The localization and activity of the protein can be regulated by anchoring and release. Defective GPI anchors are implicated in Paroxysmal nocturnal hemoglobinuria (PNH). These lipid rafts are implicated in endocytosis, G protein signaling and binding of viral pathogens. Lipid rafts are areas on the membrane having predominantly glycosphingolipids and cholesterol. The GPI anchors that tether proteins to the membrane are also seen at the lipid rafts. Membrane proteins may be anchored by covalent bonding, palmitoylation and myristoylation.
- D. **Caveolae** are flask shaped indentations on the areas of lipid rafts that are involved in membrane transport and signal transduction. Caveolae contain the protein **caveolin**, along with other receptor proteins. Transport of macromolecules (IgA) from the luminal side occurs by caveolae mediated transcytosis. The endocytosis of cholesterol containing lipoproteins may be caveolae mediated. Similarly the fusion and budding of viral particles are also mediated by caveolae.
- E. **The integral membrane proteins** are deeply embedded in the bilayer and are attached by hydrophobic bonds or van der Waals forces.
- F. Some of the integral membrane proteins span the whole bilayer and they are called **transmembrane proteins** (Fig. 2.4). The hydrophobic side chains of the amino acids are embedded in the hydrophobic central core of the membrane. The transmembrane proteins can serve as **receptors** (for hormones, growth factors, neurotransmitters), tissue specific antigens, ion channels, membrane-based enzymes, etc.

### Bacterial Cell Wall

Prokaryotic (bacterial) cells as well as plant cells have a cell wall surrounding the plasma membrane; this cell wall provides mechanical strength to withstand high osmotic pressure. Animal cells are devoid of the cell wall; they have only plasma membrane. Major constituent of bacterial cell wall is a heteropolysaccharide, consisting of repeating

units of N-acetyl muramic acid (NAM) and N-acetyl glucosamine (NAG). This polysaccharide provides mechanical strength to the plasma membrane. Synthesis of this complex polysaccharide is blocked by penicillin. This inhibition is responsible for the **bactericidal action of penicillin**.

## SPECIALIZED MEMBRANE STRUCTURES

### Tight Junction

When two cells are in close approximation, in certain areas, instead of 4 layers, only 3 layers of plasma membranes are seen. This tight junction permits calcium and other small molecules to pass through from one cell to another through narrow hydrophilic pores. Some sort of communication between cells thus results. Absence of tight junction is implicated in loss of contact inhibition in cancer cells (see Chapter 57). Tight junctions also seal off subepithelial spaces of organs from the lumen. They contain specialized proteins, such as occludin, claudins and other adhesion molecules.

Most eukaryotic cells are in contact with their neighboring cells and these interactions are the basis of formation of organs. Cells that abut one another are in metabolic contact, which is brought about by specialized particles called **gap junctions**. Gap junctions are intercellular channels and their presence allows whole organs to be continuous from within. One major function of gap junctions is to ensure a supply of nutrients to cells of an organ that are not in direct contact with the blood supply. Gap junctions are formed from a type of protein called **connexin**.

### Myelin Sheath

It is made up of the membrane of **Schwann's cells**, (Theodor Schwann, 1858) condensed and spiralled many times around the central axon. The cytoplasm of Schwann cells is squeezed to one side of the cell. Myelin is composed of sphingomyelin, cholesterol and cerebroside. Myelin sheaths thin out in certain regions (**Node of Ranvier**) (Anotoine Ranvier, 1878). Due to this arrangement, the propagation of nerve impulse is wave-like; and the speed of propagation is also increased. Upon stimulation, there is rapid influx of sodium and calcium, so that depolarization occurs. Voltage gradient is quickly regained by ion pumps. The ions flow in and out of membrane only where membrane is free of insulation; hence the wave-like propagation of impulse. In **multiple sclerosis**, demyelination occurs at discrete areas, velocity of nerve impulse is reduced, leading to motor and sensory deficits.

### Microvilli

Microvilli of intestinal epithelial cells and pseudopodia of macrophages are produced by membrane evagination. This is due to the fluid nature of membranes.

### Membranes of Organelle

Membranes of endoplasmic reticulum, nucleus, lysosomes and outer layer of mitochondria may be considered as variants of plasma membrane. Percentage of protein content varies from 20% in myelin sheath to over 70% in the inner membranes of mitochondria.



Ernst Ruska  
NP 1986  
1906–1988

Gerd  
Binnig  
NP 1986  
b.1947

Heinrich  
Rohrer  
NP 1986  
b.1933

Theodor  
Schwann  
1810–1882

## Cytoskeleton

Human body is supported by the skeletal system; similarly the structure of a cell is maintained by the cytoskeleton present underneath the plasma membrane. The cytoskeleton is responsible for the shape of the cell, its motility and chromosomal movements during cell division.

The cytoskeleton is composed of microfilaments, intermediate filaments and microtubules, forming a network within the cell. Microfilaments made of G-actin found in almost all cells fuse to form F-actin and exist as a tangled meshwork of 8–9 nm size. **Intermediate filaments** have approximately 10 nm diameter. They form rod like elongated structures which are stable components of the cytoskeleton. Examples are **keratins** found in hair and nails and **lamins** which provide support for nuclear membrane. **Microtubules** contain alpha and beta **tubulin** with a diameter of 25 nm. They are essential for formation of mitotic spindle and participate in exocytosis and endocytosis. Alpha and beta tubulin molecules polymerize to form cylindrical protofilaments that assemble into sheets and fibers. They are continuously undergoing assembly and disassembly. Microtubule associated proteins stabilize their assembly, e.g. Abnormal aggregation of Tau proteins are found in brain in degenerative diseases. Vinca alkaloids used as anticancer drugs, inhibit the formation of mitotic spindle by interfering with the assembly of microtubules and thus inhibit cell division.

## Molecular Motors

Proteins that are responsible for coordinated movements in tissues and cells are referred to as molecular motors. These may be ATP driven as in the case of the contractile proteins; actin and myosin in muscle as well as dynein and tubulin in cilia and flagella. Kinesin, which mediates movement of vesicles on microtubules also requires ATP.

## TRANSPORT MECHANISMS

The permeability of substances across cell membrane is dependent on their solubility in lipids and not on their molecular size. Water-soluble compounds are generally impermeable and require carrier mediated transport. An important function of the membrane is to withhold unwanted molecules, while permitting entry of molecules necessary for cellular metabolism. Transport mechanisms are classified into:

1. **Passive transport**
  - A. **Simple diffusion**
  - B. **Facilitated diffusion**
  - C. **Ion channels** are specialized carrier systems. They allow passage of molecules in accordance with the concentration gradient.
2. **Active transport**
3. **Pumps** can drive molecules against the gradient using energy.

## Passive Transport

### Simple Diffusion

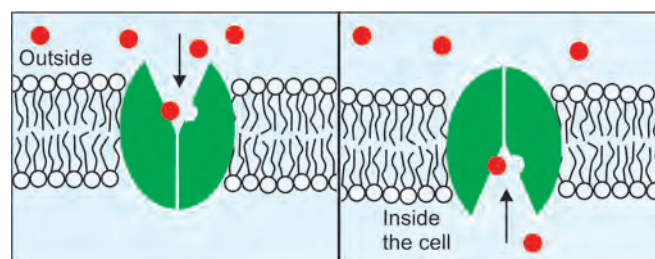
Solutes and gases enter into the cells passively. They are driven by the concentration gradient. The rate of entry is proportional to the solubility of that solute in the hydrophobic core of the membrane. Simple diffusion occurs from higher to lower concentration. This does not require any energy. However, it is a very slow process.

Diffusion of gases such as O<sub>2</sub>, CO<sub>2</sub>, NO and CO occurs at a rate that is solely dependent upon concentration gradients. Lipophilic molecules will also diffuse across membranes at a rate that is directly proportional to the solubility of the compound in the membrane.

### Facilitated Diffusion

This is a **carrier mediated process**. (Fig. 2.5). Important features of facilitated diffusion are:

- a. The carrier mechanism could be saturated which is similar to the V<sub>max</sub> of enzymes.
- b. Structurally similar solutes can competitively inhibit the entry of the solutes.
- c. Facilitated diffusion can operate bidirectionally.
- d. This mechanism does not require energy but the rate of transport is more rapid than simple diffusion process.
- e. The carrier molecules can exist in two conformations, **Ping and Pong states**. In the pong state, the active sites are exposed to the exterior, when the solutes bind to the specific sites. Then there is a conformational change. In the ping state, the active sites are facing the interior of the cell, where the concentration of the solute is minimal. This will cause the release of the solute molecules and the protein molecule reverts to the pong state. By this mechanism the inward flow is facilitated,



**Fig. 2.5:** Facilitated diffusion. The carrier molecule exists in two conformations



but the outward flow is inhibited (Fig. 2.5). **Hormones** regulate the number of carrier molecules. For example, glucose transport across membrane is by facilitated diffusion involving a family of **glucose transporters**. Glucose transport is described in detail in Chapter 9.

## Aquaporins

They are water channels (Fig. 2.6). They are a family of membrane channel proteins that serve as selective pores through which water crosses the plasma membranes of cells. They form tetramers in the cell membrane, and facilitate the transport of water. They control the water content of cells. Agre and MacKinnon were awarded Nobel Prize for Chemistry in 2003 for their contributions on aquaporins and ion channels. Diseases, such as nephrogenic diabetes insipidus are due to impaired function of these channels.

Aquaporins (AQP) are a family of channels responsible for the transport of water across membranes. At least 11 aquaporin proteins have been identified in mammals with 10 known in humans (termed AQP0 through AQP9). A related family of proteins is called aquaglyceroporins, which is involved in water transport as well as transport of other small molecules. AQP9 is the human aquaglyceroporin. Probably the most significant location of aquaporin expression is in the kidney. The



Peter Agre  
NP 2003  
b. 1949



Roderick  
MacKinnon  
NP 2003  
b.1956



Jen Skour  
NP 1997  
b. 1918

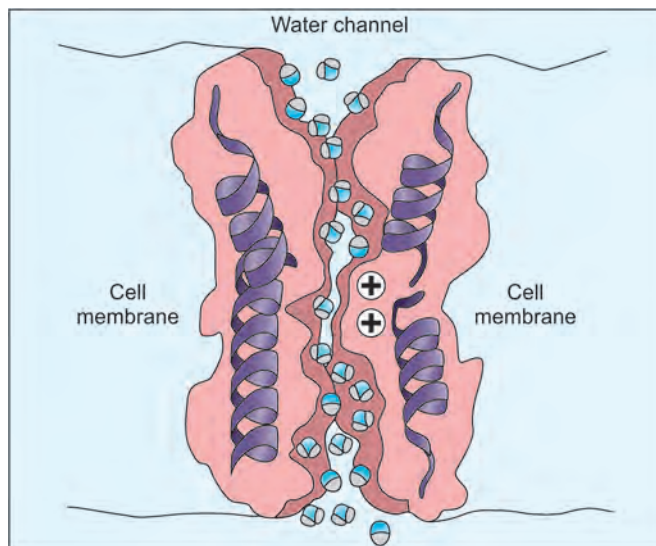


Fig. 2.6: Water channel or aquaporin

proximal tubule expresses AQP1, AQP7 and AQP8, while collecting duct expresses AQP2, AQP3, AQP4, AQP6 and AQP8. Loss of function of renal aquaporins is associated with several disease states; reduced expression of AQP2 is associated with nephrogenic diabetes insipidus (NDI), acquired hypokalemia and hypercalcemia.

**Channelopathies** are a group of disorders that result from abnormalities in the proteins forming the ion channels or regulatory proteins. Channelopathies may be acquired or congenital. Congenital channelopathies may occur due to genetic mutations in sodium, potassium, chloride and calcium channels. A few examples are Barter syndrome, myasthenia gravis, long and short QT syndromes, cystic fibrosis (chloride channel), Liddle's syndrome (sodium channel) periodic paralysis (potassium channel) and some types of deafness.

## Ion Channels

Membranes have special devices called ion channels (Fig. 2.9). Ion channels are transmembrane proteins that allow the selective entry of various ions. Salient features are enumerated in Box 2.4. These channels are for quick transport of electrolytes, such as  $\text{Ca}^{++}$ ,  $\text{K}^+$ ,  $\text{Na}^+$  and  $\text{Cl}^-$ . These are selective ion conductive pores. Ion channels are specialized protein molecules that span the membranes. The channels generally remain closed, but in response to stimulus, they open allowing rapid flux of ions down the gradient. This may be compared to opening of the gate of a cinema house, when people rush to enter in. Hence, this regulation is named as "gated". Such ion channels are important for nerve impulse propagation, synaptic transmission and secretion of biologically active substances from the cells. Ion channels are different from ion transport pumps described below.

## Ligand-Gated Channels

Ligand gated channels are opened by binding of effectors. The binding of a ligand to a receptor site on the channel

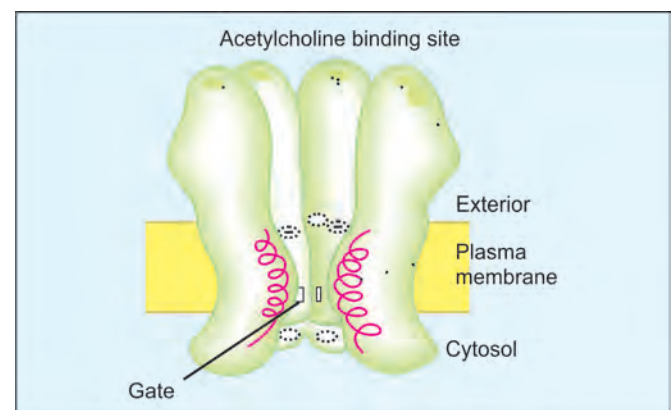


Fig. 2.7: Acetylcholine receptor

results in the opening (or closing) of the channel. The ligand may be an extracellular signaling molecule or an intracellular messenger. Clinical applications of channels are shown in Box 2.5.

- a. **Acetylcholine receptor** (Fig. 2.7) is the best example for ligand gated ion channel. It is present in post-synaptic membrane. It is a complex of 5 subunits, consisting of acetylcholine binding site and the ion channel. Acetylcholine released from the presynaptic region binds with the receptors on the postsynaptic region, which triggers opening of the channel and influx of  $\text{Na}^+$ . This generates an action potential in the postsynaptic nerve. The channel opens only for a millisecond, because the acetylcholine is rapidly degraded by acetylcholinesterase.
- b. **Calcium channels:** Under appropriate stimuli calcium channels are opened in the sarcoplasmic reticulum membrane, leading to an elevated calcium level in the cytosol of muscle cells. Calcium channel blockers

are therefore widely used in the management of hypertension.

- c. **Amelogenin**, a protein present in enamel of teeth has hydrophobic residues on the outside. A 27 amino acid portion of amelogenin functions as a calcium channel. Phosphorylation of a serine residue of the protein opens the calcium channel, through which calcium ions zoom through and are funneled to the mineralization front. The amelogenin is used for the formation of calcium hydroxy apatite crystals.

## Voltage-Gated Channels

Voltage-gated channels (Fig. 2.9) are opened by membrane depolarization. The channel is usually closed in the ground state. The membrane potential change (voltage difference) switches the ion channel to open, lasting less than 25 milliseconds.

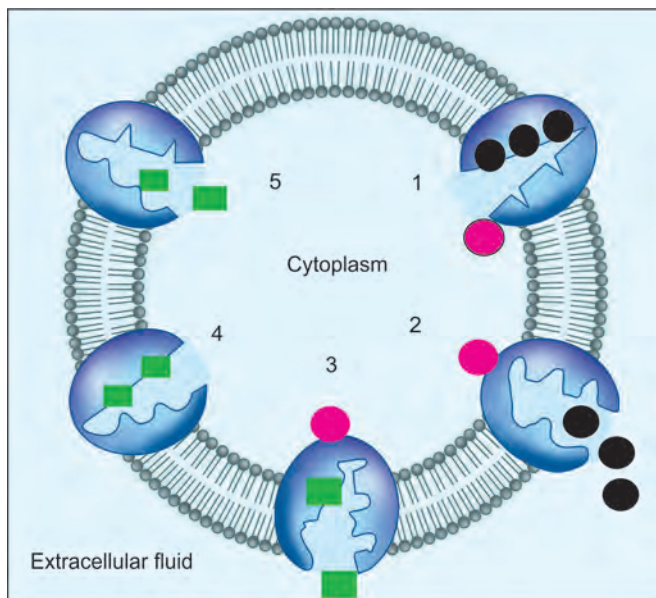
In voltage-gated channels, the channels open or close in response to changes in membrane potential. They pass from closed through open to inactivated state on depolarization. Once in the inactivated state, a channel cannot re-open until it has been reprimed by repolarization of the membrane.

Voltage-gated sodium channels and voltage gated potassium channels are the common examples. These are seen in nerve cells and are involved in the conduction of nerve impulses.

Ion channels allow passage of molecules in accordance with the concentration gradient. Ion pumps can transport molecules against the gradient.

## Ionophores

They are membrane shuttles for specific ions. They transport antibiotics. Ionophores increase the permeability of membrane to ions by acting as channel formers. The two types of ionophores are; mobile ion carriers (e.g. **Valinomycin**) and channel formers (e.g. **Gramicidin**). They are produced by certain microorganisms and are used as antibiotics. When cells of higher organisms are exposed to ionophores, the ion gradient is dissipated. Valinomycin allows potassium to permeate mitochondria and so it dissipates the proton gradient; hence, it acts as an uncoupler of electron transport chain (see Chapter 20).



**Fig. 2.8:** The sodium potassium pump. It brings sodium ions out of the cells and potassium ions into the cells. Black circle = sodium ion; green square = potassium ion; pink circle = phosphate. (1) Cytoplasmic sodium ions (3 numbers) bind to the channel protein. This favors phosphorylation of the protein along with hydrolysis of ATP; (2) Phosphorylation causes the protein to change conformation, expelling the sodium ions across the membrane; (3) Simultaneously, extracellular potassium ions (2 numbers) bind to the carrier protein. Potassium binding leads to release of phosphate group; (4) So, original conformation is restored; (5) Potassium ions are released into the cytoplasm. The cycle repeats

### Box 2.4: Salient features of Ion channels

1. They are transmembrane proteins
2. Selective for one particular ion
3. Regulation of activity is done by voltage-gated, ligand-gated or mechanically-gated mechanisms
4. Different channels are available for  $\text{Na}^+$ ,  $\text{K}^+$ ,  $\text{Ca}^{++}$  and  $\text{Cl}^-$
5. Transport through the channel is very quick



## Active Transport

The salient features of active transport are:

- This form of transport **requires energy**. About 40% of the total energy expenditure in a cell is used for the active transport system.
- The active transport is unidirectional.
- It requires specialized integral proteins called **transporters**.
- The transport system is saturated at higher concentrations of solutes.
- The transporters are susceptible to inhibition by specific organic or inorganic compounds. General reaction is depicted in Figures 2.8 and 2.9.

### Sodium Pump

It is the best example for active transport. **Cell has low intracellular sodium**; but concentration of potassium inside the cell is very high. This is maintained by **sodium-potassium activated ATPase**, generally called as sodium

#### Box 2.5: Clinical applications of channels

- Sodium channels:** Local anesthetics such as **procaine** act on sodium channels both as blockers and on gating mechanisms to hold the channel in an inactivated state. Point mutation in sodium channel leads to myotonia, characterized by increased muscle excitability and contractility.
- In **Liddle's disease**, the sodium channels in the renal epithelium are mutated, resulting in excessive sodium reabsorption, water retention and elevated blood pressure.
- Potassium channel** mutations in "**Long QT syndrome**" leads to inherited cardiac arrhythmia, where repolarization of the ventricle is delayed, resulting in prolonged QT intervals in ECG. Potassium channel blockers are used in cardiac arrhythmias and potassium channel openers as smooth muscle dilators.
- Chloride channels:** The role of GABA and glycine as inhibitory neurotransmitters is attributed to their ability to open the chloride channels at the postsynaptic membranes.
- Cystic fibrosis** is due to certain mutations in the CFTR gene (cystic fibrosis transmembrane regulator protein), which is a chloride transporting ABC protein.
- Retina:** The excitation of retinal rods by a photon is by closing of cation specific channels resulting in hyperpolarization of the rod cell membrane. This light induced hyperpolarization is the major event in visual excitation (see Chapter 36).
- Barter syndrome** is due to mutations in potassium and chloride channels in the renal tubules, especially the ascending limb. The condition is characterized by hypokalemia and alkalosis and loss of chloride and potassium in urine.
- Calcium channel** blockers are used in the treatment of hypertension.

pump. The ATPase is an integral protein of the membrane (Fig. 2.8). Jen Skou was awarded Nobel Prize in 1997 for his work on Sodium-Potassium-ATPase. It has binding sites for ATP and sodium on the inner side and the potassium binding site is located outside the membrane. It is made up of two pairs of unequal subunits alpha-2 beta-2. Both subunits of the pump (alpha and beta) span the whole thickness of membrane. Details are shown in Figure 2.8. Clinical applications of sodium pump are shown in Box 2.6. There are four different types of ATPases, three that transport cations and one that transports anions.

A-type ATPases transport anions.

P-type ATPases are mostly found in the plasma membrane and are involved in the transport of  $H^+$ ,  $K^+$ ,  $Na^+$ ,  $Ca^{2+}$ ,  $Cd^{2+}$ ,  $Cu^{2+}$  and  $Mg^{2+}$ .

F-type ATPases function in the translocation of  $H^+$  in the mitochondria during the process of oxidative phosphorylation.

V-type ATPases are located in acidic vesicles and lysosomes and have homology to the F-type ATPases.

### Calcium Pump

An ATP dependent calcium pump also functions to regulate muscle contraction. A specialized membrane system called sarcoplasmic reticulum is found in skeletal muscles, which regulates the  $Ca^{++}$  concentration around muscle fibers.

In resting muscle the concentration of  $Ca^{++}$  around muscle fibers is low. But stimulation by a nerve impulse results in a sudden release of large amounts of  $Ca^{++}$ . This would trigger muscle contraction. The function of calcium pump is to remove cytosolic calcium and maintain low cytosolic concentration, so that muscle can receive the next signal. For each ATP hydrolyzed,  $2Ca^{++}$  ions are transported.

## Uniport, Symport and Antiport

Transport systems are classified as uniport, symport and antiport systems (Fig. 2.9).

#### Box 2.6: Clinical applications of sodium pump

The use of cardiotonic drugs like digoxin and ouabain was prompted by the use of the leaves of the plant foxglove by natives. They bind to the alpha-subunit and act as competitive inhibitor of potassium ion binding to the pump. Inhibition of the pump leads to an increase in  $Na^+$  level inside the cell and extrusion of  $Ca^{++}$  from the myocardial cell. This would enhance the contractility of the cardiac muscle and so improve the function of the heart. These drugs are now rarely used.

1. **Uniport system** carries single solute across the membrane, e.g. **glucose** transporter in most of the cells. Calcium pump is another example.
2. If the transfer of one molecule depends on simultaneous or sequential transfer of another molecule, it is called **co-transport** system. The active transport may be coupled with energy indirectly. Here, movement of the substance against a concentration gradient is coupled with movement of a second substance down the concentration gradient; the second molecule being already concentrated within the cell by an energy requiring process.
3. The cotransport system may either be a symport or an antiport. In **symport**, (Fig. 2.9) the transporter carries two solutes in the same direction across the membrane, e.g. sodium dependent glucose transport (see Chapter 9). **Phlorhizin**, an inhibitor of sodium-dependent cotransport of glucose, especially in the proximal convoluted tubules of kidney, produces renal damage and results in renal glycosuria. Amino acid transport is another example for symport.
4. **The antiport** system (Fig. 2.9) carries two solutes or ions in opposite direction, e.g. **sodium pump** (Fig. 2.7) or chloride-bicarbonate exchange in RBC (see Chapter 22). Features of different types of transport modalities are summarized in Table 2.3.

### Clinical Applications

In **Hartnup's disease**, transport mechanism for amino acids are defective in intestine and renal tubules (see Chapter 18). In cystinuria, renal reabsorption of cystine is abnormal (see Chapter 16). Renal reabsorption of phosphate is decreased in **vitamin D** resistant rickets (see Chapter 36).

### Endocytosis

Endocytosis is the mechanism by which cells internalize extracellular macromolecules, to form an endocytic vesicle. This requires energy in the form of ATP as well as calcium ions in the extracellular fluid. Cytoplasmic contractile elements take part in this movement. In general, plasma membrane is invaginated, enclosing the matter. This forms the **endocytic vesicle** (Fig. 2.10). The endocytosis may either be pinocytosis or phagocytosis.

### Pinocytosis

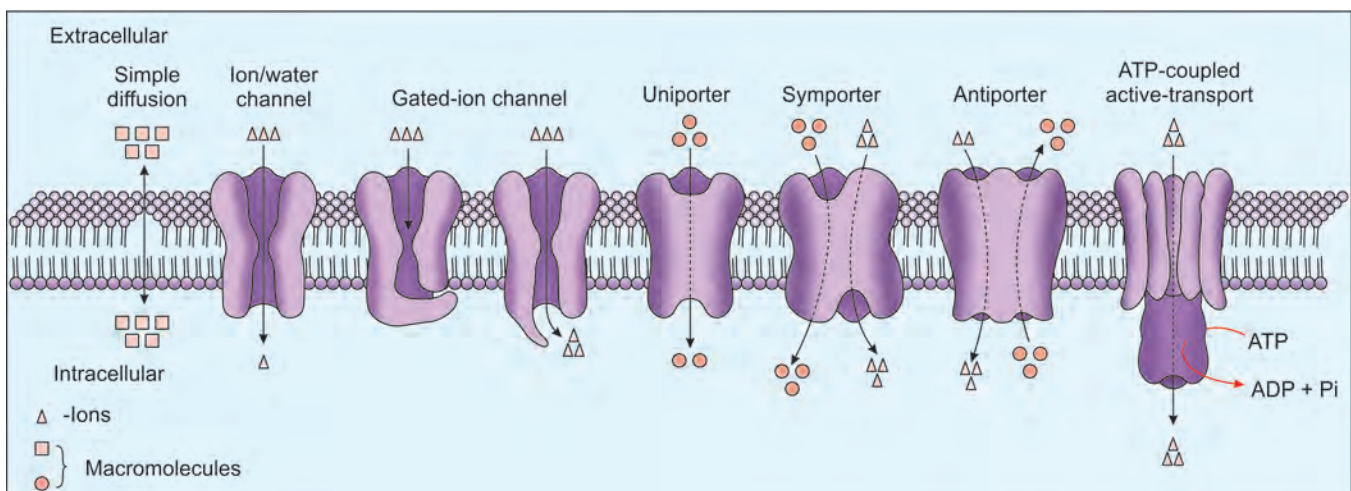
Pinocytosis literally means 'drinking by the cell'. Cells take up fluid by this method. The fluid phase pinocytosis is a nonselective process.

### Receptor-Mediated Endocytosis

The selective or adsorptive pinocytosis is **receptor-mediated**; also called as **absorptive pinocytosis**. Low density lipoprotein (LDL) is a good example. LDL binds to the LDL receptor and the complex is later internalized. The cytoplasmic side of these vesicles are coated with filaments; mainly composed of Clathrin. These are called **Clathrin coated pits**. Absorption of cholesterol by clathrin coated pit is shown in

**TABLE 2.3:** Types of transport mechanisms

	Carrier	Against gradient	Energy required	Examples
Simple diffusion	no	no	nil	water
Facilitated diffusion	yes	no	nil	glucose to RBCs
Primary active	yes	yes	directly	sodium pump
Secondary active	yes	yes	indirect	glucose to intestine
Ion channels	yes	no	no	sodium channel



**Fig. 2.9:** Different types of transport systems

Chapter 13. After the LDL-receptor complex is internalized, the receptor molecules are released back to cell surface; but the LDL is degraded by lysosomal enzymes. Several hormones are also taken up by the cells by receptor-mediated mechanism. The protein, **Dynamin** which has GTPase activity, is necessary for the internalization of clathrin coated pits. Many viruses get attached to their specific receptors on the cell membranes. Examples are Influenza virus, Hepatitis B virus, polio virus and HIV. They are taken up by caveolae-mediated processes. Caveolae-mediated endocytosis is also known as **potocytosis**.

### Secretory Vesicles and Exocytosis

Under appropriate stimuli, the secretory vesicles or vacuoles move towards and fuse with the plasma membrane. This movement is created by cytoplasmic contractile elements; the microtubule system. The inner membrane of the vesicle fuses with outer plasma membrane, while cytoplasmic side of vesicle fuses with cytoplasmic side of plasma membrane. Thus the contents of vesicles are externalized. This process is called exocytosis or reverse pinocytosis. Release of trypsinogen by pancreatic acinar cells; release of insulin by beta cells of Langerhans and release of acetylcholine by presynaptic cholinergic nerves are examples of exocytosis (Fig. 2.11). Often, hormones are the signal for exocytosis, which leads to calcium ion changes, triggering the exocytosis.

The most important vesicles are those that contain secreted factors. Membrane bound proteins (e.g. growth factor receptors) are processed as they transit through the ER to Golgi apparatus and finally to the plasma membrane. As these proteins transit to the surface of the cell they undergo a series of processing events that includes glycosylation. The vesicles that pinch off from the Golgi apparatus are termed coated vesicles. The membranes of coated vesicles are surrounded by specialized scaffolding proteins that will interact with the extracellular environment. Clathrin coated vesicles contain clathrin and are involved in transmembrane protein, G1I linked protein and secreted protein transit to plasma membrane. They are also involved in endocytosis (e.g. LDL uptake).

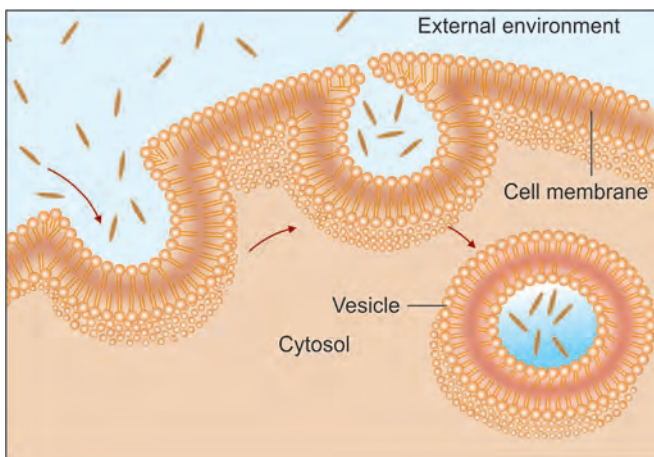


Fig. 2.10: Endocytosis

### Phagocytosis

The term is derived from the Greek word “phagein” which means to eat. It is the engulfment of large particles such as bacteria by **macrophages and granulocytes**. They extend pseudopodia and surround the particles to form **phagosomes**. Phagosomes later fuse with lysosomes to form phagolysosomes, inside which the particles are digested. An active macrophage can ingest 25% of their volume per hour. In this process, 3% of plasma membrane is internalized per minute. The biochemical events accompanying phagocytosis is described as **respiratory burst** (see Chapter 33).

### Transcytosis

This is a transport process for macromolecules across cells especially epithelial cells; Ig A, transferrin and insulin are some of the molecules thus transported. Transcytosis may be caveolae-mediated. The process has been implicated in the entry of pathogens into intestinal mucosal cells and across the blood brain barrier. This process may be an effective mechanism for targeted drug delivery, especially antibodies and similar macromolecules.

### The ABC Family of Transporters

ATP-binding cassette transporters superfamily: All members of this superfamily of membrane proteins contain a conserved ATP-binding domain and use the energy of ATP hydrolysis to drive the transport of various molecules across all cell membranes. There are 48 known members of this superfamily and they are divided into seven sub-families designated as ABCA through ABCG.

ABCA1 is involved in the transport of cholesterol out of cells when HDLs are bound to their cell surface receptor, SR-B1.

ABCB4 is a member of the P-glycoprotein family of multidrug resistance transporters. Defects in ABCB4 gene are associated with familial intrahepatic cholestasis type 3 (PFIC3), adult biliary cirrhosis, and intrahepatic cholestasis.

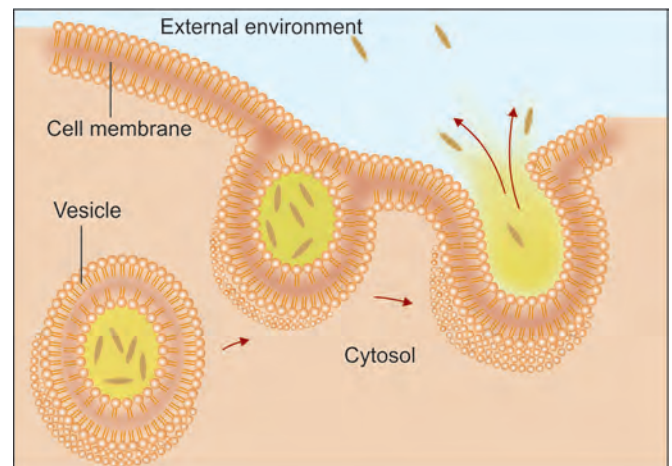


Fig. 2.11: Exocytosis

ABCB7 is involved in iron homeostasis. Defects in the gene are associated with X-linked sideroblastic anemia with ataxia (XSAT).

ABCC2 is also called multidrug resistance associated protein 2 (MRP2). Defects in the gene encoding ABCC2 result in Dubin-Johnson's syndrome, a type of conjugated hyperbilirubinemia.

ABCD1 is involved in the import and/or anchoring of very long chain fatty acyl CoA synthetase (VLCFA-CoA synthetase) to the peroxisome. Defects result in X-linked adrenoleukodystrophy (XALD).

ATP7A and ATP7B are copper transporting ATPases that are related to SLC31A1. Defects in ATP7A result in Menkes disease and defects in ATP7B are associated with Wilson's disease.

SLC11A2 which is also known as DMT1 (divalent metal ion transporter) is involved in uptake of iron by the apical surface of the duodenum. In addition to iron, DMT1 is involved in manganese, cobalt, cadmium, nickel, copper and zinc transport. Defects in DMT1 activity are associated with hypochromic microcytic anemia with iron overload.

Abnormalities in SLC30A8 result in impaired pancreatic  $\beta$  cell function leading to defects in insulin secretion. SLC35C1 is fucose transporter, defects in which result in congenital disorder of glycosylation (CDG) syndrome. Examples are leukocyte adhesion deficiency syndrome II (LAD II) leading to immunodeficiency and mental retardation.

SLC40A1 is also known as ferroportin or insulin-regulated gene 1 (IREG1). It is required for the transport of dietary iron across basolateral membranes of intestinal enterocytes. Defects in SLC40A1 gene are associated with type 4 hemochromatosis.

## ■ QUICK LOOK OF CHAPTER 2

- In a cell, biomolecules are maintained in a state of 'dynamic' or 'steady state' equilibrium.
- Cell organelles can be separated by density gradient ultracentrifugation.
- All cells in the body contain nucleus except mature erythrocytes.
- Endoplasmic reticulum is involved in protein synthesis and also detoxification of various drugs.
- Golgi apparatus is primarily involved in glycosylation, protein sorting, packaging and secretion.
- Lysosomes are the 'suicide' bags, which contain many hydrolyzing enzymes.
- Mitochondria, the 'power house' of the cell has its own DNA, can synthesize its own proteins. It is sometimes referred to as 'mini cell'.
- Antibiotics inhibiting bacterial protein biosynthesis can inhibit mitochondrial protein biosynthesis also.
- Membranes are mainly composed of lipids (phospholipids), proteins and a small percentage of carbohydrates.
- Phospholipids, which are amphipathic in nature, are arranged as bilayers.
- Cholesterol content and nature of the fatty acid of the membrane, influences the fluidity.
- Membrane proteins can be integral, peripheral or transmembrane.
- Transmembrane proteins serve as receptors, tissue specific antigens, ion-channels, etc.
- Transport of molecules across the plasma membrane could be energy dependent (active) or energy independent (passive).
- Ion-channels function for the transport of the ions, such as  $\text{Ca}^{2+}$ ,  $\text{K}^+$ ,  $\text{Cl}^-$ ,  $\text{Na}^+$ , etc.
- Ionophores or transport antibiotics increase permeability of membranes by acting as channel formers. They could be mobile ion carriers (e.g. valinomycin) or channel formers (e.g. gramicidin).
- $\text{Na}^+ \text{K}^+$  ATPase (sodium pump) is an example of active transport. Cardiotonic drugs like Digoxin and Ouabain competitively inhibit  $\text{K}^+$  ion binding. The property is used to enhance contractility of the cardiac muscle.
- Transport systems may be Uniport, Antiport or Symport.



# CHAPTER 3

## Amino Acids: Structure and Properties

### Chapter at a Glance

The reader will be able to answer questions on the following topics:

- Classification of amino acids based on structure
- Based on side chain character
- Based on metabolic fate
- Based on nutritional requirements
- Isoelectric point
- Reactions due to carboxyl group
- Reactions due to amino group
- Reactions of SH group
- Peptide bond formation

Proteins are of paramount importance in biological systems. All the major structural and functional aspects of the body are carried out by protein molecules. All proteins are polymers of amino acids. Proteins are composed of a number of amino acids linked by peptide bonds.

Although about 300 amino acids occur in nature, only 20 of them are seen in human body. Most of the amino acids (except proline) are **alpha amino acids**, which means that the amino group is attached to the same carbon atom to which the carboxyl group is attached (Fig. 3.1).

### CLASSIFICATION OF AMINO ACIDS

#### Based on Structure

- A. **Aliphatic amino acids**
  - a. **Monoamino monocarboxylic acids:**
    - Simple amino acids: Glycine, Alanine (Fig. 3.2)
    - Branched chain amino acids: Valine, Leucine, Isoleucine (Fig. 3.3)
    - Hydroxyamino acids: Serine, Threonine (Fig. 3.4.)
    - Sulfur-containing amino acids: Cysteine, Methionine (Fig. 3.5)
    - Amino acids with amide group: Asparagine, Glutamine (Fig. 3.6).
  - b. **Monoamino dicarboxylic acids:** Aspartic acid, Glutamic acid (Fig. 3.7).
  - c. **Dibasic monocarboxylic acids:** Lysine, Arginine (Fig. 3.8).
- B. **Aromatic amino acids:** Phenylalanine, Tyrosine (Fig. 3.9).
- C. **Heterocyclic amino acids:** Tryptophan (Fig. 3.10), Histidine (Fig. 3.11).
- D. **Imino acid:** Proline (Fig. 3.11).

### E. Derived amino acids:

- i. **Derived amino acids found in proteins:** After the synthesis of proteins, some of the amino acids are modified, e.g. hydroxy proline (Fig. 3.12) and hydroxy lysine are important components of collagen. Gamma carboxylation of glutamic acid residues of proteins is important for clotting process (Fig. 3.12). In ribosomal proteins and in histones, amino acids are extensively methylated and acetylated.
- ii. **Derived amino acids not seen in proteins** (Non-protein amino acids): Some derived amino acids are seen free in cells, e.g. Ornithine (Fig. 3.12), Citrulline, Homocysteine. These are produced during the metabolism of amino acids. Thyroxine may be considered as derived from tyrosine.
- iii. **Non-alpha amino acids:** Gamma amino butyric acid (GABA) is derived from glutamic acid. Beta alanine, where amino group is in beta position, is

a constituent of pantothenic acid (vitamin) and co-enzyme A.

Each amino acid will have three-letter and one-letter abbreviations which are shown in Table 3.1 as well as in Figures 3.2 to 3.11. Sometimes asparagine/aspartic acid may not be separately identified, for which 3-letter abbreviation is Asx and 1-letter abbreviation is B. Similarly Glx or Z stands for glutamine/glutamic acid.



Fig. 3.4: Hydroxyamino acids

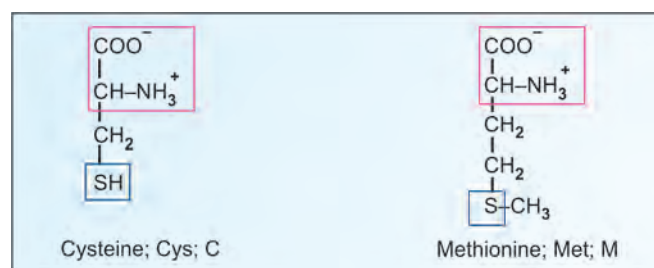


Fig. 3.5: Sulfur-containing amino acids



Fig. 3.6: Amino acids with amide groups

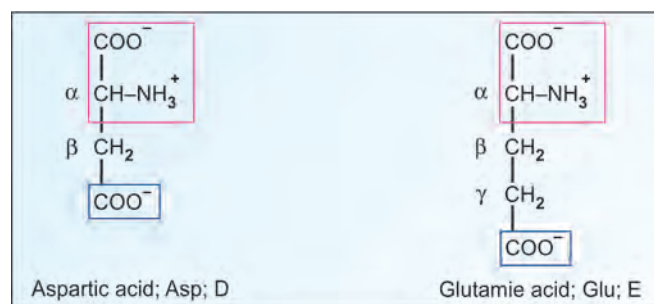


Fig. 3.7: Dicarboxylic amino acids

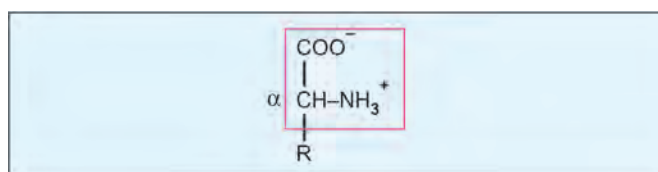


Fig. 3.1: General structure

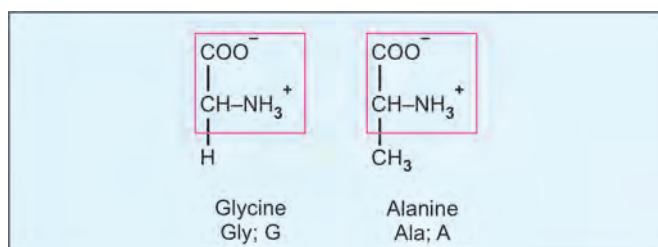


Fig. 3.2: Simple amino acids

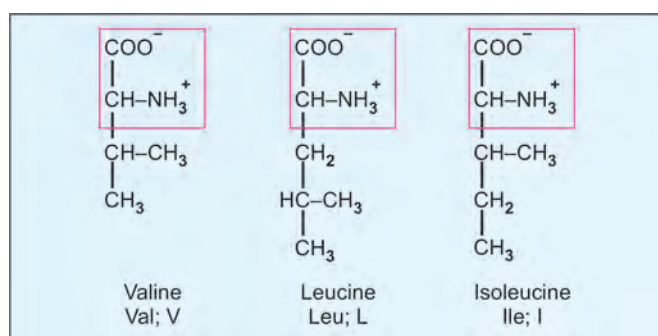


Fig. 3.3: Branched chain amino acids

### Special Groups in Amino Acids

In the figures, special groups are shaded. Arginine contains **guanidinium** group; Phenylalanine (**benzene**); Tyrosine (**phenol**); Tryptophan (**indole**); Histidine (**imidazole**); and Proline (**pyrrolidine**) (Table 3.1). Proline has a secondary amino group, and hence it is an **imino acid**.

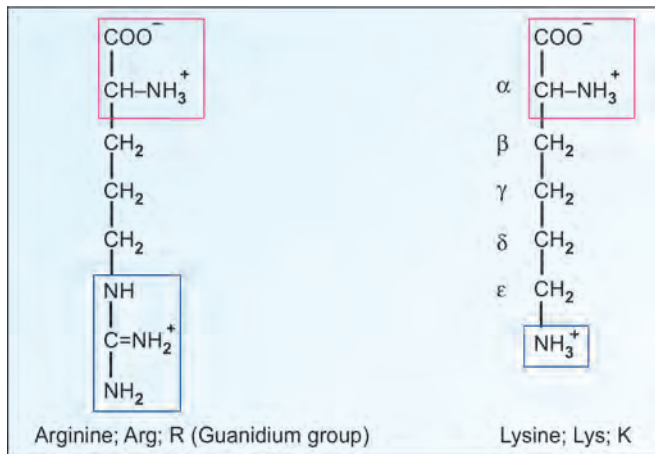


Fig. 3.8: Dibasic amino acids

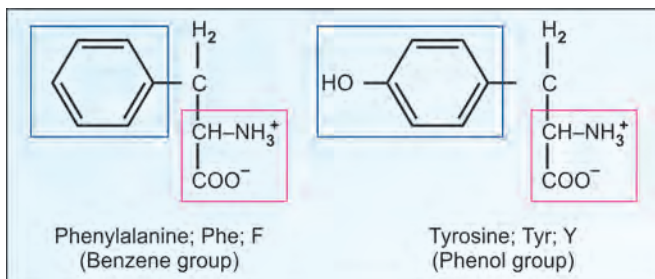


Fig. 3.9: Aromatic amino acids

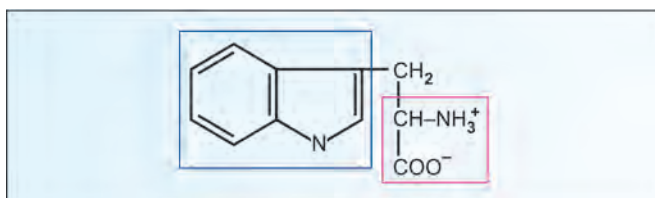


Fig. 3.10: Tryptophan (Trp) (W) with indole group

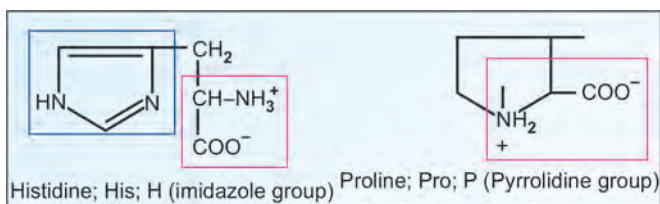


Fig. 3.11: Histidine and proline

### Based on Side Chain

- A. **Amino acids having non-polar side chains:** These include Alanine, Valine, Leucine, Isoleucine, Methionine, Proline, Phenylalanine and Tryptophan. These groups are **hydrophobic** (water repellent) and lipophilic. Therefore, the parts of proteins made up of these amino acids will be hydrophobic in nature.
- B. **Amino acids having uncharged or non-ionic polar side chains:** Glycine, Serine, Threonine, Cysteine, Tyrosine, Glutamine and Asparagine belong to this group. These amino acids are **hydrophilic** in nature.

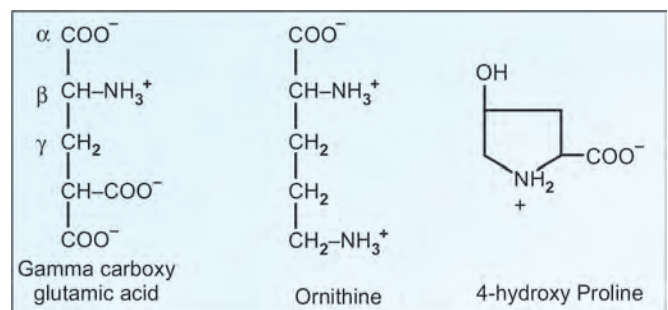


Fig. 3.12: Some derived amino acids

TABLE 3.1: Common amino acids

Name of amino acid	Special group present	3-letter abbreviation	1-letter abbreviation	Molecular weight
Glycine		Gly	G	77
Alanine		Ala	A	89
Valine		Val	V	117
Leucine		Leu	L	131
Isoleucine		Ile	I	131
Serine	Hydroxyl	Ser	S	105
Threonine	Hydroxyl	Thr	T	119
Cysteine	Sulfhydryl	Cys	C	121
Methionine	Thioether	Met	M	149
Asparagine	Amide	Asn	N	132
Glutamine	Amide	Gln	Q	146
Aspartic acid	$\beta$ -carboxyl	Asp	D	133
Glutamic acid	$\gamma$ -carboxyl	Glu	E	147
Lysine	$\epsilon$ -amino	Lys	K	146
Arginine	Guanidinium	Arg	R	174
Phenylalanine	Benzene	Phe	F	165
Tyrosine	Phenol	Tyr	Y	181
Tryptophan	Indole	Trp	W	204
Histidine	Imidazole	His	H	155
Proline (imino acid)	Pyrrolidine	Pro	P	115

(Tyrosine and Cysteine may show hydrophobic character when present in the interior of the protein).

- C. **Amino acids having charged or ionic polar side chains (hydrophilic):**
- Acidic amino acids:** They have a negative charge on the R group: Aspartic acid and Glutamic acid. (Tyrosine is mildly acidic).
  - Basic amino acids:** They have a positive charge on the R group: Lysine, Arginine and Histidine.

### Based on Metabolism

- Purely ketogenic:** Leucine is purely ketogenic because it is converted to ketone bodies (see Fig.18.16).
- Ketogenic and glucogenic:** Lysine, Isoleucine, Phenylalanine, Tyrosine and Tryptophan are partially ketogenic and partially glucogenic. During metabolism, part of the carbon skeleton of these amino acids will enter the ketogenic pathway and the other part to glucogenic pathway (see Fig.18.16).
- Purely glucogenic:** All the remaining 14 amino acids are purely glucogenic as they enter only into the glucogenic pathway (see Chapter 18).

### Based on Nutritional Requirements

- Essential or indispensable:** The amino acids may further be classified according to their essential nature for growth. Thus, **Isoleucine, Leucine, Threonine, Lysine, Methionine, Phenylalanine, Tryptophan, and Valine** are essential amino acids. Their carbon skeleton cannot be synthesized by human beings and so preformed amino acids are to be taken in food for normal growth. Normal growth and optimal health will not occur, if one such amino acid is deficient in the diet. See memory aid in Box 3.1.
- Partially essential or Semiessential: Histidine and Arginine** are semi-indispensable amino acids.

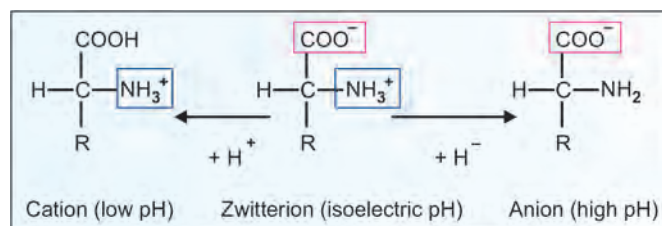


Fig. 3.13: Ionic forms of amino acids

Growing children require them in food. But they are not essential for the adult individual.

- Non-essential or Dispensable:** The remaining 10 amino acids are non-essential, because their carbon skeleton **can be synthesized** by the body. So we need not have to ingest these amino acids as such. However, they are also required for normal protein synthesis. The non-essential amino acids are Alanine, Asparagine, Aspartic acid, Cysteine, Glutamine, Glutamic Acid, Glycine, Proline, Serine and Tyrosine. All body proteins do contain all the non-essential amino acids.
- Conditionally essential amino acids:** When a person is suffering from a moderate to severe chronic illness, person may lose the ability to manufacture enough non-essential amino acids and thus require supplementation. Problems with digestion will also necessitate supplementation of “non-essential” amino acids. These amino acids are normally non-essential, but become essential during times of physiological stress. Then these amino acids have to be taken in food or through supplements. These conditionally essential amino acids are Arginine, Glycine, Cysteine, Tyrosine, Proline, Glutamine and Taurine.

### Naming (numbering) of Carbon Atoms

Carbon atoms in amino acids in sequence are named with letters of Greek alphabets, starting from the carbon atom to which carboxyl group is attached. As examples, naming of glutamic acid is shown in Figure in 3.7 and that of lysine is shown in Figure 3.8.

## PROPERTIES OF AMINO ACIDS

Glycine, alanine, valine, serine, tryptophan, histidine and proline are sweet in taste; leucine is tasteless; while isoleucine and arginine are bitter. Sodium glutamate is a

### Box 3.1: Memory aid for essential amino acids

"Any Help In Learning These Little Molecules Proves Truly Valuable"

This stands for

Arginine, Histidine, Isoleucine, Leucine, Threonine, Lysine, Methionine, Phenylalanine, Tryptophan and Valine in that order.

Arginine and Histidine are semi-essential amino acids; while others are essential.



flavoring agent. Aspartame, an artificial sweetener contains aspartic acid and phenylalanine. All amino acids have high melting points (more than 200°C). All amino acids are soluble in water and alcohol (polar solvents); but insoluble in non-polar solvents (benzene).

## Ampholyte and Isoelectric Point

1. Amino acids can exist as **ampholytes** or **zwitterions** (German word “zwitter” = hybrid) in solution, depending on the pH of the medium.
2. **The pH at which the molecule carries no net charge is known as isoelectric point or isoelectric pH (pI).**
3. In **acidic solution**, they are **cationic** in form and in alkaline solution they behave as anions (Fig. 3.13).
4. At isoelectric point, the amino acid will carry no net charge; all the groups are ionized but the charges will cancel each other. Therefore, at isoelectric point, there is **no mobility in an electrical field**. Solubility and buffering capacity will be minimum at isoelectric pH.

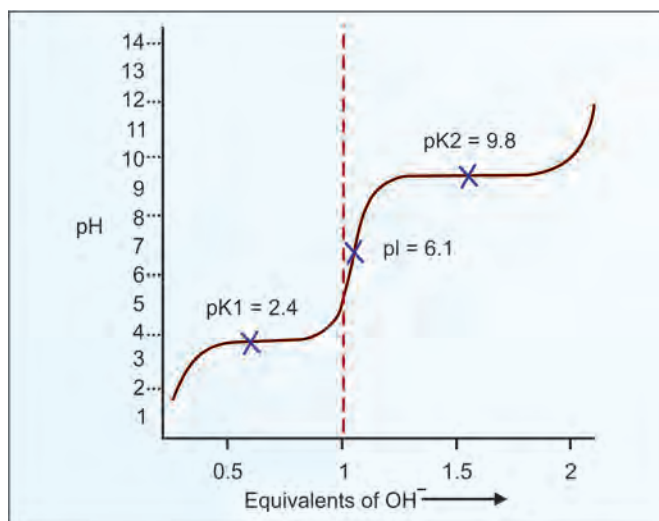


Fig. 3.14: Titration curve of glycine; pH in Y-axis

5. To such a solution if we add hydrochloric acid drop by drop, at a particular pH, 50% of the molecules are in cation form and 50% in zwitterion form. This pH is pK<sub>1</sub> (with regard to COOH). If more HCl is added, more molecules become cationic in nature and solubility increases.
6. On the other hand, if we titrate the solution from isoelectric point with NaOH, molecules acquire the anionic form. When 50% of molecules are anions, that pH is called pK<sub>2</sub> (with respect to NH<sub>2</sub>).
7. The isoelectric pH (pI) for monoamino monocarboxylic amino acids can be calculated:

$$pI = \frac{pK_1 + pK_2}{2}$$

$$\text{As for example, pI of glycine} = \frac{2.4 + 9.8}{2} = 6.1$$

8. From the graph it is evident that the buffering action is maximum in and around pK<sub>1</sub> or at pK<sub>2</sub> and minimum at pI (Fig. 3.14)
9. In the case of amino acids having more than two ionizable groups, correspondingly there will be more pK values, e.g. Aspartic acid (Fig. 3.15). The pK values of amino acids are given in Table 3.2. From these values, it can be seen that **at physiological pH of 7.4, both carboxyl and amino groups of amino acids are completely ionized**. Thus to be very correct, zwitterion forms are to be shown as the structures of amino acids.
10. The pK value of imidazolium group of **Histidine** is 6.1, and therefore effective as a buffer at the physiological pH of 7.4. The buffering capacity of plasma proteins and hemoglobin is mainly due to histidine residue.

## Optical Activity

1. Amino acids having an asymmetric carbon atom exhibit optical activity. **Asymmetry** arises when 4

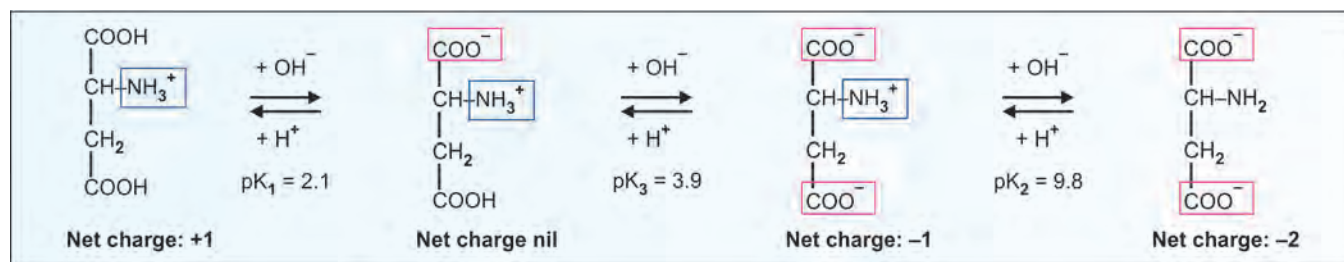


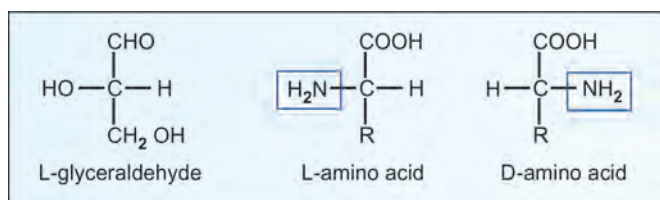
Fig. 3.15: Ionization of aspartic acid

different groups are attached to the same carbon atom (Fig. 3.16).

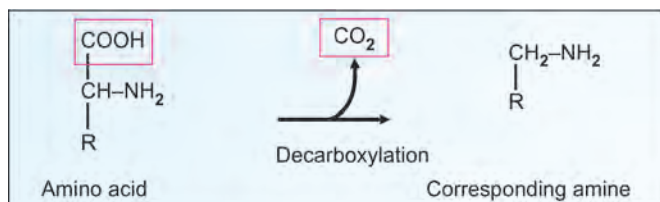
- Glycine is the simplest amino acid and has no asymmetric carbon atom and therefore, shows no optical activity. All others are optically active.
- The mirror image forms produced with reference to the alpha carbon atom, are called **D and L isomers**.
- The L-amino acids occur in nature and are therefore called **natural amino acids**. D-amino acids are seen in small amounts in micro-organisms and as constituents

**TABLE 3.2:** pK values of amino acids

Name of amino acid	pK1 of alpha carboxy group	pK2 of alpha amino group	pK3 of extra ionizable group	Extra ionizable group present	pI
Glycine	2.4	9.8	6.1		
Valine	2.3	9.6	6.0		
Serine	2.2	9.2	5.7		
Cysteine	1.9	10.3	8.2	Sulfhydryl	5.1
Glutamine	2.2	9.1	5.6		
Aspartic acid	2.1	9.8	3.9	Beta carboxyl	3.0
Glutamic acid	2.2	9.6	4.3	$\gamma$ -carboxyl	3.2
Lysine	2.2	8.9	10.5	$\epsilon$ -amino	9.7
Arginine	2.0	9.0	12.5	Guanidinium	10.8
Phenylalanine	2.6	9.2	5.9		
Tyrosine	2.2	9.1	10.1	Phenol	5.7
Tryptophan	2.4	9.4	5.9		
Histidine	1.8	9.2	6.1	Imidazole	7.6



**Fig. 3.16:** L and D amino acids



**Fig. 3.17:** Decarboxylation of amino acid

of certain antibiotics such as Gramicidin-S, Polymyxin, Actinomycin-D and Valinomycin, as well as bacterial cell wall peptidoglycans. D-amino acids have multiple functions in bacteria, like synthesis of cross-links in cell wall.

- Isoleucine and Threonine have 2 optically active centers and therefore each has 4 diastereoisomers.

### Sorensen's Formal Titration

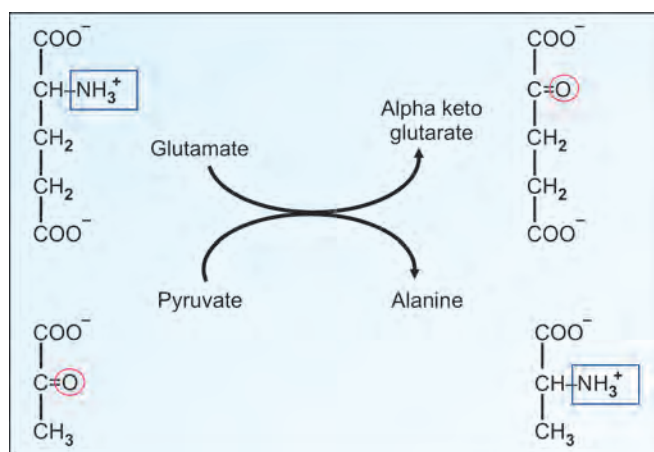
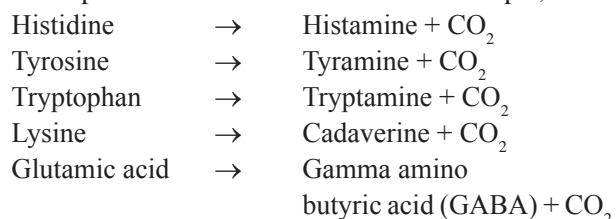
Amino acids cannot be exactly titrated. If, for example, 1 mL of 1N solution of glycine is titrated against 1N sodium hydroxide, the alkali requirement will be less than 1 mL. This is because hydrogen ions released by ionization of carboxyl group are partly taken up by the amino group. To circumvent this problem, excess formaldehyde is added to the solution, which converts amino group into neutral dimethylol derivative. Thereafter, titration can be completed to the end point. In the above example, after addition of formaldehyde, exactly 1 mL of 1N sodium hydroxide is utilized in the titration.

## GENERAL REACTIONS OF AMINO ACIDS

### Due to Carboxyl Group

#### Decarboxylation

The amino acids will undergo alpha decarboxylation to form the corresponding amine (Fig. 3.17). Thus, some important amines are produced from amino acids. For example,



**Fig. 3.18:** Transamination reaction

### Amide Formation

The -COOH group of dicarboxylic amino acids (other than alpha carboxyl) can combine with ammonia to form the corresponding amide. For example,



These amides are also components of protein structure. The amide group of glutamine serves as the source of nitrogen for nucleic acid synthesis.

### Due to Amino Group

#### Transamination

The alpha amino group of amino acid can be transferred to alpha keto acid to form the corresponding new amino acid and alpha keto acid (Fig. 3.18). This is an important reaction in the body for the interconversion of amino acids and for **synthesis of non-essential amino acids**.

#### Oxidative Deamination

The alpha amino group is removed from the amino acid to form the corresponding keto acid and ammonia (see Fig.14.9). In the body, **Glutamic acid** is the most common amino acid to undergo oxidative deamination.

#### Formation of Carbamino Compound

Carbon dioxide adds to the alpha amino group of amino acids to form carbamino compounds. The reaction occurs at alkaline pH and serves as a mechanism for the transport of carbon dioxide from tissues to the lungs by hemoglobin (see Chapter 22).

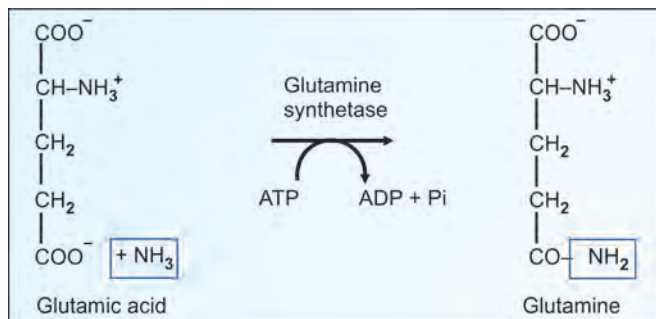
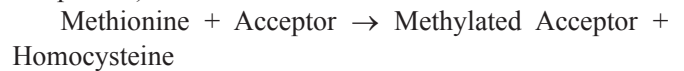


Fig. 3.19: Formation of glutamine

### Due to Side Chains

#### Transmethylation

The methyl group of Methionine, after activation, may be transferred to an acceptor, which becomes methylated (see Chapter 16).



#### Ester Formation by the OH Group

The hydroxy amino acids can form esters with phosphoric acid. In this manner, the **Serine and Threonine** residues of proteins are involved in the formation of phosphoproteins. Similarly, these hydroxyl groups can form O-glycosidic bonds with carbohydrate residues to form glycoproteins.

#### Reaction of the Amide Group

The amide groups of **Glutamine and Asparagine** can form N-glycosidic bonds with carbohydrate residues to form glycoproteins.

#### Reactions of SH Group

Cysteine has a sulfhydryl (SH) group and it can form a disulfide (S-S) bond with another cysteine residue. The two cysteine residues can connect two polypeptide chains by the formation of **interchain disulfide bonds** or links (Fig. 3.20). The dimer formed by two cysteine residues is sometimes called **Cystine** or Dicycysteine.

### Amino Acid Derivatives of Importance

- i. **Gamma amino butyric acid** (GABA, a derivative of glutamic acid) and dopamine (derived from tyrosine)

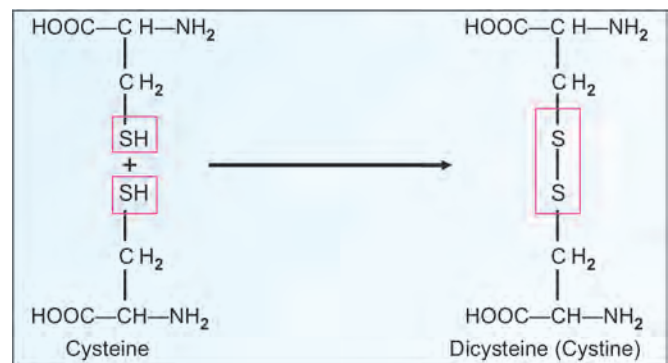


Fig. 3.20: Formation of disulfide bridges

are neurotransmitters. **GABA pentin** can pass blood brain barrier and can form GABA in brain.

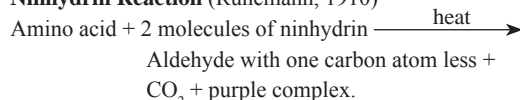
- ii. **Histamine** (synthesized from histidine) is the mediator of allergic reactions.
- iii. **Thyroxine** (from tyrosine) is an important thyroid hormone.
- iv. **Cycloserine**, a derivative of serine is an antituberculous drug. **Azaserine** inhibits reactions where amide groups are added, and so acts as an anticancer drug.
- v. **Histidine** residues are important in the buffering activity of proteins.
- vi. **Ornithine** and **citrulline** are derivatives of arginine, and are essential for urea synthesis.

## PEPTIDE BOND FORMATION

**Alpha carboxyl group** of one amino acid reacts with **alpha amino group** of another amino acid to form a peptide bond or CO-NH bridge (Fig. 3.21). Proteins are made by polymerization of amino acids through peptide bonds. Details of protein structures are given in Chapter 4.

### Color Reactions of Amino Acids and Proteins

1. **Ninhydrin Reaction** (Ruhemann, 1910)



All amino acids when heated with ninhydrin can form complexes; pink, purple or blue in color. The color complex is called **Ruhemann's purple**. Proline and hydroxy proline will give yellow color with ninhydrin. Amino acids with amide group (glutamine, asparagine) produce a brown color. The ninhydrin reaction may be adopted for qualitative as well as quantitative estimation of amino acids. It is often used for detection of amino acids in chromatography. Proteins do not give a true color reaction;

but N-terminal end amino group of protein will also react with ninhydrin, to produce a blue color.

2. **Biuret Reaction** : Cupric ions in an alkaline medium form a violet color with peptide bond nitrogen (Schiff, 1896). This needs a minimum of two **peptide bonds**, and so *individual amino acids and dipeptides will not answer this test*. This reaction can be used for quantitative estimation also. The name is derived from the compound biuret ( $\text{NH}_2\text{—CO—NH—CO—NH}_2$ ), a condensation product of two urea molecules, which also gives a positive color test. Magnesium and ammonium sulfates interfere with this reaction.
3. **Xanthoproteic Test**: The ring systems in **phenylalanine, tyrosine and tryptophan** undergo nitration on treatment with concentrated nitric acid when heated (Salkowski, 1888). The end product is yellow in color which is intensified in strong alkaline medium. This reaction causes the yellow stain in skin by nitric acid.
4. **Millon's Test**: The phenol group of **phenylalanine and tyrosine** containing proteins, when heated with mercuric sulfate in sulfuric acid and sodium nitrite (or, mercurous and mercuric nitrates in nitric acid) form red colored mercury phenolate (Millon, 1812–1867). Chloride interferes with this reaction and so it is not suitable to test for tyrosine in urine samples. Both xanthoproteic and Millon's tests are negative for tapioca (casava), which is deficient in phenylalanine and tyrosine.
5. **Aldehyde Tests for Tryptophan**: In the **Hopkins-Cole test**, tryptophan containing protein is mixed with glyoxylic acid, and the mixture is layered over concentrated sulfuric acid. A violet ring at the interface of liquids shows the presence of the indole ring.

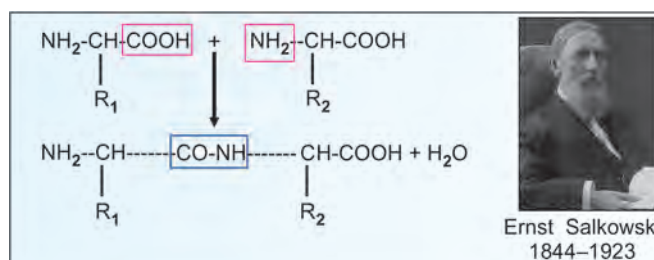


Fig. 3.21: Peptide bond formation

TABLE 3.3: Color reactions of amino acids

Reaction	Answered by specific group
1. Ninhydrin	Alpha amino group
2. Biuret reaction	Peptide bonds
3. Xanthoproteic test	Benzene ring (Phe, Tyr, Trp)
4. Millon's test	Phenol (Tyrosine)
5. Aldehyde test	Indole (Tryptophan)
6. Sakaguchi's test	Guanidinium (Arginine)
7. Sulfur test	Sulfhydryl (Cysteine)
8. Nitroprusside test	Sulfhydryl (Cysteine)
9. Pauly's test	Imidazole (Histidine)

### Box 3.2: Selenocysteine as the 21st amino acid

21st century witnesses the addition of **Selenocysteine** as the 21st amino acid present in human proteins. An amino acid is given the individual status, when it is incorporated as such into proteins during protein biosynthesis, and having a separate codon. Selenocysteine is present in some enzymes. Instead of SH (sulfhydryl) group in cysteine, SeH (selenium) is present in selenocysteine. It is abbreviated as SeCys or SeC. Details are given in Chapter 16, under serine. There are about 25 proteins that incorporate selenocysteine.

Similarly **Pyrrrolysine** (Pyl) is known as the 22nd amino acid. Pyrrrolysine is a lysine in an amide linkage to substituted-pyrroline-5-carboxylate. It is present in methyl transferase enzymes of certain bacteria. Both SeC and Pyl are encoded by codons that normally function as stop signals.



Formaldehyde and mercuric sulfate is used similarly in **Acree-Rosenheim reaction** to get a violet color. Para-dimethyl-amino-benzaldehyde and strong hydrochloric acid give dark blue color (Ehrlich's reaction). Gelatin with limited tryptophan content will not answer these tests.

- Sakaguchi's Test for Arginine** : Free arginine or arginyl residues in proteins react with alpha-naphthol and alkaline hypobromite to give bright-red color. This is due to the guanidium group.
- Sulfur Test for Cysteine**: When cysteine or cysteine-containing proteins are boiled with strong alkali, organic sulfur splits and forms sodium sulfide, which on addition of lead acetate produces lead sulphide as a black precipitate. Methionine does not answer this test because sulfur in methionine is in the thioether linkage which is difficult to break. Albumin and keratin will answer sulfur test positively; but casein will give a negative test.
- Nitroprusside Reaction for SH groups**: Proteins with free sulfhydryl groups give a reddish color with sodium nitroprusside, in ammoniacal solution. Many proteins give a negative, reaction in the native state, but when denatured, reaction will be positive, showing the emergence of free SH groups.
- Pauly's Test for Histidine or Tyrosine**: Diazo-benzene sulfonic acid reacts with imidazole group of Histidine to form a cherry-red colored diazotized product under alkaline conditions. The same reagent will give an orange red colored product with phenol group of Tyrosine.

Color reactions of amino acids are shown as summary in Table 3.3. The amino acid **Selenocysteine** is described

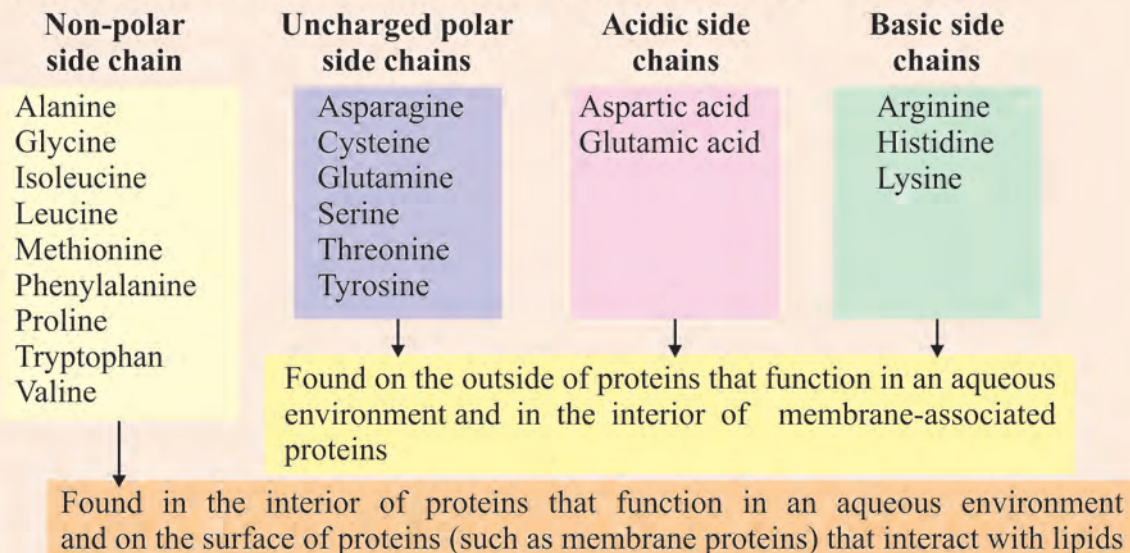
in Box 3.2. Quantitative estimation procedures of proteins are given in Chapter 4.

### QUICK LOOK OF CHAPTER 3

- Most amino acids in the body are alpha amino acids.
- Amino acids can be classified based on their (i) Structure (ii) Side chain characters (iii) Metabolic fate (iv) Nutritional requirements.
- In solution, amino acids exist as 'Zwitter ions' or 'Ampholytes' at their characteristic Isoelectric pH (pI). In this state they carry no net charge.
- The Imidazolium group of Histidine has a pK of 6.1 and contributes to the buffering actions of plasma proteins and hemoglobin at the physiological pH.
- Glycine has no asymmetric carbon atoms and therefore has no optical activity.
- Alpha carboxyl group of one amino acid combines with the alpha amino group of another amino acid to form a peptide bond. A peptide bond is a partial bond and hence there is no freedom of rotation.
- Proteins are polymers of amino acids linked adjacently by peptide bonds.

#### Importance of side chains of amino acids:

$\alpha$  carboxy groups and a amino groups in proteins are unavailable as they form peptide bonds; nature of side chains determine physical properties, including protein folding.



# CHAPTER 4

## Proteins: Structure and Function

### Chapter at a Glance

The reader will be able to answer questions on the following topics:

- Peptide bonds
- Primary structure of proteins
- Secondary structure
- Tertiary structure
- Quaternary structure
- Sequence analysis (study of primary structure)
- Isoelectric pH of proteins
- Precipitation reactions of proteins
- Classification of proteins
- Quantitative estimation of proteins

The word protein is derived from Greek word, “proteios” which means primary. As the name shows, the proteins are of paramount importance for biological systems. Out of the total dry body weight, 3/4ths are made up of proteins. Proteins are used for body building; all the major structural and functional aspects of the body are carried out by protein molecules. Abnormality in protein structure will lead to molecular diseases with profound alterations in metabolic functions.

Proteins contain Carbon, Hydrogen, Oxygen and Nitrogen as the major components while Sulfur and Phosphorus are minor constituents. Nitrogen is characteristic of proteins. **On an average, the nitrogen content of ordinary proteins is 16% by weight.** All proteins are polymers of amino acids.

### Amino Acids are Linked by Peptide Bonds

Alpha carboxyl group of one amino acid reacts with alpha amino group of another amino acid to form a peptide bond or CO-NH bridge (Fig. 4.1A).

Proteins are made by polymerization of amino acids through peptide bonds. Two amino acids are combined to form a **dipeptide**; three amino acids form a **tripeptide**; four will make a **tetrapeptide**; a few amino acids together will make an **oligopeptide**; and combination of 10 to 50 amino acids is called as a **polypeptide**. By convention, long polypeptide chains containing more than 50 amino acids are called **proteins**.

In a tripeptide, there are 3 amino acids, but these 3 can be any of the total 20 amino acids. Thus  $20^3 = 8000$  different permutations and combinations are possible in

a tripeptide. An ordinary protein having about 100 amino acids, will have  $20^{100}$  different possibilities. This number is more than the total number of atoms present in the whole universe. Thus, even though there are only 20 amino acids, by changing the sequence of combination of these amino acids, nature produces enormous number of markedly different proteins.

## STRUCTURE OF PROTEINS (Organization of Proteins)

Proteins have different levels of structural organization; primary, secondary, tertiary and quaternary.

### Primary Structure

#### Sequence of Amino Acids in Proteins

Protein structure is studied as the primary, secondary, tertiary and quaternary levels (Box 4.1). **Primary structure denotes the number and sequence of amino acids in the protein.** The higher levels of organization are decided by the primary structure. Each polypeptide chain has a unique amino acid sequence decided by the genes. The primary structure is maintained by the covalent bonds of the peptide linkages (Fig. 4.1A).

Students should have a clear concept of the term “sequence”. See the following example:

Gly - Ala - Val (1)

Gly - Val - Ala (2)

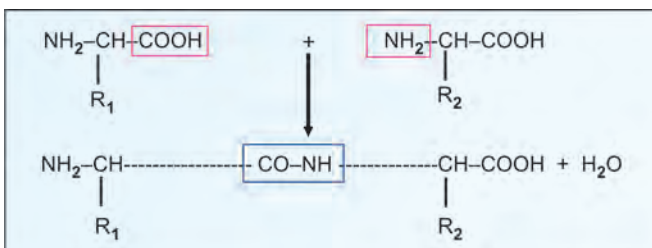


Fig. 4.1A: Peptide bond formation

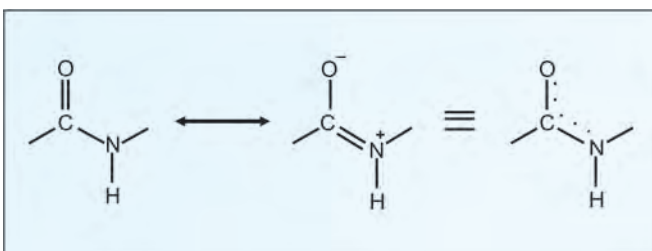


Fig. 4.1B: Peptide bond is a partial double bond

Both the tripeptides shown above contain the same amino acids; but their sequence is altered. When the sequence is changed, the peptide is also different.

#### Characteristics of a Peptide Bond

- The peptide bond is a **partial double bond**.
- The **C-N bond is ‘trans’** in nature and there is no freedom of rotation because of the partial double bond character. (Fig. 4.1B)
- The distance is  $1.32\text{\AA}$  which is midway between single bond ( $1.49\text{\AA}$ ) and double bond ( $1.27\text{\AA}$ ).
- The side chains are free to rotate on either side of the peptide bond.
- The angles of rotation, known as **Ramachandran angles**, therefore determine the spatial orientation of the peptide chain (Fig. 4.2). (Dr GN Ramachandran did pioneering work on the structural aspects of proteins during 1950s and 1960s).



GN Ramachandran  
1922–2001

#### Box 4.1: Definitions of levels of organization

- Primary structure** of protein means the order of amino acids in the polypeptide chain and the location of disulfide bonds, if any.
- Secondary structure** is the steric relationship of amino acids, close to each other.
- Tertiary structure** denotes the overall arrangement and inter-relationship of the various regions, or domains of a single polypeptide chain.
- Quaternary structure** results when the proteins consist of two or more polypeptide chains held together by non-covalent forces.

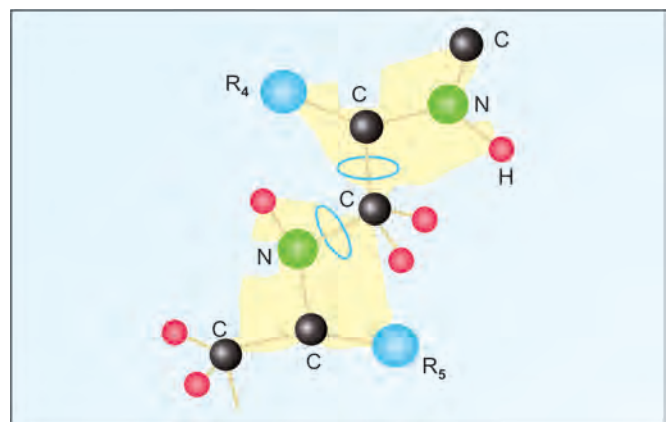


Fig. 4.2: Angles of rotation in a peptide bond

### Numbering of Amino Acids in Proteins

- i. In a polypeptide chain, at one end there will be one free alpha amino group. This end is called the **amino terminal (N-terminal) end** and the amino acid contributing the alpha-amino group is named as the **first amino acid**. (Fig. 4.3).
- ii. Usually the N-terminal amino acid is written on the left hand side when the sequence of the protein is denoted. Incidentally, the biosynthesis of the protein also starts from the amino terminal end.
- iii. The other end of the polypeptide chain is the **carboxy terminal end (C-terminal)**, where there is a free alpha carboxyl group which is contributed by the **last amino acid** (Fig. 4.3). All other alpha amino and alpha carboxyl groups are involved in peptide bond formation.
- iv. Amino acid residues in polypeptides are named by changing the suffix “-ine” to “-yl”, e.g. Glycine to Glycyl. Thus peptide bonds formed by carboxyl group of glycine with amino group of Alanine, and then carboxyl group of Alanine with amino group of Valine and is called glycyl-alanyl-valine and abbreviated as

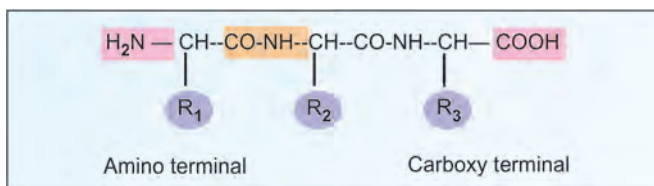


Fig. 4.3: End groups of polypeptide chain

NH<sub>2</sub>-Gly-Ala-Val-COOH or Gly-Ala-Val or simply as GAV.

### Branched and Circular Proteins

- i. Generally the polypeptide chains are linear. However branching points in the chains may be produced by interchain **disulphide bridges**. The covalent disulphide bonds between different polypeptide chains in the same protein (interchain) or portions of the same polypeptide chain (intrachain) are also part of the primary structure.
- ii. Rarely, instead of the alpha COOH group, the **gamma carboxyl** group of glutamic acid may enter into peptide bond formation, e.g. Glutathione (gamma-glutamyl-cysteinyl-glycine) (see Fig. 16.19). The term **pseudopeptide** is used to denote such a peptide bond formed by carboxyl group, other than that present in alpha position.
- iii. Very rarely, protein may be in a circular form, e.g. Gramicidin.

### Primary Structure of Insulin

As an example of the primary structure of a protein, that of insulin is shown in Figure 4.4. This was originally described by Sanger in 1955 who received the Nobel prize in 1958.

- i. Insulin has **two polypeptide chains**. The A chain (**Glycine chain**) has 21 amino acids and B (**Phenylalanine**) chain has 30 amino acids.



Frederick Sanger  
NP 1958 and  
1980, b. 1918

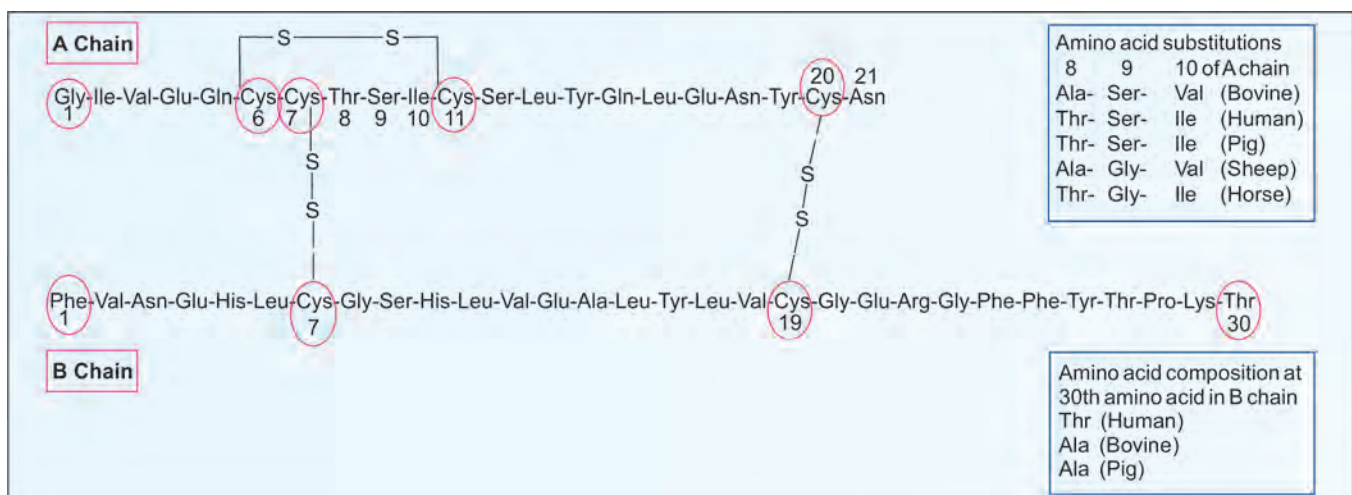


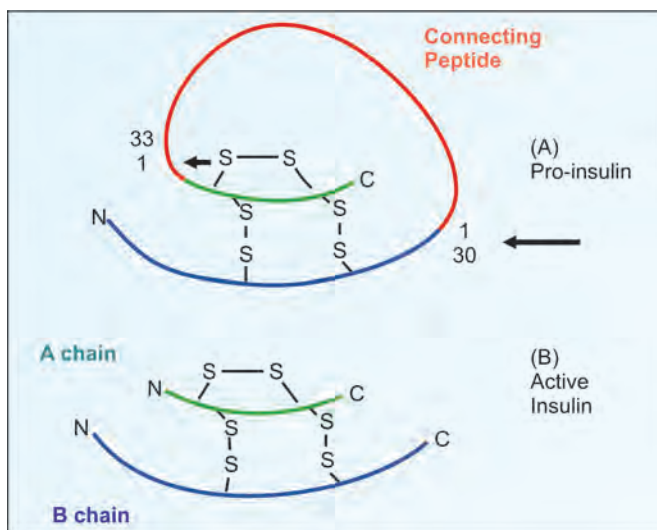
Fig. 4.4: Primary structure of human insulin



- ii. They are held together by **two interchain disulfide bonds** (Fig. 4.4). A chain 7th cysteine and B chain 7th cysteine are connected. Similarly A chain 20th cysteine and B chain 19th cysteine are connected. There is another **intrachain** disulfide bond between 6th and 11th cysteine residues of A chain.
- iii. The species variation is restricted to amino acids in position 8, 9 and 10 in A chain and in C-terminal of B chain (Fig. 4.4). The amino acid sequence has been conserved to a great extent during evolution.
- iv. The porcine insulin and human insulin are structurally similar, except the C terminal amino acid in B chain (Thr → Ala) (Fig. 4.4). Bovine Insulin may produce antibodies in humans by repeated injections. But de-alaninated porcine Insulin, bearing no antigenic difference from human Insulin will not produce antibodies in diabetic patients even after long-term use. Human insulin required for replacement therapy, is now produced by recombinant DNA technology.

### Pro-insulin

Beta cells of pancreas synthesize insulin as a prohormone. Proinsulin is a **single polypeptide chain** with 86 amino acids. Biologically active insulin (2 chains) is formed by removal of the central portion of the pro-insulin before release. The **C-peptide** (connecting peptide) is also released into the circulation (Fig. 4.5).



**Fig. 4.5:** Conversion of pro-insulin to active insulin. Arrows = site of action of proteolytic enzymes

### Primary Structure Determines Biological Activity

A protein with a specific primary structure will automatically form its natural three dimensional shape. So the higher levels of organization are dependent on the primary structure.

Even a single amino acid change (**mutation**) in the linear sequence may have profound biological effects on the function, e.g. in HbA (normal hemoglobin) the 6th amino acid in the beta chain is glutamic acid; it is changed to valine in HbS (**sickle cell anemia**).

### Secondary Structure of Proteins

The term “secondary structure” denotes the configurational relationship between residues, which are about 3–4 amino acids apart in the linear sequence (Box 4.2). Secondary and tertiary levels of protein structure are preserved by **noncovalent forces** or bonds like hydrogen bonds, electrostatic bonds, hydrophobic interactions and van der Waals forces. These forces are described in Chapter 1.

- i. **A hydrogen bond** is a weak electrostatic attraction between one electronegative atom like O or N and a hydrogen atom covalently linked to a second electronegative atom. Hydrogen atoms can be donated by -NH (imidazole, indole, peptide); -OH (serine, threonine) and -NH<sub>2</sub> (arginine, lysine). Hydrogen accepting groups are COO<sup>-</sup> (aspartic, glutamic) C = O (peptide); and S–S (disulfide).
- ii. **Electrostatic bonds (ionic bonds):** Positive charges are donated by epsilon amino group of lysine, guanidinium group of arginine and imidazolium group of histidine. Negative charges are provided by beta and gamma carboxyl groups of aspartic and glutamic acids.
- iii. **Hydrophobic bonds** are formed by interactions between nonpolar hydrophobic side chains by eliminating water molecules. This serves to hold lipophilic side chains together.
- iv. The **van der Waals forces** are very weak, but collectively contribute maximum towards the stability of protein structure.

#### Box 4.2: Configuration and conformation

Configuration of a compound denotes the spatial relationship between particular atoms, e.g. L and D amino acids. Conformation means the spatial relationship of every atom in a molecule, e.g. rotation of a portion of the molecule.

### Alpha Helix

Pauling (Nobel prize, 1954) and Corey described the alpha helix and beta-pleated sheet structures of polypeptide chains in 1951.

- i. **The alpha helix is the most common and stable conformation** for a polypeptide chain. In proteins like hemoglobin and myoglobin, the alpha helix is abundant, whereas it is virtually absent in chymotrypsin.
- ii. The alpha helix is a **spiral structure** (Fig. 4.6). The polypeptide bonds form the back-bone and the side chains of amino acids extend outward.
- iii. The structure is stabilized by hydrogen bonds between NH and C=O groups of the main chain.
- iv. Each turn is formed by 3.6 residues. The distance between each amino acid residue (translation) is 1.5 Å.
- v. The alpha helix is generally **right handed**. Left handed alpha helix is rare, because amino acids found in proteins are of L-variety, which exclude left handedness. Proline and hydroxy proline will not allow the formation of alpha helix.

### Beta-Pleated Sheet

- i. The polypeptide chains in beta-pleated sheet is almost fully extended. The distance between adjacent amino acids is 3.5 Å.

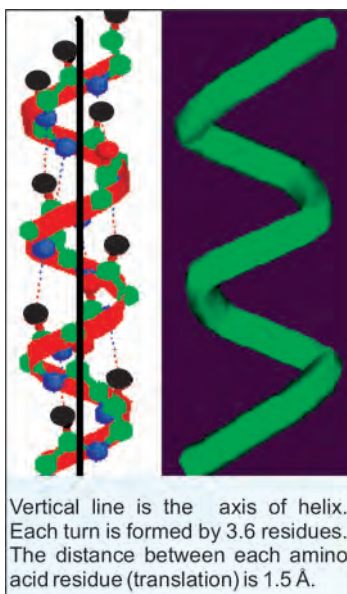


Fig. 4.6: Structure of alpha helix



Linus Pauling  
NP 1954 and 1962  
1901–1994



Robert B Corey  
1897–1971

- ii. It is stabilized by hydrogen bonds between NH and C=O groups of neighboring polypeptide segments.
- iii. Adjacent strands in a sheet can run in the same direction with regard to the amino and carboxy terminal ends of the polypeptide chain (parallel) or in opposite direction (anti-parallel beta sheet) (Fig. 4.7). Beta-pleated sheet is the major structural motif in proteins like silk Fibroin (anti-parallel), Flavodoxin (parallel) and Carbonic anhydrase (both).
- iv. Beta bends may be formed in many proteins by the abrupt U-turn folding of the chain. Intrachain disulfide bridges stabilize these bends.

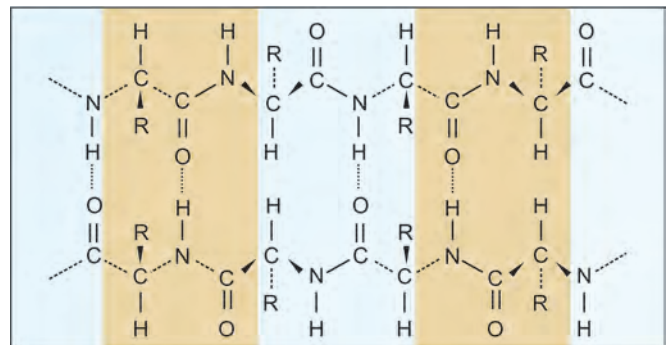


Fig. 4.7: Structure of beta-pleated sheet

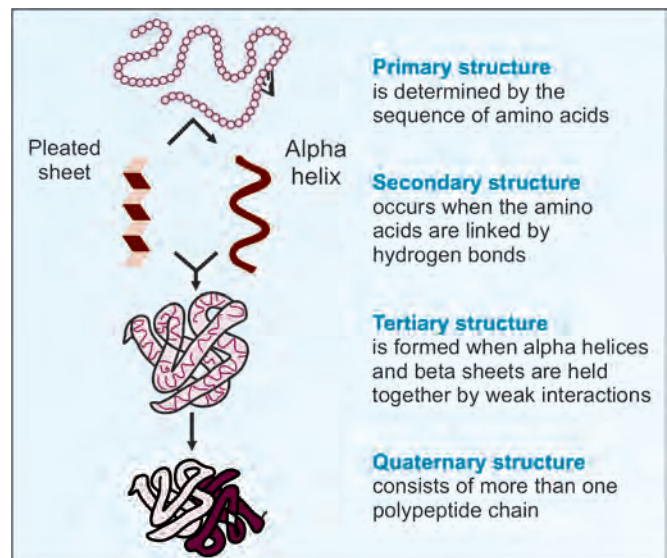


Fig. 4.8: Levels of organizations of proteins

### Collagen Helix

It is a triple helical structure found in collagen (details in Chapter 58).

### Tertiary Structure

- Secondary structure denotes the configurational relationship between residues which are about 3–4 amino acids apart; or secondary level defines the organization at immediate vicinity of amino acids. The tertiary structure denotes three dimensional structure of the whole protein (Box 4.1 and Fig. 4.8). The tertiary structure defines the steric relationship of amino acids which are far apart from each other in the linear sequence, but are close in the three-dimensional aspect.
- The tertiary structure is maintained by **non-covalent** interactions such as hydrophobic bonds, electrostatic bonds and van der Waals forces. The tertiary structure acquired by native protein is always thermodynamically most stable.
- Domain** is the term used to denote a compact globular functional unit of a protein. A domain is a relatively independent region of the protein, and may represent a functional unit. The domains are usually connected with relatively flexible areas of protein (see immunoglobulins, Chapter 55). Phenyl alanine hydroxylase enzyme contains 3 domains, one regulatory, one catalytic and one protein-protein interaction domains.
- The arrangements of the tertiary structure elements in a protein form a “fold”. A typical example is calmodulin, the calcium binding regulatory protein which regulates intracellular calcium level.

Different structural motifs are enumerated in Table 4.1.

### Quaternary Structure

- Certain polypeptides will **aggregate to form one functional protein** (Box 4.1 and Fig. 4.8). This is referred to as the quaternary structure.
- The protein will lose its function when the subunits are dissociated.
- The forces that keep the quaternary structure are hydrogen bonds, electrostatic bonds, hydrophobic bonds and van der Waals forces.
- Depending on the number of polypeptide chain, the protein may be termed as monomer (1 chain), dimer

(2 chains), tetramer (4 chains ) and so on. Each polypeptide chain is termed as **subunit** or **monomer**.

**Homodimer** contains two copies of the same polypeptide chain. **Heterodimer** contains two different types of polypeptides as a functional unit.

- For example, 2 alpha-chains and 2 beta-chains form the **hemoglobin** molecule. Similarly, 2 heavy chains and 2 light chains form one molecule of **immunoglobulin G**. Creatine kinase (CK) is a dimer. Lactate dehydrogenase (LDH) is a tetramer.

### Structure-function Relationship

The functions of proteins are maintained because of their ability to recognise and interact with a variety of molecules. The three-dimensional structural conformation provides and maintains the functional characteristics. In the three-dimensional structure of proteins, the hydrophilic polar charged residues are seen on the outer surface and the non-polar hydrophobic residues inside, out of contact with water. The three-dimensional structure, in turn, is dependent on the primary structure. So, any difference in the primary structure may produce a protein which cannot serve its function. To illustrate the structure-function relationship, the following three proteins are considered; each belongs to a different class in the functional classification.

### Enzymes

The first step in enzymatic catalysis is the binding of the enzyme to the substrate. This, in turn, depends on the structural conformation of the active site of the enzyme, which is precisely oriented for substrate binding (see Chapter 5). **Carbonic anhydrase** catalyses the reversible hydration of carbon dioxide. This enzyme makes it possible for the precise positioning of the CO<sub>2</sub> molecule and the hydroxyl (OH<sup>-</sup>) ion for the formation of bicarbonate ion. The zinc ion is located at a deep cleft coordinated to histidine residues. The CO<sub>2</sub> binding residues are very near

**TABLE 4.1:** Specific structural motifs in common proteins

Protein	Structural motif present
Myoglobin	Alpha helix and beta pleated sheet
Collagen	Triple helix
Keratin	Coiled coil
Elastin	No specific motif
Superoxide dismutase	Antiparallel beta pleated sheet

Bioinformatics identifies patterns within proteins that are signatures of structural features or motifs



to the zinc ion. Water binds to zinc ion, gets ionized to hydroxyl ion and it binds to the  $\text{CO}_2$  which is proximally located. The substrates are brought in close proximity for the reaction to proceed.

### Transport Proteins

**Hemoglobin**, the transporter of oxygen is a tetrameric protein (alpha 2, beta 2), with each monomer having a heme unit (see Chapter 22). Binding of oxygen to one heme facilitates oxygen binding by other subunits. Binding of  $\text{H}^+$  and  $\text{CO}_2$  promotes release of  $\text{O}_2$  from hemoglobin. This allosteric interaction is physiologically important, and is termed as Bohr effect. Even a single amino acid substitution alters the structure and thereby the function, e.g. in sickle cell anemia (HbS), the 6th amino acid in the beta chain is altered, leading to profound clinical manifestations.

### Structural Proteins

**Collagen** is the most abundant protein in mammals and is the main fibrous component of skin, bone, tendon, cartilage and teeth. Collagen forms a superhelical cable where the **3 polypeptide chains are wound around** itself (see Chapter 58). In collagen, every 3rd residue is a glycine. The only amino acid that can fit into the triple stranded helix is glycine. Replacement of the central glycine by mutations can lead to brittle bone disease. The triple helix of collagen is stabilized by the steric repulsion of the rings of hydroxyproline and also by the hydrogen bonds between them. In vitamin C deficiency, failure of hydroxylation of proline/lysine leads to reduced

hydrogen bonding and consequent weakness of collagen (see Chapter 58). The **quarter staggered triple helical structure** of collagen is responsible for its tensile strength. Different arrangements of collagen fibrils in tissues are seen. Parallel bundles in tendons and sheets layered at many angles in skin. Heat denatured collagen is **gelatin**. See Box 4.3 for details about keratin.

## STUDY OF PROTEIN STRUCTURE

The first protein to be sequenced was insulin by Sanger in 1955 (Nobel prize in 1958). Before studying the structure, first a pure sample of the protein has to be available. The proteins are extracted and purified by various chromatography techniques (ion exchange, adsorption, partition, size exclusion, affinity, HPLC). The purity of the protein thus isolated is studied by electrophoresis (agar, PAGE, iso electric focusing). Further, molecular weight is determined by mass spectroscopy. Principles of all the above-said techniques are discussed in Chapter 35.

### Steps for Determining the Primary Structure

1. Determination of the number of polypeptide chains in a protein. This is ascertained by treating them with **Dansyl chloride**, which combines with the N-terminal amino acid (Fig. 4.10). The tagged polypeptide chains are subjected to **complete hydrolysis** by boiling with 6 N HCl at  $110^\circ\text{C}$  for 18–36 hours under anaerobic conditions to give a mixture of amino acids. The number and nature of the dansyl amino acids can be determined and will indicate the number of polypeptide chains in the protein, e.g. if there are two different polypeptide chains in a protein, two different dansyl amino acids can be identified.

#### Box 4.3: Keratin—Some interesting facts

Mammals contain alpha keratin. It is classified into soft and hard keratin depending on the sulfur content. The cysteine residues are responsible for disulfide bridge formation which confers characteristic texture for each type of the protein. Soft keratin having low sulfur content is present in skin. Hard keratin is present in hair, horn and nails and has high sulfur content. The disulfide bridges resist the forces that try to deform them.

Springiness of hair is due to the characteristic coiled coil structural motif. When stretched, the coiled coil will untwist and resume the original structure. Hair styling like curling and straightening is based on reduction of the existing disulfide bond and then reoxidation so that new bonds are formed. Stretching using moist heat breaks disulfide bonds. Abnormalities in keratin structure will cause loss of skin integrity and results in diseases like Epidermolysis bullosa.

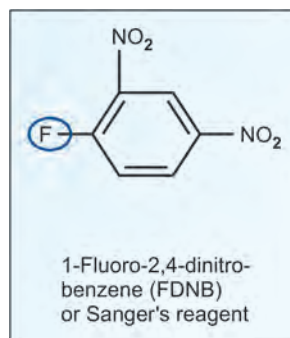


Fig. 4.9: 1-Fluoro-2, 4-dinitrobenzene (FDNB)

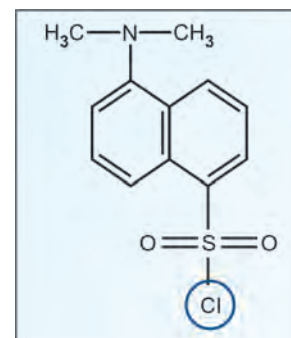


Fig.4.10: Dansyl chloride

- Determination of the amino acid composition by complete hydrolysis of the polypeptide chains, followed by chromatographic separation and identification.
- Identification of N-terminal and C-terminal amino acids (see below).
- Site specific hydrolysis of the polypeptide chain using specific enzymes to get a mixture of overlapping peptides.
- Separation and purification of each of these peptides, and then analyzing the amino acid sequence of each of the small peptides, and then deciphering the sequence of the whole protein.

### End Group Analysis

- The **N-terminal amino acid** has already been identified by treatment with dansyl chloride (Fig. 4.10). Originally Sanger used fluorodinitrobenzene (FDNB, **Sanger's reagent**) for identification of N-terminal amino acid (Fig. 4.9).
- The **C-terminal amino acid** may be identified by Carboxypeptidase A and B.

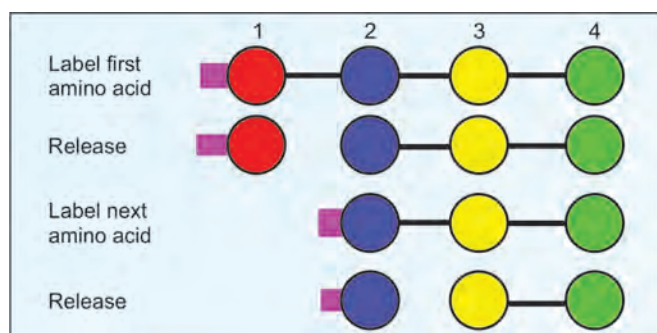
These enzymes specifically hydrolyze and release the C-terminal amino acid from the polypeptide chain. Continued action of the enzyme would release amino acids sequentially from the C-terminal end. Carboxypeptidase A will not act if the C-terminal residue is Arginine, Proline or Lysine. Carboxypeptidase B will act only if the penultimate residue is Proline.



Pehr Victor  
Edman  
1916–1977



Merrifield  
NP 1984  
1921–2006



**Fig.4.11:** Steps in Edman's degradation process. The numbers show the amino acid sequence. Amino terminal amino acid reacts with Edman's reagent; then it is hydrolyzed. This cycle repeats

### Sequencing

The purified individual polypeptide chains are then sequenced using **Edman's degradation technique**. Edman's reagent is phenyl-isothiocyanate. It forms a covalent bond to the N-terminal amino acid of any peptide chain (Fig. 4.11). This can be identified. The Edman's reagent would then react with the second amino acid which now has the alpha amino group. The degradation technique is useful in sequencing first 10–30 amino acids.

### Partial Hydrolysis

For very long chain proteins, the chain is broken into many small peptides of overlapping sequences. This is done by subjecting the polypeptide chain to hydrolysis by two or more different site specific enzymes. Each of these small peptides can be purified and subjected to Edman's degradation and sequenced.

**Trypsin** hydrolyzes peptide bonds formed by alpha carboxyl group of Lysine and Arginine.

**Chymotrypsin** preferentially acts on peptide bonds formed by carboxyl group of amino acids Phe, Tyr, Trp, or Leu.

**Cyanogen bromide (CNBr)** attacks C-side of methionine residue and breaks the peptide bond.

Each peptide is then analyzed and the whole sequence of the polypeptide is determined as if fitting in the parts of a jigsaw puzzle. The position of **disulfide bonds** can be determined by cleaving the native protein sample to get fragments with intact S–S bonds. These fragments are then identified.

### Finger Printing Method (Ingram's Technique)

This helps to easily identify any qualitative abnormalities in protein structure. Here the protein is digested into many small peptides by trypsin. The mixture of peptides are separated by chromatography (peptide mapping). The position of the peptide containing the altered amino acid is found to be different when compared with the peptide map of the normal polypeptide, e.g. beta chain of hemoglobin in HbA and HbS.

### Automatic Sequencing

Using the Edman's degradation technique, sequencing can be completed within a few hours by automatic machines.

### Study of Higher Levels of Protein Structure

The higher levels of protein structure may be studied by techniques like X-ray diffraction, ultraviolet light spectroscopy, optical rotatory dispersion, circular dichroism, nuclear magnetic resonance (NMR), etc.

**NMR spectroscopy** measures the absorbance of radio frequency of atomic nuclei. By studying the frequency at which a particular nucleus absorbs energy, we could get an idea of the functional group available in the molecule. Two-dimensional NMR permits a three-dimensional representation of the protein in solution. It also helps to study the alterations in conformation of a protein during binding with another ligand.

A beam of X-ray is diffracted by the electrons around each atom and the intensity of diffracted beam is detected by a photographic plate



or collected by an electronic device. This **X-ray diffraction study** is possible only on crystallised proteins.

Nowadays, **DNA sequencing** is helping the amino acid sequencing. In this method, at first, a rough sequencing of protein is done by Edman's method. Based on this knowledge, small length oligonucleotide primers are made. These are used to amplify the appropriate gene by polymerase chain (PCR) reaction (see Chapter 49) and correct DNA clone is obtained. The sequencing of that part of DNA is done. Using the knowledge of the genetic code (see Chapter 46), the sequence of the encoded protein is identified.

### Chemical Synthesis of Peptides

Peptides are artificially synthesized for the following purposes: 1. To check whether the sequence analysis is correct or not. 2. The primary structure of a peptide is altered by one or two amino acids, so as to determine the biologically important area or the active center. 3. To get pure preparations for medical or diagnostic purpose, e.g. HIV antibody in the blood of AIDS patients is detected by ELISA method. For this, pure antigen from HIV is to be coated in the test tubes. Preparation of enough quantity of antigen from the virus is tedious and hazardous. The best way is to synthesize the antigenic part of the protein. Commercially it is cheaper to synthesize small peptides, than isolating them from biological sources.

Emil Fischer in 1890 developed the basic mechanism to protect or activate reactive groups of amino acids. Bruce Merrifield in 1961 introduced the **solid phase** peptide synthesis (Nobel prize, 1984). He simplified the process by adding the carboxy terminal end amino acid to insoluble polystyrene beads, so that washing and purification processes become rapid. Insulin was the first major protein chemically synthesized (Katsoyanis, 1964). In principle, the carboxyl group of the last amino acid is fixed on the resin; and other amino acids are added sequentially.

## PHYSICAL PROPERTIES OF PROTEINS

1. Protein solutions exhibit colloidal properties and therefore scatter light and exert **osmotic pressure**. Osmotic pressure of plasma proteins is clinically important (see Chapter 28).
2. **Molecular weights** of some of the proteins are: Insulin (5,700); Hemoglobin (68,000); Albumin (69,000); Immunoglobulins (1,50,000); Rabbit Papilloma Virus Protein (4,70,00,000).
3. **Shape** of the proteins also vary. Thus, Insulin is globular, Albumin is oval in shape, while Fibrinogen molecule is elongated. Bigger and elongated molecules will increase the viscosity of the solution.
4. **Isoelectric pH** of amino acids has been described in Chapter 3. Since proteins are made of amino acids, the pI of all the constituent amino acids will influence the pI of the protein. Application of pI is shown in Box 4.4.

## PRECIPITATION REACTIONS OF PROTEINS

Purification of enzymes and other proteins usually start with precipitating them from solution. The stability of proteins in solution will depend mainly on the charge and hydration. Polar groups of the proteins ( $-\text{NH}_2$ ,  $\text{COOH}$ ,  $\text{OH}$  groups) tend to attract water molecules around them to produce a shell of hydration. Any factor, which **neutralizes the charge or removes water of hydration** will therefore cause precipitation of proteins. The following procedures are used for protein precipitation:

### Salting Out

When a neutral salt, such as ammonium sulfate or sodium sulfate is added to protein solution, the shell of hydration is removed and the protein is precipitated. This is called salting out. As a general rule, higher the molecular weight of a protein, the salt required for precipitation is lesser. Thus **globulins are precipitated at half saturation of ammonium sulfate; but albumin will need full saturation** of ammonium sulfate.

### Isoelectric Precipitation

**Proteins are least soluble at their isoelectric pH.** Some proteins are precipitated immediately when adjusted to their

#### Box 4.4: Significance of isoelectric pH (pI)

1. The amino acid composition will determine the isoelectric pH (pI) of protein. The alpha amino group and carboxyl group are utilized for peptide bond formation, and hence are not ionizable. All other ionizable groups present in the protein will influence the pI of the protein.
2. At the isoelectric point, the number of anions and cations present on the protein molecule will be equal and the **net charge is zero**.
3. At the pI value, the proteins **will not migrate** in an electrical field. At the pI, solubility, buffering capacity and viscosity will be minimum; and **precipitation** will be maximum.
4. On the acidic side of pI, the proteins are cations and on alkaline side, they are anions in nature.
5. The pI of pepsin is 1.1; casein 4.6; human albumin 4.7; human insulin 5.4; human globulins 6.4; human hemoglobin 6.7; myoglobin 7; and lysozyme 11.
6. **Acidic dyes** such as eosin will dissociate into  $\text{H}^+$  + dye which will then attach with protein- $\text{NH}_3^+$  (proteincations). **Basic dyes** such as hematoxylin and methylene blue are dissociated to  $\text{OH}^-$  + dye $^+$ , which will then stain Protein- $\text{COO}^-$  (anions). Thus, the staining characteristic of a protein is determined by the pI of that protein.

isoelectric pH. The best example is **Casein** which forms a flocculent precipitate at pH 4.6 and redissolves in highly acidic or alkaline solutions. When milk is curdled, the casein forms the white curd, because lactic acid produced by the fermentation process lowers the pH to the isoelectric point of casein.

### Precipitation by Organic Solvents

When an organic solvent is added to the protein solution, water molecules available for proteins are reduced, and precipitation occurs. Organic solvents reduce the dielectric constant of the medium which also favors protein precipitation. Hence **alcohol** is a powerful protein precipitating agent. This may explain the disinfectant effect of alcohol.

### Precipitation by Heavy Metal Ions

In alkaline medium, proteins have net negative charge, or are anions. To such a solution, if salts of heavy metals are added, positively charged metal ions can complex with protein molecules and metal proteinates are precipitated. Salts of **Copper, Zinc, Lead, Cadmium and Mercury** are toxic, because they tend to precipitate normal proteins of the gastrointestinal wall. Based on this principle, **raw egg** is sometimes used as an **antidote** for mercury poisoning.

#### Box 4.5: Denaturation of proteins

1. Mild heating, treating with urea, salicylate, X-ray, ultraviolet rays, high pressure, vigorous shaking and such other physico-chemical agents produce denaturation.
2. There will be nonspecific alterations in secondary, tertiary and quaternary structures of protein molecules. **Primary structure is not altered** during denaturation (Fig. 4.12).
3. In general, during the process the solubility is decreased while precipitability of the protein is increased. It often causes **loss of biological activity**.
4. Native proteins are often resistant to proteolytic enzymes, but denatured proteins will have more exposed sites for enzyme action. Since cooking leads to denaturation of proteins, cooked foods are more easily digested.
5. Denatured proteins are sometimes re-natured when the physical agent is removed. Ribonuclease is a good example for such **reversible denaturation**. Immunoglobulin chains are dissociated when treated with urea. When the urea is removed by dialysis, the subunits are reassociated and biological activity of immunoglobulin is regained.
6. But many proteins undergo irreversible denaturation. For example, albumin cannot be renatured by removing the physical agent.

### Precipitation by Alkaloidal Reagents

Tungstic acid, phosphotungstic acid, **trichloro acetic acid**, picric acid, sulfosalicylic acid and **tannic acid** are powerful protein precipitating agents. These acids lower the pH of medium, when proteins carry net positive charges. These protein cations are complexed with negatively charged ions to form protein-tungstate, protein-picrate, etc., and thick flocculent precipitate is formed. In clinical laboratory phosphotungstic or trichloro acetic acid are usually used for precipitating proteins. **Tanning** in leather processing is based on the protein precipitating effect of tannic acid. Under certain conditions, proteins undergo **denaturation**, which is a mild form of precipitation reaction (Box 4.5). **Heat coagulation** is an irreversible precipitation process (Box 4.6 and Fig. 4.13).

## CLASSIFICATION OF PROTEINS

It is almost impossible to correctly classify all proteins. The following classifications are given only to introduce a broader idea to the students.

### Classification Based on Functions

1. Catalytic proteins, e.g. enzymes
2. Structural proteins, e.g. collagen, elastin

#### Box 4.6: Significance of heat coagulation

When **heated at isoelectric point**, some proteins will denature **irreversibly** to produce thick floating conglomerates called coagulum. This process is called heat coagulation. **Albumin** is easily coagulated, and globulins to a lesser extent. (Fig. 4.13). This is the basis of '**Heat and Acetic Acid test**', very commonly employed to detect the presence of albumin in urine (see Chapter 27).

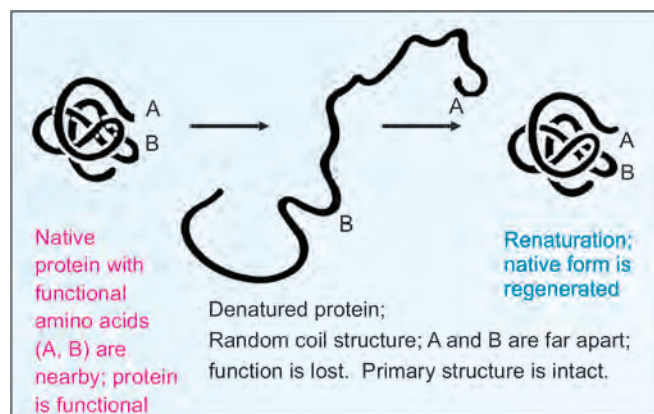


Fig. 4.12: Denaturation of protein

3. Contractile proteins, e.g. myosin, actin.
4. Transport proteins, e.g. hemoglobin, myoglobin, albumin, transferrin
5. Regulatory proteins or hormones, e.g. ACTH, insulin, growth hormone
6. Genetic proteins, e.g. histones
7. Protective proteins, e.g. immunoglobulins, interferons, clotting factors.

## Classification based on Composition and Solubility

### Simple Proteins

According to definition, they contain only amino acids.

- i. **Albumins:** They are **soluble in water** and coagulated by heat. Human serum albumin has a molecular weight of 69,000, e.g. lactalbumin of milk and egg albumin.
- ii. **Globulins:** These are insoluble in pure water, but soluble in **dilute salt solutions**. They are also coagulated by heat, e.g. egg globulin, serum globulins, legumin of peas.
- iii. **Protamines:** These are soluble in water, **dilute acids**. They are not coagulated by heating. They contain large number of arginine and lysine residues, and so are strongly basic. Hence they can combine with other acidic proteins. Protamine zinc insulinate is a common commercial preparation of insulin.
- iv. **Prolamines:** They are soluble in 70–80% **alcohol**, but insoluble in pure water. They are rich in proline but lack in lysine, e.g. zein from corn, gliadin of wheat, hordein of barley.
- v. **Lectins:** Lectins are precipitated by 30–60% **ammonium sulfate**. They are proteins having high affinity to sugar groups. Lectin from *Dolichos biflorus* will agglutinate human blood group A1 RBCs. Phytohemagglutinin (PHA), a lectin from *Phaseolus vulgaris* (red kidney bean) agglutinates all RBCs and WBCs. Concanavalin-A (ConA) from legumes will specifically attach to mannose and glucose. The attachment of lectins on normal and cancer cells will be different, this property is sometimes utilized to differentiate cancer cells.
- vi. **Scleroproteins:** They are insoluble in water, salt solutions and organic solvents and soluble only in **hot strong acids**. They form supporting tissues, e.g. collagen of bone, cartilage and tendon; keratin of hair, horn, nail and hoof.

### Conjugated Proteins

They are combinations of protein with a non-protein part, called **prosthetic group** (Table 4.2). Conjugated proteins may be classified as follows:



**Fig. 4.13:** Heat coagulation. On heating, liquid white portion of egg becomes solid white coagulum

- i. **Glycoproteins:** These are proteins combined with carbohydrates. Hydroxyl groups of serine or threonine and amide groups of asparagine and glutamine form linkages with carbohydrate residues. **Blood group antigens** and many serum proteins are glycoproteins. When the carbohydrate content is more than 10% of the molecule, the viscosity is correspondingly increased; they are sometimes known as **mucoproteins** or proteoglycans.
- ii. **Lipoproteins:** These are proteins loosely combined with lipid components. They occur in blood and on cell membranes. Serum lipoproteins are described in Chapter 13.
- iii. **Nucleoproteins:** These are proteins attached to nucleic acids, e.g. Histones. The DNA carries negative charges, which combines with positively charged proteins.
- iv. **Chromoproteins:** These are proteins with coloured prosthetic groups. Hemoglobin (Heme, red); Flavoproteins (Riboflavin, yellow), Visual purple (Vitamin A, purple) are some examples of chromoproteins.
- v. **Phosphoproteins:** These contain phosphorus. **Casein** of milk and **vitellin** of egg yolk are examples. The phosphoric acid is esterified to the hydroxyl groups of serine and threonine residues of proteins.
- vi. **Metalloproteins:** They contain metal ions. Examples are Hemoglobin (Iron), Cytochrome (Iron), Tyrosinase (Copper) and Carbonic anhydrase (Zinc).

### Derived Proteins

They are degradation products of native proteins. Progressive hydrolysis of protein results in smaller and smaller chains: Protein → peptones → peptides → amino acids.

## Classification Based on Shape

### Globular Proteins

They are spherical or oval in shape. They are easily soluble, e.g. albumins, globulins and protamines.

### Fibrous Proteins

The molecules are elongated or needle shaped. Their solubility is minimum. They resist digestion. Collagen, elastin and keratins are examples.

**TABLE 4.2:** Examples of conjugated proteins

Conjugated Protein	Protein part	Prosthetic group
Hemoglobin	Globin	Heme
Nucleoprotein	Histones	DNA
Rhodopsin	Opsin	11-cis-retinal
Succinate dehydrogenase	Protein	Riboflavin as FAD
Ferritin	Apo ferritin	Iron
Ceruloplasmin	Apo ceruloplasmin	Copper

## Classification Based on Nutritional Value

### Nutritionally Rich Proteins

They are also called as **complete proteins or first class proteins**. They contain all the essential amino acids in the required proportion. On supplying these proteins in the diet, children will grow satisfactorily. A good example is **casein** of milk.

### Incomplete Proteins

They **lack one essential amino acid**. They cannot promote body growth in children; but may be able to sustain the body weight in adults. Proteins from **pulses are deficient in methionine**, while proteins of **cereals lack in lysine**. If both of them are combined in the diet, adequate growth may be obtained. (See mutual supplementation, Chapter 40).

### Poor Proteins

They **lack in many essential amino acids** and a diet based on these proteins will not even sustain the original body weight. Zein from corn lacks tryptophan and lysine.

## Biologically Important Peptides

When 10 or less number of amino acids are joined together, it is called an oligopeptide. Some of them are biologically active. A few examples are given below:

- i. **Thyrotropin releasing hormone (TRH)** is a tripeptide with the sequence of Glu-His-Pro; but the Glu and Pro are modified.
- ii. **Glutathione** is a tripeptide. It is gamma glutamyl cysteinyl glycine (see Fig. 16.19). It is involved in erythrocyte membrane integrity and is important in keeping enzymes in active state.
- iii. **Oxytocin and vasopressin (ADH)** are napeptides; with 9 amino acids. They are secreted by posterior pituitary.
- iv. **Angiotensin I** has 10 amino acids and Angiotensin II has 8 amino acids. They are pressor agents; they elevate blood pressure. (see Chapter 30).
- v. **Gramicidin S**, an antibiotic produced by *Bacillus brevis*, contains 10 amino acids. It is circular and contains D-phenyl alanine (usual proteins contain only L-amino acids).

Polypeptide hormones (more than 10 amino acids) are described in Chapters 24 and 51.

## QUANTITATIVE ESTIMATION

### Kjeldahl's Procedure

- i. The protein sample is digested by boiling (360°C) with concentrated sulfuric acid in presence of copper sulfate and sodium sulfate as catalysts.
- ii. The nitrogen present in the protein is reduced to ammonia which is absorbed by acid medium to become ammonium sulfate. After cooling, the digest is made alkaline by adding excess alkali. Now ammonia (NH<sub>3</sub>) is liberated, which is absorbed by a known quantity of standard acid kept in a vessel. The excess acid present in the vessel is back-titrated with a standard base, from which the liberated ammonia can be calculated.
- iii. Then the quantity of nitrogen originally present in the protein is assessed. Since **proteins**, on an average contain **16% nitrogen**, the weight of nitrogen  $\times 100/16$ , or nitrogen  $\times 6.25$  will give the value of proteins present in the original sample.
- iv. **Advantage:** This is the most accurate and precise method. It is generally used for standardizing a particular protein; that protein is then used for calibrating other proteins employing other easier methods.
- v. **Disadvantage:** It takes many days to get the result, and is unsuitable for routine clinical work.

### Biuret Method

- i. Cupric ions chelate with peptide bonds of proteins in alkaline medium produce a pink or violet color. The intensity of the color is proportional to the number of peptide bonds. The color is then compared with a standard protein solution treated with the biuret reagent, and estimated colorimetrically. The principle of colorimetry is discussed in Chapter 35.
- ii. **Advantage:** The biuret method is simple one step process, and is the most widely used method for plasma protein estimations.
- iii. **Disadvantage:** The sensitivity of the method is less and is unsuitable for estimation of proteins in milligram or microgram quantities.

### Lowry's Method

- i. This is based on the reduction of Folin-Ciocalteu phenol reagent (phosphomolybdic acid and phosphotungstic acid) by the tyrosine and tryptophan residues of protein. A blue color is developed, which is compared with that produced by a known standard.
- ii. **Advantage:** This method is very sensitive and protein content in microgram range can be measured. If tyrosine and tryptophan content of the proteins of test and standard vary widely, then the accuracy is lost; this is a minor disadvantage of this method.



## Spectrophotometric Estimation

- i. Proteins will absorb ultraviolet light at **280 nm**. This is due to the tyrosine and tryptophan residues in the protein. Quantitation is done by comparing the absorbance of the test solution with a known standard.
- ii. **Advantage and disadvantage:** The method is accurate, simple and highly sensitive up to microgram quantities. Since color reaction using other chemicals is not employed, the protein is not wasted in this method. However, the instrument is costly. Please see discussion in Chapter 35.

## Radial Immunodiffusion (Mancini's Technique)

Please note that the name is “radial” and not “radio”. There is no radiation applied in this process. As the precipitation arc is moving radially outward from the point of application, the name “radial” is given. Here specific antiserum is incorporated in the liquid agar, and then allowed to solidify on a glass plate. Then small wells (1 mm dia) are cut in the agar, and antigen (protein solution, patient's sera, etc.) is added in the well. The plate is incubated at 4°C for 1 to 3 days. The antigen molecules diffuse radially around the wells and react with the specific antibody molecules present all over the agar. A white ring of precipitate is seen, where equimolecular concentration (1:1 ratio) of antigen and antibody is attained. **The diameter of the precipitation ring will be proportional to the log of antigen concentration.** If known standards of different concentration is included along with the test, a standard graph is plotted, from which quantity of test substance can be obtained (Fig. 4.14).



Johan Kjeldahl  
1849–1900



Oliver Howe  
Lowry 1910–1996



Richard A Zsigmondy  
NP1925, 1865–1929

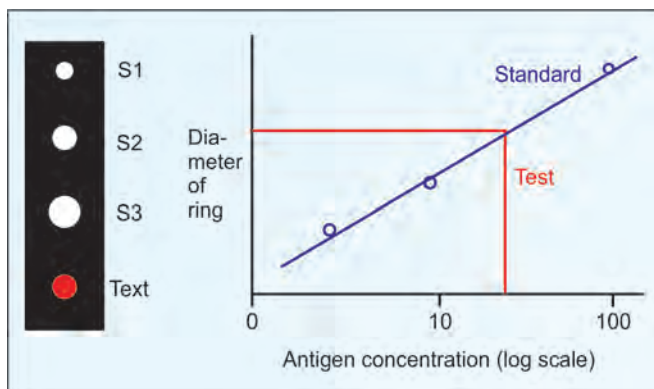


Fig. 4.14: Radial immunodiffusion

**Advantage:** The procedure is simple and sensitive enough to quantitate mg or microgram quantities of proteins. Since the method is based on antibodies, the test is exquisitely specific. Serum levels of immunoglobulins, complement components, etc. are routinely assayed by this method.

## Nephelometry

It is based on the measurement of scattering of light by colloids, originally studied by Richard Zsigmondy (Nobel prize, 1925). Scattering of light by antigen-antibody complexes was used as a quantitation method by Libby in 1938. Nephelometry is defined as the **detection of light scattered by turbid particles in solution**. If albumin is to be estimated, specific antibody against albumin is added. The resultant antigen-antibody complex will form turbidity of the solution. A beam of light (preferably laser beam) is passed through the solution. The particles in the solution will scatter light. The light turning at 30° to 90° angle (generally 60°) is collected and passed into a detector system. The emergent scattered light will be proportional to the turbidity of the solution, which in turn will be proportional to the antigen.

**Advantage and disadvantage:** This is a very rapid method and suitable for automated programs. Microgram quantities could be quantitated. The instrument and reagents are costly and needs careful standardization.

## Turbidimetry or Turbidometry

Proteins in biological fluids like urine and CSF can be estimated by adding protein precipitating agents (sulfosalicylic acid or specific antibody); the turbidity thus produced is measured. The method is simple, but less accurate. Nephelometry and turbidimetry are based on the same principle of scattering of light by colloidal particles. In nephelometry, emergent light scattered at 60° angle is observed; while in turbidimetry, light emerging at 180° angle is detected. Turbidimetry is comparatively cheaper. In Immunoturbidimetry, the particular protein is precipitated by specific antibody, and the resultant turbidity is measured. The method is very specific, simple, easy to perform and cheap.

## RIA and ELISA Tests

If proteins of nanogram and picogram quantities are to be estimated, radioimmunoassay (RIA) or enzyme-linked immunosorbent assay (ELISA) techniques are to be employed. These are described in detail in Chapter 35.

## Proteomics

Proteomics is the study of the entire galaxy of proteins produced by a cell under different conditions. At a particular time, a gene is “on” in a particular cell; but it will be “off” in another cell. Expression of proteins during growth and development will be different from the resting cell. Proteins produced by a gastro intestinal cell and a neuronal cell will be entirely different. Many proteins undergo post-translational modification, that too, at different levels at various organs. But genes are the same in



all cells at all times. Therefore study of genes (genomics) will give only a partial picture of what is going on in nature. Even though DNA determines the basic genetic structure of an organism, it is the protein which actually carries out the body functions. Proteomics aims at studying the protein structure and function. A variety of techniques are available for studying proteins; these include mass spectrometry, NMR spectrometry, isoelectric focusing, etc. Human body contains hundreds of different cells, which express thousands of proteins, at different times and under the influence of different stimuli. Proteomics attempt to study this multifaceted picture in toto.

### QUICK LOOK OF CHAPTER 4

1. Nitrogen content of ordinary proteins is on the average 16 % by weight.
2. Protein structure can be defined and studied at four levels viz. Primary, Secondary, Tertiary and Quaternary.
3. Quaternary structure is present in proteins with more than one polypeptide chain. Examples of oligomeric proteins with quaternary structure are hemoglobin and creatine kinase.
4. Cysteine forms disulfide linkages between two polypeptide chains in oligomeric proteins.
5. Primary structure determines the biological activity of the protein. Alterations lead to loss of functional capacity, e.g. Sick cell hemoglobin (HbS).
6. Secondary structure of protein is stabilized by hydrogen bonds, ionic bonds, hydrophobic interactions and van der Waals forces.
7. Secondary structure could be an alpha helix or a beta pleated sheet. A beta pleated sheet may further be parallel or anti-parallel.
8. Tertiary structure of a protein is the most thermodynamically stable configuration.
9. Protein folding into its 3-D configuration is assisted by chaperones. Incorrect folding has been proposed as a mechanism in the origin of prion diseases.
10. N-terminal amino acid can be determined by Dansyl Chloride, Edman's reagent and Sanger's reagent (Fluorodinitrobenzene - FDNB), while the C-terminal amino acid can be determined using Carboxypeptidase.
11. Solubility of a protein is dependent on the ionic concentration of the medium. Hence, proteins may be 'salted in' or 'salted out'.
12. Denaturation of protein results in loss of biological activity but not the primary structure. Denaturation may be reversible.
13. Proteins can be classified based on (i) Functions (ii) Composition (iii) Shape and (iv) Nutritional value.
14. Tyrosine and Tryptophan residues in proteins absorb strongly at 280 nm. This property is used for quantitation of proteins spectrophotometrically.
15. Methods of protein estimation include colorimetry (Biuret and Lowry's method), radioimmunoassay (RIA) and enzyme-linked immunosorbent assay (ELISA).

# CHAPTER 5

## Enzymology: General Concepts and Enzyme Kinetics

### Chapter at a Glance

The reader will be able to answer questions on the following topics:

- Classification of enzymes
- Co-enzymes
- Mode of action of enzymes
- Michaelis-Menten theory
- Fischer's template theory
- Koshland's induced fit theory
- Michaelis constant,  $K_m$  value,  $V_{max}$
- Factors influencing enzyme activity
- Enzyme activation
- Inhibition, competitive, non-competitive
- Allosteric inhibition, suicide inhibition
- Covalent modification
- Iso-enzymes

Once upon a time there was a rich merchant. In his last will and testament, he put aside his 17 white horses to his 3 sons to be shared thus; 1/2 for the 1st son, 1/3 for the 2nd son and 1/9 for the 3rd son. After his death, the sons started to quarrel, as the division could not produce whole number. Then their brother-in-law told them that they should include his black horse also for the sharing purpose. Thus now they had  $17 + 1 = 18$  horses, and so division was possible; 1st son got one-half or 9 horses; 2nd son got 6 and 3rd son 2 horses. Now all the 17 white horses were correctly divided among the sons. The remaining black horse was taken back by the brother-in-law. Catalysts are similar to this black horse.

A chemical reaction, although theoretically probable, becomes practically possible only with the help of catalysts. They enter into the reaction, but come out of the reaction without any change. **Catalysts are substances which accelerate the rate of chemical reactions, but do not change the equilibrium.**

Berzelius in 1835 showed hydrolysis of starch by malt extract and put forward the theory of enzyme catalysis (see Table 1.1). In 1878, Willy Kunhe coined

the word enzyme, which in Greek means "in yeast". Eduard Buchner (Nobel prize 1907) showed that cell-free extract of yeast could catalyze the fermentation of sucrose to ethanol. He named this active principle as Zymase. Sir Arthur Harden in 1897 (Nobel prize 1929) showed that Zymase is a complex mixture of enzymes, each catalyzing a separate step in the degradation of sucrose. The rate of chemical reactions, chemical equilibrium and catalysis were studied by Ostwald (Nobel prize 1909). In 1926, James Sumner (Nobel prize 1946) was the first to crystallize the



Eduard  
Buchner  
NP 1907  
1860–1917



Arthur  
Harden  
NP 1929  
1865–1940



James  
Sumner  
NP 1946  
1887–1955



John  
Northrop  
NP 1946  
1891–1987



Wilhelm  
Ostwald  
NP 1909  
1853–1932

enzyme urease. In 1930, John Northrop (Nobel prize, 1946) crystallized a number of proteolytic enzymes from gastrointestinal tract and proved that they are all proteins.

## Enzymes are Biocatalysts

Life is possible due to the coordination of numerous metabolic reactions inside the cells. Proteins can be hydrolyzed with hydrochloric acid by boiling for a very long time; but inside the body, with the help of enzymes, proteolysis takes place within a short time at body temperature. Enzyme catalysis is very rapid; usually 1 molecule of an enzyme can act upon about 1000 molecules of the substrate per minute. Lack of enzymes will lead to block in metabolic pathways causing **inborn errors of metabolism**.

The substance upon which an enzyme acts, is called the **substrate**. The enzyme will convert the substrate into the **product** or products.

## Characteristics of Enzymes

- Almost all enzymes are proteins. Enzymes follow the physical and chemical reactions of proteins.
- They are heat labile.
- They are water-soluble.
- They can be precipitated by protein precipitating reagents (ammonium sulfate or trichloroacetic acid).
- They contain 16% weight as nitrogen.

## CLASSIFICATION OF ENZYMES

When early workers isolated certain enzymes, whimsical names were given. Some of these, such as Pepsin, Trypsin, Chymotrypsin, etc. are still used. Later, it was agreed to call the enzymes by adding the suffix "-ase" to the substrate. Thus, enzyme **Lactase** acts on the substrate lactose, and the products glucose and galactose are formed. Enzymes that hydrolyse starch (amylose) are termed as amylases; those that dehydrogenate the substrates are called dehydrogenases. These are known as the **trivial names** of the enzymes.

## IUBMB System of Classification

International Union of Biochemistry and Molecular Biology (IUBMB) in 1964, (modified in 1972 and 1978), suggested the IUBMB system of nomenclature of enzymes. It is complex and cumbersome; but unambiguous. As per this

system, the name starts with EC (enzyme class) followed by 4 digits.

**First** digit represents the class

**Second** digit stands for the subclass

**Third** digit is the sub-sub class or subgroup

**Fourth** digit gives the number of the particular enzyme in the list.

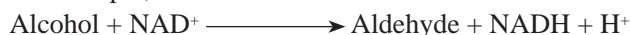
The enzymes are grouped into following **six major classes** (Box 5.1).

### Class 1: Oxidoreductases

This group of enzymes will catalyze oxidation of one substrate with simultaneous reduction of another substrate or co-enzyme. This may be represented as



for example,



The enzyme is **Alcohol dehydrogenase**; IUB name is Alcohol-NAD-oxidoreductase; Code number is EC.1.1.1.1. Oxidoreductases may also oxidize substrates by adding oxygen, e.g. oxidases, oxygenases and dehydrogenases (see Chapter 20).

### Class 2: Transferases

This class of enzymes **transfers one group** (other than hydrogen) from the substrate to another substrate. This may be represented as



For example, Hexose + ATP → Hexose-6-phosphate + ADP

#### Box 5.1: Classification of enzymes

**Class 1: Oxidoreductases:** Transfer of hydrogen or addition of oxygen; e.g. Lactate dehydrogenase (NAD); Glucose-6-phosphate dehydrogenase (NADP); Succinate dehydrogenase (FAD); di-oxygenases.

**Class 2: Transferases:** Transfer of groups other than hydrogen. Example, Aminotransferase. (Subclass: Kinase, transfer of phosphoryl group from ATP; e.g. Hexokinase).

**Class 3: Hydrolases:** Cleave bond and add water; e.g. Acetylcholine esterase; Trypsin.

**Class 4: Lyases:** Cleave without adding water, e.g. Aldolase; HMG CoA lyase; ATP Citrate lyase. (Subclass: Hydratase; add water to a double bond).

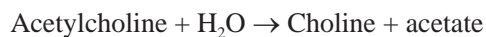
**Class 5: Isomerases:** Intramolecular transfers. They include racemases and epimerases. Example, Triose phosphate isomerase.

**Class 6: Ligases:** ATP dependent condensation of two molecules, e.g. Acetyl CoA carboxylase; Glutamine synthetase; PRPP synthetase.

The name of enzyme is **Hexokinase** and systematic name is ATP-Hexose-6-phosphate-transferase.

### Class 3: Hydrolases

This class of enzymes can hydrolyze ester, ether, peptide or glycosidic bonds by adding water and then breaking the bond.



The enzyme is **Acetylcholine esterase** or Acetylcholine hydrolase (systematic). All digestive enzymes are hydrolases.

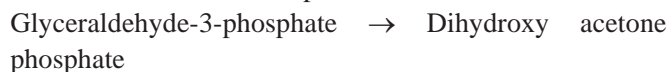
### Class 4: Lyases

These enzymes can remove groups from substrates or break bonds by mechanisms other than hydrolysis. For example, Fructose-1,6-bisphosphate  $\rightarrow$  Glyceraldehyde-3-phosphate + dihydroxy acetone phosphate

The enzyme is **Aldolase** (see Chapter 9 for details).

### Class 5: Isomerases

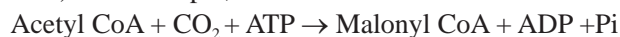
These enzymes can produce optical, geometric or positional isomers of substrates. Racemases, epimerases, cis-trans isomerases are examples.



Enzyme is Triose phosphate isomerase.

### Class 6: Ligases

These enzymes link two substrates together, usually with the simultaneous hydrolysis of ATP, (Latin, Ligare = to bind). For example,



Enzyme is Acetyl CoA carboxylase.

A summary of classification is given in Box 5.1. The differences between synthetase and synthase are shown in Box 5.2.

#### Box 5.2: Synthetase and synthase are different

**Synthetases** are ATP-dependent enzymes catalyzing biosynthetic reactions; they belong to Ligases (class 6). Examples are Carbamoyl phosphate synthetase; Arginino succinate synthetase; PRPP synthetase and Glutamine synthetase.

**Synthases** are enzymes catalyzing biosynthetic reactions; but they do not require ATP directly; they belong to classes other than Ligases. Examples are Glycogen synthase and ALA synthase.

## CO-ENZYMES

- i. Enzymes may be simple proteins, or complex enzymes, containing a non-protein part, called the **prosthetic group**. The prosthetic group is called the **co-enzyme**. It is heat stable. Salient features of co-enzymes are shown in Box 5.3.
- ii. The protein part of the enzyme is then named the **apo-enzyme**. It is heat labile.
- iii. These two portions combined together are called the **holo-enzyme**.
- v. Co-enzymes may be divided into **two groups**
  - a. Those taking part in reactions catalyzed by **oxidoreductases** by donating or accepting hydrogen atoms or electrons.
  - b. Those co-enzymes taking part in reactions transfer ring groups **other than hydrogen**.

### First Group of Co-enzymes

In the first group, the change occurring in the substrate is counter-balanced by the co-enzymes. Therefore, such co-enzymes may be considered as **co-substrates** or secondary substrates. In the example shown in Figure 5.1, the substrate lactate is oxidized, and simultaneously the co-enzyme (co-substrate) is reduced. When the reaction is reversed, the effect will be exactly the opposite, substrate getting reduced and co-enzyme being oxidized.

#### Box 5.3: Salient features of co-enzymes

1. The protein part of the enzyme gives the necessary three-dimensional infrastructure for chemical reaction; but the group is transferred from or accepted by the co-enzyme
2. The co-enzyme is essential for the biological activity of the enzyme
3. Co-enzyme is a low molecular weight organic substance. It is heat stable
4. Generally, the co-enzymes combine loosely with the enzyme molecules. The enzyme and co-enzyme can be separated easily by dialysis
5. Inside the body, when the reaction is completed, the co-enzyme is released from the apo-enzyme, and can bind to another enzyme molecule. In the example shown in Figure 5.1, the reduced co-enzyme, generated in the first reaction can take part in the second reaction. The coupling of these two reactions becomes essential in anaerobic glycolysis (Chapter 9) for regeneration of  $\text{NAD}^+$
6. One molecule of the co-enzyme is able to convert a large number of substrate molecules with the help of enzyme
7. Most of the co-enzymes are derivatives of vitamin B complex substances.

Other such examples are NADP–NADPH; FAD–FADH<sub>2</sub> and FMN–FMNH<sub>2</sub>.

## Nicotinamide Adenine Dinucleotide (NAD<sup>+</sup>)

- This is a co-enzyme synthesized from Nicotinamide, a member of vitamin B complex. The structure of NAD<sup>+</sup> is Nicotinamide-Ribose-P-P-Ribose-Adenine (see Fig. 37.6). Warburg (Nobel prize, 1931) elucidated the structure of NAD<sup>+</sup>.
- The reversible reaction of lactate to pyruvate is catalyzed by the enzyme lactate dehydrogenase, but the actual transfer of hydrogen is taking place on the co-enzyme, NAD<sup>+</sup> (Fig. 5.2A).
- In this case, two hydrogen atoms are removed from lactate, out of which one hydrogen and two electrons (hydride ion)



Otto Heinrich Warburg  
NP 1931  
1883–1970

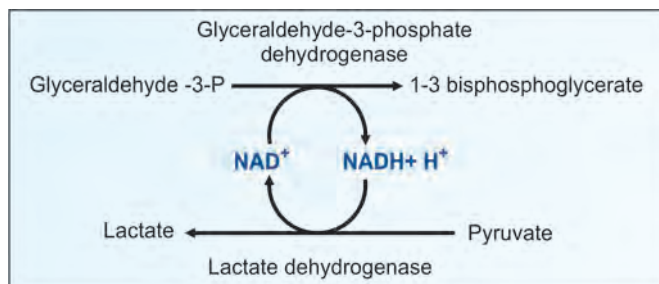


Fig. 5.1: One co-enzyme molecule can work with different enzymes

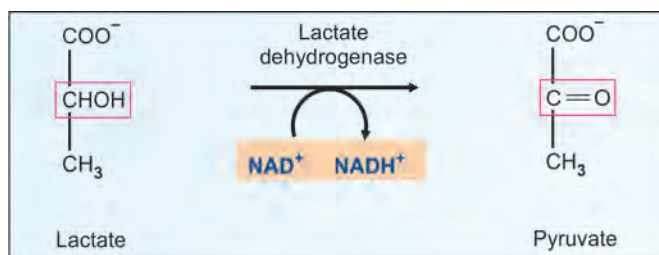


Fig. 5.2A: Reaction of lactate dehydrogenase

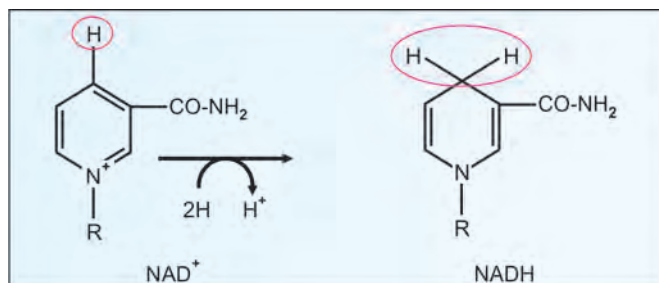


Fig. 5.2B: NAD<sup>+</sup> accepts hydride ion

are accepted by the NAD<sup>+</sup> to form NADH, and the remaining H<sup>+</sup> is released into the surrounding medium. The hydrogen is accepted by the **nicotinamide** group as shown in Figure 5.2B.

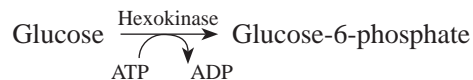
## Second Group of Co-enzymes

These co-enzymes take part in reactions **transferring groups other than hydrogen**. A particular group or radical is transferred from the substrate to another substrate. Most of them belong to vitamin B complex group. A few such examples are given in Table 5.1.

Co-enzyme A or CoA contains the -SH group, on which reactions take place. In order to emphasize the presence of -SH group, the molecule sometimes written as CoA-SH. Here the letter "A" stands for the acyl group that attaches to it.

## Adenosine Triphosphate (ATP)

- ATP is considered to be the **energy currency** in the body. Fiske and Subbarao first isolated ATP in 1926 and Lohmann in 1929 showed the importance of ATP in muscle contraction.
- In the ATP molecule, the second and third phosphate bonds are '**high energy**' bonds (shown as squiggle bonds in Fig.5.3).
- During the oxidation of food stuffs, energy is released, a part of which is stored as **chemical energy** in the form of ATP.
- The endergonic reactions are carried out with the help of energy released from hydrolysis of ATP.



## Metallo-enzymes

- These are enzymes, which require certain metal ions for their activity. Some examples are given in Table 5.2.

TABLE 5.1: Examples of co-enzymes

Co-enzyme	Group transferred
Thiamine pyrophosphate (TPP)	Hydroxyethyl
Pyridoxal phosphate (PLP)	Amino group
Biotin	Carbon dioxide
Co-enzyme-A (Co-A)	Acyl groups
Tetrahydrofolate (FH4)	One carbon groups
Adenosine triphosphate (ATP)	Phosphate



- ii. In certain cases, e.g. copper in Tyrosinase, the metal is **tightly bound** with the enzyme.
- iii. In other cases, even without the metal ion, enzyme may be active; but when the metal ion is added, the activity is enhanced. They are called **ion-activated enzymes**, e.g. calcium ions will activate pancreatic lipase.

## Co-factors

The term co-factor is used as a collective term to include co-enzymes and metal ions. Co-enzyme is an organic co-factor.

## MODE OF ACTION OF ENZYMES

There are a few theories explaining the **mechanism of action of enzymes**. Perhaps each of them tries to view the fact from different perspectives to explain a particular aspect of the action.

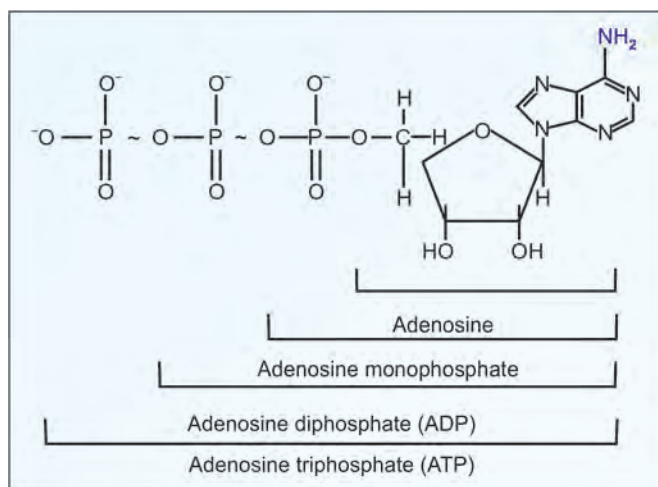


Fig. 5.3: Structure of ATP

TABLE 5.2: Metallo-enzymes

Metal	Enzymes containing metals
Zinc	Carbonic anhydrase, carboxy peptidase, alcohol dehydrogenase
Magnesium	Hexokinase, phosphofructokinase, enolase, glucose-6-phosphatase
Manganese	Phosphoglucomutase, hexokinase, enolase, glycosyl transferases
Copper	Tyrosinase, cytochrome oxidase, lysyl oxidase, superoxide dismutase
Iron	Cytochrome oxidase, catalase, peroxidase, xanthine oxidase
Calcium	Lecithinase, lipase
Molybdenum	Xanthine oxidase

## Lowering of Activation Energy

- i. Enzymes lower the energy of activation.
- ii. Activation energy is defined as the energy required to convert all molecules of a reacting substance from the ground state to the transition state.
- iii. Substrates are remaining in an **energy trough**, and are to be placed at a higher energy level, whereupon spontaneous degradation can occur. Suppose, we want to make a fire; even if we keep a flame, the wood will not burn initially; we have to add kerosene or paper for initial burning. Similarly, the activation energy is to be initially supplied.
- iv. During enzyme substrate binding, weak interactions between enzyme and substrate are optimized. This weak binding interaction between enzyme and substrate provides the major driving force for the enzymatic catalysis.
- v. **Enzymes reduce the magnitude of this activation energy**. This can be compared to making a tunnel in a mountain, so that the barrier could be lowered (Fig. 5.4). For example, activation energy for acid hydrolysis of sucrose is 26,000 cal/mol, while the activation energy is only 9,000 cal/mol when hydrolyzed by sucrase.

## Acid Base Catalysis

Protonated form of histidine is an example of a general acid and its conjugate base, the general base (Fig.5.5). The action of **ribonuclease** is an example of acid-base catalysis. Histidine residues 12 and 119 at

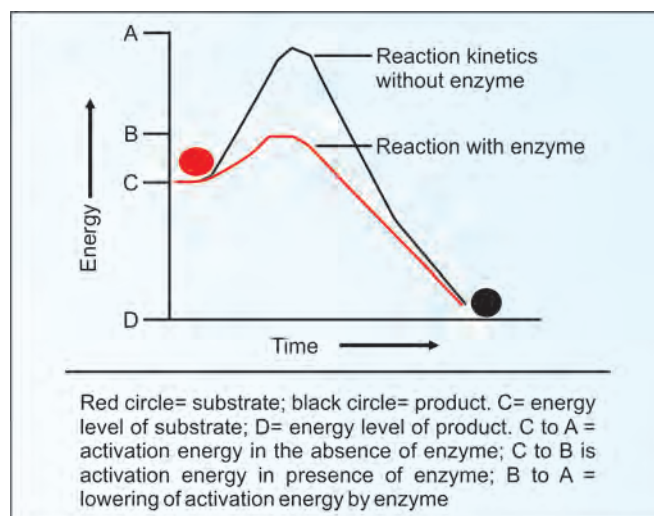


Fig. 5.4: Lowering of activation energy by enzymes

the active site of ribonuclease function as acid and base in catalysis. Histidine 12 acts as an acid and donates a proton to form the basic form. Then the 2'-3' cyclic phosphate is formed. Histidine 119 accepts a proton from the cyclic phosphate and product is released.

In the enzymes of **aspartic protease family**, catalysis involves two aspartyl residues, which act as acid-base catalysts. Pepsin, cathepsin and protease of HIV belong to this group.

### Substrate Strain

Binding of substrate to a preformed site on the enzyme can induce strain in the substrate. The energy level of the substrate is raised. A combination of substrate strain and acid base catalysis is seen in the action of lysozyme.

The lysozyme substrate has a repeating hexasaccharide unit. Binding of the substrate to the enzyme generates a strained conformation in the enzyme substrate complex (D in Fig.5.6). In the transition state, acid catalyzed hydrolysis of the glycosidic linkage by a glutamic acid residue at the active site generates a carbonium ion on the D residue. This relieves the strain generated in the initial enzyme-substrate complex. This results in the change from transition state to products. The glycosidic bond between N-acetyl glucosamine and N-acetyl muramic acid on the bacterial cell wall is thus hydrolyzed. This accounts for bactericidal action of lysozyme. Lysozyme was purified and studied by Howard Florey (Nobel prize, 1945).

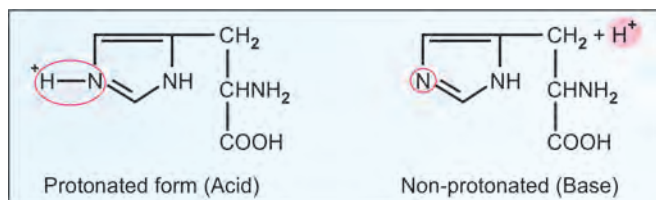


Fig. 5.5: Acid base catalysis with the help of histidine

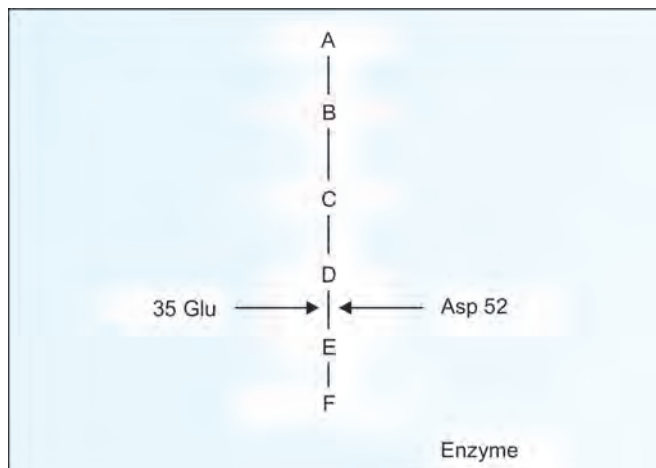


Fig. 5.6: Active center of lysozyme. A, B, C, D, E, F are carbohydrate units (substrate). D = N-acetyl muramic acid; E= N-acetyl glucosamine. Bond is broken between D and E, with the help of Glu and Asp residues in the enzyme, which are opposite to each other

### Serine Proteases

They are enzymes with a serine residue at the active site and most of the proteolytic enzymes belong to this group, e.g. trypsin, chymotrypsin, clotting factors (Table 5.3).

### Action of Chymotrypsin

It is a combination of covalent and acid base catalysis. The peptide bond is hydrolyzed through acid catalyzed nucleophilic attack, utilizing the serine 195 residue of the enzyme. The enzyme substrate complex is formed by the binding of the aromatic amino acid residue with the hydrophilic pocket on the active site on the enzyme. A covalent acyl enzyme intermediate is formed. Cleavage of the peptide bond occurs. Serine 195, Histidine 57 and Aspartate 102 are the catalytic groups.

### Covalent Catalysis

In covalent catalysis, a nucleophilic (negatively charged) or electrophilic (positively charged) group of the enzyme attacks the substrate. This results in covalent binding of the substrate to the enzyme. Similarly, co-enzymes often form covalent bonds with the substrates.

### Entropy Effect

Enzymes enhance reaction rates by decreasing entropy. When correctly positioned and bound on the enzyme surface, the substrates are strained to the transition state. This is referred to as the **Proximity effect**. Chemical reactions need physical apposition of two reactants. The occurrence of

TABLE 5.3: Proteases

Serine proteases	Trypsin, Chymotrypsin, Clotting factors
Cysteine proteases	Papain
Aspartyl proteases	Renin, retroviral proteases
Carboxyl proteases	Pepsin
Metalloproteases	Carboxy peptidases
Protease inhibitors used as drugs	ACE inhibitor (Captopril) HIV protease inhibitor (Retonavir)

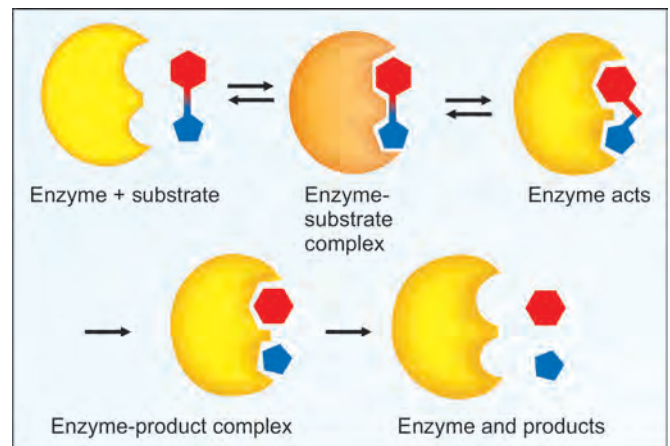


Fig. 5.7: Enzyme substrate complex

collision between two substrate molecules is determined by statistical probability. Since substrates usually are present in low concentrations, the collision probability is less and hence the reaction velocity is low. But a complex formation between the enzyme and the two substrate molecules can improve the collision probabilities many fold, causing the rapid rate of reaction.

### Product Substrate Orientation Theory

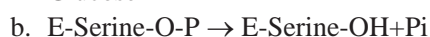
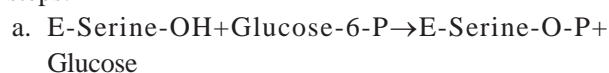
Enzyme has appropriate three dimensional structure to keep the substrates in a specific orientation, such that the reactive groups come in to physical apposition, leading to speedy reactions (Fig. 5.8). It has been shown that the hydroxyl group of the 6th carbon atom of glucose and the terminal phosphate group of ATP are juxtaposed with the help of hexokinase.

### MICHAELIS-MENTEN THEORY

- i. In 1913, Michaelis and Menten put forward the **Enzyme-Substrate complex theory**. Accordingly, the enzyme (E) combines with the substrate (S), to form an enzyme-substrate (ES) complex, which immediately breaks down to the enzyme and the product (P) (Fig. 5.7).



- ii. Alkaline phosphatase hydrolyzes a number of phosphate esters including glucose-6-phosphate. The active center of this enzyme contains a Serine residue, and the reaction is taking place in the following two steps:



Thus, the overall reaction is

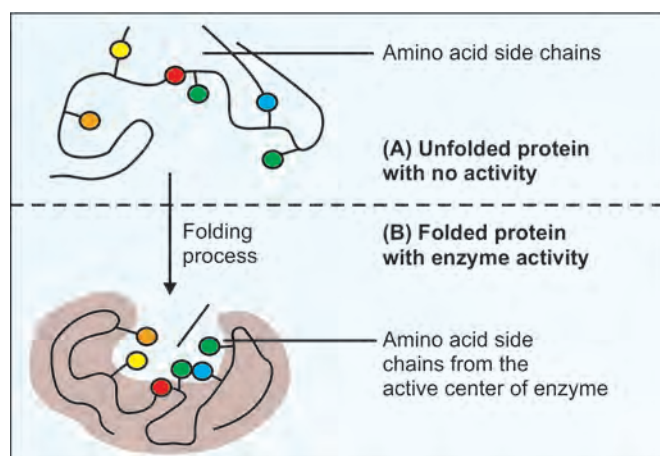
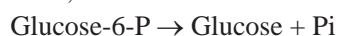


Fig. 5.8: Correct alignment of amino acids in the active center of the enzyme

In this reaction mixture, the enzyme substrate complex, E-Serine-O-P, has been isolated.

### FISCHER'S TEMPLATE THEORY

- i. It states that the three-dimensional structure of the active site of the enzyme is complementary to the substrate.
- ii. Thus **enzyme and substrate fit each other**. Substrate fits on the enzyme, similar to **lock and key**. The lock can be opened by its own key only (Figs 5.9 and 5.10).
- iii. However, Fischer envisaged a rigid structure for enzymes, which could not explain the flexibility shown by enzymes.

### KOSHLAND'S INDUCED FIT THEORY

- i. Conformational changes are occurring at the active site of enzymes concomitant with the combination of enzyme with the substrate. At first, substrate binds to a specific part of the enzyme.
- ii. This leads to more secondary binding and conformational changes. The **substrate induces conformational changes in the enzyme**, such that precise orientation of catalytic groups is effected (Fig. 5.8). A simplified explanation is that a glove is

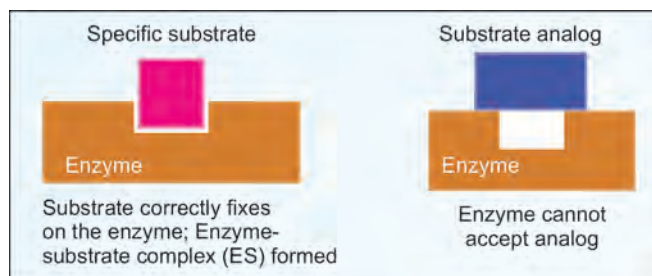


Fig. 5.9: Fischer's template theory

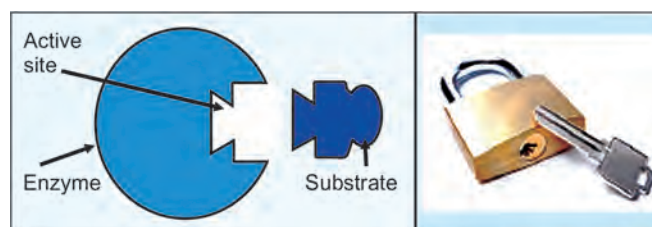


Fig. 5.10: Enzyme and substrate are specific to each other. This is similar to key and lock (Fischer's theory)

put on a hand. At first, the glove is in a partially folded position, but hand can enter into it. When the hand is introduced, the glove is further opened. Similarly, conformational changes occur in the enzyme when the substrate is fixed.

- iii. When substrate analog is fixed to the enzyme, some structural alteration may occur; but reaction does not take place due to lack of proper alignment (Fig. 5.8). Allosteric inhibition can also be explained by the hypothesis of Koshland.

## ACTIVE SITE OR ACTIVE CENTER OF ENZYME

Catalysis occurs at the active center or active site. Salient features are shown in Box 5.4. See Tables 5.3, 5.4 and Figure 5.8 also.

### Active Site of Ribonuclease

The catalytic site of ribonuclease also lies within a hydrophobic cleft, where 7th Lysine and 41st Lysine lie on one side and 12th Histidine and 119th Histidine on the opposite side of the binding site for uridylic acid. These active groups are brought to the specific orientation by the tertiary structure of the protein. The amino acid sequence and active conformation of ribonuclease were studied by Christian Anfinsen, Stanford Moore and William Stein, all three were awarded Nobel prize in 1972. Proteolytic enzymes having a serine residue at the active center are called **serine**



Emil Fischer  
NP, 1902  
1852–1919



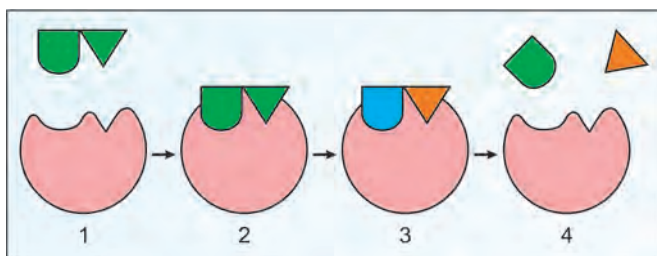
Leonor Michaelis  
1875–1949



Maud Menten  
1879–1960



Daniel Koshland  
1920–2007



1 Enzyme has shallow grooves; substrate alignment is not correct. 2. Fixing of substrate induces structural changes in enzyme. 3. Now substrate correctly fits into the active site of enzyme. 4. Substrate is cleaved into two products.

Fig. 5.11: Koshland's induced fit theory

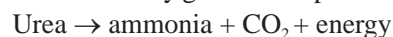
**proteases**, e.g. pancreatic proteases (Table 5.3), and coagulation factors. Other examples are given in Table 5.4.

## THERMODYNAMIC CONSIDERATIONS

From the standpoint of energy, the enzymatic reactions are divided into 3 types:

### Exergonic or Exothermic Reaction

Here energy is released from the reaction, and therefore reaction essentially goes to completion, e.g. urease enzyme:



#### Box 5.4: Active center of enzyme

1. The region of the enzyme where substrate binding and catalysis occurs is referred to as active site or active center (Tables 5.3 and 5.4)
2. Although all parts are required for maintaining the exact three-dimensional structure of the enzyme, the reaction is taking place at the active site. The active site occupies only a small portion of the whole enzyme
3. Generally active site is situated in a crevice or cleft of the enzyme molecule (Fig. 5.8). To the active site, the specific substrate is bound. The binding of substrate to active site depends on the alignment of specific groups or atoms at active site
4. During the binding, these groups may realign themselves to provide the unique conformational orientation so as to promote exact fitting of substrate to the active site (Fig. 5.8)
5. The substrate binds to the enzyme at the active site by non-covalent bonds. These forces are hydrophobic in nature
6. The amino acids or groups that directly participate in making or breaking the bonds (present at the active site) are called catalytic residues or catalytic groups
7. The active site contains substrate binding site and catalytic site; sometimes these two may be separate.

TABLE 5.4: Active center of enzymes

Name of enzyme	Important amino acid at the catalytic site
Chymotrypsin	His (57), Asp (102), Ser (195)
Trypsin	Serine, Histidine
Thrombin	Serine, Histidine
Phosphoglucomutase	Serine
Alkaline phosphatase	Serine
Acetylcholinesterase	Serine
Carbonic anhydrase	Cysteine
Hexokinase	Histidine
Carboxypeptidase	Histidine, Arginine, Tyrosine
Aldolase	Lysine





Howard Florey  
NP 1945  
1898–1968



Christian Anfinsen  
NP 1972  
1916–1995



Stanford Moore  
NP 1972  
1913–1982



William Stein  
NP 1972  
1911–1980

At equilibrium of this reaction, the substrate will be only 0.5% and product will be 99.5%. Such reactions are generally irreversible.

## Isothermic Reaction

When energy exchange is negligible, the reaction is easily reversible, e.g.



At equilibrium of this reaction, 77% glycogen will be unutilized and 23% glucose-1-phosphate will be formed.

## Endergonic or Endothermic Reaction

Energy is consumed and external energy is to be supplied for these reactions. In the body, this is usually accomplished by coupling the endergonic reaction with an exergonic reaction, e.g. Hexokinase catalyzes the following reaction:



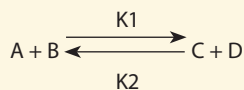
## ENZYME KINETICS

Velocity or rate of enzyme reaction is assessed by the rate of change of substrate to product per unit time.

### Box 5.5: Derivation of equilibrium constant

$$V \propto [A][B]$$

At equilibrium, forward reaction and backward reaction are equal, so that



$$\text{Forward reaction } R_1 = K_1 [A][B]$$

$$\text{and backward reaction } R_2 = K_2 [C][D]$$

$$\text{At equilibrium, } R_1 = R_2$$

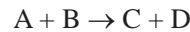
$$\text{Or, } K_1 [A][B] = K_2 [C][D]$$

$$\text{Or, } K_1 = [C][D] = K_{eq} \text{ or}$$

$$K_2 = [A][B] \quad \text{Equilibrium constant.}$$

In practice, **initial velocity** is determined. If much time is allowed to lapse, the velocity may tend to fall due to decrease in substrate concentration below a critical level.

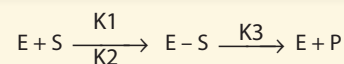
**The velocity is proportional to the concentration of reacting molecules.**



If concentration of A or B is doubled, the rate of reaction is also doubled. If concentrations of A and B are doubled together, the velocity becomes 4-fold. (Box 5.5). The following facts can be derived from the equations given in Box 5.6.

1. The **equilibrium constant** of the reaction is the ratio of reaction rate constants of forward and backward reactions.
2. At equilibrium, forward and backward reactions are equal. Equilibrium is a dynamic state. Even though no net change in concentrations of substrate and product occurs, molecules are always interconverted.
3. Numerical value of the constant can be calculated by finding the concentrations of substrates and products.
4. If  $K_{eq}$  is more than 1, the forward reaction is favored. In such instances, the reaction is spontaneous and exothermic.
5. **Concentration of enzyme does not affect the  $K_{eq}$ .** Concentration of enzyme certainly increases the rate of reaction; but not the  $K_{eq}$  or the ultimate state. In other words, enzyme makes it quicker to reach the equilibrium.

### Box 5.6: Derivation of Michaelis constant ( $K_m$ )



If concentration of substrate is increased, the forward reaction  $K_1$  is increased, and so  $K_3$  as well as total velocity is correspondingly enhanced. The three different constants may be made into one equation,

$$K_m = \frac{K_2 + K_3}{K_1}$$

$K_m$  is called as Michaelis Constant

It is further shown that

$$\text{Velocity } (v) = \frac{V_{max}[S]}{K_m + [S]}$$

When concentration of substrate is made equal to  $K_m$ , i.e.

When  $[S] = K_m$

$$\text{Velocity } (v) = \frac{V_{max}[S]}{[S] + [S]} = \frac{V_{max}[S]}{2[S]} = \frac{V_{max}}{2}$$

or  $v = \frac{1}{2} V_{max}$



**Catalysts increase the rate of reaction, but do not alter the equilibrium.**

## FACTORS INFLUENCING ENZYME ACTIVITY

The various factors which affect enzyme activity are enumerated in Box 5.7. These are explained below.

### Enzyme Concentration

- Rate of a reaction or velocity (V) is directly proportional to the enzyme concentration**, when sufficient substrate is present. Velocity of reaction is increased proportionately with the concentration of enzyme, provided substrate concentration is unlimited (Fig. 5.12).
- Hence, this property is made use of determining the level of particular enzyme in plasma, serum or tissues.
- Known volume of serum is incubated with substrate for a fixed time, then reaction is stopped and product is quantitated (**end point method**). Since the product formed will be proportional to the enzyme concentration, the latter could be assayed.

### Effect of Substrate Concentration

In a series of test tubes, equal volume of enzyme solution is taken, but increasing quantity of substrate is added and the

#### Box 5.7: Factors affecting enzyme activity

- Enzyme concentration
- Substrate concentration
- Product concentration
- Temperature
- Hydrogen ion concentration (pH)
- Presence of activators
- Presence of inhibitors
- Presence of repressor or derepressor
- Covalent modification.

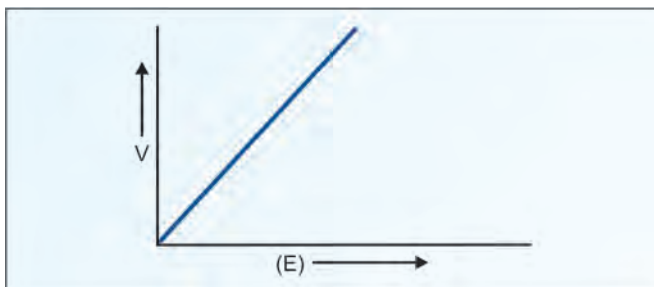


Fig. 5.12: Effect of enzyme concentration

rate of reaction is assayed in each tube. The velocity ( $v$ ) is expressed in micromoles of substrate converted per minute.

If the velocity is plotted against the substrate concentration, a typical curve (Fig. 5.13A) will be obtained. **As substrate concentration is increased, the velocity is also correspondingly increased in the initial phases; but the curve flattens afterwards.**

This is explained in the Figure 5.13B. At lower concentrations of substrate (point A in the curve), some enzyme molecules are remaining idle. As substrate is increased, more and more enzyme molecules are working. At half-maximal velocity, 50% enzymes are attached with substrate (point B in the curve). As more substrate is added, all enzyme molecules are saturated (point C). Further

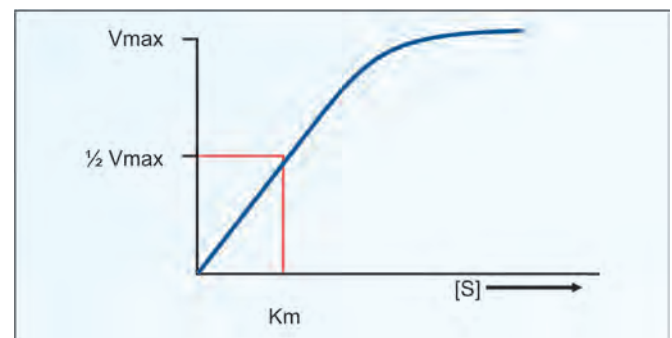


Fig. 5.13A: Effect of substrate concentration (substrate saturation curve)

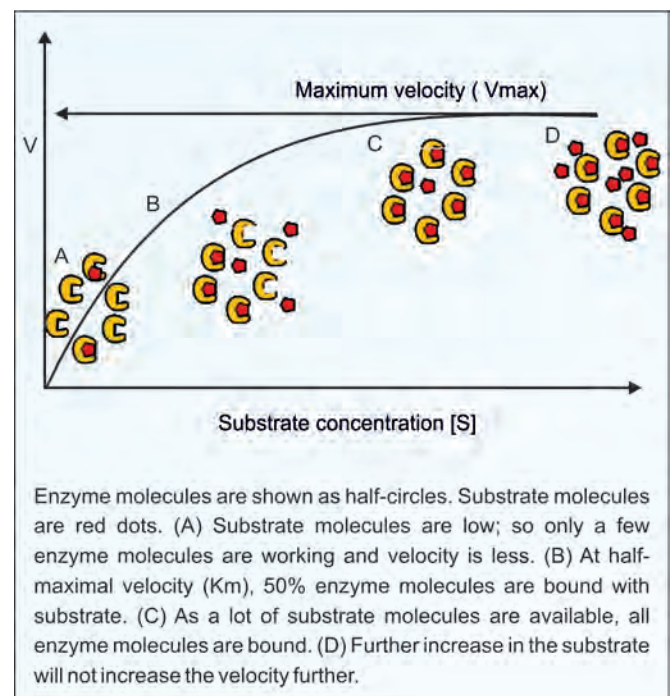


Fig. 5.13B: Effect of substrate concentration on enzyme activity

increase in substrate cannot make any effect in the reaction velocity (point D). **The maximum velocity obtained is called  $V_{max}$**  (Fig. 5.13B). It represents the maximum reaction rate attainable in presence of excess substrate (at **substrate saturation level**).

### Michaelis Constant

According to Michaelis theory, the formation of enzyme-substrate complex is a reversible reaction, while the breakdown of the complex to enzyme + product is irreversible. (See the derivation of the Michaelis constant in Box 5.6).

In the Figure 5.14, 50% velocity in Y axis is extrapolated to the corresponding point on X-axis, which gives the numerical value of  $K_m$ . Salient features of  $K_m$  value are shown in Box 5.8.

The lesser the numerical value of  $K_m$ , the affinity of the enzyme for the substrate is more. To cite an example,  $K_m$  of glucokinase is 10 mmol/L and that of hexokinase is 0.05 mmol/L. Therefore, 50% molecules of hexokinase are saturated even at a lower concentration of glucose. In other words, hexokinase has more affinity for glucose than glucokinase.

### Double Reciprocal Plot

Sometimes it is impractical to achieve high substrate concentrations to reach the maximal velocity conditions. So,  $\frac{1}{2}V_{max}$  or  $K_m$  may be difficult to determine. Then, the experimental data at lower concentrations is plotted as reciprocals. The straight line thus obtained is extrapolated to get the reciprocal of  $K_m$ . This is called **Lineweaver-**

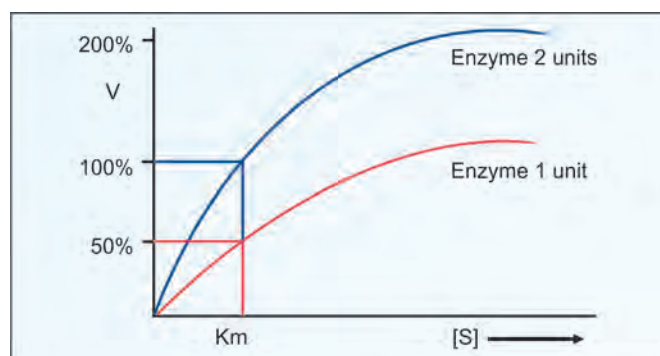


Fig. 5.14: Effect of enzyme concentrate on  $K_m$

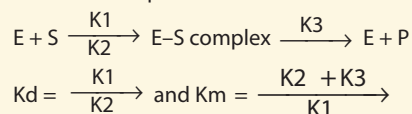
**Burk Plot or Double Reciprocal Plot** which can be derived from the Michaelis-Menten equation (For Lineweaver-Burk equation, see Box 5.9). If we plot  $1/v$  against  $1/[S]$ , it will give a straight line graph as shown in Figure 5.15. Intercept in X axis is minus  $1/K_m$ , from which the  $K_m$  can be calculated.

### Dixon Plot

The velocity ( $V$ ) is measured at several concentrations of inhibitor ( $I$ ), when the substrate ( $S$ ) concentration is kept constant. It is used for determining inhibition constants. A plot of  $1/V$  versus  $[I]$  yields a straight line. The experiment is repeated at different concentrations of substrates.

#### Box 5.8: Salient features of $K_m$

- $K_m$  value is substrate concentration** (expressed in moles/L) **at half-maximal velocity**
- It denotes that 50% of enzyme molecules are bound with substrate molecules at that particular substrate concentration** (Fig. 5.13.B)
- $K_m$  is independent of enzyme concentration.** If enzyme concentration is doubled, the  $V_{max}$  will be double (Fig. 5.14). But the  $\frac{1}{2}V_{max}$  ( $K_m$ ) will remain exactly same. In other words, irrespective of enzyme concentration, 50% molecules are bound to substrate at that particular substrate concentration.
- $K_m$  is the signature of the enzyme.**  $K_m$  value is thus a constant for an enzyme. It is the **characteristic feature of a particular enzyme** for a specific substrate.
- The **affinity of an enzyme** towards its substrate is **inversely related** to the dissociation constant,  $K_d$  for the enzyme-substrate complex.



Therefore, the smaller the tendency for the dissociation of the complex, the greater is the affinity of the enzyme for the substrate.

- $K_m$  denotes the affinity of enzyme for substrate.** The *lesser the numerical value of  $K_m$ , the affinity of the enzyme for the substrate is more.*

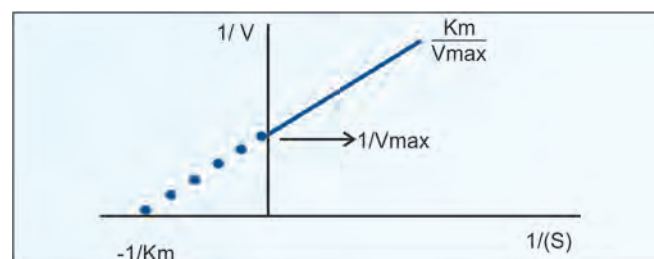


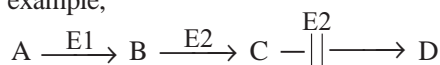
Fig. 5.15: Lineweaver-Burk plot

### Cooperative Binding

Some enzymes may not strictly follow the Michaelis-Menten kinetics. When the enzyme has many subunits, and **binding of substrate to one unit enhances the affinity for binding to other subunits** (cooperative binding), a sigmoid shaped saturation curve is obtained (Fig. 5.16). In such cases, determination of  $K_m$  value, as shown in the previous paragraph, will be invalid. Instead the **Hill equation**, originally described for explaining the oxygen binding to Hemoglobin, is employed (Hill was awarded Nobel prize in 1922).

### Effect of Concentration of Products

In a reversible reaction,  $S \rightleftharpoons P$ , when equilibrium is reached, as per the law of mass action, the reaction rate is slowed down. So when product concentration is increased, the reaction is slowed, stopped or even reversed. In inborn errors of metabolism, one enzyme of a metabolic pathway is blocked. For example,



If E3 enzyme is absent, C will accumulate, which in turn, will inhibit E2. Consequently, in course of time, the whole pathway is blocked.

#### Box 5.9: Lineweaver-Burk equation

$$v = \frac{V_{\max} [S]}{K_m + [S]}$$

When inverted, the equation is:

$$\begin{aligned} \frac{1}{v} &= \frac{K_m + [S]}{V_{\max} [S]} \\ &= \frac{K_m}{V_{\max}} \times \frac{1}{[S]} + \frac{[S]}{V_{\max} [S]} \\ &= \frac{K_m}{V_{\max}} \times \frac{1}{[S]} + \frac{1}{[V_{\max}]} \end{aligned}$$

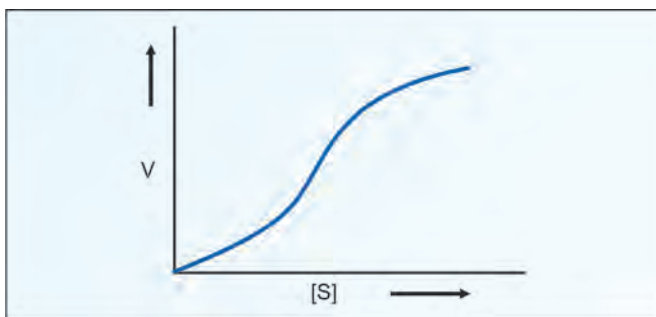


Fig. 5.16: Sigmoid substrate-saturation kinetics of cooperative binding

### Effect of Temperature

The velocity of enzyme reaction increases when temperature of the medium is increased; reaches a maximum and then falls (**Bell shaped curve**). The temperature at which maximum amount of the substrate is converted to the product per unit time is called the **optimum temperature** (Fig. 5.17). As temperature is increased, more molecules get activation energy, or molecules are at increased rate of motion. So their collision probabilities are increased and so the reaction velocity is enhanced. The **temperature coefficient** ( $Q_{10}$ ) is the factor by which the rate of catalysis is increased by a rise in  $10^\circ\text{C}$ . Generally, the rate of reaction of most enzymes will double by a rise in  $10^\circ\text{C}$ .

But when temperature is more than  $50^\circ\text{C}$ , heat denaturation and consequent loss of tertiary structure of protein occurs. So activity of the enzyme is decreased. Most human enzymes have the optimum temperature around  $37^\circ\text{C}$ . Certain bacteria living in hot springs will have enzymes with optimum temperature near  $100^\circ\text{C}$ .



Archibald Vivian Hill NP 1922  
1886–1977

### Effect of pH

Each enzyme has an optimum pH, on both sides of which the velocity will be drastically reduced. The graph will show a **bell shaped curve** (Fig. 5.18). The pH decides the charge on the amino acid residues at the active site. The net charge on the enzyme protein would influence substrate binding and catalytic activity. **Optimum pH** may vary depending on the temperature, concentration of substrate, presence of ions, etc. Usually enzymes have the optimum

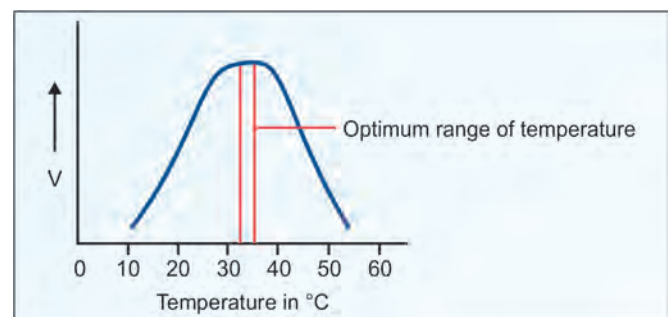


Fig. 5.17: Effect of temperature on velocity

pH between 6 and 8. Some important exceptions are **pepsin** (with optimum pH 1–2); **alkaline phosphatase** (optimum pH 9–10) and acid phosphatase (4–5).

## Enzyme Activation

- A. In presence of certain **inorganic ions**, some enzymes show higher activity. Thus, chloride ions activate salivary amylase and calcium ions activate lipase.
- B. Another type of activation is the conversion of an inactive **pro-enzyme** or **zymogen** to the active enzyme.
  - i. By splitting a single peptide bond, and removal of a small polypeptide from **trypsinogen**, the active trypsin is formed. This results in unmasking of the active center.
  - ii. Similarly trypsin activates **chymotrypsinogen**, so that A peptide (1–13 amino acids), B peptide (16–46) and C peptide (149–245) are formed from chymotrypsinogen. These 3 segments align in such a manner that histidine (57) and aspartate (102) and serine (195) residues form the active site.
  - iii. All the gastrointestinal enzymes are synthesized in the form of pro-enzymes, and only after secretion into the alimentary canal, they are activated. This prevents autolysis of cellular structural proteins.
  - iv. **Coagulation factors** are seen in blood as zymogen form, their activation pathways are described in Chapter 28.
  - v. Similar activation of precursor protein is taking place in the case of **complement components** (see Chapter 55). These activities are needed only occasionally; but when needed, a large number of molecules are to be produced instantaneously.

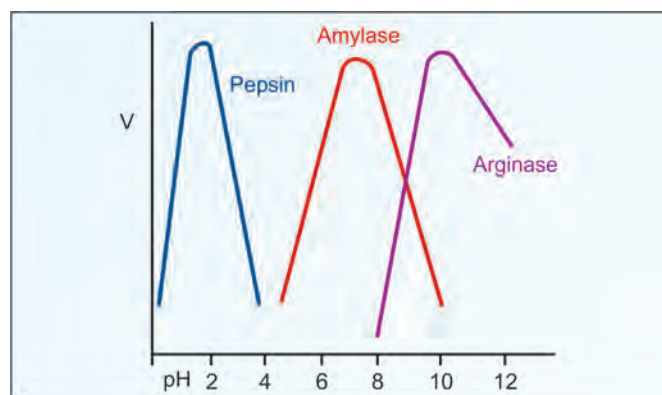


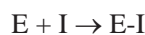
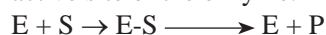
Fig. 5.18: Effect of pH on enzyme velocity

Hence, the cascade system of **chemical amplification** of such factors.

## Enzyme Inhibition

### Competitive Inhibition

- i. Here **inhibitor molecules are competing with the normal substrate** molecules for attaching with the active site of the enzyme.



- ii. Since E-I (enzyme-inhibitor complex) can react only to reform the enzyme and inhibitor, the number of enzyme molecules available for E-S formation is reduced. Suppose 100 molecules of substrate and 100 molecules of inhibitor are competing for 100 molecules of the enzyme. So, half the enzyme molecules are trapped by the inhibitor and only half the molecules are available for catalysis to form the product.
- iii. Since effective concentration of enzyme is reduced, the reaction **velocity is decreased**.
- iv. In competitive inhibition, the inhibitor will be a **structural analog** of the substrate. There will be similarity in three-dimensional structure between substrate (S) and inhibitor (I). For example, the succinate dehydrogenase reaction is inhibited by malonate (Fig. 5.19).
- v. **Competitive inhibition is usually reversible. Or, excess substrate abolishes the inhibition.** In the previous example of 100 moles of E and 100 moles of I, if 900 moles of S are added, only 1/10th of enzyme molecules are attached to inhibitor and 90% are working with substrate. Thus 50% inhibition in the first example is now decreased to 10% inhibition (Fig. 5.20).

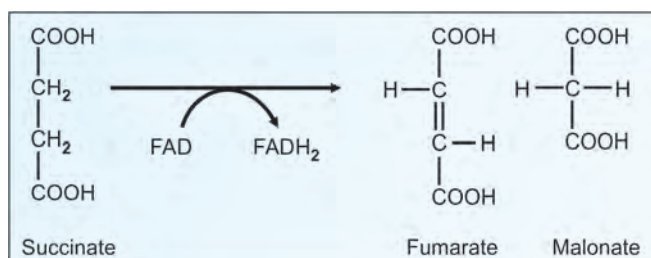


Fig. 5.19: Malonate inhibits succinate dehydrogenase enzyme



- vi. From the graphs, it is obvious that in the case of competitive inhibition, **the  $K_m$  is increased in presence of competitive inhibitor**. Thus competitive inhibitor apparently increases the  $K_m$ . In other words, the affinity of the enzyme towards substrate is apparently decreased in presence of the inhibitor.
- vii. **But  $V_{max}$  is not changed**. Clinical significance of such inhibition is shown in Box 5.10.

### Non-competitive Inhibition (Irreversible)

- i. A variety of **poisons**, such as iodoacetate, heavy metal ions (lead, mercury) and oxidizing agents act as irreversible non-competitive inhibitors. There is no competition between substrate and inhibitor (Fig. 5.22).
- ii. The inhibitor usually binds to a different domain on the enzyme, other than the substrate binding site. Since these inhibitors have no structural resemblance to the substrate, an **increase in the substrate concentration generally does not relieve this inhibition**. The saturation curve of this type of inhibition is shown in Figure 5.23. A comparison of the two types of inhibitions is shown in Table 5.6. Examples are:

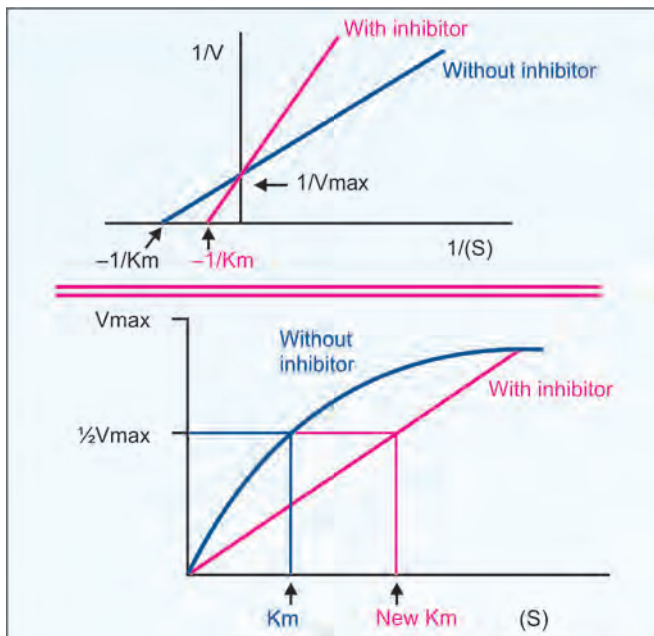


Fig. 5.20: Substrate saturation curve in presence and absence of competitive inhibitor

- a. **Cyanide** inhibits cytochrome oxidase.
- b. **Fluoride** will remove magnesium and manganese ions and so will inhibit the enzyme, enolase, and consequently the glycolysis.
- c. **Iodoacetate** would inhibit enzymes having -SH group in their active centers.
- d. **BAL** (British Anti-Lewisite; dimercaprol) is used as an antidote for heavy metal poisoning. The heavy

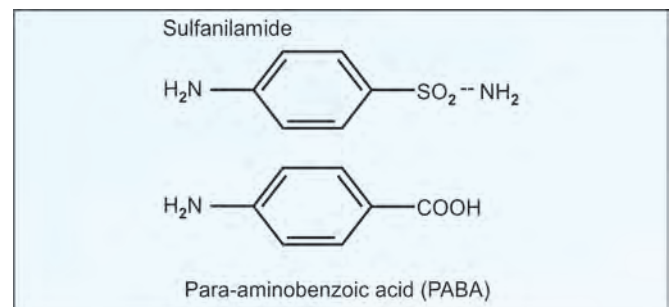


Fig. 5.21: Competitive inhibition

#### Box 5.10: Clinical importance of inhibition

**Pharmacological action** of many drugs may be explained by the principle of competitive inhibition. A few important examples are given below:

- Sulfonamides:** They are commonly employed antibacterial agents (Fig. 5.21). Bacteria synthesize folic acid by combining PABA with pteroylglutamic acid. Bacterial wall is impermeable to folic acid. Sulfa drugs, being structural analogs of PABA, will inhibit the folic acid synthesis in bacteria, and they die. The drug is nontoxic to human cells, because human beings cannot synthesize folic acid. Preformed folic acid is essential for man. Antibacterial effect of sulfa drug was studied by Gerhard Domagk, (Nobel prize 1939)
- Methotrexate:** It is 4-amino-N<sup>10</sup>-methyl folic acid. It is a structural analog of folic acid, and so can competitively inhibit folate reductase enzyme (see Chapter 38). This is essential for DNA synthesis and cell division. Therefore, methotrexate is used as an anticancer drug
- Dicoumarol:** It is structurally similar to vitamin K and can act as an anticoagulant by competitively inhibiting the vitamin K activity (see Chapter 36)
- Isonicotinic acid hydrazide (INH):** It is a commonly used antituberculous drug. It is structurally similar to pyridoxal, and prolonged use of INH may cause pyridoxal deficiency and peripheral neuropathy (see Chapter 37). A selected list of clinically **important drugs** working on the principle of competitive inhibition is given in Table 5.5.



metals act as enzyme poisons by reacting with the SH group. BAL has several SH groups with which the heavy metal ions can react and thereby their poisonous effects are reduced.

- e. **Acetylcholinesterase** enzyme cleaves acetylcholine to form acetate and choline and therefore

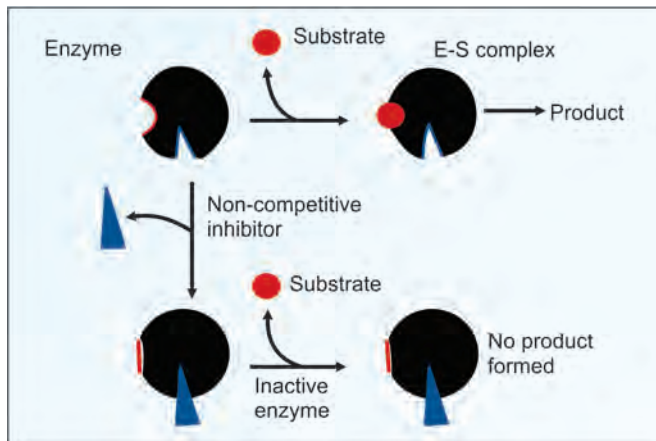


Fig. 5.22: Non-competitive inhibition



Gerhard Domagk  
NP 1939  
1895–1964

terminates the action of acetylcholine. Certain chemicals e.g. diisopropyl fluorophosphates (DFP) binds to the active site, serine of acetylcholinesterase. As a result acetylcholine accumulates and over-stimulates autonomous nervous system including heart, blood vessels and glands. This leads to vomiting, salivation, sweating, and in worst cases even death. DFP forms an irreversible covalent bond with acetylcholinesterase, and activity can be regained only if new enzyme is synthesized.

- iii. The inhibitor combines with the enzymes by forming a covalent bond and then the reaction becomes irreversible. The velocity ( $V_{max}$ ) is reduced. But  **$K_m$  value is not changed**, because the remaining enzyme molecules have the same affinity for the substrate.
- iv. **Increasing the substrate concentration** will abolish the competitive inhibition, but **will not abolish non-competitive inhibition**.

TABLE 5.5: Clinically useful competitive inhibitors

Drug	Enzyme inhibited	Clinical use	Refer chapter
1. Allopurinol	Xanthine oxidase	Gout	43
2. Dicoumarol	Vitamin K-epoxide-reductase	Anticoagulant	36
3. Penicillin	Transpeptidase	Antibiotic	2
4. Sulfonamide	Pteroid synthetase	Antibiotic	38
5. Trimethoprim	FH2-reductase	Antibiotic	38
6. Pyrimethamine	Do	Malaria	38
7. Methotrexate	Do	Cancer	57
8. 6-mercaptopurine	Adenylosuccinate synthetase	Cancer	57
9. 5-fluorouracil	Thymidylate synthase	Cancer	57
10. Azaserine	Phosphoribosyl-amidotransferase	Cancer	57
11. Cytosine arabinoside	DNA polymerase	Cancer	57
12. Acyclovir	Do	Virus	47
13. Neostigmine	ACh-esterase	Myasthenia	23
14. Alpha-methyl dopa	Dopa-decarboxylase	Hypertension	18
15. Lovastatin	HMGCoA-reductase	Cholesterol lowering	13
16. Oseltamiver (Tamiflu)	Neuraminidase	Influenza	47

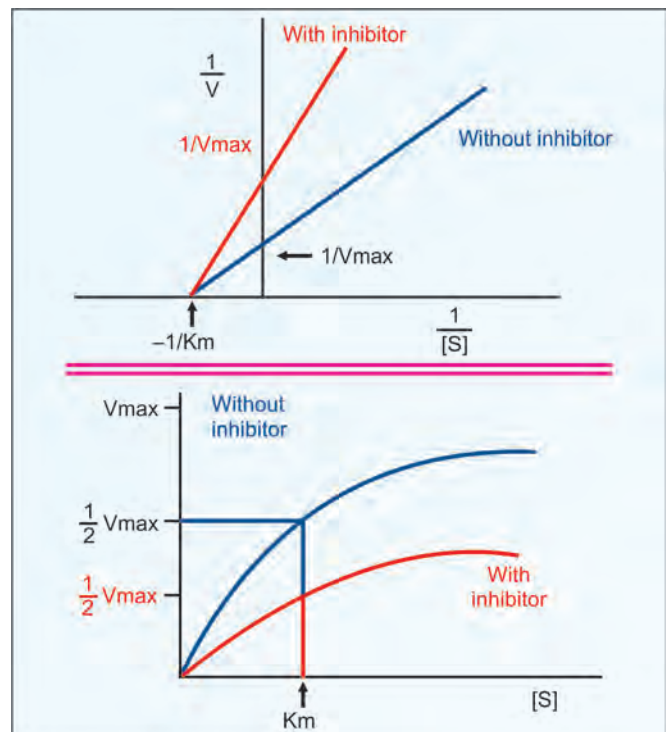


Fig. 5.23: Non-competitive inhibition

## Uncompetitive Inhibition

Here inhibitor does not have any affinity for free enzyme. Inhibitor binds to enzyme–substrate complex; but not to the free enzyme. In such cases both  $V_{max}$  and  $K_m$  are decreased (Fig. 5.24). Inhibition of placental alkaline phosphatase (Regan iso-enzyme) by phenylalanine is an example of uncompetitive inhibition.

## Suicide Inhibition

- It is a special type of **irreversible** inhibition of enzyme activity. It is also known as **mechanism based inactivation**. The inhibitor makes use of the enzyme's own reaction mechanism to inactivate it (mechanism based inactivation).
- In suicide inhibition, the structural analog is converted to a more effective inhibitor with the help of the enzyme to be inhibited. The substrate-like compound initially binds with the enzyme and the first few steps of the pathway are catalyzed.
- This new product irreversibly binds to the enzyme and inhibits further reactions.
- For example, **ornithine decarboxylase (ODC)** catalyzes the conversion of ornithine to putrescine which is necessary for polyamine synthesis (see Chapter 17). When the ODC in trypanosoma is inhibited multiplication of the parasite is arrested. Therefore inhibitors of ODC enzyme such as difluoromethylornithine (DFMO) has been found to be effective against **trypanosomiasis** (sleeping sickness). DFMO is initially inert, but on binding with the enzyme, forms irreversible covalent complex with the co-enzyme (pyridoxal phosphate) and the amino acid residues of the enzyme. In mammalian cells, the turnover rate of ODC is very high, and so the inhibition by DFMO is only transient. So DFMO kills the parasites with no side effects to the patient.

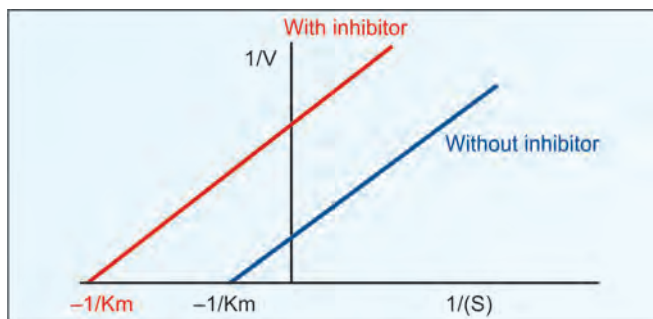
- A similar mechanism is observed in the case of **Allopurinol** that is oxidized by xanthine oxidase to alloxanthine which is a more potent inhibitor of xanthine oxidase (see Chapter 43).
- The anti-inflammatory action of **Aspirin** is also based on suicide inhibition. Arachidonic acid is converted to prostaglandin by the enzyme **Cyclo-oxygenase** (see Chapter 14). Aspirin acetylates a serine residue in the active center of cyclo-oxygenase, thus prostaglandin synthesis is inhibited, and so inflammation subsides.

## Allosteric Regulation

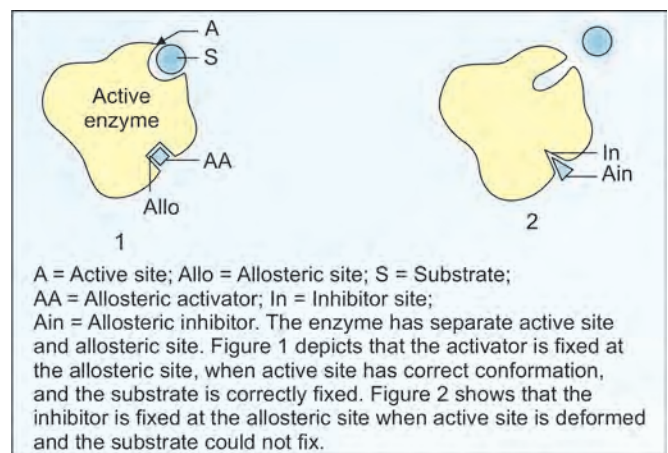
- Allosteric enzyme has one catalytic site where the substrate binds and another **separate allosteric site** where the modifier binds (*allo* = other) (Fig. 5.25).
- Allosteric and substrate binding sites may or may not be physically adjacent.
- The binding of the regulatory molecule can either enhance the activity of the enzyme (allosteric activation), or inhibit the activity of the enzyme (allosteric inhibition).
- In the former case, the regulatory molecule is known as the **positive modifier** and in the latter case as the **negative modifier**.
- The binding of substrate to one of the subunits of the enzyme may enhance substrate binding by other subunits. This effect is said to be **positive cooperativity**. If the binding of substrate to one of the subunits

**TABLE 5.6:** Comparison of two types of inhibition

	Competitive inhibition	Non-competitive inhibition
Acting on	Active site	May or may not
Structure of inhibitor	Substrate analog	Unrelated molecule
Inhibition is	Reversible	Generally irreversible
Excess substrate	Inhibition relieved	No effect
$K_m$	Increased	No change
$V_{max}$	No change	Decreased
Significance	Drug action	Toxicological



**Fig.5.24:** Uncompetitive Inhibition



**Fig. 5.25:** Action of allosteric enzymes

decreases the avidity of substrate binding by other sites, the effect is called **negative cooperativity**.

- vi. In most cases, a combination is observed, resulting in a sigmoid shaped curve (Fig. 5.26). Salient features of allosteric regulation are enumerated in Box 5.11.

## Key Enzymes

- i. Body uses allosteric enzymes for regulating metabolic pathways. Such a **regulatory enzyme** in a particular pathway is called the **key enzyme** or **rate limiting enzyme**.
- ii. The flow of the whole pathway is constrained as if there is a bottle neck at the level of the key enzyme.
- iii. The allosteric inhibitor is most effective when substrate concentration is low. This is metabolically very significant. When more substrate molecules are available, there is less necessity for stringent regulation. A few examples are given in detail below:
  - a. **Phosphofructokinase 1**  

$$\text{Fructose-6-phosphate} + \text{ATP} \longrightarrow \text{Fructose,1,6 bisphosphate} + \text{ADP}$$

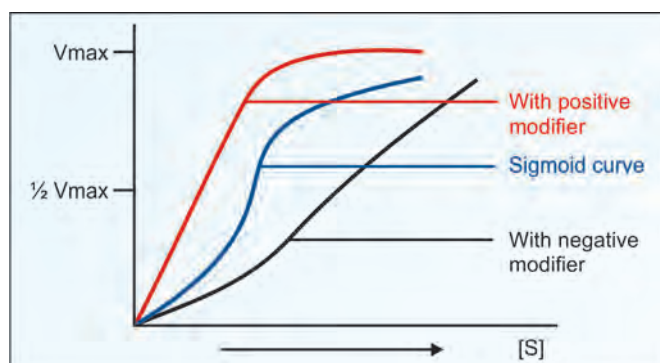
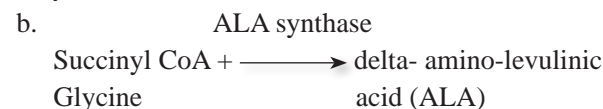


Fig. 5.26: Allosteric inhibition

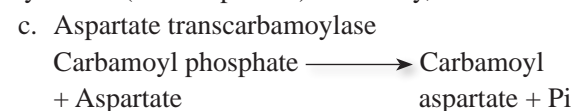
### Box 5.11: Salient features, allosteric regulation

1. The inhibitor is **not** a substrate analog.
2. It is partially reversible, when excess substrate is added
3.  $K_m$  is usually increased
4.  $V_{max}$  is reduced
5. The effect of allosteric modifier is maximum at or near substrate concentration equivalent to  $K_m$  (Fig.5.26). When an inhibitor binds to the allosteric site, the configuration of catalytic site is modified such that substrate cannot bind properly
6. Most allosteric enzymes possess quaternary structure. They are made up of subunits, e.g. Aspartate transcarbamoylase has 6 subunits and pyruvate kinase has 4 subunits. Examples of allosteric enzymes are shown in Table 5.7.

This is the committed step in glycolysis. ATP acts as an allosteric inhibitor (negative modifier) of PFK1. When the cellular level of ATP rises, glycolysis can slow down and ATP binds to the allosteric site, thus inhibiting the reaction. A high level of AMP within the cell indicates a low level of ATP. Hence AMP acts as an allosteric activator (positive modifier) of the enzyme.



This is the first step in heme biosynthesis. *The end product, heme will allosterically inhibit the ALA synthase.* This enzyme is the key enzyme of heme synthesis (see Chapter 21). Similarly,



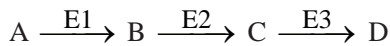
This is the first step in the pathway which finally produces cytidine triphosphate (CTP) (Chapter 43). *CTP, the end product will allosterically inhibit aspartate transcarbamoylase.* There is no structural resemblance between aspartate and CTP. Other such allosteric enzymes are listed in Table 5.7.

## Feedback Inhibition

The term feedback inhibition or **end-product** inhibition means that the activity of the enzyme is inhibited by the final product of the biosynthetic pathway.

TABLE 5.7: Examples of allosteric enzymes

Enzyme	Allosteric inhibitor	Allosteric activator	Chapter
1. Phosphofructokinase	ATP, citrate	AMP, F-2,6-P	9
2. ALA synthase	Heme		22
3. Aspartate trans-carbamoylase	CTP	ATP	43
4. HMG CoA-reductase	Cholesterol		13
5. Pyruvate carboxylase	ADP	AcetylCoA	9
6. Acetyl CoA-carboxylase	AcylCoA	Citrate	12
7. Citrate synthase	ATP		19
8. Carbamoyl phosphate synthetase I		NAG	15
9. Carbamoyl phosphate synthetase II	UTP		43



In this pathway, if D inhibits E1, it is called feedback inhibition. For example, AMP inhibits the first step in purine synthesis (see Chapter 43). Usually such end product inhibition is effected allosterically. Inhibition of aspartate transcarbamoylase by CTP is an example for end product inhibition.

## Induction

Induction is effected through the process of derepression. The *inducer will relieve the repression on the operator site* and will remove the block on the biosynthesis of the enzyme molecules. Classical example is the induction of lactose-utilizing enzymes in the bacteria when the media contains lactose in the absence of glucose (details in Chapter 47). There will be a minimal level of the enzyme inside the cell, but in presence of the inducer, the level will go up to thousand or million times within hours. By this mechanism nutrients are utilized most efficiently; while the enzyme synthesis is kept to the optimum. **Tryptophan pyrrolase** and transaminases are induced by glucocorticoids. **Glucokinase** is induced by insulin. **ALA synthase** is induced by barbiturates.

## Repression

Even though both inhibition and repression reduce the enzyme velocity, the mechanisms are different. In the case of **inhibition**, the inhibitor acts on the enzyme directly; the inhibitory activity is noticed as soon as the inhibitor is added; and the number of enzyme molecules is not changed by the inhibitor.

On the contrary, **repressor** acts at the gene level; the effect is noticeable only after a lag period of hours or days; and the number of enzyme molecules is reduced in the presence of repressor molecule. Details of repression

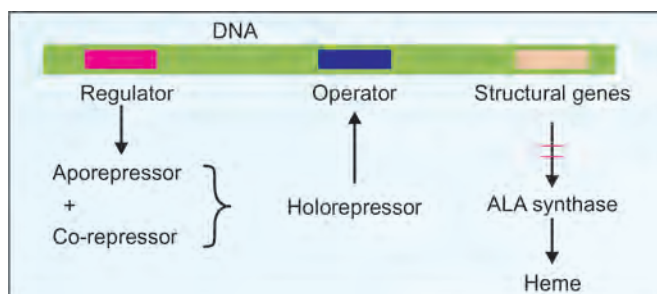


Fig. 5.27: Repression of ALA synthase

are given in Chapter 47. A summary of the mechanism of repression is given in Figure 5.27.

The key enzyme of heme synthesis, **ALA synthase** is autoregulated by heme by means of repression. The structural gene is transcribed and later translated to produce the enzyme molecules. The transcription process starts at the **operator** site when it is free. When heme is not available, this operator site is open, and therefore the enzyme is being synthesized. When heme is produced in plenty, heme acts as the co-repressor and in combination with an apo-repressor, heme will shut off the operator site. Now further production of ALA synthase is stopped.

## Covalent Modification

The activity of enzymes may be increased or decreased by covalent modification. It means, either addition of a group to the enzyme protein by a covalent bond; or removal of a group by cleaving a covalent bond.

**Zymogen activation** by partial proteolysis is an example of covalent activation. Addition or removal of a particular group brings about covalent modification of enzyme protein. This is a reversible reaction.

The most common type of covalent modification is the reversible **protein phosphorylation**. The phosphate group may be attached to serine, threonine or tyrosine residues. When hormone binds to the membrane bound receptor, hormone-receptor complex (HR) is formed. The enzyme adenylate cyclase is activated. This activation is mediated through a G protein (see Chapter 50). The active adenylate cyclase converts ATP to cyclic AMP (cAMP), which acts as a second messenger. It activates protein kinase by binding to the regulatory subunit of the enzyme. The active catalytic subunit will phosphorylate the enzyme. Table 5.8 gives a

TABLE 5.8: Examples of covalent modification

Enzyme	Phosphorylated enzyme
Acetyl-CoA carboxylase	Inactive
Glycogen synthase	Inactive
Pyruvate dehydrogenase	Inactive
HMG CoA reductase	Inactive
Pyruvate kinase	Inactive
PFK2	Inactive
Glycogen phosphorylase	Active
Phosphorylase b kinase	Active
HMG CoA reductase kinase	Active



partial list of examples of such activation by phosphorylation/dephosphorylation.

**ADP ribosylation** is another covalent modification, where an ADP-ribose from  $\text{NAD}^+$  is added to enzyme/protein. For example, ADP ribosylation of alpha subunit of G-protein leads to inhibition of GTPase activity; hence G protein remains active. Cholera toxin and pertussis toxin act through ADP ribosylation. ADP ribosylation of glyceraldehyde-3-phosphate dehydrogenase results in inhibition of glycolysis.

### Stabilization

Enzyme molecules undergo usual wear and tear and finally get degraded. Such degradation if prevented can lead to increased overall enzyme activity. This is called stabilization of enzyme. Degradation of Tryptophan pyrrolase is retarded by tryptophan. Phosphofructokinase is stabilized by growth hormone. Enzymes having SH-groups (Papain, Urease, Succinate dehydrogenase) are stabilized by glutathione (G-SH).

### Compartmentalization

The activity of enzymes catalyzing the different steps in a metabolic pathway may be regulated by compartmentalization of enzymes. Certain enzymes of the pathway may be located in mitochondria whereas certain other enzymes of the same pathway are cytoplasmic. For example, heme synthesis (see Chapter 21), urea cycle (see Chapter 15) gluconeogenesis (see Chapter 9). The intermediates have to be shuttled across the mitochondrial membrane for this purpose which provides a point where controls can be exerted.

## SPECIFICITY OF ENZYMES

### Absolute Specificity

Some enzymes are absolutely specific. For example, hydrolysis of urea to ammonia and carbon dioxide is catalyzed by urease. Urea is the only substrate for **urease**. Thiourea, though structurally similar to urea, will not act as the substrate for urease. Similarly glucose oxidase will oxidize only beta-D-glucose and no other isomeric form. Thus, these enzymes show absolute specificity.

### Bond Specificity

Most of the proteolytic enzymes are showing group (bond) specificity. For example, trypsin can hydrolyze peptide bonds formed by carboxyl groups of arginine or lysine residues in any protein.

### Group Specificity

One enzyme can catalyze the same reaction on a group of structurally similar compounds, e.g. hexokinase can

catalyze phosphorylation of glucose, galactose and mannose.

### Stereospecificity

Human enzymes are specific for L-amino acids and D-sugars. Fumarase will hydrate fumaric acid (transform) to malic acid; but the corresponding cis form, maleic acid will not be acted upon (Fig. 5.28). Lactate dehydrogenase, acting on pyruvate will form only L-lactate, but not the D variety.

### Ribozymes

In the first part of this chapter, it is stated that all enzymes are proteins. Invariably, all rules will have exceptions. Ribozymes are RNA molecules with enzymatic activity, which catalyze cutting of nascent mRNA or primary transcript (see Chapter 45).

### Enzyme Assays and Units

Enzymes are assayed by taking the serum sample and adding a suitable substrate. After the incubation time, the mixture is assayed for the product formed.

$\text{NAD}^+$  or  $\text{NADP}^+$  dependent enzymes are assayed by spectrophotometry, as the reduced form of these co-enzymes will absorb light at a wavelength of 340 nm; but their oxidized forms will not absorb light.

A reaction of our interest can be suitably coupled with another reaction utilizing  $\text{NAD}^+$  or  $\text{NADP}^+$  and then the reaction rate can be measured.

**Enzyme activity** is expressed as micromoles of substrate converted to product per minute under specified assay conditions. One **standard unit** (or International Unit) of enzyme activity (U) is the amount of enzyme that will convert one micromole of substrate per minute per liter of sample and is abbreviated as U/L.

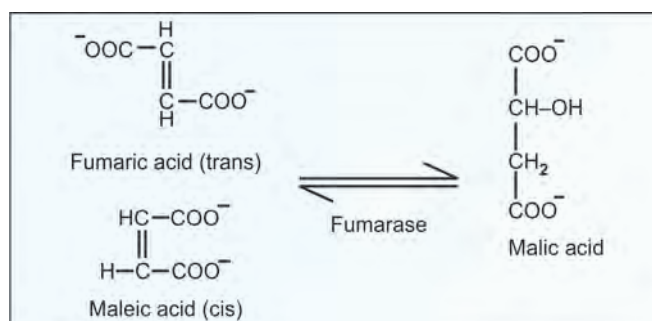


Fig. 5.28: Example of stereospecificity



The modern method of expression of enzyme activity is in **Katals (kat)**. One **Katal** (catalytic activity) is defined as the number of mol of substrate transformed per second per liter of sample ( $K_{cat} = V_{max}$  divided by the number of active sites). ( $60 \text{ U} = 1 \text{ nkat}$  and  $1 \text{ nkat} = 0.06 \text{ U}$ ) ( $1 \text{ I.U.} = 1 \text{ mmol/min} = 16.67 \text{ nkat}$ ). When expressed in katals, the activity of different enzymes can be compared.

**Catalytic efficiency** is expressed as the ratio of  $K_{cat}$  divided by  $K_m$ .

**Specific activity** is the number of enzyme units present per milligram of protein ( $V_{max}$  divided by the protein concentration). It is a measure of the purity of the preparation.

**Turnover number** is the number of substrate molecules transformed per unit time by a single enzyme molecule or by a single catalytic site ( $V_{max}$  divided by number of enzyme molecules). This is estimated in purified preparations of enzymes. The turnover number of catalase is 40,000,000; that of carbonic anhydrase is 400,000 and fumarase is 800.

### Body Metabolism is Controlled by Enzymes

In a pipe, theoretically water can flow both ways, but practically the flow is unidirectional. In the same way, although most of the individual enzyme activities are readily reversible, the pathway as a whole, tends to lead towards the final product.

In the reaction series,  $A \rightarrow B \rightarrow C$ , as soon as C is produced, it is utilized for something else, so that the reactions as a whole, tend to go in the forward direction only. True equilibrium of chemical reactions in the cell is achieved only when the cell is dead. In other words, living cells avoid the state of chemical equilibrium. At the same time, if we analyse a particular metabolite, the concentration is more or less kept constant over very long periods. This is called **steady-state system**. For example, blood glucose level is kept within a narrow range, because the factors, which tend to increase the level are at dynamic equilibrium with the factors that try to decrease the level.

Deficiency of the enzyme or its activity will lead to genetic defects, inborn errors of metabolism. Such deficiency may be due to genetic mutation or by infections.

### Drug Metabolism

Enzymes present in human being or in pathogen act on the drugs. Penicillin blocks cell wall synthesis in bacteria by irreversible binding of the enzyme transpeptidase. Many bacteria, however, produce beta-lactamases that hydrolyze the penicillin. Another example is that the drug 5-fluoro uracil is metabolized inside human body into deoxy fluoro uridylic acid, which inhibits thymidylate synthase, and hence acts as an anticancer drug.

### Enzyme Engineering

Enzymes are widely used in food, pharmaceutical and chemical industries. Bacterial enzymes from time immemorial, accomplish **fermentation** of food items. Making of curd from milk by *Lactobacillus acidophilus*; producing yogurt or cheese by *Streptococcus thermophilus*;

and fermenting rice and black gram by *Leuconostoc mesenteroides* for preparing delicious doshas are good examples. In **washing** powders, enzymes are incorporated to remove stains from clothes.

### Drug Designing

With the help of computer programming, it is nowadays possible to get an idea of the three-dimensional structure of active site of enzyme, which exactly fits the substrate. With this knowledge, research workers could make theoretical models of hundreds of different inhibitors. The best few are selected and then experiments are done in vivo. This approach to drug designing is getting rapid momentum in medical field.

### Processive Enzymes

They continue to act on a particular substrate; and do not dissociate between repetitions of the catalytic event. Examples are DNA polymerase, RNA polymerase, glycogen synthase and fatty acid synthase.

### Multi-enzyme Complexes

Generally enzymes are diffusion limited, meaning that the rate of reaction is limited by the rate at which substrate molecules diffuse through solution and reach the active site of the enzyme. In a series of reactions, the product of the first enzyme diffuses into the surrounding medium, later reaches the second enzyme. This may act as a hindrance for the smooth and efficient work of the enzymes in a metabolic pathway. Nature circumvents this problem, by keeping all the enzymes of a reaction sequence into a multi-enzyme complex, so that the product of the first reaction is immediately transferred to the second enzyme and so on. Examples are fatty acid synthase (see Chapter 12) pyruvate dehydrogenase, alpha-keto glutarate dehydrogenase, acetyl CoA carboxylase, glycine cleavage system and pyruvate carboxylase and pyrimidine nucleotide synthesis (see Chapter 43).

### Sequential Reactions or Single Displacement Reactions

In such cases, both substrates are first combined with the enzyme to form a ternary complex, then catalysis is followed. Most of the  $\text{NAD}^+$  dependent reactions follow this principle.

### Ping Pong Reactions or Double Displacement Reactions

They involve a transient modified form of the enzyme. The group undergoing transfer is first taken from one substrate A, added to the enzyme, subsequently the group is taken from the modified enzyme, and added to another substrate. Examples are aminotransferases.

## ISO-ENZYMES

They are **physically distinct forms of the same enzyme activity**. Multiple molecular forms of an enzyme are described as iso-enzymes or isozymes. If 50 paise coins

are examined carefully, there will be minor variations of ridges on the rims and number of dots below the year. In the market, all these coins have the same face value; but to an experienced numismatist, these variations will explain from which mint it was produced. In the same way, different molecular forms of the same enzyme synthesized from various tissues are called iso-enzymes. Hence, study of iso-enzymes is very useful to understand diseases of different organs. If the subunits are all the same, the protein is a **homomultimer** represented by a single gene. If the subunits are different, protein is said to be a **heteromultimer**, produced by different genes.

### Iso-enzymes may be Formed in Different Ways

1. They may be products of different genes (more than one locus) in which case they are known as **true iso-enzymes**. The genes may be located on different chromosomes, e.g. salivary and pancreatic amylase.
2. In certain cases, all the different forms are present in the same individual, e.g. **Lactate dehydrogenase** (LDH) has 5 iso-enzymes and all are seen in all persons in the population (see Chapter 23).
3. The same locus of the gene may have different alleles (alternate forms). Such allelic iso-enzymes are called **allozymes**. In this case, only one form will be present in one individual; but all the different forms will be seen in total population. For example, more than 400 distinct forms of **glucose-6-phosphate dehydrogenase** (GPD) have been identified; all of them are produced by the same locus on the X-chromosome. When iso-enzymes due to variation at a single locus occur with appreciable frequency (more than 1% in population), it is said to be **polymorphism**.
4. Molecular heterogeneity of enzymes may also be produced after the protein is synthesized (post-translational modification). These are called **iso-forms**, e.g. sialic acid content in alkaline phosphatase (ALP) iso-enzymes. Different types of iso-forms may be seen in the same individual.

### Identification of Iso-Enzymes

1. In Agar gel or polyacrylamide gel **electrophoresis**, the iso-enzymes have different mobility. LDH, CK and ALP iso-enzymes can be separated by electrophoresis.
2. **Heat stability**: One of the iso-enzymes may be easily denatured by heat, e.g. bone iso-enzyme of ALP (BALP).
3. **Inhibitors**: One of the iso-enzymes may be sensitive to one inhibitor, e.g. tartrate labile ACP.
4. Km value or **substrate specificity** may be different for iso-enzymes, e.g. glucokinase has high Km and hexokinase has low Km for glucose.
5. **Co-factor** requirements may be different for iso-enzymes. Mitochondrial isocitrate dehydrogenase is NAD<sup>+</sup> dependent and the cytoplasmic iso-enzyme is NADP<sup>+</sup> dependent.

6. Tissue **localization** may be different for iso-enzymes. H4 form of LDH is present in heart, while M4 variety is seen in skeletal muscle.
7. Specific antibodies may identify different types of iso-enzymes. For example, CK iso-enzymes are separated by antibodies.

### Related Topics

Iso-enzymes of LDH, CK, ALP; enzymes used for therapeutic and diagnostic purposes and immobilized enzymes are described in Chapter 23. Enzyme linked immunosorbent assay as well as protein purification techniques are summarized in Chapter 35.

## QUICK LOOK OF CHAPTER 5

1. Almost all enzymes are proteins.
2. Enzymes can be classified into (i) Oxidoreductases (e.g. alcohol dehydrogenase) (ii) Transferases (e.g. hexokinase) (iii) Hydrolases (e.g. acetyl cholinesterase) (iv) Lyases (e.g. Aldolase) (v) Isomerases (e.g. triose phosphate isomerase) (vi) Ligases (e.g. acetyl CoA carboxylase).
3. Enzymes may be simple or compound proteins. In case of compound proteins, the protein component is termed 'apo-enzyme' and the prosthetic group is termed 'co-enzyme'. The combination produces a functional 'holo-enzyme'.
4. Co-enzymes may be involved in the transfer of hydrogen (e.g. NAD, FAD, FMN) or groups other than hydrogen (e.g. amino group by PLP, hydroxyethyl group by TPP).
5. Enzymes requiring the presence of a certain metal ion for their activity are called Metalloenzymes. Examples are Zinc in carbonic anhydrase, Iron in catalase and peroxidase, Calcium in lipase, etc.
6. Michaelis-Menten theory states that an enzyme (E) combines with a substrate (S) to form an enzyme-substrate (E-S) complex, which breaks down to give product (P).
7. Theories proposed to explain the mechanism of enzyme action are Fischer's template (lock and key) theory and Koshland's induced fit theory.
8. Area of an enzyme where the catalysis occurs is called the 'active site'.
9. Amino acid residues of the enzyme involved directly in the binding of the substrate are called 'catalytic residues'.

10. Enzyme activity is influenced by enzyme concentration, substrate concentration, pH, temperature and presence of inhibitors.
11.  $K_m$  value is characteristic of a given enzyme. No two enzymes can have the same  $K_m$  value. It denotes the affinity of the enzyme to its substrate. Lesser the  $K_m$ , greater the affinity and vice versa.
12. Enzyme inhibition can be competitive, non-competitive or uncompetitive. Competitive inhibition is usually reversible.
13. Actions of drugs, such as Sulfonamides, Methotrexate, Dicoumarol and Isoniazid are based on the principle of competitive inhibition.
14. Suicide inhibition is an irreversible inhibition. The inhibitor makes use of the natural reaction of the enzyme for inhibition, e.g. ornithine decarboxylase.
15. The allosteric site is different from the catalytic site and enzymes, which possess the site, are termed 'allosteric enzymes'.
16. Key enzyme or Rate limiting enzyme in a pathway has the lowest  $K_m$  value for its substrate.
17. Enzyme activity in the body is regulated by allosteric inhibition, covalent modification, induction, repression.
18. Specificity of enzymes could be Absolute (Urease), Group (Trypsin) or Stereo (Lactate dehydrogenase).
19. Iso-enzymes are physically distinct forms of the same enzyme activity. They may be products of the same gene or different genes.
20. Iso-enzymes, which are products of different genes, are called 'true iso-enzymes', e.g. salivary and pancreatic amylase.

# CHAPTER 6

## Chemistry of Carbohydrates

### Chapter at a Glance

The reader will be able to answer questions on the following topics:

- Nomenclature and classification of sugars
- Stereoisomers
- Glucose, mannose and galactose
- Fructose
- Reactions of monosaccharides
- Glycosides
- Amino sugars and deoxy sugars
- Pentoses
- Sucrose, lactose and maltose
- Starch, glycogen and cellulose
- Heteroglycans, mucopolysaccharides

### Functions of Carbohydrates

1. Carbohydrates are the main sources of **energy** in the body. Brain cells and RBCs are almost wholly dependent on carbohydrates as the energy source. Energy production from carbohydrates will be 4 kcal/g.
2. Storage form of energy (starch and glycogen).
3. Excess carbohydrate is converted to fat.
4. Glycoproteins and glycolipids are components of cell membranes and receptors.
5. Structural basis of many organisms: Cellulose of plants; exoskeleton of insects, cell wall of microorganisms, mucopolysaccharides as ground substance in higher organisms.

The general molecular formula of carbohydrate is  $C_n(H_2O)_n$ . For example, glucose has the molecular formula  $C_6H_{12}O_6$ . Carbohydrates are **polyhydroxy aldehydes or ketones** or compounds which yield these on hydrolysis (Fig. 6.1).

### NOMENCLATURE

Molecules having only one actual or potential sugar group are called **monosaccharides** (Greek, mono = one; saccharide = sugar). They cannot be further hydrolyzed into smaller units. When two monosaccharides are combined together with elimination of a water molecule, it is called a **disaccharide** (e.g.  $C_{12}H_{22}O_{11}$ ). **Trisaccharides** contain three sugar groups. Further addition of sugar groups will correspondingly produce tetrasaccharides, pentasaccharides and so on, commonly known as **oligosaccharides** (Greek, oligo = a few). When more than

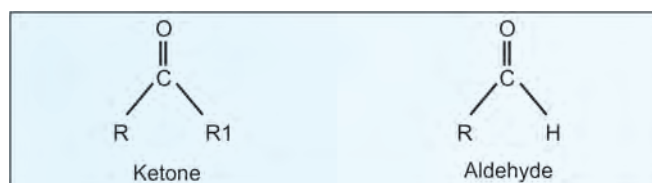


Fig. 6.1: Keto group and aldehyde group

10 sugar units are combined, they are generally named as **polysaccharides** (Greek, poly = many). Polysaccharides having only one type of monosaccharide units are called **homopolysaccharides** and those having different monosaccharide units are **heteropolysaccharides**.

Sugars having aldehyde group are called **aldoses** and sugars with keto group are **ketoses**. Depending on the number of carbon atoms, the monosaccharides are named as triose (C3), tetrose (C4), pentose (C5), hexose (C6), heptose (C7) and so on. Commonly occurring monosaccharides are given in Table 6.1.

## STEREISOMERS

Compounds having same structural formula, but differing in spatial configuration are known as stereoisomers. While writing the molecular formula of monosaccharides, the spatial arrangements of H and OH groups are important, since they contain asymmetric carbon atoms. Asymmetric carbon means that four different groups are attached to the same carbon. The reference molecule is glyceraldehyde (glycerose) which has a single asymmetric carbon atom (Fig. 6.2).



Fig. 6.2: Stereoisomers

TABLE 6.1: Common monosaccharides			
No. of carbon atoms	Generic name	Aldoses (with aldehyde group)	Ketoses (with keto group)
3	Triose	Glyceraldehyde	Dihydroxy-acetone
4	Tetrose	Erythrose	Erythrulose
5	Pentose	Arabinose, Xylose, Ribose	Xylulose, Ribulose
6	Hexose	Glucose, Galactose, Mannose	Fructose
7	Heptose		Sedoheptulose

The number of possible stereoisomers depends on the number of asymmetric carbon atoms by the formula  $2^n$  where n is the number of asymmetric carbon atoms.

## Reference Carbon Atom of Sugars

The configuration of H and OH groups at the second carbon atom of glyceraldehyde (Fig. 6.2) may be noticed. The two mirror forms are denoted as D- and L-varieties. All monosaccharides can be considered as molecules derived from glyceraldehyde by successive addition of carbon atoms. Therefore, **penultimate carbon atom is the reference carbon atom** for naming the mirror images (Fig. 6.3).

## D and L Isomerism of Glucose

With reference to the penultimate carbon atom (i.e. C5 in the case of glucose), the configuration of H and OH groups is changed and two mirror images are produced (Fig. 6.3). It may be noted that in D and L varieties, the groups in 2nd, 3rd, 4th and 5th carbon atoms are totally reversed, so as to produce the mirror images. These two forms are also stereoisomers. **D-sugars are naturally occurring** sugars and body can metabolize only D-sugars.

## Optical Activity

The presence of asymmetrical carbon atom causes optical activity. When a beam of plane-polarized light is passed through a solution of carbohydrates, it will rotate the light either to right or to left. Please note that the D- and L-notation has no bearing with the optical activity. Depending on the rotation, molecules are called dextrorotatory (+) (d) or levorotatory (-) (l). Thus **D-glucose is dextrorotatory but D-fructose is levorotatory**. Equimolecular mixture

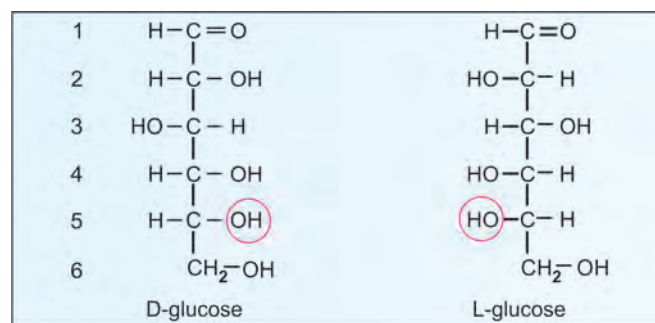


Fig. 6.3: Penultimate (reference) carbon atom



of optical isomers has no net rotation (**racemic mixture**). Heyrovsky was awarded Nobel prize in 1959 for polarographic analysis of sugars.

## Diastereoisomers of Glucose

Configurational changes with regard to C2, C3 and C4 will produce eight different monosaccharides. Out of these, only 3 are seen in human body. They are **Glucose, Galactose and Mannose**. (Fig. 6.4 and Table 6.2).

There are 8 diastereoisomers for aldohexoses. With reference to C5, all of them will have D and L forms. Hence the molecular formula of hexose ( $C_6H_{12}O_6$ ) represents 16 different monosaccharides, due to spatial arrangement of constituent groups.

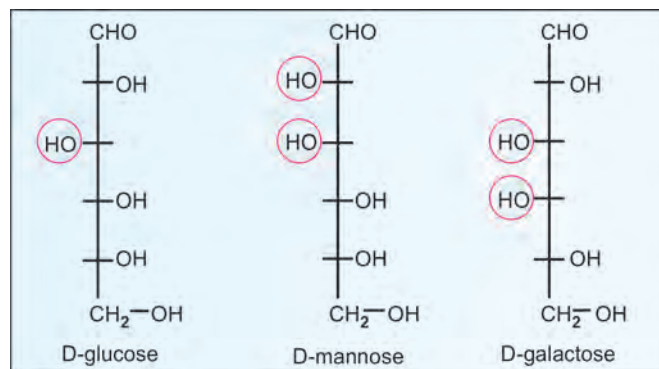
**Glucose** is the most predominant sugar in human body. It is the major source of energy. It is present in blood (Table 6.2). D-glucose is dextro-rotatory. In clinical practice, it is often called as **dextrose** (Box 6.5).

**Galactose** is a constituent of lactose (milk sugar) and glycoproteins. Galactose is epimerized to glucose in liver and then utilized as a fuel. The term galactose is derived from Greek word “gala”, meaning milk.

**Mannose** is a constituent of many glycoproteins. Mannose was isolated from plant mannans; hence the name.

**TABLE 6.2:** Hexoses of physiological importance

Sugar	Importance
D-Glucose	Blood sugar, main source of energy in body
D-Fructose	Constituent of sucrose, the common sugar
D-Galactose	Constituent of lactose, glycolipids and glycoproteins
D-Mannose	Constituent of globulins, mucoproteins and glycoproteins



**Fig. 6.4:** Epimers of D-glucose

## Epimerism of Aldoses

When sugars are different from one another, only in configuration **with regard to a single carbon atom, other than the reference carbon atom**, they are called epimers. For example, glucose and mannose are an epimeric pair which differ only with respect to C2. Similarly, galactose is the 4th epimer of glucose (Fig. 6.4). Galactose and mannose are not epimers but diastereoisomers.

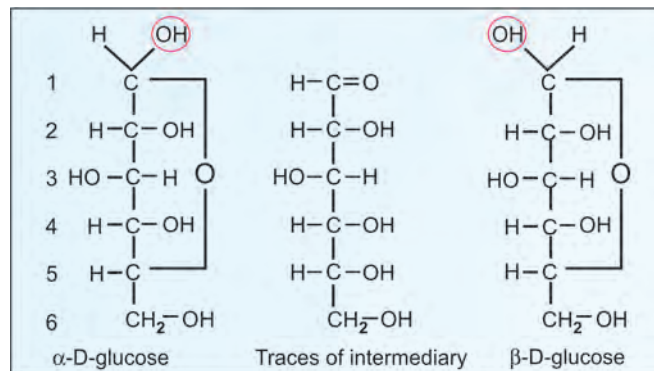
## Anomerism of Sugars

When D glucose is crystallized at room temperature, and a fresh solution is prepared, its specific rotation of polarized light is +112°; but after 12–18 hours it changes to +52.5°. If initial crystallization is taking place at 98°C and then solubilized, the specific rotation is found to be +19°, which also changes to +52.5° within a few hours. This change in rotation with time is called **mutarotation**.

### Box 6.1: Practical importance of mutarotation

In a clinical laboratory, once a technician freshly prepared a standard solution (100 mg/100 mL) of glucose. She compared it with another standard solution similarly prepared one week ago. The comparison was done by glucose-oxidase method. To her surprise, the freshly prepared solution showed only one-tenth strength of the old solution. Testing a second time, she got the same results. So she asked for the help of her boss, an MD in Biochemistry, who suggested to keep the new solution, overnight in fridge. The next day, both one-week-old solution and the new (kept overnight) solution gave identical results. The technician was not able to explain the reason for this change. Can you explain?

Answer: When glucose solution is freshly prepared, most of the molecules are in  $\alpha$ -form. On keeping the solution for 18 hours, "mutarotation" takes place, and 63% molecules are changed to  $\beta$ -configuration. The glucose-oxidase enzyme preferentially acts on the  $\beta$ -form. Hence, freshly prepared solutions will give lower values.



**Fig. 6.5:** Anomers of D-glucose

This is explained by the fact that D-glucose has two anomers, **alpha and beta varieties**. These anomers are produced by the spatial configuration with reference to the first carbon atom in aldoses and second carbon atom in ketoses (Fig. 6.5). Hence, these carbon atoms are known as **anomeric carbon atoms**. Thus  $\alpha$ -D-glucose has specific rotation of  $+112^\circ$  and  $\beta$ -D-glucose has  $+19^\circ$ . Both undergo mutarotation and at equilibrium one-third molecules are alpha type and 2/3rd are beta variety to get the specific rotation of  $+52.5^\circ$ . The hemiacetal structure of anomeric forms of glucose are shown in Figure 6.5.

The differences between  $\alpha$  and  $\beta$  anomeric forms are dependent on the 1st carbon atom only. In the previous section 16 stereoisomers of glucose are described. Each of them will have 2 anomers; and hence there are a total of 32 isomers for glucose.



Emil Fischer  
NP 1902  
1852–1919



Walter Haworth  
NP 1937  
1883–1950



Heyrovsky  
NP 1959  
1890–1967

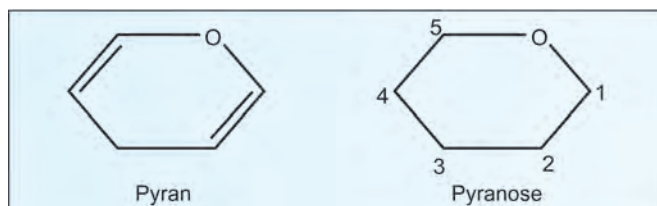


Fig. 6.6: Pyranose ring

### Three Representations of Glucose Structure

The 1st carbon, aldehyde group is condensed with the hydroxyl group of the 5th carbon to form a ring. Ring structure represents *hemi acetal* form, which is the condensation of an aldehyde (or keto) with a hydroxyl group.

The open chain projection formula and hemi acetal ring structure of glucose were proposed by Emil Fischer in 1883, and hence called Fischer's formula. Fischer was awarded Nobel prize in 1902.

Later it was shown that glucose exists in biological systems not as a rectangle, but as a pyranose ring (Fig. 6.6). This was established by Sir Walter Haworth in 1925 who got Nobel prize in 1937. Therefore, the structure of glucose may be given as the following 3 forms, each successive form adding more details (Fig. 6.7).

In solution,  $\beta$ -D-glucopyranose is the predominant form (63%),  $\alpha$ -D-glucopyranose 36% while 1% molecules are in glucofuranose forms. The practical importance is shown in Box 6.1.

### Fructose is a Ketohexose

In fructose, the keto group is on the 2nd carbon atom. Thus second carbon atom is the anomeric carbon atom. Fructose has 4 isomers. Each of them has D and L forms with regard to 5th carbon atom. Fructose has the same molecular formula as glucose, but differs in structural formula. So glucose and fructose are functional group (**aldose-ketose**) **isomers**. **D fructose is levorotatory**. Only D variety is seen in biological systems. Fructose remains predominantly as **furanose** ring structure (Fig. 6.8). Fructose is a major constituent of honey.

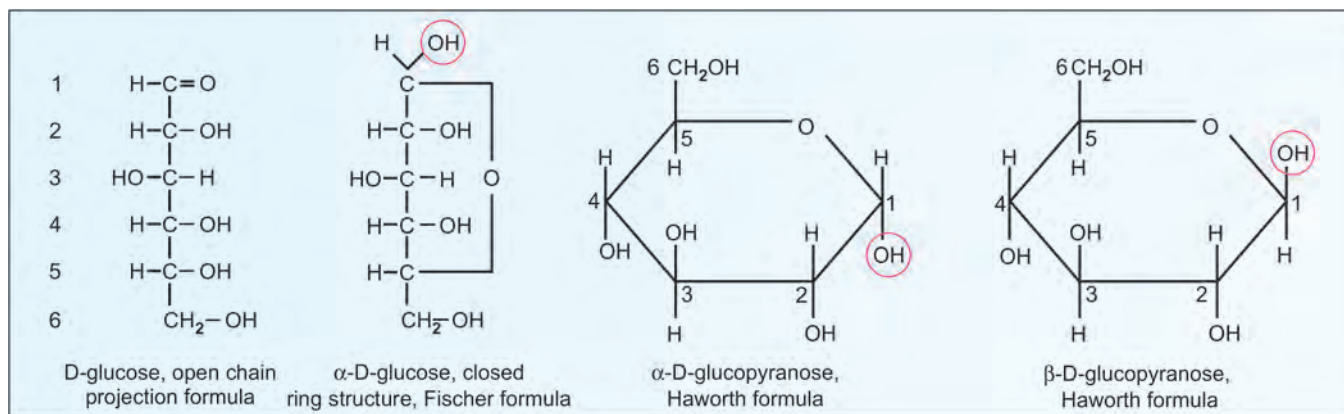


Fig. 6.7: Comparison of different representations of D-glucose

## REACTIONS OF MONOSACCHARIDES

In sugars, the following 3 properties will be seen together:

- Mutarotation
- Reducing property
- Formation of osazone with phenylhydrazine.

### Enediol Formation

In mild alkaline solutions, carbohydrates containing a free sugar group (aldehyde or keto) will tautomerize to form **enediols**, where two hydroxyl groups are

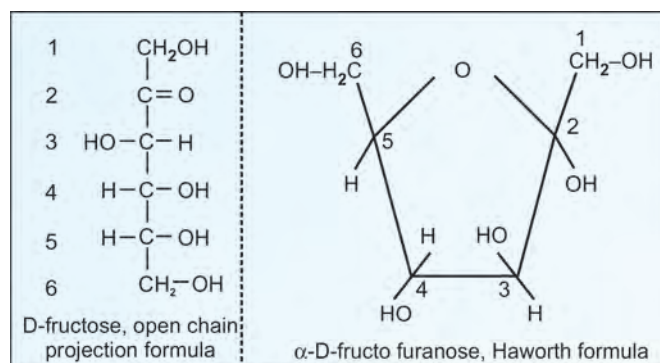


Fig. 6.8: Different representations of D-fructose

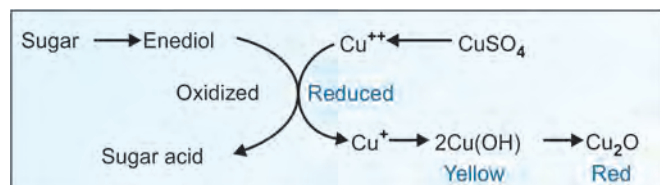


Fig. 6.9: Benedict's test, principle

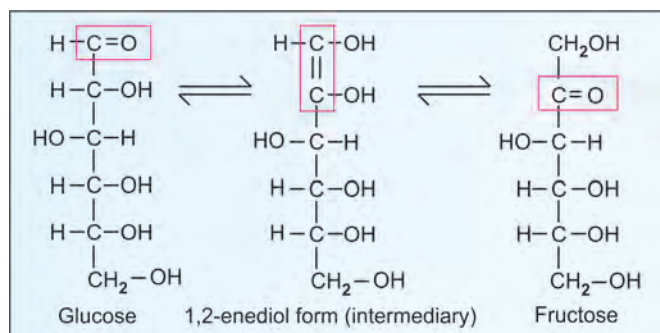


Fig. 6.10: Lobry de Bruyn-Van Ekenstein transformation

attached to the double-bonded carbon. In mild alkaline conditions, **glucose is converted into fructose and mannose**. The interconversion of sugars through a common enediol form is called Lobry de Bruyn-Van Ekenstein transformation (Fig. 6.10). Since enediols are highly reactive, sugars are powerful reducing agents in alkaline medium. When oxidizing agents like cupric ions are present, sugars form a mixture of carboxylic acids by breaking at the double bonds.

### Benedict's Reaction

Benedict's reagent is very commonly employed to detect the presence of glucose in urine (**glucosuria**). It is a standard laboratory test employed for follow-up of **diabetes mellitus**. Benedict's reagent contains sodium carbonate, copper sulfate and sodium citrate. In alkaline medium, sugars form enediol, cupric ions are reduced, correspondingly sugar is oxidized (Fig. 6.9). **Glucose is a reducing sugar** (Fig. 6.19B). Any sugar with free aldehyde/keto group will reduce the Benedict's reagent. Therefore, this is not specific for glucose. Reducing substances in urine are described in Chapter 24.

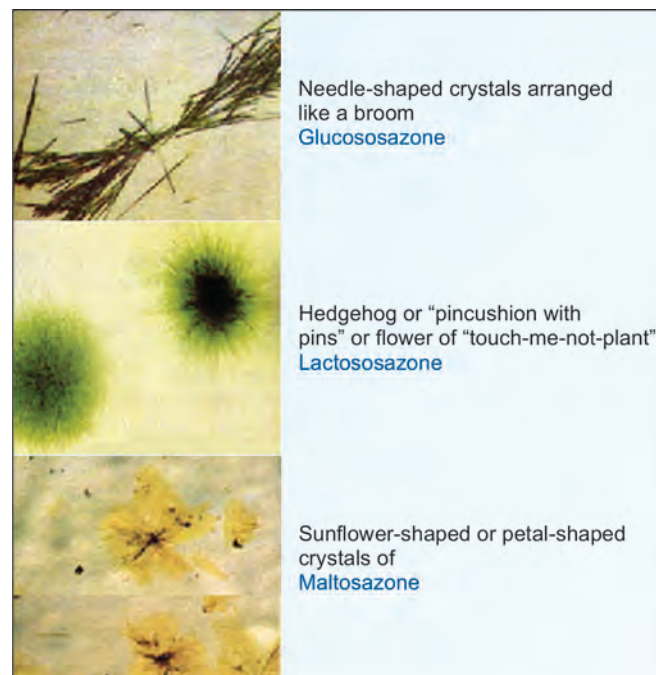


Fig. 6.11: Shape of osazones under microscope



## Osazone Formation

All reducing sugars will form osazones with excess of phenylhydrazine when kept at boiling temperature. Osazones are insoluble. Each sugar will have characteristic crystal form of osazones. The differences in glucose, fructose and mannose are dependent on the first and second carbon atoms, and when the osazone is formed these differences are masked. Hence, these 3 sugars will produce the same **needle-shaped crystals** arranged like sheaves of corn or a broom (Fig. 6.11). Osazones may be used to differentiate sugars in biological fluids like urine.

## Oxidation of Sugars

- Under mild oxidation conditions (hypobromous acid,  $\text{Br}_2/\text{H}_2\text{O}$ ), the aldehyde group is oxidized to carboxyl group to produce **aldonic acid** (Fig. 6.12). Thus, glucose is oxidized to gluconic acid, mannose to mannonic acid and galactose to galactonic acid.
- When aldehyde group is protected, and the molecule is oxidised, the last carbon becomes  $\text{COOH}$  group

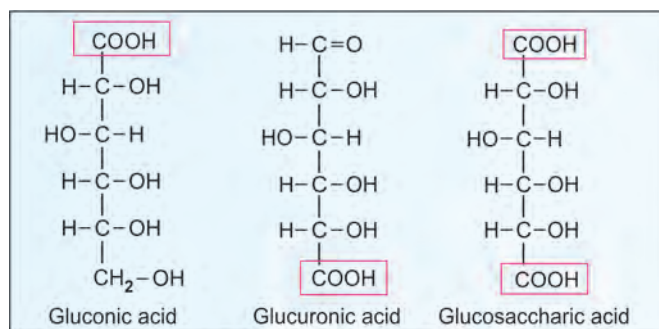


Fig. 6.12: Oxidation products of glucose

to produce **uronic acid**. Thus glucose is oxidized to glucuronic acid, mannose to mannanuronic acid and galactose to galacturonic acid. The **glucuronic acid** (Fig. 6.12) is used by the body for conjugation with insoluble molecules to make them soluble in water for detoxification purpose (see Chapter 41) and also for synthesis of heteropolysaccharides.

- Under strong oxidation conditions (nitric acid + heat), the first and last carbon atoms are simultaneously oxidized to form dicarboxylic acids, known as saccharic acids (Fig. 6.12). Glucose is thus oxidized to glucosaccharic acid, mannose to mannanic acid and galactose to mucic acid. The mucic acid forms in soluble crystals, and is the basis for a test for identification of galactose.

## Furfural Derivatives

Monosaccharides when treated with concentrated sulfuric acid undergo dehydration with the removal of 3 molecules of water. Therefore hexoses give hydroxymethyl furfural and pentoses give furfural. The furfural derivative can condense with phenolic compounds to give colored products. This forms the basis of Molisch's test. It is a general test for carbohydrates.

## Reduction to Form Alcohols

- When treated with reducing agents, such as sodium amalgam, hydrogen can reduce sugars. Aldose yields corresponding alcohol.
- But ketose forms two alcohols, because of appearance of a new asymmetric carbon atom in this process (Fig. 6.13).

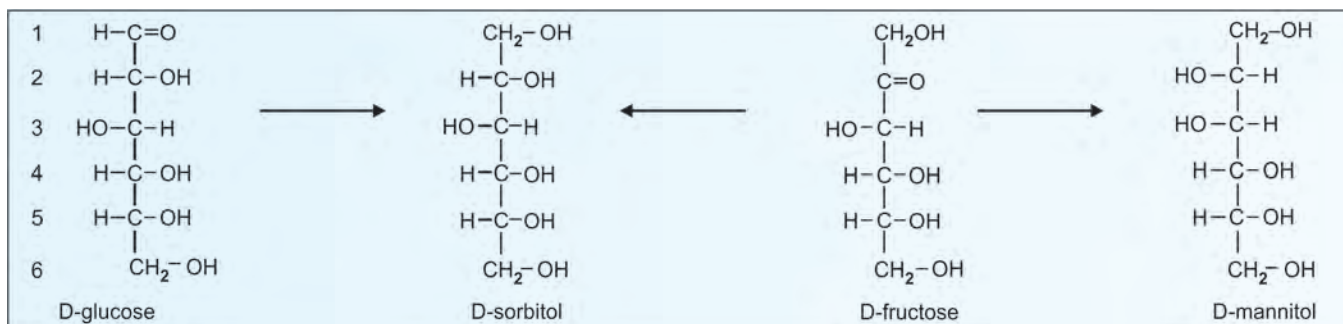


Fig. 6.13: Reduction of sugar to alcohol

- iii. Glucose is reduced to sorbitol; mannose to mannitol; while fructose becomes sorbitol and mannitol (Fig. 6.13). Galactose is reduced to dulcitol and ribose to ribitol.
- iv. Sorbitol, mannitol and dulcitol are used to identify bacterial colonies. Mannitol is also used to reduce intracranial tension by forced diuresis. The osmotic effect of sorbitol and dulcitol produces changes in tissues when they accumulate in abnormal amounts, e.g. cataract of lens.

## Glycosides

- a. When the hemiacetal group (hydroxyl group of the anomeric carbon) of a monosaccharide is condensed with an alcohol or phenol group, it is called a glycoside (Fig. 6.14). The non-carbohydrate group is called **aglycone**.
- b. Glycosides **do not reduce** Benedict's reagent, because the sugar group is masked. They may be hydrolyzed by boiling with dilute acid, so that sugar is free and can then reduce copper.
- c. Alpha-glycosides are hydrolyzed by maltase from yeast, while beta-glycosides are hydrolyzed by Emulsin from almonds. Enzyme hydrolysis thus affords a method of distinguishing between the two forms.

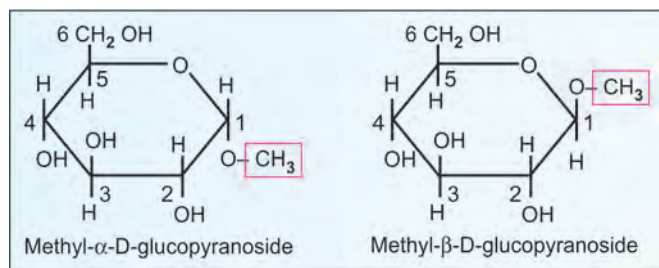


Fig. 6.14: Glycosides

TABLE 6.3: Glycosides				
Sugar+	Aglycon	= Glycoside	Source	Importance
Glucose	phloretin	Phlorhizin	Rose bark	Renal damage
Galactose, xylose	digitogenin	Digitonin	Leaves of foxglove	Cardiac stimulant
Glucose	indoxyl	Plant indican	Leaves of indigofera	Stain

- d. Some glycosides of medical importance are given in Table 6.3. Digitonin is a cardiac stimulant. Phlorhizin is used to produce renal damage in experimental animals.

## Formation of Esters

Hydroxyl groups of sugars can be esterified to form acetates, propionates, benzoates, phosphates, etc.

Sugar phosphates are of great biological importance. Metabolism of sugars inside the body starts with phosphorylation. Glucose-6-phosphate and glucose-1-phosphate are important intermediates of glucose metabolism (Fig. 6.15).

## Amino Sugars

- i. Amino groups may be substituted for hydroxyl groups of sugars to give rise to amino sugars. Generally, the amino group is added to the second carbon atom of hexoses (Fig. 6.16).
- ii. Amino sugars will not show reducing property. They will not produce osazones.

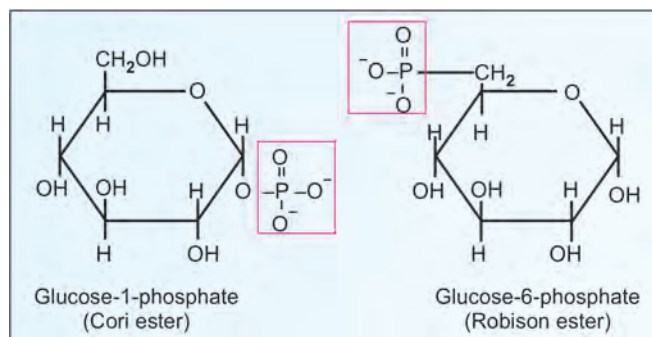


Fig. 6.15: Phosphorylated sugars

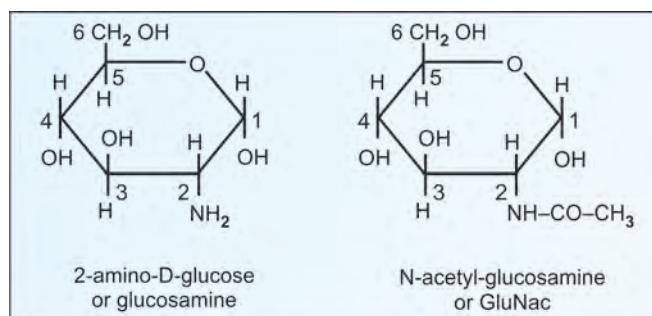


Fig. 6.16: Amino sugars



- iii. Glucosamine is seen in hyaluronic acid, heparin and blood group substances. Galactosamine is present in chondroitin of cartilage, bone and tendons. Mannosamine is a constituent of glycoproteins.
- iv. The amino group in the sugar may be further acetylated to produce N-acetylated sugars such as N-acetyl-glucosamine (GluNac) (Fig. 6.16), N-acetyl-galactosamine (GalNac), etc. which are important constituents of glycoproteins, mucopolysaccharides and cell membrane antigens.

## Deoxy Sugars

- i. Oxygen of the hydroxyl group may be removed to form deoxy sugars. Some biologically important deoxy sugars are shown in Figure 6.17.
- ii. Deoxy sugars will not reduce and will not form osazones. L-fucose is present in blood group antigens and many other glycoproteins.
- iii. **Deoxyribose** (Fig. 6.18) is an important part of nucleic acid. **Feulgen staining** is specific for 2-deoxy sugars (and DNA) in tissues; this is based on the reaction of 2-deoxy sugars with Schiff's reagent (Dye Fuchsin is decolorized by sulfurous acid).

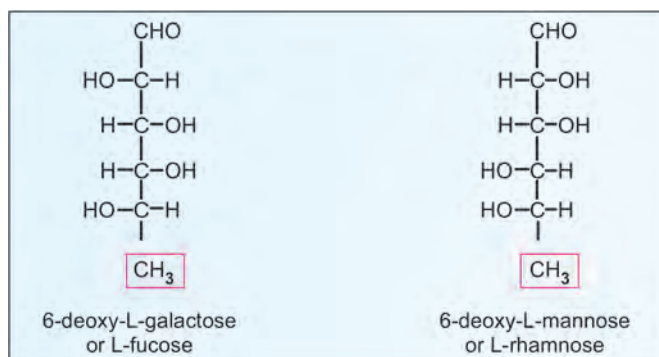


Fig. 6.17: Deoxy sugars

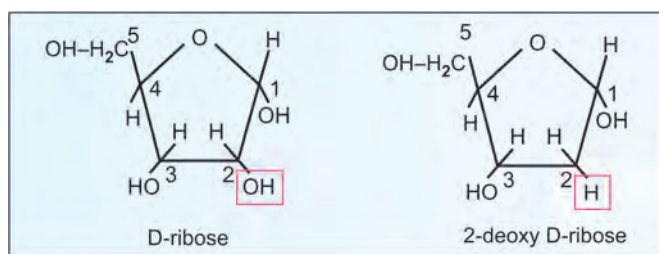


Fig. 6.18: Sugars of nucleic acids

## Pentoses

- i. They are sugars containing 5 carbon atoms.
- ii. **Ribose** (Fig. 6.18) is a constituent of RNA. Ribose is also seen in co-enzymes such as ATP and NAD. **Deoxyribose** is seen in DNA (Fig. 6.18).
- iii. **Ribulose** is an intermediate of HMP shunt pathway. **Arabinose** is present in cherries and seen in glycoproteins of the body. The name arabinose is derived as it was originally isolated from gum arabic.
- iv. **Xylose** is seen in proteoglycans. **Xylulose** is an intermediate of uronic acid pathway.

## DISACCHARIDES

When two monosaccharides are combined together by glycosidic linkage, a disaccharide is formed. The important disaccharides are:

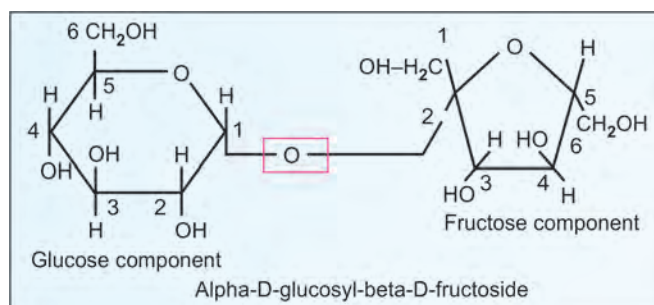


Fig. 6.19A: Structure of sucrose (1-2 linkage)

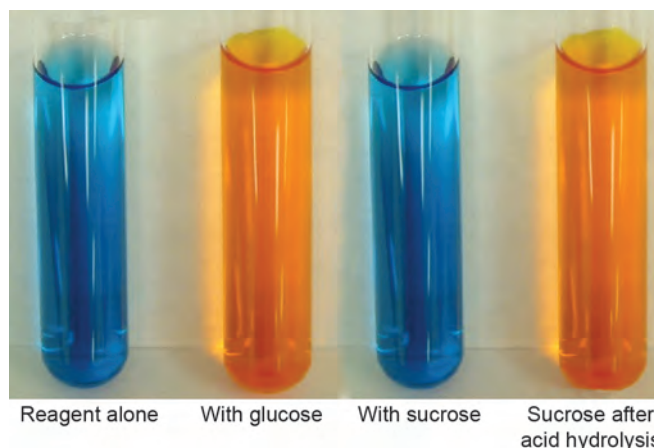


Fig. 6.19B: Benedict's test is positive for glucose. Test is negative for sucrose; but when sucrose is hydrolyzed, the test becomes positive (specific sucrose test)

1. Sucrose
2. Maltose and isomaltose
3. Lactose.

## Sucrose

- It is the sweetening agent known as cane sugar. It is present in sugarcane and various fruits.
- Sucrose contains glucose and fructose. Sucrose is **not a reducing sugar**; and it will not form osazone. This is because the linkage involves first carbon of glucose and second carbon of fructose, and free reducing groups are not available (Fig. 6.19A).
- When sucrose is hydrolyzed, the products have reducing action. A sugar solution which is originally non-reducing, but becomes reducing after hydrolysis, is inferred as sucrose (**specific sucrose test**) (Fig. 6.19B).
- Hydrolysis of sucrose (optical rotation  $+66.5^\circ$ ) will produce one molecule of glucose ( $+52.5^\circ$ ) and one molecule of fructose ( $-92^\circ$ ). Therefore, the products will change the dextrorotation to levorotation, or the plane of rotation is inverted. Equimolecular mixture of glucose and fructose thus formed is called **invert sugar**. The enzyme producing hydrolysis of sucrose is called **sucrase or invertase**. Honey contains invert sugar. Invert sugar is sweeter than sucrose.

## Lactose

- It is the sugar present in milk. It is a **reducing disaccharide**. On hydrolysis lactose yields glucose

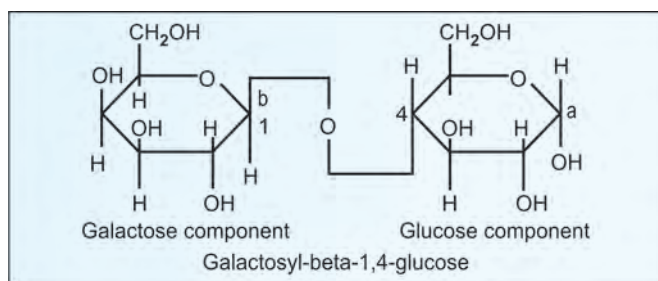


Fig. 6.20: Lactose

### Box 6.2: Lactose and lactate are different

**Lactose** is the milk sugar; a disaccharide made of galactose and glucose.

**Lactate** or Lactic acid is a product of anaerobic metabolism of glucose.

and galactose. **Beta glycosidic linkage** is present in lactose.

- The structure is given in Figure 6.20. The anomeric carbon atom of beta-galactose is attached to the 4th hydroxyl group of glucose through beta-1,4 glycosidic linkage. The lactose may be alpha or beta variety, depending on the configuration of 1st carbon of glucose moiety.
- Lactose forms osazone which resembles "pincushion with pins" or "**hedgehog**" or flower of "touch-me-not" plant (Fig. 6.11).
- Lactose and lactate should not be confused (Box 6.2).

## Maltose

- Maltose contains two glucose residues.
- There is alpha-1,4 linkage, i.e. the anomeric 1st carbon atom of one glucose is combined with 4th hydroxyl group of another glucose through alpha-glycosidic linkage. Structure is shown in Figure 6.21.
- Maltose may be alpha or beta depending on the configuration at the free anomeric carbon atom.
- It is a **reducing disaccharide**. It forms **petal-shaped crystals** of maltose-osazone (Fig. 6.11).

## Isomaltose

It is also a **reducing** sugar. It contains 2 glucose units combined in alpha-1, 6 linkage. Thus first carbon of one glucose residue is attached to the sixth carbon of another glucose through a glycosidic linkage (Fig. 6.22). Partial hydrolysis of glycogen and starch produces isomaltose. The enzyme oligo-1,6-glucosidase present in intestinal juice can hydrolyze isomaltose into glucose units.

The salient features of important sugars are shown in Box 6.3.

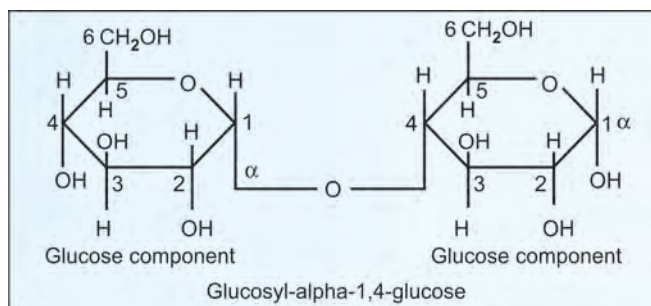


Fig. 6.21: Maltose

## POLYSACCHARIDES

These are polymerized products of many monosaccharide units. They may be:

1. **Homoglycans** are composed of single kind of monosaccharides, e.g. starch, glycogen and cellulose.
2. **Heteroglycans** are composed of two or more different monosaccharides, e.g. hyaluronic acid, chondroitin sulfate.

### Starch

#### Structure of starch

- i. It is the reserve carbohydrate of **plant kingdom**.
- ii. **Sources:** Potatoes, tapioca, cereals (rice, wheat) and other food grains.
- iii. Starch is composed of amylose and amylopectin. When starch is treated with boiling water, 10–20% is solubilized; this part is called **amylose**. Amylose is made up of glucose units with **alpha-1,4 glycosidic linkages** (Fig. 6.21) to form an unbranched long chain with a molecular weight 400,000 D or more.

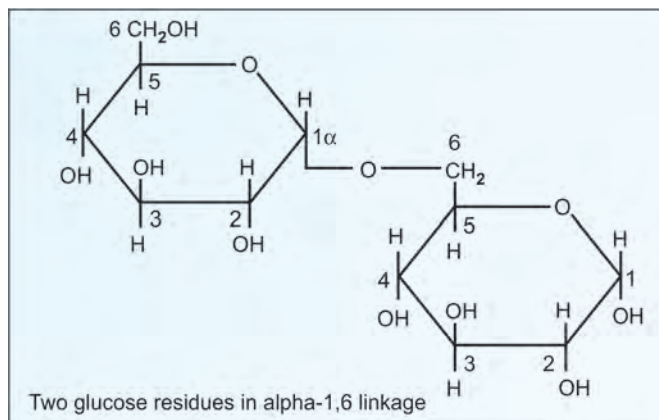


Fig. 6.22: Isomaltose

#### Box 6.3: Salient features of important sugars

##### Monosaccharides

Glucose	Aldohexose
Galactose	4th epimer of glucose
Mannose	2nd epimer of glucose
Fructose	Ketohexose

##### Disaccharides

Glucose + Galactose = Lactose (reducing)
Glucose + Glucose = Maltose (reducing)
Glucose + Fructose = Sucrose (non-reducing)

- iv. The insoluble part absorbs water and forms paste like gel; this is called **amylopectin**. Amylopectin is also made up of glucose units, but is highly branched with molecular weight more than 1 million. The branching points are made by **alpha-1,6 linkage** (similar to isomaltose, Fig. 6.22).

#### Hydrolysis of Starch

- i. Starch will form a **blue colored complex with iodine**; this color disappears on heating and reappears when cooled. This is a sensitive test for starch. Starch is non-reducing because the free sugar groups are negligible in number.
- ii. When starch is hydrolyzed by mild acid, smaller and smaller fragments are produced.
- iii. Thus hydrolysis for a short time produces **amylopectin** which gives violet color with iodine and is non-reducing. Further hydrolysis produces **erythropectin** which gives red color with iodine and mildly reduce the Benedict's solution. Later achropectins (no color with iodine, but reducing) and further on, maltose (no color with iodine, but powerfully reducing) are formed on continued hydrolysis.

#### Action of Amylases on Starch

- i. Salivary amylase and pancreatic amylase are **alpha-amylases**, which act at random on alpha-1,4 glycosidic bonds to split starch into smaller units (dextrins), and finally to **alpha-maltose**.
- ii. **Beta-amylases** are of plant origin (almond, germinating seeds, etc.) which split starch to form **beta-maltose**. They act on amylose to split maltose

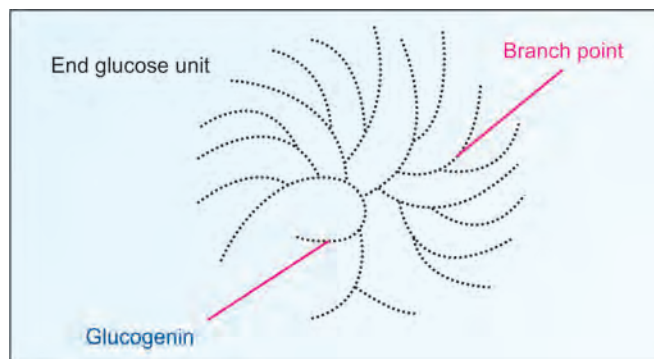


Fig. 6.23: Branched glycogen molecule

units consecutively. Thus the enzyme starts its action from one end.

- iii. When beta-amylase acts on amylopectin, maltose units are liberated from the ends of the branches of amylopectin, until the action of enzyme is blocked at the 1,6-glycosidic linkage. The action of beta-amylase stops at branching points, leaving a large molecule, called **limit dextrin** or **residual dextrin**.

## Glycogen

- i. It is the **reserve carbohydrate in animals**. It is stored in **liver and muscle**. About 5% of weight of liver is made up by glycogen. Excess carbohydrates are deposited as glycogen.
- ii. Glycogen is composed of glucose units joined by alpha-1,4 links in straight chains. It also has alpha-1,6 glycosidic linkages at the branching points (Fig. 6.23). Molecular weight of glycogen is about 5 million. Innermost core of glycogen contains a primer protein, **Glycogenin**. Glycogen is **more branched and more compact** than amylopectin.

## Cellulose

- i. It is the supporting tissues of plants. Cellulose constitutes 99% of cotton, 50% of wood and is the most abundant organic material in nature.
- ii. It is made up of glucose units combined with **beta-1,4 linkages**. It has a straight line structure, with no branching points. Molecular weight is in the order of 2 to 5 million.
- iii. Beta-1,4 bridges are hydrolyzed by the enzyme **cellobiase**. But this enzyme is absent in animal and human digestive system, and hence cellulose **cannot be digested**.
- iv. Herbivorous animals have large cecum, which harbor bacteria. These bacteria can hydrolyze cellulose, and the glucose produced is utilized by the animal. White ants (termites) also digest cellulose with the help of intestinal bacteria.

### Box 6.4: Inulin and Insulin are different

**Inulin** is a polysaccharide (carbohydrate) made up of fructose units. It is used for renal function studies.

**Insulin** is a polypeptide (protein) hormone, with wide ranging actions on carbohydrate and lipid metabolism.

- v. Cellulose has a variety of commercial applications, as it is the starting material to produce fibers, celluloids, nitrocellulose and plastics.

## Inulin

It is a long chain homoglycan composed of D-fructose units with repeating beta-1,2 linkages. It is the reserve carbohydrate present in various bulbs and tubers, such as chicory, dahlia, dandelion, onion, garlic. It is clinically used to find renal clearance value and glomerular filtration rate. Inulin and Insulin are different (Box 6.4).

## Dextrans

These are highly branched homopolymers of glucose units with 1-6, 1-4 and 1-3 linkages. They are produced by micro-organisms. They have molecular weight 1 million to 4 millions. Since they will not easily go out of vascular compartment, they are used for intravenous infusion as plasma volume expander for treatment of hypovolemic shock. It may be noted that dextrans are different from previously described dextrans (Box 6.5).

## Chitin

It is present in exoskeletons of crustacea and insects. It is composed of units of N-acetyl-glucosamine with beta-1,4 glycosidic linkages.

## HETEROGLYCANS

These are polysaccharides containing more than one type of sugar residues. Examples are:

### Agar

- i. It is prepared from sea weeds. It contains galactose, glucose and other sugars.
- ii. It is dissolved in water at 100°C, which upon cooling sets into a gel. Agar cannot be digested by bacteria and hence used widely as a supporting agent to culture

### Box 6.5: Dextrose, Dextrin and Dextran are different

D-glucose is otherwise called **Dextrose**, a term often used in bed-side medicine, e.g. dextrose drip. **Dextrin** is the partially digested product of starch. **Dextran** is high molecular weight carbohydrate, synthesized by bacteria.



bacterial colonies. Agar is used as a supporting medium for immunodiffusion and immunoelectrophoresis.

- iii. **Agarose** is made up of galactose combined with 3,6-anhydrogalactose units; it is used as matrix for electrophoresis (see Chapter 35).

## MUCOPOLYSACCHARIDES

Mucopolysaccharides or **glycosamino glycans** (GAG) are heteropolysaccharides, containing uronic acid and amino sugars. Acetylated amino groups, sulfate and carboxyl groups are also generally present. Because of the presence of these charged groups, they attract water molecules and so they produce viscous solutions. Mucopolysaccharides in combination with proteins form mucoproteins. Examples of mucopolysaccharides are hyaluronic acid, heparin, chondroitin sulfate, dermatan sulfate and keratan sulfate.

Mucopolysaccharides are excreted in urine in abnormal amounts in the group of lysosomal storage disorders known as **mucopolysaccharidoses**. They can be detected by 2D gel electrophoresis techniques; some mucopolysaccharides can also be detected by simple urine screening tests like CPC test, Cetavlon test and Alcian blue staining.

### Hyaluronic acid

It is present in connective tissues, tendons, synovial fluid and vitreous humor. It serves as a lubricant in joint cavities. It is composed of repeating units of N-Acetyl-glucosamine  $\rightarrow$  beta-1, 4-Glucuronic acid  $\rightarrow$  beta-1-3-N-Acetyl glucosamine and so on.

### Heparin

- i. It is an anticoagulant widely used when taking blood in vitro for clinical studies. It is also used in vivo in suspected

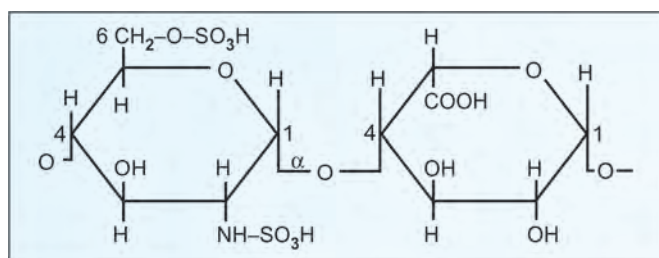


Fig. 6.24: Sulfated glucosamine-alpha-1, 4-iduronic acid. Repeating units in heparin

thromboembolic conditions to prevent intravascular coagulation. It activates antithrombin III, which in turn inactivates thrombin, factor X and factor IX.

- ii. Heparin is present in liver, lungs, spleen and monocytes. Commercial preparation of heparin is from animal lung tissues.
- iii. It contains repeating units of sulphated glucosamine  $\rightarrow$  alpha-1, 4-L-iduronic acid  $\rightarrow$  and so on (Fig. 6.24). Idose is the 5th epimer of glucose. Iduronic acid is the oxidized form of idose. Sulfated heparin or heparan sulfate is also present in tissues.

### Chondroitin Sulfate

It is present in ground substance of connective tissues widely distributed in cartilage, bone, tendons, cornea and skin. It is composed of repeating units of glucuronic acid  $\rightarrow$  beta-1,3-N-acetyl galactosamine sulfate  $\rightarrow$  beta-1, 4 and so on (Fig. 6.25).

### Keratan Sulfate

It is the only GAG, which **does not contain any uronic acid**. The repeating units are galactose and N-acetyl glucosamine in beta linkage. It is found in cornea and tendons.



Alexander Fleming  
NP 1945  
1881–1955



Ernst Chain  
NP 1945  
1906–1979



Howard Florey  
NP 1945  
1898–1968

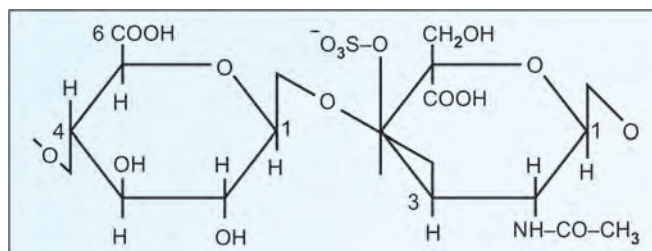


Fig. 6.25: D-glucuronic acid-beta-1, 3-N-acetyl galactosamine-4 sulfate (units of chondroitin sulfate)

## Dermatan Sulfate

It contains L-iduronic acid and N-acetyl galactosamine in beta-1, 3 linkages. It is found in skin, blood vessels and heart valves. Repeating units in various polysaccharides are summarized in Box 6.6.

## GLYCOPROTEINS AND MUCOPROTEINS

- i. When the carbohydrate chains are attached to a polypeptide chain it is called a **proteoglycan**. If the carbohydrate content is less than 10%, it is generally named as a **glycoprotein**. If the carbohydrate content is more than 10% it is a **mucoprotein**. (But some authors use these words as synonyms).
- ii. They are seen in almost all tissues and cell membranes. About 5% of the weight of the cell membrane is carbohydrates; the carbohydrate groups cover the entire surface of the cell membrane, they are called **glycocalyx**. Functions include their role as enzymes, hormones, transport proteins, structural proteins and receptors.
- iii. **Glycophorin** is the major membrane glycoprotein of erythrocytes. The protein is transmembrane (spans the whole thickness of the membrane), with polypeptide chain is seen both inside and outside the membrane. Carbohydrate chains are attached to the amino terminal portion, outside the cell surface.
- iv. The oligosaccharide chains of glycoproteins are composed of varying numbers of the following carbohydrate residue: Glucose (Glu); mannose (Man); galactose (Gal); N-acetyl glucosamine (GluNAc); N- acetyl galactosamine (GalNAc); arabinose (Ara); Xylose (Xyl); L-fucose (Fuc) (Fig. 6.17) and N-acetyl neuraminic acid (NANA). Glycoprotein metabolism is further elaborated in Chapter 10.

Carbohydrate group is attached to proteins either as O-glycosidic linkages or as N-glycosidic linkages. The O-glycosidic linkage is GalNAc to

serine or threonine residues of usual protein; however, galactose is added to hydroxylysine residues of collagen. The N-glycosidic linkages are made by addition of carbohydrate group to nitrogen atom of asparagine or glutamine residues of proteins. The oligosaccharides attached to proteins may alter physical properties such as size, shape, solubility, or stability, may effect folding, and/or may have biological roles.

## Common Sugar Substitutes

**Acesulfame-Potassium (Ace K)** is made from aceto acetic acid. It is 200 times more sweet than sugar; but calorie content is negligible. It is present in artificial sweeteners, carbonated drinks, pharmaceutical products. It has a slightly bitter aftertaste. Unlike aspartame, acesulfame K is stable under heat, allowing it to be used in baking, or in products that require a long shelf life.

**Aspartame** is made from aspartic acid and phenyl alanine, both are amino acids. (Aspartame is the methyl ester of a phenylalanine/aspartic acid dipeptide). It is 200 times more sweet than sugar. Calorie content is 4 kcal per gram. Under strongly acidic or alkaline conditions, aspartame may generate methanol by hydrolysis. Aspartame is immediately metabolized to phenylalanine, aspartic acid and methanol. Aspartame is not suitable for people with phenyl ketonuria.

**Saccharin** is made from anthranilic acid. It is 300 times sweeter than sugar. Calorie content is nil.

**Sucralose** is made from sucrose or table sugar. Sucralose is approximately 600 times as sweet as sucrose (table sugar), twice as sweet as saccharin, and 3.3 times as sweet as aspartame. Calorie content is nil.

**Sodium cyclamate** (Sodium cyclohexyl sulfamate) is 30–50 times sweeter than sugar. It is less expensive than most sweeteners and is stable under heating. The 10:1 cyclamate : saccharin mixture is found to increase the incidence of bladder cancer in rats. Its sale is banned in the United States. However, Cyclamate is approved as a sweetener in over 55 countries.

**Saccharin** (Benzoic sulfimide) is an artificial sweetener, but has an unpleasant bitter or metallic aftertaste, especially at high concentrations. It is used to sweeten products such as drinks, candies, medicines, and toothpaste. Although saccharin has no food energy, it can trigger the release of insulin in humans and rats, apparently as a result of its taste. It is not banned anywhere in the world.

**Erythritol** is a natural sugar alcohol. It occurs naturally in fruits and fermented foods. It is 60–70% as sweet as table sugar yet it is almost non-caloric, does not affect blood sugar, does not cause tooth decay. In the body, erythritol is absorbed, and then for the most part excreted unchanged in the urine.

**Xylitol** is found in the fibers of many fruits and vegetables, including various berries, corn husks, oats, and mushrooms. Xylitol is roughly as sweet as sucrose with only two-thirds the food energy. Xylitol is a safe sweetener for people with diabetes that would not impact insulin levels.

Sugar substitutes can be used in the initial phase of a dieting plan for an obese child. Children, unless diabetic, should avoid them.

## Dietary Fiber

Dietary fiber is contributed by the unavailable carbohydrates in the diet. Several different types of dietary fiber have been found in different types of food items. They contribute the bulk and assist in normal bowel

Box 6.6: Repeating units in polysaccharides

Polysaccharide	Repeating units
<b>Homoglycans</b>	
Inulin	D-fructose, beta-1,2 linkages
Dextran	Glucose, 1-6, 1-4, 1-3 linkages
Chitin	N-acetyl glucosamine; beta 1-4 links
<b>Heteroglycans</b>	
Agar	Galactose, glucose
Agarose	Galactose, anhydrogalactose
Hyaluronic acid	N-acetyl glucosamine, glucuronic acid
Heparin	Sulphated glucosamine, L-iduronic acid
Chondroitin S	Glucuronic acid, Nacetyl galactosamine
Keratan S	Galactose, N-acetyl glucosamine
Dermatan S	L-iduronic acid, N-acetyl galactosamine

movements. Cellulose, hemicellulose, pectin, alginates and gums are the usual glycans which form dietary fiber. Of these cellulose, a homoglycan made of glucose is found in bran, flour and tubers. Hemicellulose is a mixture of glycans; pentosans made of xylose or arabinose and hexans (mannans, galactans and polyuronic acids). These are mainly found in whole grains and brans. Pectins are mixtures of homoglycans found in fruits like apples and berries. They are made of galacturonic acid and arabinose. Gums and alginates are found in legumes and oatmeal and are made of polymannuronic acid.

## Bacterial Cell Wall

Major constituents of prokaryotic (bacterial) cells are heteropolysaccharides, consisting of repeating units of N-acetyl muramic acid (NAM) and N-acetyl glucosamine (NAG). This polysaccharide provides mechanical strength. Synthesis of this complex polysaccharide is blocked by penicillin. This inhibition is responsible for the bactericidal action of penicillin. Penicillin was discovered by Sir Alexander Fleming in 1928. Later, Ernst Chain isolated and purified penicillin. The first clinical trial with penicillin was conducted by Howard Florey in 1940. All the three were awarded Nobel prize in 1945.

## QUICK LOOK OF CHAPTER 6

1. Carbohydrates are polyhydroxy aldehydes or ketones or compounds, which yield them on hydrolysis.
2. Carbohydrates are classified into monosaccharides, disaccharides and polysaccharides, based on the number of sugar/saccharide units they possess. They could also be classified as aldoses and ketoses based on the functional group they possess.
3. Common examples of monosaccharides include Glucose, Fructose, Galactose, and Mannose.
4. Common examples of disaccharides are Sucrose, Lactose and Maltose.
5. Monosaccharides exhibit stereoisomerism, optical isomerism, anomerism and pyranose-furanose isomerism.
6. All carbohydrates are considered to be derived from glyceraldehyde by successive addition of carbons. The penultimate carbon atom is thus the reference carbon atom for naming mirror images.
7. The stereoisomers are prefixed as 'D' or 'L'. D sugars are naturally occurring and human body can metabolise only D sugars.
8. A carbon atom bound by four different groups on all its valencies is referred to as an asymmetric carbon.
9. Anomers of monosaccharides are produced by the spatial configuration with reference to the first carbon atom in aldoses and the second carbon atom in ketoses.
10. Two anomers of glucose are alpha-D glucose and beta-D glucose. Mutarotation is the result of anomerism.
11. Optical isomerism is based on the rotation of plane polarized light by a pure solution of the sugar. The prefix 'd' or (+) and 'l' or (-) is used to indicate dextro and levorotatory compounds respectively.
12. All reducing sugars form characteristic osazone crystals. Glucose and fructose form needle shaped crystals, maltose forms sunflower-shaped crystals and lactose forms hedgehog-shaped crystals.
13. Amino sugars form important components of mucopolysaccharides. For example, Galactosamine, Glucosamine.
14. Sucrose is formed from glucose and fructose linked by 1, 2 glycosidic linkage.
15. Lactose is formed from galactose and glucose linked by beta 1,4 glycosidic linkage.
16. Maltose is formed from two glucose molecules linked by alpha 1,4 glycosidic linkage.
17. Starch is made of two components; straight chain amylose and branched amylopectin. The linkages are alpha-1,6 type at branch points while alpha-1,4 linkages form the straight chain.
18. Action of amylase on starch yields limit dextrans.
19. Mucopolysaccharides or Glycosaminoglycans (GAGs) such as Hyaluronic acid, Chondroitin sulfate, Keratan sulfate, Dermatan sulfate are associated with connective tissue.
20. Keratan sulfate is the only GAG that does not contain uronic acid.
21. When the carbohydrate chains are attached to a polypeptide chain it is called a proteoglycan.

# CHAPTER 7

## Chemistry of Lipids

### Chapter at a Glance

The reader will be able to answer questions on the following topics:

- Classification of lipids
- Classification of fatty acids
- Saturated and unsaturated fatty acids
- Neutral fats or triacylglycerols
- Phospholipids
- Phosphatidylcholine or lecithin
- Sphingomyelin
- Non-phosphorylated lipids

Lipids constitute a heterogeneous group of compounds of biochemical importance. Lipids may be **defined as** compounds which are relatively insoluble in water, but freely soluble in non-polar organic solvents, such as benzene, chloroform, ether, hot alcohol, acetone, etc. The functions of lipids are summarized in Box 7.1. The clinical applications are shown in Box 7.2.

### CLASSIFICATION OF LIPIDS

Detailed classification is shown in Table 7.1. Based on the chemical nature, lipids are classified as:

1. **Simple lipids:** They are esters of fatty acids with glycerol or other higher alcohols. (Table 7.1).
2. **Compound lipids:** They are fatty acids esterified with alcohol; but in addition they contain other groups. Depending on these extra groups, they are subclassified in Table 7.1.
  - a. Phospholipids, containing phosphoric acid.
  - b. Non-phosphorylated lipids (Table 7.1)

3. **Derived lipids:** They are compounds, which are derived from lipids or precursors of lipids, e.g. fatty acids, steroids. For details of cholesterol and steroids, see Chapter 13.

### 4. Lipids complexed to other compounds

#### Box 7.1: Functions of Lipids

1. Storage form of energy (triacylglycerol)
2. Structural components of biomembranes (phospholipids and cholesterol)
3. Metabolic regulators (steroid hormones and prostaglandins)
4. Act as surfactants, detergents and emulsifying agents (amphipathic lipids)
5. Act as electric insulators in neurons
6. Provide insulation against changes in external temperature (subcutaneous fat)
7. Give shape and contour to the body
8. Protect internal organs by providing a cushioning effect (pads of fat)
9. Help in absorption of fat soluble vitamins (A, D, E and K)
10. Improve taste and palatability of food.



## FATTY ACIDS

Fatty acids, are included in the group of derived lipids. It is the most common component of lipids in the body. They are generally found in ester linkage in different classes of lipids. In the human body, free fatty acids are formed only during metabolism.

Fatty acids are **aliphatic carboxylic acids** and have the general formula, R—CO—OH, where COOH (carboxylic

group) represents the functional group. Depending on the R group (the hydrocarbon chain), the physical properties of fatty acids may vary. Characteristics of common fatty acids are shown in Table 7.2. Classification of fatty acid is given in Table 7.3.

**TABLE 7.1:** Classification of lipids

I Simple lipids
a. Triacylglycerol or Triglycerides or neutral fat
b. Waxes
II. Compound lipids
A. Phospholipids, containing phosphoric acid
1. Nitrogen containing glycerophosphatides:
i. Lecithin (phosphatidylcholine)
ii. Cephalin (phosphatidylethanolamine)
iii. Phosphatidylserine
2. Non-nitrogen glycerophosphatides
i. Phosphatidylinositol
ii. Phosphatidylglycerol
iii. Diphosphatidylglycerol (cardiolipin)
3. Plasmalogens, having long chain alcohol
i. Choline plasmalogen
ii. Ethanolamine plasmalogen
4. Phospho sphingosides, with sphingosine
Sphingomyelin
B. Non-phosphorylated lipids
1. Glycosphingolipids (carbohydrate)
i. Cerebrosides (ceramide monohexosides)
ii. Globosides (ceramide oligosaccharides)
iii. Gangliosides (ceramide + oligosaccharides + N-acetyl neuraminic acid)
2. Sulfolipids or sulfatides
i. Sulfated cerebrosides
ii. Sulfated globosides
iii. Sulfated gangliosides
III. Derived lipids
Fatty acids, steroids (see chapter 13), prostaglandins (see chapter 14), leukotrienes, terpenes, dolichols, etc.
IV. Lipids complexed to other compounds
Proteolipids and lipoproteins.

**TABLE 7.2:** Characteristics of common fatty acids

Common name	No. of carbon atoms	Chemical nature	Occurrence
A. Even chain, saturated fatty acids			
Acetic	2	Saturated; small chain	Vinegar
Butyric	4	do	Butter
Caproic	6	do	Butter
Capric	10	do	Coconut oil
Lauric	12	do	Coconut oil
Myristic	14	do	Coconut oil
Palmitic	16	Saturated; long chain	Body fat
Stearic	18	do	do
Arachidic	20	do	Peanut oil (Arachis oil)
B. Odd-chain fatty acids			
Propionic	3	Saturated; odd chain	Metabolism
C. Even chain, unsaturated fatty acids			
Palmitoleic	16	Monounsaturated ( $\omega$ 7)	Body fat
Oleic	18	do ( $\omega$ 9)	do
Erucic	22	do ( $\omega$ 9)	Mustard oil
Nervonic	24	do ( $\omega$ 9)	Brain lipids
Linoleic	18	2 double bonds ( $\omega$ 6)	Vegetable oils
Linolenic	18	3 double bonds ( $\omega$ 3)	do
Arachidonic	20	4 double bonds ( $\omega$ 6)	Vegetable oils
Timnodonic	20	Eicosapentaenoic ( $\omega$ 3)	Fish oils, brain
Clupanodonic	22	Docosapentaenoic ( $\omega$ 3)	Fish oils, brain
Cervonic	22	Docosahexaenoic ( $\omega$ 3)	Fish oils, brain
D. Branched fatty acids			
Isovaleric acid	5	Branched	Metabolic intermediate
E. Hydroxy fatty acids			
Cerebronic acid	24	Hydroxy acid	Brain lipids

## SATURATED FATTY ACIDS

Swedish scientist Scheele isolated glycerol in 1779. Chevreul ME isolated oleic, stearic, butyric and caproic acids in 1823. In 1898, Edmed FG identified the structure of oleic acid. Linoleic acid was prepared from linseed oil by Sacc F in 1844. Lauric acid (12:0) was discovered in *Lauraceae* seeds by Marsson T in 1849. Franz Soxhlet, a German chemist, invented the Soxhlet apparatus in 1879. This apparatus was used first to separate fats from food.

i. They have the general formula  $\text{CH}_3-(\text{CH}_2)_n-\text{COOH}$ .

For example,

**Acetic acid**  $\text{CH}_3-\text{COOH}$

**Butyric acid**  $\text{CH}_3(\text{CH}_2)_2-\text{COOH}$

**Palmitic acid**  $\text{CH}_3-(\text{CH}_2)_{14}-\text{COOH}$

**Stearic acid**  $\text{CH}_3-(\text{CH}_2)_{16}-\text{COOH}$

Some of the common saturated fatty acids are noted in Table 7.2.

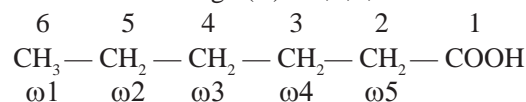
### Box 7.2: Clinical applications

- Excessive fat deposits cause obesity. Truncal obesity is a risk factor for heart attack.
- Abnormality in cholesterol and lipoprotein metabolism leads to atherosclerosis and cardiovascular diseases (see Chapter 25).
- In diabetes mellitus, the metabolisms of fatty acids and lipoproteins are deranged, leading to ketosis (see Chapter 24).

**TABLE 7.3:** Classification of fatty acids

1. Depending on total number of carbon atoms:
a. Even chain:
They have carbon atoms 2,4,6 and similar series. Most of the naturally occurring lipids contain even chain fatty acids.
b. Odd chain:
They have carbon atoms 3, 5, 7, etc. Odd numbered fatty acids are seen in microbial cell walls. They are also present in milk.
2. Depending on length of hydrocarbon chain:
a. Short chain with 2 to 6 carbon atoms
b. Medium chain with 8 to 14 carbon atoms
c. Long chain with 16 and above, usually up to 24 carbon atoms
d. Very long chain fatty acids (more than 24 carbon).
3. Depending on nature of hydrocarbon chain:
a. Saturated fatty acids (Table 7.2)
b. Unsaturated fatty acids which may be subclassified into Monounsaturated (monoenoic) having single double bond or Polyunsaturated (polyenoic) with 2 or more double bonds. (Table 7.2)
c. Branched chain fatty acids
d. Hydroxy fatty acids

- They are named by adding the suffix 'anoic' after the hydrocarbon.
- The two carbon acetic acid and 4 carbon butyric acid are important metabolic intermediates.
- The C16 (palmitic acid) and C18 (stearic acid) are most abundant in body fat.
- Each animal species will have characteristic pattern of fatty acid composition. Thus, human body fat contains 50% oleic acid, 25% palmitic acid, 10% linoleic and 5% stearic acid.
- The carbon atoms of fatty acids are numbered as C1, C2, etc. starting from the COOH group. Or, starting from the methyl end, the carbon atoms may be numbered as omega ( $\omega$ )—1,2,3, etc.



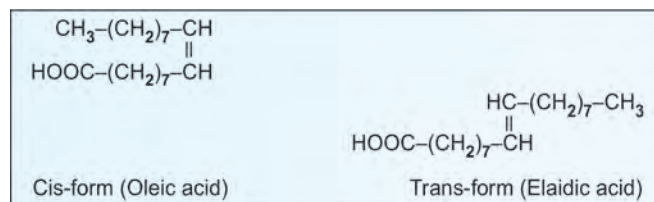
## UNSATURATED FATTY ACIDS

They are named by adding the suffix 'enoic' after the systematic name. They are similar to saturated fatty acids in the reaction of the carboxylic group but also show properties due to presence of the double bond.

Unsaturated fatty acids exhibit geometrical isomerism at the double bonds (Fig. 7.1). All the naturally occurring fatty acids have the **cis configuration**. However, in the body during metabolism trans fatty acids are formed (see Chapter 14).

The **polyunsaturated fatty acids** (PUFA) exist in cis configuration in naturally occurring lipids. **Clinical significance** of PUFA is shown in Box 7.3.

Many clinical and epidemiologic studies have shown positive roles for omega-3 fatty acids in infant development; cancer; cardiovascular diseases; and more recently, in various mental illnesses, including depression, attention-deficit hyperactivity disorder, and dementia. These fatty acids are known to have pleiotropic effects, including effects against inflammation, platelet aggregation, hypertension, and hyperlipidemia.



**Fig. 7.1:** Cis and trans forms of fatty acid



### Hydrogenation

Unsaturated fatty acids may be converted to the corresponding saturated fatty acids by hydrogenation of the double bond.

Linolenic  $\xrightarrow{(+2H)}$  Linoleic  $\xrightarrow{(+2H)}$  Oleic  $\xrightarrow{(+2H)}$  Stearic  
Hydrogenation of oils can lead to solidification and saturation, e.g. Vanaspathi.

### Halogenation

When treated with halogens under mild conditions, the unsaturated fatty acids can take up two halogen atoms, at each double bond to form the halogenated derivative of the fatty acid. For example,

Oleic acid + I<sub>2</sub> → Di-iodo oleic acid

The number of halogen atoms taken up will depend on the number of double bonds and is an index of the degree of unsaturation. (See iodine number, under triacylglycerol).

### Melting Point

The short and medium chain fatty acids are liquids, whereas long chain fatty acids are solids at 25°C. The solubility in water decreases, while melting and boiling points increase with increase in chain length.

The unsaturated fatty acids have lower melting point compared to saturated fatty acids with the same chain length. For example, stearic acid (C18 fatty acid, no double bond) has the melting point 69°C, oleic acid (C18, 1 double bond) has 13°C; linoleic acid (C18, 2 double bonds) has -5°C and linolenic (C18, 3 double bonds) has -10°C.

### Salt Formation

Saturated and unsaturated fatty acids form salts with alkali.  
 $\text{CH}_3\text{—COOH} + \text{NaOH} \rightarrow \text{CH}_3\text{—COONa} + \text{H}_2\text{O}$

Sodium and potassium salts of long chain fatty acids are called **soaps**. Calcium and magnesium soaps are insoluble. Calcium soaps are used in grease.

Alkyl sulfate (R—CH<sub>2</sub>—O—SO<sub>2</sub>—ONa) and alkyl sulfonate (R—CH<sub>2</sub>—SO<sub>2</sub>—O—Na) are not precipitated by hard water and are used as detergents.

### Ester Formation

Both saturated and unsaturated fatty acids form esters with alcohols, especially with glycerol. Fatty acids can form mono-, di- or tri- esters with alcohol groups of glycerol.

Triglycerides or triacylglycerols are also known as **neutral fat** (Fig.7.3).

Glycerol + fatty acid → Monoacylglycerol  
 Monoglyceride + fatty acid → Diacylglycerol  
 Diglyceride + fatty acid → Triglyceride or triacylglycerol

### Oxidation of Fatty Acids

All fatty acids undergo oxidation in the body to give energy. Beta-oxidation is the major process by which acids are oxidized (see Chapter 12). However, the unsaturated fatty acids can undergo auto-oxidation, due to the presence of the highly reactive double bonds and a variety of products are formed.

## NEUTRAL FATS

Neutral fats are also called as triacylglycerols (TAG) or triglycerides (TG). These are esters of the trihydric alcohol, glycerol with fatty acids (Fig. 7.3).

### Nomenclature of Carbon Atoms

As per International Union of Biochemistry (IUB) the correct designations are monoacylglycerol, diacylglycerol and triacylglycerol. But the old terminology of monoglyceride, diglyceride and triglyceride are still popular, especially among clinical laboratory workers.

The carbon atoms of glycerol are designated as α, β and α' or as 1, 2, 3 as shown in Figure 7.3, where R represents the side chain of fatty acids. Enzymes can distinguish between 1st and 3rd carbon atoms.

### Mixed Triglycerides

- Naturally occurring fats and oils are mixtures of triglycerides.
- If all the three hydroxyl groups of the glycerol are esterified to the same fatty acid, a **simple** triacylglycerol is formed, e.g. Tripalmitin, Triolein, etc.

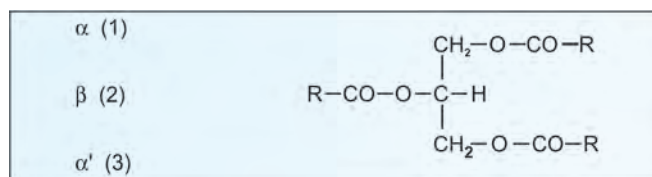


Fig. 7.3: Triacylglycerol (TAG) (Triglyceride)



- iii. A **mixed** triglycerol is formed, when different fatty acids are esterified to the hydroxyl groups of glycerol.
- iv. Generally, two hydroxyl groups are esterified to similar fatty acid and the third with a different one, e.g. 1, 3-dipalmitoyl-2-olein; 1-palmitoyl-2, 3-distearin, etc. When a PUFA is present, it is commonly esterified to the 2nd or  $\beta$ -carbon atom.

### Physical Properties of Triacylglycerols

- i. They are hydrophobic and insoluble in water.
- ii. **Oils are liquids** at 20°C; they are triacylglycerols, which contain a higher proportion of unsaturated fatty acids or short chain triglycerides. Oils are generally of plant origin.
- iii. **Fats are solids** at room temperature and contain mainly saturated long chain fatty acids. Fats are mainly of animal origin. (Table 7.4).
- iv. When the constituent fatty acids have a higher chain length and are predominantly saturated, 'hard fat' is formed, e.g. pig fat.
- v. Fats containing medium chain triacylglycerols or unsaturated fatty acids are soft fats, e.g. butter, coconut oil. Coconut oil contains mainly medium chain TAG, e.g. Lauric and Myristic acids.

### Storage of Energy as Fat

The triacylglycerols are the storage form of lipids in the **adipose tissue**. In a 70 kg normal person, body stores contain about 11 kg of triacylglycerol, which is roughly equivalent to 100,000 kcal. If the same calories were stored as hydrated glycogen, the total weight of this alone would have been 65 kg! When stored as TAG, water molecules are repelled and space requirement is minimal. Excess fat in the body leads to obesity.

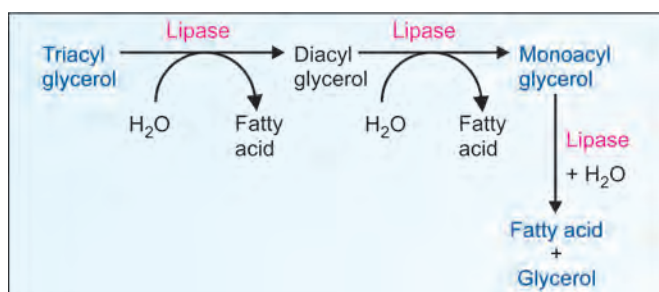


Fig. 7.4: Hydrolysis of triglycerides

### Hydrolysis of Triacylglycerols

This occurs in the body during digestion of dietary fat and mobilization of TAG from adipose tissue. Triacylglycerols in the body are hydrolyzed by enzymes, **lipases** which are hydrolases (class 3 enzymes, Chapter 5). Triacylglycerol is **sequentially hydrolyzed** to diacylglycerol and monoacylglycerol and finally glycerol plus 3 fatty acids. (Fig.7.4).

### Saponification

- i. When triacylglycerols are hydrolyzed by alkali, the process is known as saponification. The products are glycerol and soaps (Fig. 7.5).
- ii. **Saponification number** is defined as the number of milligrams of potassium hydroxide required to saponify one gram of fat.
- iii. It is an indication of the molecular weight of the fat, and is inversely proportional to it. Human fat has a saponification number of 194–198, butter has 210–230 and coconut oil has 253–262.

### Iodine Number

Iodine number of a fat is defined as the number of grams of iodine taken up by 100 grams of fat. It is an index of the degree of unsaturation and is directly proportional to the content of unsaturated fatty acids. Higher the iodine number, higher is the degree of unsaturation, e.g. iodine number of butter is 28, and that of sunflower oil is 130.

### Rancidity of Fat

Fats and oils have a tendency to become rancid. The term rancidity refers to the appearance of an unpleasant smell and taste for fats and oils.

Hydrolytic rancidity is due to partial hydrolysis of the triacylglycerol molecules due to traces of hydrolytic enzymes present in naturally occurring fats and oils.

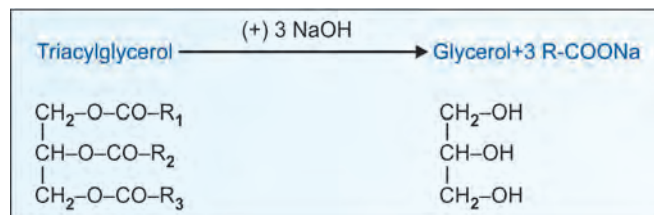


Fig. 7.5: Saponification

Oxidative rancidity is the result of partial oxidation of unsaturated fatty acids with resultant formation of epoxides and peroxides of small molecular weight fatty acids by peroxides and free radicals. The same process, if it occurs in vivo will affect the integrity of biomembranes, leading to cell death.

Many natural fats and oils may contain antioxidants (e.g. vitamin E), which prevent the occurrence of oxidative rancidity. PUFA are more easily oxidized; so vegetable oils with a high content of PUFA are usually preserved with addition of antioxidants.

Repeated heating of oils would lead to the formation and polymerization of **cyclic hydrocarbons**. These will impart an unpleasant taste and color to the oil. Coconut oil having medium chain saturated fatty acids will withstand such polymerization.

## Waxes

They form the secretions of insects, leaves and fruits of plants, e.g. Lanolin or wool fat, beeswax, whalesperm oil, etc. They are esters of higher fatty acids with higher monohydroxy aliphatic alcohols and so have very long straight chains of 60–100 carbon atoms. They are used as the base for the preparation of cosmetics, ointments, polishes, lubricants and candles.

## PHOSPHOLIPIDS

They contain glycerol, fatty acids and a nitrogenous base. Lecithin, was discovered in 1870 by the German biochemist Ernst Hoppe-Selyer. Strecker characterized choline in 1861. In 1884, Thudichum JLW described sphingosine, sphingomyelin, cerebrosides, cephalin and lecithin in brain tissue.

## Phosphatidates

- These are derivatives of phosphatidic acid, which is the simplest phospholipid.
- Phosphatidic acid** is made up of one glycerol to which two fatty acid residues are esterified to carbon

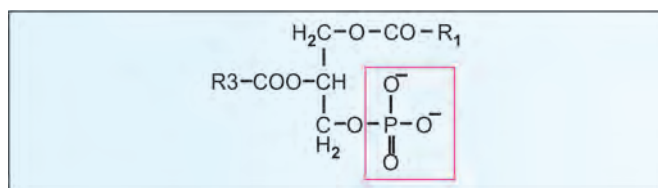


Fig. 7.6: L-Phosphatidic acid

atoms 1 and 2. The 3rd hydroxyl group is esterified to a **phosphoric acid** (Fig. 7.6).

- The molecule has an asymmetric carbon atom and therefore, exhibits optical isomerism. L-isomer is found in nature.

## Amphipathic Nature

Phospholipids in general are amphipathic, particularly Lecithin. They have both hydrophobic and hydrophilic portion in their molecule (Fig. 7.7A and 7.8). The glycerol along with the phosphoric acid and choline constitute the polar 'head' of a phospholipid molecule, whereas the hydrocarbon chains of the fatty acids represent the non-polar 'tail'.

## Micellar Formation

When phospholipids are distributed in water, their hydrophobic parts keep away from water, forming molecular aggregates called micelle (Fig.7.7B). These are

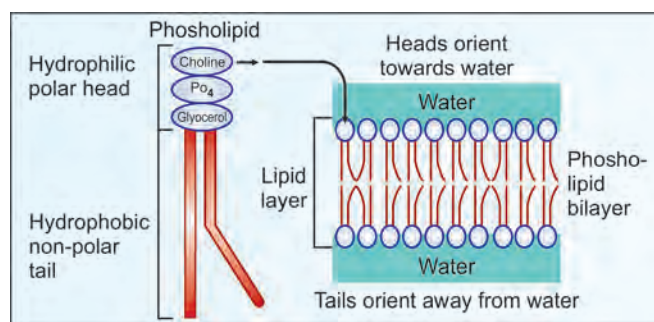


Fig. 7.7A: Phospholipids form the bilayer

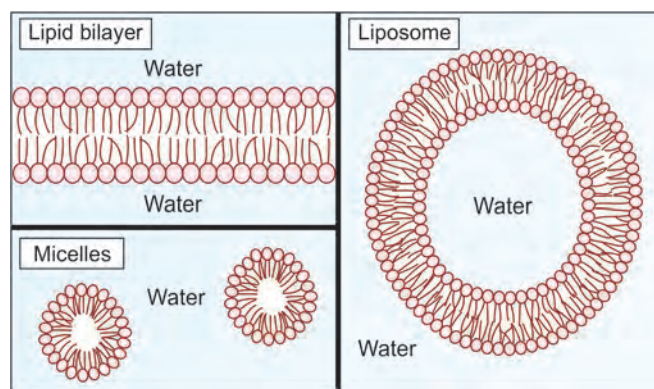


Fig. 7.7B: Phospholipids form micelles and liposomes

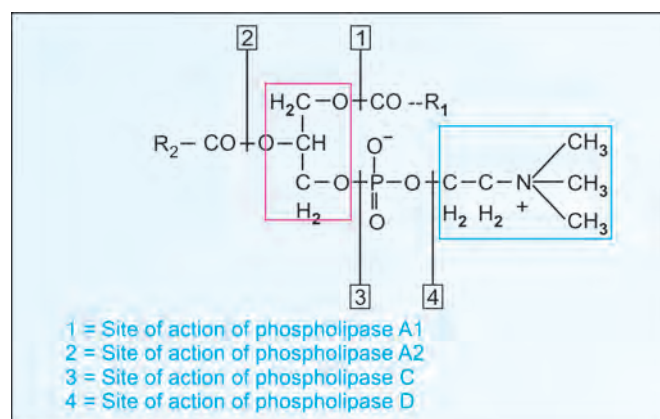
involved in solubilization of lipids in aqueous media and help in digestion and absorption of lipids.

### Liposomes

A lipid bilayer will close on itself under appropriate conditions to form liposomes. Unilamellar or multilamellar liposomes may be formed. They may be prepared by sonication of mixtures of phospholipids and cholesterol (Fig. 7.7B). Liposomes are microscopic spherical vesicles. When mixed in water under special conditions, the phospholipids arrange themselves to form a bilayer membrane which encloses some of the water in a phospholipid sphere. Drugs, proteins, enzymes, genes, etc. may be encapsulated by the liposomes which could act as carriers for these substances to target organs. Liposome-entrapped drugs exhibit superior pharmacological properties than those observed with conventional formulations. Liposomes have important applications in cancer chemotherapy, antimicrobial therapy, gene therapy, vaccines and diagnostic imaging.

### Aquasomes

They are one of the most recently developed delivery systems that are making a niche as the peptide/protein carriers. These are nanoparticulate carrier systems with three layered self-assembled structures. They comprise the central solid nanocrystalline core coated with polyhydroxy oligomers onto which biochemically active molecules are adsorbed. The solid core provides the structural stability. The carbohydrate coating stabilizes the biochemically active molecules. As the conformational integrity of bioactive molecules is maintained, aquasomes are being proposed as a carrier system for delivery of peptide based pharmaceuticals. The delivery system has been successfully utilized for the delivery of insulin, hemoglobin and various antigens. Oral delivery of enzymes like serratiopeptidase has also been achieved.



**Fig. 7.8:** Lecithin R1 and R2 are fatty acids. Red rectangle depicts glycerol group. The blue rectangle is choline which shows polar or hydrophilic property

## Biomembranes

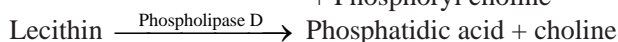
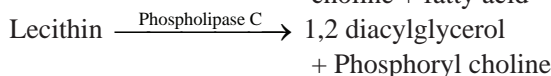
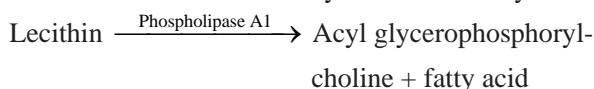
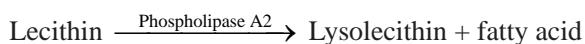
The molecules align themselves to form monolayers with the polar heads pointing in one direction and the nonpolar tails in the opposite direction (Figs 7.7A and B). Only fatty acids with more than 6 carbon atoms form monolayers. This explains their role as components of biomembranes. The self-assembly of phospholipids into bilayers is driven by hydrophobic interaction. They also act as detergents and emulsifying agents. In vivo, they act as pulmonary surfactants.

### Phosphatidylcholine or Lecithin

- This is a nitrogen containing phospholipid. The word lecithin is derived from the Greek word, lekithos = egg yolk. It contains glycerol.
- The alpha and beta positions are esterified with fatty acids. Usually, the fatty acid attached to the beta-carbon, is a **PUFA** molecule (Fig.7.8).
- The phosphoric acid is added to the third position, to form phosphatidic acid. The phosphate group is esterified to the quaternary nitrogen base, **Choline** (Fig.7.8). The molecules of lecithin exist as zwitterions (pI = 6.7).

### Action of Phospholipases

Phospholipases are enzymes that hydrolyze phospholipids. Different phospholipases are involved in the hydrolysis of specific bonds in lecithin (Fig. 7.8). **Phospholipase A2** acts on an intact lecithin molecule hydrolyzing the fatty acid esterified to the beta (second) carbon atom. The products are **Lysolecithin** and fatty acid. Lysolecithin is a detergent and **hemolytic** agent. The enzyme is present in the venom of viper snakes. The hemolysis and consequent renal failure seen in viper poisoning could be thus explained. Actions of other phospholipases are shown in Figure 7.8. The products formed in each case may be summarized as follows:



### Lung Surfactants

Normal lung function depends on a constant supply of lung surfactants. It is produced by epithelial cells. It decreases surface tension of the aqueous layer of lung and prevents collapse of lung alveoli. Constituents of surfactants are **dipalmitoyl lecithin**, phosphatidyl glycerol, cholesterol and surfactant proteins A, B and C. During fetal life, the lung synthesizes sphingomyelin before 28th week of gestation. But as fetus matures, more lecithin is synthesized. The lecithin-sphingomyelin (LS) ratio of amniotic fluid is an index of fetal maturity. A ratio of 2 indicates full lung maturity. Low surfactant level can lead to respiratory distress syndrome (RDS), which is a common cause of neonatal morbidity.

### Respiratory Distress Syndrome (RDS)

It is due to a defect in the biosynthesis of dipalmitoyl lecithin (DPL), the main pulmonary surfactant. Premature infants have a higher incidence of RDS because the immature lungs do not synthesize enough DPL.

### Phosphatidylethanolamine or Cephalin

Cephalin differs from lecithin in that the nitrogen base ethanolamine is present instead of choline (Fig. 7.9). Cephalin is also found in biomembranes and possesses amphipathic properties.

### Phosphatidylinositol

Here, phosphatidic acid is esterified to inositol. (Fig. 7.10). Phosphatidyl inositol biphosphate or **PIP2** is present in biomembranes. This compound plays a vital role in the mediation of hormone action on biomembranes and acts as a second messenger (see Chapter 50).

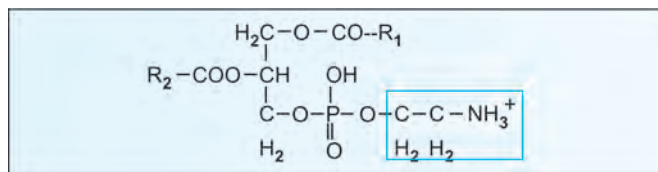


Fig. 7.9: Cephalin (Phosphatidylethanolamine)

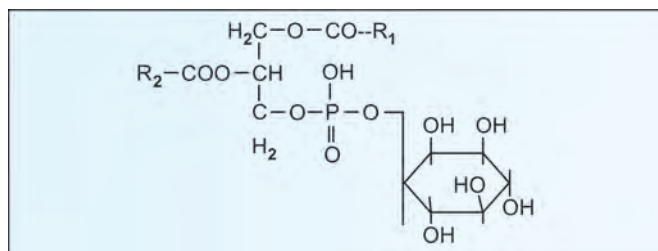


Fig. 7.10: Phosphatidylinositol

### Plasmalogens

These are phospholipids which have an aliphatic long chain  $\alpha$ - $\beta$  unsaturated alcohol in ether linkage with the first hydroxyl group of glycerol (Fig. 7.11). The second OH group is esterified to a fatty acid. The phosphoric acid is attached to choline or ethanolamine (Fig. 7.11). The alcohols have about C12 to C18 chain length. Plasmalogens are found in biomembranes in brain and muscle.

### Phosphatidylglycerol

It is formed by esterification of phosphatidic acid to glycerol. When two molecules of phosphatidic acid are linked with a molecule of glycerol, diphosphatidylglycerol or **cardiolipin** is formed. It is the major lipid of mitochondrial membrane. Commercially, it is extracted from myocardium. Decreased cardiolipin level leads to mitochondrial dysfunction, and is accounted for heart failure, hypothyroidism and some types of myopathies.

### Sphingolipids

The sphingosine containing lipids may be of 3 types; **phosphosphingosides**, **glycosphingolipids** and **sulfatides**. All sphingolipids have the long aliphatic amino alcohol **sphingosine** (Fig. 7.12) which is attached to a fatty acid in amide

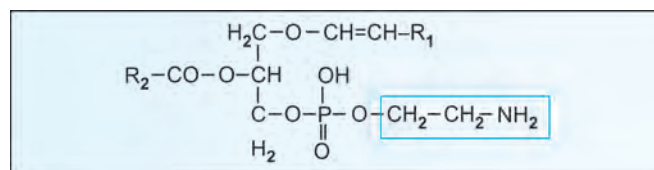


Fig. 7.11: Ethanolamine plasmalogen

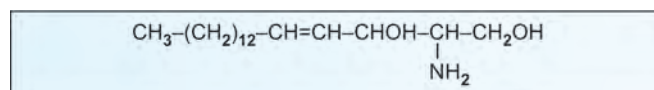


Fig. 7.12: Sphingosine

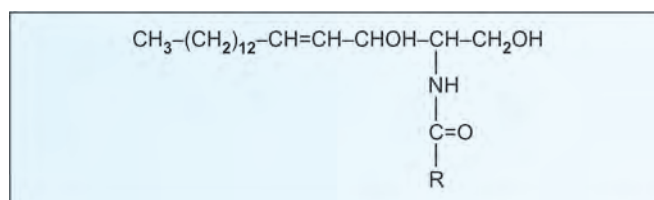


Fig. 7.13: Ceramide



linkage to form a **ceramide** (Fig. 7.13). The fatty acid has a chain length varying from C18 to C24.

## Phosphosphingosides

They contain **phosphoric acid** group. A common phosphosphingoside present abundantly in biomembranes, especially of the nervous system, is **sphingomyelin**. It contains choline (Fig. 7.14).

## Sphingomyelins

**Sphingomyelins are the only sphingolipid that contain phosphate and have no sugar moiety.** They are found in large quantities in nervous system. Different sphingomyelins may be formed depending on the fatty acid attached. Common fatty acids found are—lignoceric (24 C), nervonic (24 C, one double bond) and cervonic (22 C, 6 double bonds) acids (Table 7.2). Because of its amphipathic nature sphingomyelin can act as an emulsifying agent and detergent. The relative proportion of lecithin and sphingomyelin is important in biological fluids like bile, amniotic fluid, etc. Sphingomyelin combined with fatty acid is called **ceramide**, which is a component of glycosphingolipids.

Clinical relevance of antiphospholipid antibody is described in Box. 7.4.

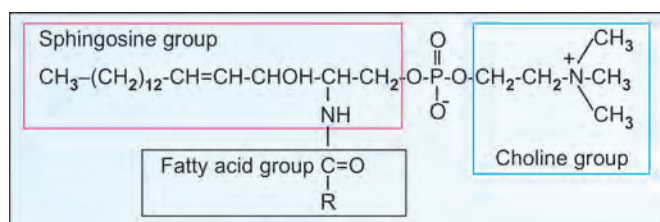


Fig. 7.14: Sphingomyelin

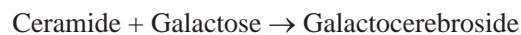
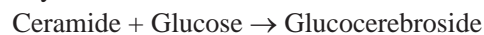
### Box 7.4: APL antibody syndrome

Antiphospholipid antibodies have been found to be present in blood in patients with autoimmune diseases and in patients with thrombotic episodes. In pregnancy, the presence of these antibodies can cause complications like miscarriage, eclampsia and preterm labor. Here the antibodies are developed against membrane phospholipid, **cardiolipin**.

## Non-phosphorylated Lipids

### Glycosphingolipids (Glycolipids)

They are seen widely in nervous tissues. This group of lipids do not contain phosphoric acid; instead they contain carbohydrates and ceramide.



### Globosides (Ceramide Oligosaccharides)

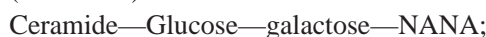
They contain two or more hexoses or hexosamines, attached to a ceramide molecule.



Lactosyl ceramide is a component of erythrocyte membrane.

### Gangliosides

They are formed when ceramide oligosaccharides have at least one molecule of NANA (N-acetyl neuraminic acid) (sialic acid) attached to them.



This is designated as GM3 (ganglioside M3).

Gangliosides contribute to stability of paranodal junctions and ion channel clusters in myelinated nerve fibers. Autoantibodies to GM1 disrupt lipid rafts, paranodal or nodal structures, and ion channel clusters in peripheral motor nerves.

### Sulfolipids or Sulfatides

These are formed when sulfate groups are attached to ceramide oligosaccharides. All these complex lipids are important components of membranes of nervous tissue. Failure of degradation of these compounds results in accumulation of these complex lipids in CNS. This group of inborn errors is known as **lipid storage diseases**. These are described in Chapter 14.

## Related Topics

Cholesterol, steroids, bile acids and lipoproteins are described in Chapter 13. Chapter 14 contains the metabolism of compound lipids.

## ■ QUICK LOOK OF CHAPTER 7

1. Lipids may be broadly classified into Simple, Compound and Derived lipids.
2. Compound lipids are Phospholipids, Sphingolipids, Sulfolipids, etc.
3. Fatty acids are classified based on (i) Number of carbon atoms (ii) Length of hydrocarbon chain and (iii) Nature of hydrocarbon chain.
4. Palmitic and stearic acid are the most abundant saturated fatty acids in the body.
5. Essential fatty acids are those, which cannot be synthesized in the human body and have to be supplemented in the diet. As for example, Linoleic acid, Linolenic acid and Arachidonic acid.
6. Arachidonic acid is the precursor of prostaglandins.
7. Saponification number is defined as the number of milligrams of KOH required to saponify 1 gram of fat.
8. Iodine number of a fat is defined as the number of grams of iodine taken up by 100 grams of fat. It is directly proportional to the degree of unsaturation.
9. Rancidity refers to the appearance of unpleasant odor and taste to oils and fats. Rancidity can be of two types, Hydrolytic and Oxidative.



# SECTION B

## General Metabolism

- Chapter 8 Overview of Metabolism
- Chapter 9 Major Metabolic Pathways of Glucose
- Chapter 10 Other Metabolic Pathways of Glucose
- Chapter 11 Metabolic Pathways of Other Carbohydrates
- Chapter 12 Metabolism of Fatty Acids
- Chapter 13 Cholesterol and Lipoproteins
- Chapter 14 MCFA, PUFA, Prostaglandins and Compound Lipids
- Chapter 15 General Amino Acid Metabolism (Urea Cycle, One Carbon Metabolism)
- Chapter 16 Simple, Hydroxy and Sulfur-containing Amino Acids
- Chapter 17 Acidic, Basic and Branched Chain Amino Acids
- Chapter 18 Aromatic Amino Acids
- Chapter 19 Citric Acid Cycle
- Chapter 20 Biological Oxidation and Electron Transport Chain
- Chapter 21 Heme Synthesis and Breakdown
- Chapter 22 Hemoglobin





# CHAPTER 8

## Overview of Metabolism

### Chapter at a Glance

The reader will be able to answer questions on the following topics:

- Study on six levels of organizations
- Metabolic pathways and control mechanisms
- Importance of blood glucose
- Metabolic profile of organs
- Metabolic adaptations during starvation

### EXPERIMENTAL STUDY OF METABOLISM

The study of metabolic sequences may be conducted at **six levels of organizations**, each at deeper levels of cellular architecture, and each giving different perspectives to the same phenomenon.

#### Level 1: The Intact Organism

The essential nature of amino acids and vitamins, etc. could be understood by feeding animals with diets lacking in one of the ingredients of food. In 1842, Friedrich Wohler showed that benzoic acid when injected is excreted as **hippuric acid** (benzoyl glycine); this was the starting point of metabolic study in animals. Radiolabeled iron ( $^{59}\text{Fe}$ ) is given, and incorporation of the radioactivity in bone marrow and erythrocyte precursors are studied, which provides information regarding the life span of **RBCs**. The studies on inborn errors have been of great help in understanding normal processes inside the body. It is easy

to study individual enzyme systems in microorganisms. By utilizing mutant strains of bacteria, metabolic defects may be elucidated.

#### Level 2: Organ Perfusion

The organ can be isolated preserving its blood vessels. The organ is cannulated and perfused with Ringer solution. To the perfusion fluid any compound may be added and the fluid emerging from the organ is analyzed for the metabolites of the compound.

#### Level 3: Organ Slices

The next lower level of study is by using the slices of organs, about 50 micrometer thick. Otto Warburg (Nobel prize 1931) was the first scientist to study metabolic pathways using organ slices. (The instrument for study of tissue respiration is known as Warburg apparatus). The advantage of this procedure is that the cellular organelles were preserved intact.



Alexis Carrel  
NP 1912  
1873–1944



Friedrich  
Wohler  
1800–1882

Metabolic transformations of nutrients could be studied in detail. If rat liver slices are incubated with medium containing glucose, carbon dioxide is evolved.

### Level 4: Intact Cells and Tissue Culture Set-up

Tissues or cells can be kept in defined culture medium for a few days for metabolic studies. The medium contains nucleotides, carbohydrates, amino acids, vitamins and growth factors. The pH of the medium should be kept around 7.2. If **labeled glucose** is added in the culture, the utilization of glucose and its incorporation into glycogen etc. could be identified. If **labeled nucleotides** are added in the culture, cells take them up for DNA synthesis and the uptake of radioactivity will be proportional to the cell division. Activities of **drugs** can be studied in cell culture system. Biologically useful substances can be harvested from tissue culture set-up. For example, specific **monoclonal antibodies** could be obtained from the supernatant of cultured **hybridoma** cells (see Chapter 49).

The cells from cancer tissues have indefinite capacity to grow into any number of passages. This **immortalization** is characteristic of cancer tissues. A good example is the HeLa cell line from cervical cancer tissue, now growing in laboratories all over the world. This cell line was originally started in 1938 from a patient, Henrietta Lacks whose first and last names were abbreviated to name the culture. A pioneer in tissue culture work was Alexis Carrel (Nobel prize, 1912).

### Level 5: Homogenates

The tissue is homogenized in an isotonic medium and cell wall is broken by ultrasonic vibration and cellular organelle are separated. For example, isolated mitochondrial preparation will show enzymes of electron transport chain.

### Level 6-A: Purified Enzymes

Enzyme preparations may be used to study individual metabolic reactions, their regulation, co-factors, etc.

### Level 6-B: DNA or Genomics

Present day research work mainly involves the studies at genetic level (molecular biology). For example, phenylketonuria is due to a mutation in the gene coding for the enzyme phenylalanine hydroxylase. The full complement of genes within the cells (**genomics**), their expression and regulation (**transcriptomics**) and the gene products (**proteomics**) can be studied.

### Use of Radioisotope Tracers

The isotope studies provide valuable information regarding precursor-product relationship, rate of metabolism and anatomical distribution (see Chapter 59). When **<sup>14</sup>C-labeled glucose** is administered, the metabolites can be traced to different organs. Administration of **<sup>15</sup>N-labeled glycine** was followed by appearance of the label in different compounds like hemoproteins, nucleic acids, and creatinine.

### Studies on Metabolism

Four aspects of metabolic pathways are studied:

- Sequence of reactions
- Precursor-product relationship
- Mechanism of reaction
- Control mechanisms.

Metabolic pathways may also be studied by creating perturbances to the system, such as:

- by causing metabolic blocks
- by studying organisms with metabolic defects
- genetic manipulation, e.g. gene knock-out (details in Chapter 49).

## METABOLISM

Thousands of chemical reactions are taking place inside a cell in an organized, well coordinated, and purposeful manner; all these reactions are collectively called as **Metabolism**. Metabolism serves the following purposes:

- Chemical energy is obtained from the degradation of energy-rich nutrients.
- Food materials are converted into the building block precursors of cellular macromolecules. These building blocks are later made into macromolecules, such as proteins, nucleic acids, polysaccharides, etc.

Biomolecules required for specialized functions of the cell are synthesized.

3. Metabolic pathways are taking place with the help of sequential enzyme systems. These pathways are regulated at three levels:
  - a. Regulation through the action of allosteric enzymes, which increase or decrease the activity under the influence of effector molecules.
  - b. Hormonal regulation. Hormones are chemical messengers secreted by different endocrine glands.
  - c. Regulation at the DNA level; the concentration of the enzyme is changed by regulation at the level of synthesis of the enzyme.

## Types of Metabolic Pathways

- A. **Catabolic** (degradation) pathways, where energy rich complex macromolecules are degraded into smaller molecules. Energy released during this process is trapped as chemical energy, usually as ATP.
- B. **Anabolic** (biosynthesis) pathways. The cells synthesise complex molecules from simple precursors. This needs energy.
- C. **Amphibolic** pathways are seen at cross-roads of metabolism, where both anabolic and catabolic pathways are linked.

**Metabolism** is a sum of the following 4 major types of pathways:

1. Fuel oxidative pathway: Food materials consumed are converted to energy
2. Fuel storage and mobilization pathway: Stored fuel mobilized when there is no intake of food or during strenuous exercise
3. Biosynthetic pathway: For the synthesis of proteins and other such macromolecules. The basic materials needed for biosynthetic pathways include certain amino acids, essential fatty acids and vitamins
4. Detoxification and waste disposal pathway: For removal of toxic waste products from the body.

Additional pathways, which help these essential pathways are transport and intercellular signaling pathways.

## Stages or Phases of Metabolism

The degradation of foodstuffs occurs in three stages.

- i. In the first stage, digestion in the gastrointestinal tract converts the macromolecules into small units. For example, proteins are digested to amino acids. This is called **primary metabolism**.
- ii. Then these products are absorbed, catabolized to smaller components, and ultimately oxidized to  $\text{CO}_2$ . The reducing equivalents are mainly generated in the mitochondria by the final common oxidative pathway, citric acid cycle. In this process, NADH or  $\text{FADH}_2$  are

generated. This is called **secondary or intermediary metabolism**.

- iii. Then these reduced equivalents enter into the **electron transport** chain (ETC, or Respiratory chain), where energy is released. This is the **tertiary metabolism** or Internal respiration or cellular respiration (see Fig. 20.1).

**Glucose** enters glycolysis pathway, converted to acetyl CoA and are oxidized in the citric acid cycle. Carbohydrate metabolism is centered around glucose, and is mainly used for provision of energy to the body (see Chapter 9).

**Lipid metabolism** is centered around fatty acids, which are also used for provision of energy (see Chapter 12).

**Amino acids** are mainly meant for body building purpose. However, most of the amino acids are eventually transaminated, the carbon skeletons are oxidized. This will provide some energy. (see Chapter 15). But energy production is not the main purpose of amino acid metabolism.

Carbohydrate, lipid and amino acid metabolisms are inter-related and details are given in chapters in the next 9 chapters of this book.

## METABOLIC PROFILE OF ORGANS

The metabolic pattern or metabolic profile of different organs is different depending on its function. Moreover, the organs are able to adapt to metabolic alterations in fed state and starvation. The storage forms of fuels are shown in Table 8.1.

Calories are stored in the body as fat and glycogen. The approximate percentage of storage form of energy (total fuel reserve) present in a normal human body is, fat 85%, glycogen 1%, and proteins 14%. Box 8.1 shows the energy utilisation of an average person.

Fat stores are mobilized actively only on prolonged fasting, even though adipose tissue fat is undergoing turnover on a daily basis.

### Box 8.1: Energy utilization of average person

The energy consumption varies based on lifestyle in adults. Approximately 300 g of carbohydrates (1200 kcal), 70 g of proteins (294 kcal) and 80 g of fats (720 kcal) are consumed by a person with a sedentary lifestyle. Therefore about 60% calories are derived from carbohydrates, 15% from proteins and rest from fats. The energy reserves provide energy in between meals and after overnight fasting (glycogenolysis and gluconeogenesis).

**TABLE 8.1:** Energy reserves of man

Stored fuel	Weight (in gram)	Energy equivalent (in kilo calories)
Glycogen in liver	70	280
Glycogen in muscle	120	480
Glucose in body fluids	20	80
Fat in adipose tissue	15,000	135,000
Protein in muscle	6,000	24,000

Caloric homeostasis is maintained regardless of whether a person is well fed, fasting, or in a state of starvation. Similarly metabolic profile of various organs and tissues change to adapt to physiological and pathological states, so that caloric homeostasis is maintained unless extreme conditions set in. On an average during the well fed state, a person consumes 180–280 g of Carbohydrates, 70–100 g of proteins and 70–100 g of fat contributing about 2500 calories.

The reciprocal regulation of glycolysis and gluconeogenesis is the major deciding factor in the flux of metabolic intermediates through these pathways.

## Brain

- i. Although brain represents only 2% of adult body weight, it needs 10–20% cardiac output. About 750 mL of blood circulates through the brain per minute. Neurons can survive only a few minutes without blood supply. Occlusion of blood supply to brain causes unconsciousness within 10 seconds.
- ii. There is **no stored fuel** in the brain. Glucose, the preferred fuel for the brain, should be in continuous supply. Glucose can freely enter the brain cells.
- iii. The total consumption of glucose by brain is about 120 g/day (480 kcal). Thus, about **60% of the total carbohydrate intake by the body is metabolized by the brain**. Moreover, about 25% of the oxygen consumed by the adult body is due to glucose oxidation in brain. In children, this may be as high as 50%.
- iv. **Brain under conditions of anoxia:** In anoxia the rate of **lactate production** by glycolysis rises to 5 or 8 times within one minute. The Pasteur effect (see Chapter 9) is the brain's protection against conditions of anoxia. **Blood glucose level below 30 mg/dL is fatal.**
- v. **Brain and acetoacetate:** The brain is unable to utilize fatty acids as a source of fuel since the fatty acids complexed to albumin are unable to traverse the blood brain barrier. But, brain can effectively utilize acetoacetate. This is again a survival technique in diabetic and starvation ketosis.

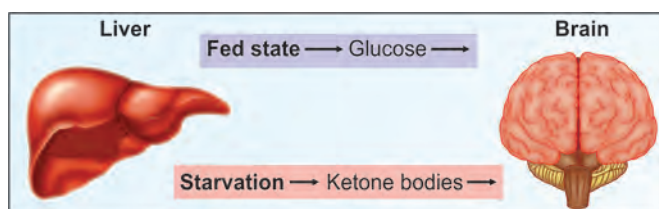


Fig. 8.1: Metabolic alterations in brain

- vi. **Brain and starvation:** During starvation, a significant part (60–70%) of the energy requirement of the brain is met by ketone bodies (Fig. 8.1).
- vii. Under conditions of partial anoxia, the production of ammonia is increased. This is immediately trapped as glutamine. The  $\text{NH}_2$  group of glutamine and glutamate can be used for synthesis of other amino acids (see Chapter 17).

## Skeletal Muscle

- i. The skeletal muscle forms about 45% of the total weight of the body. About 0.5% muscle weight is due to glycogen content. Following a meal, the muscle glycogen content increases by about 1% of the total weight.
- ii. **Muscle metabolism after a meal:** The uptake and storage of glucose by the skeletal muscle is under the influence of insulin. Following a meal, the level of the glucose and insulin are high. So glycogen synthesis is enhanced. (Fig. 8.2). The resting muscle uses fatty acids as a major fuel (85%).
- iii. **Muscle metabolism during exercise:** Muscle uses glycogen for short active spurts of activity. Glycogen is rapidly broken down to form lactate. The lactate has to be transported to liver to undergo gluconeogenesis (Cori's cycle in Chapter 9). Muscle however uses fatty acid as fuel for aerobic exercise and long distance running.
- iv. **Muscle metabolism during starvation:** During starvation, maximum glucose is spared for the brain. The **free fatty acid (FFA)** mobilized from adipose tissue is the preferred fuel for muscle during starvation. FFA does not require insulin, and during fasting insulin level is low (Table 8.3).
- v. **During prolonged starvation,** muscle protein breakdown occurs and alanine is released to the bloodstream. It is transported to liver to provide substrate for gluconeogenesis (glucose-alanine cycle in Fig. 9.30). The metabolic fuel during prolonged fasting is **ketone bodies**. **Branched chain amino acids** are utilised by the skeletal muscle (Fig. 8.3 and Table 8.2).

## Adipose Tissue

It is the **storehouse of energy** in the body (about 1,35,000 kcal) (Table 8.1). The energy is stored in the concentrated form, triacylglycerol. The chylomicrons and VLDL are hydrolyzed by lipoprotein lipase present on capillary walls. It is activated by insulin. The fatty acids are re-esterified



to form triacylglycerol (see Chapter 11). The glycerol is derived from dihydroxy acetone phosphate (DHAP), an intermediate of glycolysis. Therefore, for storage of triacylglycerol, both fatty acid synthesis and glycolysis should operate. The uptake of glucose, glycolysis and lipogenesis are all favored by insulin.

About 25% of glucose taken up by adipose tissue is metabolized by the HMP shunt pathway, and the rest by glycolysis. The NADPH generated from the shunt pathway is used for the synthesis of fatty acids. The NADH produced during glycolysis is used to reduce the DHAP to glycerol-3-phosphate. Table 8.3 shows the major metabolic fuels of different organs during various physiological conditions.

During fasting, triacylglycerols in the adipose tissue are hydrolyzed. Cyclic AMP mediated activation of hormone sensitive lipase occurs in response to the high glucagon-insulin ratio. Glucocorticoids also have a stimulant lipolytic effect during fasting.

### Liver

- i. The liver plays a central role in metabolism by providing adequate quantities of metabolic fuel for other organs.

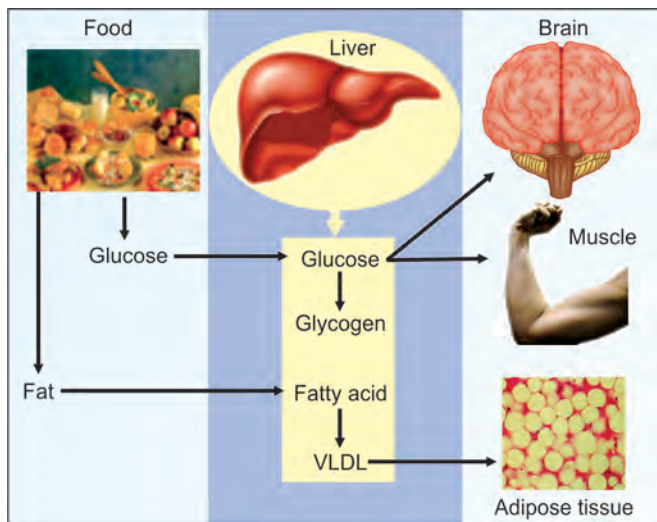


Fig. 8.2: Metabolism in well-fed state

Almost all the metabolic pathways operate in the liver; a notable exception being ketolysis.

- ii. **Liver metabolism in fed state:** Under well-fed conditions, the liver takes up glucose from circulation and stores it as **glycogen**. Similarly the fatty acids synthesised by the liver are incorporated into **VLDL** and secreted into bloodstream (Fig. 8.2). Liver is the major site of degradation of amino acids and detoxification of ammonia into urea (see Chapter 15).
- iii. **During starvation,** liver provides glucose by **glycogenolysis** and later by **gluconeogenesis** so that the obligatory requirements of the brain are met (Fig. 8.3). Moreover, liver also produces the **ketone bodies**, an alternate source of fuel. But the liver cannot use ketone bodies as its own fuel. Table 8.3 shows the major metabolic fuels of different organs during various physiological conditions.

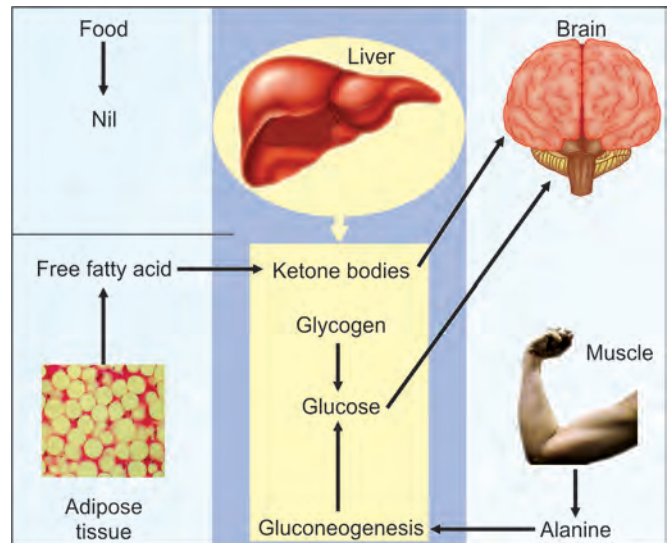


Fig. 8.3: Metabolism in fasting state

TABLE 8.2: Adaptations during starvation		
Fed state	Skeletal muscle	Cardiac muscle
Preferred fuel at rest	Fatty acids	FFA, ketone bodies, lactate
Exercise	Glycogen to lactate	Fatty acids
Starvation Adaptations	Protein breakdown; release of amino acids; FFA, ketone bodies and branched chain amino acids utilized	Fatty acids, branched chain amino acids and ketone bodies utilized

TABLE 8.3: Major fuels in different organs				
	Brain	Skeletal muscle	Cardiac muscle	Adipose tissue
After a meal	Glucose	Glucose, Fatty acids	Glucose, pyruvate	Fatty acids; glucose
Fasting (short-term)	Glucose	Fatty acids	Fatty acids	Fatty acids
Fasting (long-term)	Glucose; ketone bodies	Ketone bodies; Branched chain aa	Ketone bodies	Fatty acids; ketone bodies
Exercise		Glycogen	Fatty acids	

## Cardiac Muscle

Heart consumes more energy than any other organ. It utilizes about 6 kg of ATP per day, 20-30 times of its own weight. Cardiac muscle derives its energy by oxidative metabolism of fatty acids (60–90%) and glucose 10–40%. Ketone bodies are also normally metabolized.

In addition, energy transfer to heart's myofibrils occurs by creatine kinase catalyzed energy shuttle. Phosphocreatine being a smaller molecule than ATP can easily diffuse into the myofibrils from mitochondria. The myofibrillar creatine kinase catalyzes the reformation of ATP. The free creatine diffuses back. The creatine kinase system acts as an energy buffer, by keeping ATP level constant. When ADP level increases due to a fall in phosphocreatine, it inhibits intracellular enzymes causing failure of the heart's contracting mechanism. In a failing heart, the uptake and utilization of fatty acids and glucose occurs. In advanced heart failure, insulin resistance also develops, further decreasing the glucose utilization. At the same time, the metabolism of a hypertrophied heart switches from fatty acid utilization to glucose.

Table 8.4 shows the activity of key enzymes under well-fed conditions, fasting and starvation and their regulators.

## Effect of Exercise on Metabolic Profile

Long distance running is the typical example of aerobic exercise, where as sprinting or weight lifting exemplifies anaerobic exercise. During anaerobic exercise, the major organ involved is the skeletal muscle with very little involvement of other organs. The relative ischemia created by the compression of blood vessels in the muscle will necessitate the use of glycogen and phosphocreatine available in the muscle to supply the required energy.

During moderate aerobic exercise, the muscular stores of glycogen are used, but in a normal individual this is not sufficient to provide a continuous supply of ATP for exercise like long distance running. The respiratory quotient (RQ) falls during long distance running since there is a progressive change from glycogenolysis to fatty acid oxidation to meet the energy demands. Muscles start oxidizing fatty acids and the high AMP level which activates AMP kinase and low malonyl CoA that

activates carnitine acyl transferase (CAT) will favor fatty acid oxidation. The training for athletes is different depending on whether they are sprinters or long distance runners since the energy sources are different. Rest after a vigorous muscular activity often results in repletion of the exhausted glycogen stores.

In muscle developed by exercise and training, the size and number of mitochondria are more as well as the level of enzymes for fatty acid oxidation and ketone body utilization. Hence the trained muscle can better utilize non-carbohydrate sources of energy. So exhaustion is delayed (Box 8.2).

## Metabolic Adaptations During Starvation

When blood glucose levels decline as in starvation, it is normalized by intrahepatic glycogenolysis and gluconeogenesis. Once the glycogen and gluconeogenesis are utilized, fatty acids, ketone bodies and finally body proteins are utilized for energy production. In early fasting the effect of short-term regulation by altering the activity of existing enzymes (fine control) is more significant. When starvation is prolonged (>3 days), long-term adaptation sets in, e.g. brain starts metabolizing ketone bodies deriving about 30% energy from ketone bodies.

### Box 8.2: Long distance runners do not compete with sprinters!!

Long distance running is an example of **aerobic exercise**. Metabolic profile of organs changes during aerobic exercise with fatty acids and ketone bodies being the preferred fuel for the skeletal muscle. Because glycogenolysis is not sufficient to meet the energy demands of prolonged aerobic exercise.

**Anaerobic exercise**, on the other hand, has no effect on the metabolic profile of organs other than skeletal muscle. The skeletal muscle depends on its own glycogen stores and phosphocreatine to meet the demand for ATP.

**TABLE 8.4:** Key enzymes under well-fed conditions, fasting and starvation

Enzyme	Fed	Fasting	Activator	Inhibitor
Glucokinase	Increase	Decrease	Insulin, glucose	F-6-P
Phosphofructokinase1	Increase	Decrease	F-2,6-bisP, AMP	ATP, Citrate
Fructose 1,6 bisphosphatase	Decrease	Increase	ATP, Citrate	F-2,6-bisP, AMP
Pyruvate carboxylase	Decrease	Increase	Acetyl CoA	
PEPCK	Decrease	Increase	Glucagon, corticoids	Insulin
Glycogen phosphorylase	Decrease	Increase	Glucagon, AMP	Insulin
Glycogen synthase	Increase	Decrease	Insulin, G-6-P	Glucagon
Carnitine acyltransferase		Increase	Glucagon	Malonyl CoA
Acetyl CoA carboxylase	Increase	Decrease	Insulin, citrate	Fatty acyl CoA
Hormone sensitive lipase	Decrease	Increase	Glucagon	Insulin

PEPCK = phosphoenol pyruvate carboxykinase; F-6-P = fructose-6-phosphate; F-2,6-bisP = fructose-2,6-bisphosphate; G-6-P = glucose-6-phosphate

## First Stage: Glycogenolysis

Table 8.2 and Figure 8.3 show the changes in activities during starvation. During early fasting, at first, blood glucose level is maintained by hepatic glycogenolysis. The glycogen stores are sufficient for about 18 hours. The primary requirement for glucose is to meet the demands of the brain.

## Second Stage: Gluconeogenesis

Even before the glycogen stores are depleted, gluconeogenesis is accelerated (Figs 8.3 and 8.4). The amino acids released from muscle form the major substrate for gluconeogenesis. The amino nitrogen is transferred from other amino acids to pyruvate to form alanine. Thus the amino group reaches the liver as alanine where it is transaminated to give pyruvate for gluconeogenesis. This glucose alanine cycle (see Fig. 9.30) serves to transport the amino nitrogen of other amino acids to liver in a harmless form. Glutamic acid also serves as an important mode of transport of amino acids to liver (see Chapter 15).

The **branched chain amino acids** liberated by muscle protein catabolism especially leucine and isoleucine are utilized by the muscle to give energy. Brain can preferentially take up the glucogenic valine from the bloodstream. The plasma level of branched chain amino acids reaches a peak by 5th day of starvation.

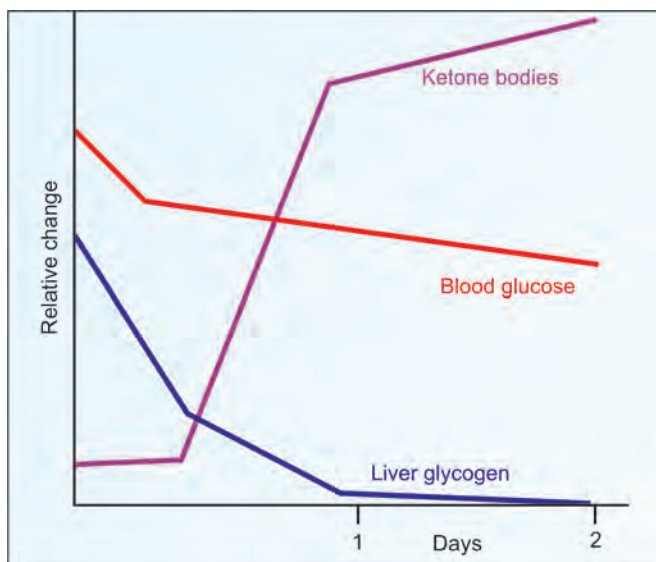


Fig. 8.4: Relative changes of important parameters during starvation

Glutamine also acts as fuel for several cells like enterocytes, lymphocytes, macrophages, etc. This glutamine cycle involves the hydrolysis of glutamine to glutamate, followed by transamination to alpha ketoglutarate. In the TCA cycle malate is formed from alpha ketoglutarate, which by the action of malic enzyme is decarboxylated to pyruvate. Pyruvate on transamination gives rise to alanine.

## Third Stage: Lipolysis

The prevailing state of high glucagon-insulin ratio stimulates cAMP-mediated lipolysis by increasing the activity of hormone sensitive lipase. Then skeletal muscle, heart and kidney will shut down their glucose utilization; and will depend mainly on fatty acids for energy needs (glucose fatty acid cycle). Inactivation of pyruvate dehydrogenase by phosphorylation is the basis of this change. The stimulation of the activity of CAT by glucagon favors increased rate of beta oxidation. The increased rate of lipolysis and beta oxidation provides an alternate source of fuel as acetyl CoA and subsequently **ketone bodies**. Ketone bodies provide fuel for tissues like heart muscle, skeletal muscle and to some extent the brain.

## Fourth Stage: Acidosis

However, this state cannot continue indefinitely since excessive production of ketone bodies leads to metabolic acidosis. When the bicarbonate buffering capacity is exceeded, the pH falls and hyperventilation occurs as a compensatory mechanism. Since glucose levels are comparatively low during prolonged starvation, secretion of insulin is reduced, but more glucagon is secreted. A fall in the T3 level leads to decrease in basal energy requirements by 25%.

## Role of AMP kinase as a fuel gauge

AMP kinase is activated by an increase in AMP levels, which signifies a low ATP level and a low energy charge in the cell. The activation of AMP kinase turns off the anabolic pathways that consume energy and speeds up the catabolic pathways that provide energy. Phosphorylation inhibits enzymes like acetyl CoA carboxylase (fatty acid synthesis), Glyceraldehyde-3-phosphate acyl transferase (TAG synthesis) and HMG CoA reductase (cholesterol synthesis). At the same time fatty acid oxidation is activated by the low malonyl CoA level. Similar activation and inactivation reactions occur in the adipose tissue also.

### **Fifth stage: Death from Starvation**

Metabolic acidosis and dehydration, unless corrected efficiently, will lead to death. A normal person has fuel reserves to live up to 45–60 days. Examples are available in history. As part of the freedom struggle, Sri Jatin Das took a fast unto death, who died on the 61st day of his hunger strike on 13th September 1929.

To summarize, when blood glucose levels decline as in starvation, it is normalized by intrahepatic glycogenolysis and gluconeogenesis. Once the glycogen and gluconeogenesis

are utilized, then fatty acids, ketone bodies and finally body proteins are utilized for energy production.

### **Metabolic Profile During Early Refeeding After Fasting**

The metabolism of triacylglycerol and fatty acids occurs as during the well fed state, lipogenesis. However, the liver switches to gluconeogenic mode for a few hours after refeeding, so that sufficient glucose is provided for glycogen synthesis. Amino acids absorbed from the gut, provide the substrate.

# CHAPTER 9

## Major Metabolic Pathways of Glucose

### Chapter at a Glance

The reader will be able to answer questions on the following topics:

- Digestion of carbohydrates
- Absorption of glucose and glucose transporters
- Glycolysis pathway and its regulation
- Energy yield from glycolysis
- Cori's cycle
- Pyruvate as a junction point
- Gluconeogenesis and malate shuttle
- Glucose alanine cycle

### DIGESTION OF CARBOHYDRATES

- In the diet, carbohydrates are present as complex polysaccharides (starch, glycogen), and to a minor extent, as disaccharides (sucrose and lactose). They are hydrolyzed to monosaccharide units in the gastrointestinal tract. Cooking makes the digestion process easier.
- The process of digestion starts in mouth by the **salivary alpha-amylase**. However, the time available for digestion in the mouth is limited, because the gastric hydrochloric acid will inhibit the action of salivary amylase.
- In the **pancreatic** juice another **alpha-amylase** is available, which will hydrolyze the alpha-1,4 glycosidic linkages randomly, so as to produce smaller subunits like maltose, isomaltose, dextrans and branched or unbranched oligosaccharides.
- The cells of brush border of intestine contain the enzymes, **sucrase**, **maltase**, **isomaltase** and **lactase**.

They hydrolyze the corresponding disaccharides into component monosaccharides, which are then absorbed.

### Clinical Application; Lactose Intolerance

- Lactase hydrolyzes lactose to glucose and galactose. **Lactase** is present in the brush border of enterocytes.
- Deficiency of lactase** leads to lactose intolerance. In this condition, lactose accumulates in the gut. Irritant diarrhea and flatulence are seen.
- The causes may be congenital or acquired. As age advances, lactase activity decreases and secondary lactose intolerance occurs. Acquired lactose intolerance can also occur when there is a sudden change to a milk based diet. Lactase is an inducible enzyme. If milk is withdrawn temporarily, diarrhea will be limited. Curd is also an effective treatment, because the lactobacilli present in curd contains the enzyme lactase. Lactase is abundantly seen in yeast, which could also be used in treatment.



## ABSORPTION OF CARBOHYDRATES

Only monosaccharides are absorbed by the intestine. Absorption rate is maximum for galactose; moderate for glucose; and minimum for fructose.

### Absorption of Glucose

Glucose has specific transporters, which are transmembrane proteins. Table 9.1 shows a summary of the glucose transporters.

#### Co-transport from Lumen to Intestinal Cell

- This process is mediated by **Sodium Dependent Glucose Transporter-1 (SGLuT-1)** (Fig.9.1). Absorption from intestinal lumen into intestinal cell is by co-transport mechanism (secondary active transport) (see Chapter 2).
- A membrane bound **carrier protein** is involved, which carries glucose, along with sodium. This sodium is later expelled by the **sodium pump** with utilization of energy. So energy is needed indirectly (details in Chapter 2).
- The transporter in intestine is named as **SGLuT-1** and the transporter in the kidney is called **SGLuT-2**. The first one is involved in glucose-galactose malabsorption. The SGLuT-2 is defective in congenital renal glycosuria.
- Clinical application:** Common treatment for diarrhea is **oral rehydration fluid**. It contains glucose and

sodium. Presence of sodium and glucose together in oral rehydration fluid allows absorption of sodium to replenish body sodium chloride levels and glucose to provide energy.

#### Another Uniport System Releases Glucose into Blood

- The same intestinal epithelial cells have a different transport mechanism on the membrane facing capillaries (Fig. 9.2). Intestinal cells release glucose into blood stream by the carrier mechanism called **Glucose Transporter Type 2 (GluT2)**.
- This transporter is not dependent on sodium. It is a **uniport, facilitated diffusion** system.
- Glucose binds to the transporter on one side of the membrane. When fixed, the complex changes configuration. This leads to the closure of the first binding site. At the same time, the binding site is now exposed on the inner side of the membrane, releasing the glucose. The process is called ping-pong mechanism (Fig. 9.2A).
- GluT2 (facilitated transport)** is involved in absorption of glucose from blood stream to cells.

TABLE 9.1: Glucose transporters		
Transporter	Present in	Properties
GluT1	RBC, brain, kidney, colon, retina, placenta	Glucose uptake in most of cells
GluT2	Serosal surface of intestinal cells, liver, beta cells of pancreas	Low affinity; glucose uptake in liver; glucose sensor in beta cells
GluT3	Neurons, brain	High affinity; glucose into brain cells
GluT4	Skeletal, heart muscle, adipose tissue	Insulin-mediated glucose uptake
GluT5	Small intestine, testis, sperms, kidney	Fructose transporter; poor ability to transport glucose
GluT7	Liver endoplasmic reticulum	Glucose from ER to cytoplasm
SGLuT	Intestine, kidney	Cotransport; from lumen into cell

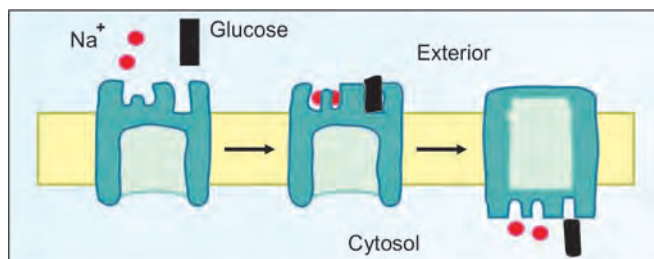


Fig. 9.1: SGLuT. Sodium and glucose co-transport system at luminal side; sodium is then pumped out

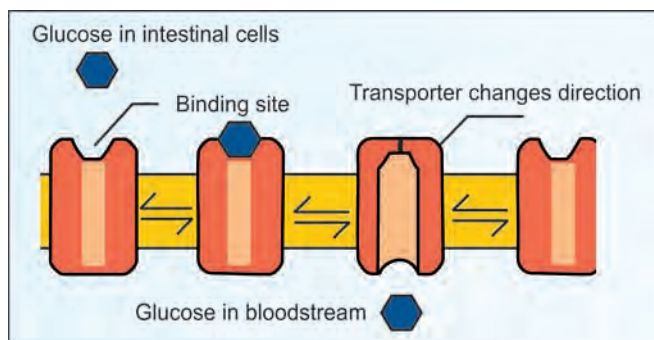


Fig. 9.2: Glucose absorption (GluT2)

Glut2 is present in intestinal epithelial cells, liver cells, beta cells of pancreas and kidney.

- v. Since GluT2 has a high  $K_m$  for glucose, its presence in beta cells is ideally suited for sensing a high glucose level and releasing insulin (see Chapter 24). So, this mechanism enables the pancreas to **monitor the glucose level** and adjust the rate of insulin secretion.

### Glucose Transporter 4

- i. GluT4 is the major glucose transporter in **skeletal muscle and adipose tissue** (Fig. 9.3).
- ii. GluT4 is under the control of **insulin**. But other glucose transporters are not under the control of insulin.
- iii. **Clinical application:** Insulin promotes the translocation of intracellular GluT4 molecules to the cell surface and thus increases glucose uptake. In Type 2 **diabetes mellitus** (see Chapter 24), membrane GluT4 is reduced, leading to insulin resistance in muscle and fat cells. In diabetes, entry of glucose into muscle is only half of normal cells.

The glucose transporters are facilitative transporters that carry hexose sugars across the membrane without requiring energy. They comprise a family of at least 14 members. The most well-characterized members of the family are **GLUT1, GLUT2, GLUT3, GLUT4 and GLUT5**, which are described previously. The transporters belong to a family of

proteins called the **solute carriers**. Thus, the GLUT1 gene symbol is **SLC2A1**, GLUT2 is **SLC2A2**, GLUT3 is **SLC2A3**, GLUT4 is **SLC2A4** and GLUT5 is **SLC2A5**. Although GLUT2, -5, -7, 8, -9, -11, and -12 can all transport fructose, GLUT5 is the only transporter that exclusively transports fructose. Recent evidence has shown that the cell surface receptor for the human T cell leukemia virus (HTLV) is the ubiquitous GLUT1.

### Absorption of Other Monosaccharides

Glucose and galactose are absorbed by the same transporter, SGLuT. It is an energy dependent process, against a concentration gradient, and therefore absorption is almost complete from the intestine. Other monosaccharides are absorbed by carrier mediated facilitated transport. Therefore, absorption is not complete, and the remaining molecules in the intestine will be fermented by bacteria.

## GLUCOSE METABOLISM

Abbate Spallanzani (1768) showed that living tissues take up oxygen and give off carbon dioxide. In 1860, Louis Pasteur demonstrated the fermentation process of glucose to alcohol by yeast. Fick (1882) indicated that chemical energy in muscle is converted to contraction of muscle. Gad (1893) found out that lactic acid is formed during muscle contraction. In 1902, Sir Walter Fletcher established that this lactic acid is derived from glycogen. In 1914, Gustav George Embden (1874–1933) studied the lactic acid formation from pyruvate. In 1919, Otto Fritz Meyerhof (1884–1951) enunciated most of the steps of the glycolytic pathway (Nobel prize, 1922). Hexokinase enzyme was first identified by von Euler Chelpin in 1915 (Nobel prize, 1929). Other enzymes in the glycolytic pathway were then identified rapidly; pyruvate decarboxylase by Neuberg in 1911, phosphofructokinase by Sir Arthur Harden in 1920 (Nobel prize, 1929); phosphohexose isomerase by Lohmann in 1933; pyruvate kinase by Parnas in 1934; enolase by Meyerhof in 1935; phosphoglucomutase by Leloir in 1938 (Nobel prize, 1970); glyceraldehyde phosphate dehydrogenase by Warburg in 1939; phosphoglyceromutase by Sutherland in 1942 (Nobel prize, 1971). Between 1935 and 1943, all enzymes of glycolytic pathway were crystallized and characterized by Warburg. He was awarded Nobel prize in 1931 for his earlier work on cellular respiration. He was awarded Nobel prize for a second time in 1944 for his contributions in glycolysis; but Hitler did not permit him to receive it! Parnas was murdered by Stalinistic regime.

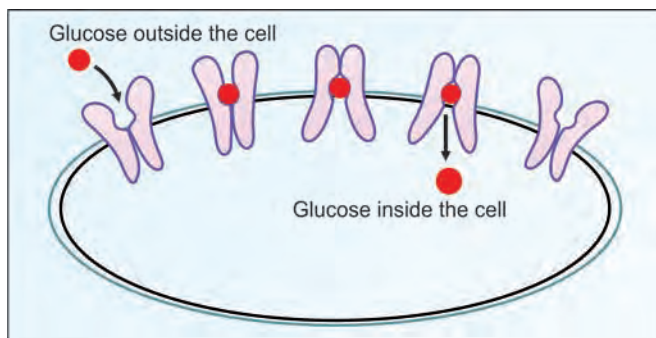


Fig. 9.3: GluT-Glucose transport in cells



Lazzaro  
Spallanzani  
1729–1799



Louis  
Pasteur  
1822–1895



Arthur Harden  
NP 1929  
1865–1940



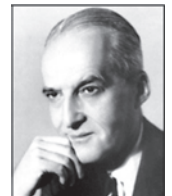
von Euler-  
Chelpin  
NP 1929  
1873–1964



Otto Warburg  
NP 1931  
1883–1970



Karl Lohmann  
1898–1978



Luis Leloir  
NP 1970  
1906–1987

## Clinical Importance of Glucose

1. Glucose is the preferred source of energy for most of the body tissues. Brain cells derive the energy mainly from glucose.
2. When the glucose metabolism is deranged, life-threatening conditions may occur. A minimum amount of glucose is always required for normal functioning.
3. **Normal fasting plasma glucose level is 70 to 110 mg/dL.** After a heavy carbohydrate meal, in a normal person, this level is below 150 mg/dL.

## GLYCOLYSIS (EMBDEN-MEYERHOF-PARNAS PATHWAY)

**Definition:** In glycolytic pathway glucose is converted to **pyruvate** (aerobic condition) or **lactate** (anaerobic condition), along with production of a small quantity of energy. Glycolysis is derived from the Greek words, glykys = sweet; and lysis = splitting.

**Site of reactions:** All the reaction steps take place in the cytoplasm.

## Significance of Glycolysis Pathway

1. It is the only pathway that is taking place in all the cells of the body.
2. Glycolysis is the only source of energy in erythrocytes.
3. In strenuous exercise, when muscle tissue lacks enough oxygen, **anaerobic glycolysis forms the major source of energy for muscles.**
4. The glycolytic pathway may be considered as the preliminary step before complete oxidation.
5. The glycolytic pathway provides carbon skeletons for synthesis of non-essential amino acids as well as glycerol part of fat.
6. Most of the reactions of the glycolytic pathway are reversible, which are also used for gluconeogenesis. A summary is shown in Figure 9.4.

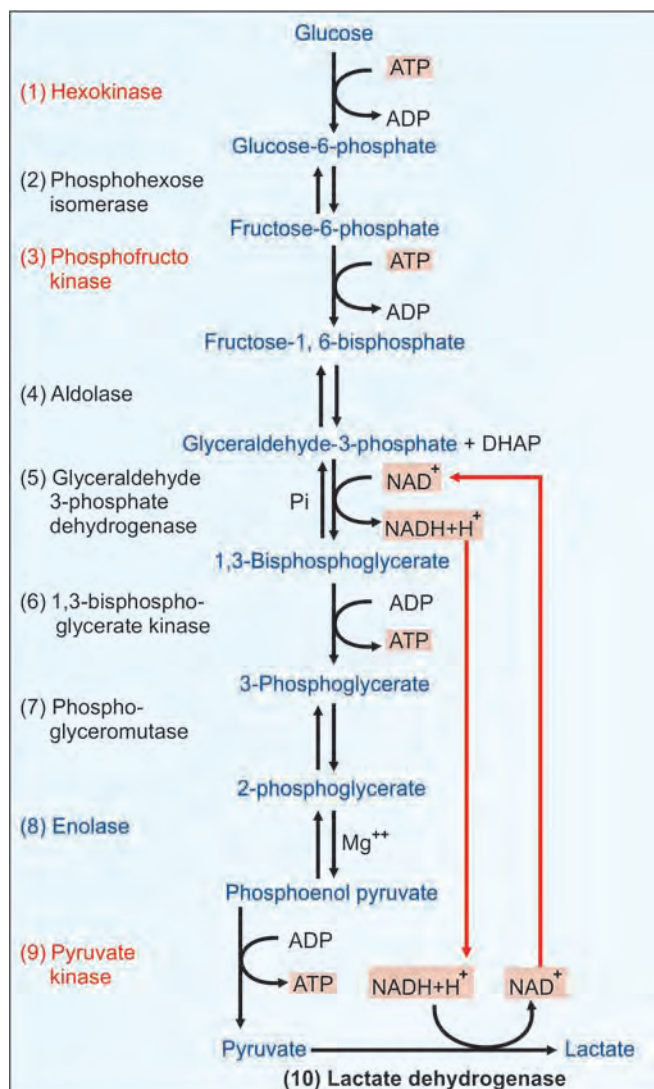
## Glucose Entry into Cells

Glucose transporter-4 (**Glut4**) transports glucose from the extracellular fluid to muscle cells and adipocytes (Table 9.1). This translocase is under the influence of **insulin**. In diabetes mellitus, insulin deficiency hinders the entry of glucose into the peripheral cells. But **Glut2** is the transporter in liver cells; it is not under the control of insulin.

## Steps of Glycolytic Pathway

### Step 1 of Glycolysis

- i. Glucose is phosphorylated to glucose-6-phosphate (Fig. 9.5).
- ii. The enzyme is **Hexokinase** (HK), which splits the ATP into ADP, and the Pi is added on to the glucose. The energy released by the hydrolysis of ATP is utilized for the forward reaction.
- iii. Hexokinase is a **key glycolytic enzyme**. The kinase reaction is **irreversible**. But this irreversibility



**Fig. 9.4:** Summary of glycolysis (Embden-Meyerhof - Parnas pathway). Steps 1, 3 and 9 are key enzymes; these reactions are irreversible. Steps 6 and 9 produce energy. Steps 5 and 10 are coupled for regeneration of  $\text{NAD}^+$



is circumvented by another enzyme glucose-6-phosphatase (see gluconeogenesis).

- iv. Hexokinase and glucokinase may be considered as iso-enzymes; their properties are compared in Table 9.2. Glucokinase is under the influence of insulin; but hexokinase is not. Hexokinase is present in most tissues. Glucokinase with a high  $K_m$  for glucose is

present in liver and beta cells. Glucokinase is induced by insulin.

- v. The metabolic fates of Glucose-6-phosphate are shown in Figure 9.6. The phosphorylation of glucose traps it within the cells. Once phosphorylated, glucose-6-phosphate is trapped within the cell and has to be metabolized.



Otto Meyerhof  
NP 1922  
1884–1951



Gustav Georg  
Embden  
1874–1933



Jakub Parnas  
1884–1949

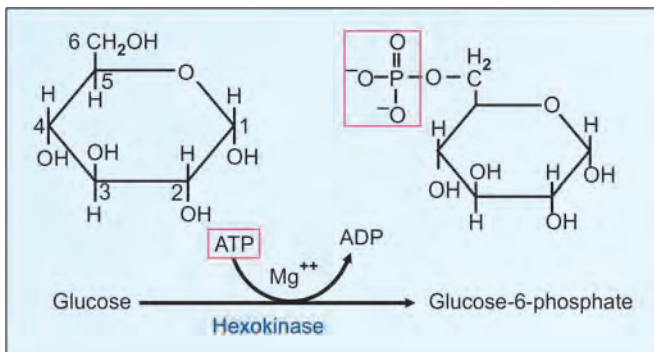


Fig. 9.5: Step 1 of glycolysis; irreversible step

TABLE 9.2: Comparison of hexokinase and glucokinase

	Hexokinase	Glucokinase
Occurrence	In all tissues	Only in liver
$K_m$ value	$10^{-2}$ mmol/L	20 mmol/L
Affinity to substrate	High	Low
Specificity	Acts on glucose, fructose and mannose	Acts only on glucose
Induction	Not induced	Induced by insulin and glucose
Function	Even when blood sugar level is low, glucose is utilized by body cells	Acts only when blood glucose level is more than 100 mg/dL; then glucose is taken up by liver cells for glycogen synthesis

### Step 2 of Glycolysis

Glucose-6-phosphate is isomerized to fructose-6-phosphate by phosphohexose **isomerase**. This is readily reversible.

This isomerisation of aldose to ketose involves the opening of the glucopyranose ring of glucose-6-phosphate to a linear structure which then changes to the furanose ring structure of fructose-6-phosphate.

### Step 3 of Glycolysis

- Fructose-6-phosphate is further phosphorylated to fructose-1,6-bisphosphate (Fig. 9.7 and Box. 9.1). The enzyme is **phosphofruktokinase**.
- Phosphofruktokinase (PFK) is the rate limiting enzyme of glycolysis. It is an allosterically regulated enzyme. The enzyme catalyzes the second phosphorylation step of glycolysis using a second molecule of ATP. PFK is an allosteric, inducible, regulatory enzyme. It is an important **key enzyme** of this pathway.

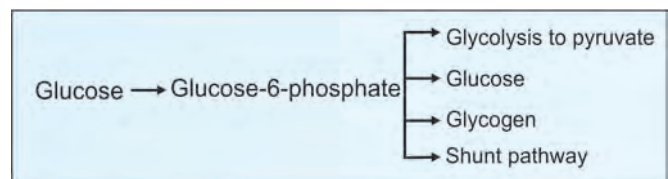


Fig. 9.6: Fate of glucose-6-phosphate

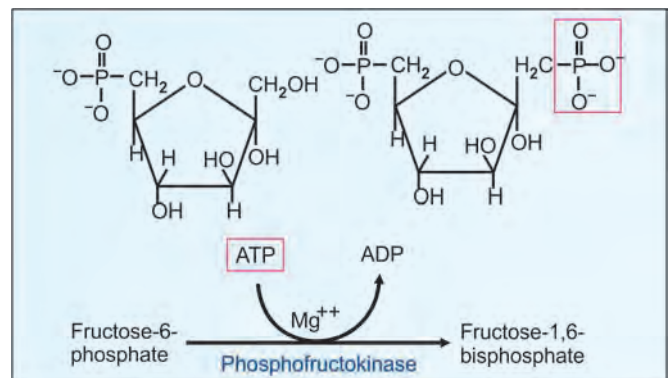


Fig. 9.7: Step 3 of glycolysis; irreversible step

This is again an activation process, and the energy is derived from ATP. This reaction is an **irreversible** step in glycolysis. However during gluconeogenesis, this difficulty is circumvented by fructose-1,6-bisphosphatase.

- iii. The steps 1,2 and 3 together are called as the **preparatory phase**.

#### Step 4 of Glycolysis

The 6 carbon fructose-1,6-bisphosphate is cleaved into two 3 carbon units; one glyceraldehyde-3-phosphate and another molecule of dihydroxy acetone phosphate (DHAP) (Fig. 9.8). Since the backward reaction is an aldol condensation, the enzyme is called **aldolase**. This reaction is reversible.

#### Step 4-A of Glycolysis

Dihydroxyacetone phosphate is isomerized to glyceraldehyde-3-phosphate by the enzyme phosphotriose **isomerase**. Thus net result is that glucose is now cleaved into 2 molecules of glyceraldehyde-3-phosphate (Fig. 9.9). The steps 4 and 4-A are together called the **Splitting Phase**.

Glycerol portion of the neutral fat can enter into glycolytic or gluconeogenic pathways at this point. Similarly for neutral fat synthesis, glycerol is required which can be derived from glucose through DHAP.

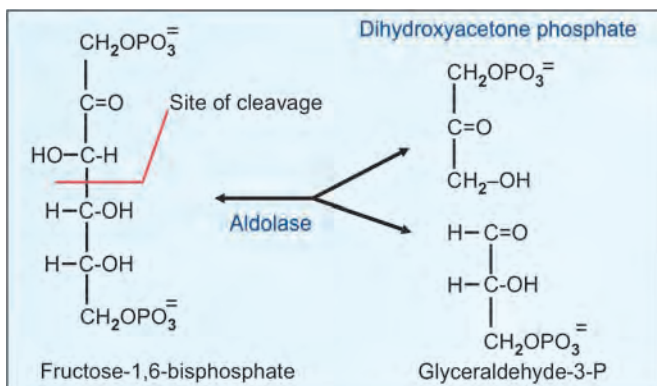


Fig. 9.8: Step 4 of glycolysis; reversible

#### Box. 9.1: Diphosphate and bisphosphate are different

When two phosphate groups are linked together and then attached to a parent compound, it is called diphosphate, e.g. adenosine-di-phosphate (see Fig. 5.3).

But when phosphoric acid groups are present at two different sites of the compound, it is named as bisphosphate, e.g. fructose-1,6-bisphosphate (Fig. 9.7).

The triose phosphate isomerase (TPI) enzyme forms an enzyme bound intermediate, an enediol, which can be converted to methyl glyoxal, a glycating agent. Under normal conditions, the labile intermediate is trapped at the active site and is released only when the isomerization is complete. When there is hyperglycemia, the reactive intermediates may be released forming methyl glyoxal which acts as a glycating agent, leading to formation of Advanced Glycation End Products or AGE (see chapter 24).

#### Step 5 of Glycolysis

Glyceraldehyde-3-phosphate is dehydrogenated and simultaneously phosphorylated to 1,3-bisphosphoglycerate (1,3-BPG) with the help of  $\text{NAD}^+$  (Fig. 9.10). The enzyme is glyceraldehyde-3-phosphate dehydrogenase. The product contains a high energy bond. This is a reversible reaction.

The oxidation of the aldehyde is an exergonic reaction that drives the synthesis of the high energy compound, 1,3-bisphosphoglycerate with high phosphate group transfer potential. The enzyme has a cysteinyl SH group at the active centre and is inhibited by iodoacetate. During this reaction,  $\text{NAD}^+$  is reduced to  $\text{NADH}$ .

#### Step 6 of Glycolysis

- The energy of 1,3-BPG is trapped to synthesize one ATP molecule with the help of **bisphosphoglycerate kinase** (Fig. 9.11).
- This is an example of **substrate level phosphorylation**, where energy is trapped directly from the substrate, without the help of the complicated electron transport chain reactions.

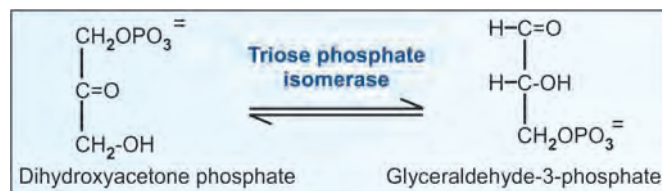


Fig. 9.9: Step 4-A; isomerization; reversible

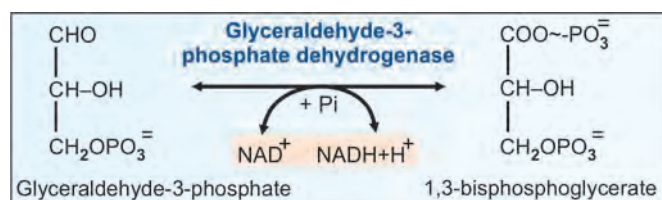


Fig. 9.10: Step 5 of glycolysis. Reversible step.  $\text{NADH}$  generating step



- iii. When energy is trapped by oxidation of reducing equivalents such as NADH, it is called **oxidative phosphorylation**. Step 6 is reversible.
- iv. Arsenate inhibits this reaction since it interferes with the incorporation of the inorganic phosphate into 1,3-BPG. But the oxidation occurs and 3-phosphoglycerate is formed which can undergo further reactions of glycolysis, but ATP is not formed in this step.

### Step 7 of Glycolysis

3-phosphoglycerate is isomerized to 2-phosphoglycerate by shifting the phosphate group from 3rd to 2nd carbon atom (Fig. 9.12). The enzyme is **phosphoglyceromutase**. This is a readily reversible reaction.

### Step 8 of Glycolysis

- i. 2-phosphoglycerate is converted to phosphoenol pyruvate by the enzyme **enolase**. One water molecule is removed (Fig. 9.12).
- ii. A **high energy phosphate bond** is produced. The reaction is reversible.
- iii. Enolase requires  $Mg^{++}$ , and by removing magnesium ions, **fluoride** will irreversibly inhibit this enzyme. Thus, fluoride will stop the whole glycolysis. So when collecting blood for sugar estimation, fluoride is added to blood. If not, glucose is metabolized by the blood cells, so that lower blood sugar values are obtained.

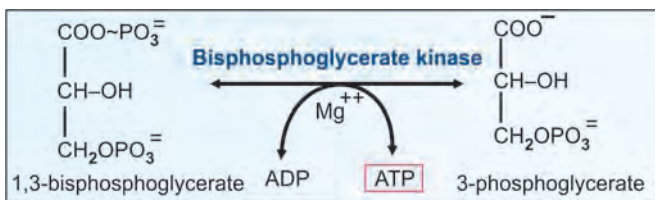


Fig. 9.11: Step 6 of glycolysis. Reversible reaction. ATP generation step

### Step 9 of Glycolysis

During the reaction, PEP is first converted to the enol intermediate and then to keto pyruvate, the stable form.

- i. Phosphoenol pyruvate (PEP) is dephosphorylated to pyruvate, by **pyruvate kinase**. First PEP is made into a transient intermediary of enol pyruvate; which is spontaneously isomerized into keto pyruvate, the stable form of pyruvate.
- ii. One mole of ATP is generated during this reaction. This is again an example of **substrate level phosphorylation** (Fig. 9.13).
- iii. The pyruvate kinase is a **key glycolytic enzyme**. This step is **irreversible**. The reversal, however, can be brought about in the body with the help of two enzymes (pyruvate carboxylase and phosphoenol pyruvate carboxy kinase) and hydrolysis of 2 ATP molecules (see gluconeogenesis).

### Step 10 of Glycolysis

In anaerobic condition, pyruvate is reduced to lactate by lactate dehydrogenase (LDH) (Fig. 9.14). (Greek; an=not; aer=air; bios=life). LDH has 5 iso-enzymes. A summary of glycolysis is shown in Figure 9.4.

In aerobic conditions, the pyruvate enters the citric acid cycle for complete oxidation. The end product of anaerobic glycolysis is lactate which enters the Cori's cycle.

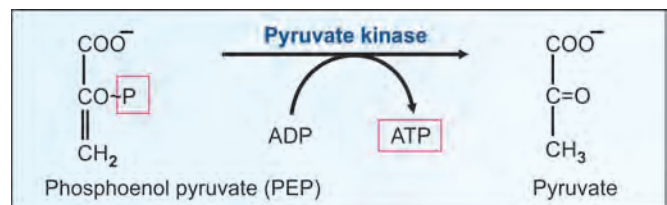


Fig. 9.13: Step 9. ATP production (irreversible)

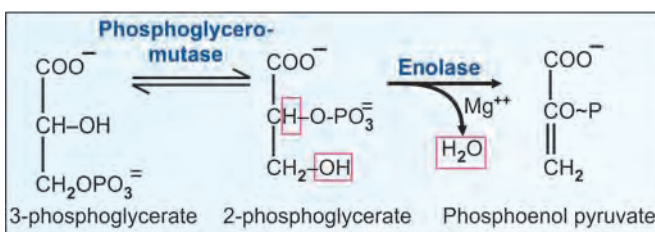


Fig. 9.12: Steps 7 and 8 of glycolysis

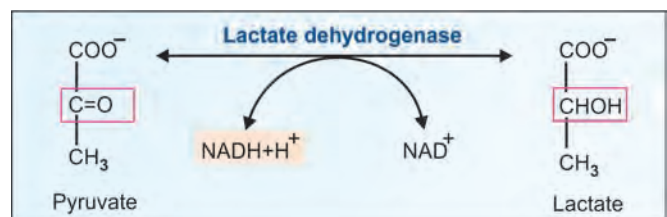


Fig. 9.14: Step 10; LDH reaction; reversible

## Significance of Lactate Production Steps 5 and 10 are Coupled

In the 5th step, for each molecule of glucose entering in the pathway, two molecules of  $\text{NAD}^+$  are reduced to NADH. The availability of co-enzymes inside a cell is limited. Therefore, this step becomes a bottleneck in the whole reaction sequence.

For smooth operation of the pathway, the NADH is to be reconverted to  $\text{NAD}^+$ . This can be done by oxidative phosphorylation. However, during exercise, there is lack of oxygen. So, this reversion is not possible. Therefore, the cell has to couple some other reaction in which  $\text{NAD}^+$  is regenerated in the cytoplasm itself. Hence pyruvate is reduced to lactate; the  $\text{NAD}^+$  thus generated is reutilized for uninterrupted operation of the 5th step (Fig. 9.15).

In RBCs, there are no mitochondria. Hence RBCs derive energy only through glycolysis, where the end product is lactic acid.

## Energy Yield from Glycolysis

- During **anaerobic** (oxygen deficient) condition, when one molecule of glucose is converted to 2 molecules of lactate, there is a net yield of 2 molecules of ATP.
- Four molecules of ATP are synthesized by the 2 substrate level phosphorylations (steps 6 and 9). But 2 molecules of ATP are used in the steps 1 and 3, hence the **net yield is only 2 ATP** (Table 9.4).
- The whole reaction is summarized as  

$$\text{Glucose} + 2 \text{ Pi} + 2 \text{ ADP} \rightarrow 2 \text{ Lactate} + 2 \text{ ATP}$$
- But when **oxygen is in plenty**, the two NADH molecules, generated in the glyceraldehyde-3-

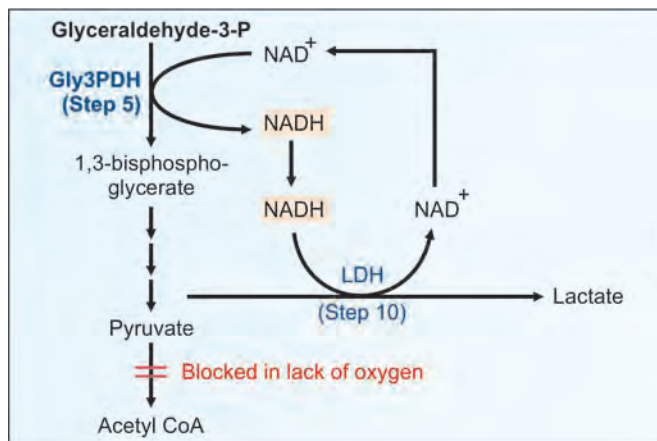


Fig. 9.15: Lactate formation is necessary for reversion of NADH to  $\text{NAD}^+$  during anaerobiasis

phosphate dehydrogenase reaction (step 5), can enter the mitochondrial electron transport chain for complete oxidation (see Chapter 19). As each NADH provides 2.5 ATPs, this reaction generates  $2.5 \times 2 = 5$  ATPs. Thus when oxygen is available, the net gain of energy from the glycolysis pathway is **7 ATPs** (Table 9.5).

- Hence the ATP yield from glycolysis is different in anaerobic and aerobic conditions (compare Tables 9.4 and 9.5).
- In aerobic conditions, pyruvate is converted to acetyl CoA which enters the TCA cycle for complete oxidation. Complete oxidation of glucose through glycolysis plus citric acid cycle will yield a **net 32 ATPs** (Table 9.6).

**Note:** Previously calculations were made assuming that NADH produces 3 ATPs and FADH generates 2 ATPs. This will amount to a net generation of 38 ATP per glucose molecule. Recent experiments show that these old values are wrong, and net generation is only 32 ATPs.

## Regulation of Glycolysis

The regulation is summarized in Figure 9.16. The regulatory enzymes or key enzymes of glycolysis are:

- Hexokinase, step 1 (glucokinase, in liver)
- Phosphofructokinase, step 3 (Table 9.3)
- Pyruvate kinase, step 9.

## Factors Regulating Glycolysis

- Hexokinase** having a high affinity for glucose will phosphorylate glucose even at low glucose

### Box 9.2: Chicken is white, but duck is red!!

Actively contracting muscles that rapidly consume ATP can also regenerate ATP entirely by anaerobic glycolysis. Fast twitch white muscle fibers have very few mitochondria and predominate in muscles capable of short bursts of activity (sprints). Slow twitch red muscle fibers rich in mitochondria are found in muscles that contract slowly and steadily (distance runners). Chicken flies only short bursts and has white fibers. Ducks on the other hand are migratory and have red fibers suitable for sustained activity.

TABLE 9.3: Regulatory enzymes of glycolysis

Enzyme	Activation	Inhibition
HK		G-6-P
GK	Insulin	Glucagon
PK	Insulin, F1,6-BP	Glucagon, ATP, cyclicAMP
PFK	Insulin, AMP, F-6-P, F-2,6-BP	Glucagon, ATP, citrate, low pH, cAMP

concentrations to provide energy to tissues that depend on glycolysis for energy needs, e.g. brain and RBCs. However, glucose-6-phosphate has a feedback inhibitory effect on the enzyme. Glucokinase with a low affinity and high  $K_m$  for glucose is present only in tissues where the phosphorylation has to take place when glucose is available in plenty. In the liver glucokinase phosphorylates glucose which can be used for glycogen synthesis. In the beta cells of pancreas, the glucokinase phosphorylates glucose when the intracellular concentration is sufficiently high so that ATP is produced within the cell which triggers the events leading to release of insulin (see Chapter 24). Insulin also induces glucokinase.

2. **Phosphofructokinase (PFK)** (step 3) is the most important **rate-limiting** enzyme for glycolysis pathway. **ATP** and **citrate** are the most important allosteric inhibitors. AMP acts as an allosteric activator (Fig. 9.16).
3. **Fructose-2,6-bisphosphate (F-2,6-BP)** increases the activity of phosphofructokinase. F-2,6-BP is formed from fructose-6-phosphate by the action of an enzyme called PFK-2. (It is different

from the PFK). The activities of both the enzymes (PFK2 and Fructose-2,6-bisphosphatase) are reciprocally regulated. When glucose supply is in plenty, PFK-2 is dephosphorylated and activated; so F-2,6-BP concentration increases; this in turn, activates PFK. Thus glycolysis is favored (Fig. 9.17). The two enzyme activities are present on the same polypeptide chain, a tandem enzyme. The activities of the two enzymes (PFK2 and F-2,6-bisphosphatase) are reciprocally regulated. Addition of a phosphate group to the tandem enzyme activates F-2,6-bisphosphatase and inactivates PFK2 leading to a fall in F-2,6-bisphosphate and glycolysis slows down. Dephosphorylation has the opposite effect. An increase in cyclic AMP level in cell phosphorylates the enzymes.

4. **Pyruvate kinase** catalyzes an irreversible step and is a regulatory enzyme of glycolysis. When energy is in plenty in the cell, glycolysis is inhibited. Insulin increases its activity whereas glucagon inhibits (Fig. 9.18). Pyruvate kinase is inactive in the phosphorylated state.
5. **Insulin** favors glycolysis by activating the key glycolytic enzymes.
6. **Glucocorticoids** inhibit glycolysis and favors gluconeogenesis (Tables 9.3 and 9.7).

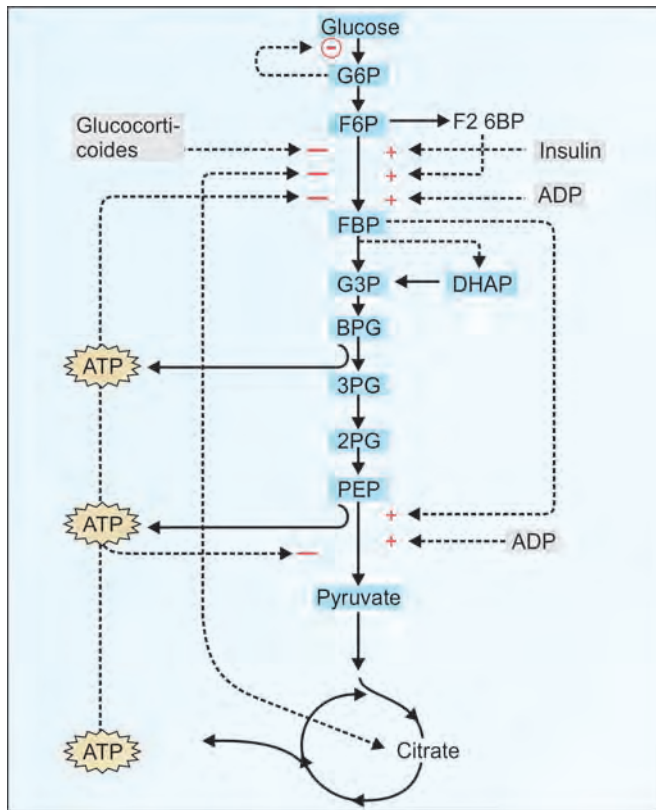


Fig. 9.16: Summary of regulation of glycolysis

**TABLE 9.4:** Energy yield (number of ATP generated) per molecule of glucose in the glycolytic pathway, under anaerobic conditions (Oxygen deficiency)

Step	Enzyme	Source	No. of ATPs gained per glucose mol
1	Hexokinase	-	Minus 1
3	Phosphofructokinase	-	Minus 1
6	1,3-bisphosphoglycerate kinase	ATP	1 × 2 = 2
9	Pyruvate kinase	ATP	1 × 2 = 2
			Total = 4 minus 2 = 2

**TABLE 9.5:** Energy yield (number of ATP generated) per molecule of glucose in the glycolytic pathway, under aerobic conditions (oxygen is available)

Step	Enzyme	Source	No. of ATPs gained per glucose mol
1	Hexokinase	-	Minus 1
3	Phosphofructokinase	-	Minus 1
5	Glyceraldehyde-3-phosphate dehydrogenase	NADH	2.5 × 2 = 5
6	1,3-bisphosphoglycerate kinase	ATP	1 × 2 = 2
9	Pyruvate kinase	ATP	1 × 2 = 2
			Total = 9 minus 2 = 7



## Cori's Cycle or Lactic Acid Cycle

- Definition:** It is a process in which glucose is converted to lactate in the muscle; and in the liver this lactate is re-converted into glucose. (Fig. 9.19).
- In an actively contracting muscle, pyruvate is reduced to lactic acid which may tend to accumulate in the muscle. The muscle cramps, often associated with strenuous muscular exercise, are thought to be due to lactate accumulation.
- To prevent the lactate accumulation, body utilizes Cori's cycle.
- Lactic acid from muscle diffuses into the blood. Lactate then reaches liver, where it is oxidized to pyruvate. Thus it is channeled to gluconeogenesis.

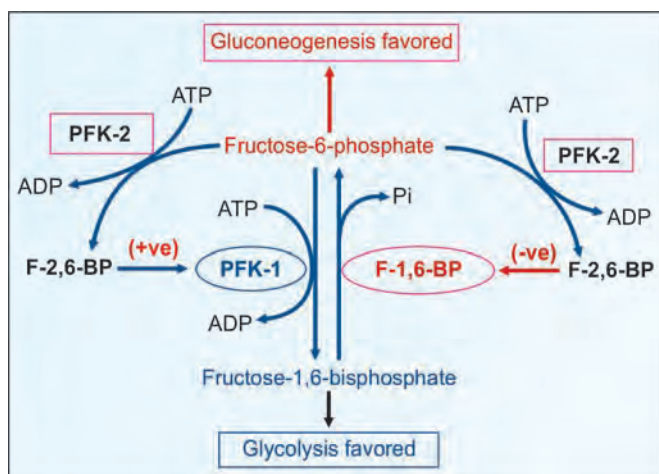


Fig. 9.17: Reciprocal regulation of PFK-2 and fructose-2,6-bisphosphate by phosphorylation

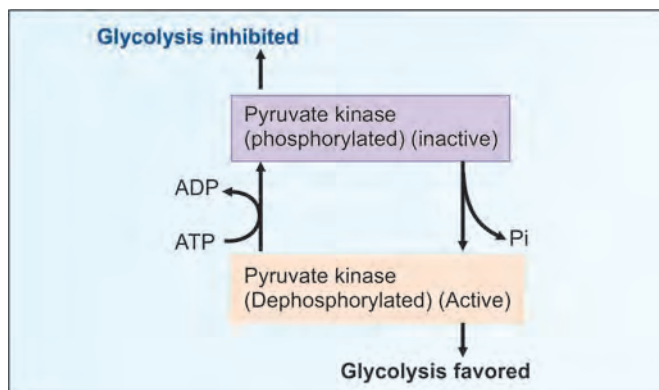


Fig. 9.18: Covalent modification of pyruvate kinase reaction; this is similar to PFK-2

Regenerated glucose can enter into blood and then to muscle. This cycle is called Cori's cycle (Fig. 9.19).

- Significance of the Cori's cycle:** The lactate produced in the muscle is efficiently reutilized by the body. But this is an energy-expensive process. During exercise, lactate production is high, which is utilized by liver to produce glucose. The process needs ATP. The resultant increased oxygen consumption is the explanation for the **oxygen debt** after vigorous exercise.

### Pasteur Effect

Under aerobic conditions, glycolysis is inhibited. This inhibitory effect of oxygen on glycolysis is known as **Pasteur effect**.

### Warburg Hypothesis

Otto Warburg has studied glycolysis in various tissues. According to his studies, **cancer cells** utilize energy from glycolysis and they require less oxygen than their normal counterparts; this is called Warburg hypothesis (1923). Rapidly growing tumor cells produce good quantity of lactic acid, causing high acidity in the local environment. Lactate is used for gluconeogenesis by the liver; however, this needs large amount of energy. This is one of the reasons for **cancer cachexia** (loss of weight).

Inhibition of glycolysis severely depletes ATP in cancer cells, especially in clones of cancer cells with mitochondrial respiration defects, and leads to rapid dephosphorylation of other glycolysis-apoptosis integrating molecule BAD at Ser112, relocalization of BAX to mitochondria, and massive cell death. Inhibition of glycolysis effectively kills colon cancer cells and lymphoma cells in a hypoxic environment in which the cancer cells exhibit high glycolytic activity and decreased

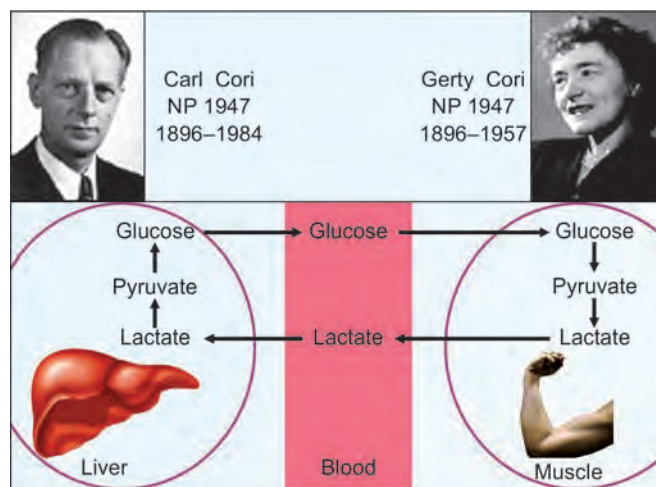


Fig. 9.19: Cori's cycle. Contracting muscle has lack of oxygen. So pyruvate is reduced to lactate. This can be reconverted to glucose in liver by gluconeogenesis. Lactate to pyruvate ratio is normally approximately 25:1

sensitivity to common anticancer agents. Because the Warburg effect and hypoxia are frequently seen in human cancers, these findings may have broad clinical implications. Depletion of ATP by glycolytic inhibition also potently induced apoptosis in multidrug-resistant cells, suggesting that deprivation of cellular energy supply may be an effective way to overcome multidrug resistance.

### Rapaport Leubering Cycle (BPG Shunt)

In the erythrocytes, step 6 of glycolysis is bypassed. Bisphosphoglycerate mutase converts 1,3-bisphosphoglycerate (BPG) to 2,3-BPG. Then BPG-phosphatase removes the phosphate group to form 3-phosphoglycerate (Fig. 9.20).

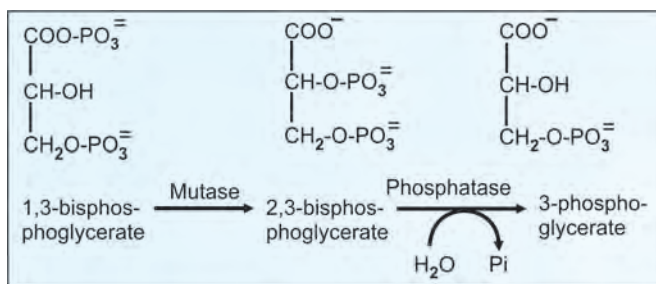
### Significance of BPG

1. 2,3-BPG binds to hemoglobin, and **reduces the affinity towards oxygen**. So, in presence of 2,3-BPG, oxyhemoglobin will unload oxygen more easily in tissues.
2. Under **hypoxic conditions the 2,3-BPG concentration in the RBC increases**, thus favoring the release of oxygen to the tissues even when  $pO_2$  is low.
3. The compensatory increase in 2,3-BPG in high altitudes favors oxygen dissociation. BPG is increased in fetal circulation.
4. In this shunt pathway, **no ATP is generated**. Please compare Figures 9.20 and 9.11.

## METABOLIC FATE OF PYRUVATE

Under aerobic conditions, pyruvate is converted to acetyl CoA which enters the TCA cycle to be oxidised to  $CO_2$ . ATP is generated.

Glycolysis is taking place in cytoplasm. So pyruvate is generated in cytoplasm. This is transported into mitochondria by a **pyruvate transporter**.



**Fig. 9.20:** BPG shunt; step 6 of glycolysis is bypassed in erythrocytes. Compare with Figure 9.11

## Pyruvate Dehydrogenase Complex

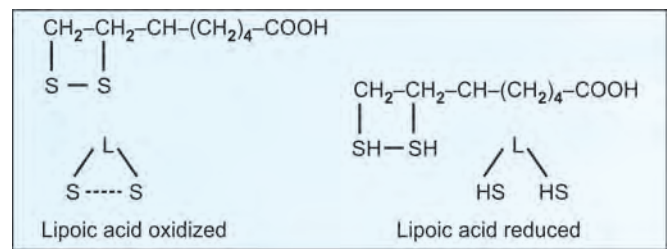
Inside the mitochondria, pyruvate is **oxidatively decarboxylated** to acetyl CoA by pyruvate dehydrogenase (PDH). It is a multi-enzyme complex with 5 co-enzymes and 3 apo-enzymes. The co-enzymes needed are:

1. Thiamine pyrophosphate (TPP)
2. Co-enzyme A (CoA)
3. FAD
4.  $NAD^+$
5. Lipoamide. The lipoic acid, otherwise called thioctic acid has two sulphur atoms and 8 carbon atoms. It can accept or donate hydrogen atoms (Fig. 9.21).
6. The enzyme part of the PDH complex is made up of three component enzymes (Fig. 9.22).
  - A. **Pyruvate dehydrogenase** (Enzyme 1): Catalyzes oxidative decarboxylation. TPP is required for this step. So, **Thiamine**, a B complex group vitamin is essential for utilization of pyruvate. An enzyme bound hydroxyl ethyl TPP is formed.
  - B. **Dihydrolipoyl transacetylase** (Enzyme 2): Then, hydroxyethyl group is oxidized to form an acetyl group and then transferred from TPP to lipoamide to form acetyl lipoamide.
  - C. **Dihydrolipoyl dehydrogenase** (Enzyme 3): The last step is the oxidation of lipoamide. At the end of the reaction the cofactors, namely TPP, lipoamide and FAD are regenerated (Fig. 9.22).

A similar enzyme complex brings about the oxidative decarboxylation of alpha keto glutarate to succinyl CoA in the TCA cycle (see Chapter 19).

**Regulation:** PDH is subject to regulation by allosteric mechanisms and covalent modification. Allosteric inhibitors are the products acetyl CoA and NADH. PDH or E1 is covalently modified by phosphorylation by PDH kinase and dephosphorylated by PDH phosphatase. The dephosphorylated form of the enzyme is active. Hence, activators of PDH kinase like ATP, NADH and acetyl CoA inhibit PDH reaction. PDH phosphatase is activated by  $Ca^{++}$ ,  $Mg^{++}$  and AMP; this will increase the rate of PDH reaction whereas PDH kinase is inhibited by  $Ca^{++}$ . When there is adequate ATP and acetyl CoA, the enzyme is inhibited.

The PDH complex is comprised of multiple copies of the 3 enzymes: pyruvate dehydrogenase (20–30 copies), dihydrolipoyltransacetylase



**Fig. 9.21:** Structure of lipoic acid



(60 copies) and dihydrolipoyl dehydrogenase (6 copies). Three of the coenzymes of the complex are tightly bound to enzymes of the complex (TPP, lipoic acid and FAD<sup>+</sup>) and two are employed as carriers of the products of PDH complex activity (CoA and NAD<sup>+</sup>).

## Importance of Pyruvate Dehydrogenase

1. **Completely irreversible process.** There is no pathway available in the body to circumvent this step. Glucose through this step is converted to acetyl CoA from which fatty acids can be synthesized.
2. But the backward reaction is not possible, and so **there is no net synthesis of glucose from fat.**
3. Pyruvate may be channeled back to glucose through gluconeogenesis. But oxidative decarboxylation of pyruvate to acetyl CoA is irreversible. Hence, **PDH reaction is the committed step** towards complete oxidation of glucose.
4. **Energetics:** The NADH generated in this reaction, enters the electron transport chain to produce 2.5 ATP molecules (see footnote of Table 9.6).

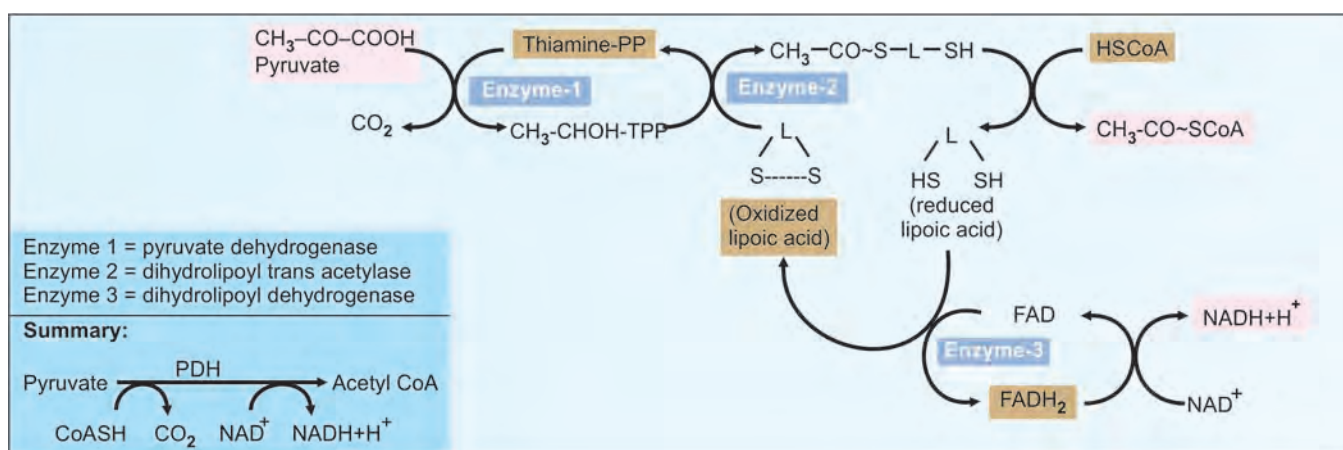


Fig. 9.22: Details of pyruvate dehydrogenase reaction. See summary in the inset

**TABLE 9.6:** Energy yield (number of ATP generated) per molecule of glucose when it is completely oxidized through glycolysis plus citric acid cycle, under aerobic conditions

Pathway	Step	Enzyme	Source	Method of ATP formation	No of ATPs gained per glucose (new calculation)	No. of ATPs as per old calculation
Glycolysis	1	Hexokinase	-		Minus 1	Minus 1
Do	3	Phosphofructokinase	-		Minus 1	Minus 1
Do	5	Glyceraldehyde-3-P DH	NADH	Respiratory chain	2.5 × 2 = 5	3 × 2 = 6
Do	6	1,3-BPG kinase	ATP	Substrate level	1 × 2 = 2	1 × 2 = 2
Do	9	Pyruvate kinase	ATP	Substrate level	1 × 2 = 2	1 × 2 = 2
Pyruvate to acetyl CoA	-	Pyruvate dehydrogenase	NADH	Respiratory chain	2.5 × 2 = 5	3 × 2 = 6
TCA cycle	3	Isocitrate DH	NADH	Respiratory chain	2.5 × 2 = 5	3 × 2 = 6
Do	4	alpha keto glutarate DH	NADH	Respiratory chain	2.5 × 2 = 5	3 × 2 = 6
Do	5	Succinate thiokinase	GTP	Substrate level	1 × 2 = 2	1 × 2 = 2
Do	6	Succinate DH	FADH <sub>2</sub>	Respiratory chain	1.5 × 2 = 3	2 × 2 = 4
Do	8	Malate DH	NADH	Respiratory chain	2.5 × 2 = 5	3 × 2 = 6
Net generation in glycolytic pathway					9 minus 2 = 7	10 minus 2 = 8
Generation in pyruvate dehydrogenation					= 5	= 6
Generation in citric acid cycle					= 20	= 24
Net generation of ATP from one glucose mol					= 32	= 38

Note: Previously, calculations were made assuming that in the electron transport chain, NADH produces 3 ATPs and FADH<sub>2</sub> generates 2 ATPs. This will amount to a net generation of 38 ATP per glucose molecule. Recent experiments show that these old values are wrong. Please also see Chapter 19 for details.

5. Pyruvate dehydrogenase is regulated by **end product inhibition** as well as by **covalent modification**. Phosphorylation of the enzyme by a kinase decreases the activity of the enzyme. Dephosphorylation activates the enzyme. Diseases associated with glycolysis pathway are described in Box 9.3.

## Pyruvate as a Junction Point

Pyruvate occupies an important junction between various metabolic pathways. It may be decarboxylated to **acetyl CoA** which enters the TCA cycle, or may be utilized for fatty acid synthesis. Pyruvate may be carboxylated to **oxaloacetate** which is used for gluconeogenesis. These pathways are summarized in Figure 9.23.

## GLUCONEOGENESIS

### Definition

It is the process by which glucose molecules are produced from non-carbohydrate precursors. These include lactate, glucogenic amino acids, glycerol part of fat and propionyl CoA derived from odd chain fatty acids (Fig. 9.27).

### Site

Gluconeogenesis occurs mainly in the liver, and to a lesser extent in the renal cortex. The pathway is partly mitochondrial and partly cytoplasmic.

#### Box 9.3: Clinical applications of glycolytic enzymes

- Lactic acidosis.** It is seen in hypoxia, shock, pulmonary failure, alcohol abuse (see Chapter 11), and diabetes mellitus (see Chapter 24).
- Deficiency of glycolytic enzymes.** These conditions are rare, out of which **pyruvate kinase** deficiency and **hexokinase** deficiency are comparatively common. Though rare, these deficiency states can lead to hemolytic anemia, because energy depleted RBCs are destroyed. Hexokinase deficient RBCs have a low level of 2,3 BPG and a high affinity for oxygen. On the other hand, a deficiency of pyruvate kinase leads to decreased affinity for oxygen since 2,3 BPG levels are high. Inherited aldolase deficiency also causes hemolysis. In PFK deficiency, muscles are weak.
- Pyruvate dehydrogenase (PDH).** PDH requires thiamine pyrophosphate (TPP); this explains the serious afflictions in **beriberi** due to thiamine deficiency (see Chapter 37). TPP deficiency in alcoholism causes lactate accumulation in tissues. Inherited aldolase deficiency may lead to lactic acidosis.

## Key Gluconeogenic Enzymes

1. Pyruvate carboxylase
2. Phosphoenol pyruvate carboxy kinase
3. Fructose-1-6-bisphosphatase
4. Glucose-6-phosphatase

Gluconeogenesis involves several enzymes of glycolysis, but **it is not a reversal** of glycolysis. The irreversible steps in glycolysis are circumvented by four enzymes which are designated as the key enzymes of gluconeogenesis (Table 9.7).

### Pyruvate Carboxylase Reaction

Pyruvate in the cytoplasm enters the mitochondria. Then, carboxylation of pyruvate to oxaloacetate is catalyzed by a mitochondrial enzyme, pyruvate carboxylase (Fig. 9.24), which needs the co-enzyme **biotin** and energy by ATP hydrolysis.

### Malate Aspartate Shuttle

The previous reaction takes place in mitochondria. So, oxaloacetate is generated inside the mitochondria. This **oxaloacetate has to be**

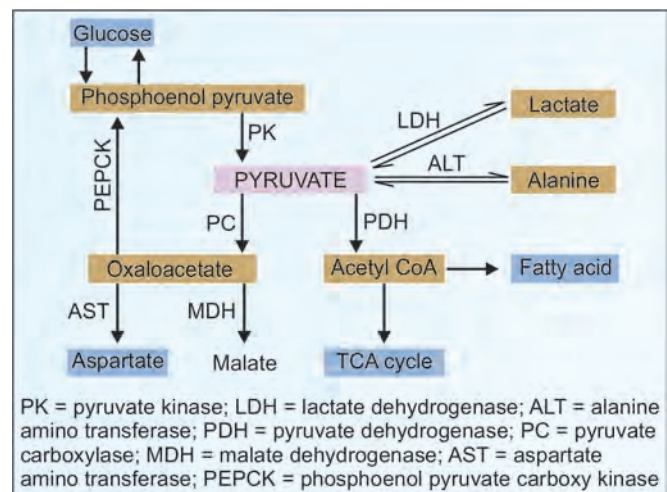


Fig. 9.23: Pyruvate; metabolic junction point

TABLE 9.7: Key enzymes

Irreversible steps in glycolysis	Corresponding key gluconeogenic enzymes
Pyruvate kinase (step 9)	Pyruvate carboxylase; Phosphoenol pyruvate-carboxy kinase
Phosphofructokinase (step 3)	Fructose-1,6- biphosphatase
Hexokinase (step 1)	Glucose-6-phosphatase





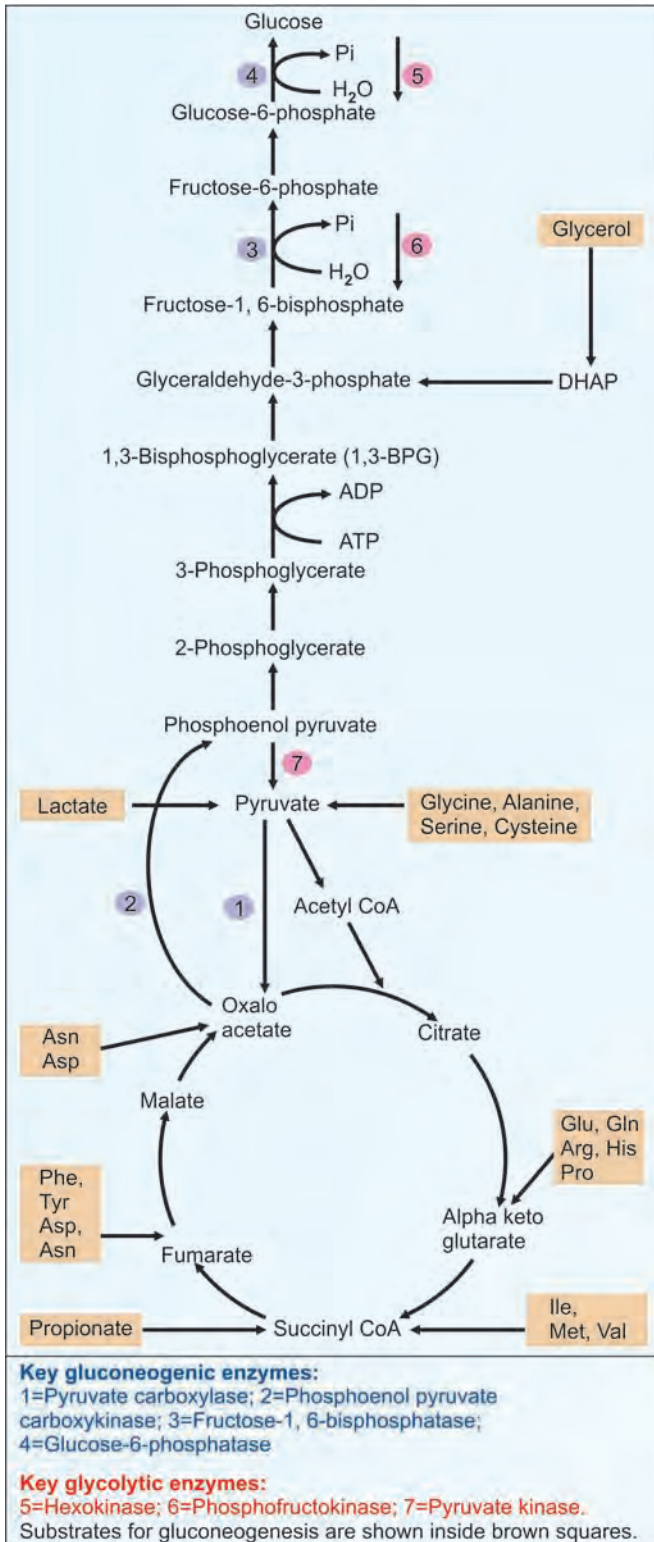
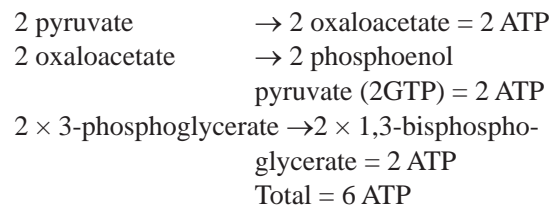


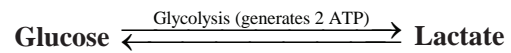
Fig. 9.27: Gluconeogenic pathway

within the first 12–18 hours of fasting. On prolonged starvation, the gluconeogenesis is speeded up and protein catabolism provides the substrates, namely glucogenic amino acids.

- Energy requirement:** The reactions catalyzed by pyruvate carboxylase, phosphoenol pyruvate carboxy kinase and phosphoglycerate kinase require one ATP each; so 3 ATPs are used by 1 pyruvate residue to produce one-half molecule of glucose; or 6 ATPs are required to generate one glucose molecule.



Gluconeogenesis (utilizes 6 ATP)



### Substrates for Gluconeogenesis

Lactate and glucogenic amino acids are the most important substrates for gluconeogenesis.

#### Lactate

The lactate formed in the muscle is transported to the liver. In the liver cell lactate dehydrogenase converts lactate to pyruvate (Fig. 9.28). The pyruvate enters the

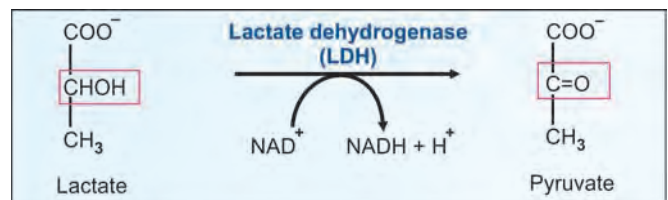


Fig. 9.28: Reversal of step 10 of glycolysis

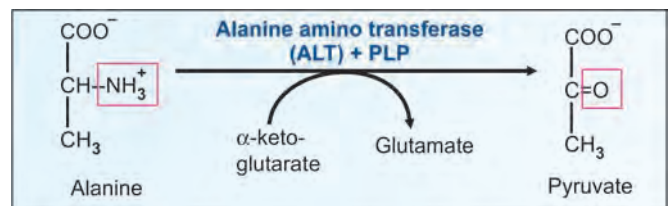


Fig. 9.29: Transamination of alanine



gluconeogenic pathway to form glucose. See also Cori's cycle (Fig. 9.19).

### Glucogenic Amino Acids

- Glucogenic amino acids are shown in Figure 9.27. (Alanine, glutamic acid, aspartic acid, etc.).
- When glucose is not readily available (starvation or diabetes mellitus), the glucogenic amino acids are transaminated to corresponding carbon skeletons. (Fig. 9.27). These then enter the TCA cycle and form oxaloacetate or pyruvate.
- Alanine** released from the muscle is the major substrate for gluconeogenesis (Fig. 9.29). Muscle wastage seen in uncontrolled diabetes mellitus could be explained by this factor.
- During starvation, rate of gluconeogenesis by kidney increases.

### Glucose-Alanine Cycle (Cahill Cycle)

- Alanine is transported to liver, transaminated to pyruvate and converted to glucose. This glucose may again enter the glycolytic pathway to form pyruvate, which in turn, can be transaminated to alanine.
- Glucose-alanine cycle is important in conditions of starvation (Fig. 9.30). Thus net transfer of amino acid (nitrogen) from muscle to liver and corresponding transfer of glucose (energy) from liver to muscle is affected.
- Alanine cycle is intimately related with Cori's cycle (Compare Figs 9.19 and 9.30).

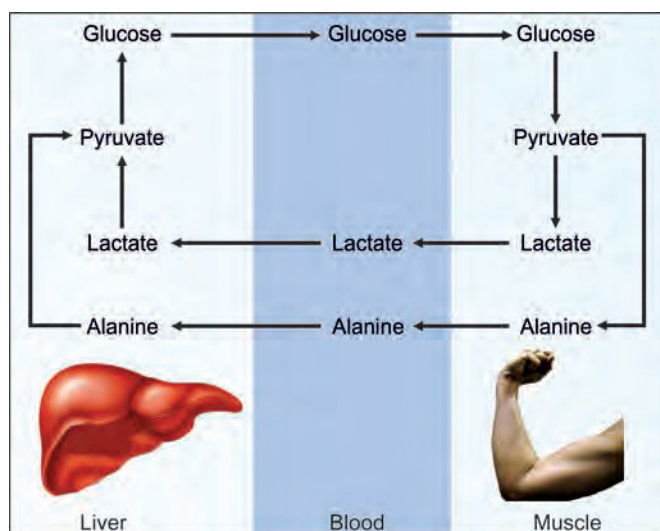


Fig. 9.30: Glucose alanine cycle

### Glycerol

The glycerol part of fat is phosphorylated in the liver cytosol by ATP to glycerol-3-phosphate. It is then oxidized to dihydroxyacetone phosphate by an  $\text{NAD}^+$  dependent dehydrogenase (Fig. 9.31).

### Propionyl CoA

Propionyl CoA is formed from odd chain fatty acids and carbon skeleton of some amino acids. It is converted to succinyl CoA (see Fig. 11.11) and is a minor source for glucose.

**Important:** Even chain fatty acids **cannot** be converted to glucose; **they are not** substrates for gluconeogenesis.

### Regulation of Gluconeogenesis

Gluconeogenesis and glycolysis are reciprocally regulated so that one pathway is relatively inactive when the other is active. The regulatory steps are:

### Pyruvate Carboxylase

It is an allosteric enzyme. **Acetyl CoA** is an activator of pyruvate carboxylase so that generation of oxaloacetate is favored when acetyl CoA level is sufficiently high (Fig. 9.24).

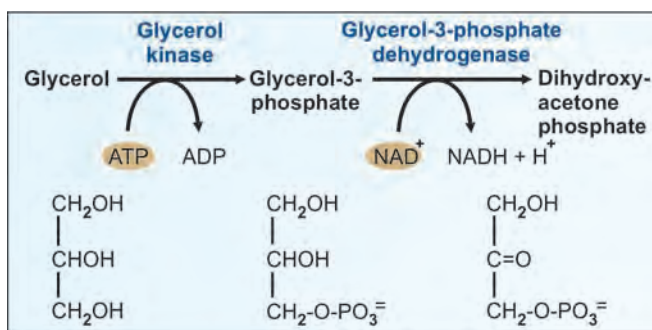


Fig. 9.31: Gluconeogenesis from glycerol

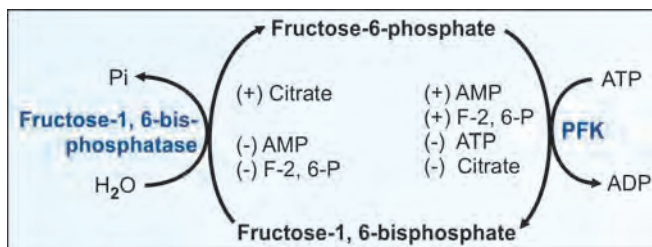


Fig. 9.32: Reciprocal regulation of PFK (glycolytic enzyme) and Fructose-1,6-bisphosphatase (gluconeogenic enzyme)

### Fructose-1,6-bisphosphatase

**Citrate** is an activator while fructose-2,6-bis-phosphate and AMP are inhibitors. All these three effectors have an exactly opposite effect on the phosphofructokinase (PFK) (Fig. 9.32).

### ATP

Gluconeogenesis is enhanced by ATP.

### Hormonal Regulation of Gluconeogenesis

- The hormones **glucagon** and **glucocorticoids** increase gluconeogenesis (Fig. 9.33).
- Glucocorticoids induce the synthesis of hepatic amino transferases thereby providing substrate for gluconeogenesis.
- The high glucagon-insulin ratio also favors induction of synthesis of gluconeogenic enzymes (PEPCK, Fructose-1,6-bisphosphatase and glucose-6-phosphatase).

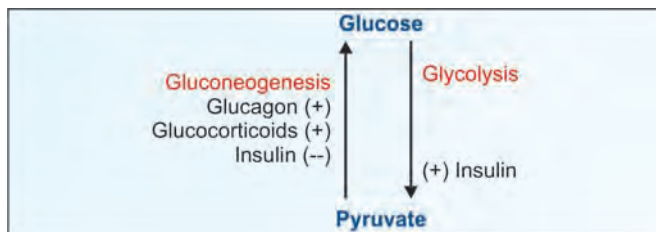


Fig. 9.33: Hormonal regulation of gluconeogenesis

#### Box 9.4: Clinical significance of pyruvate

- Pyruvate carboxylase deficiency.** It is seen as an inborn error of metabolism, where mental retardation is manifested. Its incidence is 1 in 25,000 births. Lactic acidosis is noticed.
- Malignant hyperthermia.** This may occur when halothane is given as an anaesthetic to certain persons. The ryanodine receptor, a calcium-release channel is defective, leading to inappropriate release of calcium from sarcoplasmic reticulum. This results in uncontrolled heat generation, damage of muscle cells, ATP depletion, lactic acidosis and rhabdomyolysis. CPK is markedly elevated. This defect is seen in 1 per 50,000 population.
- Ethanol (Ethyl alcohol).** Inhibits gluconeogenesis. During the metabolism of ethanol the level of cytoplasmic NADH is raised. Thus, the Pyruvate  $\rightarrow$  Malate  $\rightarrow$  Oxaloacetate reactions are reversed. So, 1 excessive ingestion of alcohol results in hypoglycemia. Lactate also accumulates as NADH level is high (see Chapter 11).

- At the same time, synthesis of glycolytic enzymes HK, PFK and PK are depressed.
- Insulin** inhibits the process (Fig. 9.33). A summary of regulatory enzymes of gluconeogenesis is shown in Table 9.8 (compare with Table 9.3). Clinical significance of pyruvate metabolism is shown in Box 9.4.

### GN ratio or DN ratio

During gluconeogenesis proteins are degraded and end-product urea is excreted through urine. The ratio of glucose (dextrose) to urea nitrogen in urine is termed as GN ratio or DN ratio. In such animals, the ratio is 3.65. That means **1 g of nitrogen (from protein) will form 3.65 g of glucose**. Since proteins contain 16% nitrogen; **58% of protein is glucogenic**. GN ratio is enhanced when catabolism is increased, e.g. insulin deficiency, starvation, pyrexia, hyperthyroidism and cancer.

### Clinical Case Study 9.1

A newborn baby had severe abdominal distension, severe abdominal pain, and diarrhea after being fed breast milk. Urine analysis revealed the presence of reducing sugar. What is the possible defect? What is the confirmatory diagnostic test? How can it be treated?

### Clinical Case Study 9.1 Answer

The likely cause is lactose intolerance. Abdominal distension and bowel cramps after intake of milk is due to undigested lactose. This lactose can be ultimately excreted in urine giving a positive urine sugar Benedict's test.

There is absence of lactase enzyme, which digests lactose. This is normally produced by cells lining small intestine. Highest levels of lactase are present shortly after

**TABLE 9.8:** Regulatory enzymes of gluconeogenesis (compare with Table 9.3)

Enzyme	Activation	Inhibition
PC	Cortisol, Glucagon, Adrenalin, Acetyl CoA	Insulin, ADP
PEPCK	do	Insulin
F-1,6-bisphosphatase	do	F-1,6-BP, AMP, F-2,6-BP
G-6-phosphatase	do	Insulin

birth, and this declines with age. Lactose fermentation in the intestine produces large amounts of gas (a mixture of hydrogen, CO<sub>2</sub> and methane) which produces abdominal cramps, bloating and flatulence. Resultant elevated osmotic pressure can produce diarrhea. Symptoms usually appear 30 minutes – 1 hour after consuming milk or milk products.

Confirmatory diagnosis is made by stool acidity test. The stool acidity test is used for infants and young children to measure amount of acid in stool. Undigested lactose creates lactic acid and other fatty acids that can be detected in stool sample. Glucose also may be present in stool.

Gradual introduction of small amounts of milk/milk products may help adaptation in some patients. Lactose-free, lactose-reduced milk, Soy milk and other products may be beneficial. Lactase enzyme or tablets can be administered.

## QUICK LOOK OF CHAPTER 9

1. Digestion of carbohydrates occurs at the mouth by salivary amylase and in the intestine by pancreatic amylase and specific enzymes such as sucrase, maltase, lactase, etc.
2. Deficiency of Lactase results in lactose intolerance.
3. Special Glucose transporters; GluT1, GluT2, GluT3, GluT4, GluT5 and GluT7 perform the function of absorption of glucose in various cells, tissues and organs of the body.
4. The GluT4 has been implicated in Type 2 diabetes mellitus.
5. Glycolysis occurs both in aerobic and anaerobic conditions. Anaerobic glycolysis is the major source of energy for muscles, when the muscle tissue lacks oxygen.
6. Irreversibility of the hexokinase reaction can be circumvented by glucose-6-phosphatase, which is a key enzyme of gluconeogenesis.
7. Phosphofructokinase (PFK) is the regulatory or rate limiting enzyme of glycolysis. It is an allosteric and inducible enzyme. AMP is allosteric activator, while citrate and ATP are allosteric inhibitors.
8. The reaction catalyzed by 1,3-bisphosphoglycerate kinase and pyruvate kinase are examples of substrate level phosphorylation.
9. Energy generating steps of glycolysis are catalysed by the enzymes glyceraldehyde-3-phosphate dehydrogenase; 1,3-bisphosphoglycerate kinase and pyruvate kinase.
10. Cori's cycle ensures efficient reutilization of lactate produced in the muscle.
11. Under anaerobic conditions, glycolysis is inhibited by oxygen. This effect is called Pasteur effect.
12. Energy yield per molecule of glucose in the glycolytic pathway under anaerobic conditions is 2 ATPs.
13. Total energy yield from glycolysis, under aerobic condition is 7 ATP. Total net ATP generation from one glucose molecule is 32.
14. Under anaerobic condition pyruvate is reduced to lactate by lactate dehydrogenase. Under aerobic conditions, it is oxidatively decarboxylated to acetyl CoA by the enzyme complex Pyruvate dehydrogenase (PDH).
15. The components of PDH complex are; pyruvate decarboxylase, dihydrolipoyl transacetylase and dihydrolipoyl dehydrogenase.
16. The PDH enzyme complex requires 5 cofactors for its activity viz. NAD, FAD, TPP, Lipoamide and Co A.
17. The PDH reaction is a totally irreversible reaction. Hence, there is no net synthesis of glucose from fat.
18. Key enzymes of gluconeogenesis are; pyruvate carboxylase, phosphoenol pyruvate carboxykinase, fructose-1,6-bisphosphatase and glucose-6-phosphatase.
19. Major substrates for gluconeogenesis are lactate and glucogenic amino acids.

# CHAPTER 10

## Other Metabolic Pathways of Glucose

### Chapter at a Glance

The reader will be able to answer questions on the following topics:

- Glycogenolysis; degradation of glycogen
- Glycogenesis; glycogen synthesis
- Regulation of glycogen; cyclic AMP
- Glycogen storage diseases
- Hexose monophosphate shunt pathway
- Glucose-6-phosphate dehydrogenase deficiency
- Glucuronic acid pathway
- Essential pentosuria
- Polyol pathway

### GLYCOGEN METABOLISM

Carl Cori and Gerty Cori were awarded Nobel prize in 1947, for their work on glycogen degradation. Based on his work on glycogen synthesis, Luis Leloir (Argentina) was awarded Nobel prize in 1970. Earl Sutherland (Nobel prize, 1971) studied the role of cyclic AMP as the second messenger in glycogenolysis. Glycogen is a homopolysaccharide with glucose units linked in alpha-1, 4 linkages (straight line) and alpha-1, 6 linkages (branching point). Branching makes the molecule more globular and less space-consuming. For details of structure, see Figure 6.23.

### Functions of Glycogen

1. Glycogen is the storage form of carbohydrates in the human body. The major sites of storage are liver and muscle. The major function of **liver glycogen** is to provide glucose during fasting. The glycogen content of liver (10 g/100 g tissue) is more than in the skeletal muscle (1–2 g/100 g). But the total quantity of muscle glycogen is more than liver glycogen because of the larger muscle mass.
2. When blood glucose level lowers, liver glycogen is broken down and helps to maintain blood glucose level. After taking food, blood sugar tends to rise,

which causes glycogen deposition in liver. About 5 hours after taking food, the blood sugar tends to fall. But, glycogen is lyzed to glucose so that the energy needs are met. After about 18 hours fasting, most of the liver glycogen is depleted, when depot fats are hydrolyzed and energy requirement is met by fatty acid oxidation (Fig. 10.1A).

3. The function of muscle glycogen is to act as reserve fuel for muscle contraction.

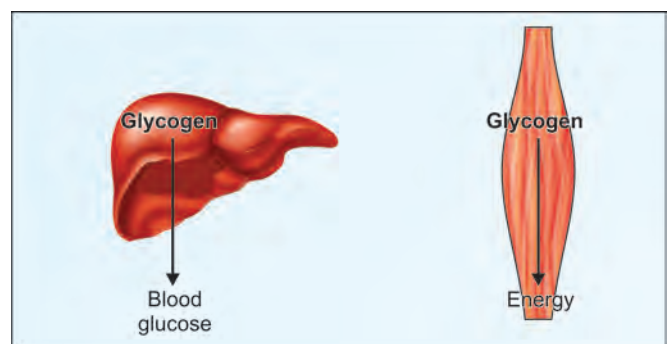


Fig. 10.1A: Functions of muscle and liver glycogen



4. All the enzymes related to glycogen metabolism are cytoplasmic.

## DEGRADATION OF GLYCOGEN (GLYCOGENOLYSIS)

### Glycogen Phosphorylase

- Glycogen phosphorylase removes glucose as glucose-1-phosphate from glycogen (phosphorolysis) (Fig. 10.1B). It contains **pyridoxal phosphate (PLP)** as a prosthetic group. The alpha-1, 4 linkages in the glycogen are cleaved.
- It removes glucose units one at a time. Enzyme sequentially hydrolyzes alpha-1, 4 glycosidic linkages,

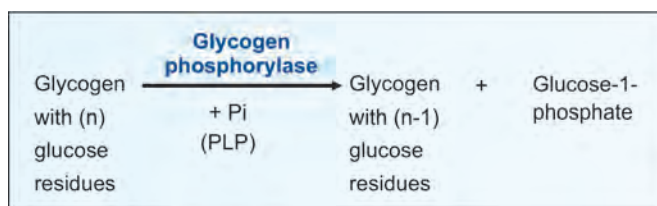


Fig. 10.1B: Reaction of glycogen phosphorylase

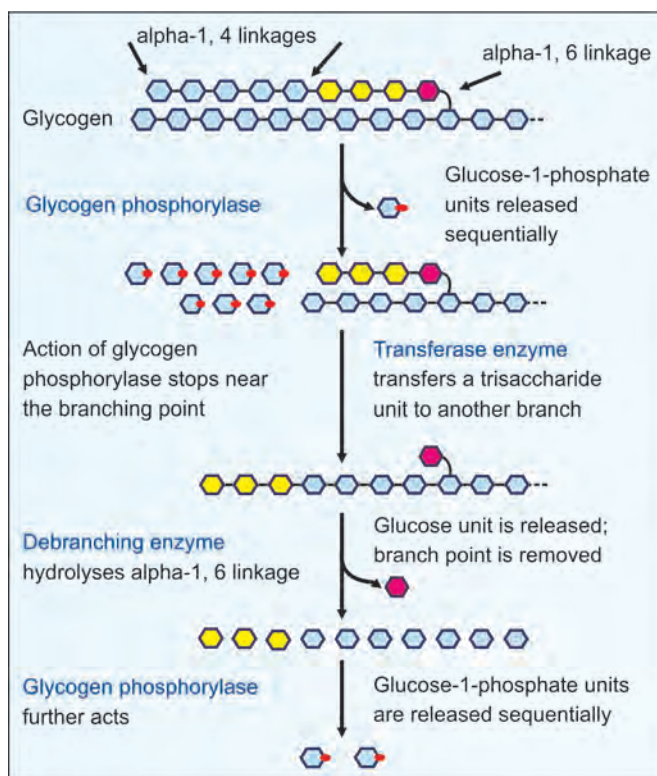


Fig. 10.2: Glycogenolysis

till it reaches a glucose residue, 3–4 glucose units away from a branch point (Fig. 10.2). It cannot attack the 1, 6 linkage at branch point.

- If glycogen phosphorylase alone acts on a glycogen molecule, the final product is a highly branched molecule; it is called **limit dextrin**.

### Debranching by Bifunctional (Two) Enzymes

- A block of 3 glucose residues (trisaccharide unit) are transferred from the branching point to another branch. This enzyme is alpha-1, 4 → alpha-1, 4 **glucan transferase**.
- Now the branch point is free. Then **alpha-1, 6-glucosidase** (debranching enzyme) can hydrolyze the remaining glucose unit held in alpha-1, 6 linkage at the branch point (Fig. 10.2).
- This glucose residue is released as **free glucose**. At this stage, the ratio of glucose-1-phosphate to free glucose is about 8:1.
- The transferase and alpha-1, 6-glucosidase will together convert the branch point to a linear one. With the removal of the branch point, phosphorylase enzyme can proceed with its action.

### Phosphoglucomutase

Phosphorylase reaction produces glucose-1-phosphate while debranching enzyme releases glucose. The glucose-1-phosphate is converted to glucose-6-phosphate by phosphoglucomutase (Fig. 10.3).

### Glucose-6-phosphatase in Liver

Next, hepatic glucose-6-phosphatase hydrolyzes glucose-6-phosphate to glucose. The free glucose is released to the bloodstream.

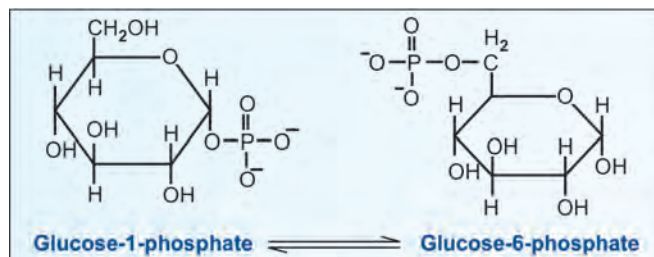


Fig. 10.3: Phosphoglucomutase reaction

## Muscle Lacks Glucose-6-phosphatase

Muscle will not release glucose to the bloodstream, because muscle tissue does not contain the glucose-6-phosphatase. Instead, in muscle, glucose-6-phosphate undergoes glycolysis to produce ATP for muscle contraction.

## Energetics

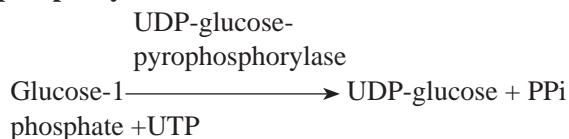
- The energy yield from one glucose residue derived from glycogen is 3 ATP molecules, because no ATP is required for initial phosphorylation of glucose (step 1 of glycolysis).
- If glycolysis starts from free glucose only 2 ATPs are produced.

## GLYCOGEN SYNTHESIS (GLYCOGENESIS)

The glycogen synthesis occurs by a pathway distinctly different from the reversal of glycogen breakdown, which would prevent the operation of futile cycles. The steps are:

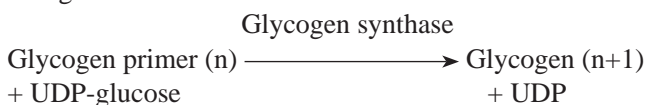
### Activation of Glucose

UDP glucose is formed from glucose-1-phosphate and UTP (uridine triphosphate) by the enzyme **UDP-glucose pyrophosphorylase**.



### Glycogen Synthase

The glucose moiety from UDP-glucose is transferred to a glycogen primer (**glycogenin**) molecule. The primer is essential to accept the glycosyl unit. The primer is made up of a protein-carbohydrate complex. It is a dimeric protein, having two identical monomers. An oligosaccharide chain of 7 glucose units is added to each monomer.



In the next step, activated glucose units are sequentially added by the enzyme glycogen synthase (Fig. 10.4). The glucose unit is added to the nonreducing (outer) end of the glycogen primer to form an alpha-1, 4 glycosidic linkage and UDP is liberated.

### Glycogen Synthase and Primer

The glycogen primer is formed by autoglycosylation of glycogenin. Glycogenin is a dimeric protein, the monomers glycosylating each other using UDP glucose till seven glucose units are added. This molecule acts as the glycogen primer to which glucose units are added by glycogen synthase.

### Branching Enzyme

- The glycogen synthase can add glucose units only in alpha-1, 4 linkage. A branching enzyme is needed to create the alpha-1, 6 linkages.
- When the chain is lengthened to 11–12 glucose residues, the branching enzyme will transfer a block of 6 to 8 glucose residues from this chain to another site on the growing molecule. The enzyme amylo-[1, 4]→[1, 6]-transglucosidase (**branching enzyme**) forms this alpha-1, 6 linkage. (Fig. 10.4).
- To this newly created branch, further glucose units can be added in alpha-1, 4 linkage by glycogen synthase.

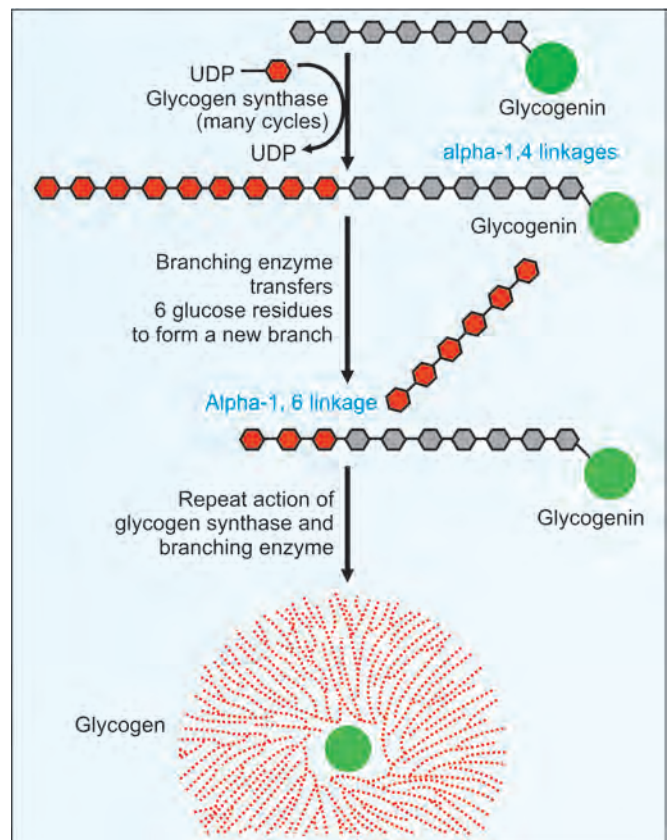


Fig. 10.4: Formation of branches in glycogen

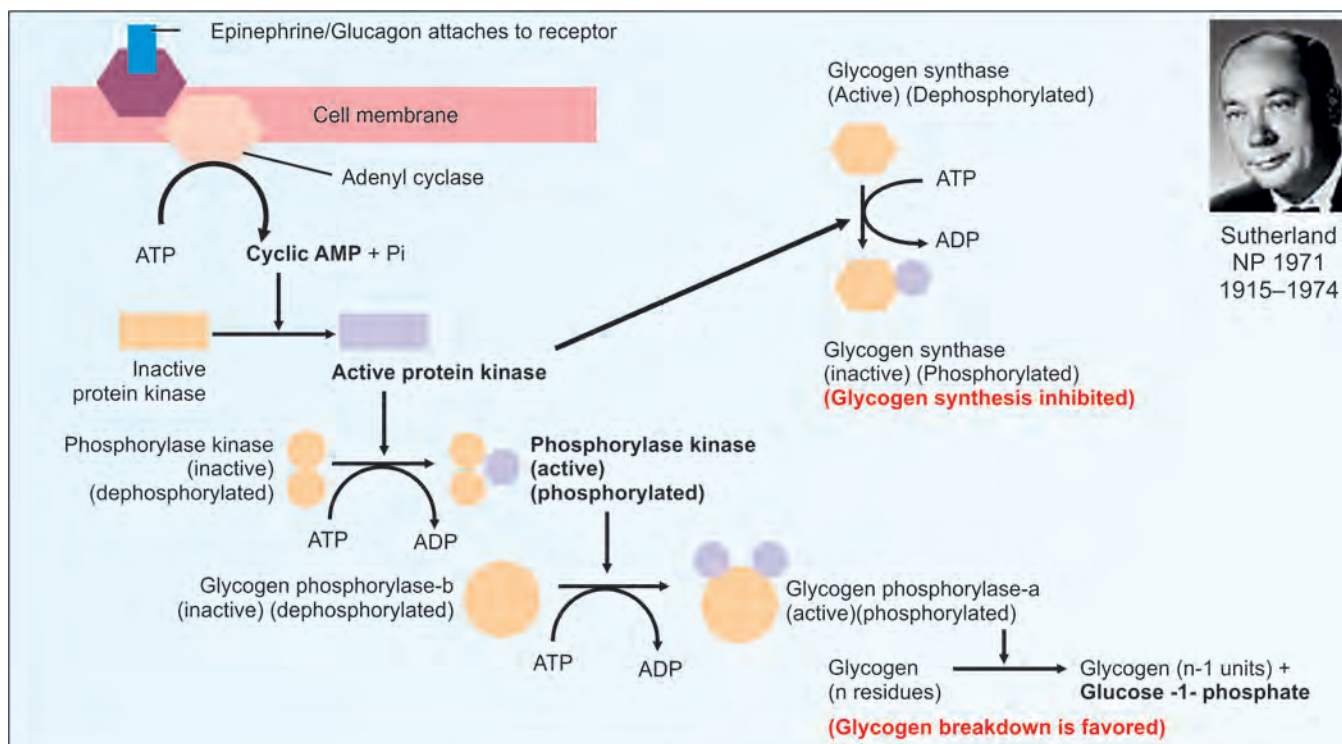


Fig. 10.5: Cyclic AMP mediated activation cascade

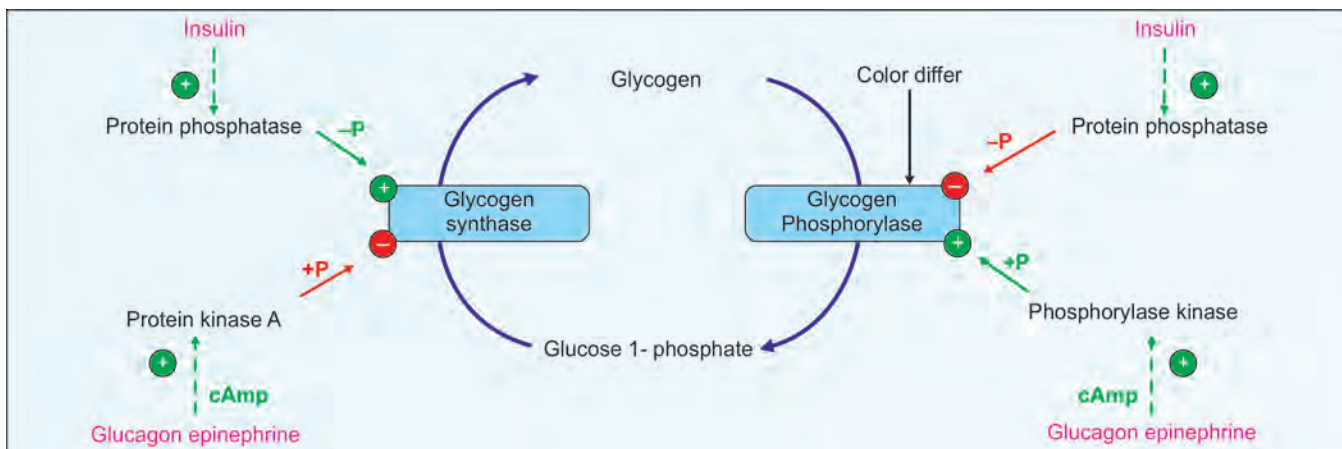


Fig. 10.6: Reciprocal regulation of glycogenolysis and glycogen synthesis by cyclic AMP

## Regulation of Glycogen Metabolism

- i. The synthesis and degradation pathways are reciprocally regulated **to prevent futile cycles**.
- ii. The **phosphorylated form of glycogen phosphorylase is active; but glycogen synthase becomes inactive on phosphorylation**. The covalently modified phosphorylase is active even without AMP. Active (dephosphorylated) glycogen synthase is responsive to the action of glucose-6-

phosphate. Covalent modification modulates the effect of allosteric regulators. The hormonal control by covalent modification and allosteric regulation are interrelated.

- iii. These hormones act through a second messenger, cyclic AMP (cAMP) (For structure see Fig 43.8). The mechanism is shown in Figures 10.5 and 10.6.
- iv. The covalent modification of glycogen phosphorylase and synthase is by a cyclic AMP mediated



cascade. Specific protein kinases bring about phosphorylation and protein phosphatases cause dephosphorylation.

## Generation of Cyclic AMP (cAMP)

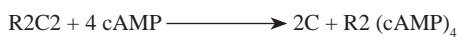
- i. Both liver and muscle phosphorylases are activated by a **cyclic AMP mediated activation cascade** triggered by the hormonal signal.
- ii. The hormones **epinephrine and glucagon can activate liver glycogen phosphorylase but glucagon has no effect on the muscle.**
- iii. When the hormone binds to a specific receptor on the plasma membrane, the enzyme adenylyl cyclase is activated which converts ATP to cyclic AMP (cAMP).
- iv. When level of cyclic AMP rises, it will activate a protein kinase (Fig. 10.5).

### Protein Kinase Activation

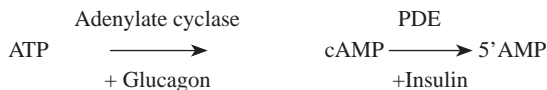
The protein kinase is inactive when the catalytic (C) and regulatory (R) subunits are associated with each other.

Earl Sutherland (Nobel Prize, 1971) studied the role of cyclic AMP as the second messenger in glycogenolysis. In 1992, Nobel prizes were awarded to Edwin Krebs and Edmond Fisher for their work on protein kinase, phosphorylase kinase and phosphorylase phosphatase.

The cAMP combines with the R subunit so that the C subunit is free to have its catalytic activity. PKA is an enzyme that can phosphorylate serine and threonine residues of several enzyme proteins and is activated by cAMP which combines with the regulatory subunit of PKA. In the absence of cAMP, PKA is an inactive tetramer.



The intracellular concentration of cAMP therefore decides the level of active PKA and cAMP level depends on the activity of adenylyl cyclase and phosphodiesterase. Cyclic AMP level is increased by glucagon and decreased by insulin.



### Phosphorylase Kinase Activation

The active protein kinase can now convert the phosphorylase kinase to an active phosphorylated form, which converts phosphorylase-b to phosphorylase-a (Fig. 10.6).

Phosphorylase kinase itself is a tetrameric enzyme (alpha, beta, gamma, delta). Of these the gamma subunit has the catalytic site and the other 3 subunits have regulatory effects. Phosphorylase kinase is activated by  $\text{Ca}^{++}$  and phosphorylation of alpha and beta subunits by PKA. Phosphorylation of alpha and beta subunits relieves autoinhibition of catalytic activity of gamma subunit. Binding of  $\text{Ca}^{++}$  to the delta subunit which is identical to calmodulin (CaM) is also necessary for full activity of delta subunit since it also has a role in dysregulating the

gamma subunit. Calcium triggers muscle contraction as well as glycogen breakdown through the action of phosphorylase kinase. The rate of glycogenolysis is linked to rate of muscle contraction.

The dephosphorylation of the active form by **protein phosphatase 1 (PP1)** involves removal of phosphate group from phosphorylase a and alpha and beta subunits of phosphorylase kinase. The activity of PP1 is controlled differently in liver and muscle. The catalytic subunit of PP1 in muscle is active only when it is bound to glycogen through the glycogen binding GM subunit. The phosphorylation of PP1 by an insulin stimulated protein kinase (site1) activates the enzyme where as phosphorylation at site 2 by PKA makes its action ineffective. When cAMP level is high, PP1 is inhibited by inhibitor1 which is activated by phosphorylation by PKA. The effect of cyclic AMP is not only by increasing the phosphorylation of enzymes, but also by decreasing dephosphorylation.

## Glycogen Phosphorylase in Liver and Muscle

- a. **Liver:** The liver phosphorylase-b is the inactive form. It becomes **active on phosphorylation**. The active enzyme is denoted as **phosphorylase-a**. The enzyme is inhibited by ATP and glucose-6-phosphate. (see Fig. 9.38).

In the liver the PP1 is regulated differently through the intermediary of **glycogen binding subunit (GL)**. GL complex can bind to R and T forms of phosphorylase a, but the phosphate group attached to ser14 is exposed only in the T state, so that PP1 can convert phosphorylase a to phosphorylase b. Glucose is an allosteric inhibitor of phosphorylase a. Insulin favors this effect by promoting the uptake and phosphorylation of glucose.

- b. **Muscle:** Skeletal muscle glycogen is degraded only when the demand for ATP is high. The regulation of glycogenolysis in skeletal muscle is by epinephrine. Glucagon has no effect on muscle glycogenolysis. AMP formed by degradation of ATP during muscle contraction is an allosteric activator of phosphorylase b.

The active form of phosphorylase is referred to as 'a' (active, phosphorylated) and the relatively inactive dephosphorylated form as 'b'. On the other hand, the active glycogen synthase (a) is dephosphorylated and phosphorylated (b) is relatively inactive.

Glycogen phosphorylase is activated by phosphorylation by phosphorylase kinase that adds phosphate group to a specific serine residue of phosphorylase b (ser14). This phosphorylase kinase, in



Edmond  
Fischer  
NP 1992  
b.1920



Edwin G  
Krebs  
NP 1992  
1918–2009



Otto von  
Guericke  
1877–1945



Archibald  
Garrod  
1857–1936



turn, is activated by protein kinase A or cyclic AMP dependent protein kinase. Phosphoprotein phosphatase I dephosphorylates both phosphorylase kinase and phosphorylase b. Phosphorylase b is sensitive to allosteric effectors like AMP but phosphorylase a is not sensitive. High concentration of ATP and glucose-6-phosphate in the cell will inhibit phosphorylase b.

## Glycogen Synthase

- Glycogen synthase and phosphorylase activities are **reciprocally regulated** (Fig. 10.6).
- The same protein kinase, which phosphorylates the phosphorylase kinase would also phosphorylate glycogen synthase.
- The activity of the glycogen synthase is markedly decreased on phosphorylation. Insulin promotes glycogen synthesis by favouring dephosphorylation.

Glycogen synthase is active in the dephosphorylated state. Phosphorylase kinase can phosphorylate glycogen synthase and inactivate the enzyme. PKA can also inactivate the enzyme by phosphorylation.  $\text{Ca}^{++}$  and calcium dependent cam kinase also phosphorylate the enzyme.

Relative rates of glycogen synthesis and breakdown are controlled by the action of PKA, phosphorylase kinase and PP1. PP1 can activate glycogen synthase only after dephosphorylating and inactivating phosphorylase a. The regulation of glycogen phosphorylase and synthase is a typical example of multisite phosphorylation (primary and secondary sites) for metabolic regulation.

Control by allosteric effectors is superimposed on covalent modification. Glucose-6-phosphate can activate glycogen synthesis. Insulin activates PP1 and PDE which decreases cAMP level and increases G6P level to promote glycogen synthesis.

The reciprocal regulation of glycogenolysis and glycogenesis is by covalent modification (phosphorylation and dephosphorylation). Insulin and glucagon are the major regulatory hormones, although epinephrine has stimulatory effect on glycogenolysis in both liver and muscle. They bring about alterations in the activity of protein kinases and phosphatases by varying the level of cAMP.

## Summary of Regulation

- The **key enzyme for glycogenolysis is phosphorylase**, which is activated by glucagon and epinephrine, under the stimulus of hypoglycemia.
- The **key enzyme for glycogen synthesis is glycogen synthase**, the activity of which is decreased by glucagon and epinephrine but is enhanced by insulin, under the stimulus of hyperglycemia (Fig. 10.7).

Glycogen metabolism is regulated by coordinated regulation of glycogen synthase and glycogen

phosphorylase. The regulatory mechanisms include allosteric control as well as hormonal control by covalent modification of enzymes. The allosteric effectors are ATP, glucose-6-phosphate and AMP. The regulation in muscle and liver is given in Table 10.1.

## GLYCOGEN STORAGE DISEASES

These are inborn-errors of metabolism. That phrase was coined by Sir Archibald Garrod.

### Glycogen Storage Disease Type-I

- It is also called **Von Gierke's Disease**. Most common type of glycogen storage disease is type I.
- Incidence is 1 in 100,000 live births. Salient features of the disease are:
- Glucose-6-phosphatase** is deficient.
- Fasting hypoglycemia that does not respond to stimulation by adrenaline**. The glucose cannot be released from liver during over night fasting (see Box 10.4 for neonatal hypoglycemia).
- Hyperlipidemia, **lactic acidosis** and **ketosis**.
- Glucose-6-phosphate is accumulated, so it is channeled to HMP shunt pathway (described below) producing more ribose and more purine nucleotides.
- Purines are then catabolized to uric acid, leading to **hyperuricemia** (see Chapter 43).
- Glycogen gets deposited in liver. Massive liver enlargement may lead to **cirrhosis**.
- Children usually die in early childhood.

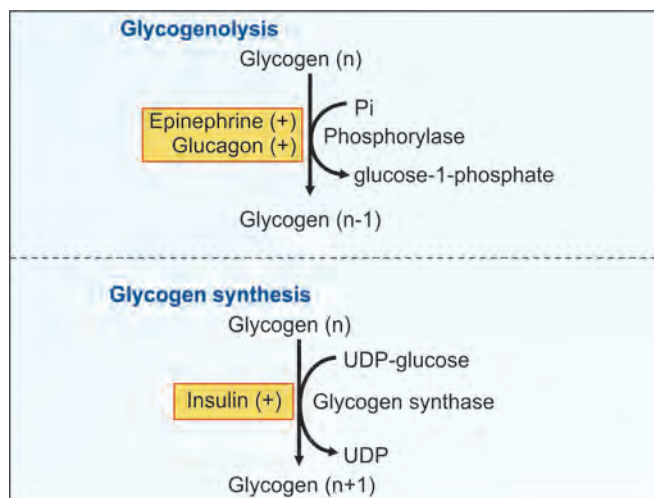


Fig. 10.7: Effects of hormones on glycogen

10. Treatment is to give small quantity of food at frequent intervals.

Other glycogen storage diseases (type II to X) are shown in Table 10.2. They are very rare, incidence being 1 in 1 million births (Box 10.1A).

#### Box 10.1A: Pompe's disease

Enzyme replacement therapy is now available for treatment of infantile-onset Pompe's disease. The enzyme designated as Myozyme (recombinant human acid alpha glucosidase, rhGAA) is administered intravenously and is approved in US by FDA. The drug is very expensive currently and has to be taken life-long.

Blood glucose level is maintained within a very narrow limit in normal persons. The homeostasis of blood sugar and abnormal conditions are explained in Chapter 24.

## HEXOSE MONOPHOSPHATE (HMP) SHUNT PATHWAY

It is also known as “Pentose phosphate pathway”; “Dickens-Horecker pathway”; “Shunt pathway” or “Phosphogluconate oxidative pathway”. Instead of glucose going through the glycolytic pathway, it is shunted through this pathway; so it is known as the **shunt pathway**. In glycolysis, there are a

**TABLE 10.1:** Regulators of glycogen metabolism (L = Liver, M = Muscle)

Effectors	Glycogen phosphorylase-L	Glycogen synthase-L	Glycogen phosphorylase-M	Glycogen synthase-M
ATP	Inhibition	Inhibition	Inhibition	Inhibition
AMP	Activation		Activation	Inhibition
Glucose-6-phosphate	Inhibition	Activation	Inhibition	Activation
Ca <sup>++</sup>	Activation		Activation	

**TABLE 10.2:** Glycogen storage diseases

Type	Name	Deficient enzyme	Clinical features
Type 0a		Glycogen synthase 2 (Liver)	Hypoglycemia, hyperketonemia, early death
Type Ia	von Gierke's disease	Glucose-6-phosphatase	Fasting hypoglycemia; hepatomegaly, thrombocyte dysfunction
Type 1b		Microsomal glucose 6 phosphate translocase	Same as above, plus neutropenia and recurrent infections
Type 1c		Microsomal Pi transporter	Like 1
Type II	Pompe's disease	Lysosomal maltase (Alpha 1, 4 glucosidase)	Accumulation of glycogen in lysosomes of Liver, heart and muscle; infantile form death before 2 years; juvenile form myopathy; adult form muscular dystrophy like
Type III	Limit dextrinosis Cori's disease	Debranching enzyme (Liver and muscle)	Highly branched dextrin accumulates; Fasting hypoglycemia; hepatomegaly, myopathy
Type IV	Amylopectinosis Anderson's disease	Branching enzyme (Liver and muscle)	Glycogen with few branches; hepatosplenomegaly, cirrhosis; death before age of 5
Type V	McArdle's disease	Muscle phosphorylase (Skeletal muscle)	Exercise intolerance; accumulation of glycogen in muscles, myoglobinuria
Type VI	Hers' disease	Liver phosphorylase	Mild hypoglycemia; hepatomegaly; hyperlipidemia, ketosis; better prognosis than other types
Type VII	Tarui's disease	Muscle PFK-1 (Muscle, RBCs)	Glycogen accumulates in muscles; exercise intolerance; hemolytic anemia
Type VIII		Liver phosphorylase kinase	Mild hypoglycemia; better prognosis
Type IXa, b		Muscle phosphorylase kinase (liver, leukocytes, muscle)	Like VI
Fanconi Bickel hepatorenal glycogenosis		GLUT-2	Failure to thrive, hepatomegaly, rickets, proximal renal tubular dysfunction

few bisphosphate intermediates; but in this pathway, there are **monophosphates only**; hence this is called hexose monophosphate (HMP) pathway. The reactions involve the intermediate formation of **pentose phosphates**; hence this is also called pentose phosphate pathway.

About 10% of glucose molecules per day are entering this pathway. The liver and RBC metabolise about 30% of glucose by this pathway. The major purpose of this pathway is generation of reduced NADPH and pentose phosphates for nucleotide synthesis (Box 10.1B).

## Overview of the Shunt Pathway

The HMP shunt pathway has oxidative and non-oxidative phases. During the oxidative phase, glucose-6-phosphate is oxidized with the generation of 2 molecules of NADPH, and one molecule of pentose phosphate, with the liberation of one molecule of CO<sub>2</sub>. During the non-oxidative phase, the pentose phosphates are converted to intermediates of glycolysis.

## OXIDATIVE PHASE

### Step 1 of HMP pathway

Glucose-6-phosphate is oxidized by NADP<sup>+</sup> dependent **Glucose-6-phosphate dehydrogenase (GPD)**. 6-phosphoglucono lactone is formed. One molecule of **NADPH** is formed in the reaction (Fig. 10.8). This is the **rate-limiting step**. Regulation is effected by this enzyme.

### Step 2 of HMP pathway

The lactone is hydrolyzed by gluconolactone hydrolase to form 6-phosphogluconic acid (Fig. 10.8).

### Step 3, NADPH is again Generated

This is an oxidative step coupled with decarboxylation. The enzyme is 6-phosphogluconate **dehydrogenase**. The

6-phosphogluconic acid is dehydrogenated to 3-keto-6-phosphogluconate. It is a transient compound, and spontaneously undergoes **decarboxylation** to form ribulose-5-phosphate. The carbon of CO<sub>2</sub> is derived from COOH group of gluconic acid (Fig. 10.8). In this step, a second molecule of **NADPH is generated**.

## NON-OXIDATIVE PHASE

### Step 4, Isomerization

The ribulose-5-phosphate is then isomerized to ribose-5-phosphate or epimerized to xylulose-5-phosphate (Fig. 10.9).

### Step 5, Transketolase Reaction

Transketolase is a thiamine pyrophosphate (TPP) dependent enzyme. It transfers two-carbon unit (with keto group) from xylulose-5-phosphate to ribose-5-phosphate to form a 7 carbon sugar, sedoheptulose-7-phosphate and glyceraldehyde-3-phosphate (Fig. 10.10). Transketolase enzyme will transfer the group from a donor ketose to an aldose acceptor. In thiamine deficiency, transketolase activity is decreased.

#### Box 10.1B: NAD and NADP are different

NADH is used for reducing reactions in catabolic pathways, e.g. pyruvate to lactate. NADH enters the electron transport chain, and ATP is generated.

NADPH is used for reductive biosynthetic reactions, e.g. de novo synthesis of fatty acid, synthesis of cholesterol, etc. NADPH is generated mainly by the HMP shunt pathway. NADPH is not entering the electron transport chain; and NADPH will not generate ATP.

NADP differs from NAD in having an additional phosphate group. (see Chapter 37). These two co-enzymes are specific for enzymes; they are not interchangeable.

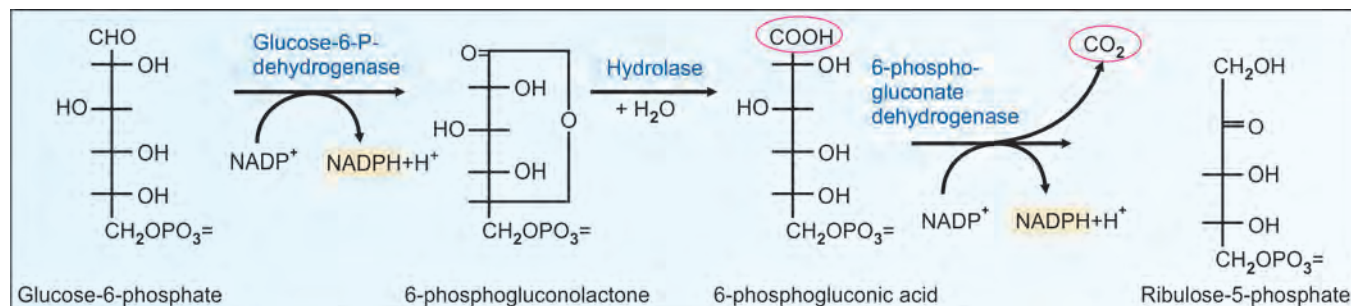


Fig. 10.8: Oxidative phase of HMP shunt pathway; Steps 1, 2 and 3

## Step 6, Transaldolase Reaction

The next group transfer reaction involves the transfer of a 3 carbon unit, from sedoheptulose-7-phosphate to glyceraldehyde-3-phosphate to form fructose-6-phosphate. Here also the donor is a ketose and acceptor is an aldose (Step 6, Fig. 10.11).

## Step 7, Second Transketolase Reaction

In another transketolase reaction a 2C unit is transferred from xylulose-5-phosphate to erythrose-4-phosphate to form fructose-6-phosphate and glyceraldehyde-3-phosphate (Step 7, Fig. 10.11).

## Step 8, Regeneration of Glucose-6-Phosphate

Two molecules of glyceraldehyde-3-phosphate formed in step 7 are condensed to form one fructose-6-phosphate (reversal of step 4 of glycolysis). Fructose-6-phosphate is then converted to glucose-6-phosphate (reversal of step 2 of glycolysis). A summary of the whole pathway is depicted in Figure 10.11.

## Regulation of HMP Shunt Pathway

The pathway is mainly regulated by the level of  $\text{NADP}^+$ . The first reaction catalyzed by **GPD is the rate-limiting** step and it is inhibited by NADPH. The oxidative phase is therefore controlled by the level of  $\text{NADP}^+$  and non-oxidative phase by the requirement of pentoses. **Insulin** will induce GPD and therefore will increase the overall pathway. When more NADPH is needed, the pathway proceeds to completion with the equivalent of one molecule of glucose being completely oxidized to  $\text{CO}_2$ . The reaction may be summarized as:

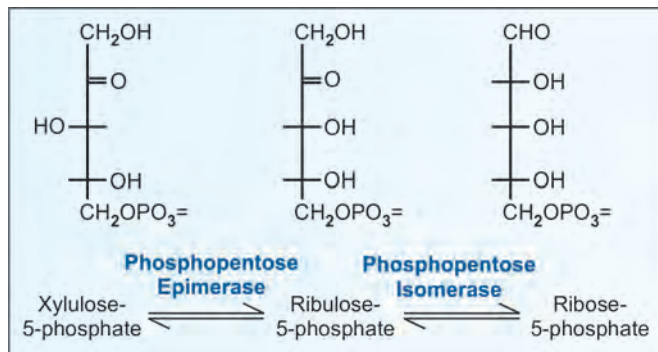
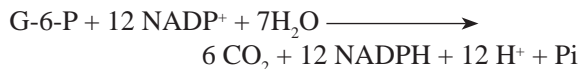


Fig. 10.9: Step 4 of HMP shunt pathway



## Summary of Shunt Pathway

Suppose, 6 molecules of glucose ( $6 \times 6 = 36$  carbons) are entering in this pathway. The first carbon atoms of all 6 glucose molecules are removed as 6 molecules of  $\text{CO}_2$ .

(This is equivalent to complete oxidation of 1 molecule of glucose). In this process, 12 NADPH are generated. The remaining 6 molecules of 5-carbon pentoses ( $6 \times 5 = 30\text{C}$ )

### Box 10.2: Significance of HMP shunt pathway

#### Metabolic importance:

1. To produce NADPH and pentose phosphates  
NADPH is required for
  - i. Reductive biosynthesis—fatty acids, cholesterol and steroid hormones
  - ii. Free radical scavenging
  - iii. Maintain RBC membrane integrity by keeping GSH in reduced state
  - iv. Prevention of met-hemoglobin formation
  - v. Detoxification by hydroxylation
  - vi. Maintain the transparency of lens
  - vii. Bactericidal activity of macrophages
2. Ribose-5-phosphate is required for nucleic acid synthesis  
Clinical Importance
  - i. Glucose-6-phosphate dehydrogenase deficiency
  - ii. Drug induced hemolytic anemia
  - iii. Met-hemoglobinemia
  - iv. Thiamine deficiency leads to reduced transketolase activity

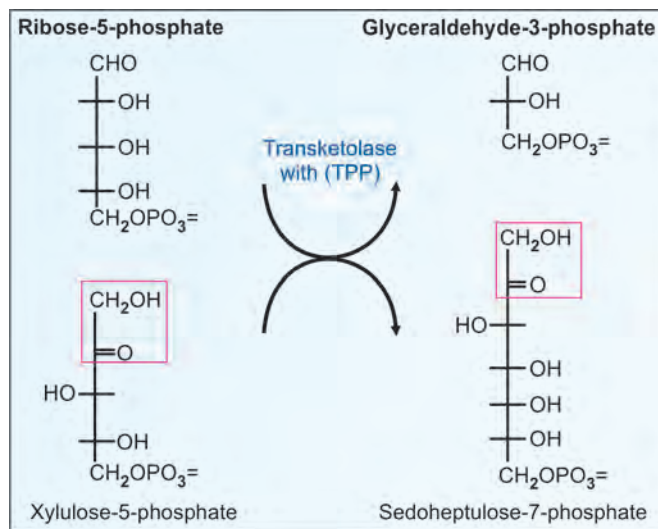


Fig. 10.10: Step 5; first transketolase reaction



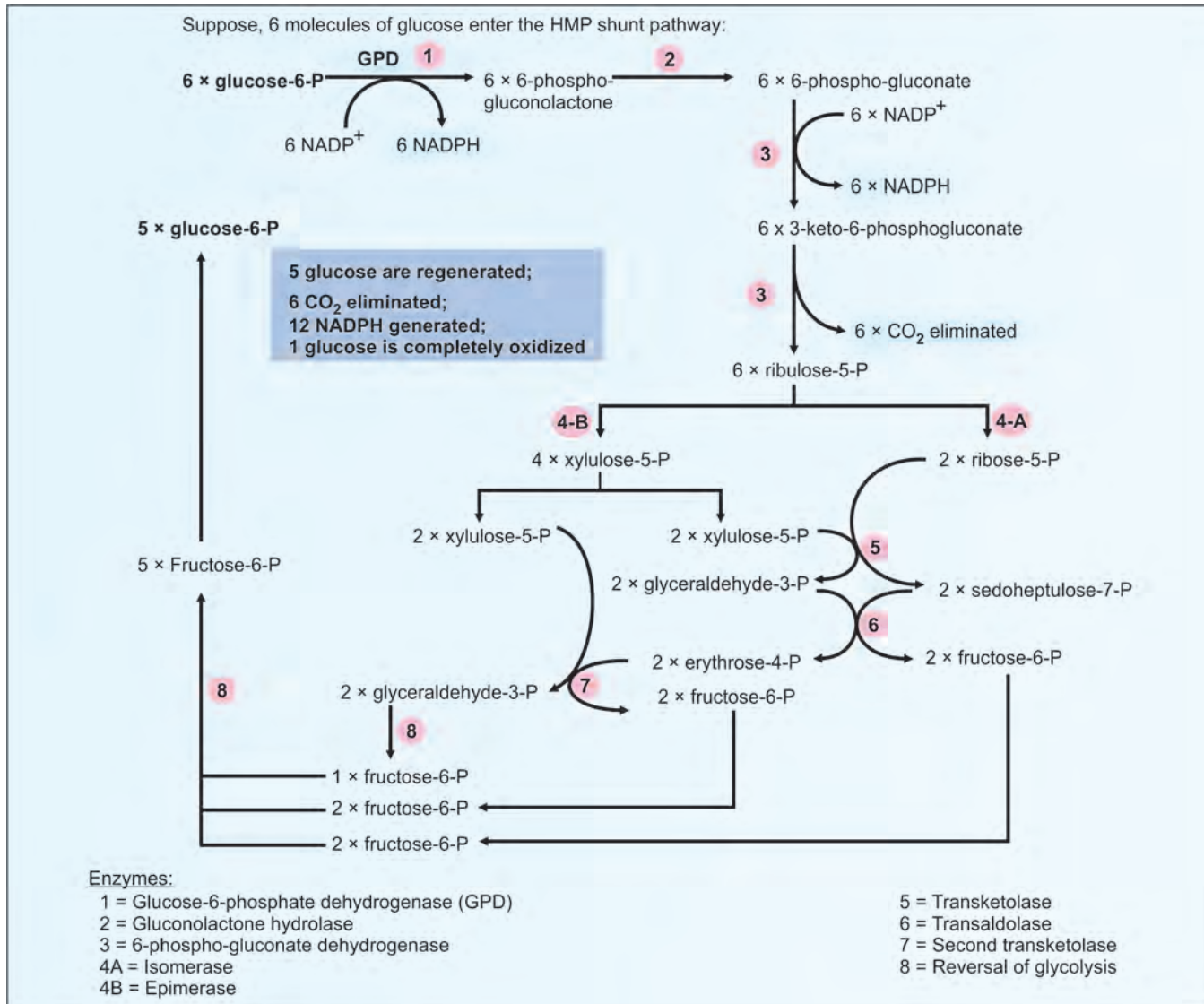


Fig. 10.11: Summary of shunt pathway; numbers shows the steps referred in the text

are interchanged such a way that 5 molecules of glucose ( $5 \times 6 = 30C$ ) are regenerated. This is summarized in Figure 10.11.

### Physiological Significance of the Pathway

Please see summary in Box 10.2.

### Pathway is Operating in Following Organs

- Liver
- Adipose tissue
- Adrenal cortex
- Mammary glands
- Testes and ovaries

- RBCs
- Lens of eye

- The oxidative phase of the pathway is seen in the above organs, where NADPH generation is required for lipid synthesis or steroid synthesis.
- The non-oxidative phase is present in all tissues, and so synthesis of ribose is possible in all tissues of the body.

### Generation of Reducing Equivalents

The major metabolic role of the pathway is to provide cytoplasmic **NADPH** for **reductive biosynthesis** of fatty acids, cholesterol and steroids (see Chapters 12 and 13).

## Free Radical Scavenging

Free radicals (super oxide, hydrogen peroxide) are continuously produced in all cells. These will destroy DNA, proteins, fatty acids and all biomolecules, and in turn cells are destroyed. The free radicals are inactivated by enzyme systems containing superoxide dismutase (SOD), peroxidase (POD) and glutathione reductase (GR). Reduced GR is regenerated with the help of NADPH (Fig. 10.12).

## Erythrocyte Membrane Integrity

NADPH is required by the RBC to keep the **glutathione** in the reduced state (Fig. 10.12). In turn, reduced glutathione will detoxify the peroxides and free radicals formed within the RBC (see Chapter 33). So, **NADPH, glutathione and glutathione reductase** together will preserve the integrity of RBC membrane.

## Prevention of Met-Hemoglobinemia

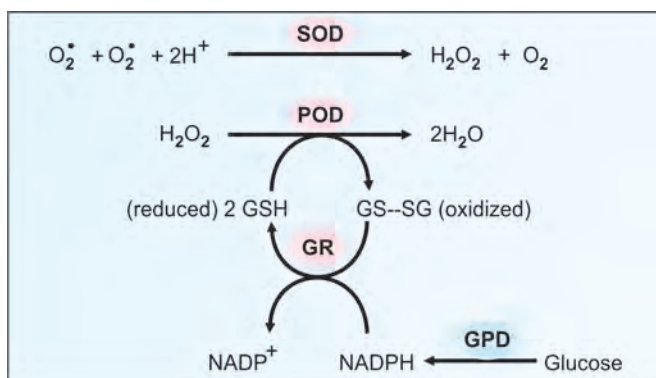
NADPH is also required to keep the iron of hemoglobin in the reduced (ferrous) state and to prevent the accumulation of met-hemoglobin (see Chapter 22). Met-hemoglobin cannot carry oxygen.

## Detoxification of Drugs

Most of the drugs and other foreign substances are detoxified by the liver microsomal P450 enzymes, with the help of NADPH.

## Lens of Eye

Maximum concentration of NADPH is seen in lens of eye. NADPH is required for preserving the transparency of lens.



**Fig. 10.12:** Free radical scavenging enzymes. SOD = superoxide dismutase; POD = glutathione peroxidase; GSH = glutathione; GR = glutathione reductase; GPD = glucose-6-phosphate dehydrogenase

## Macrophage Bactericidal Activity

NADPH is required for production of reactive oxygen species (ROS) (superoxide anion radical) by macrophages to kill bacteria (Fig. 10.13).

## Availability of Ribose

Ribose and deoxyribose are required for DNA and RNA synthesis. Ribose is also necessary for nucleotide co-enzymes. Reversal of non-oxidative phase is present in all tissues, by which ribose could be made available.

## What about ATP?

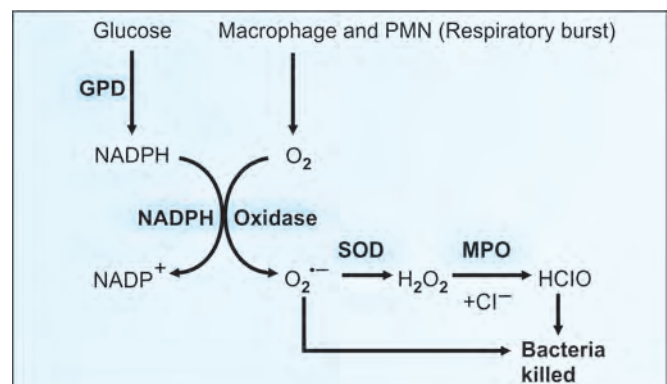
*ATP is neither utilized nor produced by the HMP shunt pathway.* Cells do not use the shunt pathway for energy production.

## Clinical Significance of Shunt Pathway

Please see summary in Box 10.3.

## GPD Deficiency

- i. The enzyme glucose-6-phosphate dehydrogenase (GPD) may be deficient in some persons (see Chapter 23). It is the most common enzyme deficiency seen in clinical practice. The defect is transmitted as an **X-linked recessive** trait.
- ii. It will lead to **drug-induced hemolytic anemia**. The deficiency is manifested only when exposed to certain drugs or toxins, e.g. intake of **antimalarial drugs** like primaquine. Primaquin stimulates peroxide formation inside RBC. In GPD deficient cells, the level of



**Fig. 10.13:** Generation of ROS in macrophages. MPO = myeloperoxidase

NADPH is low; hence further production of peroxides will lead to cell lysis.

- iii. Similarly, ingestion of toxic glycosides present in fava beans may have similar effect (**Favism**).
- iv. **Sulpha drugs** and furadantin may also precipitate the hemolysis. This will lead to jaundice and severe anemia.
- v. **The geographical distribution of GPD deficiency correlates well with the malarial endemicity.** The enzyme deficiency offers resistance to *Plasmodium* infection (see Chapter 22). The parasite requires reduced glutathione for its survival, which will not be available in adequate amounts in deficiency of GPD. GPD deficiency is reported from almost all regions of India.

### Met-Hemoglobinemia

GPD deficient persons will show increased met-hemoglobin in circulation, even though cyanosis may not be manifested.

### Thiamine Deficiency

The **transketolase** reaction is measured in RBCs as an index of the thiamine status of an individual. The occurrence and manifestation of **Wernicke's Korsakoff's syndrome** (encephalopathy) which is seen in **alcoholics** and those with thiamine deficiency is due to a genetic defect in the enzyme **transketolase**.

### Inborn Errors of Pentose Phosphate Pathway

There are three inborn errors in the pentose phosphate pathway. The most common being the result of mutations in glucose-6-phosphate dehydrogenase (GPD), which is described previously. Rarely deficiencies of ribose-5-phosphate isomerase and transaldolase have been documented. In transaldolase deficiency, liver problems were the principal symptoms.

Because of the need for NADPH in phagocytic cells, by the NADPH oxidase system, any defect in enzymes in this process can result in impaired killing of infectious organisms. Chronic granulomatous disease (CGD; also known as Bridges-Good syndrome) is a syndrome that results in individuals harboring defects in the NADPH oxidase system. Individuals with CGD are at increased risk for specific recurrent infections. The most common are pneumonia, abscesses of the skin, tissues, and organs, and osteomyelitis (infection of the bone). Individuals with reduced ability to produce NADPH (such as those with GPD deficiency) also manifest with CGD.

## GLUCURONIC ACID PATHWAY OF GLUCOSE

The pathway is shown in Figure 10.14.

### Importance of the Glucuronic Acid Pathway

It provides **UDP-glucuronic acid**, which is the active form of glucuronic acid. It is used for the following purposes:

1. Conjugation of bilirubin
2. Conjugation of steroids
3. Conjugation of various drugs which will make them more water soluble and more easily excretable.
4. Synthesis of glycosamino glycans (GAG).

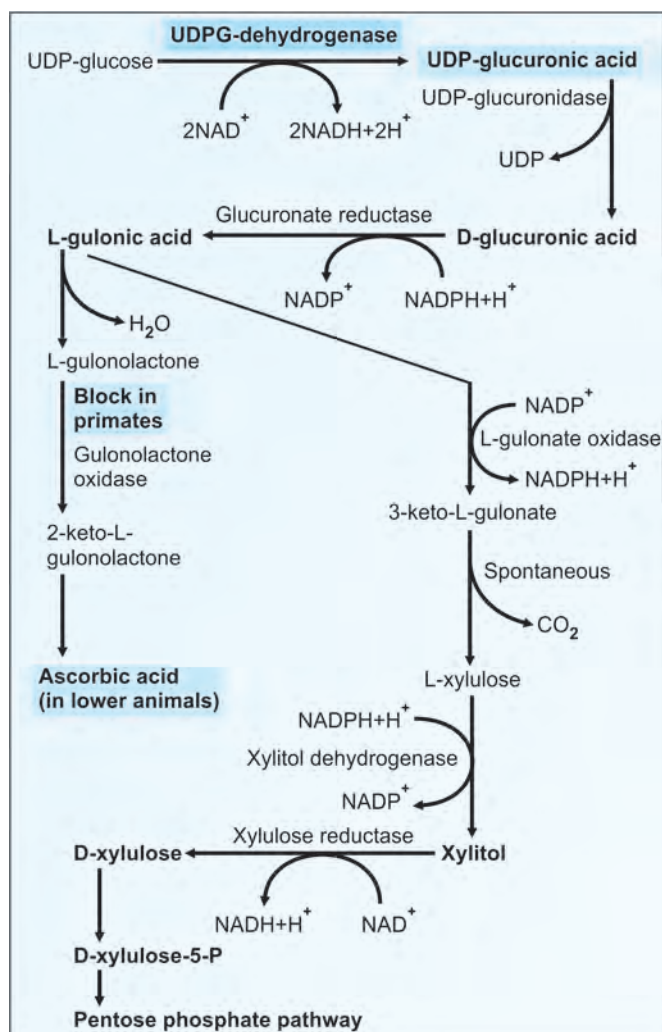


Fig. 10.14: Glucuronic acid pathway

## Effect of Drugs

Barbiturates, antipyrene and aminopyrine will increase the uronic acid pathway, leading to availability of more glucuronate for conjugation purpose.

## Vitamin C in Lower Animals

The enzyme **L-gulonolactone oxidase is absent in human beings**, primates, guinea pigs and bats. Hence ascorbic acid cannot be synthesized by these organisms. Hence ascorbic acid became essential in diet for human beings.

## Essential Pentosuria

- i. It is one of the members of the Garrod's tetrad. The incidence is 1 in 2,500 births.
- ii. It is an inborn error of metabolism. In the pathway (Fig. 10.14), L-xylulose is converted to D-xylulose by two enzymes, **xylitol dehydrogenase** and **xylulose reductase**. Absence of any of these enzymes leads to pentosuria.
- iii. L-xylulose is excreted in urine and gives a **positive Benedict's test**.
- iv. **Barbiturates**, aminopyrine, etc. will induce uronic acid pathway and will increase xylulosuria in such patients.
- v. This condition does not produce any harm; but it should be differentiated from diabetes mellitus.

## POLYOL PATHWAY OF GLUCOSE

Sorbitol is very poorly absorbed from intestine. It is formed by reduction of glucose by aldose reductase to sorbitol,

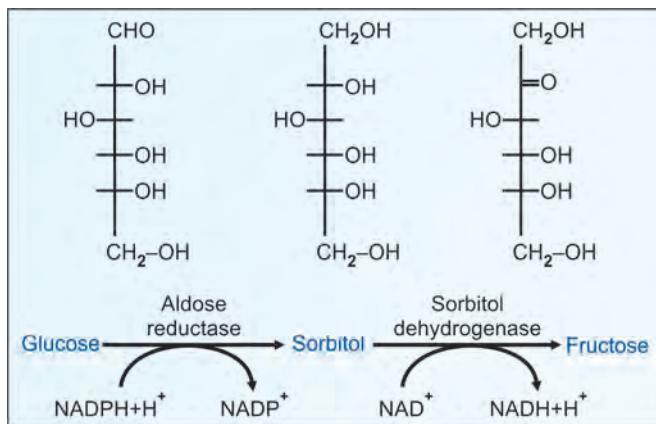


Fig. 10.15: Polyol pathway of glucose metabolism

which can then be oxidized to fructose. This would amount to the interconversion of glucose to fructose (Fig. 10.15).

Glucose when converted to sorbitol, cannot diffuse out of the cell easily and gets trapped there. Sorbitol is normally present in lens of eyes. But in **diabetes mellitus**, when glucose level is high, the sorbitol concentration also increases in the lens. This leads to osmotic damage of the tissue and development of **cataract**. Galactitol also causes cataract (see under galactose metabolism).

Fructose is present in semen in large quantities. It is produced by the polyol pathway. The polyol pathway is active in brain and fructose is seen in CSF. This pathway is inactive in liver.

## Clinical Case Study 10.1

A 2-year-old child presented with liver enlargement. On investigation, Blood sugar—50 mg%, Uric acid—10 mg%, Lactic acid—15 mg% and ketone bodies were present. Plasma cholesterol—300 mg%. What is the likely diagnosis? What is the biochemical basis of the disorder and its treatment?

## Clinical Case Study 10.2

A 6-year-old boy presented with general weakness. There was paleness, fatigue, shortness of breath and a rapid heart rate. History revealed that he had prolonged neonatal jaundice. Results at that time were as follows—Total Bilirubin—10.0 mg%, Conjugated bilirubin—1.5 mg%, Unconjugated bilirubin—8.5 mg%. AST—30.0 U/L, ALT—35.0 U/L, ALP—10.0 KAU/L. LDH—1000 U/L. Jaundice was triggered on many occasions by bacterial and viral infections as well as some antibiotics. What is the likely diagnosis?

## Clinical Case Study 10.3

A 3-year-old child was brought to the pediatrician for complaints of fever and cough. On examination, all systems were normal and no evidence for any genetic disorder. On the safer side, the doctor performed urine screening to rule out an inborn error of metabolism. As a surprise, Benedict's test result came as positive! Blood glucose—100 mg%, urine was negative for glucose as well as galactose; Bial's test was positive. What is the likely diagnosis? What is the biochemical basis for this disease?



### Clinical Case Study 10.1 Answer

The diagnosis is von Gierke's disease (GSD Type I). The important biochemical features are hypoglycemia, hyperlactatemia, metabolic acidosis, hyperlipidemia and hyperuricemia. Clinical features include convulsions, enlargement of liver and kidneys, doll's face (rounded cheeks due to fat deposition), growth retardation, normal mental development, etc. Late complications include renal stones, tubular defects, hypertension, changes in skin and mucous membrane and altered platelet function leading to bleeding. Renal conditions may necessitate dialysis and transplantation.

No specific treatment is available. Primary goal of dietary therapy is to correct hypoglycemia and maintain normoglycemia by frequent small quantity of food. Intake of fructose and galactose is to be limited, because they are converted to lactate, and not to glucose. Nasogastric glucose infusion, parenteral nutrition and oral administration of raw cornstarch are useful options.

### Clinical Case Study 10.2 Answer

GPD deficiency. Jaundice is hemolytic in type, kernicterus and anemia are present. Liver enzymes are normal and lactate dehydrogenase levels are very high. Hemolytic anemia in GPD deficiency is triggered on many occasions by bacterial and viral infections as well as some antibiotics.

### Clinical Case Study 10.3 Answer

Essential pentosuria. See chapter for biochemical basis.

## QUICK LOOK OF CHAPTER 10

- Glycogen is the storage polysaccharide of the body. It is stored mainly in the liver and muscle.
- The enzymes glycogen phosphorylase and glycogen synthase are regulated by covalent modification.
- Glycogen phosphorylase is activated by glucagon and adrenaline, while glycogen synthase is activated by insulin.
- Glycogen storage diseases (GSD) are Inborn errors of metabolism. Type 1 is called von Gierke's disease.
- The HMP shunt pathway, also known as pentose phosphate pathway (PPP) generates NADPH required for reductive cytoplasmic biosynthesis of biomolecules such as steroids, fatty acids and cholesterol.
- The HMP pathway involves only monophosphates. But glycolysis involves both monophosphates and bisphosphates.
- The first step catalyzed by glucose-6-phosphate dehydrogenase (GPD) is the rate-limiting step of the HMP pathway.
- NADPH generated as a result of HMP pathway is essential to maintain transparency of the eye lens, to prevent met-hemoglobinemia and to maintain erythrocyte membrane integrity.
- The pathway also provides pentose sugars (ribose and deoxyribose) for nucleic acid synthesis.
- GPD deficiency is a common clinical condition, transmitted as X-linked recessive trait. Ingestion of fava beans (favism) and anti-malarials such as primaquine precipitates the manifestations.
- Thiamine status of an individual can be assessed by measurement of transketolase reaction of the HMP pathway.
- Polyol dehydrogenase, converts glucose and galactose into sorbitol and galacticol respectively. Accumulation of these compounds are responsible for cataracts seen in chronic diabetes mellitus and galactosemia.

# CHAPTER 11

## Metabolic Pathways of Other Carbohydrates

### Chapter at a Glance

The reader will be able to answer questions on the following topics:

- Fructose metabolism
- Galactose metabolism
- Metabolism of alcohol
- Amino sugars
- Glycoproteins
- Blood group antigens
- Mucopolysaccharidoses

### FRUCTOSE METABOLISM

1. Fructose is a ketohexose present in fruits, honey and sucrose. Soft drinks have the sweetener, corn syrup, which has a high fructose content and is sweeter than sucrose. Fructose is promptly metabolized by the liver.
2. Fructose is phosphorylated by **fructokinase**, an enzyme present in liver with a high affinity for fructose (Fig. 11.1). Fructokinase phosphorylates the substrate at 1st position, whereas hexokinase action is on the 6th position. Fructokinase is not dependent on insulin. So fructose is more rapidly utilized in normal persons, because HK and PFK metabolic bottlenecks are not encountered in fructose metabolism.

Therefore, in theory, fructose will be better utilized in patients with diabetes mellitus, because the first few enzymes of fructose utilization do not require insulin. But in experiments, fructose was found to be deleterious in diabetic patients. Fructose rapidly enters the tissues, leading to enhanced fatty acid synthesis, raised serum triglycerides and increased LDL cholesterol level in blood; all these are atherogenic and harmful.

Fructose metabolism in liver bypasses the PFK control point; hence fructose increases the flux of glycolytic pathway, leading to lipogenesis. Moreover, glycerol phosphate required for TAG synthesis is provided by the metabolism of fructose, leading to the increase in TAG pool in the body.

Phosphorylation of fructose by fructokinase depletes the cell of ATP. Low ATP levels enhance oxidative phosphorylation leading to lowering of Pi levels in cell. This will remove the inhibitory effect on adenosine deaminase. There is increased rate of conversion of AMP to IMP and then to uric acid. Accumulation of fructose-1-phosphate also inhibits gluconeogenesis.

3. In muscle, fructose is phosphorylated by hexokinase to fructose-6-phosphate.
4. The fructose-1-phosphate is then cleaved by the enzyme, fructose-1-phosphate-aldolase or **aldolase-B**. The products are glyceraldehyde and dihydroxyacetone phosphate (Fig. 11.1).
5. Fructose is mainly metabolized by liver, but free fructose is seen in large quantities in **seminal plasma**. The energy for mobility of spermatozoa is mainly derived from fructose. Fructose is secreted by seminal vesicles.

6. In some persons, azoospermia is seen due to a block in the duct. In such persons, fructose is estimated in semen. If fructose is present, the block is above the seminal vesicular duct; if absent, block is after the seminal vesicles.
7. High fructose levels are known to be related to aging and myocardial infarction. Fructose participates in glycation 10 times faster than glucose and the decreased antioxidant effects contribute to myocardial infarction.
- vi. Vomiting and loss of appetite are seen. The infants often fail to thrive. Hepatomegaly and jaundice may occur. If liver damage progresses, death will occur.
- vii. Fructose is also excreted in urine when urine gives positive Benedict's test.
- viii. Withdrawal of fructose from the diet will immediately relieve the symptoms.

## Hereditary Fructose Intolerance (HFI)

- i. It is an autosomal **recessive** inborn error of metabolism. Incidence of the disease is 1 in 20,000 births, while 1 in 70 persons are carriers of the abnormal gene.
- ii. The defect is in **aldolase-B**; hence fructose-1-phosphate cannot be metabolized (Fig.11.1).
- iii. This is seen when sucrose (containing fructose) is introduced in the diet of infants, usually around 6 months of age.
- v. Accumulation of fructose-1-phosphate will inhibit glycogen phosphorylase. This leads to accumulation of glycogen in liver and associated **hypoglycemia** (Box 11.1).

### Box 11.1. Neonatal hypoglycemia

#### Neonatal hypoglycemia is seen in:

1. Glycogen storage disease type I (see Chapter 10)
2. Fructose intolerance (see Chapter 11)
3. Galactosemia (see Chapter 11)
4. Medium chain fatty acyl CoA dehydrogenase deficiency (see Chapter 14)
5. Long chain fatty acyl CoA dehydrogenase deficiency (see Chapter 12)

#### Premature infants are more prone to hypoglycemia because

- a. Decreased level of PEPCK leads to decreased gluconeogenesis
- b. Low hepatic glycogen stores
- c. Inability to produce and utilize ketone bodies
- d. Larger brain : body ratio.

## Fructosuria

This is a benign metabolic defect due to deficiency of fructokinase (Fig. 11.1). There is no abnormality other than excretion of fructose in urine. Fructose is not dietary essential. Urine gives positive Benedict's and Seliwanoff's tests. Incidence is 1 in 130,000 births.

## GALACTOSE METABOLISM

1. The term galactose is derived from Greek word, "gala" = milk. Galactose is an aldohexose and is the 4th epimer of glucose.
2. Galactose is a constituent of lactose of milk sugar, and is taken in the diet. Galactose is not an essential nutrient, because UDP glucose can form UDP galactose (Fig. 11.2).
3. Galactose is metabolized almost exclusively by the liver and therefore galactose tolerance test is done to assess the functional capacity of the liver. UDP galactose is the active donor of galactose during synthetic reactions.
4. Galactose is necessary for synthesis of the following:

#### i. Lactose Synthesis:

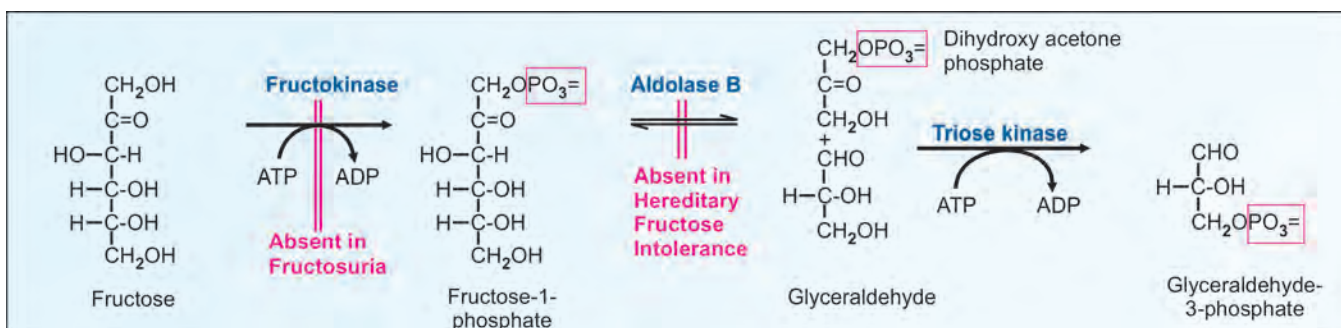
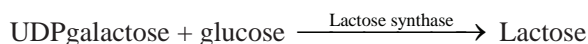
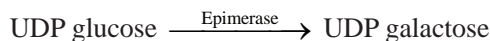


Fig. 11.1: Fructose entering glycolysis

Lactose synthesis is seen in lactating mammary glands. See also Chapter 31.

- ii. Synthesis of glycosaminoglycans
- iii. Synthesis of cerebrosides
- iv. Synthesis of glycolipids
- v. Synthesis of glycoproteins.

## Galactose Utilizing Steps

1. **Galactokinase reaction:** Galactose is first phosphorylated by galactokinase to galactose-1-phosphate (step 1, Fig. 11.2).
2. **Galactose-1-phosphate uridyl transferase (GALT):** This is the **rate-limiting** enzyme in galactose metabolism (Step 2, Fig. 11.2). UDP-galactose may be used as such for synthesis of compounds containing galactose (e.g. lactose).
3. **Epimerase reaction:** By this reaction, galactose is channeled to the metabolism of glucose (Step 3, Fig. 11.2). Since the reaction is freely reversible, even if the dietary supply of galactose is deficient, UDP-glucose can be epimerized to UDP-galactose.
4. **Alternate pathway:** The galactose-1-phosphate pyrophosphorylase in liver becomes active only after 4 or 5 years of life. The enzyme will produce UDP-galactose directly, which can be epimerized to UDP-glucose (Step 4, Fig. 11.2).

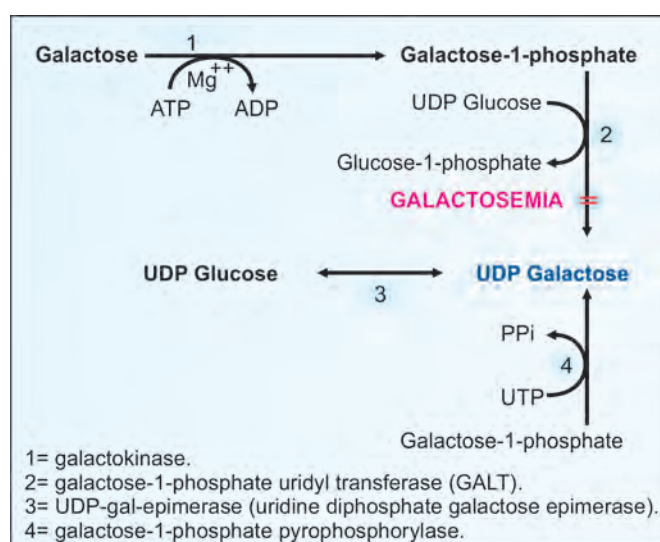


Fig. 11.2: Summary of galactose metabolism

## Galactosemia

1. There is deficiency of enzyme **galactose-1-phosphate uridyl transferase**. It is an inborn error of metabolism. The incidence is 1 in 35,000 births. Herman Kalckar described it in 1958.
2. Due to the block in this enzyme, galactose-1-phosphate will accumulate in liver. This will inhibit galactokinase as well as glycogen phosphorylase. **Hypoglycemia** is the result (Box 11.1).
3. Bilirubin uptake is less and bilirubin conjugation is reduced; so **unconjugated bilirubin** level is increased in blood (for bilirubin, see Chapter 21).
4. There is enlargement of liver, jaundice and severe **mental retardation**.
5. Free galactose accumulates, leading to **galactosemia**. It is partly excreted in urine (**galactosuria**).
6. Galactose is reduced to dulcitol (see Chapter 6). The accumulation of dulcitol in the lens results in cataract due to its osmotic effect. This is called **congenital cataract** and is a very characteristic feature of galactosemia.
7. Galactose-1-phosphate may get deposited in renal tubules, producing tubular damage leading to generalized **amino aciduria**. These salient clinical findings are summarized in Figure 11.3.
8. **Diagnosis:** Clinical manifestation including *congenital cataract* and *presence of galactose* in

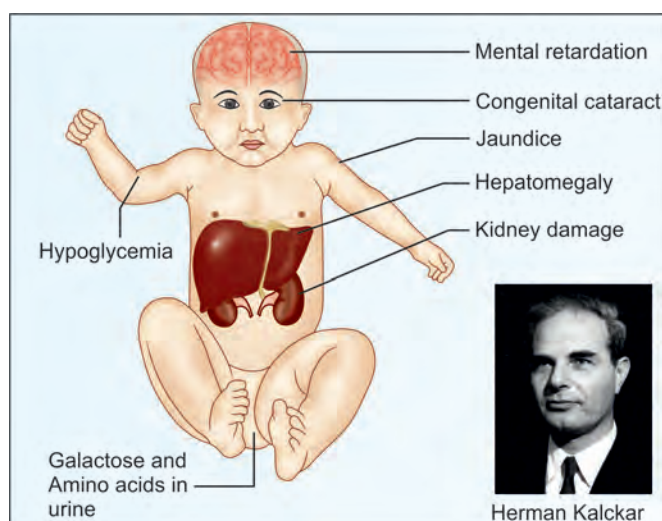


Fig. 11.3: Clinical features of galactosemia



urine as well as elevated blood galactose levels will help in the diagnosis. Collection of fetal cells by **amniocentesis** may be useful in prenatal diagnosis. Heterozygous parents could be detected by elevated galactose level in blood after a galactose load.

- Treatment:** If lactose is withdrawn from the diet, most of the symptoms recede. But mental retardation, when established, will not improve. Hence early detection is most important. For affected infant **lactose-free diet** is given. Such special diets may be withdrawn after 4 years, when galactose-1-phosphate pyrophosphorylase (step 4, Fig. 11.2) becomes active.

### Galactokinase Deficiency

A variant of the disease occurs due to the deficiency of galactokinase. But here the symptoms are milder. This is because galactose-1-phosphate is not formed and hence no toxic effects of this compound are manifested. However, cataract is seen. Galactokinase deficiency is reported to be 1 in 40,000 births.

## METABOLISM OF ALCOHOL

Alcohol absorption starts from the stomach itself, but most of it is absorbed by intestine. Only 1% of the ingested alcohol is excreted through the lungs or urine. Major fraction of the alcohol is oxidized in the liver.

### Alcohol Dehydrogenase (ADH)

It is an  $\text{NAD}^+$  dependent cytoplasmic enzyme. It oxidizes ethanol to acetaldehyde (Fig. 11.4). Alcohol dehydrogenase is a dimer and has 6 iso-enzymes. In some individuals the enzyme is mutated. This mutation rate is more in Orientals. In such individuals, alcohol metabolism is slower and even small quantity of alcohol may produce symptoms of intoxication. The enzyme was identified by Bateilli and Stern in 1909.

### Aldehyde Dehydrogenase

The acetaldehyde is further oxidized to acetate by a **mitochondrial**  $\text{NAD}^+$  dependent enzyme (Fig. 11.4). The acetate is then converted to acetyl CoA. The activity of alcohol dehydrogenase is more than aldehyde dehydrogenase. So acetaldehyde accumulates in liver. **Aldehyde is toxic**, which in excess may lead to cell death. The activity of aldehyde dehydrogenase is less in Indians, when compared to Europeans.

### Microsomal Ethanol Oxidizing System (MEOS)

It is another mechanism of detoxification of alcohol. It is cytochrome P450 dependent and is inducible. This accounts for metabolic tolerance of alcohol observed in chronic alcoholics.

Ethanol can be oxidized in liver microsomes to acetaldehyde by a mixed function oxidase. The electron donors are ethanol and  $\text{NADPH}$  by which  $\text{O}_2$  is reduced to water.



MEOS is part of the superfamily of Cytochrome P450, all of which catalyze similar reactions. About 10 gene families and 100 different cytochrome P450 molecules are available. The isoenzyme with highest activity towards ethanol is designated CYP2E1 (2 refers to the gene family, E refers to the subfamily and 1 refers to the particular enzyme). CYP2E1 has higher  $K_m$  for ethanol than Class I ADH (11mM). When the ethanol consumption is high, higher proportion is metabolized by MEOS. Other CYP iso-enzymes also metabolize alcohol and MEOS refers to the combined oxidizing activity of all these.

### Biochemical Alterations in Alcoholism

Both the oxidation steps of alcohol produces  $\text{NADH}$ , resulting in a high  $\text{NADH}/\text{NAD}^+$  ratio. As a result, several metabolic adaptations occur:

- In the cytoplasm, the high  $\text{NADH}$  level favors conversion of pyruvate to lactate, leading to **lactic acidosis**.
- Deficiency of pyruvate leads to inadequate formation of oxaloacetate. This results in depression of gluconeogenesis, leading to **hypoglycemia**.

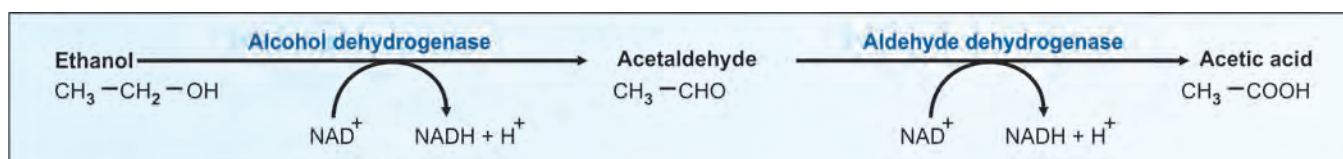


Fig. 11.4: Alcohol metabolism

- iii. Reduced oxaloacetate, decreased pyruvate and high NADH level causes suppression of TCA cycle. So Acetyl CoA is accumulated, which favors **ketogenesis**.
- iv. Increased level of acetyl CoA causes increased fatty acid synthesis; but fatty acid is not oxidized. So fat is accumulated in liver, resulting in **fatty liver** and steatosis.
- v. Alcohol also increases the release of ROS, leading to mitochondrial damage and apoptosis.
- vi. Lactic acidosis causes decreased excretion of uric acid, resulting in acute attack of gout (see Chapter 43).
- vii. Alcohol causes **CNS depression** by inhibiting excitatory receptors (N-methyl aspartate receptors) and by potentiating inhibitory neurotransmitter (GABA) receptors.
- viii. In pregnancy, alcohol consumption leads to fetal alcohol syndrome (FAS).

## Chronic Alcoholism

Differences in ethanol metabolism may determine whether an individual becomes a chronic alcoholic, develops alcohol induced liver disease or other diseases related to alcohol ingestion like cancers of the liver, lungs or breasts. Genotypes, drinking history, gender, quantity, etc. are the factors which influence alcohol metabolism.

### Alcoholism and Liver

- i. Accumulation of fat in liver cells leading to **fatty liver**. Accumulated toxic effect of acetaldehyde leads to cellular death.
- ii. This is followed by replacement by fibrous tissue. Fibrosis of liver is called **Cirrhosis**. When liver functions are reduced (see Chapter 26) hepatic coma results.
- iii. Elimination rates of ethanol vary among individuals and populations. Susceptibility to alcohol is a complex function of genetics and socioeconomic factors. Possession of an allele that encodes a relatively fast ADH (alcohol dehydrogenase) is associated with a decreased susceptibility. A single amino acid substitution (Glu487 by Lys) produces a variant ALDH (Aldehyde dehydrogenase) with high  $K_m$  (260 times) and low affinity for acetaldehyde.  $V_{max}$  is also reduced 10 times. This enzyme is very inactive. Homozygotes for this variant afford absolute protection against alcoholism.
- iv. Five percent of all deaths in India are due to liver diseases, for which the most important culprit is

alcohol. In India, chronic alcoholism is the most leading cause for morbidity and consequent loss of man hours. The activity of mitochondrial aldehyde dehydrogenase is less in Asians compared to western population. Hence, *Indians are more prone for alcoholic cirrhosis*.

- v. Acetaldehyde can further produce adducts with proteins and other components. Amino groups, sulfhydryl groups, nucleotides and phospholipids are commonly targeted. Free radicals including hydroxyethyl radicals can produce irreversible liver damage.

### Alcoholism and Nervous System

In chronic alcoholics, the brain ventricles are enlarged, neurons are lost, neurodegenerative changes set in and memory is affected. In alcoholics, combined thiamine deficiency leads to **Wernick's disease**. Aldehyde inhibits pyridoxal phosphate; hence neuritis is very common in alcoholics (see Chapter 37).

### Alcohol and Cardiovascular System

There are reports stating that mild alcohol intake (red wine less than 20 mg per day) will reduce attacks of myocardial infarction. But this minor benefit on heart far outweighs the drastically deleterious effects of alcohol on liver.

### Laboratory Findings in Chronic Alcoholism

- i. Increase in serum levels of gamma-glutamyl transferase (GGT) and alanine transaminase (ALT) (see Chapter 23).
- ii. Decrease in aldehyde dehydrogenase activity (in liver cells and RBCs) is the best marker for alcohol abuse.
- iii. **Disialotransferrin** (sialic acid groups are removed from transferrin) level in blood is a highly sensitive marker for chronic alcohol abuse.

The important markers for monitoring alcoholism are gamma glutamyl transpeptidase (GGTP), serum glutamate dehydrogenase (GDH), serum disialotransferrin and RBC acetaldehyde dehydrogenase (ALDH).

Alcohol dependence and alcohol abuse cause substantial morbidity and mortality. Alcohol-abuse is associated with depression, severe anxiety, insomnia, suicide, heart disease, stroke, cancers, liver cirrhosis, amnesia, temporary cognitive deficits, sleep problems, and peripheral neuropathy; gastrointestinal problems; decreased bone density, production of blood cells and fetal alcohol syndrome. Hyperuricemia and gout are exacerbated by alcohol.

Causes for alcohol dependence include environmental factors and specific genes that affect the risk of alcohol-use disorders, including genes for enzymes that metabolize alcohol, such as alcohol dehydrogenase and aldehyde dehydrogenase; those that confer a low sensitivity to alcohol.

## METABOLISM OF AMINO SUGARS

The amino sugars, N-acetyl glucosamine, N-acetyl galactosamine and N-acetyl neuraminic acid are synthesized from fructose-6-phosphate. The amino group is derived from amide group of **glutamine**. The reaction is catalyzed by an amido transferase. This is irreversible; it is the **rate limiting step** in amino sugar synthesis.

The glucosamine-6-phosphate is then acetylated by acetyl CoA to form N-acetyl glucosamine-6-phosphate. The active form of amino sugar, namely, UDP-N-acetyl glucosamine is formed from N-acetyl glucosamine-1-phosphate, with the help of a mutase and a pyrophosphorylase. It is then epimerized to galactose derivative.

Both these are used for synthesis of glycosaminoglycans and gangliosides. Mannose (6C) and pyruvate (3C) combines to form 9C compound, N-acetyl neuraminic acid (NANA). The steps are outlined in Figure 11.5.

Lysosomal storage disorders due to defective degradation of GAG are called Mucopolysaccharidoses. The major features of different types of such disorders are given in Table 11.1. All amino sugars are derived from glucose (Fig.11.6).

## GLYCOPROTEINS

**Glycobiology** is the study of the sugars in health and disease. The **glycome** is the entire component of sugars in the cell. **Glycomics** is the comprehensive study of the carbohydrates in its entire aspects. Lectins (see Chapter 4) can be used to isolate and purify glycoproteins.

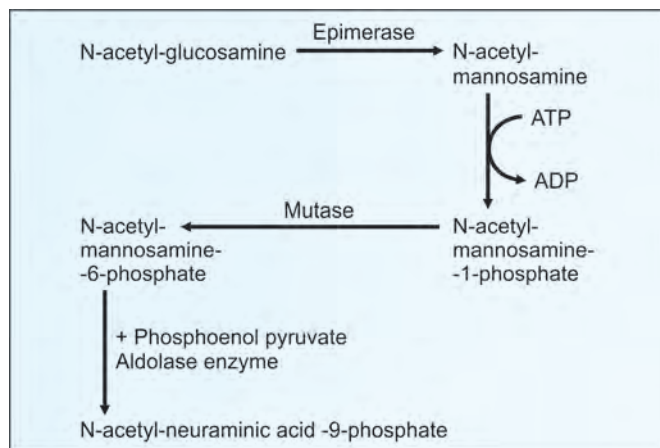


Fig. 11.5: Synthesis of N-acetyl neuraminic acid (NANA)

Glycoproteins have a protein backbone to which oligosaccharide groups are attached. Only 8 monosaccharides are commonly found in such side chains; some of them will be further acetylated or sulfated. These are glucose, galactose, mannose, galNAc, gluNAc, xylose, fucose and N-acetyl neuraminic acid (sialic acid).

**Proteoglycans** are complexes of glycosamino glycans and proteins. As the carbohydrate content is increased, viscosity is increased and solubility is decreased. The carbohydrate content of mucins is generally more than 50%. **Mucus** consists of 5–10% of mucins. These monomers are further linked together by disulfide linkages, to form oligomers. **Mucins** will form a protective barrier on epithelial surfaces. They are also found in secretions of the gastrointestinal, respiratory and urogenital tract.

Depending on the sialic acid content, the electric charges also vary. Glycoproteins are widely distributed in tissues. All plasma proteins are glycoproteins. Examples are given in Table 11.3.

In glycoproteins, the carbohydrate groups are attached to the polypeptide chain by the following types of linkages:

- Through the amide group of asparagine to N-acetyl glucosamine (**N-glycosidic** linkages). (The biosynthesis of N-linked glycoproteins involves Dolichol phosphate. **Dolichol** is a polyisoprenol, containing about 20 repeating isoprenoid units.) Dolichol is activated to Dol-P-P-GluNAc; this is the starting point, over which other carbohydrate units are added. **Tunicamycin** specifically inhibits N-glycosylation by inhibiting the transferase which adds GluNAc to dolichol-phosphate.
- Through hydroxyl group of serine, threonine, hydroxylysine and hydroxyproline to N-acetyl glucosamine or galactose or xylose (**beta-O-glycosidic** linkages). Glycosylation occurs in Golgi

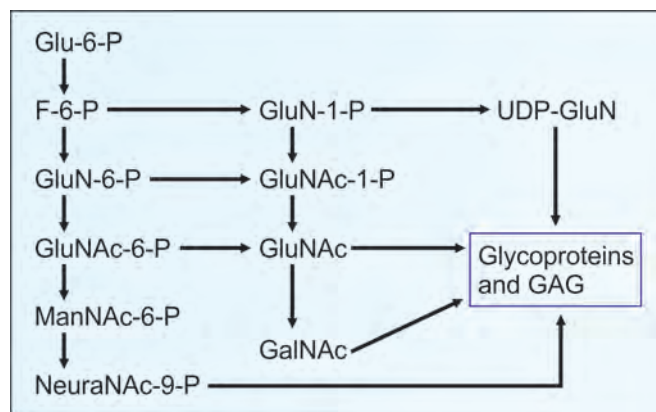


Fig. 11.6: Interrelations of amino sugars

P= phosphate; G= glucose; F= fructose; gluN= glucosamine; Neura = neuraminic; NAc = N-acetyl; UDP = uridine diphosphate; GAG = glycosamino glycans

bodies and only proteins that are glycosylated and properly folded are exported.

- c. Linked to carboxyl terminal amino acid of the protein via phosphoryl-ethanolamine, which is linked to a phosphatidyl inositol, which in turn is linked to a glucosamine in the glycan group. This is called **glycosyl phosphatidyl inositol (GPI)** linkage. Some proteins are anchored to the plasma membrane by glycosyl phosphatidyl inositol (GPI) linked proteins.

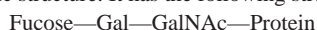
There can be many (usually 20–30) oligosaccharide chains attached to a single protein. Each sugar chain may range from 1 to 20 in length.

Enzymatic addition of specific carbohydrate unit on the protein is called **glycosylation**, while non-enzymatic spontaneous addition is called **glycation**. Proteins with identical amino acid sequences, but having different oligosaccharide sequences are called **glycoforms**.

Glycoproteins function as recognition sites on cell surfaces. The carbohydrate containing uppermost layer of plasma membrane is known as **glycocalyx**.

### Blood Group Substances (Antigens)

The RBC membrane contains several antigenic substances, based on which persons are classified into different blood groups. More than 160 different antigens are known. Of these, ABO system and Lewis system are known to involve glycoproteins. ABO system is associated with 3 blood group substances on RBCs designated A, B and H antigens. The **H antigen** is the basic structure. It has the following structure:



The RBCs carrying such H antigen are denoted as blood group O. A and B antigens differ from this in having additional sugar residues.

A antigen: – Fucose—Gal—GalNAc—Protein



B antigen: – Fucose—Gal—GalNAc—Protein



The H locus codes for fucosyl transferase. In a person belonging to blood group A, N-acetyl-galactosaminyl transferase is present. In group B person, galactosyl transferase is seen. Lack of both leads to blood group O, while AB persons have both enzymes.

### Selectins, Integrins and ICAMs

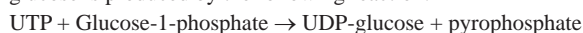
Leukocytes generally pass over endothelial surface of blood vessels. When necessity arises, leukocytes can attach over the endothelial surface, then pass through junctions between endothelial cells, so as to reach extravascular compartment. This attachment involves interaction between selectins or integrins on the leukocytes and ICAM (intracellular adhesion molecule) present on the endothelial cells. The selectins are glycoproteins and the corresponding receptors on the endothelial surface will have lectin type domains. There are different types of selectins and integrins.

## Proteoglycans

These are widely distributed complex molecules having glycosaminoglycans (GAG) and proteins (Table 11.4). The GAGs containing repeating disaccharide units are covalently bound to the peptide chain to form proteoglycans. Structures of the repeating sugar units are shown in the end of Chapter 6. The different GAGs found in different tissues are shown in Table 11.1.

### Biosynthesis of Glycoproteins

The **biosynthesis** of GAG is taking place in endoplasmic reticulum and Golgi bodies, with the help of specific glycosyl transferases. Along with protein is synthesized, at the endoplasmic reticulum, these carbohydrate units are added one by one. Certain amino acid sequences in the protein will code for the attachment of the glycans; specific enzymes will add the glycans sequentially. This addition needs activation of sugar; activation is in the form of corresponding nucleotide sugar. For example, UDP-glucose is utilized for addition of glucose to the protein back-bone. UDP glucose is produced by the following reaction:



The enzyme is UDP-glucose pyrophosphorylase.

**TABLE 11.1: Features of mucopolysaccharidoses**

Type	Eponym	Deficient enzyme	Clinical findings
I	Hurler's	L-Iduronidase	MR <sup>+++</sup> ; Skeletal deformity <sup>++</sup> ; Corneal opacity <sup>++</sup> ; DS and HS in urine
II	Hunter's	Iduronate sulfatase	MR <sup>+</sup> ; Skeletal deformity <sup>++</sup> ; deafness; no corneal clouding; DS and HS in urine
III	Sanfilippo's	N-Acetyl glucosaminidase, Heparan sulfatase	MR <sup>++</sup> ; Skeletal deformity <sup>+</sup> ; corneal clouding <sup>+</sup> ; HS in urine; 3 different types are reported
IV	Morquio's	Galactosamine sulfatase, $\beta$ -D-galactosidase	MR <sup>+</sup> ; Skeletal deformity <sup>+</sup> ; epiphyseal dysplasia <sup>+</sup> ; Corneal opacity <sup>+</sup> ; KS and CS in urine; 2 types reported
V	Scheie's	L-Iduronidase	No MR; Mild skeletal changes; corneal opacity <sup>++</sup> ; DS in urine
VI	Maroteaux-Lamy's	N-Acetyl- $\beta$ -D-Galactosamino-4-Sulfatase	Skeletal deformity <sup>+++</sup> ; corneal opacity <sup>++</sup> ; No MR; DS in urine
VII	Sly's	$\beta$ -Glucuronidase	MR <sup>+</sup> ; DS and HS in urine

MR = mental retardation;  
KS = keratan sulfate;  
DS = dermatan sulfate

CS = chondroitin sulfate;  
HS = heparan sulfate;



There are carrier systems (transporters) to transport nucleotide sugars across Golgi membrane. Termination of the oligosaccharide chain occurs following sulfation of the sugar residues.

The glycoproteins having mannose-6-P as the end residue will be directed to lysosomes. Mannose phosphate acts as the tag to deliver such glycoproteins into lysosomes. Defect in this correct tagging will lead to defective **targeting**. See I-cell disease, described in Chapter 46.

**Calnexin** and **Calreticulin** are proteins present in the endoplasmic reticulum membrane that act as chaperones for correct folding of glycoproteins, and also preventing aggregation of glycans. Only the correctly folded glycoproteins are secreted out of endoplasmic reticulum.

### Congenital Disorders of Glycosylation (CDG)

These are an emerging group of autosomal recessive disorders. They are multisystem disorders, mostly affecting CNS, with mental retardation. At least 15 distinct disorders in this group have been reported.

### Leukocyte Adhesion Deficiency (LAD)

It is due to mutation affecting Golgi fucose transporter. So, selectins are not correctly glycosylated, resulting in sluggish activity of leukocytes.

### Paroxysmal Nocturnal Hemoglobinuria (PNH)

There is somatic mutations in PIG (phosphatidylinositol glycan) gene in hematopoietic cells. The product of this gene is necessary for GPI linkage. So, GPI linked proteins are deficient on the RBCs. During sleep, there is a slight drop in pH of blood, causing mild RBC lysis by complement factors, which leads to excretion of hemoglobin in urine. Normal persons can withstand this lysis with the help of GPI linked proteins, termed decay accelerating factor (DAF).

### Rheumatoid Arthritis

There is altered glycosylation of circulating immunoglobulin G, these are aglycosyl IgG molecules. These will activate complement system, causing chronic inflammation of synovial membranes of joint cavities.

### Viruses

Many viruses will attach on human cells through specific glycoproteins. HIV virus (causing AIDS), attaches on lymphocytes by means of a surface glycoprotein (gp120) of the virus (see Chapter 56). Influenza virus attaches by hemagglutinin (H). So neuraminidase inhibitors are used as antiviral drugs against H1N1. *Helicobacter pylori*, causing peptic

**TABLE 11.2:** Inborn errors associated with carbohydrate metabolism

Name	Incidence 1 out of	Defective enzyme	Chromosome location	Salient features	Chapter no.
Glycogen storage disease, Type I (von Gierke's disease)	100,000	Glucose-6-phosphatase	17	Hepatomegaly, cirrhosis, hypoglycemia, ketosis, hyperuricemia	9
Do, type II (Pompe's disease)	175,000	Lysosomal maltase	17	Generalized glycogen deposit; lysosomal storage disease	9
Do, type III (Cori's disease)	125,000	Debranching enzyme	1	Hepatomegaly, cirrhosis	9
Do, type IV (Andersen's disease)	1 million	Branching enzyme	3	Do	9
Do, type V (McArdle's disease)	1 million	Muscle phosphorylase	11	Exercise intolerance	9
Do, type VI (Hers' disease)	1 million	Liver phosphorylase	14	Hepatomegaly, hypoglycemia	9
Do, type VII (Tarui's disease)	1 million	Phosphofructokinase	1		9
Do, type VIII	125,000	Phosphorylase kinase	X-linked		9
Lactose intolerance		Lactase		Milk induced diarrhea	8
Fructose intolerance	20,000	Aldolase B	9	Hypoglycemia, vomiting, hepatomegaly	11
Fructosuria	130,000	Fructokinase		Benign; urine sugar	11
Galactosemia	35,000	Gal-1-P-uridyl transferase	9	Hypoglycemia; hepatomegaly; mental retardation; jaundice; congenital cataract	11
Do, variant	40,000	Galactokinase	17	Congenital cataract	11
Essential pentosuria	2,500	Xylitol dehydrogenase		Benign	11
PC deficiency	25,000	Pyruvate carboxylase	11	Mental retardation	9
GPD deficiency	5,000	Glucose-6-phosphate dehydrogenase	X-linked	Drug-induced hemolytic anemia	9
HK deficiency		Hexokinase		Hemolytic anemia	9
PK deficiency		Pyruvate kinase		Hemolytic anemia	9
PDH deficiency	250,000	Pyruvate dehydrogenase		Neuronal loss in brain; muscular hypotonia; lactic acidosis	9

ulcer, binds through two different glycoproteins present on the epithelial cells of stomach. *Plasmodium falciparum* (parasite causing malaria) attaches to human cells by a glycoprotein on the surface of the parasite.

### Catabolism of Glycoproteins

The catabolism is by hydrolases which are bond specific. Deficiency of these enzymes would result in marked accumulation of substrates (Table 11.1). The half-life of many proteins in circulation is determined by the glycosylation. This is a potential area for therapeutics, where carbohydrate side chains are removed (asialo glycation), and the half-life of protein drugs could be enhanced.

### Mucopolysaccharidoses

These are a group of inborn errors of metabolism characterized by excessive **intralysosomal accumulation** of GAG in various tissues. They are progressive disorders. The clinical manifestations include coarse facial features, thick skin and corneal opacity due to accumulation of GAG.

**Mental retardation**, growth deficiency and skeletal dysplasia are also seen due to defective formation of ground substances. In general, defective degradation of heparan sulfate leads to mental retardation predominantly whereas accumulation of other GAGs leads to mesenchymal abnormalities. A characteristic finding is the excessive excretion of any one of the GAGs in urine. All these diseases are inherited as autosomal recessive traits, except Hunter's disease, which is X-linked (Table 11.1).

The inborn errors associated with carbohydrate metabolism, are shown in Table 11.2.

### Clinical Case Study 11.1

A 2-year-old child presented with liver enlargement. Investigations showed the following results: Blood sugar – 50 mg%, Uric acid – 10 mg%, Lactic acid – 15mg%, Plasma cholesterol – 300 mg% and ketone bodies were present. What is the likely diagnosis? What is the biochemical basis of the disorder and its treatment?

**TABLE 11.3: Functions of glycoproteins**

Function	Example of glycoprotein
Structural substance	Collagen, bacterial cell walls
Enzymes	Ribonuclease-B, Prothrombin
Transport proteins	Ceruloplasmin, Transferrin
Hormones	Thyroglobulin, Erythropoietin, TSH
Immunity	Immunoglobulins, Blood group
Lubricant	Mucin
Message transfer	Receptor proteins on cell surfaces
Cell adhesion	Selectins and integrins

### Clinical Case Study 11.2

A 3-year-old boy is brought to the emergency department after several episodes of vomiting and lethargy. His pediatrician has been concerned about his failure to thrive and possible hepatic failure along with recurrent episodes of the vomiting and lethargy. After a careful history is taken, it is found that these episodes occur after ingestion of certain types of food, especially high in fructose. His blood sugar was checked in the emergency department and was extremely low.

1. What is the most likely diagnosis?
2. What is the biochemical basis for the clinical symptoms?
3. What is the treatment of the disorder?

### Clinical Case Study 11.3

A 10-year-old child was brought to the OP Department with complaints of constant dribbling of thick mucus from mouth and not responding to surroundings. Clinical history revealed delayed developmental milestones since 2 years of age. The child has coarse facial features and thick mucus and skeletal deformities. Urinalysis revealed presence of heparan sulfate and dermatan sulfate. What is the probable diagnosis? What is the biochemical basis of this disorder?

### Clinical Case Study 11.4

A middle aged man complained of fatigue. There was vague abdominal pain. On examination, there was enlargement of the liver. Laboratory results obtained were as follows – Serum AST – 120 U/L, ALT – 80 U/L, ALP – 68 U/L, GGT – 170 U/L, Bilirubin – 1.0 mg/dL, glucose – 60 mg/dL, Uric acid – 8.0 mg/dL. CBC and urinalysis were normal. What is the diagnosis? Interpret the biochemical data on the basis of your diagnosis.

**TABLE 11.4: Glycosaminoglycans**

GAG	Repeating sugar units	Linkage	Tissues
Hyaluronic acid	N-Acetyl glucosamine and Glucuronic acid	$\beta$ -1,3	Synovial fluid, vitreous humor
Chondroitin sulphate	N-Acetyl galactosamine Glucuronic acid	$\beta$ -1,3	Cartilage, bone, cornea
Keratin sulphate Types I and II	N-Acetyl glucosamine and Galactose	$\beta$ -1,4	Cornea, cartilage
Heparan	N-Acetyl glucosamine	$\alpha$ -1,4	Skin

### Clinical Case Study 11.1 Answer

Galactosemia. See Figure 11.3 for details. Hypoglycemia causes increased fatty acid catabolism leading to increased acetyl CoA production. This excess acetyl CoA leads to increased synthesis of cholesterol and acetone bodies.

### Clinical Case Study 11.2 Answer

*Diagnosis:* Fructose intolerance.

*Biochemical basis of disorder:* Because of a genetic disorder, the hepatic aldolase B enzyme is defective, and functions normally in glycolysis but not in fructose metabolism. Glucose production is inhibited by elevated fructose-1-phosphate. When fructose is ingested, severe hypoglycemia results.

*Treatment:* Avoid dietary fructose.

*Clinical correlation:* Deficiency of aldolase B is an autosomal recessive disease, leading to fructose intolerance. It does not cause difficulty as long as the patient does not consume any foods with fructose or sucrose. Frequently, children with fructose intolerance avoid candy and fruit. However, if chronically exposed to fructose-containing foods, infants and small children may have poor weight gain and abdominal cramping or vomiting.

### Clinical Case Study 11.3 Answer

Diagnosis is Hurler's syndrome, a type of mucopolysaccharidoses (MPS-I). There is deficiency of  $\alpha$ -L-Idurionidase. This leads to defective degradation of dermatan sulphate and heparan sulphate. They accumulate in tissues and are also excreted in urine. Clinical features include progressive deterioration, hepatosplenomegaly, progressive mental retardation, coarse facial features, loss of physical skills, hearing loss (conductive hearing loss) and language problems, skeletal deformities (including disproportionate growth of trunk and extremities), etc. These children often die by 10 years of age.

Urine analysis for Mucopolysaccharides is diagnostic in these patients. Urine cetyl trimethyl ammonium bromide test for mucopolysaccharides is positive. Absence of  $\alpha$ -L-Idurionidase in WBC is diagnostic. Treatment options are bone marrow transplantation and umbilical cord blood transplantation, before 18 months of age. There is no cure for the disease. Gene therapy trials and enzyme replacement therapies are ongoing. These options are partially beneficial (Please see Table 11.1 for further details).

### Clinical Case Study 11.4 Answer

The patient has alcohol related liver disease. Hypoglycemia and hyperuricemia are due to alcoholism. Alcoholism is associated with fatty liver, hepatitis and cirrhosis. High GGT also points towards a diagnosis of alcoholism. There can be acute or chronic inflammation and parenchymal necrosis, which is often reversible.

Fatty liver is caused by impaired fatty acid oxidation and increased lipogenesis, due to changes in [NADH]/[NAD] ratio in liver. Oxidation of alcohol by alcohol dehydrogenase leads to increased NADH. This NADH can compete with other substrates like fatty acids for the respiratory chain, inhibiting their oxidation and causing increased esterification of fatty acids to form triglycerides and causing fatty liver. Oxidation of ethanol produces acetaldehyde and acetate. Increased [NADH]/[NAD] ratio also causes increased [lactate]/[pyruvate] ratio leading to elevated lactate, which decreases uric acid excretion aggravating gout.

In alcoholism, usually ALT is higher than AST (Please note that in this patient it is not the case), GGT is high and ALP may be normal. Serum bilirubin may be high, serum proteins may be reduced, and hypoglycemia, hyperuricemia, ketosis and metabolic acidosis may be seen. Fasting hypoglycemia is due to high lactate and low pyruvate. Level of  $\beta$  hydroxy butyrate is elevated due to high NADH leading to ketosis. Ketoacidosis and lactic acidosis are accompanying features.

## QUICK LOOK OF CHAPTER 11

1. Deficiency of aldolase B enzyme leads to an inborn metabolic disorder termed hereditary fructose intolerance (HFI).
2. Deficiency of galactose-1-phosphate uridyl transferase is the cause of galactosemia.
3. Characteristic features of galactosemia are congenital cataract, generalized aminoaciduria, hepatomegaly, jaundice and mental retardation. Lactose-free diet forms the main stay of treatment.
4. Metabolism of alcohol involves two enzymes; alcohol dehydrogenase and aldehyde dehydrogenase.
5. Gamma glutamyl transferase (GGT) is used as a clinical marker of alcoholism.
6. Blood group antigens are glycoproteins.
7. Mucopolysaccharidoses (MPS) are a group of inborn metabolic disorders caused due to accumulation of mucopolysaccharides in tissues. Features include mental retardation.

# CHAPTER 12

## Metabolism of Fatty Acids

### Chapter at a Glance

The reader will be able to answer questions on the following topics:

- Digestion of lipids
- Absorption of lipids
- Chylomicrons
- Beta oxidation of fatty acids
- Oxidation of odd chain fatty acids
- Alpha oxidation
- Omega oxidation
- De novo synthesis of fatty acids
- Synthesis of triglycerols
- Metabolism of adipose tissue
- Fatty liver and lipotropic factors
- Ketogenesis and ketolysis

### DIGESTION OF LIPIDS

The major dietary lipids are triacylglycerol, cholesterol and phospholipids. The average normal Indian diet contains about 20–30 g of lipids per day. Western diet generally contains two or three times more than this quantity.

#### Digestion in Stomach

The **lingual lipase** from the mouth enters stomach along with the food. It has an optimum pH of 2.5 – 5. The enzyme therefore continues to be active in the stomach. It acts on short chain triglycerides (SCT). SCTs are present in milk, butter and ghee. The action of lingual lipase is observed to be more significant in the newborn infants. **Gastric lipase** is acid stable, with an optimum pH about 5.4. It is secreted by Chief cells, the secretion is stimulated by Gastrin. Up to 30% digestion of triglycerides occurs in stomach.

#### Digestion in Intestines

**Emulsification** is a pre-requisite for digestion of lipids. The lipids are dispersed into smaller droplets; surface tension is reduced; and surface area of droplets is increased. This process is favored by:

1. Bile salts (detergent action)
2. Peristalsis (mechanical mixing)
3. Phospholipids.

#### Bile Salts are Important for Digestion of Lipids

The bile salts present in the bile (sodium glycocholate and sodium taurocholate) **lower surface tension**. They emulsify the fat droplets. The emulsification increases the surface area of the particles for enhanced activity of enzymes (Fig. 12.2).



## Lipolytic Enzymes in Intestines

1. **Pancreatic lipase** with co-lipase
2. Cholesterol esterase
3. Phospholipase A<sub>2</sub>.

The bile (pH 7.7) entering the duodenum serves to neutralize the acid chyme from the stomach and provides a pH favorable for the action of pancreatic enzymes. A list of physiologically important lipases is shown in Table 12.1.

## Digestion of Triacylglycerols

1. **Pancreatic lipase** can easily hydrolyze the fatty acids esterified to the 1st and 3rd carbon atoms of glycerol forming 2-monoacylglycerol and two molecules of fatty acid (Fig. 12.1).
2. Then an **isomerase** shifts the ester bond from position 2 to 1. The bond in the 1st position is then hydrolyzed by the **lipase** to form free glycerol and fatty acid (Fig. 12.1).

TABLE 12.1: Physiologically important lipases			
Lipase	Site of action	Preferred substrate	Product(s)
Lingual/acid-stable lipase	Mouth, stomach	TAGs with short and medium chain FAs	FFA+DAG
Pancreatic lipase + co-lipase	small intestine	TAGs with long-chain FAs	FFA+2MAG
Intestinal lipase with bile acids	small intestine	TAGs with medium chain FAs	3 FFA+ glycerol
Phospholipase A <sub>2</sub> + bile acids	small intestine	PLs with unsat. FA on position 2	Unsat FFA Lysolecithin
Lipoprotein lipase	capillary walls	TAGs in chylomicron or VLDL	FFA+ glycerol
Hormone sensitive lipase	adipocytes	TAG stored in adipose tissue	FFA+ DAG

3. The major end products of the digestion of TAG are 2-MAG (78%), 1-MAG (6%), glycerol and fatty acids (14%). Thus digestion of TAG is partial (incomplete).
4. **Cholesterol** ester may be hydrolyzed to free cholesterol and fatty acid. The action of **phospholipase A<sub>2</sub>** produces lysophospholipid and a fatty acid (see Fig. 7.8).

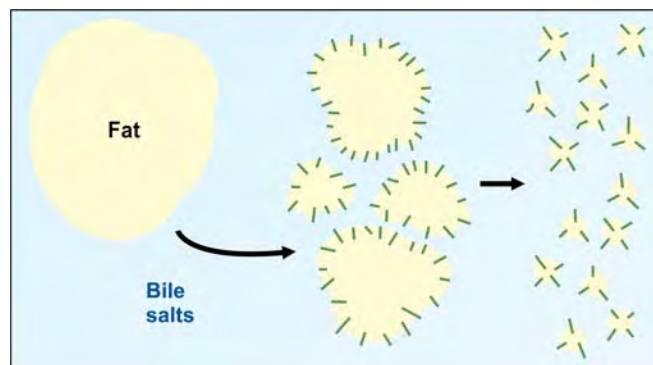
## Co-lipase

The binding of co-lipase to the triacylglycerol molecules at the oil water interface is obligatory for the action of lipase. The co-lipase is secreted by the pancreas as an inactive zymogen (molecular weight 11,000). It is activated by trypsin.

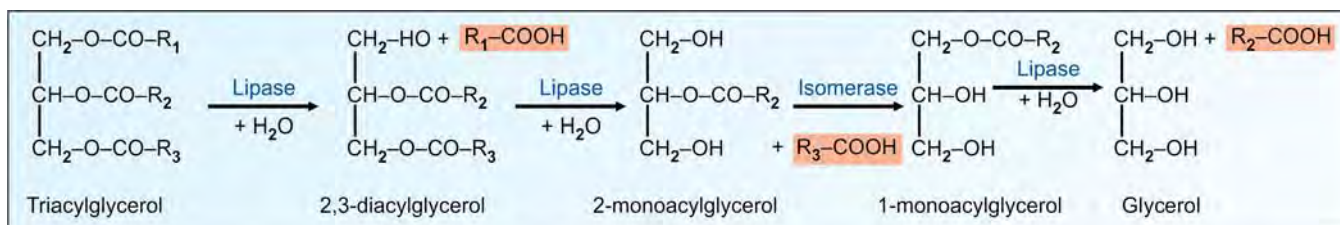
## ABSORPTION OF LIPIDS

### Absorption of Long Chain Fatty Acids

Long chain fatty acids (chain length more than 14 carbons) are absorbed to the lymph and not directly to the blood. The theory proposed by **Bergstrom** (Nobel Prize, 1982) has the following steps.



**Fig. 12.2:** Action of bile salts. The hydrophobic portions of bile salts intercalate into the large aggregated lipid, with the hydrophilic domains remaining at the surface. This leads to breakdown of large aggregates into smaller and smaller droplets. Thus the surface area for action of lipase is increased



**Fig. 12.1:** Complete hydrolysis of triglyceride. In the intestines, generally fats are only partially hydrolyzed

### Mixed Micelle Formation

- The products of digestion, namely 2 monoacylglycerols, long chain fatty acids, cholesterol, phospholipids and lysophospholipids are incorporated into molecular aggregates to form **mixed micelle**. (Fig. 12.3). The micelles are spherical particles with a hydrophilic exterior and hydrophobic interior core (Fig. 12.3). Due to their amphipathic nature, the **bile salts** help to form micellar aggregates.
- Micellar formation is essential for the absorption of fat-soluble vitamins such as vitamin A, D and K.
- The micelles are aligned at the microvillous surface of the **jejunal mucosa**. Fatty acids, 2-MAG and other digested products passively diffuse into the mucosal cell (Fig. 12.4).

### Enterohepatic Circulation of Bile Salts

The bile salts are left behind which are mostly reabsorbed from the ileum and returned to the liver to be re-excreted (enterohepatic circulation). About 98% of dietary lipids are normally absorbed.

### Re-esterification Inside the Mucosal Cell

- Once inside the intestinal mucosal cell, the long chain fatty acids are re-esterified to form triacylglycerols (Fig. 12.5).
- The fatty acids are first activated to fatty acyl CoA by the enzyme, **acyl CoA synthetase** or thiokinase (Fig. 12.9). This needs lysis of two high energy bonds.
- Two such activated fatty acids react with monoacylglycerol (MAG) to form the triacylglycerol. Majority

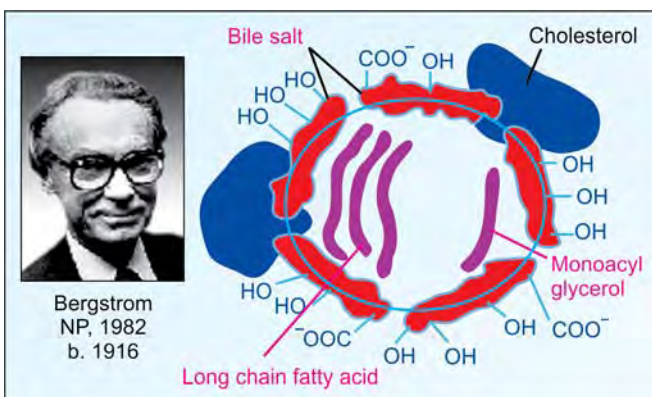


Fig. 12.3: Micellar formation

of molecules follow this MAG pathway (Figs 12.4 and 12.5).

- Free **glycerol** absorbed from intestinal lumen directly enters into the bloodstream. So free glycerol is not available for re-esterification. But the cells can derive glycerol phosphate from glucose by glycolysis, and add 3 molecules of acyl groups to synthesize TAG.

### Chylomicrons

The TAG, cholesterol ester and phospholipid molecules along with apoproteins B48, and apo-A are incorporated into chylomicrons (Fig. 12.6). The chyle (milky fluid) from the intestinal mucosal cells loaded with chylomicrons are transported through the lacteals into the thoracic duct and then emptied into systemic circulation (Fig. 12.5). The serum may appear milky after a high fat meal (post-prandial lipemia) due to the presence of chylomicrons in circulation. Normally the lipemia clears within a few hours by the uptake of chylomicrons by tissues. The major steps of lipid absorption are shown in Box 12.1.

### SCFA Absorption is Different

- Short chain** fatty acids (SCFA) (seen in milk, butter, ghee) and **medium chain** fatty acids (MCFA) (in coconut oil and mother's milk) do not need re-esterification.

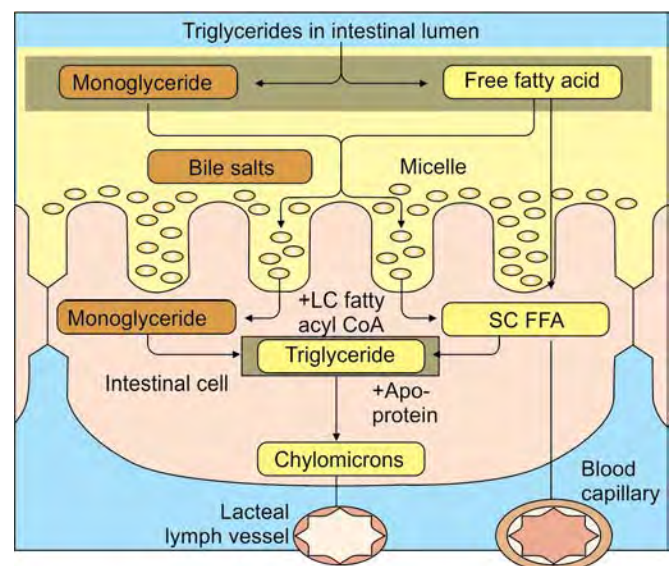


Fig. 12.4: Digestion and absorption of triglycerides

LC = long chain; SC FFA = short chain free fatty acid. Triglycerides with long chain fatty acids are absorbed into lymph vessels as chylomicrons. Short chain fatty acids directly enters portal vein (blood vessel).

- ii. They can directly enter into blood vessels, then to portal vein, finally to liver where they are immediately utilized for energy (Fig. 12.5).
- iii. Their absorption is rapid. They are better absorbed than long chain fatty acids. Peculiarities in digestion and absorption of medium chain fatty acids are given in Table 14.1.

### Abnormalities in Absorption of Lipids

1. **Defective digestion:** In steatorrhea, daily excretion of fat in feces is more than 6 g per day. (Greek word,

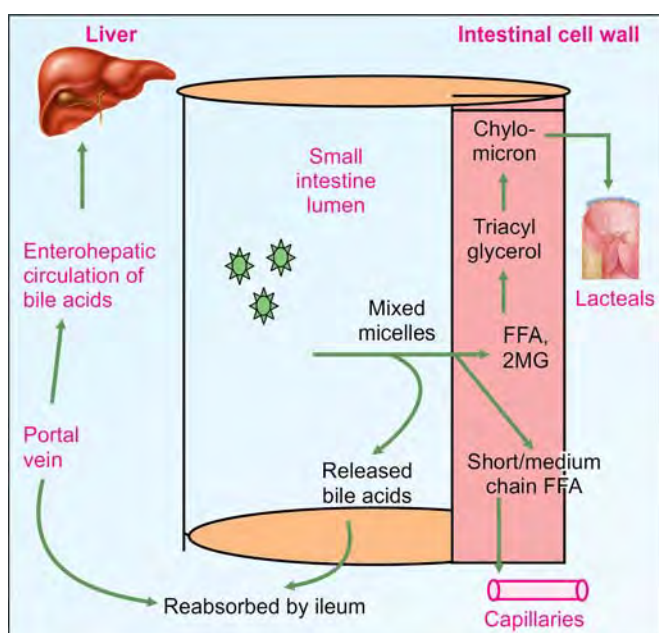


Fig. 12.5: Absorption of fatty acids

Long chain fatty acids are absorbed into the intestinal cell wall, where they are re-esterified, made into chylomicrons and enter into lymphatics. Short chain fatty acids are directly absorbed into blood capillaries. Bile acids are reabsorbed into portal vein.

#### Box 12.1: Six steps of lipid absorption

1. **Minor digestion** of triacylglycerols in mouth and stomach by lingual (acid-stable) lipase
2. **Major digestion** of all lipids in the lumen of the duodenum/ jejunum by pancreatic lipolytic enzymes
3. **Bile acid** facilitates formation of mixed micelles
4. **Passive absorption** of the products of lipolysis from the mixed micelle into the intestinal epithelial cell
5. **Re-esterification** of 2-monoacylglycerol with free fatty acids inside the intestinal enterocyte
6. **Assembly** of chylomicrons containing Apo B48, triacylglycerols, cholesterol esters and phospholipids and **export** from intestinal cells to the lymphatics.

"steat", means fat). It is due to chronic diseases of pancreas. In such cases, unsplit fat is seen in feces (Box 12.2).

2. **Defective absorption:** On the other hand, if the absorption alone is defective, most of the fat in feces may be split fat, i.e. fatty acids and monoglycerides. (Box 12.2). Defective absorption may be due to diseases:

A. **Celiac** disease, sprue, Crohn's disease.

B. **Surgical removal** of intestine.

C. **Obstruction of bile duct:** This may be due to gallstones, tumors of head of pancreas, enlarged lymph glands, etc. The result is deficiency of bile salts. In such cases, triglycerols with short chain and medium chain fatty acids (SCT and MCT) are digested and absorbed properly, because they do not require micellerization for absorption. Since milk fat and coconut oil are made up of MCT, they are therapeutically useful in malabsorption syndromes.

3. **Chyluria.** There is an abnormal connection between the urinary tract and lymphatic drainage system of the intestine. Urine appears milky due to lipid droplets. **Chylothorax** can result from an abnormal connection between the pleural cavity and thoracic duct.

Chyluria can occur due to filariasis. Hematochyluria results when blood mixes with urine. Usually it is self limiting; if cause is filariasis it has to be treated. Left untreated, chronic chyluria can lead to micronutrient deficiencies.

### Fate of Chylomicrons

- i. The absorbed (exogenous) triglycerols are transported in blood as **chylomicrons**. They are taken up by adipose tissue, skeletal muscle and liver.
- ii. Liver synthesizes endogenous triglycerols. These are transported as **VLDL** (very low density lipoproteins) and are transported to adipose tissue.
- iii. During states of starvation, triacylglycerols in adipose tissue are hydrolyzed to produce **free fatty acids**. In the blood, they are transported, complexed with albumin.

#### Box 12.2. Absence of digestive juices

1. **In pancreatic deficiency:** Steatorrhea; unsplit fat is present in stools
2. **When bile is not available:** Absorption is defective; split fat is present in stools; defective absorption of vitamin K leads to prolonged prothrombin time.



These free fatty acids are taken up by the cells, and are then oxidized to get energy. A summary of lipid transport is shown in Figure 12.6.

## BETA OXIDATION OF FATTY ACIDS

This process is known as beta-oxidation, because the oxidation and splitting of **two carbon** units occur at the beta-carbon atom. The oxidation of the hydrocarbon chain occurs by a sequential cleavage of two carbon atoms (Fray Knoop, 1904).

### Preparative Steps for Beta Oxidation

The co-enzyme A is a complex molecule containing B complex vitamin pantothenic acid and a molecule of beta mercapto ethanolamine; this SH group forms thioester bond in acyl CoA (Fig. 12.7). To emphasize the function of the SH group, the CoA is sometimes written as CoA-SH.

#### Preparative Step 1: Activation of Fatty Acids

Fatty acids are activated to their co-enzyme A (CoA) derivative. This activation is taking place in **cytoplasm**. ATP is hydrolyzed to AMP and PPI and the energy from

hydrolysis of PPI drives the reaction forward. Thus **two high energy bonds** are utilized in this reaction.

The enzyme is a **thiokinase** or fatty acyl CoA **synthetase** (step 0, Fig. 12.9). Acetyl group and acyl groups are different; see Box 12.3.

Three different enzymes, one each for short chain, medium chain and long chain fatty acids have been identified. Small chain fatty acids may also be activated by thiophorase enzyme, using succinyl CoA (see under ketone bodies).

#### Preparative Step 2: Role of Carnitine

Fatty acids are activated in the cytoplasm; but **beta-oxidation is in mitochondria**. So transport of fatty acids through the mitochondrial membrane is essential. The long chain fatty acyl CoA cannot pass through the inner mitochondrial membrane. Therefore a transporter, carnitine is involved in transfer of fatty acids. **Carnitine** is beta-hydroxy-gamma-trimethyl ammonium butyrate,



It is synthesized from lysine and methionine in liver and kidney.

#### Preparative Step 3: Carnitine Acyl Transferase

The enzyme carnitine acyl transferase-I (**CAT-I**) will transfer the fatty acyl group to the hydroxyl group of carnitine to form **acyl carnitine** (Fig. 12.8) The reaction occurs on the cytosolic side of inner mitochondrial membrane.

#### Preparative Step 4: Translocase

A protein **translocase** will carry the acyl carnitine across the membrane to the matrix of mitochondria. On the matrix side of the membrane another enzyme, carnitine acyl

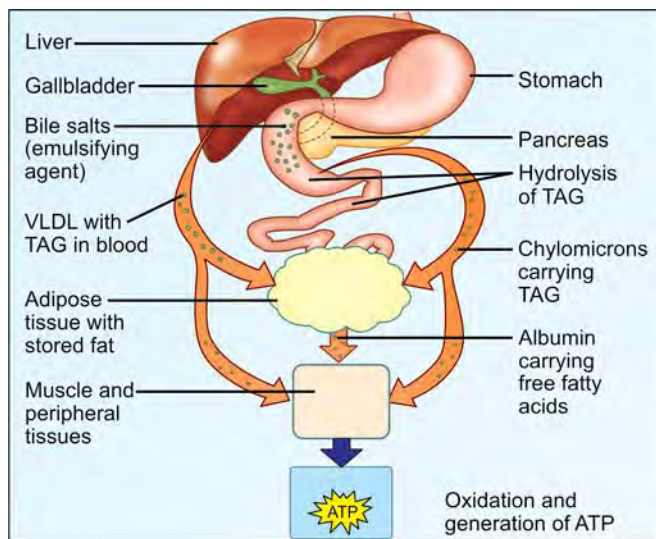


Fig. 12.6: Summary of utilization of fat

#### Box 12.3: Acetyl and Acyl groups are different

- Acetyl CoA** is the combination of acetate or acetic acid (2 carbon unit) with Co-enzyme A.
- Acyl CoA** means acyl group (any fatty acid, C4 to C26 in length) combined with Co-enzyme A.

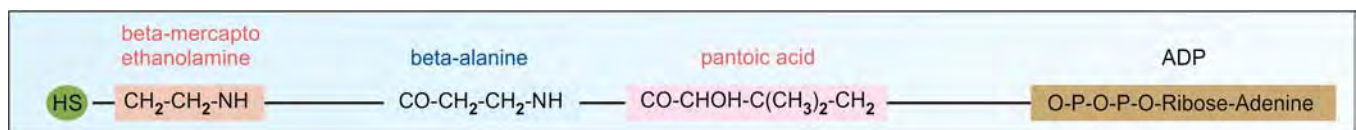


Fig. 12.7: Structure of co-enzyme A (CoA) (CoA-SH)



transferase-II (**CAT-II**) will transfer the acyl group back to co-enzyme A molecule (Fig. 12.8). Carnitine is returned to the cytosolic side by the translocase.

## Clinical Applications

1. Medium chain and short chain fatty acids do not require carnitine for transport across the inner mitochondrial membrane. So, medium chain and short chain fatty acids are easily oxidized.
2. **Carnitine deficiency** is reported in preterm infants, in whom impaired fatty acid oxidation is noticed. So more glucose is utilized, resulting in episodes of hypoglycemia.
3. **Deficiency of translocase:** It leads to defective metabolism of long chain fatty acids. In this condition, muscle cramps are precipitated by fasting, exercise and high fat diet.

## Carnitine

Carnitine was originally found as a growth factor for mealworms and labeled *vitamin Bt*. Carnitine is synthesized in the liver and kidneys from lysine (via trimethyllysine) and methionine. Vitamin C (ascorbic acid) is essential for the synthesis of carnitine. During growth or pregnancy, the requirement of carnitine might exceed its natural production.

Human genetic disorders, such as primary carnitine deficiency, carnitine palmitoyltransferase I deficiency, carnitine palmitoyltransferase II deficiency and carnitine-acylcarnitine translocase deficiency affect different steps of this process.

During the aging process, carnitine concentration in cells diminishes, affecting fatty acid metabolism in various tissues. Bones

are particularly affected adversely, which require continuous metabolic functions of osteoblasts for maintenance of bone mass. Reduction in plasma osteocalcin levels is an indicator of reduced osteoblast activity, leading to osteoporosis in elderly subjects. Administration of carnitine is capable of increasing serum osteocalcin concentrations. Oral carnitine reduces fat mass, increases muscle mass, reduces fatigue and reduces weight loss. Carnitine protects against lipid peroxidation of phospholipid membranes and oxidative stress in myocardium and endothelium. The potential pharmaceutical roles in heart diseases, kidney diseases, male infertility, as a weight loss supplement, and to improve fatigue in cancer chemotherapy are being explored.

The classical presentation of primary carnitine deficiency is hypoketotic hypoglycemic encephalopathy, hepatomegaly, elevated transaminases, hyperammonemia, cardiomyopathy, pericardial effusion, muscle weakness, recurrent episodes of vomiting and diarrhea, recurrent infections and hypochromic anemia. The symptoms are triggered by fasting or viral infections. Secondary carnitine deficiency can present with hypoketotic hypoglycemia in infancy, cardiac and skeletal muscle disease later in life, seizures, apnea and developmental delay. The causes for secondary carnitine deficiency are organic acidurias, respiratory chain and mitochondrial defects, renal Fanconi syndrome and drug induced (valproic acid, zidovudine).

The highest concentrations of carnitine are found in red meat and dairy products. Other natural sources of carnitine include nuts and seeds (e.g. pumpkin, sunflower, sesame), legumes or pulses (beans, peas), vegetables (broccoli, brussels sprouts, garlic, mustard greens), fruits (bananas), cereals (corn, millet, oatmeal, rice bran, rye, wheat).

## Beta Oxidation Steps

The next 4 reactions are sequentially repeated for complete oxidation of fatty acids. After one round of four metabolic steps, one acetyl CoA unit is split off and acyl CoA with 2 carbon atoms less is generated. This would undergo the same series of reactions again until the fatty acid is completely oxidized.

### Step 1: FAD Linked Dehydrogenase

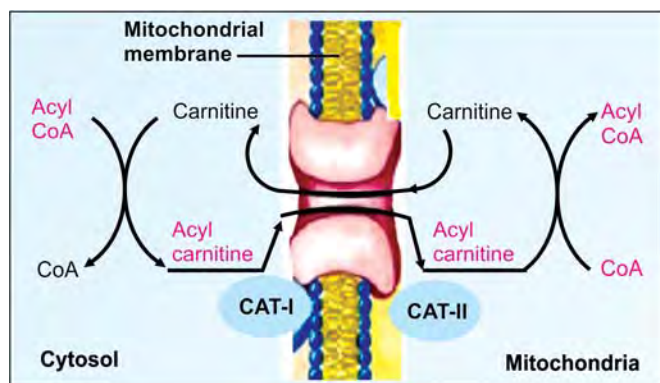
The fatty acyl CoA is dehydrogenated to a transenoyl CoA with FAD accepting the hydrogen atoms (Step 1, Fig. 12.9). **FADH<sub>2</sub>** when oxidised in electron transport chain will produce **1.5 ATP** molecules.

### Step 2: Hydration

This is catalyzed by an enoyl CoA hydratase (step 2, Fig. 12.9). This step forms a beta-hydroxy fatty acyl CoA. The L isomer alone is formed during the hydration of the trans double bond.

### Step 3: NAD<sup>+</sup> Dependent Dehydrogenase

The beta-hydroxy fatty acyl CoA is again oxidized to form beta-keto fatty acyl CoA. (Step 3, Fig. 12.9).



**Fig. 12.8:** Role of carnitine in transport of acyl groups  
CAT = Carnitine acyl transferase

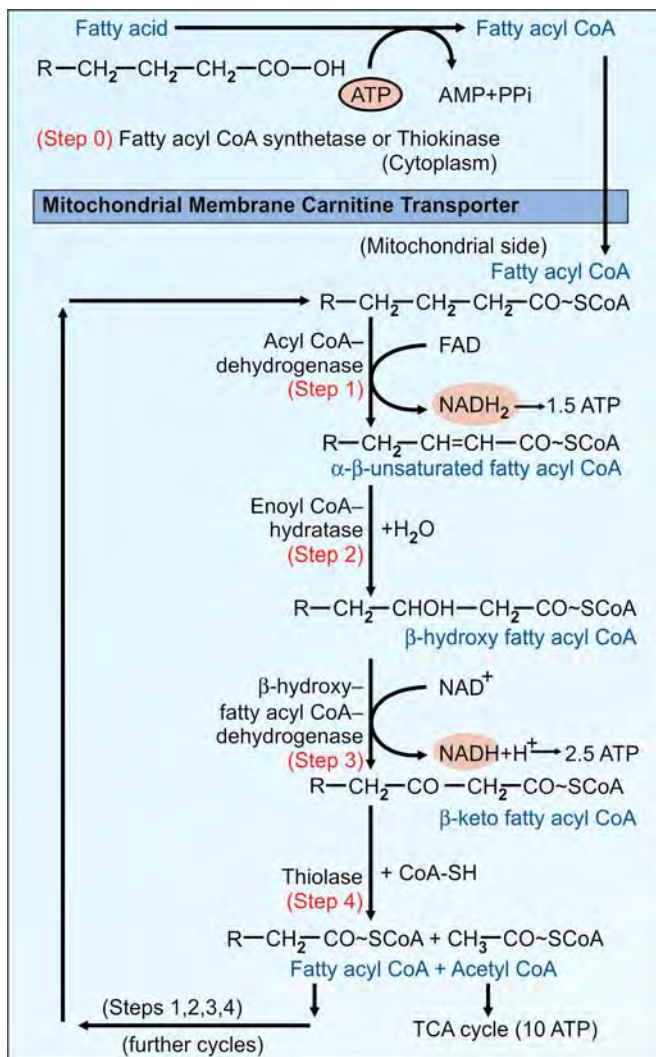
This dehydrogenase acts only on L isomer. The **NADH** when oxidized in electron transport chain will generate **2.5 ATPs**.

### Step 4: Cleavage

The beta-keto fatty acyl CoA now undergoes thiolytic cleavage, splitting off a molecule of acetyl CoA and leaving behind a fatty acid with 2 carbon atoms less (step 4, Fig. 12.9).

## Further Cycles

The newly formed fatty acyl CoA will sequentially undergo further cycles of steps 1, 2, 3 and 4 of beta-oxidation



**Fig. 12.9:** Beta oxidation of fatty acids

Important to remember that the first step is FAD dependent and the third step is  $NAD^+$  dependent.

until the fatty acid is completely converted to acetyl CoA (Fig. 12.10). A summary is shown in Box 12.4.

## Energetics of Beta Oxidation (ATP Yield)

**Palmitic acid** (16 C) needs 7 cycles of beta oxidation (Fig. 12.10). So, it gives rise to 8 molecules of acetyl CoA (Box 12.4). Every molecule of acetyl CoA when oxidized in the TCA cycle gives 10 molecules of ATP. Each molecule of  $FADH_2$  produces 1.5 molecules of ATP and each  $NADH$  generates 2.5 molecules of ATP, when oxidized in the electron transport chain. Hence, the energy yield from one molecule of palmitate may be calculated as:

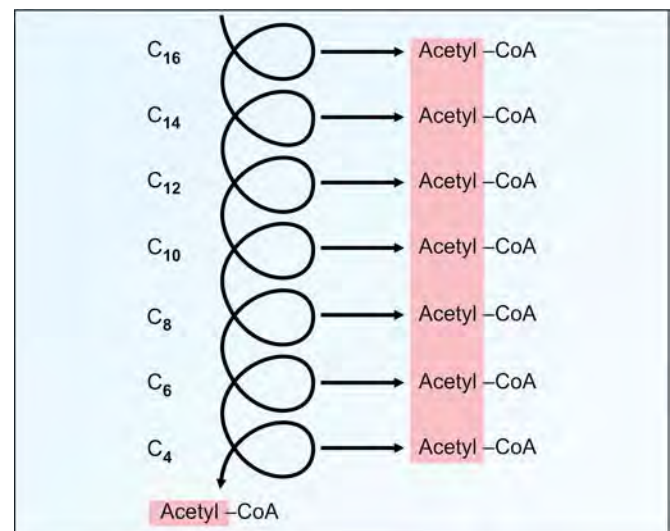
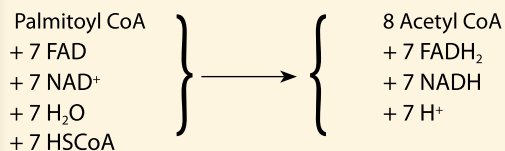
$$\begin{aligned} 8 \text{ acetyl CoA} \times 10 &= 80 \text{ ATP} \\ 7 \text{ FADH}_2 \times 1.5 &= 10.5 \text{ ATP} \\ 7 \text{ NADH} \times 2.5 &= 17.5 \text{ ATP} \\ \text{Gross total} &= 108 \text{ ATP} \end{aligned}$$

$$\text{Net yield} = 108 \text{ minus } 2 = 106 \text{ ATP}$$

(In the initial activation reaction, the equivalents of 2 high energy bonds are utilized). The efficiency of beta oxidation

### Box 12.4. Summary of beta oxidation

When one molecule of palmitate undergoes beta-oxidation, the net reaction is:



**Fig. 12.10:** Summary of beta oxidation of palmitic acid (16 C)

It undergoes 7 cycles, which give rise to 8 molecules of acetyl CoA.

is about 33%. The differences in oxidation of unsaturated fatty acids are shown in Chapter 14.

**Important Note:** Previously calculations were made assuming that NADH produces 3 ATPs and FADH generates 2 ATPs. This will amount to a net generation of 129 ATP per palmitate molecule. Recent experiments show that these old values are wrong, and net generation is only 106 ATPs.

## Regulation of Beta Oxidation

- The availability of free fatty acid (FFA) regulates the net utilization through beta oxidation.
- The level of FFA, in turn, is controlled by glucagon:insulin ratio. Glucagon increases FFA level and insulin has the opposite effect.
- CAT-I is the regulator of entry of fatty acid into mitochondria. Malonyl CoA inhibits CAT-I activity. Thus during de novo synthesis of fatty acid, beta oxidation is inhibited.

## Defects in Beta Oxidation

Abnormalities in transport of fatty acids into mitochondria and defects in oxidation can lead to deficient energy production by oxidation of long chain fatty acids. Common features are hypoketotic hypoglycemia, hyperammonemia, skeletal muscle weakness and liver diseases.

**Acyl carnitine** accumulates when the transferases or translocase is deficient. Dietary supplementation of carnitine has been found to improve the symptoms in some cases.

## Organic Acidurias

They are disorders of metabolism of fatty acids, branched chain and aromatic amino acids and citric acid cycle. The incidence of "medium chain acyl CoA dehydrogenase deficiency" is about 1 in 2,500 live births, and is the second most common inborn error of metabolism (WHO, 2003). They are all characterized by the accumulation of organic acids in body tissues and their excretion in urine. The patients present with acidosis, vomiting, **convulsions** and coma. The children often die in infancy; in case they survive, there is severe **mental** and physical retardation. Diagnosis is confirmed by showing the presence of organic acids in urine by chromatography. Dietary restriction, cofactor therapy and substrate removal are the general lines

**TABLE 12.2:** Some important organic acidurias

Disorders	Deficient enzyme	Clinical features
Methyl malonic aciduria	Methyl malonyl CoA mutase or B <sub>12</sub> co-enzyme	Ketoacidosis, hypotonia, hypoglycemia, hyperammonemia, hyperuricemia
Propionic acidemia	Propionyl CoA carboxylase	Ketoacidosis, hypotonia, vomiting, lethargy
MCADH deficiency	Medium chain acyl CoA dehydrogenase	Acidosis, hyperammonemia; hypoglycemia, fatty liver
LCACDH deficiency	Long chain acyl CoA dehydrogenase	Nonketotic hypoglycemia, low carnitine, increased acyl carnitine
Glutaric aciduria	Glutaryl CoA dehydrogenase	Ketoacidosis, convulsions, progressive neurological defects, cerebral palsy

of management. Examples of these disorders are given in Table 12.2.

## OXIDATION OF ODD CHAIN FATTY ACIDS

The odd chain fatty acids are oxidized exactly in the same manner as even chain fatty acids. However, after successive removal of 2-carbon units, at the end, one 3 carbon unit, **propionyl CoA** is produced.

### Fate of Propionyl CoA

- Carboxylase:** Propionyl CoA is first carboxylated to D-methyl malonyl CoA by a **biotin** dependent carboxylase. Biotin is a member of vitamin B complex group. One molecule of ATP is utilized to supply energy (step 1, Fig. 12.11).
- Racemase:** Then racemase acts upon D-methyl malonyl CoA to give L-methyl malonyl CoA. (step 2, Fig. 12.11).
- Mutase:** Then L-methyl malonyl CoA is rearranged to form succinyl CoA by L-methyl malonyl CoA mutase. The reaction needs **vitamin B<sub>12</sub>** co-enzyme (step 3, Fig. 12.11).
- Succinyl CoA then enters TCA cycle, finally converted to oxaloacetate, and is used for gluconeogenesis.
- Propionyl CoA is also derived from the metabolism of valine and isoleucine (see Chapter 17).

### Propionate is Gluconeogenic

Ordinary fatty acids are cleaved to acetyl CoA units which on entering the Krebs cycle are completely oxidized to CO<sub>2</sub>,



and hence as a general rule, **fatty acids cannot be used for gluconeogenesis**. However, propionate is entering into the citric acid cycle at a point after the  $\text{CO}_2$  elimination steps, so propionate can be channelled to gluconeogenesis. Thus **3 carbon units from odd carbon fatty acids are gluconeogenic**. Cow's milk contains significant quantity of odd chain fatty acids.

## Inborn Errors of Propionate Metabolism

1. **Propionyl CoA carboxylase deficiency.** It is characterized by propionic **acidemia**, ketoacidosis, and developmental abnormalities.
2. **Methyl malonic aciduria.** Some patients respond to treatment with pharmacological doses of  $\text{B}_{12}$ . This group had deficiency in the formation of adenosyl  $\text{B}_{12}$  with deficient mutase activity. The second type did not respond to cyanocobalamin and had deficiency of the enzyme racemase or mutase. Methylmalonate affects the metabolism of brain leading to mental retardation in these cases.

## ALPHA OXIDATION

It is a process by which fatty acids are oxidized by removing carbon atoms, one at a time, from the carboxyl end. The process is **important in brain**. The fatty acid does not need activation. Hydroxylation occurs at the alpha-carbon atom.

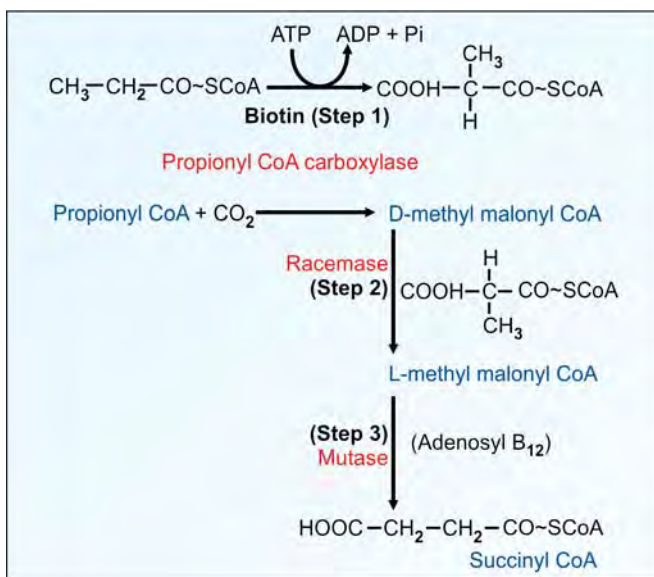


Fig. 12.11: Metabolism of propionyl CoA

It is then oxidized to alpha-keto acid. The keto acid then undergoes decarboxylation yielding a molecule of  $\text{CO}_2$  and a fatty acid with one carbon atom less. This process occurs in the **endoplasmic reticulum**, does not require CoA, but **does not generate energy**. Some fatty acids undergo alpha hydroxylation in peroxisomes also.

Alpha-oxidation is mainly used for fatty acids that have a methyl group at the beta-carbon, which blocks beta-oxidation. A major dietary methylated fatty acid is **phytanic acid** (Fig. 12.12). It is derived from phytol present in chlorophyll, milk and animal fats.

## Refsum's Disease

It is a metabolic error due to lack of alpha-hydroxylase (phytanic acid oxidase) so that alpha oxidation does not occur and phytanic acid accumulates in the tissues. The patient presents with severe neurological symptoms, polyneuropathy, retinitis pigmentosa, nerve deafness and cerebellar ataxia. Regression of symptoms is observed with restricted dietary intake of phytanic acid. Milk is a good source of phytanic acid, which may be avoided.

## Infantile Refsum's Disease

It is a peroxisomal disorder, similar to Zellweger syndrome and adrenoleukodystrophy (see Chapter 41). Hence phytanic acid accumulates along with VLCFA. Children do not survive long.

## OMEGA OXIDATION

It is a minor pathway taking place in **microsomes**, with the help of hydroxylase enzymes involving NADPH and cytochrome P-450. The  $\text{CH}_3$  group is converted to  $\text{CH}_2\text{OH}$  and subsequently oxidized with the help of  $\text{NAD}^+$  to a  $\text{COOH}$  group to produce dicarboxylic acids.  $\omega$ -oxidation becomes important when  $\beta$ -oxidation is defective and dicarboxylic acids (6C and 8C acids) are excreted in urine causing **dicarboxylic aciduria**. Peroxisomal oxidation is described in Chapter 14, under VLCFA.

## Inherited Disorders

Inherited defects in the enzymes of beta oxidation and ketogenesis also lead to nonketotic hypoglycemia, coma, and fatty liver. Defects are

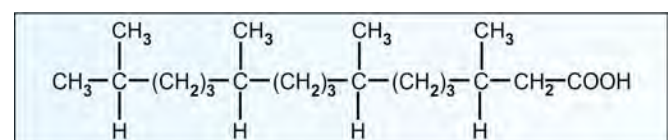


Fig. 12.12: Phytanic acid



known in long- and short-chain 3-hydroxyacyl-CoA dehydrogenase. **3-Ketoacyl-CoA thiolase** and **HMG-CoA lyase deficiency** also affect the degradation of leucine, a ketogenic amino acid. **Dicarboxylic aciduria** is characterized by the excretion of dicarboxylic acids and by nonketotic hypoglycemia. It is caused by a lack of mitochondrial medium-chain acyl-CoA dehydrogenase. **Zellweger's (cerebrohepato renal) syndrome** occurs in individuals with a rare inherited absence of peroxisomes in all tissues. They accumulate C26–C38 polyenoic acids in brain tissue and also exhibit a generalized loss of peroxisomal functions, e.g. impaired bile acid and ether lipid synthesis.

More than 25 enzymes have been identified for fatty acid metabolism in humans, out of which about 15 are known to be associated with metabolic disorders.

## DE NOVO SYNTHESIS OF FATTY ACIDS

The process of fatty acid synthesis was studied by Feodor Lynen, who got Nobel prize in 1964. The pathway is referred to as **Lynen's spiral**. It is not a reversal of oxidation. Important differences in synthesis and breakdown of fatty acids are given in Table 12.3.

Fatty acids are synthesized mainly by a de novo synthetic pathway operating in the **cytoplasm**. So it is referred to as **extramitochondrial** or cytoplasmic fatty acid synthase system.

The major fatty acid synthesized de novo is **palmitic acid**, the 16C saturated fatty acid. The process occurs in liver, adipose tissue, kidney, brain, and mammary glands.

## Transport of Acetyl CoA to Cytoplasm

The starting material for de novo synthesis is acetyl CoA. It is formed inside the mitochondria from pyruvate. The inner membrane is not freely permeable to acetyl CoA. Hence the

**acetyl CoA units are delivered to the cytoplasm as citrate** (Fig. 12.13). Citrate is transported from mitochondria by a tricarboxylic acid **transporter**. In the cytoplasm, citrate is cleaved to oxaloacetate and acetyl CoA in the cytoplasm. The enzyme is **ATP citrate lyase**. The oxaloacetate can return to the mitochondria as **malate** or **pyruvate** (Fig. 12.13).

## Fatty Acid Synthase (FAS) Complex

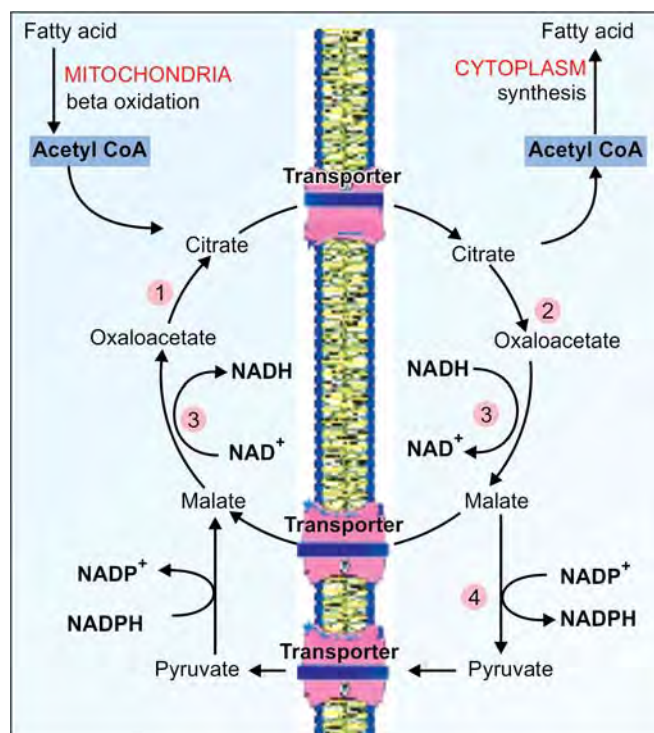
This system exists as a **multi-enzyme complex**. The enzymes form a **dimer** with identical subunits. Each subunit of the complex is organized into 3 **domains** with 7 enzymes (Fig. 12.14).

## Advantages of Multi-enzyme Complex

- Intermediates of the reaction can easily interact with the active sites of the enzymes.
- One gene codes all the enzymes; so all the enzymes are in equimolecular concentrations.
- So the efficiency of the process is enhanced.

**TABLE 12.3:** Difference in the two pathways

	<i>Beta-oxidation</i>	<i>Fatty acid synthesis</i>
Site	Mitochondria	Cytoplasm
Intermediates	Present as CoA derivatives	Covalently linked to SH group of ACP
Enzymes	Present as independent proteins	Multi-enzyme complex
Sequential units	Two carbon units split off as acetyl CoA	Two carbon units added, as 3 carbon malonyl CoA
Co-enzymes	NAD <sup>+</sup> and FAD are reduced	NADPH used as reducing power
Carrier	Carnitine	Citrate
Regulation	Insulium ↓ Glucagon ↑	Insulium ↑ Glucagon ↓



**Fig. 12.13:** Transfer of acetyl CoA from mitochondria to cytoplasm by malate-oxaloacetate shuttle

1 = citrate synthetase; 2 = ATP-citrate lyase; 3 = malate dehydrogenase; 4 = malic enzyme

### First Domain or Condensing Unit

It is the initial substrate binding site. The enzymes involved are beta-keto acyl synthase or condensing enzyme (CE); acetyl transferase (AT) and malonyl trans acylase (MT) (Fig. 12.14).

### Second Domain or Reduction Unit

It contains the dehydratase (DH); enoyl reductase (ER); beta-keto acyl reductase (KR) and acyl carrier protein (ACP) (Fig. 12.14). The acyl carrier protein is a polypeptide chain having a phospho-pantotheine group, to which the acyl groups are attached in thioester linkage. So ACP acts like the CoA carrying fatty acyl groups (Fig. 12.14).

### Third Domain or Releasing Unit

It is involved in the release of the palmitate synthesized. It contains thio-esterase (TE) or de-acylase (Fig. 12.14).

### Step 1: Carboxylation of Acetyl CoA

The first step in the fatty acid synthesis is the carboxylation of acetyl CoA to form malonyl CoA. Acetyl CoA carboxylase is not a part of the multi-enzyme complex. But it is the **rate-limiting enzyme**. **Biotin**, a member of B

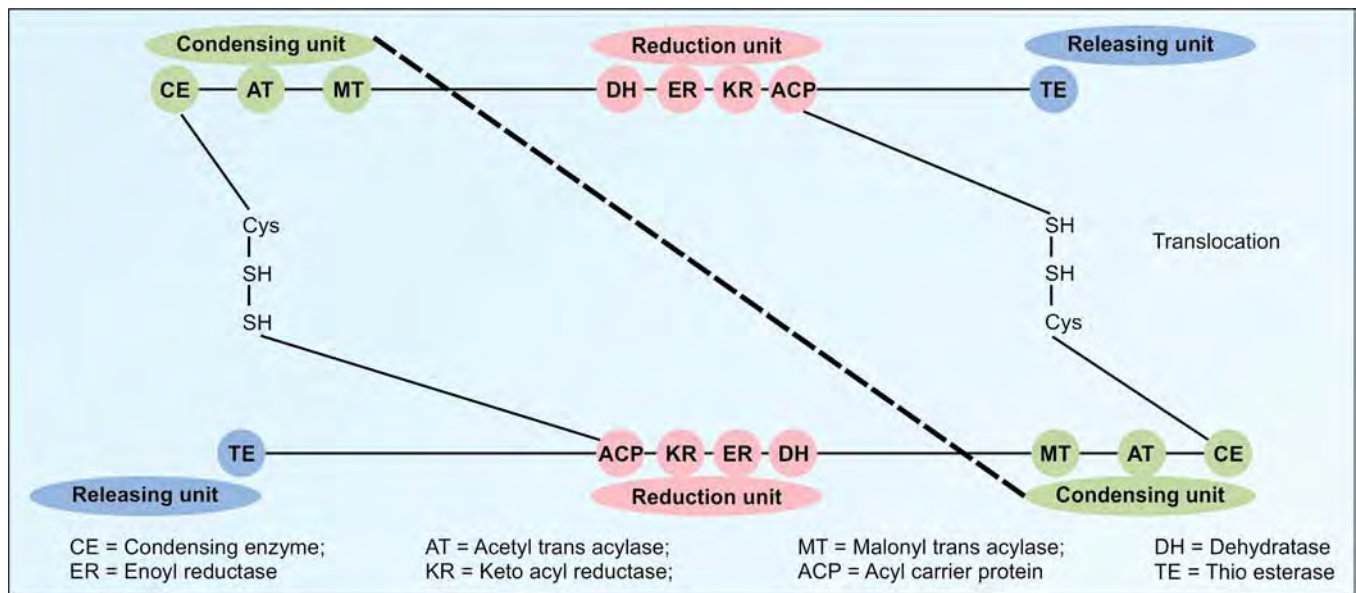
complex vitamins, is necessary for this reaction (Step 1 in Fig. 12.15).

The enzyme is allosterically regulated, the major effectors being citrate (positive) and palmitoyl CoA (negative). The reaction is similar to carboxylation of pyruvate to form oxaloacetate.

The elongation of the fatty acid occurs by addition of 2 carbon atoms at a time. But the 2-carbon units are added as 3-carbon, **malonyl units**. The whole reaction sequence occurs while the intermediates are bound to ACP (acyl carrier protein).

### Step 2: Three C and Two C Units are Added

- Acetyl transacylase** (AT in Fig. 12.14) catalyzes the transfer of the acetyl group (2 carbons) to the cysteinyl SH group of the **condensing enzyme** (CE) of the other monomer of the fatty acid synthase complex (step 2A in Fig. 12.15).
- One molecule of acetyl CoA (2 carbon) and one molecule of malonyl CoA (3 carbon) bind to the multi-enzyme complex. **Malonyl transacylase** (MT in Fig. 12.14) transfers the malonyl group to the SH group of the ACP of one monomer of the enzyme (step 2B in Fig. 12.15).



**Fig. 12.14:** Fatty acid synthase complex

Upper and lower units are two monomers of the complex. Dotted line represents functional division.

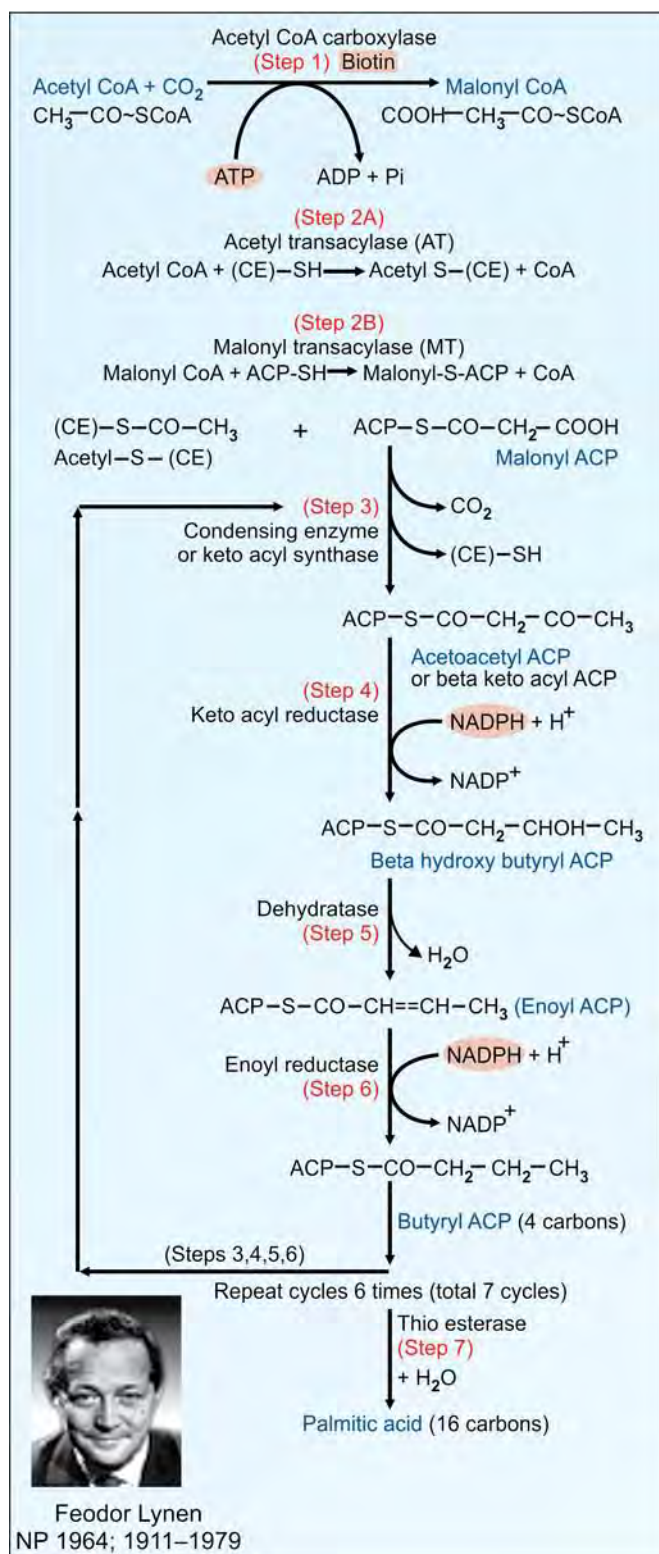


Fig. 12.15: De novo synthesis of fatty acid (Lynen cycle). Steps 4 and 6 utilize NADPH

### Step 3: Condensation

Acetyl (2C) and malonyl (3C) units are condensed to form beta-keto acyl ACP or aceto acetyl ACP (4C). During this process one carbon is lost as CO<sub>2</sub> (step 3 in Fig. 12.15). The enzyme is called **condensing enzyme** or keto acyl synthase (CE in Figs.12.14).

### Step 4: Reduction

Acetoacetyl ACP is reduced by NADPH dependent beta-keto acyl **reductase** (KR in Fig. 12.14) to form beta-hydroxy fatty acyl ACP (step 4 in Fig. 12.15).

### Step 5: Dehydration

It is then dehydrated by a **dehydratase** (DH) to form enoyl ACP otherwise known as (alpha beta unsaturated acyl ACP) (step 5 Fig. 12.15).

### Step 6: Second Reduction

The enoyl ACP is again reduced by enoyl reductase (ER) utilizing a 2nd molecule of NADPH to form butyryl ACP (step 6 in Fig. 12.15).

## Cycling of Reactions

The butyryl group (4C) is now transferred to the SH group of the condensing enzyme on the other monomer and a 2nd malonyl CoA molecule binds to the phospho-pantothenyl SH group. The sequence of reactions, namely condensation, reduction, dehydration and reduction (steps 3,4,5,6) are repeated. The cycles are repeated a total of **seven times**, till the 16-Carbon palmitic acid is formed.

### Step 7: Palmitic acid is Released

**Thio-esterase** or de-acylase activity (TE) releases palmitate from the multi-enzyme complex (step 7, Fig. 12.15).

The end point is Palmitic acid (16 C) in liver and adipose tissue. But in lactating mammary gland, the end products are Capric (10 C) and Lauric (12 C) acids. Mother's milk contains these medium-chain fatty acids. Cow's milk contains odd numbered fatty acids.

## Summary of De Novo Synthesis

The net reaction of de novo synthesis of fatty acid may be summarized as:







### Insulin Favors Lipogenesis

Insulin enhances the uptake of glucose by adipocytes and increases the activity of pyruvate dehydrogenase, acetyl CoA carboxylase and glycerol phosphate acyl transferase (see Table 24.4). Insulin also depresses hormone sensitive lipase (Fig. 12.16).

### Glucagon Inhibits Lipogenesis

Glucagon and epinephrine are lipolytic. They inhibit acetyl CoA carboxylase by keeping the enzyme in the inactive phosphorylated state. These hormones are secreted when the energy charge is low and AMP levels are high.

### ChREBP: Master Lipid Regulator in the Liver

Excess glucose is diverted into the lipid synthesis pathway. Glucose is catabolized to acetyl-CoA which is used for de novo fatty acid synthesis and ultimately stored as triglycerides in adipose tissue. A diet rich in carbohydrates leads to stimulation of both the glycolytic and lipogenic pathways. Genes encoding glucokinase (GK) and liver pyruvate kinase (L-PK) of glycolysis and ATP citrate lyase, ACC, and FAS of lipogenesis are regulated by modulation of their transcription rates. These genes contain glucose- or carbohydrate-response elements (ChoREs) that are responsible for their transcriptional regulation. One transcription factor that exerts control over glucose and lipid homeostasis is sterol-response element-binding protein (SREBP), in particular SREBP-1c. The regulation and actions of SREBP are discussed in the Cholesterol Metabolism (see Chapter 13). SREBP controls the expression of a number of genes involved in lipogenesis and its own transcription is increased by insulin and repressed by glucagon. The carbohydrate-responsive element-binding protein (ChREBP) is identified as a major glucose-responsive transcription factor and it is required for glucose-induced expression of L-PK and the lipogenic genes ACC and FAS.

## SYNTHESIS OF TRIACYLGLYCEROLS

Liver and adipose tissue are the major sites of triacylglycerol (TAG) synthesis. The TAG synthesis in adipose tissue is for storage of energy whereas in liver it is mainly secreted as VLDL and is transported. The TAG is synthesized by esterification of fatty acyl CoA with either glycerol-3-phosphate or dihydroxy acetone phosphate (DHAP) (Fig. 12.17). The glycerol part of the fat is derived from the metabolism of glucose. DHAP is an intermediate of glycolysis. Glycerol-3-phosphate may be formed by phosphorylation of glycerol or by reduction of dihydroxy acetone phosphate (DHAP).

**In adipose tissue, glycerol kinase is deficient and the major source is DHAP derived from glycolysis.**

However in liver, glycerol kinase is active. The fatty acyl CoA molecules transfer the fatty acid to the hydroxyl groups of glycerol by specific acyl transferases.

In addition to these two pathways, in the intestinal mucosal cells the TAG synthesis occurs by the MAG pathway. The 2-MAG absorbed is re-esterified with fatty acyl CoA to form TAG (Fig. 12.4).

Esterification of fatty acyl CoA with glycerol phosphate to form triacyl glycerol occurs at a rapid rate during the fed state. Under conditions of fasting, it is seen that synthesis of triacyl glycerol occurs side by side with lipolysis, since the free fatty acid level is high in plasma. The glycerol phosphate is derived from the metabolism of glucose in the fed state by channeling dihydroxy acetone phosphate, an intermediate of glycolysis. In the fasting state, the glycerol phosphate is derived from dihydroxy acetone phosphate formed during gluconeogenesis (neoglycerogenesis). The activity of the enzyme PEPCK is enhanced in liver and adipose tissue during conditions of fasting, so that glycerol phosphate is available to esterify and store the excess fatty acid mobilized.

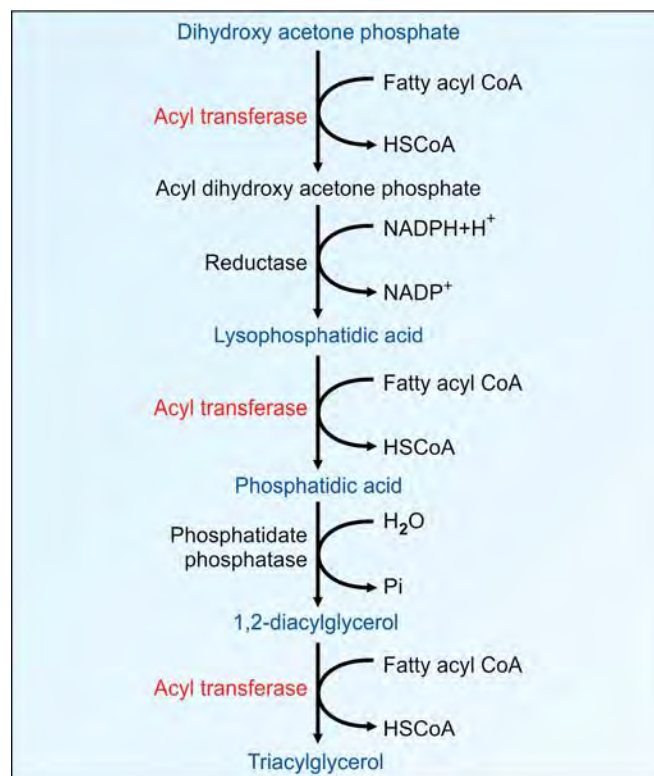


Fig. 12.17: Triacylglycerol synthesis

## METABOLISM OF ADIPOSE TISSUE

The adipose tissue serves as a storage site for excess calories ingested. The triglycerides stored in the adipose tissue are not inert. They undergo a daily turnover with new triacylglycerol molecules being synthesized and a definite fraction being broken down.

### Adipose Tissue in Well-fed Condition

- i. Under well-fed conditions, active lipogenesis occurs in the adipose tissue.
- ii. The dietary triglycerides transported by chylomicrons and the endogenously synthesized triglycerides from liver brought by VLDL are both taken up by adipose tissue and esterified and stored as TAG. The lipoprotein molecules are broken down by the **lipoprotein lipase** present on the capillary wall.
- iii. In well fed condition, glucose and insulin levels are increased. GluT4 in adipose tissue is insulin dependent. Insulin increases the activity of key glycolytic enzymes as well as pyruvate dehydrogenase, acetyl CoA carboxylase and glycerol phosphate acyl transferase. The stimulant effect of insulin on the uptake of glucose by adipose tissue, on the glycolysis and on the utilization of glucose by HMP pathway also enhances lipogenesis.
- iv. Insulin also causes inhibition of **hormone sensitive lipase**, and so lipolysis is decreased (Fig. 12.16 and Table 12.4).

### Adipose Tissue in Fasting Condition

- i. The metabolic pattern totally changes under conditions of fasting. TAG from the adipose tissue is mobilized under the effect of the hormones, **glucagon and epinephrine**.
- ii. The cyclic AMP mediated activation cascade enhances the intracellular hormone sensitive lipase (Fig. 12.16 and Table 12.4). The **phosphorylated form of the enzyme is active**, which acts on TAG and liberates fatty acids.
- iii. Under conditions of starvation, a high glucagon, ACTH, glucocorticoids and thyroxine have lipolytic effect. The released free fatty acids (FFA) are taken up by peripheral tissues as a fuel.

### Adipose Tissue and Diabetes Mellitus

Lipolysis is enhanced and high FFA level in plasma is noticed in diabetes mellitus. Insulin acts through receptors on the cell surface of adipocytes. These **receptors are decreased**, leading to **insulin insensitivity** in diabetes.

In type 2 diabetes mellitus, there is insulin resistance and the different insulin signaling pathways are affected differently. Hepatic gluconeogenesis occurs uninhibited leading to hyperglycemia. However, increased mobilization of fatty acids from adipose tissue and the persistently high free fatty acid levels in the presence of hyperinsulinemia stimulates synthesis of triacylglycerol. The overproduction of TAG leads to increased release of VLDL from liver causing hypertriglyceridemia. The excess deposition of TAG in adipose tissue accounts for the obesity prevalent in type 2 diabetes patients.

### Adipose Tissue and Obesity

The fat content of the adipose tissue can increase to unlimited amounts, depending on the amount of **excess calories** taken in. This leads to obesity. A high level of plasma insulin level is noticed. But the **insulin receptors are decreased**; and there is peripheral resistance against insulin action. When fat droplets are overloaded, the nucleus of adipose tissue cell is degraded, cell is destroyed, and TAG becomes extracellular. Such TAG cannot be metabolically reutilized and forms the dead bulk in obese individuals. **See Chapter 40 for details.**

### Adipokines (Adipose Tissue Derived Hormones)

Adipokines are a group of active factors involved in maintenance of energy homeostasis as well as resistance to insulin. The important adipokines are leptin, adiponectin, resistin, TNF-alpha (tumor necrosis factor) and IL-6 (interleukin-6).

**Leptin** is a small peptide, produced by adipocytes. Leptin receptors are present in specific regions of the brain. The feeding behavior is

**TABLE 12.4:** Changes in adipose tissue

<i>Well fed state</i>	<i>During fasting</i>
Lipogenesis increased	Lipogenesis inhibited
Lipolysis inhibited	Lipolysis increased
Insulin inhibits HS-lipase	Glucagon activates HS-lipase
Lipoprotein lipase active	FFA in blood increased

regulated by leptin. A defect in leptin or its receptor, can lead to obesity. Leptin also prepares body to adapt for starvation. Leptin regulates energy balance and exerts an insulin sensitizing effect. Decreased level of leptin increases the occurrence of obesity.

**Adiponectin** is another polypeptide, which increases the insulin sensitivity of muscle and liver and exerts an anti-atherogenic effect. Low levels of adiponectin will accelerate atherosclerosis. Low levels are also observed in patients with metabolic syndrome.

Increased secretion of TNF-alpha and IL-6 will decrease insulin action on muscle and liver.

### White Adipose Tissue

It is mainly concerned with energy storage. It is made up of spherical cells, with very few mitochondria. The triglycerides form the major component of white adipose tissue (about 80%) with oleic acid being the most abundant fatty acid (50%).

**Brown adipose tissue** is involved in thermogenesis. Brown adipose tissue cells are polygonal with more abundant cytoplasm. The brown color is due to the presence of numerous mitochondria. It is primarily important in new born human beings and adult hibernating animals.

**Thermogenesis** is a process found in brown adipose tissue. It liberates heat by uncoupling oxidation from phosphorylation. So energy is released as heat, instead of trapping it in the high energy bonds of ATP by the action of the uncoupling protein, thermogenin.

### Liver-Adipose Tissue Axis

Role of liver in fat metabolism is shown in Box 12.5. Liver produces fatty acid and TAG (triacylglycerol), which is transported as VLDL (very low density lipoprotein) in the

#### Box 12.5: Role of liver in fat metabolism

1. Secretion of bile salts
2. Synthesis of fatty acid, triacyl glycerol and phospholipids
3. Oxidation of fatty acids
4. Production of lipoproteins
5. Production of ketone bodies
6. Synthesis and excretion of cholesterol.

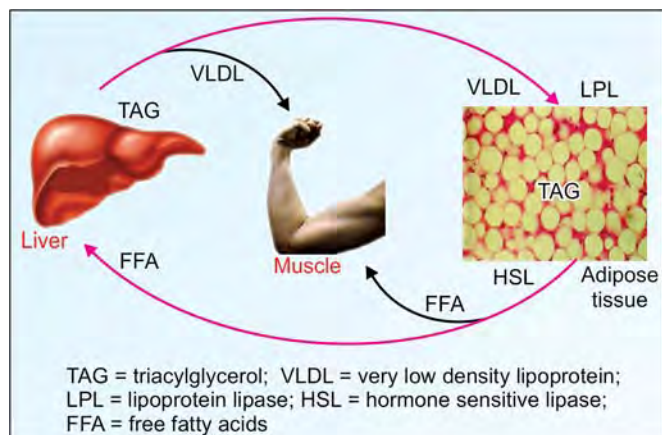


Fig. 12.18: Liver-adipose tissue axis

blood. The fatty acids from VLDL are taken up by adipose tissue with the help of lipoprotein lipase, and stored as TAG. This neutral fat is hydrolysed by hormone sensitive lipase into NEFA, which in the blood is carried by albumin. The NEFA is utilized by the peripheral tissues, excess of which can be taken up by liver cells. Thus there is a constant flux of fat molecules from liver to adipose tissue and back (Fig. 12.18).

## FATTY LIVER AND LIPOTROPIC FACTORS

Fatty liver refers to the deposition of excess triglycerides in the liver cells. The balance between the factors causing fat deposition in liver versus factors causing removal of fat from liver, determines the outcome.

### Causes of Fatty Liver

- Causes of fat deposition in liver**
  1. Mobilization of NEFA from adipose tissue.
  2. More synthesis of fatty acid from glucose.
- Reduced removal of fat from liver**
  3. Toxic injury to liver. Secretion of VLDL needs synthesis of apo B-100 and apo C.
  4. Decreased oxidation of fat by hepatic cells. An increase in factors (1) and (2) or a decrease in factors (3) and (4) will cause excessive accumulation, leading to fatty liver. These pathways are summarized in Figure 12.19.

### Excessive Mobilization of Fat

The capacity of liver to take up the fatty acids from blood far exceeds its capacity for excretion as VLDL. So fatty liver can occur in **diabetes mellitus and starvation** due to increased lipolysis in adipose tissue (step 1, Fig. 12.19).

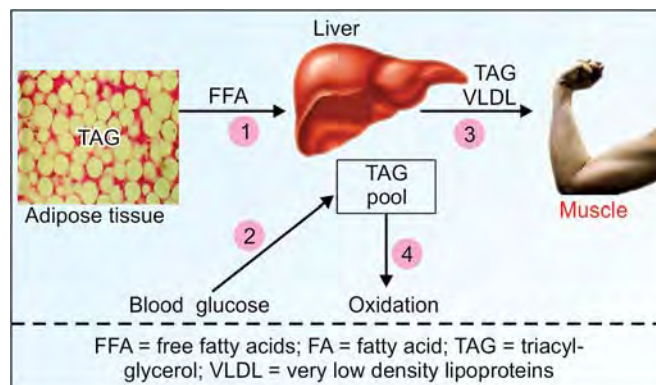


Fig. 12.19: Causes for fatty liver

## Excess Calorie Intake

Excess calories, either in the form of carbohydrates or as fats, are deposited as fat. Hence **obesity** may be accompanied by fatty liver (step no. 2 in Fig. 12.19).

## Toxic Injury to Liver

- i. In toxic injury to the liver due to **poisoning** by compounds like carbon tetrachloride, arsenic, lead, etc., the capacity to synthesize VLDL is affected leading to fatty infiltration of liver (step no. 3 in Fig. 12.19).
- ii. In **protein calorie malnutrition**, amino acids required to synthesise apoproteins may be lacking.
- iii. **Hepatitis B virus** infection reduces the function of hepatic cells. Occurrence of fatty liver in protein energy **malnutrition** (PEM) may be due to defective apoprotein synthesis.

## Alcoholism

- i. It is the most common cause of fatty liver and cirrhosis in India. The metabolism of alcohol is described in Chapter 11.
- ii. Alcohol is oxidized to acetaldehyde. This reaction produces increased quantities of NADH, which converts oxaloacetate to malate. As the availability of oxaloacetate is reduced, the oxidation of acetyl CoA through citric acid cycle is reduced (block in step 4 of Fig. 12.19).
- iii. So fatty acid accumulates leading to TAG deposits in liver.

## Non-alcoholic Fatty Liver Disease and Non-alcoholic Steatohepatitis

Non-alcoholic fatty liver disease (NAFLD) is the most common liver disease, where fat accumulates in hepatocytes. High fat diet and uncontrolled diabetes mellitus are the most common causes. As it is progressed, inflammatory reaction occurs, which is then termed as non-alcoholic steatohepatitis (NASH).

## Fatty Liver Progresses to Cirrhosis

- i. Fat molecules infiltrate the cytoplasm of the cell (**fatty infiltration**). These are seen as fat droplets, which are merged together so that most of the cytoplasm becomes laden with fat.

- ii. The nucleus is pushed to a side of the cell, nucleus further disintegrated (**karyorrhexis**), and ultimately the hepatic cell is lysed.
- iii. As a healing process, fibrous tissue is laid down, causing **fibrosis** of liver, otherwise known as **cirrhosis**. *Liver function tests* (see Chapter 26) will show abnormal values.

## Lipotropic Factors

They are **required for the normal mobilization** of fat from liver. Therefore deficiency of these factors may result in fatty liver. They can afford protection against the development of fatty liver.

1. **Choline**: Feeding of choline has been able to reverse fatty changes in animals.
2. **Lecithin and methionine**. They help in synthesis of apoprotein and choline formation. The deficiency of methyl groups for carnitine synthesis may also hinder fatty acid oxidation.
3. **Vitamin E and selenium** give protection due to their antioxidant effect.
4. **Omega-3 fatty acids** present in marine oils have a protective effect against fatty liver.

## METABOLISM OF KETONE BODIES

Carbohydrates are essential for the metabolism of fat or **fat is burned under the fire of carbohydrates**. The acetyl CoA formed from fatty acids can enter and get oxidized in TCA cycle only when carbohydrates are available.

During **starvation and diabetes mellitus**, acetyl CoA takes the alternate route of formation of ketone bodies.

## Ketogenesis

Acetoacetate is the **primary ketone body** while beta-hydroxy butyrate and acetone are **secondary ketone bodies**. They are synthesized exclusively by the **liver mitochondria**. The steps involved are shown in Fig. 12.20. Beta hydroxyl butyrate does not contain a keto group and therefore strictly speaking is not a ketone body. It contains alcohol group. The name is therefore a misnomer.

### Step 1: Condensation

Two molecules of acetyl CoA are condensed to form acetoacetyl CoA.



### Step 2: Production of HMGCoA

One more acetyl CoA is added to acetoacetyl CoA to form HMG CoA (beta hydroxy beta methyl glutaryl CoA). The enzyme is HMG CoA synthase. **Mitochondrial HMG CoA is used for ketogenesis**, while cytosolic fraction is used for cholesterol synthesis.

### Step 3: Lysis

Then HMG CoA is lysed to form acetoacetate. Acetoacetate may also be formed by the degradation of carbon skeleton of ketogenic amino acids like leucine, lysine, phenylalanine and tyrosine. HMGCoA lyase is present **only in liver**.

### Step 4: Reduction

Beta-hydroxy butyrate is formed by reduction of acetoacetate. Ratio between acetoacetate and beta hydroxy butyrate is decided by the cellular NAD:NADH ratio.

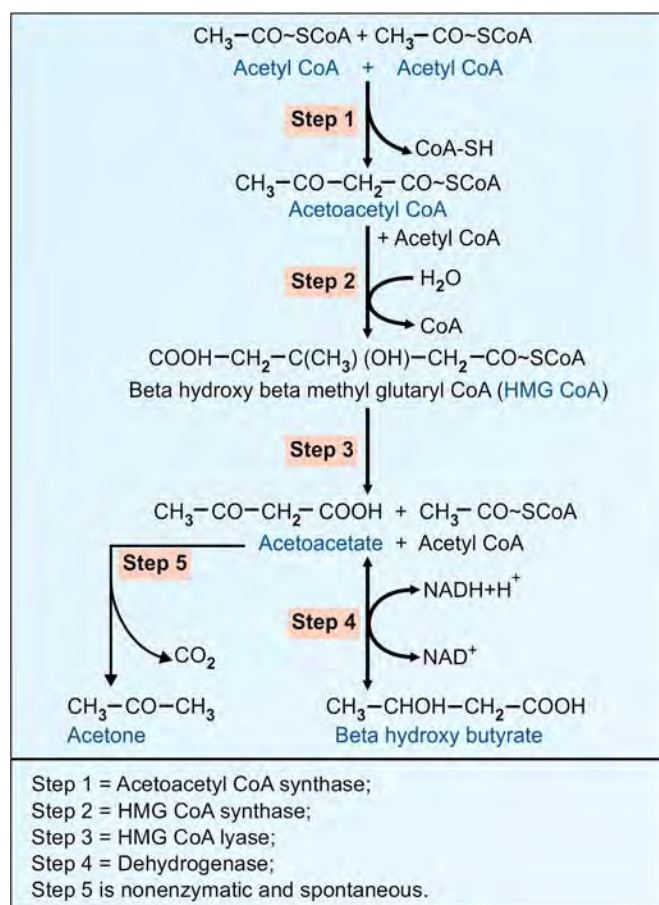


Fig. 12.20: Ketone body formation (Ketogenesis)

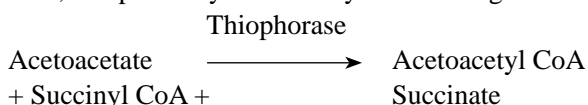
### Step 5: Spontaneous Decarboxylation

Acetone is formed (Fig. 12.20).

## Ketolysis

The ketone bodies are formed in the liver; but they are utilized by **extrahepatic tissues**. The heart muscle and renal cortex prefer the ketone bodies to glucose as fuel. Tissues like skeletal muscle and brain can also utilize the ketone bodies as alternate sources of energy, if glucose is not available. Acetoacetate is activated to acetoacetyl CoA by **thiophorase** enzyme.

Almost all tissues and cell types can use ketone bodies as fuel, with the exception of liver and RBC. The placenta can use ketone body as fuel. Intestinal mucosal cells, brain and adipocytes use ketone bodies. Skeletal muscles, heart, liver, etc. primarily utilize fatty acids during starvation.



Then acetoacetyl CoA enters the beta oxidation pathway to produce energy. Summary of ketone body metabolism is shown in Figure 12.21.

## KETOSIS

- Normally the rate of synthesis of ketone bodies by the liver is such that they can be easily metabolized by the extrahepatic tissues. Hence, the blood level of

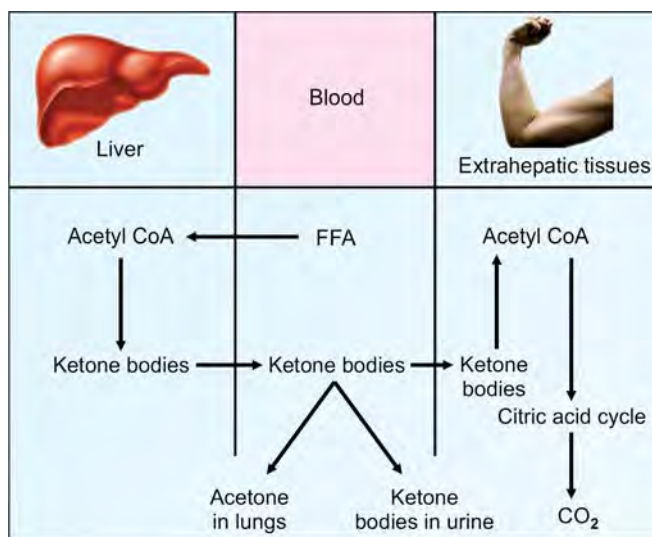


Fig. 12.21: Formation, utilization and excretion of ketone bodies

ketone bodies is less than 1 mg/dL and only traces are excreted in urine (not detectable by usual tests).

- ii. But when the rate of synthesis exceeds the ability of extrahepatic tissues to utilize them, there will be accumulation of ketone bodies in blood.
- iii. This leads to **ketonemia**, excretion in urine (**ketonuria**) and smell of **acetone** in breath. All these three together constitute the condition known as **ketosis**.

## Causes for Ketosis

1. **Diabetes mellitus:** Untreated diabetes mellitus is the most common cause for ketosis. Even though glucose is in plenty, the **deficiency of insulin** causes accelerated lipolysis and more fatty acids are released into circulation. Oxidation of these fatty acids increases the acetyl CoA pool. Enhanced gluconeogenesis restricts the oxidation of acetyl CoA by TCA cycle, since availability of oxaloacetate is less.
2. **Starvation:** In starvation, the dietary supply of glucose is decreased. Available oxaloacetate is channelled to gluconeogenesis. The increased rate of lipolysis is to provide alternate source of fuel. The excess acetyl CoA is converted to ketone bodies. The high **glucagon** favors ketogenesis. The brain derives 75% of energy from ketone bodies under conditions of fasting. **Hyperemesis** (vomiting) in early pregnancy may also lead to starvation-like condition and may lead to ketosis.

## Explanation for Ketogenesis

- i. During starvation and diabetes mellitus, the blood level of **glucagon** is increased. Glucagon (see Chapter 24) inhibits glycolysis, activates gluconeogenesis, activates lipolysis, decreases malonyl CoA level and stimulates ketogenesis. High glucagon-insulin ratio is potentially ketogenic.
- ii. **Insulin** (see Chapter 24) has the opposite effect; it favors glycolysis, inhibits gluconeogenesis, depresses lipolysis, increases malonyl CoA level and decreases ketogenesis. The ketone body formation is regulated at the following 3 levels:

### Level 1: Lipolysis

Free fatty acids are the precursors of ketone bodies. So factors regulating the mobilization of fatty acid from

adipose tissue will also control ketogenesis (Fig. 12.22). Insulin inhibits lipolysis, while glucagon favors lipolysis.

### Level 2: Entry of Fatty Acid to Mitochondria

The mobilized fatty acid then enters mitochondria for beta oxidation. Carnitine acyl transferase I (CAT-I) regulates this entry (Fig. 12.8). Malonyl CoA is the major regulator of CAT-I activity. In diabetes and starvation, glucagon is increased, which decreases malonyl CoA and so beta oxidation is stimulated (Fig. 12.22).

### Level 3: Oxidation of Acetyl CoA

- i. When the above two steps are increased, more acetyl CoA is produced. Normally, acetyl CoA is completely oxidized in the citric acid cycle. In diabetes and starvation, glucagon/insulin ratio is increased, and key gluconeogenic enzymes are activated.
- ii. **When oxaloacetate is diverted for gluconeogenesis;** citric acid cycle cannot function optimally. Thus, on the one hand, acetyl CoA is generated in excess, on the other hand, its utilization is reduced. This excess acetyl CoA is channeled into ketogenic pathway. (See Fig. 24.9 also).
- iii. In both diabetes mellitus and starvation, the oxaloacetate is channelled to gluconeogenesis; so the availability of oxaloacetate is decreased. Hence acetyl CoA cannot be fully oxidized in the TCA cycle.

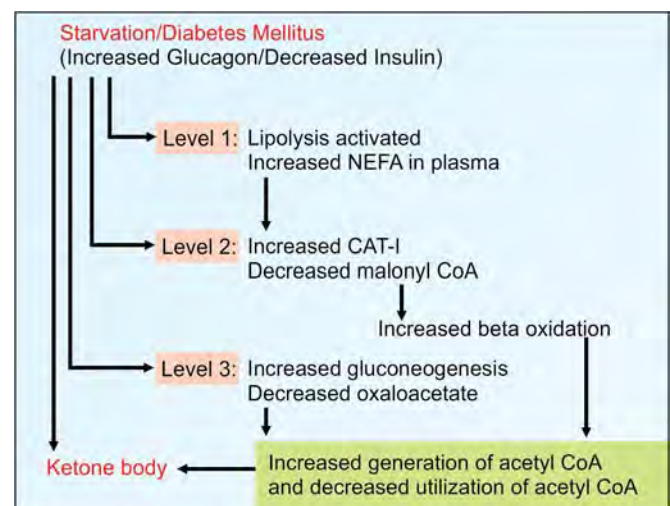


Fig. 12.22: Summary of ketosis

## Salient Features of Ketosis

1. **Metabolic acidosis.** Acetoacetate and beta-hydroxy butyrate are acids. When they accumulate, metabolic acidosis results. (see Chapter 29).
2. **Reduced buffers.** The plasma bicarbonate is used up for buffering of these acids.
3. **Kussmaul's respiration.** Patients will have typical acidotic breathing (see Chapter 24) due to compensatory hyperventilation.
4. **Smell of acetone** in patient's breath.
5. **Osmotic diuresis** induced by ketonuria may lead to dehydration.
6. **Sodium loss.** The ketone bodies are excreted in urine as their sodium salt, leading to loss of cations from the body.
7. **Dehydration.** The sodium loss further aggravates the dehydration.
8. **Coma.** Hypokalemia, dehydration and acidosis are contributing for the lethal effect of ketosis.

## Diagnosis of Ketosis

The presence of ketosis can be established by the detection of ketone bodies in urine by **Rothera's test**. Supportive evidence may be derived from estimation of serum electrolytes, acid-base parameters, glucose and urea estimation.

**Rothera's test:** Saturate 5 mL of urine with solid ammonium sulfate. Add a few drops of freshly prepared sodium nitroprusside followed by 2 mL of liquor ammonia along the sides of the test tube. Development of a purple ring indicates the presence of ketone bodies in urine. Strip tests based on the same principle are also available.

## Differential Diagnosis of Ketosis

The urine of a patient with **diabetic** keto acidosis will give positive Benedict's test as well as Rothera's test. But in **starvation** ketosis, Benedict's test is negative, but Rothera's test will be positive.

## Management of Ketoacidosis

- i. Treatment is to give insulin and glucose. When glucose and insulin are given intravenously, potassium is trapped within the cells. Hence, the clinician should always monitor the electrolytes.

- ii. Administration of bicarbonate, and maintenance of electrolyte and fluid balance are very important aspects. See Chapter 24 also.

## Clinical Case Study 12.1

A teenage girl was brought to the hospital with complaints that she gets too tired and has muscle pains. A consulting neurologist found muscle weakness in arms and legs. Biochemical investigations revealed elevated amounts of triglycerides esterified with primary long chain fatty acids. Muscle biopsy report showed significant number of lipid vacuoles. What is the probable diagnosis? What is the cause of these symptoms?

## Clinical Case Study 12.2

A 22-year-old primigravid female at 36 weeks of gestation presented with nausea, vomiting, and malaise over the last several days. On examination she had high blood pressure (190/110 mm Hg) and yellowish discoloration of sclera. Laboratory results revealed proteinuria, impaired liver function tests, prolonged clotting time, hyperbilirubinemia, hypoglycemia and hypofibrinogenemia. The patient was diagnosed as acute fatty liver of pregnancy. An emergency cesarean section was done, but hypoglycemia worsened and the patient went into coagulopathy, renal failure and hepatic coma. What is the cause of acute fatty liver of pregnancy? What is the cause for hypoglycemia?

## Clinical Case Study 12.3

A 65-year-old man presented with anemia, weight loss and passage of bulky pale stools. On examination, he had hepatosplenomegaly. His plasma electrolytes were normal. Further laboratory tests were:

Plasma, total proteins	: 5.2 g/L
Albumin	: 2.5 g/L
Calcium	: 6.8 mg/dL
Phosphates	: 2 mg/dL
Alkaline phosphatase	: 300 U/L

His fecal fat excretion was 55 g over three days (normal less than 21 g) and his plasma 25-hydroxy cholecalciferol was 28 nmol/L (normal 40–160).

- A. What is the most probable diagnosis?
- B. What will be the cause for steatorrhea and what functional analysis could be done?

- C. How do you interpret low plasma albumin?
- D. How do you interpret low plasma vitamin D, calcium and increased ALP values?
- E. What is the cause for anemia in this patient?

### Clinical Case Study 12.1 Answer

Likely cause is carnitine deficiency. Causes of carnitine deficiency may be – (1) Inadequate intake, (2) Enzyme deficiencies, (3) Decreased endogenous synthesis due to severe liver diseases, (4) Excess loss of carnitine due to diarrhea, renal losses, hemodialysis, (5) Hereditary diseases, (6) Increased requirement, as in ketosis, critical illnesses like sepsis and major burns, major surgery of GIT, and (7) Mitochondrial impairment as with certain drugs (zidovudine, valproate). It can cause a heterogeneous group of disorders. Muscle metabolism is impaired, causing myopathy, hypoglycemia, or cardiomyopathy. Infants typically present with hypoglycemia, and hypoketotic encephalopathy.

The symptoms of carnitine deficiency range from mild muscle cramps to severe weakness and death. Muscle, kidney and heart are primarily affected. Muscle weakness during prolonged exercise is a predominant feature, because muscles rely more of fatty acids as a long-term source of energy. Medium chain fatty acids, which do require carnitine, are normally metabolized in these patients.

Diagnosis is made by very low carnitine level in plasma and muscle (1–2% of normal). Fasting ketogenesis may be impaired if dietary intake is impaired. Fasting urinary organic acid pattern may show hypoketotic dicarboxylic aciduria pattern. Carnitine assay in cultured fibroblast and lymphoblast will demonstrate low level. Treatment consists of dietary L-Carnitine.

### Clinical Case Study 12.2 Answer

Short history of illness, hypoglycemia, liver failure, renal failure and coagulopathy are suggestive of acute fatty liver of pregnancy. Condition usually sets in during the second half of pregnancy and closer to term, it can also manifest in the postpartum period. Diagnosis is made incidentally with elevated liver enzymes. Patients develop jaundice, encephalopathy, and profound hypoglycemia.

Fatty liver due to any condition except alcohol is termed as nonalcoholic steatohepatitis. Causes are obesity, diabetes mellitus, hypertriglyceridemia, drugs and poisons, endocrine disorders and acute fatty liver of pregnancy.

Women with fatty liver of pregnancy develop defect in fatty acid oxidation due to reduced long chain 3 hydroxy acyl CoA dehydrogenase activity. The defect is in mitochondrial processes and reduced  $\beta$  oxidation. There is fatty infiltration of liver and glycogen levels are depleted. Gluconeogenesis is impaired and hypoglycemia develops.

### Clinical Case Study 12.3 Answer

Steatorrhea is confirmed by abnormal fecal fat excretion and the complaint of “passage of bulky pale motions”. Plasma levels of bilirubin, ALT and GGT were normal in this particular case. Liver function tests to be done to rule out chronic liver diseases. Vitamin B<sub>12</sub> absorption test will be positive in diseases of terminal ileum, e.g. regional enteritis.

Low plasma albumin is due to inadequate absorption of amino acids. Low plasma vitamin D, calcium and increased ALP are due to decreased absorption of fat-soluble vitamins. Vitamin D deficiency leads to decreased gut calcium absorption; this in turn, leads to low plasma calcium. This activates osteoblasts, which accounts for the increased ALP level. Anemia is seen because excess fat in gut will interfere with absorption of iron.

## QUICK LOOK OF CHAPTER 12

1. Digestion of lipids involves the following enzymes, Lingual lipase, gastric lipase and pancreatic lipase.
2. Lipids are absorbed by emulsification and micelle formation with the help of bile salts.
3. Short and medium chain fatty acids are absorbed directly without re-esterification.
4. Defective absorption of lipids occurs in celiac disease, Crohn's disease.
5. Mammalian tissues oxidize fatty acids primarily by the beta oxidation pathway which occurs in the mitochondria.
6. Transport of fatty acids (long chain acyl CoA) through the inner mitochondrial membrane is facilitated by carnitine acyl transferase and translocase.
7. Net yield of ATP from one molecule of palmitic acid is 106 ATP.
8. Oxidation of odd chain fatty acids produces propionyl CoA, which may be further metabolized by the TCA cycle.



9. Alpha oxidation and omega oxidation are two other modes of fatty acid oxidation.
10. De novo synthesis of fatty acids occurs in the cytoplasm with the help of a dimeric multi-enzyme complex termed Fatty acid synthase.
11. Synthesis of fatty acid requires NADPH, while degradation requires NAD and FAD.
12. Insulin favors fatty acid synthesis.
13. The white adipose tissue is concerned with energy storage and the brown adipose tissue is concerned with thermogenesis.
14. Obesity is the result of an increase in the fat content of the adipose tissue. It is associated with insulin resistance.
15. Fatty liver refers to deposition of excess triglycerides in the liver cells. It is facilitated by lipotropic factors such as methionine, choline and lecithin.
16. Acetoacetate is the primary ketone body. Beta hydroxy butyric acid and acetone are secondary ketone bodies.
17. Ketosis is seen in diabetes mellitus and starvation.
18. Rothera's test is commonly used to detect presence of ketone bodies in urine.

# CHAPTER 13

## Cholesterol and Lipoproteins

### Chapter at a Glance

The reader will be able to answer questions on the following topics:

- Structure of cholesterol
- Biosynthesis of cholesterol
- Plasma lipids
- Chylomicrons
- Very low density lipoproteins
- Low density lipoproteins
- High density lipoproteins
- Free fatty acid
- Formation of bile acids and bile salts

The word cholesterol is derived from Greek words, chole = bile; steros = solid; ol = alcohol. Almost all nucleated cells (including arterial walls) can synthesize cholesterol. It is widely distributed in the body. In a 70 kg man, a total of about 140 g of cholesterol is available; which is distributed as about 30 g in brain and nerves, 30 g in muscles, 30 g in adipose tissue, 20 g in skin, 10 g in blood, 10 g in liver and spleen, 5 g in bone marrow, 3 g in alimentary tract, and 2 g in adrenal gland. Cholesterol is a light yellow crystalline solid. When the crystals are examined under the microscope, they show a notched appearance. Cholesterol is soluble in chloroform and other fat solvents. It is the most important **animal steroid** from which other steroid compounds are formed. Cholesterol is widely distributed in animal tissues. It is absent in prokaryotes. **In plants, cholesterol is absent**, but other plant sterols are present. In bacteria and plants, compounds similar to steroids exist, known as **hopanoids**. Cholesterol was isolated from gall stones by Poulletier de la Salle in 1758. Chevreul ME characterized cholesterol in 1818. Complete structure of cholesterol was enunciated by Heinrich Wieland in 1918, who got Nobel prize in 1927.

### Clinical Significance of Cholesterol Heart Diseases

The level of cholesterol in blood is related to the development of **atherosclerosis** and **myocardial infarction**. Abnormality

of cholesterol metabolism may lead to cardiovascular accidents and heart attacks. These are explained in detail in Chapter 25. Functions of cholesterol in the body are enumerated in Box 13.1.

### Structure of Cholesterol

1. All steroids have **cyclopentanoperhydrophenanthrene ring** system (Fig. 13.1). It is a fused ring system

#### Box 13.1: Functions of cholesterol

1. **Cell membranes:** Cholesterol is a component of membranes and has a modulating effect on the fluid state of the membrane.
2. **Nerve conduction:** Cholesterol is used to insulate nerve fibers.
3. Bile acids and bile salts are derived from cholesterol. Bile salts are important for fat absorption.
4. **Steroid hormones:** Glucocorticoids, androgens and estrogens are from cholesterol.
5. Vitamin D3 is from 7-dehydro-cholesterol.
6. **Esterification:** The OH group of cholesterol is esterified to fatty acids to form cholesterol esters. This esterification occurs in the body by transfer of a PUFA moiety by lecithin cholesterol acyl transferase.

made up of 3 cyclohexane rings designated as A, B and C and a cyclopentane ring D. The six-membered rings are in a phenanthrene arrangement.

- Total **27 carbon atoms**.
- One **hydroxyl group at third position** which is characteristic of all sterols. The OH group is beta-oriented, projecting above the plane of ring.
- Double bond** between carbon atoms 5 and 6.
- An eight carbon beta oriented side chain attached to 17th carbon.

There are several centers of asymmetry and therefore the possible number of isomers are many. When the double bond between carbon atoms 5 and 6 of cholesterol is reduced, 2 possible isomers may be formed, e.g. **cholestanol** (where the hydrogen atom is alpha oriented, projecting below the plane of the ring) or **coprostanol**, where the hydrogen atom is beta oriented, projecting above the plane of the ring. Alpha oriented groups are denoted by a dotted line, whereas the beta oriented groups are denoted by a solid line. These saturated isomers are formed from cholesterol in the intestine by bacterial reduction.

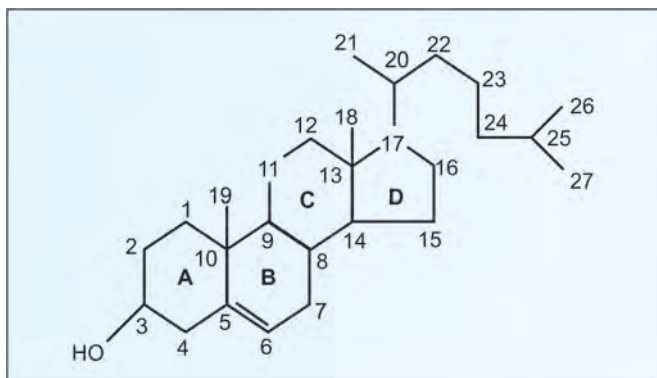


Fig. 13.1: Structure of cholesterol

TABLE 13.1: Salient features of steroids

Name of steroid	Total no. of carbon atoms	No. of carbon atoms inside chain	Importance
Cholesterol	27	8	Most important animal sterol
Bile acids	24	5	Emulsifying agents
Glucocorticoids and Mineralocorticoids	21	2	Influences metabolism as well as fluid and electrolyte balance
Testosterone	19	-	Male sex hormones
Estrogens	18	-	Female sex hormones

## Absorption of Cholesterol

Cholesterol ester present in the diet is hydrolyzed by cholesterol-esterase. The free cholesterol is incorporated into bile salt micelle and absorbed into the mucosal cell. Absorption needs micellar formation. There is a specific protein which facilitates the transport of cholesterol into the mucosal cell from the **micelle**. Inside the mucosal cell, cholesterol is re-esterified and incorporated into chylomicrons. The chylomicrons reach the blood stream through lymphatics (lacteals) (see Chapter 12). This dietary cholesterol reaches the liver through chylomicron remnants. Plant sterols (sitosterol) decrease absorption of cholesterol.

A protein designated **NPC1L1 (Neimann Pick C1 Like1)** is involved in the absorption of cholesterol. The therapeutic effect of the drug Ezetimibe is by interfering with the function of the protein. **ABC (ATP binding cassette proteins)** transporter proteins, ABCG5 (Sterolin 1) and ABCG8 (Sterolin 2) constitute a dimeric unit, limiting cholesterol absorption. They promote the secretion of absorbed sterols from intestinal epithelium back into the lumen and thus regulate the amount of cholesterol incorporated into chylomicrons.

## BIOSYNTHESIS OF CHOLESTEROL

All carbon atoms of cholesterol are derived from acetyl CoA (Konrad Bloch, 1940, Nobel prize in 1964). The biosynthetic pathway was described by Sir John Cornforth and Vladimir Prelog; both of them got Nobel prizes in 1975. The major sites of synthesis of cholesterol are **liver, adrenal cortex, testis, ovaries and intestine**. All nucleated cells can synthesize cholesterol, including arterial walls. The enzymes involved in the synthesis of cholesterol are partly located in the endoplasmic reticulum and partly in the cytoplasm.

### Step 1: Condensation

The acetyl CoA is provided by the ATP-citrate lyase reaction as in the case of fatty acid synthesis. Two molecules of acetyl CoA condense to form acetoacetyl CoA catalyzed by **cytoplasmic acetoacetyl CoA synthase** (see Chapter 12, fatty acid synthesis).

### Step 2: Production of HMG CoA

A third molecule of acetyl CoA condenses with acetoacetyl CoA to form beta-hydroxy beta-methyl glutaryl CoA (HMG CoA). The enzyme is **HMG CoA synthase**. (see Chapter 12, ketogenesis). HMG CoA is present in both cytosol as well as mitochondria of liver. The mitochondrial pool is used for ketogenesis whereas the **cytosolic fraction** is utilized for cholesterol synthesis.

### Step 3: The Committed Step

The reduction of HMG CoA to mevalonate is catalyzed by **HMG CoA reductase**. It is a **microsomal** (endoplasmic

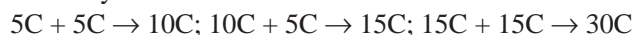
reticulum) enzyme. It uses 2 molecules of NADPH (Fig. 13.2). Steps 1 and 2 are shared with ketogenic pathway; but step 3 is the first reaction that is unique to the cholesterol biosynthetic pathway. It is the **rate-limiting step**.

### Step 4: Production of 5 Carbon Unit

- i. Mevalonate is successively phosphorylated to phosphomevalonate, to pyrophosphomevalonate, then to 3-phospho-5-pyrophosphomevalonate.
- ii. This then undergoes decarboxylation to give isopentenyl pyrophosphate, a 5 carbon unit (Fig. 13.3). Step 4 requires 3 molecules of ATP (Fig. 13.4; steps 4-A, 4-B, 4-C and 4-D). One molecule of CO<sub>2</sub> is eliminated. Steps 1, 2, 3 and 4 together may be considered as the first phase of the cholesterol synthesis.

### Step 5: Condensation of 5-Carbon Units

Details of the reactions are shown in Figure 13.4, step 5A, 5B, 5C and 5D. Thus 6 numbers of 5-carbon units are condensed to form a 30 carbon compound, **Squalene**. In summary



### Step 6: Cyclization

- A. Squalene now undergoes oxidation by epoxidase, using molecular oxygen and **NADPH** to form squalene epoxide.

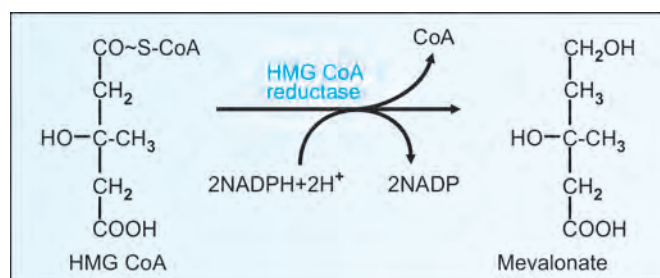


Fig.13.2: Step 3 of cholesterol synthesis

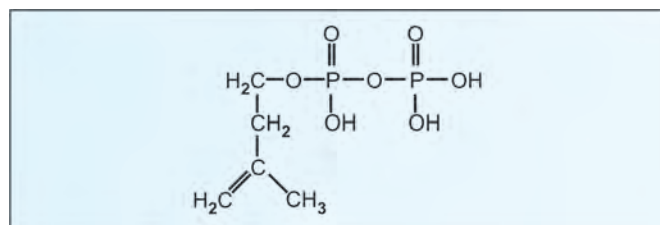


Fig. 13.3: Isopentenyl pyrophosphate; 5 carbon unit

- B. A cyclase converts it to 30C **lanosterol** (Fig.13.5). It is the first steroid compound synthesized.

### Step 7: Cutting to Size

- A. Next, the 3 additional methyl groups on carbon atoms 4 and 14 are removed to produce **zymosterol**.
- B. Then the double bond migrates from 8-9 position to 5-6 position, when **desmosterol** is formed. Desmosterol is present in fetal brain. It is absent in adult brain and re-appears in gliomas (brain tumor).
- C. Finally, the double bond in the side chain (between carbon 24- 25) is reduced by NADPH when **cholesterol** is formed (Fig. 13.5). A summary of the whole pathway of cholesterol synthesis is given in Figure 13.4.

### Regulation of Cholesterol Synthesis

1. **Regulation at transcription:** The regulatory enzyme is **HMG CoA reductase**. Long-term regulation involves regulation of transcription of the gene for HMG CoA reductase. When sufficient cholesterol is present in the cell, transcription of the gene for HMG CoA reductase is suppressed, and cellular synthesis of cholesterol is decreased. When cholesterol in diet is low, synthesis is increased (Fig. 13.6).
2. Cholesterol regulates the expression of HMG CoA reductase gene and LDLR (LDL receptor) gene. A specific recognition sequence known as the sterol regulatory element (SRE) is present in DNA. SRE binding by **sterol regulatory element binding protein (SREBP)** is essential for the transcription of these genes. When cholesterol levels are sufficiently high, the SREBP remains as an inactive precursor. It binds and activates an **SREBP cleavage activator protein (SCAP)**, which is an intracellular cholesterol sensor. When cholesterol is less, SCAP escorts SREBP to Golgi bodies. Two golgi proteases (S1P and S2P) sequentially cleave the SREBP to a protein, which activates the transcription of HMGCoA reductase gene by binding to SRE.
3. **Covalent modification:** Short-term regulation is by covalent modification of the enzyme. AMP activated kinase phosphorylates

TABLE 13.2: Plasma lipid profile

Analyte	Reference value
Total plasma lipids	400–600 mg/dL
Total cholesterol	140–200 mg/dL
HDL cholesterol, male	30– 60 mg/dL
HDL cholesterol, female	35– 75 mg/dL
LDL cholesterol, 30-39 years	80–130 mg/dL
Triglycerides, male	50–150 mg/dL
Triglycerides, female	40–150 mg/dL
Phospholipids	150–200 mg/dL
Free fatty acids(FFA)(NEFA)	10– 20 mg/dL



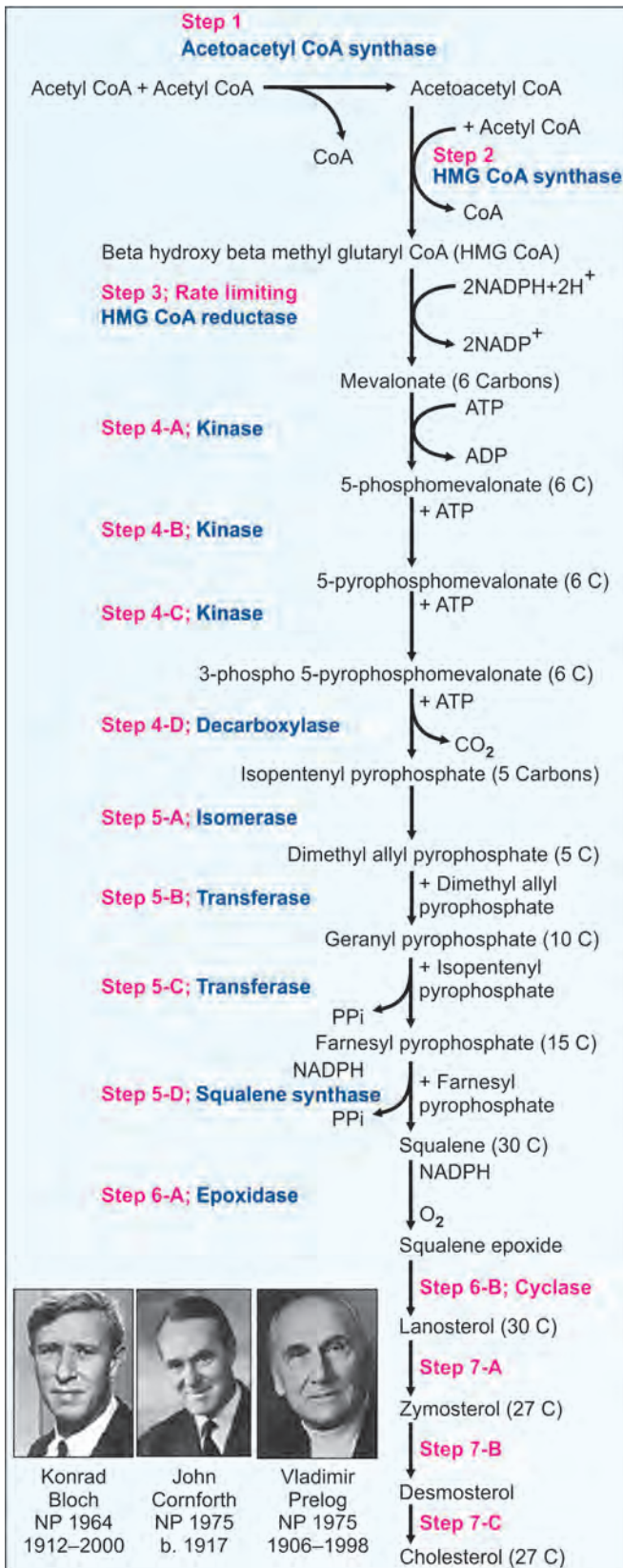


Fig. 13.4: Cholesterol biosynthesis

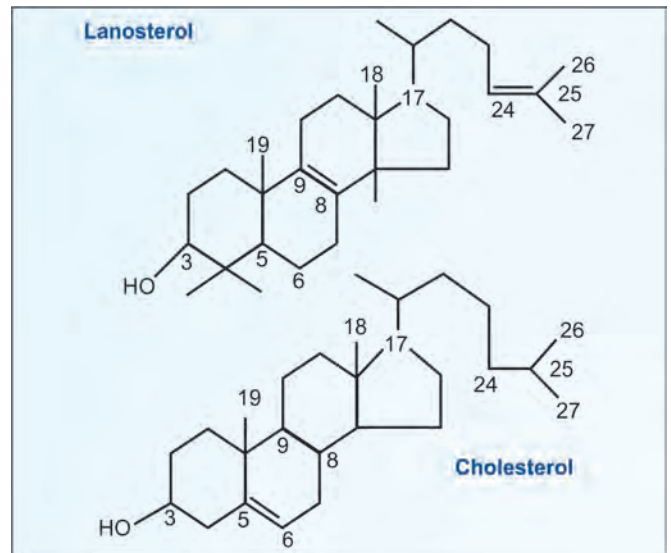


Fig. 13.5: Lanosterol and cholesterol

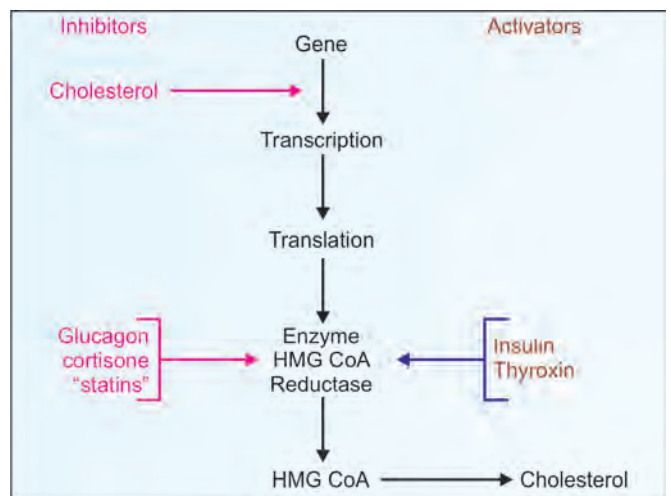


Fig. 13.6A: Regulation of cholesterol synthesis

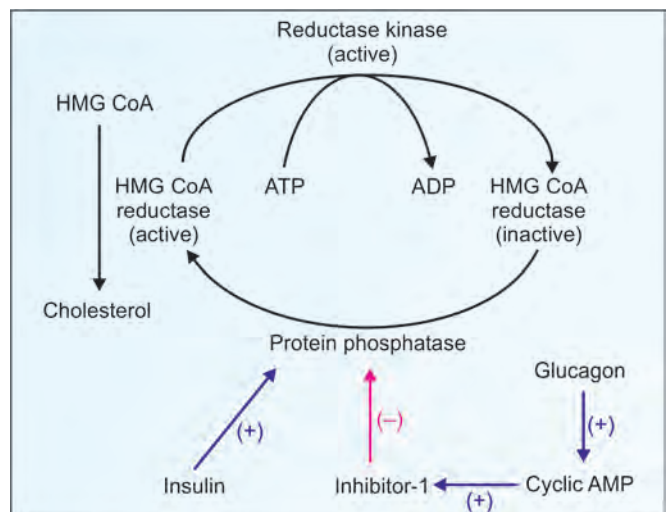


Fig. 13.6B: Regulation of HMGCoA reductase

the enzyme which is inactive. Dephosphorylation by protein phosphatase 1 makes it active. Insulin activates the protein phosphatase, whereas Cyclic AMP activated inhibitor prevents the dephosphorylation of the enzyme (Fig. 13.6B).

4. **Insulin** and thyroxine increase the activity of HMG CoA reductase (Fig. 13.6A).
5. **Cortisol** and glucagon decrease its activity.
6. **Drugs:** Lovastatin and other "statin" group of drugs are competitive inhibitors of HMG CoA reductase. So, they are used in clinical practice to reduce cholesterol level in blood.

### Cholesterol Pool and Cholesterol Metabolism

The total body cholesterol content varies from 130–150 grams. LDL (low density lipoprotein) transports cholesterol from the liver to the peripheral tissues and HDL (high density lipoprotein) transports cholesterol from tissues to liver. Cells of extrahepatic tissues take up cholesterol from LDL. The free cholesterol released within the cell has the following fates:

1. Incorporated into cell membranes.
2. Metabolized to steroid hormones, especially in adrenal cortex and gonads.
3. Esterified with saturated fatty acids and stored in the cell. The enzyme **ACAT** (acyl cholesterol acyl transferase) helps in this reaction.
4. Esterified with poly-unsaturated fatty acids (PUFA) by the action of **LCAT** (lecithin cholesterol acyl transferase) and finally excreted through liver.

### Excretion of Cholesterol

Average diet contains about 300 mg of cholesterol per day. Body synthesizes about 700 mg of cholesterol per day. Out of this total 1000 mg, about 500 mg of cholesterol is excreted through bile. This cholesterol is partly reabsorbed from intestines. Vegetables contain plant sterols which inhibit the re-absorption of cholesterol. The unabsorbed portion is acted upon by intestinal bacteria to form cholestanol and coprostanol. These are excreted (fecal sterols). Another 500 mg of cholesterol is converted to bile acids, which are excreted in the bile as bile salts (Fig. 13.6C).

### Liver and Cholesterol

The liver has a major role in controlling the plasma levels of LDL cholesterol.

1. Liver synthesizes cholesterol
2. Liver removes cholesterol from Lp remnants.
3. Liver is the only organ that can excrete cholesterol through bile.
4. Liver converts cholesterol to bile acids.

## PLASMA LIPIDS

Total plasma lipid is 400–600 mg/dL. Normal values of lipid fractions are shown in Table 13.2. Out of this, 40% is cholesterol; 30% is phospholipids; 20% is triglycerides. Since lipids are insoluble in water, they need the help of carriers in plasma. Therefore, they are complexed with proteins to form **lipoproteins**. The protein part of lipoprotein is called **apolipoprotein**. The lipoproteins are usually abbreviated as Lp.

### Classification of Lipoproteins

Depending on the density (by ultra centrifugation) or on the electrophoretic mobility, the lipoproteins in plasma are classified into five major types (Figs 13.7 and 13.8).

1. **Chylomicrons**—contains apoprotein B-48.
2. **Very low density lipoproteins (VLDL)** or pre-beta lipoproteins. Main apoprotein is B-100.
3. **Intermediate density lipoproteins (IDL)** or broad-beta lipoproteins
4. **Low density lipoproteins (LDL)** or beta-lipoproteins. Major apoprotein in LDL is B-100.
5. **High density lipoproteins (HDL)** or alpha-lipoproteins. Major apoprotein in HDL is apo-A.

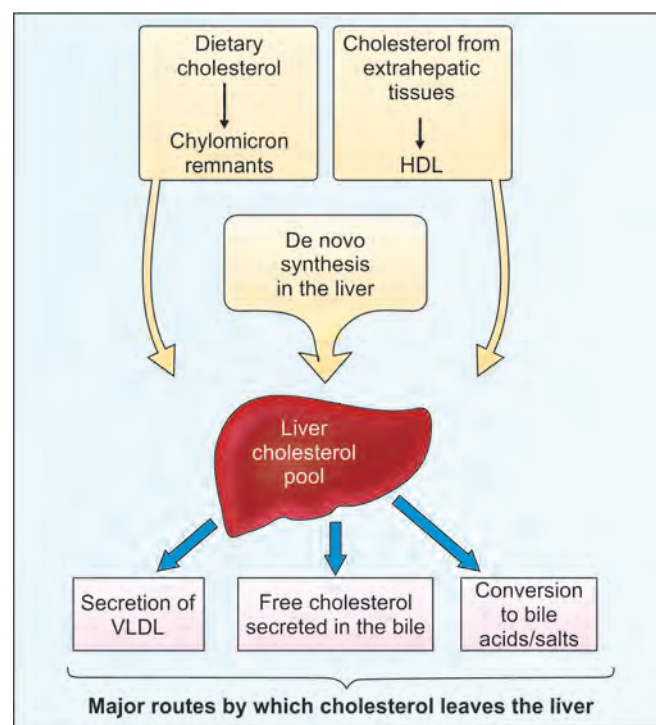


Fig.13.6C: Cholesterol pool in the liver

**Free fatty acids** (FFA) or non-esterified fatty acids (NEFA) are complexed with albumin. FFAs are not generally included in the classification of lipoproteins, because they are loosely bound to the protein.

## General Characteristics of Lipoproteins

Their salient characteristics and compositions of lipoproteins are given in Table 13.3. The lipoprotein molecules have a polar periphery made of proteins, polar heads of phospholipids and cholesterol. The inner core consists of the hydrophobic TAGs and tails of phospholipids. The apoproteins also increase the solubility of lipids.

## Separation by Ultracentrifugation

The lipoproteins are characterized on the basis of their density. Fat is less dense than water; so fat floats on water.

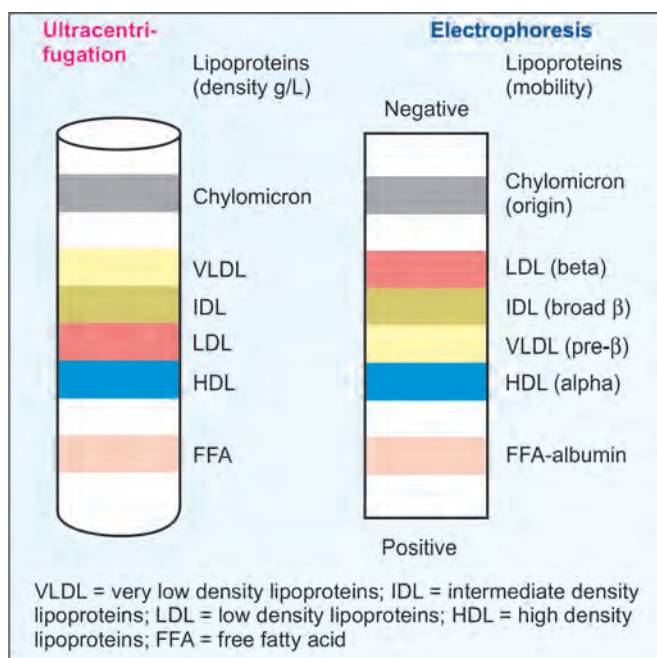


Fig. 13.7: Comparison of electrophoretic and ultra-centrifuge patterns of lipoproteins

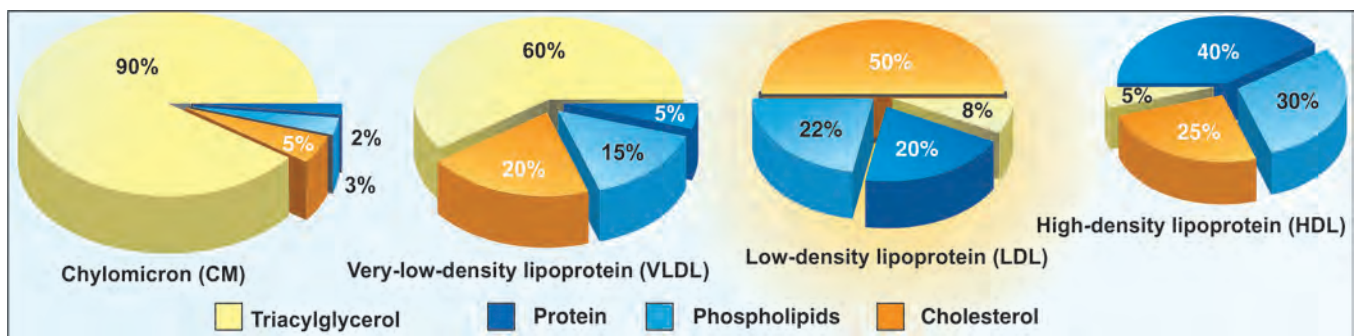


Fig. 13.8: Comparison of sizes of lipoproteins

Lipoproteins with high lipid content will have a low density and so float on centrifugation. Those with high protein content will sediment easily and have a high density. Depending on the flotation constant ( $S_f$ ), different fractions can be separated (Table 13.3 and Fig. 13.7).

## Separation by Electrophoresis

The basic principle of electrophoresis is given in Chapter 35. The serum is applied on cellulose acetate, electric current is applied for 2 hours, the strip is dried and stained with lipid dyes, such as **Oil Red O**. As a general rule, those with higher protein content will move faster towards the anode and those with less proteins have minimum mobility (Fig. 13.7).

## Apo-lipoproteins

The protein part of lipoprotein is called apolipoprotein (apo-Lp) or apoprotein. For details of apoproteins, see Table 13.4. All apoproteins are mainly synthesized in liver; but small quantities are produced from almost all organs. Intestinal cells produce small quantities of apo-A. Apart from **solubilizing** the lipid part, the protein components have specific functions.

1. **Apo-A-I.** Activates lecithin-cholesterol acyl transferase (LCAT). It is the ligand for HDL receptor. It is anti-atherogenic. It is specific for HDL.
2. **Apo-B-100.** Only apoprotein component of LDL; it binds to LDL receptor on tissues (Fig.13.10). Apo-B-100 is one of the biggest proteins, having 4536 amino acids, with a molecular weight of 550 kDa. It is synthesized in liver.
3. **Apo-B-48.** Major apoprotein of chylomicrons. It is synthesized only in intestinal cells. Apo-B-100 and apo-B-48 are products of the same gene, but in the intestine, the mRNA undergoes editing, so as to produce the B-48 protein (Fig. 13.11). B-48 is so named because it is only 40% of the size of B-100.



4. **Apo-C-II.** Activates lipoprotein lipase.
5. **Apo-E.** Arginine rich protein. It is present in chylomicrons, LDL and VLDL. Astrocytes also make apo-E; it is involved in cellular transport of lipids in CNS. Apo E has I, II, III and IV isoforms, due to independent alleles in the genes. Apo E-IV isoform is implicated in the development of senile dementia and **Alzheimer's** disease. Apo-E is also associated with lipoprotein **glomerulopathy**.

## CHYLOMICRONS

### Synthesis of Chylomicrons

Chylomicrons are formed in the **intestinal mucosal** cells, and secreted into the lacteals of lymphatic system

(see Chapter 12). They are **rich in triglyceride** (Fig. 13.9). If lipemic serum is kept overnight in the refrigerator, chylomicrons rise as a creamy layer to the top, leaving the supernatant clear. When the chylomicrons are synthesized by

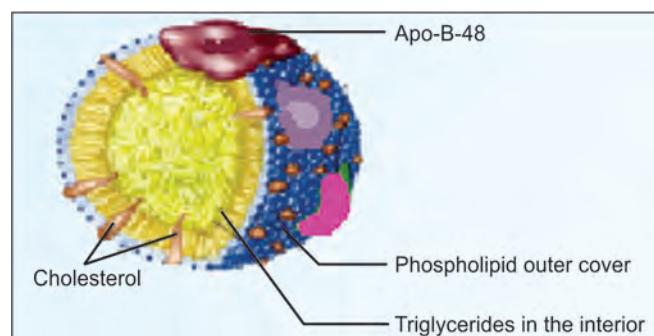


Fig. 13.9: Structure of chylomicrons

TABLE 13.3: Characteristics of different classes of lipoproteins

	Chylomicron	VLDL	IDL	LDL	HDL	FFA (*)
Density g/L	<0.95	0.95–1.006	1.006–1.019	1.019–1.063	1.063–1.121	1.28–1.3
Diameter (nm)	500	70	30	25	15	-
Electrophoretic mobility	origin	pre-beta	broad beta	beta	alpha	albumin
% Composition						
Protein	2	10	20	20	30-60	99
TAG	80	50	30	10	10	0
Phospholipids	10	20	20	20	20-30	0
Cholesterol	10	20	30	50	10-30	0
FFA	0	0	0	0	0	1
Apoproteins	A,B-48,C-II,E	B-100, C-II,E	B-100, E	B-100	A-I, C, E	Albumin
Transport function	TAG from gut to muscle and adipose tissue	TAG from liver to muscle and adipose tissue		Cholesterol from liver to peripheral tissues	Cholesterol from peripheral tissues to liver	FFA from adipose T to muscle and liver

(\*) Free fatty acids are not generally included in the lipoproteins. They are seen in circulation, weakly bound to albumin.

TABLE 13.4: Characteristics of apoproteins and their functions

Apoprotein	Component of	Functions	Molecular weight	Blood level mg/dL	Site of production
apo A-I	HDL	Activation of LCAT; ligand for HDL receptor; Anti-atherogenic	28,000	150	Intestine; liver
apo A-II	HDL	Inhibits LCAT; stimulates lipase	17,000	30	Intestine; liver
apo B-100	LDL; VLDL	Binds LDL receptor	550,000	100	Liver
apo B-48	Chylomicrons	48% size of B-100. Major structural apoprotein of chylomicrons	250,000	-	Intestine
apo C-I	Chylo; VLDL	Activation of LCAT; anti atherogenic	7,000	10	Liver
apo E	LDL; VLDL; chylomicron	Arginine rich; ligand for hepatic uptake	30,000	2	Liver
apo Lp(a)	Lp(a)	Attached to B-100; impairs fibrinolysis; highly atherogenic		< 30	Liver



the intestinal mucosa, they contain only **apo-B-48** and apo-A but apo-C and apo-E are added from HDL in blood during transport (Fig. 13.10).

## Metabolism of Chylomicrons

- Main sites of metabolism of chylomicrons are **adipose tissue** and **skeletal muscle**. The half-life of chylomicrons in blood is about 1 hour.
- The enzyme **lipoprotein lipase (LpL)** is located at the endothelial layer of capillaries of adipose tissue, muscles and heart; but not in liver. **Apo C-II** present in the chylomicrons activates the LpL (Table 13.4). The LpL hydrolyzes triglycerides present in chylomicrons into fatty acids and glycerol. Muscle or adipose tissue cells take up the liberated fatty acids (Fig. 13.10).
- Following injection of **heparin**, the LpL is released from the tissues and lipemia is thus cleared. This is called **post-heparin lipolytic activity**. Lack of C-II leads to decreased activity of LpL and consequent accumulation of chylomicrons and VLDL in blood. **Insulin** increases LpL activity.

## Liver Takes up Chylomicron Remnants

As the TAG content is progressively decreased, the chylomicrons shrink in size. These remnants containing apo B-48 and apo E are taken up by hepatic cells by receptor

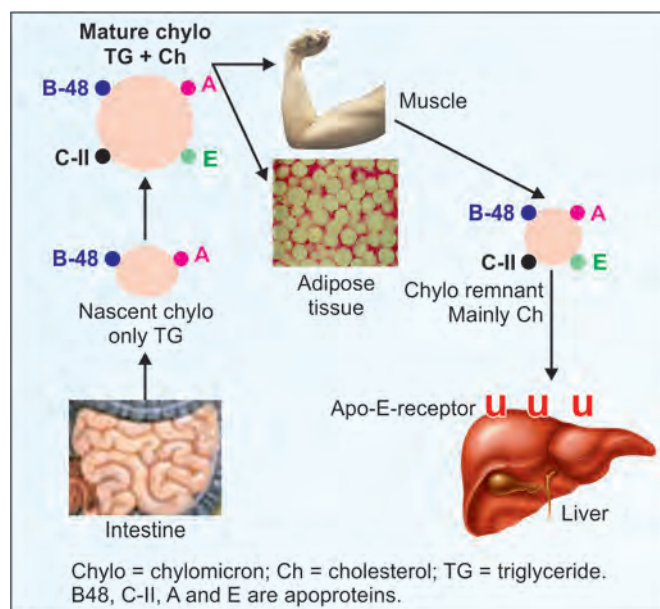


Fig. 13.10: Metabolism of chylomicrons

mediated endocytosis. **Apo E binds the hepatic receptors** (Fig. 13.10).

## Function of Chylomicrons

Chylomicrons are the transport form of dietary triglycerides from intestines to the adipose tissue for storage; and to muscle or heart for their energy needs.

## VERY LOW DENSITY LIPOPROTEINS

### Synthesis of VLDL

They are synthesized in the liver from glycerol and fatty acids and incorporated into VLDL along with hepatic cholesterol, apo-B-100, C-II and E. **Apo-B-100** is the major lipoprotein present in VLDL when it is secreted. ApoE and C-II are obtained from HDL in plasma.

### Metabolism of VLDL

The half-life of VLDL in serum is only 1 to 3 hours. When they reach the peripheral tissues, **apo C-II activates LpL** which liberates fatty acids that are taken up by adipose tissue and muscle. The remnant is now designated as **IDL (intermediate density lipoprotein)** and contains less of TAG and more of cholesterol (Table 13.3 and Fig.13.18). The major fraction of IDL further loses triglyceride, so as to be converted to LDL (low density lipoprotein). This conversion of VLDL to IDL and then to LDL is referred to as **lipoprotein cascade pathway** (Fig.13.18). A fraction of IDL is taken up by the hepatic receptors.

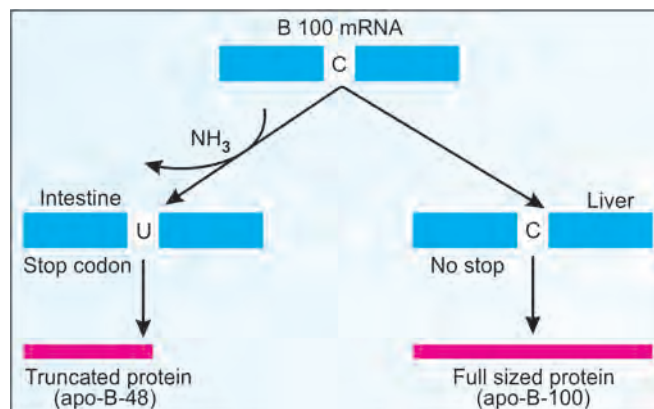


Fig.13.11: Apo-B-48 and Apo-B-100 are produced from the same gene. In liver, the mRNA is translated as usual (B100). But in intestine, a particular cytosine residue is de-aminated, to become uracil. So, a stop codon is generated in the middle, and a short protein is produced in intestine (B48). Apo-B48 is only 48% of the size of B100

## Function of VLDL

The VLDL carries triglycerols (**endogenous triglycerols**) from liver to peripheral tissues for energy needs.

## LOW DENSITY LIPOPROTEINS

Low density lipoproteins (LDL) transports cholesterol from liver to peripheral tissues. The only apoprotein present in LDL is **apo B100** (Fig.13.12). Most of the LDL particles are derived from VLDL, but a small part is directly released from liver. The half-life of LDL in blood is about 2 days.

## Metabolism of LDL and LDL Receptors

The LDL is taken up by peripheral tissues by receptor-mediated endocytosis (Fig. 13.13). LDL receptors are present on all cells but most abundant in hepatic cells. LDL receptors are located in specialized regions called **clathrin-coated pits** (Fig.13.13). Binding of LDL to the receptor is by apo B100 and uptake of cholesterol from LDL is a highly regulated process. The LDL receptor is a polypeptide of 839 amino acids. An extracellular domain is responsible for apoB-100/apoE binding. The intracellular domain is responsible for the clustering of LDL receptors into regions of the plasma membrane termed coated pits. When the apo B-100 binds to the apo-B-100 receptor, the receptor-LDL complex is internalized by endocytosis.

The endosome vesicle thus formed fuses with lysosomes. The receptor is recycled and returns to the cell surface. The LDL particle, along with apoproteins and cholesterol ester are hydrolyzed by lysosomal hydrolases, forming amino acids and free cholesterol. The free receptors can now return to the membrane surface to bind further LDL molecules (Fig. 13.13). Approximately 70% of LDL is degraded in the liver, and the rest in extra-hepatic tissues. For their work on LDL receptors, Michael Brown and Joseph Goldstein were awarded Nobel prize in 1985.

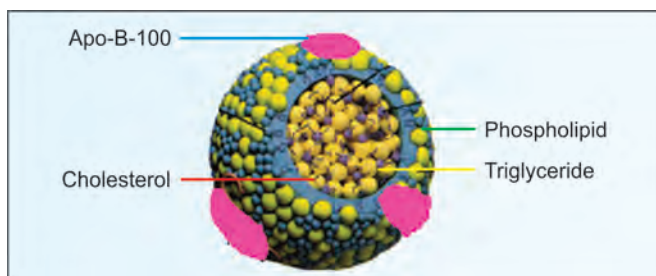


Fig. 13.12: Low density lipoprotein (LDL)

The free cholesterol is either incorporated into plasma membranes or esterified (by ACAT) and stored within the cell. The level of intracellular cholesterol is regulated through cholesterol-induced suppression of LDL receptor synthesis and cholesterol-induced inhibition of cholesterol synthesis. The increased level of intracellular cholesterol that results from LDL uptake activates ACAT, thereby allowing the storage of excess cholesterol within cells. However, the effect of cholesterol-induced suppression of LDL receptor synthesis is to decrease the rate at which LDLs and IDLs are removed from the serum. This can lead to excess circulating levels of cholesterol. The excess cholesterol tends to be deposited within the arteries, leading to atherosclerosis.

## LDL Receptor-Related Proteins (LRPs)

The LDL receptor-related protein family represents a group of structurally related transmembrane proteins involved in a diverse range of biological activities including lipid metabolism, nutrient transport and protection against atherosclerosis. The LDL receptor (LDLR) family of proteins (LRPs) include LRP1, LRP1b, LRP2 (also called megalin), LRP4 (also called MEGF7 for multiple epidermal growth factor-like domains protein 7), LRP5/6, LRP8 (also called apolipoprotein E receptor 2), and VLDL receptor (VLDLR).

LRP1 is also known as CD91 or alpha-2 macroglobulin receptor. This receptor is expressed in numerous tissues and is known to be involved lipoprotein transport, modulation of platelet derived growth factor receptor- $\beta$  (PDGFR $\beta$ ) signaling, regulation of cell-surface protease activity, and the control of cellular entry of bacteria and viruses. Regulation of PDGFR $\beta$  activity mediates the protective effects of LRP1 in development of atherosclerosis.

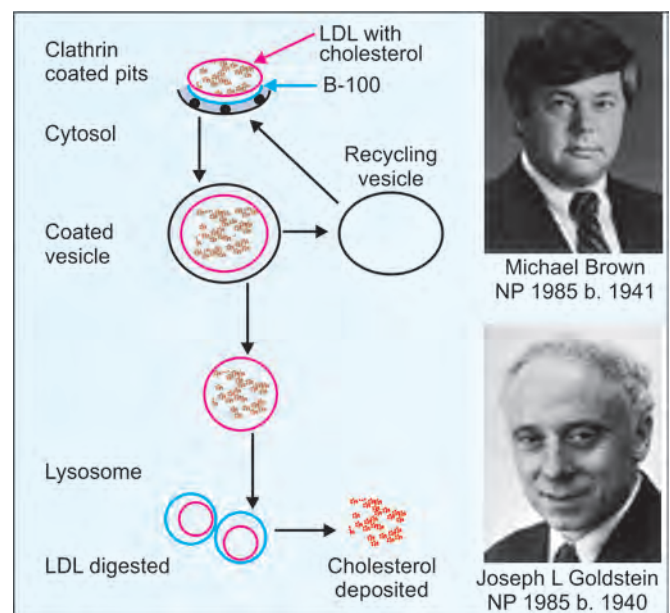


Fig. 13.13: Uptake and fate of LDL

LRP2 is found in the apical surfaces of epithelial borders as well as intracellularly in endosomes. In the proximal convoluted tubule of the kidney LRP2 is involved in the reabsorption of numerous molecules. LRP2 binds lipoproteins, hormones, vitamins, vitamin-binding proteins, proteases and, protease inhibitor complexes.

## Function of LDL

About 75% of the plasma cholesterol is incorporated into the LDL particles. LDL transports cholesterol **from liver to the peripheral tissues**. The cholesterol thus liberated in the cell has three major fates:

- It is used for the synthesis of other steroids like steroid hormones.
- Cholesterol may be incorporated into the membranes.
- Cholesterol may be esterified to a MUFA by acyl cholesterol acyl transferase (ACAT) for storage. The cellular content of cholesterol regulates further endogenous synthesis of cholesterol by regulating HMGCoA reductase.

## LDL and Clinical Applications

The LDL concentration in blood has positive correlation with incidence of **cardiovascular diseases**. A fraction of cholesterol is taken up by macrophages; this is not a regulated pathway. Increased levels of LDL or modification of LDL by glycation (as seen in diabetes mellitus) or oxidation increases the fraction of cholesterol taken up by

macrophages. LDL infiltrates through arterial walls, and are taken up by macrophages or scavenger cells. This is the starting event of **atherosclerosis** leading to myocardial infarction (see coronary artery diseases in Chapter 25). When these cells become engorged with cholesterol, foam cells are formed, that get deposited in the sub-endothelial space triggering formation of atheromatous plaque (see Fig. 25.3). Procoagulant changes are induced in the endothelium resulting in increased chances of thrombosis and coronary artery disease (see Fig. 25.4).

Since LDL-cholesterol is thus deposited in tissues, the LDL (low density lipoprotein) variety is called "**bad cholesterol**" in common parlance (Fig. 13.14 and Box 13.2).

Insulin and tri-iodothyronine (T3) increase the binding of LDLs to liver cells, whereas glucocorticoids have the opposite effect. The effects of insulin and T3 on hepatic LDL binding may explain the hypercholesterolemia and increased risk of atherosclerosis that have been shown to be associated with uncontrolled diabetes or hypothyroidism.

An abnormal form of LDL, identified as lipoprotein-X (**Lp-X**), predominates in the circulation of patients suffering from lecithin-cholesterol acyl transferase (**LCAT**, see HDL discussion for LCAT function) deficiency or cholestatic liver disease. In both cases, there is an elevation in the level of circulating free cholesterol and phospholipids.

Defects in LDL receptor synthesis leads to familial hypercholesterolemia, which is further described in Chapter 25.

### Box 13.2: LDL cholesterol is "bad"

LDL, especially oxidized and glycated LDL, creates a pro-coagulant surface on the endothelium, causing blood clot formation. Oxidized LDL is found in higher levels in cigarette smokers, patients with diabetes mellitus and in insulin resistance.

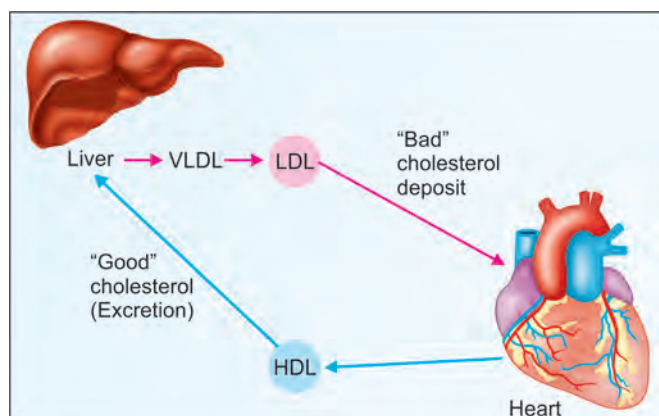


Fig. 13.14: Forward and reverse transport of cholesterol

## Scavenger Receptors

Macrophages ingest a variety of negatively charged macromolecules that includes modified LDLs. Macrophage scavenger receptors are type I, type II, class A receptors, class B receptors, mucin-like receptors, and endothelial receptors. After binding ligand the scavenger receptors can either be internalized, similar to the process of internalization of LDL receptors, or they can remain on the cell surface and transfer lipid into the cell through caveolae. The endothelial receptors bind oxidized LDL and are called the LOX-1 receptors.

### Box 13.3: Lp(a) and apo-A are different

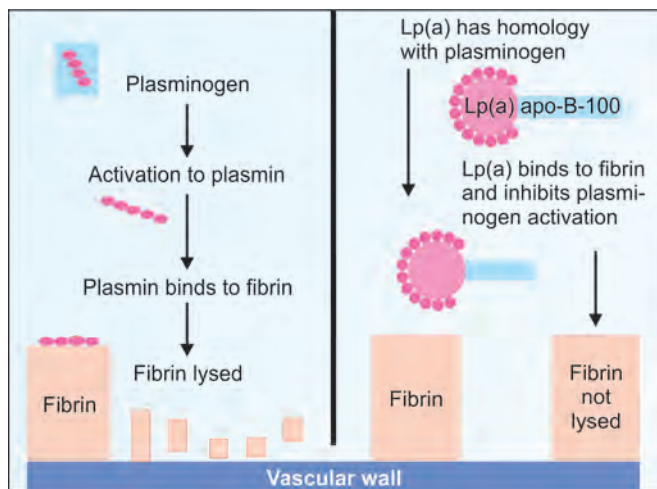
**Apo-A** is a constituent of HDL. This "A" is always written in capital letters. It is seen in all persons. It is anti-atherogenic.

**Lp(a)** is seen in high levels only in some persons. When present, it is associated with LDL. This "a" is always written in small letters. It is highly atherogenic and connected with heart attacks in younger age group.



## Lipoprotein (A)

- i. Lipoprotein (a) or **Lp(a)** should not be confused with apo A (Box 13.3). Lp(a) is very strongly associated with **myocardial infarction** and is sometimes called the “little rascal”.
- ii. Lp(a), when present, is attached to apo B-100 by a disulfide bond.
- iii. In 40% population, there is no detectable level of Lp(a) in serum. In 20% of population, the Lp(a) concentration in blood is more than 30 mg/dL; and these persons are susceptible for heart attack at a younger age.
- iv. Lp(a) is associated with heart attacks at the age of 30 or 40 years. *Indians have a higher level of Lp(a) than Western populations.*



**Fig. 13.15:** Lp(a) competitively inhibits plasminogen activation; and so inhibits fibrinolysis

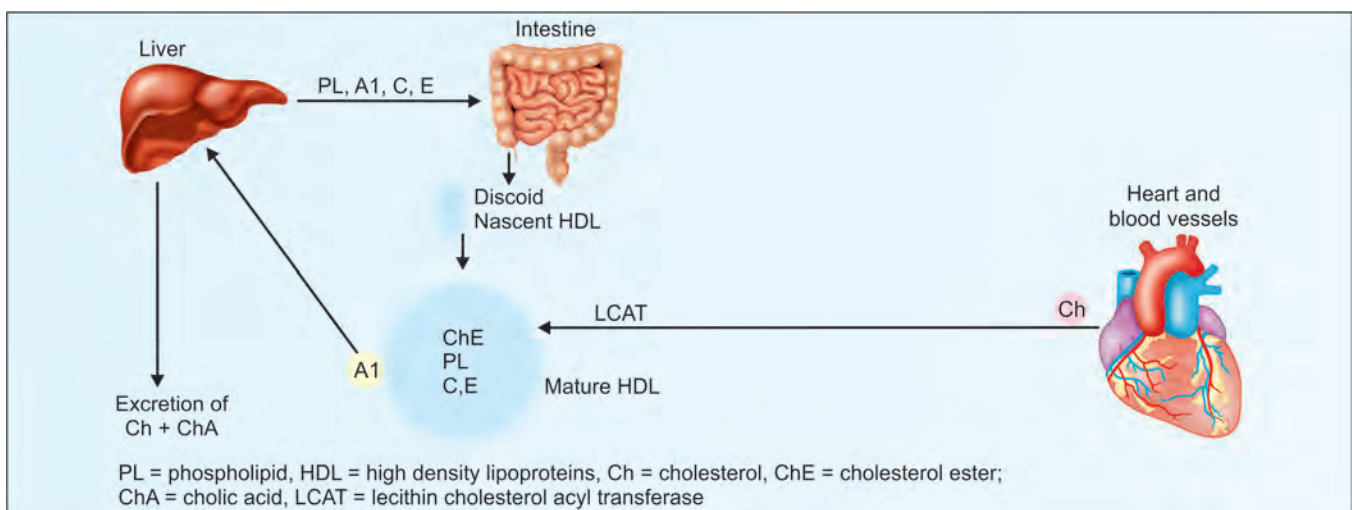
- v. Lp(a) has significant homology with **plasminogen**. So, it interferes with plasminogen activation and impairs fibrinolysis (Fig.13.15). This leads to unopposed intravascular thrombosis and possible myocardial infarction.

## HIGH DENSITY LIPOPROTEIN

High density lipoproteins (HDL) transport cholesterol from peripheral tissues to the liver. The major apoproteins in HDL are Apo A1, with some Apo A2, Apo C and Apo E. HDL serves as a plasma reservoir of Apo C and Apo E which can be transferred to VLDL and chylomicrons and back.

### Metabolism of HDL

- i. The intestinal cells synthesize components of HDL and release into blood. The nascent HDL in plasma are discoid in shape (Fig. 13.16).
- ii. The free cholesterol derived from peripheral tissue cells are taken up by the HDL. The **apo A-I** of HDL activates **LCAT** (lecithin cholesterol acyl transferase) present in the plasma. The LCAT then binds to the HDL disc. The reaction is shown in Figure 13.17. The cholesterol from the cell is transferred to HDL by a **cholesterol efflux regulator protein** which is an ABC protein.
- iii. **Lecithin** is a component of phospholipid bilayer of the HDL disc. Structure of lecithin is shown in Chapter 7. The second carbon of lecithin contains one molecule of polyunsaturated fatty acid (**PUFA**). It is transferred to the third hydroxyl group of cholesterol to form



**Fig. 13.16:** HDL metabolism



- cholesterol ester. The esterified cholesterol which is more hydrophobic, moves into the interior of the HDL disc.
- iv. This reaction continues; till HDL becomes spherical with lot of cholesterol esters are formed. This HDL particle designated as **HDL3**.
  - v. Mature HDL spheres are taken up by liver cells by **apo A-1** mediated receptor mechanism (Figs 13.16 and 13.18). HDL is taken up by **hepatic scavenger receptor B1**. Hepatic lipase hydrolyzes HDL phospholipid and TAG, and cholesterol esters are released into liver cells. The cholesterol that reaches the liver is used for synthesis of bile acids or excreted as such in bile.
  - vi. When HDL3 remains in circulation, the cholesterol ester from HDL is transferred to VLDL, IDL and LDL by a **Cholesterol Ester Transfer Protein (CETP)**. This will help to relieve product inhibition of LCAT so that more cholesterol can be taken up. Triacyl glycerol from VLDL, IDL and LDL is transferred to HDL in exchange for the cholesterol ester. The HDL particles that are rich in triacylglycerol and spherical are called

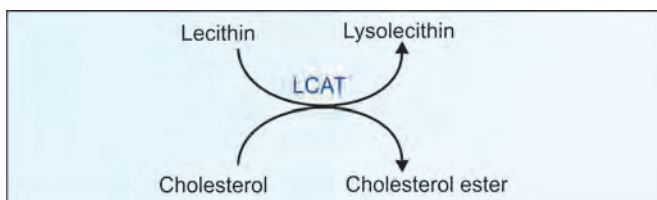


Fig. 13.17: Lecithin cholesterol acyl transferase (LCAT)

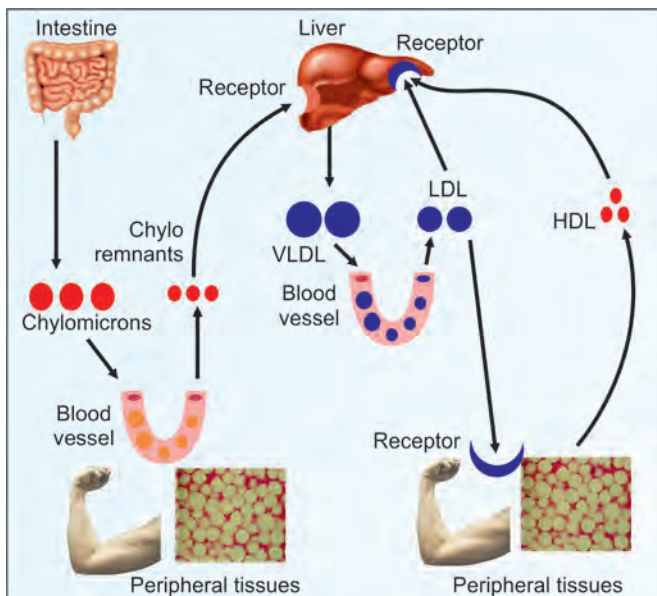


Fig. 13.18: Summary of lipoprotein metabolism

**HDL2**. These particles are first acted upon by **hepatic triglyceride lipase (HTGL)** before being taken up by scavenger B1 receptors in liver.

- vii. The efflux of cholesterol from peripheral cells to HDL is mediated by the ABC transporter protein. The reverse cholesterol transport to liver through HDL needs the activity of LCAT, CETP and Apo-D.

## Functions of HDL

- i. HDL is the main transport form of cholesterol from **peripheral tissue to liver**, which is later excreted through bile (Table 13.3). This is called **reverse cholesterol transport** by HDL.
- ii. The only excretory route of cholesterol from the body is the bile.
- iii. Excretion of cholesterol needs prior esterification with PUFA. Thus *PUFA will help in lowering of cholesterol in the body*, and so **PUFA is anti-atherogenic**.

## Clinical Significance of HDL

The level of HDL in serum is inversely related to the incidence of myocardial infarction. As it is "**anti-atherogenic**" or "protective" in nature, HDL is known as "**good cholesterol**" in common parlance (Fig. 13.14). It is convenient to remember that "H" in HDL stands for "Healthy". HDL level below 35 mg/dL increases the risk, while level above 60 mg/dL protects the person from coronary artery diseases. A summary of the lipoprotein metabolism is shown in Figure 13.18.

## HDL Specific Receptors

The main receptor for taking up HDL is the **Scavenger Receptor B1 (SR-B1)**. In liver, this receptor binds the HDL with the help of apo A-1. Then cholesterol is internalised, but the HDL particle and apo A-1 are not taken up. In the tissues, the SR-B1 accepts the cholesterol into the HDL. Thus SR-B1 has a dual role in HDL metabolism.

The SR-B1 protein is the endogenous receptor for HDLs in the liver. Additionally, the HDL-SR-B1 interaction in the adrenal glands is the mechanism for the delivery of cholesterol to the steroid hormone synthesizing cells of this tissue. HDLs first bind to SR-B1 and then the cholesteryl esters present in the HDLs are transferred to the membrane for uptake via caveolae. This ligand-receptor interaction is also involved in the removal of cholesterol from cells by HDLs in the process of reverse cholesterol transport.

## HDL Related Transport Proteins

The reverse transport of cholesterol from tissues to liver needs two transporters; ABC-A1 (**ATP binding cassette transporter A1**) and ABC-G1. The ABC-G1 is helping the transport of cholesterol from cells to HDL. ABC-A1 helps efflux of cholesterol into apo-A1 in the discoid HDL.

## FREE FATTY ACID (FFA)

- It is also known as non-esterified fatty acids (**NEFA**). (Table 13.3). It is complexed with **albumin** in plasma.
- The FFA is derived from lipolysis of triglyceride stored in adipose tissue by **hormone sensitive lipase** (see Chapter 12). Free fatty acids may be either long chain saturated or unsaturated fatty acids.
- The FFA molecules are transported to heart, skeletal muscle, liver and other soft tissues. The free fatty acids are either oxidized to supply energy or incorporated into tissue lipids by esterification.
- In the tissue cells, FFA-albumin complex is dissociated, FFA binds with a **Fatty acid transport protein**. It is a co-transporter with sodium. After entry into the cell, the FFA is bound to **Fatty acid binding protein**.
- The half-life of free fatty acids in plasma is very short; only 1–2 minutes. During starvation, about 40–50% energy requirement of the body is met by oxidation of FFA.
- Blood level of FFA is very low in the fully fed condition, high in the starved state, and very high in uncontrolled diabetes mellitus.

## Cholesterol and Beta Cells of Pancreas

The accumulation of cholesterol in beta-cells causes perturbations in glucose metabolism, reduces insulin secretion and can be associated with a diabetic phenotype. Cholesterol is also a key determinant of beta-cell membrane organization and cell survival. The ATP-binding cassette transporter A1, which effluxes cholesterol to lipid-free/lipid-poor apolipoprotein A-I, the principal apolipoprotein in HDL, is crucial for maintaining beta-cell cholesterol homeostasis and function. There is also evidence suggesting that different lipoprotein classes have varying effects on beta-cell function and survival. Cholesterol is important for beta-cell function and survival. It can cause beta-cell loss if allowed to accumulate in the cells in an unregulated manner. The maintenance of beta-cell cholesterol homeostasis, therefore, is important for preventing the onset of insulin resistance and the development of type 2 diabetes.



Adolph Strecker  
1822–18971



Adolf Otto  
Windaus  
NP 1928  
1876–1959



Heinrich Otto  
Wieland  
NP 1927  
1877–1957

## Oxidized Metabolites

In contrast to their parent molecule cholesterol, the **oxidized metabolites** are able to cross the blood-brain barrier. There is a concentration-driven flux of 24-hydroxycholesterol (24-OHC) from the brain into the circulation, which is of major importance for elimination of excess cholesterol from the brain. The opposite flux of 27-hydroxycholesterol (27-OHC) from the circulation into the brain may regulate a number of key enzymes within the brain. In vitro experiments suggest that the balance between the levels of these two molecules may be of importance for the generation of beta-amyloid peptides. In primary cultures of rat hippocampal cells 27-OHC is able to suppress expression of the activity regulated cytoskeleton-associated protein (ARC), a protein important in memory consolidation which is reduced in patients with Alzheimer's disease (AD).

## Functions of Cholesterol

- Precursor of all steroid compounds in the body like bile acids, steroid hormones (see Chapter 52) and vitamin D3 (see Chapter 36).

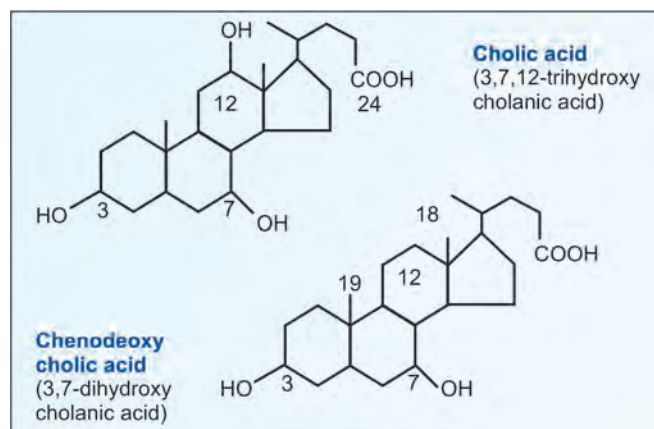


Fig. 13.19: Structure of primary bile acids

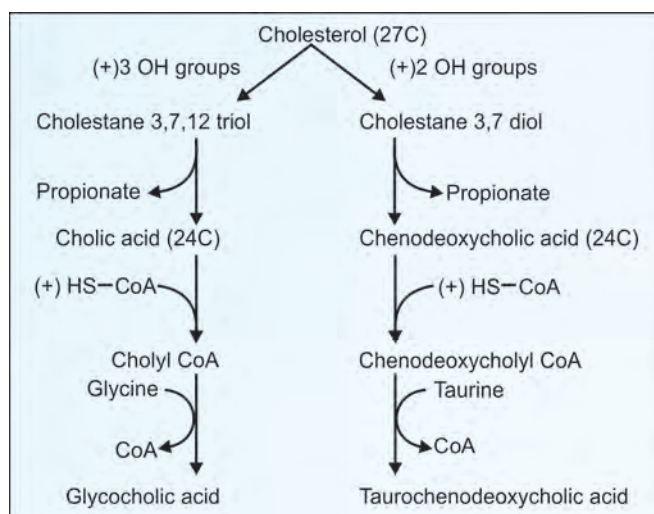


Fig. 13.20: Formation of bile salts

- Cholesterol is an essential component of biomembranes. Since it has a high dielectric constant, its presence on nerve sheaths has an insulating effect during the transmission of nerve impulses.

**Note:** The steroid ring is not degraded in the human body. Cholesterol is not used for providing energy.

## FORMATION OF BILE ACIDS

Bile salts were first crystallized by Plattner in 1844. Correct elementary formula of cholic acid ( $C_{24}H_{40}O_5$ ) was reported by Adolph Strecker in 1848, and that of cholesterol ( $C_{27}H_{46}O$ ) by Reinitzer in 1888. Windaus (Nobel prize, 1928) in 1918 showed the conversion of cholesterol to bile acid. Complete structural analysis was done by Heinrich Wieland in 1918, who got Nobel prize in 1927.

Bile acids are synthesized in the liver from cholesterol. They contain **24 carbon** atoms. All of them have an alpha-oriented (projecting below the plane of ring) hydroxyl group at position 7. The reactions for synthesis of bile acids are summarized below:

- Cholesterol hydroxylated at 3/7/12 positions
- Removal of 3-carbon unit, to make it 24 C
- Conjugation with glycine
- Secretion into intestinal canal
- In the intestine, deconjugation and removal of hydroxyl groups.

### Hydroxylation Reactions

The first and **rate-limiting** step is the introduction of this hydroxyl group by the enzyme **7-alpha-hydroxylase**. It is a microsomal enzyme. Then the beta-oriented OH group of C3 is converted to alpha type by an isomerase. A third OH group is added at 12th carbon in the case of Cholic acid.

**Chenodeoxycholic acid**, another primary bile acid has only two hydroxyl groups at positions 3 and 7. (Fig.13.19). Ring B is reduced in all cases.

### Removal of 3 Carbon Unit

The side chain is first hydroxylated at 26 C and then oxidized to COOH group. This is followed by cleavage at 24 C, with removal of propionic acid (3 carbon) unit.

### Formation of Bile Salts

The primary bile acids are now conjugated with either **glycine** or **taurine** to form bile acids. They are glycocholic acid, taurocholic acid, glycochenodeoxy cholic acid and taurochenodeoxy cholic acid (Fig. 13.20). The major conjugated bile acid is glycocholic acid. Conjugation adds more polar groups and increases the efficiency of bile acids as surfactants. The conjugated bile acids are excreted through the bile. In the bile they exist as bile salts (sodium or potassium salts of conjugated bile acids).

### Secondary Bile Acids/Bile Salts

Primary bile acids are acted upon by intestinal bacteria which result in deconjugation. The deconjugated bile acids are then partly converted to secondary bile acids by removal of the alpha hydroxyl group at position 7.

Cholic acid is thus converted to deoxycholic acid and chenodeoxycholic acid to lithocholic acid (Fig. 13.20).

## Functions of Bile Salts

They facilitate the digestion of lipids. They can form molecular aggregates called **micelle** which bring about the absorption of lipids. Bile salt micelle also plays an important role in keeping the cholesterol in solution.

During the last two decades, it has been discovered that bile acids are regulatory molecules. Bile acids have been discovered to activate specific nuclear receptors (farnesoid X receptor, pregnane X receptor, and vitamin D receptor), G protein coupled receptor TGR5 (TGR5), and cell signaling pathways (c-jun N-terminal kinase 1/2, AKT, and ERK 1/2) in cells in the liver and gastrointestinal tract. Activation of nuclear receptors and cell signaling pathways alter the expression of numerous genes encoding enzyme/proteins involved in the regulation of bile acid, glucose, fatty acid, lipoprotein synthesis, metabolism, transport, and energy metabolism. Bile acids appear to function as nutrient signaling molecules primarily during the feed/fast cycle as there is a flux of these molecules returning from the intestines to the liver following a meal. Bile acid-controlled signaling pathways are promising novel drug targets to treat common metabolic diseases, such as obesity, type 2 diabetes, hyperlipidemia, and atherosclerosis.

## Enterohepatic Circulation of Bile Salts

Of the total bile salts reaching the intestine (15–30 g/day) only a very small fraction, about 300–500 mg/day is excreted through feces (Fig. 13.6C). The rest is reabsorbed from ileum, reaches liver and re-excreted through bile. This is referred to as the enterohepatic circulation. When bile acid binding resin (cholestyramine) is given, the re-absorption of bile acids is inhibited. Hence more cholesterol gets converted to bile acids and cholesterol is decreased.

### Regulation of Cellular Sterol Content

Regulation is brought about primarily by sterol-regulated transcription of key rate limiting enzymes and by the regulated degradation of HMGR. Activation of transcriptional control occurs through the regulated cleavage of the membrane-bound transcription factor sterol regulated element binding protein, **SREBP**. Degradation of HMGR is controlled by the ubiquitin-mediated pathway for proteolysis.

SREBP is the transcription factor that binds to SRE-1 (sterol regulatory element) SREBP-2 controls the sterol biosynthetic enzymes and regulates expression of the LDL receptor gene.

High sterols activate expression of the SREBP-1 gene but do not exert this effect on the SREBP-2 gene. The sterol-mediated activation of the SREBP-1 gene occurs via the action of the liver X receptors (LXRs). The LXRs are members of the cytosolic ligand binding receptors that migrate to the nucleus upon ligand binding and regulate gene expression by binding to specific target sequences. All 3 SREBPs are proteolytically activated and the proteolysis is controlled by the level of sterols in the cell. The C-terminal domain (CTD) interacts with a protein called

SREBP cleavage-activating protein (**SCAP**). SCAP is found in the ER membrane. The C-terminal portion of SCAP interacts with the C-terminal domain of SREBP. The regulation of SREBP activity is further controlled within the ER by the interaction of SCAP with insulin regulated protein (**Insig**). When cells have sufficient sterol content, SREBP and SCAP are retained in the ER via the SCAP-Insig interaction. SCAP functions as the cholesterol sensor. When cells have sufficient levels of sterols, SCAP will bind cholesterol which promotes the interaction with Insig and the entire complex will be maintained in the ER.

When sterols are scarce, SCAP does not interact with Insig. Under these conditions the SREBP-SCAP complex migrates to the Golgi where SREBP is subjected to proteolysis. The cleavage of SREBP is carried out by 2 distinct enzymes. This cleavage is catalyzed by site-1 protease, **S1P**. The function of SCAP is to positively stimulate S1P-mediated cleavage of SREBP. The second cleavage, catalyzed by site-2 protease, **S2P**, leads to release of active SREBP.

Niemann-Pick disease type C1 (NPC1) protein is involved in cholesterol transport in the secretory pathway. NPC1 gene when disrupted, leads to severe neurological dysfunction.

## Bile

It is the chief secretion of liver, the largest gland in the body. Daily volume of secretion is about 500 mL. The secreted bile is stored in the gallbladder and released on demand. The pH of bile in hepatic duct is 7.8, and in gall bladder is 7.4. An enzyme present in bile is alkaline phosphatase.

**Secretion of Cholera** are substances which stimulate the secretion of bile by the liver. **Cholagogues** stimulate the release of bile from the gall bladder. The most important cholagogues are bile salts, the hormone **secretin** and vagal stimulation. **Cholecystokinin** is the most powerful cholagogue. The release of cholecystokinin itself is stimulated by fatty acids and amino acids in duodenum.

## Functions of Bile

1. The alkaline pH of the bile serves to neutralize the acidity of the gastric juice.
2. The bile salts are efficient surfactants and detergents.
3. Bile is the only route of excretion for bilirubin, the end product of heme catabolism.
4. It serves to excrete cholesterol, thus regulating the body cholesterol pool.

5. Bile serves as the medium of excretion for several drugs, which are detoxified by the liver.

## Solubilization of Cholesterol in Bile

The relative concentration of cholesterol in the bile favors the precipitation and resultant stone formation; it is referred to lithogenic bile. Bile salts and phospholipids in the bile play a significant role in keeping the cholesterol in solution by forming mixed micelle. Infections of the gallbladder may predispose to stone formation. Dehydration may also lead to precipitation of cholesterol crystals.

## Cholesterol and Cardiac Diseases

The level of cholesterol in blood is related to the development of **atherosclerosis**. Abnormality of cholesterol metabolism may lead to cardiovascular accidents and heart attacks. Please see Chapter 25 for details.

## QUICK LOOK OF CHAPTER 13

1. Cholesterol has a cyclopentanoperhydrophenanthrene ring with a total of 27 carbon atoms. Acetyl CoA is the precursor of cholesterol.
2. The rate limiting enzyme of the cholesterol biosynthetic pathway is HMG CoA reductase.
3. Normal serum cholesterol range is 150–200 mg%.
4. Lipoproteins are of 5 major types; Chylomicrons, VLDL, IDL, LDL and HDL.
5. Chylomicrons help in the transfer of triglycerides from the intestine to the muscle and adipose tissue.
6. VLDL help in the transfer of triglycerides from the liver to the peripheral tissues.
7. LDL carry cholesterol from the liver to the heart, while HDL carries cholesterol from the heart to the liver.
8. LDL is ‘bad’ cholesterol and HDL is ‘good’ cholesterol.
9. Higher concentration of Lipoprotein (a) or Lp(a) increases risk of a myocardial infarction.



# CHAPTER 14

## MCFA, PUFA, Prostaglandins and Compound Lipids

### Chapter at a Glance

The reader will be able to answer questions on the following topics:

- Medium chain fatty acids (MCFA)
- Monounsaturated fatty acids (MUFA)
- Polyunsaturated fatty acids (PUFA)
- Saturation and desaturation of fatty acids
- Essential fatty acids
- Eicosanoids
- Prostaglandins
- Leukotrienes
- Very long chain fatty acids (VLCFA)
- Glycerophosphatides
- Phosphatidyl choline synthesis
- Sphingolipid and sphingomyelin synthesis
- Lipid storage diseases

Fatty acids having carbon atoms 4 to 6 are called **small chain fatty acids** (SCFA); those with 8 to 14 carbon atoms are known as **medium chain fatty acids** (MCFA); those with 16 to 18 carbon atoms are **long chain fatty acids** (LCFA); and those carrying 20 or more carbon atoms are named as **very long chain fatty acids** (VLCFA) (see Table 7.3).

The SCFAs, butyric acid (4C) and caproic acid (6C) are seen in butter and ghee; the name butyric is derived from butter. MCFAs, capric acid (10C), lauric acid (12C) and myristic acid (14C) are present in coconut oil and **human milk**. Normal skin has a very thin layer of sebum secretion with MCT (medium chain triglyceride) containing lauric acid, which prevents bacterial entry into the body.

### Digestion of Medium Chain Fatty Acids

- i. Digestion and metabolism of SCFAs and MCFAs are entirely different from those of LCFAs. Small and

medium chain fatty acids containing triglycerides (SCT and MCT) do not require prolonged digestion.

- ii. **Pancreatic lipase and bile salts are not required.** MCT-specific lipase catalyzes the complete hydrolysis of SCT / MCT into glycerol and small/medium chain fatty acids.
- iii. These free MCFAs **diffuse directly into portal circulation.**
- iv. SCFA and MCFA are preferentially oxidized by peripheral cells, and so they are not deposited in adipose tissues. A comparison is given in Table 14.1.

### Very Long Chain Fatty Acids (VLCFA)

Fatty acids having 20 or more carbon atoms are called very long chain fatty acids (VLCFA). Eicosapentaenoic acid (**EPA**) (C-20, 5 double bonds) and docosahexaenoic acid (**DHA**) (C-22, 6 double bonds) are good examples of VLCFA.

DHA is synthesized in liver from linolenic acid (Omega-3, C-18, 3 double bond). DHA is available in large quantities in **fish oils**. DHA is especially required for the development of **brain and retina**. Low level of DHA in blood is seen in patients with **retinitis pigmentosa**.

In human beings, DHA is accumulated in brain before birth and for up to 12 weeks afterwards. Outer segments of retinal rods contain high concentrations of DHA, which gives high fluidity to the membranes. This is required for the lateral and rotational movement of **rhodopsin** within the membrane during photo-activation.

Lignoceric acid (C-24, saturated), nervonic acid (C-24, 1 double bond) and cerebronic (C-24, saturated hydroxy acid) are other VLCFAs seen in substantial quantities in brain, and are components of sphingomyelins.

VLCFAs (20 C and above) are partly oxidized in peroxisomes to smaller (18 C) fatty acids, which then leave peroxisomes to enter mitochondria. This **peroxisomal oxidation** differs from beta oxidation in that the electrons from FADH<sub>2</sub> (step 1 of beta oxidation) are directly donated to oxygen to form **hydrogen peroxide**. So this step does not produce ATP. Peroxisomal production of hydrogen peroxide is one mechanism to **kill bacteria** by neutrophils. The unwanted hydrogen peroxide is then detoxified by catalase. Catalase is the marker enzyme for peroxisomes.

Deficient oxidation of VLCFA by peroxisomal enzyme systems leads to **adrenoleukodystrophy** (see Chapter 2), where VLCFAs are accumulated and myelin sheaths are destroyed. It is an X-linked condition. The child usually dies during the first decade of life.

In **Zellweger syndrome**, peroxisomes are empty or peroxisomal enzymes are not transported correctly into peroxisomes (see Box 46.1). Zellweger syndrome, adrenoleukodystrophy and infantile Refsum's disease are together classified as **Peroxisomal biogenesis disorders**.

## MONOUNSATURATED FATTY ACIDS (MUFA)

Palmitoleic (C16, 1 double bond) and oleic (C18, 1 double bond) acids are present in human body fat, as well as many vegetable oils. Erucic acid (C22, 1 double bond) is a constituent of mustard oil and rapeseed oil. Nervonic acid (C24, 1 double bond) is present in substantial quantities in brain.

### Modified beta-oxidation of MUFA

The oxidation of unsaturated fatty acids proceeds as in the case of saturated fatty acids, till the double bond is reached. Thus palmitoleic acid (16 C monounsaturated) undergoes 3 cycles of beta-oxidation to yield  $\Delta^3$ -cis enoyl CoA with 10 carbon atoms. Here the double bond is cis type; the dehydrogenase cannot act on that bond. Therefore, an **isomerase** changes the cis  $\Delta^3$  double bond to  $\Delta^2$ -trans double bond. The double bond between 3rd and 4th carbon atoms is shifted to between 2nd and 3rd carbon atoms. It will then undergo 2nd, 3rd and 4th step reactions of beta oxidation (see Fig. 12.9). So in this cycle the **FAD dependent dehydrogenation** (1st step in Fig.12.9) is **not needed**. Thus in the case of unsaturated fatty acids, the **energy yield is less by 1.5 ATP molecules per double bond**,

**TABLE 14.1:** Differences in metabolisms of SCFA and LCFA containing triglycerides

	<i>Small and medium chain fatty acids</i>	<i>Long chain fatty acids</i>
Examples	Butyric acid (C4) in butter and lauric acid (C12) in coconut oil	Palmitic acid (C16) and stearic acid (C18) in vegetable oils and animal fats
Digestion in stomach	Hydrolyzed	Not hydrolyzed
Pancreatic lipase	Not necessary	Essential
Bile salts	Not necessary	Absolutely essential
Inside intestinal cells	TAG is hydrolyzed to form fatty acids	Free fatty acids are re-esterified to form TAG
Absorbed	Directly to blood	To lymphatics, then to thoracic duct
Absorbed as	Free fatty acid carried by albumin	TAG, carried by chylomicrons
Immediate fate	Oxidized by peripheral cells	Deposited in the adipose tissue
Carnitine	Not required for oxidation	Required for oxidation
Clinical application	No effect on atherosclerosis	Hypercholesterolemia and atherosclerosis

because the FAD dependent dehydrogenation (step 1 of beta-oxidation) does not occur at the double bond. Compare the energy yield from saturated fatty acid, given in Chapter 12.

Oxidation of **very long chain fatty acids** (VLCFA) (more than 20C atoms) begins in peroxisomes and once the chain length reaches 20C, they undergo beta oxidation.

## POLYUNSATURATED FATTY ACIDS (PUFA)

The important poly unsaturated fatty acids are:

1. **Linoleic acid** (18 C, 2 double bonds)
2. **Linolenic acid** (18 C, 3 double bonds)
3. **Arachidonic acid** (20 C, 4 double bonds)

They are present in good quantities in **vegetable oils** such as sunflower oil (see Fig. 7.2, Table 7.4).

They are used to esterify cholesterol, whereby the latter can be excreted. So, PUFA in general are **anti-atherogenic** (see Chapters 13 and 25). Functions of PUFA are shown in Box 14.1. Clinical manifestations of PUFA / EFA deficiency are shown in Box 14.2.

Other PUFAs belonging to very long chain fatty acids (VLCFA) are timnodonic acid (20C, 5 double bonds); clupanodonic acid (22 C, 5 double bonds) and cervonic acid (22 C, 6 double bonds). They are present in **fish oils**. They are important for development of human brain.

### Box 14.1: Significance of PUFA

1. PUFAs are seen in vegetable oils.
2. Linoleic and linolenic acids are nutritionally essential; and are called Essential Fatty Acids.
3. Prostaglandins, thromboxanes and leukotrienes are produced from arachidonic acid.
4. PUFAs form integral part of mitochondrial membranes. In deficiency of PUFA, the efficiency of biological oxidation is reduced.
5. They are components of membranes. Arachidonic acid is 10–15% of the fatty acids of membranes.
6. As double bonds are in cis configuration; the PUFA molecules cannot be closely packed. So PUFAs will increase the fluidity of the membrane.
7. As PUFAs are easily liable to undergo peroxidation, the membranes containing PUFAs are more prone for damage by free radicals.
8. The production of DHA (docosahexaenoic acid) is synthesized to a limited extent from alpha linolenic acid. DHA is present in fish oils. DHA is present in high concentrations in retina, cerebral cortex and sperms.

## Lipid Peroxidation

In vitro, peroxidation would lead to rancidity of fats and oils. In vivo the membrane lipids are more liable to attack by free radicals and produce damage to the integrity of the membrane (see Chapter 33). In naturally occurring lipids anti-oxidants prevent lipid peroxidation. Vitamin E or tocopherol is an important antioxidant in the human body.

### Elongation of Fatty Acids

The **Microsomal system** (microsomal fatty acid elongase system) elongates saturated or unsaturated fatty acyl CoA by successive addition of two-carbon units. Malonyl CoA is the donor of two carbon acetyl groups. NADPH is required for the reaction. This system can elongate fatty acids having 10 carbon units onwards up to the length of 22 or 24 carbons. The steps in elongation are similar to de novo synthesis.

- a. Acyl CoA (10C in length) + malonyl CoA to produce 3-keto acyl CoA (12C). Enzyme is 3-keto acyl CoA synthase. One molecule of carbon dioxide is released in this reaction.
- b. 3-keto acyl CoA is reduced to 3-hydroxy acyl CoA. Enzyme is 3-keto acyl CoA reductase. NADPH is needed.
- c. One water molecule is removed from 3-hydroxy acyl CoA to make 2-trans enoyl CoA, with the help of 3-hydroxy acyl CoA dehydrase.
- d. 2-trans enoyl CoA is reduced to acyl CoA (12 C) with the help of transenoyl CoA reductase and NADPH.

This is repeated till the necessary length is achieved. Finally CoA is removed from the molecule.

## Desaturation of Fatty Acids

Monounsaturated fatty acids can be synthesized from saturated fatty acids by a  $\Delta^9$  desaturase enzyme system present in the **endoplasmic reticulum**. The reaction utilizes NADH and molecular  $O_2$  and cytochrome b5. Thus stearic acid is desaturated to form oleic acid.

### Box 14.2: Clinical significance of PUFA and EFA

1. Persons with normal diet will not have any deficiency; but those who are on parenteral nutrition for long periods will have deficiency.
2. PUFAs are used for esterification and excretion of cholesterol. PUFA will reduce serum cholesterol level (see Chapter 13)
3. Deficiency of EFA causes acanthocytosis, hyperkeratosis, acrodermatitis and hypercholesterolemia.
4. EFA deficiency is connected with acrodermatitis enteropathica, hepatorenal syndrome and CNS manifestations.
5. Elevated PUFA levels are seen in Zellweger's syndrome.
6. DHA levels in blood are low in patients with retinitis pigmentosa.
7. Trans fatty acids will compete with EFAs, and may increase the EFA deficiency and decrease fluidity of membranes.
8. Trans fatty acids decrease HDL-cholesterol and may cause atherosclerosis.

The PUFA may be formed from monounsaturated fatty acids by the introduction of double bonds only between an existing double bond and carboxyl end of the fatty acid (but not between the omega end and an existing double bond). Hence, linoleic acid cannot be synthesized from oleic acid. However, **linoleic acid can be converted to arachidonic acid** by elongation and desaturation (Fig. 14.1).

## Essential Fatty Acids (EFA)

Normal dietary allowance of PUFA is 2–3% of total calories. **Linoleic acid** ( $\omega$  6, 18C,  $\Delta$  9,12) and **linolenic acid** ( $\omega$ 3, 18C,  $\Delta$  9,12,15) are the only fatty acids which cannot be synthesized in the body. Their structures are shown in Figure 8.2. They have to be provided in the food; hence they are essential fatty acids. Arachidonic acid can be formed, if the dietary supply of linoleic acid is sufficient. For deficiency manifestations of EFA, please see Box 14.2. The relation of PUFA with cholesterol is described in Chapters 13 and 25.

## Gamma-Linolenic Acid (GLA)

It is an essential fatty acid of the omega-6 family. In the body, GLA is produced from linoleic acid. GLA is desaturated to arachidonic acid (AA). GLA may prevent cardiovascular diseases by dilating blood vessels, lowering blood pressure, and preventing atherosclerosis. GLA inhibits the growth of tumors and the spread of cancer. Dietary sources of GLA are plant-seed oils of primrose, black currant, and borage. GLA is also found in human milk.

## Clinical Significance of Omega-3, and Omega-6 PUFAs

The term omega refers to the terminal carbon atom farthest from the functional carboxylic acid group ( $-\text{COOH}$ ). Thus, an omega-3 fatty acid has a site of unsaturation between the third and fourth carbons from the omega end. There are three major types of omega-3 fatty acids in foods;

these are ALA (alpha linolenic acid), eicosapentaenoic acid (EPA), and docosahexaenoic acid (DHA). The body converts ALA to EPA and then to DHA. EPA and DHA serve as important precursors for lipid-derived modulators of cell signaling, gene expression and inflammatory processes.

Most of the ALA consumed in the diet comes from fruits and nuts (walnuts, hazelnuts). The highest concentrations of EPA and DHA are found in cold water fishes such as salmon, tuna, and herring. The most important PUFAs, biologically, are EPA and DHA. Although ALA can serve as the precursor for EPA and DHA synthesis in humans, this pathway is limited in its capacity and also varies between individuals. Therefore, direct dietary intake of omega-3 fats rich in EPA and DHA are of more benefit clinically.

Most of the omega-6 PUFAs consumed in the diet are from vegetable oils such as soybean oil, corn oil, etc. Linoleic acid is converted to arachidonic acid (Fig. 14.1). The activity of the  $\Delta$ 6-desaturase is slow and can be further compromised due to nutritional deficiencies as well as during inflammatory conditions. Maximal capacity for synthesis of arachidonic acid occurs with ingested gamma-linolenic acid (GLA). GLA is converted to dihomo- $\gamma$ -linolenic acid (DGLA) and then to arachidonic acid. Most of the DGLA formed from GLA are inserted into membrane phospholipids at the same C-2 position as for arachidonic acid.

When omega-3 and omega-6 fatty acids are consumed they are incorporated into cell membranes in all tissues of the body. These membrane lipids serve as precursors for the synthesis of important signaling molecules involved in cell growth and development as well as modulation of inflammation.

The most important omega-6 PUFA is arachidonic acid. When cells are stimulated by a variety of external stimuli, arachidonic acid is released from cell membranes through the action of phospholipase A<sub>2</sub> (PLA<sub>2</sub>). The released arachidonate then serves as the precursor for the synthesis of the biologically active eicosanoids, the prostaglandins (PGs), thromboxanes (TXs), and leukotrienes. (LTs) The arachidonate-derived eicosanoids function in diverse biological phenomena, such as platelet and leukocyte activation, signaling of pain, induction of bronchoconstriction, and regulation of gastric secretions. These activities are targets of numerous



John R Vane  
NP 1982  
1927–2004



Ulf von Euler  
NP 1970  
1905–1983



Bengt Samuelsson  
NP 1982  
b. 1934

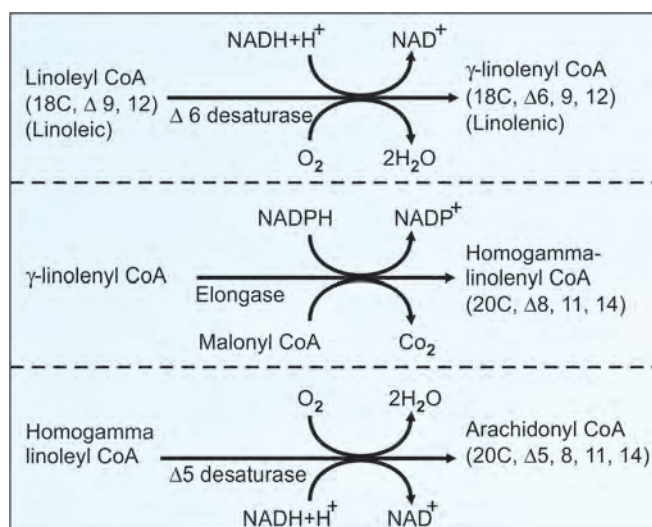


Fig. 14.1: Desaturation and elongation of linoleic acid to arachidonic acid



pharmacological agents, such as the non-steroidal anti-inflammatory drugs (NSAIDs), COX-2 inhibitors, and leukotriene antagonists.

Dietary omega-3 PUFAs compete with the pharmacological activities of omega-6 PUFAs because they displace arachidonic acid from cell membranes. The net effect of increasing dietary consumption of omega-3 PUFAs, relative to omega-6 PUFAs, is to decrease the potential for leukocytes to synthesize mediators of inflammation and to reduce the ability of platelets to release TXA<sub>2</sub>, a stimulator of the coagulation process.

Probably the most important role of the omega-3 PUFAs, EPA and DHA, is that they serve as the precursors for potent anti-inflammatory lipids called resolvins (Rvs) and protectins (PDs). The Rvs exert their anti-inflammatory actions by promoting the resolution of the inflammatory cycle, hence the derivation of their names as resolvins. The resolvins are synthesized either from EPA or DHA. The D series resolvins are derived from DHA and the E series from EPA. An additional anti-inflammatory lipid derived from DHA is protectin D1 (PD1). The E series resolvins reduce inflammation, decrease neutrophil infiltration, diminish T cell mediated inflammatory responses and lead to resolution of the inflammatory responses.

### Saturated and Trans Fatty Acids

Hydrogenation of vegetable oil produces saturation of the double bonds; the product is called Margarine or **Vanaspathy**. During the hydrogenation process, some cis double bonds are made into trans configuration. Fatty acids with trans double bonds (Trans fatty acids) are injurious to health. They decrease fluidity of membranes; decrease HDL-cholesterol, increase LDL-cholesterol and may cause atherosclerosis.

## EICOSANOIDS

They are 20 C compounds (Greek, eikosi = twenty), derived from arachidonic acid. Their names are:

1. Prostanoids, containing:
  - a. Prostaglandins (PGs);
  - b. Prostacyclins (PGIs);
  - c. Thromboxanes (TXs)
2. Leukotrienes (LTs)

## PROSTAGLANDINS

Prostaglandins (PGs) were first isolated by Ulf von Euler in 1935 (Nobel prize in 1970). In 1982, Nobel prizes were awarded to Bengt Samuelsson (biosynthesis of PGs) and Sir John Vane (effect of aspirin on PGs). PGs were originally isolated from prostate tissue and hence the name. But they are present in almost all tissues. They are the **most potent biologically active substances**; as low as one ng/mL of PG will cause smooth muscle contraction. The diverse physiological roles of prostaglandins confer on them the status of **local hormones**.

## Chemical Structure

All prostaglandins are considered to be derived from the 20 C cyclic saturated fatty acid, prostanoic acid (Fig. 14.2A). The five carbon ring is saturated. All naturally occurring PGs have an alpha-oriented **OH group at C15**.

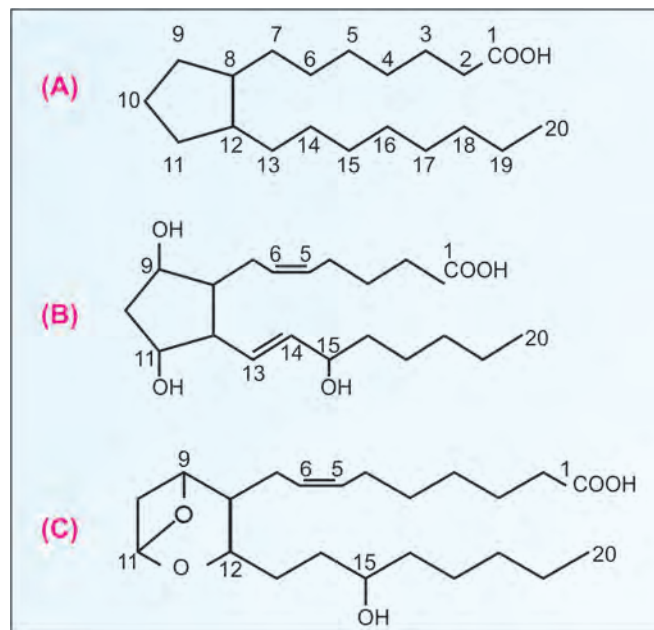
## Classification of Prostaglandins

According to the attachment of different substituent groups to the ring, PGs are named with capital letters such as A, B, E and F (Table 14.2). PGF is designated as alpha to denote the projection of the OH group in naturally occurring prostaglandins.

In the same series, depending on number of double bonds on the side chains they are denoted by a subscript after the capital letter, e.g. PGE<sub>1</sub>, PGE<sub>2</sub>, PGE<sub>3</sub>, etc. (Table 14.2).

1. Series 1 contains 1 double bond at 13–14 (trans)
2. **Series 2** have 2 double bonds at 13–14 (trans) and 5–6 (cis). This is the **most common variety**.
3. Series 3 have 3 double bonds, 13–14 (trans) 5–6 (cis) and 17–18 (cis).

The primary prostaglandins PGG and PGH, (the endoperoxides) are intermediates in the synthesis of others. **Only 5 PGs are widely distributed in the body.** They are PGD<sub>2</sub>, PGE<sub>2</sub>, PGF<sub>2</sub> and PGI<sub>2</sub> and thromboxane A<sub>2</sub>.



**Figs 14.2A to C:** (A) Prostanoic acid; (B) Prostaglandin-F<sub>2</sub>; (C) Thromboxane A<sub>2</sub>

**TABLE 14.2:** Salient features of prostaglandins

Name	Substituent groups
PGA	Keto group at C9; double bond C10 and 11
PGB	Keto group at C9; double bond C8 and 12
PGD	OH group at C9; keto group at C11
PGE	Keto group at C9; OH group at C11
PGF	OH groups at C9 and C11 (Fig.14.2)
PGG	Two oxygen atoms, interconnected to each other, and bonded at C9 and C11; hydroperoxide group at C15
PGH	Same ring as PGG; but C15 has OH group
PGI	Double ring. Oxygen attached to C6 and C9, to form another 5-membered ring. Hence called prostacyclin.

Structure of PGF<sub>2</sub> is shown in Figure 14.2B. Thromboxanes have 6 membered oxane ring (Fig.14.2C).

## Biosynthesis of Prostaglandins

Prostaglandins are derived from the PUFA, the three series being derived from the following fatty acids.

- 1 series (1 double bond)—from Linoleic acid
- 2 series (2 double bonds)—from Arachidonic acid
- 3 series (3 double bonds)—Eicosa penta-enoic

Naturally occurring PGs belong to the 2 series.

- i. PGs are not stored as such; the precursor fatty acids are stored in membrane as phospholipids. The arachidonic acid is released by the action of **phospholipase A2** on phospholipids (Fig.14.3).
- ii. Synthesis is catalyzed by prostaglandin H synthase (**PGHS**). It contains two separate enzyme activities, **cyclo-oxygenase** and peroxidase.
- iii. PGG<sub>2</sub> and PGH<sub>2</sub> are formed as intermediates during the synthesis of other PGs. Specific enzymes convert PGH<sub>2</sub> to other prostaglandins (Fig. 14.3).

## Regulation of Synthesis

- iv. The **phospholipase (PL)** is activated by epinephrine, thrombin, angiotensin II, bradykinin and vasopressin. Steroids inhibit PL and prevent release of arachidonic acid from membranes (Fig.14.3).
- v. **Cyclo-oxygenase** is activated by catecholamines and inhibited by non-steroid anti-inflammatory drugs (NSAIDs). **Aspirin** acetylates serine at the active site and irreversibly inhibits the cyclo-oxygenase (Box 14.3).
- vi. Cyclo-oxygenase is a "**suicide**" enzyme, self catalyzed destruction rapidly inactivates the enzyme (see suicide

inhibition in Chapter 5). This would prevent excessive production of PGs.

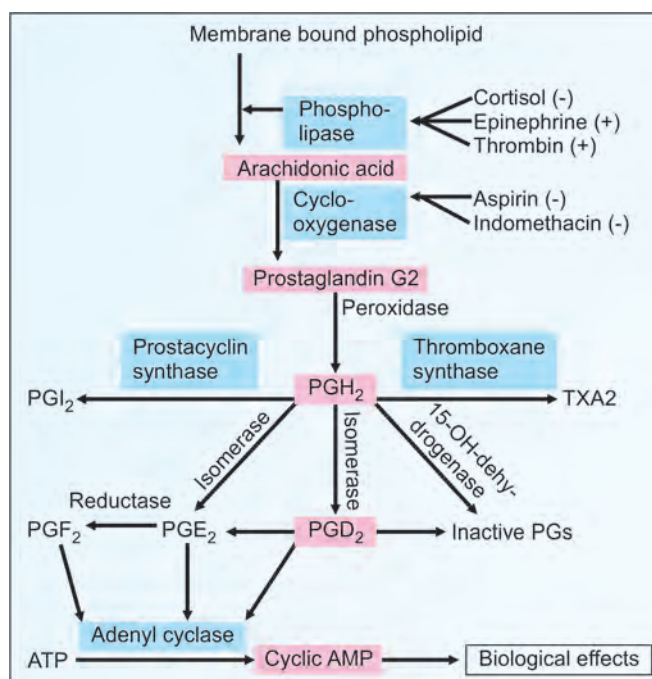
- vii. Cyclo-oxygenase exists in two different forms. COX-1, the **constitutive form** produces prostaglandins, that mediate gastric, renal and platelet functions. The **inducible form** mediates the inflammatory response.
- viii. Prostaglandins have only very short half-life, of about 30 seconds. They are inactivated by the 15-hydroxy-prostaglandin-**dehydrogenase** which converts 15-OH group to keto group (Fig.14.3).

## Mechanism of Action

Prostaglandins are **local hormones**. They function through G-protein coupled receptors (see Chapter 50). In most tissues,

### Box 14.3: Mechanism of action of aspirin

Aspirin irreversibly acetylates and inhibits **cyclo-oxygenase**. Platelets cannot regenerate cyclo-oxygenase and so thromboxane A<sub>2</sub> is not formed in platelets. Hence, there is decreased platelet aggregation. Therefore, aspirin is useful in prevention of **heart attacks**. By inhibiting cyclo-oxygenase, aspirin also reduces PGI<sub>2</sub>; but endothelial cells after a few hours will resynthesize cyclo-oxygenase. So aspirin completely blocks TXA<sub>2</sub>, but only partially inhibits PGI<sub>2</sub>. Other anti-inflammatory drugs (*indomethacin and ibuprofen*) also cause irreversible inhibition of enzyme. **Paracetamol** is a reversible inhibitor.



**Fig. 14.3:** Synthesis and action of prostaglandins

PGE increases cAMP (**cyclic AMP**) level. But in adipose tissue and in renal tubular cells, PGE lowers cAMP level. PGI activates adenyl cyclase and TXA inhibits it (Fig.14.3).

## Biological Actions and Clinical Applications

### Effects on CVS

**Prostacyclin** or PGI<sub>2</sub> is synthesized by the vascular endothelium. Major effect is **vasodilatation**. It also **inhibits platelet aggregation** and has a protective effect on vessel wall against deposition of platelets. But any injury to the vessel wall would inhibit PGI<sub>2</sub> synthesis so that platelet aggregation occurs to promote thrombus formation.

**Thromboxane** (TXA<sub>2</sub>) is the main PG produced by platelets. The major effects are **vasoconstriction** and **platelet aggregation**. Prostacyclin and thromboxane are opposing in activity (Table 14.3). Prostaglandins lower the blood pressure.

### Effects on Ovary and Uterus

The PGF<sub>2</sub> stimulates the uterine muscles. Hence PGF<sub>2</sub> may be used for medical **termination of pregnancy**. Yet another use is in **inducing labor** and arresting postpartum **hemorrhage**. PGs are involved in LH induced ovulation. In cattle, if PG is given, luteolysis takes place and animal goes into estrus. Better fertilization rate is achieved with timely artificial insemination.

### Effects on Respiratory Tract

The PGF is a constrictor of bronchial smooth muscle; but PGE is a potent **bronchodilator**. PGE series are used in aerosols for relieving bronchospasm.

### Effects on Immunity and Inflammation

The PGE<sub>2</sub> and D<sub>2</sub> produce inflammation by increasing capillary permeability. Erythema and wheal are produced

at the site of injury. The anti-inflammatory effect of PG synthesis inhibitor (aspirin; cortisol) is explained in Box 14.3. Moreover, PGE<sub>2</sub> reduces both T and B cell functions. PGE<sub>2</sub> is a sleep promoting substance.

### Effects on Gastrointestinal Tract

PGs in general inhibit gastric secretion and increase intestinal motility. The inhibitory effect on gastric secretion is used therapeutically in treatment of **acid peptic disease**. But diarrhea may be an unwanted side effect.

### Metabolic Effects

The metabolic effects may be through the action of hormones by the modulating effect on cAMP production. Prostaglandin E<sub>2</sub> decreases lipolysis, increases calcium mobilization from bone and glycogen synthesis.

### Leukotrienes (LTs)

They are produced **from arachidonic acid**. The pathway is shown in Fig.14.4. LT B<sub>4</sub> is produced in neutrophils; it is the most potent **chemotactic** agent (factor attracting cells to the inflammatory site). The number 4 denotes that there are 4 double bonds in the structure. The 12-lipo-oxygenase in platelets produces 12-HETE (hydroxy eicosa tetra-enoic acid) and 15-lipo-oxygenase in eosinophils produce 15-HETE. The **slow reacting substance of anaphylaxis** (**SRS-A**) contains LTC<sub>4</sub>, LTD<sub>4</sub> and LTE<sub>4</sub>. They cause smooth muscle contraction, constrict the bronchioles, increase capillary permeability, activate leukocytes and produce vasoconstriction. SRS is the mediator of hypersensitivity reactions such as asthma.

Incorporation of DGLA into membrane phospholipids competes with the incorporation of arachidonate so that diets enriched in GLA result in an alteration in the ratio of membrane arachidonate to DGLA. Release of membrane DGLA occurs through the action of PLA<sub>2</sub> just as for release of arachidonate. Once DGLA is released it will compete with arachidonate for COXs and LOXs. The products of COX action on DGLA are series-1 prostaglandins (PGE<sub>1</sub>) and thromboxanes (TXA<sub>1</sub>). PGE<sub>1</sub> and TXA<sub>1</sub> are anti-inflammatory, they induce vasodilation, and inhibit platelet aggregation. When DGLA is a substrate for 15-LOX the product is 15-hydroxyeicosa trienoic acid (15-HETrE). 15-HETrE is a potent inhibitor of 5-LOX which is the enzyme responsible for the conversion of arachidonic acid to LTB<sub>4</sub>. LTB<sub>4</sub> is a potent inflammatory molecule through its action on neutrophils, thus, DGLA serves to inhibit inflammation via the eicosanoid pathway as well.

### Lipoxins

They are a group of compounds produced by leukocytes. They are conjugated tetrenes. They are formed by sequential action of 5 and 15-lipo-oxygenase. LXA<sub>4</sub> is the most common variety (Fig. 14.4). It is anti-inflammatory and decreases immune response.

**TABLE 14.3:** Prostacyclins and thromboxane

	PGI <sub>2</sub>	TXA <sub>2</sub>
Structure	Cyclopentane ring	Oxane ring
Site of formation	Endothelium	Platelets
Cyclic AMP level	Increased	Decreased
Platelet aggregation	Inhibited	Enhanced
Blood vessel	Vasodilatation	Constriction
Bronchioles	Relaxation	Constriction



## SYNTHESIS OF COMPOUND LIPIDS

Structures of lecithin, cephalin, phosphatidyl inositol, plasmalogen, sphingosine, ceramide and sphingomyelin are shown in Chapter 7. Their metabolisms are described below.

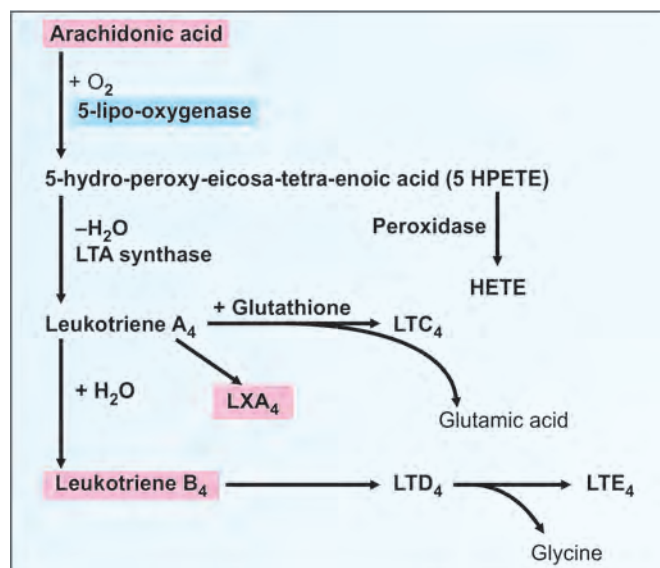


Fig. 14.4: Synthesis of leukotrienes. LT = leukotriene; LXA = lipoxin; HETE = hydroxy eicosatetraenoic acid

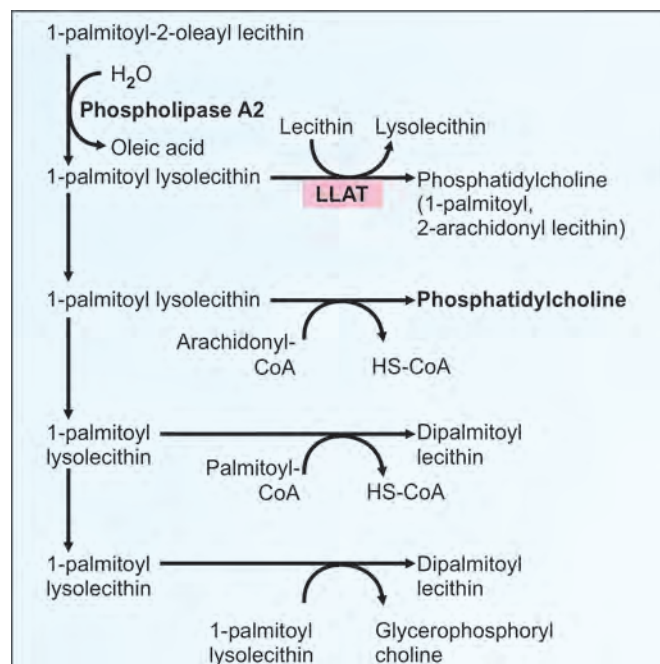


Fig. 14.5: Synthesis of phosphatidylcholine

## Synthesis of Glycerophosphatides

Phosphatidic acid is an important intermediate in the synthesis of phosphoglycerides as well as triacylglycerol. The phosphatidic acid itself may be formed from glycerol-3-phosphate or dihydroxy acetone phosphate (Fig.12.17). The synthesis of glycerophospholipids can occur either by activation to CDP-choline and CDP-ethanolamine or by formation of active diacylglycerol, CDP-diacylglycerol.

## Synthesis of Phosphatidylinositol

In the CDP-diacyl glycerol pathway, phosphatidic acid first reacts with CTP to form CDP diacylglycerol. The CDP diacylglycerol can react with the alcoholic group of serine or inositol to form the corresponding phosphoglyceride and releasing CMP. The phosphatidylinositol undergoes further phosphorylation by a specific kinase to form phosphatidylinositol diphosphate (PIP<sub>2</sub>) which acts as signal transducer.

## Synthesis of Phosphatidyl Choline

The major pathway for lecithin and cephalin synthesis, especially in liver and brain, involves the activation of choline or ethanolamine to phosphorylated derivative and then to form the CDP derivative (Fig.14.6). Finally phosphocholine or phosphoethanolamine is transferred to diacylglycerol to form the corresponding phospholipid.

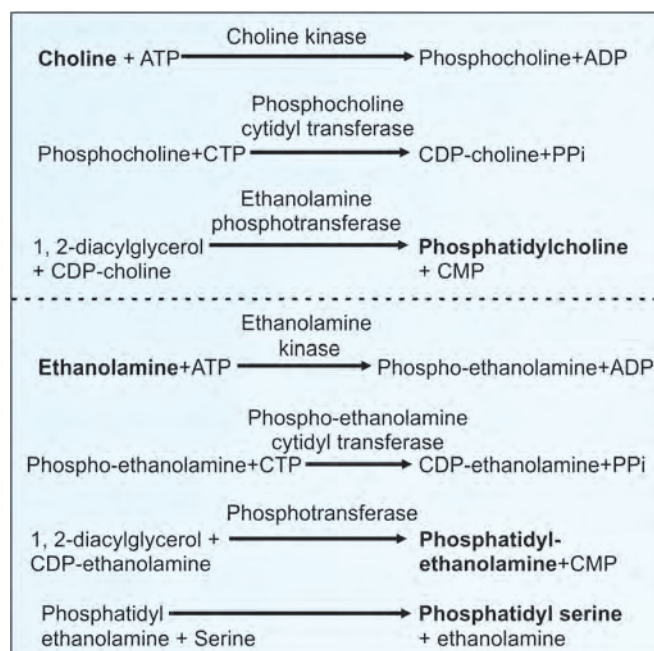


Fig. 14.6: Synthesis of phosphatidyl choline; phosphatidyl ethanolamine; phosphatidyl serine



Phosphatidyl serine can also be formed from phosphatidyl ethanolamine by a base transfer reaction. (Fig.14.6).

The addition of an arachidonic acid to the 2nd carbon of glycerol may be achieved by removal of the fatty acid already present by the action of phospholipase A2. This is followed by addition of an arachidonic acid molecule from arachidonyl-CoA by a specific acyl transferase or from another phospholipid molecule by LLAT (**Lecithin-lysolecithin acyl transferase**) (Fig.14.5). For the formation of the **pulmonary surfactant**, dipalmitoyl lecithin, palmitic acid is added by similar reactions. Lysophospholipids are often the sources of fatty acids for such purposes. Lung surfactants are described in Chapter 7.

### Cardiolipin

It is formed by reaction between CDP diacylglycerol and glycerol-3-phosphate.

### Plasmalogens

They are formed from dihydroxyacetone phosphate by acylation and addition of choline or ethanolamine from a CDP derivative. The final step is the action of a desaturase on the alkyl residue in the 1st carbon atom using molecular oxygen and NADPH to give a plasmalogen, phosphatidyl choline or phosphatidyl ethanolamine.

Yet another important enzyme acting on lecithin is **LCAT** which transfers a PUFA from 2nd carbon of glycerol to cholesterol forming lysolecithin and cholesterol ester (see Chapters 13 and 25).

### Synthesis of Sphingolipids

Sphingolipids may be of two types; phosphosphingolipids and glycosphingolipids. Both types are important components of biomembranes as well as the brain. The most important phosphosphingolipid is **sphingomyelin**. The glycosphingolipids may be cerebrosides, ceramide oligosaccharides and gangliosides. Ceramide is the basic structural unit of all sphingolipids.

#### Synthesis of Ceramide

It is formed from sphingosine and fatty acyl CoA. Sphingosine is formed in the endoplasmic reticulum from palmitoyl CoA and serine in the presence of pyridoxal phosphate (Fig.14.7).

#### Synthesis of Sphingomyelin

Ceramide + CDP choline → Sphingomyelin + CMP  
Ceramide reacts with CDP choline to form sphingomyelin; the reaction being catalyzed by the enzyme CDP choline ceramide phosphocholine transferase.

#### Niemann Pick's disease

This is an inborn error of metabolism due to failure of degradation of sphingomyelin. The enzyme sphingomyelinase is deficient in this condition (Table 14.4).

#### Synthesis of Glycosphingolipids

These carbohydrate containing lipids are synthesized by transfer of an active glycosyl or hexosamine residue from its UDP derivative.

#### Synthesis of Cerebrosides

The two most common are glucocerebroside and galactocerebroside. The transfer of one β-glycosidic bond between the C1 of the hexose and C1 of ceramide is catalyzed by specific glycosyl transferases. Galactocerebroside is an important component of brain lipids (Fig. 14.8)

#### Gaucher's Disease

This is an inborn error of metabolism due to failure of degradation of glucocerebrosides. The enzyme beta glucosidase is deficient in this condition (Table 14.4).

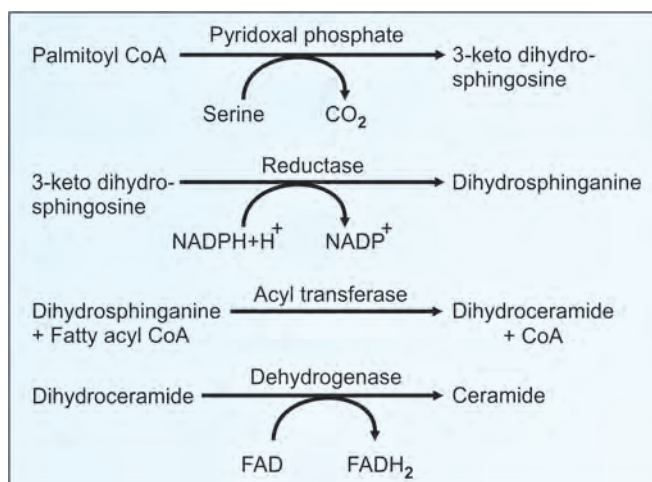


Fig. 14.7: Synthesis of ceramide

### Synthesis of Sulfatides

Cerebroside sulfatides are sulfuric acid esters of cerebroside and the major sulfolipid of brain is galactocerebroside-3-sulfate (Fig.14.8). **PAPS** is phosphoadenosine phosphosulfate or **active sulfate** formed from sulfur containing amino acids (see Chapter 16). The enzyme is  $\alpha$  sulfotransferase.

### Synthesis of Gangliosides

This group of glycosphingolipids contains one or more sialic acid residues. They are present in high concentrations in the CNS and also on surface of membranes. The major gangliosides of brain are GM1, GM2, and GM3. For

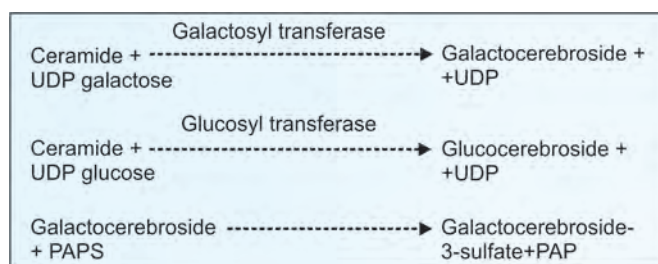


Fig. 14.8: Synthesis of cerebroside sulfatides

ganglioside synthesis, the active form of NANA (N-acetyl neuraminic acid) used is its CMP derivative. The NANA is attached by the hydroxyl group of its 2nd carbon to the 3rd hydroxyl group of sugars. The synthesis is shown in Figure 14.9.

A specific ganglioside on intestinal mucosal cell binds to the  $\beta$  subunit of the **cholera toxin** when the  $\alpha$  subunit enters the cell. It keeps the level of cellular cAMP raised by inhibition of GTPase activity of the G protein (see Chapter 50). Gangliosides also act as receptors for other toxins like tetanus toxin, and toxins of viral pathogens.

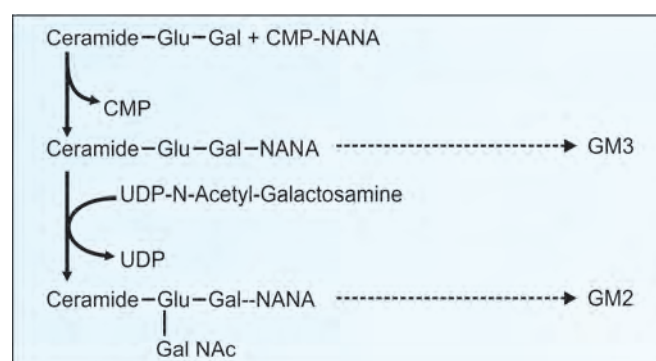


Fig. 14.9: Synthesis of gangliosides

TABLE 14.4: Sphingolipidoses or lipid storage diseases

No	Disease	Enzyme defect	Lipid accumulating	Salient features
1.	Gaucher's disease	$\beta$ -glucosidase	Glucocerebroside	3 types—adult, infantile, juvenile hepatosplenomegaly, erosion of bone, moderate anemia
2.	Niemann-Pick disease	Sphingomyelinase	Sphingomyelin	Severe CNS damage, mental retardation, hepatosplenomegaly Cherry red spot in macula. Death occurs by 2 years of age
3.	Krabbe's leukodystrophy	$\beta$ -galactosidase	Galactocerebroside	Severe mental retardation. Total absence of myelin in CNS Globoid bodies in white matter
4.	Metachromatic leukodystrophy	Sulfatidesulfatase	Sulfogalactocerebroside	Accumulates in most tissues. Neurological deficit, difficulty in speech and optic atrophy. Demyelination is also seen
5.	Fabry's disease	$\alpha$ -galactosidase	Ceramide trihexoside	Kidney is the site of accumulation. Progressive renal failure Death by 5 years of age. Purplish papules appear. 'X' linked inheritance
6.	Tay Sach's disease	Hexosaminidase A	Ganglioside (GM2)	Incidence 1 in 6000 births. Mental retardation. Cherry red spot in the macula. Progressive deterioration. Death by 3–4 years
7.	Generalized gangliosidoses	$\beta$ -galactosidase	Ganglioside (GM1)	Mental retardation, hepatomegaly, skeletal deformities. Foam cells in bone marrow. Cherry red spot in the retina
8.	Lactosyl ceramidoses	$\beta$ -galactosidase	Lactosyl ceramide	Mainly CNS and reticuloendothelial system affected
9.	Sandhoff's disease	Hexosaminidase A and B	Globoside	Neurological deficit, mental retardation

## Tay-Sachs Disease

This is an inborn error of metabolism due to failure of degradation of gangliosides. The enzyme hexosaminidase A is deficient in this condition (Table 14.4).

### Lipid Storage Diseases (Sphingolipidoses)

- They are otherwise called as Sphingolipidoses. They form a group of lysosomal storage diseases.
- The sphingolipids are normally catabolized by a series of bond specific lysosomal hydrolases like alpha and beta glucosidases, galactosidase, neuraminidase, hexosaminidase and arylsulfatase (for sulfate ester hydrolysis) (Fig.14.10).
- The diseases result from failure of breakdown of a particular sphingolipid due to deficiency of a single enzyme.
- The children afflicted by these diseases are severely retarded mentally and seldom survive for long.
- All these diseases can be diagnosed prenatally by amniocentesis and culture of amniotic fluid cells. Since the children born with these diseases will have serious mental deficits, the pregnancy may be terminated. Replacement of deficient enzyme has been tried in Gaucher's disease, with limited success.
- The common features of lipid storage diseases include:
  - Only one type of sphingolipid accumulates.
  - Rate of synthesis of the lipid is normal, only degradation is affected.
  - The extent of the enzyme deficiency is the same in all tissues. A chart showing the salient features of the disease is given in Table 14.4.

## Multiple Sclerosis

It is a demyelinating disease. Phospholipids (ethanol amine plasmalogen and sphingolipids) are lost from white matter of the central nervous system. Cerebrospinal fluid contains increased quantity of phospholipids.

## Clinical Case Study 14.1

A 63-year-old female presents to the clinic with recurrent mid-epigastric pain over the last 3 months. She reports some relief shortly after eating, but then the discomfort returns. She has tried various over-the-counter medications without relief. She also reports feeling tired and has had to increase the amount of ibuprofen needed for relief of her arthritis. She denies nausea,

vomiting, and diarrhea. On examination, she is found to have mild mid-epigastric tenderness. Blood microscopy revealed a microcytic anemia and normal white blood cell count, consistent with iron deficiency. The patient was referred to a gastroenterologist who performed an upper GI endoscopy that identified gastric ulcers. He stated that he suspected that the ibuprofen, a nonsteroidal anti-inflammatory drug (NSAID) was the causative agent and suggested switching from ibuprofen to a coxib, such as celecoxib.

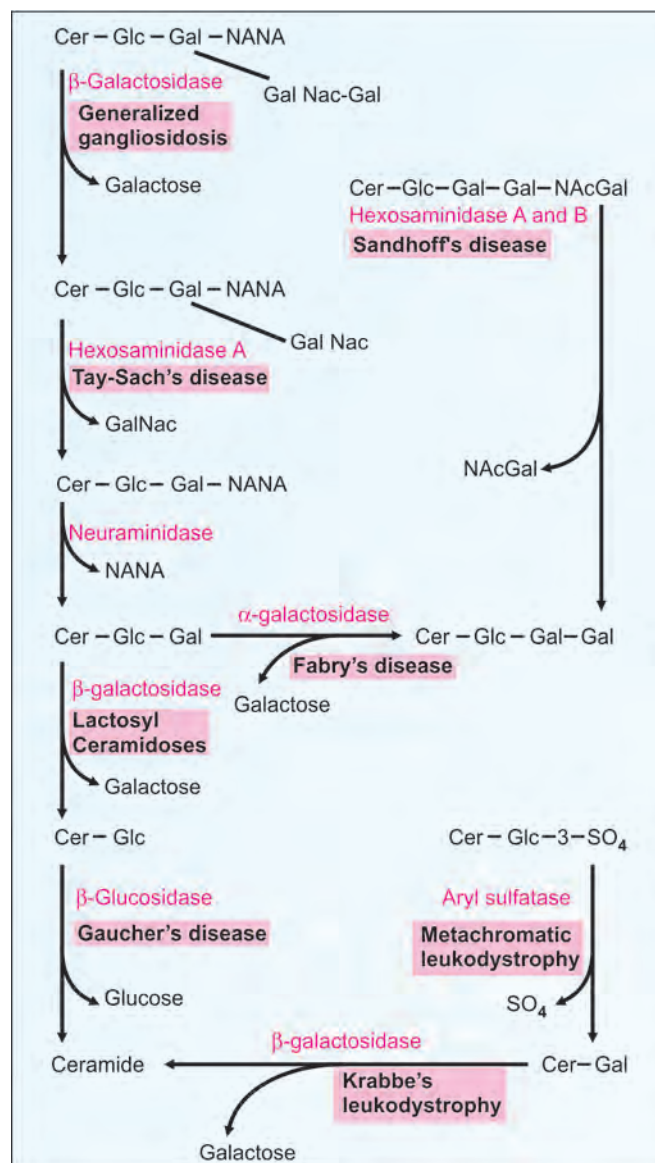


Fig. 14.10: Summary of lipid storage diseases; Cer = ceramide; Glc = glucose; Gal = galactose; NAc = N-acetyl; NANA = N-acetyl neuraminic acid

1. What is the likely biochemical etiology of the disorder?
2. Why do coxibs generally have a lower incidence of upper GI problems than other NSAIDs?
3. What is the major difference between aspirin and other NSAIDs with regard to platelet function?

### Clinical Case Study 14.1 Answer

**Diagnosis:** Gastric ulcer due to NSAID

**Biochemical etiology:** NSAID inhibits gastric enzyme (COX-1) required for synthesis of prostaglandins that have a protective effect on the gastric mucosa.

**Decreased gastric side effects with coxibs:** Traditional NSAIDs, such as ibuprofen and aspirin, inhibit both COX-1 and COX-2. The coxibs are selective inhibitors of COX-2, allowing continued production of protective prostaglandins by gastric COX-1.

Difference between aspirin and other NSAIDs: Aspirin covalently modifies platelet COX-1, thus irreversibly blocking thromboxane formation and reducing platelet function for the lifespan of the affected platelet (platelets cannot synthesize new proteins). The inhibitory action of other NSAIDs on platelet COX-1 is not covalent and is eventually reversed when the agents' blood levels decline.

Nonsteroidal anti-inflammatory drugs (NSAIDs), also known as prostaglandin synthesis inhibitors or cyclo-oxygenase (COX) inhibitors, can induce upper GI irritation or ulcers. The NSAIDs include a wide variety of medications including aspirin, ibuprofen, naproxen, and indomethacin. These medications are used for pain, inflammation, dysmenorrhea, headache, arthritis, or fever. These compounds act as anti-inflammatory and antipyretic agents by inhibiting COX catalysis by prostaglandin H synthase (PGHS). PGHS has two isoenzymes:

PGHS-1 (or COX-1) is generally a basal enzyme found in various tissues including platelets and gastric mucosa; PGHS-2 (or COX-2) is an inducible enzyme typically expressed in response to cytokines and mitogens at sites of inflammation or cell proliferation.

The prothrombotic and vasoconstrictive actions of COX-1-derived thromboxane in the vasculature are opposed by an antithrombotic and vasodilative prostaglandin, prostacyclin, that originates from COX-2 in vascular endothelial cells. The

COX-2 selective coxibs thus tend to decrease prostacyclin levels in the vasculature without reducing the thromboxane levels. This tendency is thought to explain the small but significant increase in cardiovascular risk that recently led to withdrawal of two coxibs from the market.

### QUICK LOOK OF CHAPTER 14

1. Fatty acid with 4 to 6 carbon atoms are called short chain fatty acids (SCFA) (e.g. Butyric acid) and those with 8 to 14 carbon atoms are called medium chain fatty acids (MCFA) (e.g. Lauric acid).
2. MCFA digestion does not require pancreatic lipase and bile salts. They diffuse directly into the portal circulation.
3. Deficient oxidation of VLCFA by peroxisomal oxidation leads to adrenoleukodystrophy.
4. PUFA form membrane lipids, influence fluidity of the plasma membrane and act as precursors for prostaglandin synthesis.
5. Cyclo-oxygenase is an example of a 'suicide enzyme'. Aspirin irreversibly inhibits the enzyme.
6. Prostaglandins act as local hormones and function through G protein coupled receptors. In most cases PGE increases cAMP.
7. TXA<sub>2</sub> is produced by platelets. It promotes platelet aggregation and causes vasoconstriction.
8. Prostacyclin and Thromboxanes are opposite in their actions on cAMP.
9. Leukotrienes LTC<sub>4</sub>, LTD<sub>4</sub> and LTE<sub>4</sub> constitute the slow reacting substance of anaphylaxis (SRS-A).
10. PGF<sub>2</sub> may be used for medical termination of pregnancy, since it stimulates uterine muscles.
11. Compound lipids contain molecules other than fatty acid and alcohol.
12. Sphingomyelins are the only sphingolipids, which contain phosphate and does not contain a sugar residue.
13. Deficiency of enzymes of sphingolipid metabolism results in Sphingolipidoses, a group of inborn metabolic disorders resulting in accumulation of specific lipid residues. Mental retardation, neurological deficit and skeletal abnormalities are common presenting symptoms.



# CHAPTER 15

## General Amino Acid Metabolism (Urea Cycle, One Carbon Metabolism)

### Chapter at a Glance

The reader will be able to answer questions on the following topics:

- Digestion of proteins
- Absorption of amino acids
- Meischer cycle
- Cathepsins, proteasomes
- Interorgan transport of amino acids
- Transamination and transdeamination
- Formation of ammonia
- Urea cycle
- Urea cycle disorders
- Urea level in blood
- One carbon metabolism
- Hyperammonemia

The main role of amino acids is in the **synthesis of structural and functional proteins**. Unlike carbohydrates and fats, there is no storage form of proteins in the body. A 70 kg man has an average protein turnover rate of 400 g per day (same amount synthesized and same amount broken down). The non-essential amino acids are either derived from the diet or synthesized in the body. The **essential amino acids are obtained from the diet**. Even if one is deficient, protein synthesis cannot take place. The body amino acid pool is always in a dynamic steady state. In an adult, the rate of synthesis of proteins balances the rate of degradation, so that nitrogen balance is maintained (Fig. 15.1).

### DIGESTION OF PROTEINS

The dietary proteins are denatured on cooking and therefore more easily digested. All these enzymes are hydrolases (class 3 enzymes) in nature. Proteolytic enzymes are secreted as inactive **zymogens** which are converted to their active form in the intestinal lumen. This would prevent autodigestion of the secretory acini. The proteolytic enzymes include:

1. **Endopeptidases:** They act on peptide bonds inside the protein molecule, so that the protein becomes successively smaller and smaller units. This group includes Pepsin, Trypsin, Chymotrypsin and Elastase.

2. **Exopeptidases:** Which act only on the peptide bond located at the ends of the polypeptide chain. This group includes:

- Carboxypeptidase**, which acts only on the peptide bond at the carboxy terminal end of the chain.
- Amino peptidase**, which acts only on the peptide bond at the amino terminal end of the chain.

A summary of their actions is shown in Figure 15.2. The digestion of protein is effected by enzymes in:

- Stomach
- Pancreas
- Intestinal cells

## Gastric Digestion of Proteins

In the stomach, hydrochloric acid is secreted (see Chapter 26). It makes the pH optimum for the action of pepsin and also activates pepsin. The acid also denatures the proteins.

### Rennin

Rennin otherwise called **Chymosin**, is active in infants and is involved in the curdling of milk. (Box 15.1). It is absent in adults. Milk protein, casein is converted to paracasein by the action of rennin. This denatured protein is easily digested further by pepsin.

### Pepsin

It is secreted by the chief cells of stomach as inactive **pepsinogen**. The conversion of pepsinogen to pepsin is brought about by removal of 44 amino acids from the N-terminal end, by the hydrochloric acid. The optimum pH for activity of pepsin is **around 2**. Pepsin is an endopeptidase, (Table 15.1). Pepsin catalyzes hydrolysis of the bonds formed by carboxyl groups of Phe, Tyr, Trp

and Met. By the action of pepsin, proteins are broken into proteoses and peptones.

## Pancreatic Digestion of Proteins

The optimum pH for the activity of pancreatic enzymes (pH 8) is provided by the alkaline bile and pancreatic juice. The secretion of pancreatic juice is stimulated by the peptide hormones, **Cholecystokinin** and **Pancreozymin**.

Pancreatic juice contains the important endopeptidases, namely **Trypsin**, **Chymotrypsin**, **Elastase** and **Carboxypeptidase**.

These enzymes are also secreted as zymogens (trypsinogen, chymotrypsinogen and proelastase), so that the pancreatic acinar cells are not autolyzed. All the three are serine proteases, i.e. the active centers of these enzymes contain serine residues.

### Trypsin

Trypsinogen is activated by **enterokinase** (enteropeptidase) present on the intestinal microvillus membranes. Once activated, the trypsin activates other enzyme molecules. Trypsin is activated by the removal of a hexapeptide from N-terminal end. Trypsin catalyzes hydrolysis of the bonds formed by carboxyl groups of Arg and Lys.

**Acute pancreatitis:** Premature activation of trypsinogen inside the pancreas itself, will result in the autodigestion of pancreatic cells. The result is acute pancreatitis. It is a life-threatening condition.

### Chymotrypsin

Trypsin will act on chymotrypsinogen, in such a manner that A, B and C peptides are formed. These 3 segments are approximated, so that the active site is formed. Thus selective proteolysis produces the catalytic site.

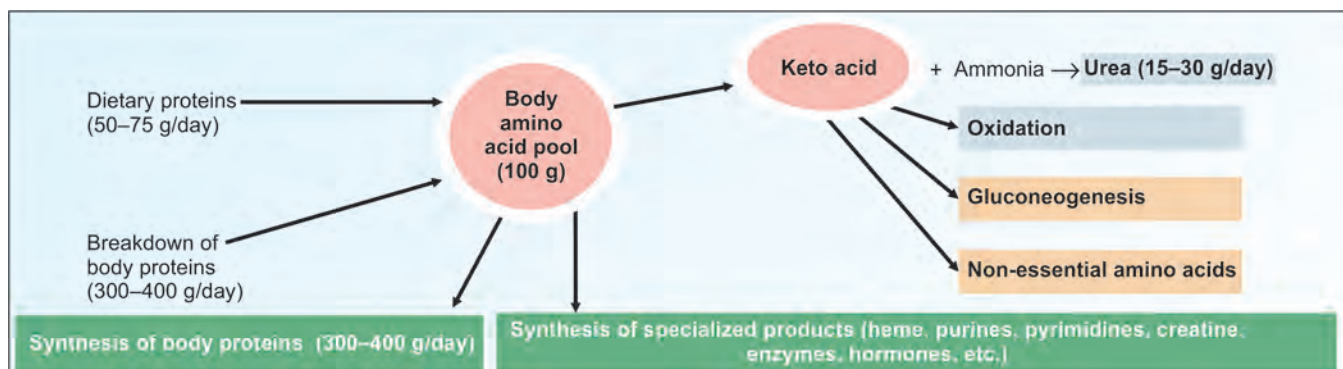


Fig. 15.1: Overview of metabolism of amino acids

## Carboxypeptidases

Trypsin and chymotrypsin degrade the proteins into small peptides; these are further hydrolyzed into dipeptides and tripeptides by **carboxypeptidases** present in the pancreatic juice. The procarboxypeptidase is activated by trypsin. They are metalloenzymes requiring zinc.

## Intestinal Digestion of Proteins

Complete digestion of the small peptides to the level of amino acids is brought about by enzymes present in intestinal juice (**succus entericus**). The luminal surface of intestinal epithelial cells contains the following enzymes:

### Leucine Aminopeptidase

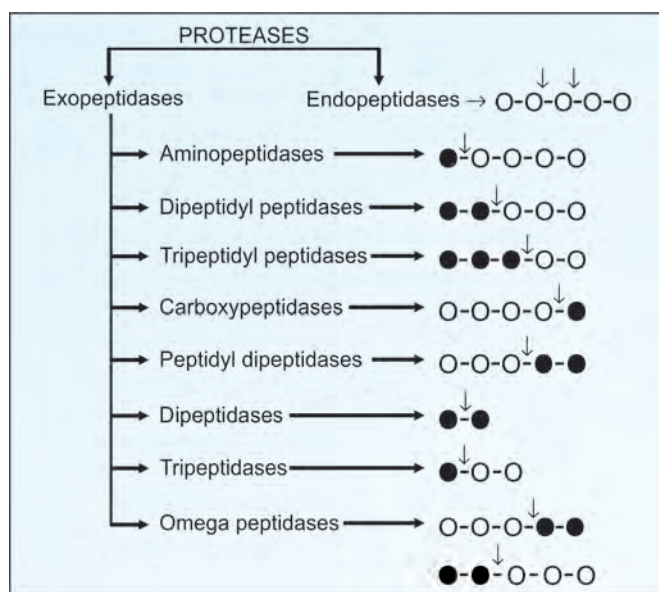
It releases the N-terminal basic amino acids and glycine.

### Proline Amino Peptidase

It removes proline from the end of polypeptides.

### Dipeptidases and Tripeptidases

They will bring about the complete digestion of proteins; their specificities are shown in Figure 15.2.



**Fig. 15.2:** Action of proteases. The enzyme hydrolyzes the peptide bond at the site of arrow

## Absorption of Amino Acids

The absorption of amino acids occurs mainly in the small intestine. It is an energy requiring process. These transport systems are carrier mediated and/or ATP sodium dependent symport systems. There are **5 different carriers** for amino acids:

1. Neutral amino acids (Ala, Val, Leu, Met, Phe, Tyr, Ile)
2. Basic amino acids (Lys, Arg) and Cysteine
3. Imino acids and Glycine
4. Acidic amino acids (Asp, Glu)
5. Beta amino acids (beta alanine).

## Miester Cycle (Gamma Glutamyl Cycle)

In intestines, kidney tubules and brain, the absorption of neutral amino acids is effected by the gamma-glutamyl cycle. The main role is played by the tripeptide **glutathione** (GSH) (gamma-glutamyl-cysteinyl glycine). It reacts with the amino acid to form gamma-glutamyl amino acid. This is catalyzed by gamma-glutamyl transferase. The glutamyl amino acid is then cleaved to give the free amino acid. The net result is the transfer of an amino acid across the membrane. (Fig. 15.3). The transport of one molecule of amino acid and regeneration of GSH requires **3 molecules of ATP**.



Aaron Ciechanover  
NP 2004  
b. 1947



Avram Hershko  
NP 2004  
b. 1937



Irwin Rose  
NP 2004  
b. 1926

### Box 15.1: Rennin and renin are different

Rennin is the proteolytic enzyme present in gastric juice. Renin is proteolytic enzyme, secreted by kidneys. It is involved in the activation of angiotensinogen to angiotensin, a hypertensive agent.

**TABLE 15.1:** Action of proteolytic enzymes

Enzyme	Hydrolysis of bonds formed by carboxyl groups of
Pepsin	Phe, Tyr, Trp, Met
Trypsin	Arg, Lys
Chymotrypsin	Phe, Tyr, Trp, Val, Leu
Elastase	Ala, Gly, Ser
Carboxypeptidase A	C-terminal aromatic amino acid
Carboxypeptidase B	C-terminal basic amino acid

## Food Allergy

Dipeptides and tripeptides can enter the brush border of mucosal cells; they are immediately hydrolyzed into single amino acids. They are then transported into portal vein. Rarely, larger molecules may pass paracellularly (between epithelial cells) and enter blood stream. These are immunogenic, causing antibody reaction, leading to food allergy.

## Clinical Applications

1. The deficiency of the enzyme 5-oxoprolinase leads to **oxoprolinuria** (pyroglutamic aciduria).
2. The allergy to certain food proteins (milk, fish) is believed to result from absorption of partially digested proteins.
3. Defects in the intestinal amino acid transport systems are seen in inborn errors of metabolism such as:
  - a. **Hartnup's disease** (see Chapter 18)
  - b. Imino glycinuria
  - c. Cystinuria (see Chapter 16)
  - d. Lysinuric protein intolerance
  - e. Oasthouse syndrome.
4. Partial gastrectomy, pancreatitis, carcinoma of pancreas and cystic fibrosis may affect the digestion and absorption of proteins.
5. **Protein losing enteropathy:** There is an excessive loss of proteins through the gastrointestinal tract.

## Intracellular Protein Degradation

All proteins in the body are constantly being degraded. Half-life ( $t_{1/2}$ ) of a protein is the time taken to lower its concentration to half of the initial

value. General tissue proteins have half lives of few hours. Key enzymes have half lives of about few minutes only (Box 15.2). **PEST sequence** (areas rich in proline, glutamate, serine and threonine) on a protein will give an inherent message to breakdown that protein very quickly.

Extracellular particles or proteins are taken by endocytosis and are fused with **lysosomes** (see Chapter 2). Intracellular proteins are also ultimately broken down by lysosomes.

## Cathepsins

In the phagolysosomes, the particles are broken down by enzymes known as cathepsins. The term cathepsin is a Greek word, meaning 'to digest'. Cathepsins are 18 in number, designated as A to T. Most of them are active at pH around 3 to 5.

## Ubiquitin

Intracellular protein breakdown also occurs independent of lysosomes. This involves ubiquitin. It is so named, because it is seen in all cells abundantly. It is a small protein with 76 residues (molecular weight, 8.5 kDa). Ubiquitin is attached to proteins with the help of 3 enzymes, E1 (activating enzyme), E2 (ligase) and E3 (transferase). Congenital defect in E3 has been implicated in the genesis of Angelman syndrome and von Hippel-Lindau syndrome.

## Proteasomes

Ubiquitin tagged proteins are immediately broken down inside the **proteasomes** of the cells. The proteasome assembly has a central cylindrical hollow core. Ubiquitin-tagged proteins are taken into this barrel, and surrounding proteolytic enzymes digest the protein into small oligopeptides of 5-6 amino acids length (Box 15.2). Ciechanover, Hershko and Rose were awarded Nobel Prize in 2004 for their discovery of ubiquitin-mediated protein degradation.

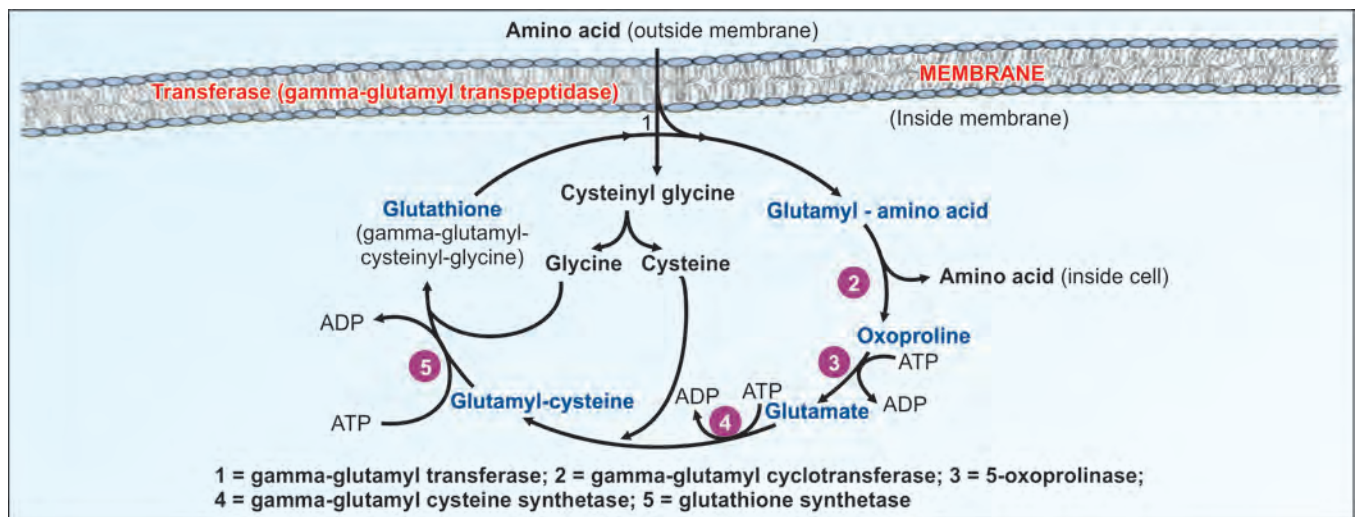


Fig. 15.3: Gamma glutamyl cycle (Meister cycle)



## Interorgan Transport of Amino Acids

In plasma, all amino acids are seen with a level roughly 1 mg/dL, except glutamic acid and glutamine, which are present in higher concentrations (each about 10 mg/dL). Breakdown of muscle protein is the source of amino acids for tissues while liver is the site of disposal (Fig. 15.4 and 15.5).

### In Fasting State

The muscle releases mainly alanine and glutamine of which **alanine is taken up by liver** and glutamine by kidneys (Fig. 15.4). Liver removes the amino group and converts it to urea and the carbon skeleton is used for **gluconeogenesis**. Students should also see glucose-alanine cycle, in Chapter 9, under gluconeogenesis (see Fig. 9.30). The brain predominantly takes up branched chain amino acids.

### In the Fed State

Amino acids absorbed from the diet are taken up by different tissues (Fig. 15.5). Both muscle and brain take up branched chain amino acids, and release glutamine and alanine. The

#### Box 15.2: Lifespan of proteins

The half-life of proteins is highly variable. Ornithine decarboxylase has only 11 minutes. Half-life of hemoglobin depends on the life span of RBCs. The lens protein, Crystallin remains unchanged throughout the life of the organism. Damaged or defective proteins are prematurely degraded.

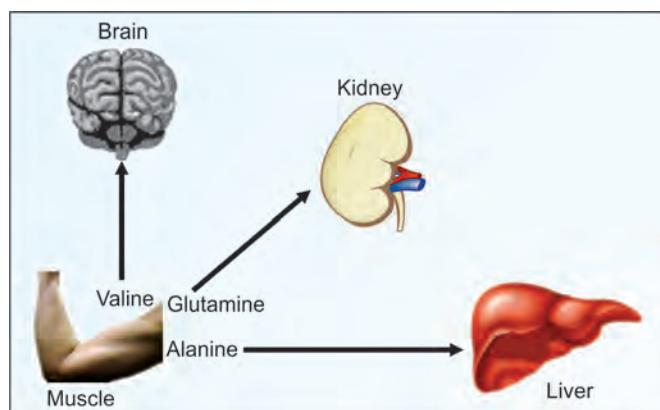


Fig. 15.4: Interorgan transport of amino acids during fasting conditions

glutamine is delivered to kidneys to aid in regulation of acid-base balance, while alanine is taken up by liver.

## General Metabolism of Amino Acids

1. The **anabolic reactions** where proteins are synthesized.
2. **Synthesis** of specialized products such as heme, creatine, purines and pyrimidines.
3. The **catabolic reactions** where dietary proteins and body proteins are broken down to amino acids.
4. **Transamination:** Amino group is removed to produce the carbon skeleton (keto acid). The amino group is excreted as **urea**.
5. The carbon skeleton is used for synthesis of **non-essential** amino acids.
6. It is also used for **gluconeogenesis** or for complete oxidation.
7. Other minor metabolic functions like conjugation, methylation, amidation, etc. Table 15.1 gives a summary of amino acid metabolism. The amino acid pool in the body is shown in Figure 15.6.

## FORMATION OF AMMONIA

The sources and fate of ammonia are shown in Figure 15.7. The first step in the catabolism of amino acids is to remove the amino group as **ammonia**. This is the major source of ammonia. However, small quantities of ammonia may also be formed from catabolism of purine and pyrimidine bases.

Ammonia is **highly toxic** especially to the nervous system. Detoxification of ammonia is by conversion to urea and excretion through urine.

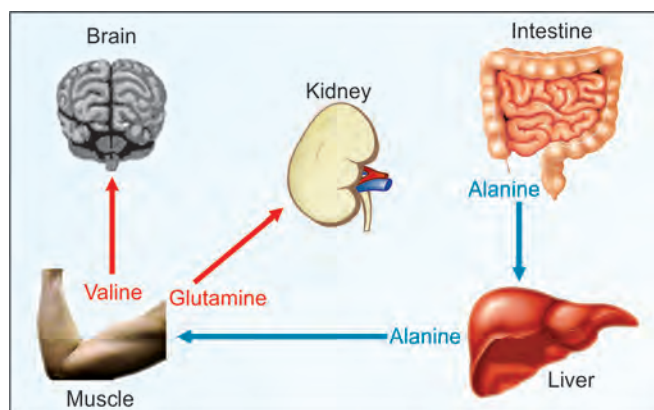


Fig. 15.5: Interorgan transport of amino acids after taking food (post-prandial condition)

## Transamination

- Transamination is the exchange of the alpha amino group between one alpha amino acid and another alpha keto acid**, forming a new alpha amino acid.  
amino acid 1 + keto acid 2  $\rightarrow$  amino acid 2 + keto acid 1
- As an example, amino group is interchanged between alanine and glutamic acid (Fig. 15.8). In almost all cases, the amino group is accepted by **alpha ketoglutaric acid** so that glutamic acid is formed.
- The enzymes catalyzing the reaction as a group are known as **amino transferases**. These enzymes have **pyridoxal phosphate** as prosthetic group (Fig. 15.8). The reaction is readily reversible. Ammoniogenesis helps in excretion of hydrogen ions.

The pyridoxal phosphate is held in Schiff base linkage with the epsilon amino group of the lysine residue of the enzyme protein. This forms an *aldimine* link with the alpha amino group of the reacting amino acid. Then the linkage shifts to a ketimine linkage followed by hydrolysis, the products being an alpha keto acid and pyridoxamine phosphate. During the 2nd phase of the reaction, the reaction is reversed, the new amino acid is formed and pyridoxal phosphate is regenerated.

## Biological Significance of Transamination

### First Step of Catabolism

In this first step, **ammonia** is removed, and the carbon skeleton of the amino acid enters into catabolic pathway.

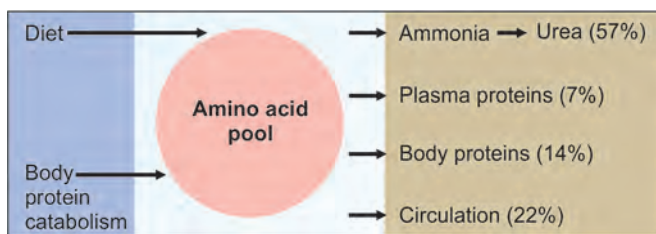


Fig. 15.6: Amino acid pool

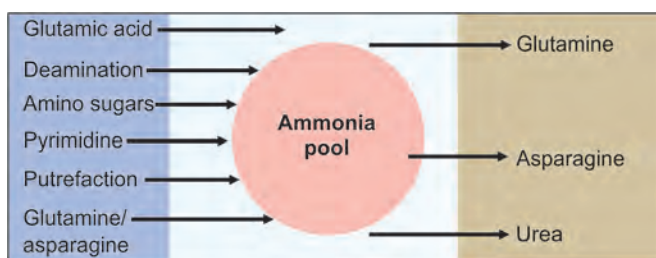


Fig. 15.7: Sources and fate of ammonia

## Synthesis of Non-Essential Amino Acids

By means of transamination, all non-essential amino acids can be synthesized by the body from keto acids available from other sources. For example, **pyruvate** can be transaminated to synthesize **alanine**. Similarly oxaloacetate produces aspartic acid. Alpha keto glutarate is transaminated to form glutamic acid. Those amino acids, which cannot be synthesized in this manner, are therefore essential; they should be made available in the food (See Box 3.1 for essential amino acids).

## Interconversion of Amino Acids

If amino acid no.1 is high and no.2 is low; the amino group from no.1 may be transferred to a keto acid to give amino acid no.2 to equalize the quantity of both. This is called **equalization** of quantities of non-essential amino acids.

## Exceptions

Lysine, threonine and proline are not transaminated. They follow direct degradative pathways.

## Clinical Significance of Transamination

Aspartate amino transferase (**AST**) and Alanine amino transferase (**ALT**) are induced by glucocorticoids, which

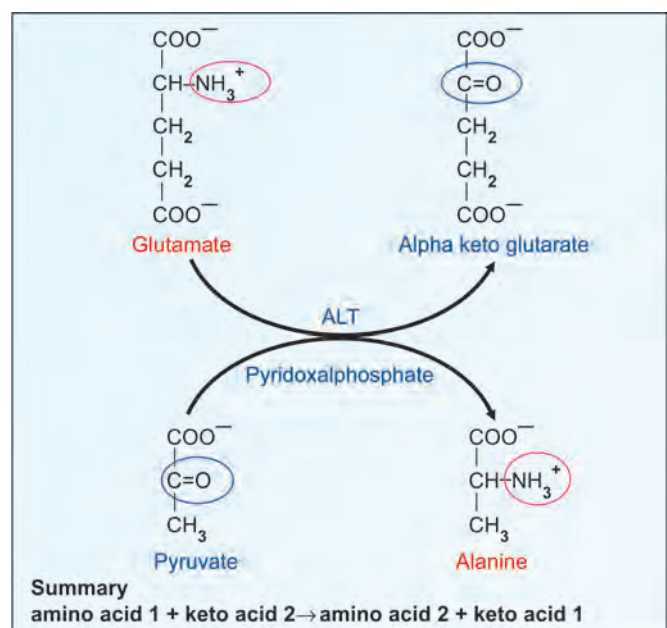


Fig. 15.8: Transamination reaction. In this example, enzyme is Alanine aminotransferase (ALT) and pyridoxal phosphate is the coenzyme. The reaction is readily reversible

favor gluconeogenesis. AST is increased in **myocardial infarction** and ALT in **liver** diseases. Their clinical importance is given in Chapter 23.

## Transdeamination

1. The amino group of most of the amino acids is released by a coupled reaction, transdeamination, that is **transamination followed by oxidative deamination**.
2. Transamination takes place in the cytoplasm of all the cells of the body; the amino group is transported to liver as **glutamic acid**, which is finally oxidatively deaminated in the mitochondria of hepatocytes.
3. Thus, the two components of the reaction are physically far away, but physiologically they are coupled. Hence, the term transdeamination (Fig. 15.9).

## Oxidative Deamination of Glutamate

Only **liver** mitochondria contain **glutamate dehydrogenase (GDH)** which deaminates glutamate to alpha keto glutarate plus ammonia. So, all amino acids are first transaminated to glutamate, which is then finally deaminated (**transdeamination**) (Fig. 15.9). Amino acids are deaminated at the rate of about 50 – 70 gram per day.

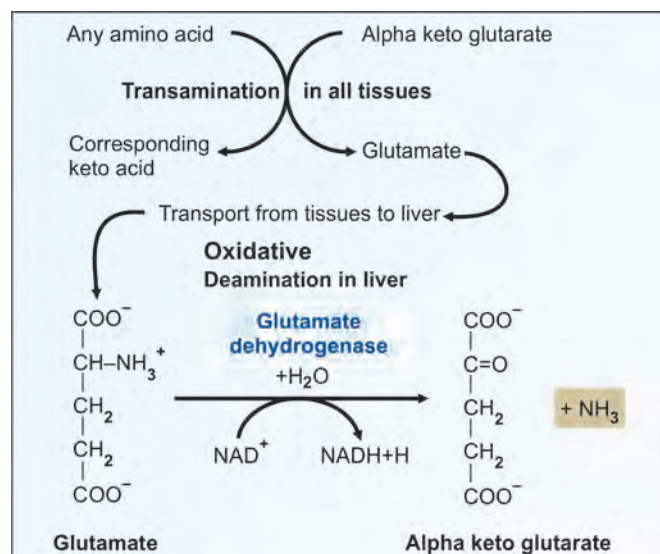


Fig. 15.9: Transamination + deamination = transdeamination

During the transamination reaction the amino group of all other amino acids is funnelled into glutamate. Hence, the glutamate dehydrogenase reaction is the final reaction, which removes the amino group of all amino acids (Fig. 15.9). It needs  $\text{NAD}^+$  as coenzyme. ( $\text{NADP}$  can also act as a co-enzyme). It is an allosteric enzyme; it is activated by ADP and inhibited by GTP.

The hydrolysis of glutamine also yields  $\text{NH}_3$  but this occurs mainly in the kidney where the  $\text{NH}_4^+$  excretion is required for acid-base regulation.

## Minor Pathways of Deamination

1. L-amino acid oxidase can act on all amino acids except hydroxy amino acids and dicarboxylic amino acids. It uses FMN as co-enzyme. The peroxide formed in this reaction is decomposed by catalase in the peroxisomes (Fig. 15.10).
2. D-amino acid oxidase can oxidize glycine and any D amino acid that may be formed by bacterial metabolism. It uses FAD as co-enzyme.
3. Ammonia may be formed in the body through minor reactions like oxidation of monoamines by MAO (mono amine oxidase) (see Chapter 17, under Tyrosine metabolism).

## Non-oxidative Deaminations

1. **Dehydratases** act on hydroxy amino acids to remove ammonia from the following amino acids:
    - a. **Serine** will give rise to pyruvate (see Chapter 16)
    - b. **Threonine** is converted to alpha keto butyric acid.
  2. **Desulfhydrase: Cysteine** undergoes deamination and simultaneous transsulfuration to form pyruvate (see Chapter 16).
  3. **Histidine** also undergoes non-oxidative deamination to form urocanic acid; catalyzed by histidase (see Fig. 18.13).
- Ammonia may also be produced in the gastrointestinal tract by bacterial putrefaction.

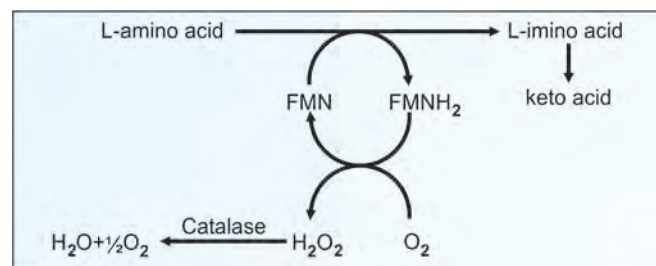


Fig. 15.10: L-amino acid oxidase

## DISPOSAL/DETOXIFICATION OF AMMONIA

### First Line of Defense (Trapping of Ammonia)

Being highly toxic, ammonia should be eliminated or detoxified, as and when it is formed. Even very minute quantity of ammonia may produce toxicity in central nervous system. But, ammonia is always produced by almost all cells, including neurons. The intracellular ammonia is immediately trapped by glutamic acid to form **glutamine**, especially in brain cells (Fig. 15.11). The glutamine is then transported to liver, where the reaction is reversed by the enzyme **glutaminase** (Fig. 15.11). The ammonia thus generated is immediately detoxified into urea. Aspartic acid may also undergo similar reaction to form **asparagine** (see Chapter 17).

### Transportation of Ammonia

Inside the cells of almost all tissues, the transamination of amino acids produce glutamic acid. However, glutamate dehydrogenase is available only in the **liver**. Therefore, the final deamination and production of ammonia is taking place in the liver (Fig. 15.9). Thus, **glutamic acid** acts as the link between amino groups of amino acids and ammonia. The concentration of glutamic acid in blood is 10 times more than other amino acids. **Glutamine** is the transport form of ammonia from brain and intestine to liver; while alanine is the transport form from muscle.

### Final Disposal

The ammonia from all over the body thus reaches liver. It is then **detoxified to urea by liver cells**, and then excreted through kidneys. **Urea is the end product of protein metabolism.**

Since mammals including human beings excrete amino nitrogen mainly as urea, they are referred to as ureotelic. Fishes excrete ammonia as such (ammonotelic) while birds and reptiles as uric acid (uricotelic) (Box 15.3).

Although, ammonia is toxic and has to be immediately detoxified, in kidney cells, ammonia generated on purpose from glutamine with the help of glutaminase. This is for buffering the acids, and maintaining acid-base balance (see Fig. 29.5).

## UREA CYCLE

In 1773, Rouelle isolated urea from urine. Frederic Wohler in 1828 obtained urea by boiling an aqueous solution of ammonium cyanate. The urea cycle is the first metabolic pathway to be elucidated in 1932, by Hans Krebs (1900–1981) and Kurt Henseleit (1907–1972). Hence, the cycle is known as Krebs-Henseleit urea cycle. As ornithine is the first member of the reaction, it is also called as Ornithine cycle.

The two nitrogen atoms of urea are derived from two different sources, one from ammonia and the other directly from the alpha amino group of aspartic acid.

### Step 1: Formation of Carbamoyl Phosphate

One molecule of ammonia condenses with CO<sub>2</sub> in the presence of **two molecules of ATP** to form carbamoyl phosphate. The reaction is catalyzed by the mitochondrial enzyme **carbamoyl phosphate synthetase-I (CPS-I)**. (Figs 15.12 and 15.13, Step 1). An entirely different cytoplasmic enzyme, carbamoyl phosphate synthetase-II, (CPS-II) is involved in pyrimidine nucleotide synthesis (see Chapter 43). The differences of CPS-I and II are shown in Table 15.2. CPS-I reaction is the **rate-limiting step** in urea formation. It is irreversible and allosterically regulated.

#### Box 15.3: Mammals excrete ammonia as urea; but birds excrete ammonia as uric acid

Millions of “gooney” birds nest on some islands of Pacific Ocean, off the coast of Peru. Over the centuries, their droppings formed big hills. These “guano” deposits, containing mainly uric acid, is now being exploited commercially as fertilizer containing nitrogen.

**TABLE 15.2:** Comparison, CPS I and II enzymes

	CPS-I	CPS-II
1. Site	Mitochondria	Cytosol
2. Pathway of	Urea	Pyrimidine
3. Positive effector	NAG	Nil
4. Source for N	Ammonia	Glutamine
5. Inhibitor	Nil	CTP



## Step 2: Formation of Citrulline

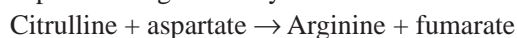
The second reaction is also **mitochondrial**. The carbamoyl group is transferred to the NH<sub>2</sub> group of ornithine by **ornithine transcarbamoylase** (OTC) (Fig. 15.12 and 15.13, step 2). The citrulline leaves the mitochondria and further reactions are taking place in cytoplasm. Citrulline is neither present in tissue proteins nor in blood; but it is **present in milk**.

## Step 3: Formation of Argininosuccinate

One molecule of aspartic acid adds to citrulline forming a carbon to nitrogen bond, which provides the 2nd nitrogen atom of urea. **Argininosuccinate synthetase** catalyzes the reaction (Figs 15.12 and 15.13, step 3). This needs hydrolysis of ATP to AMP level, so **two high energy phosphate bonds** are utilized. The PPi is an inhibitor of this step.

## Step 4: Formation of Arginine

Argininosuccinate is cleaved by **argininosuccinate lyase** (argininosuccinase) to arginine and fumarate (Figs 15.12 and 15.13, step 4). The enzyme is inhibited by fumarate. But this is avoided by the cytoplasmic localization of the enzyme. The fumarate formed may be funnelled into TCA cycle to be converted to malate and then to oxaloacetate to be transaminated to aspartate (Fig. 15.13). Thus the urea cycle is linked to TCA cycle through fumarate. The 3rd and 4th steps taken together may be summarized as:



A similar reaction of donation of amino group by aspartate takes place in purine nucleotide synthesis also (see Chapter 43).

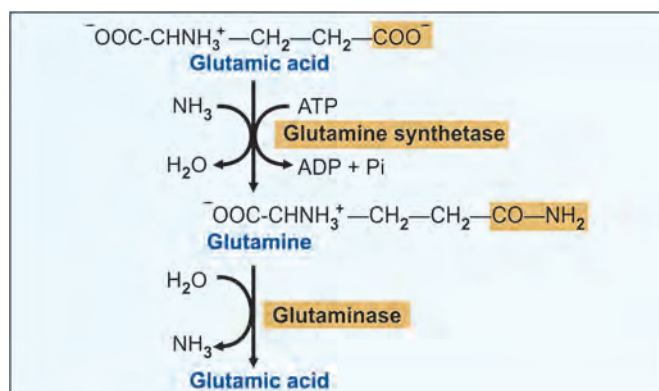


Fig. 15.11: Ammonia trapping as glutamine

## Step 5: Formation of Urea

The final reaction of the cycle is the hydrolysis of arginine to urea and ornithine by arginase (Figs 15.12 and 15.13, step 5). The ornithine returns to the mitochondria to react with another molecule of carbamoyl phosphate so that the cycle will proceed. Thus ornithine may be considered as a catalyst which enters the reaction and is regenerated.

## Energetics of Urea Cycle

The overall reaction may be summarized as:



In the urea cycle 2 ATPs are used in the first reaction. Another ATP is converted to AMP and PPi, which is equivalent to 2 ATPs. The urea cycle consumes **4 high energy phosphate bonds**. However, fumarate formed in the 4th step may be converted to malate. Malate when oxidized to oxaloacetate produces 1 NADH equivalent to 2.5 ATP. So, **net energy expenditure is only 1.5 high energy phosphates**. The urea cycle and TCA cycle are interlinked, and so, it is called as "**urea bicycle**".

## Regulation of the Urea Cycle

### Coarse Regulation

The enzyme levels change with the protein content of diet. During starvation, the activity of urea cycle enzymes is elevated to meet the increased rate of protein catabolism.

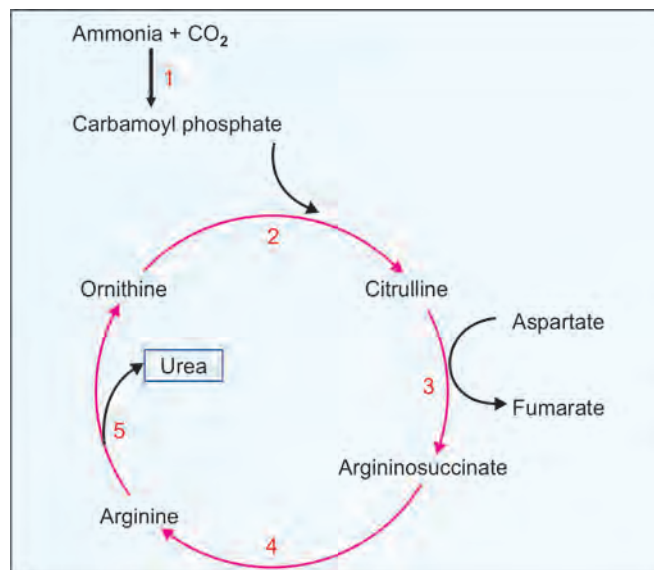


Fig. 15.12: Urea cycle, summary

### Fine Regulation

The major regulatory step is catalyzed by CPS-I where the positive effector is **N-acetyl glutamate** (NAG). It is formed from glutamate and acetyl CoA (Fig. 15.14). Arginine is an activator of NAG synthase.

### Compartmentalization

The urea cycle enzymes are located in such a way that the first two enzymes are in the mitochondrial matrix. The inhibitory effect of fumarate on its own formation is minimized because argininosuccinate lyase is in the cytoplasm, while fumarase is in mitochondria (Fig. 15.13).

### Disorders of Urea Cycle

Deficiency of any of the urea cycle enzymes would result in **hyperammonemia**. When the block is in one of the earlier steps, the condition is more severe, since ammonia itself accumulates. Deficiencies of later enzymes result in the accumulation of other intermediates, which are less toxic and hence symptoms are less. As a general description, disorders

of urea cycle is characterized by hyperammonemia, encephalopathy and respiratory alkalosis. Clinical symptoms include vomiting, irritability, lethargy and severe mental retardation. Infants appear normal at birth, but within days progressive lethargy sets in.

Treatment is more or less similar in the different types of disorders. Low protein diet with sufficient arginine and energy by frequent feeding can minimize brain damage since ammonia levels do not increase very high (Table 15.3).

1. Carbamoyl phosphate synthetase I deficiency (Hyperammonemia type I) is comparatively rare and is characterized by severe hyperammonemia. A variant of the condition is seen in N-acetyl glutamate synthetase .
2. Ornithine transporter deficiency is characterized by hyperornithinemia, hyperammonemia and homocitrullinuria (HHH syndrome). Ornithine has to be transported into the mitochondria and citrulline has to come out since urea cycle is compartmentalized. Ornithine accumulates in the cytoplasm. Since ornithine is not available in the mitochondria, lysine is carbamoylated to form homocitrulline.
3. Ornithine transcarbamoylase deficiency is the only urea cycle disorder, which is inherited as an X-linked trait. Hyperammonemia Type II is characterized by OTC deficiency. Mothers also have hyperammonemia and an aversion to high protein diet.

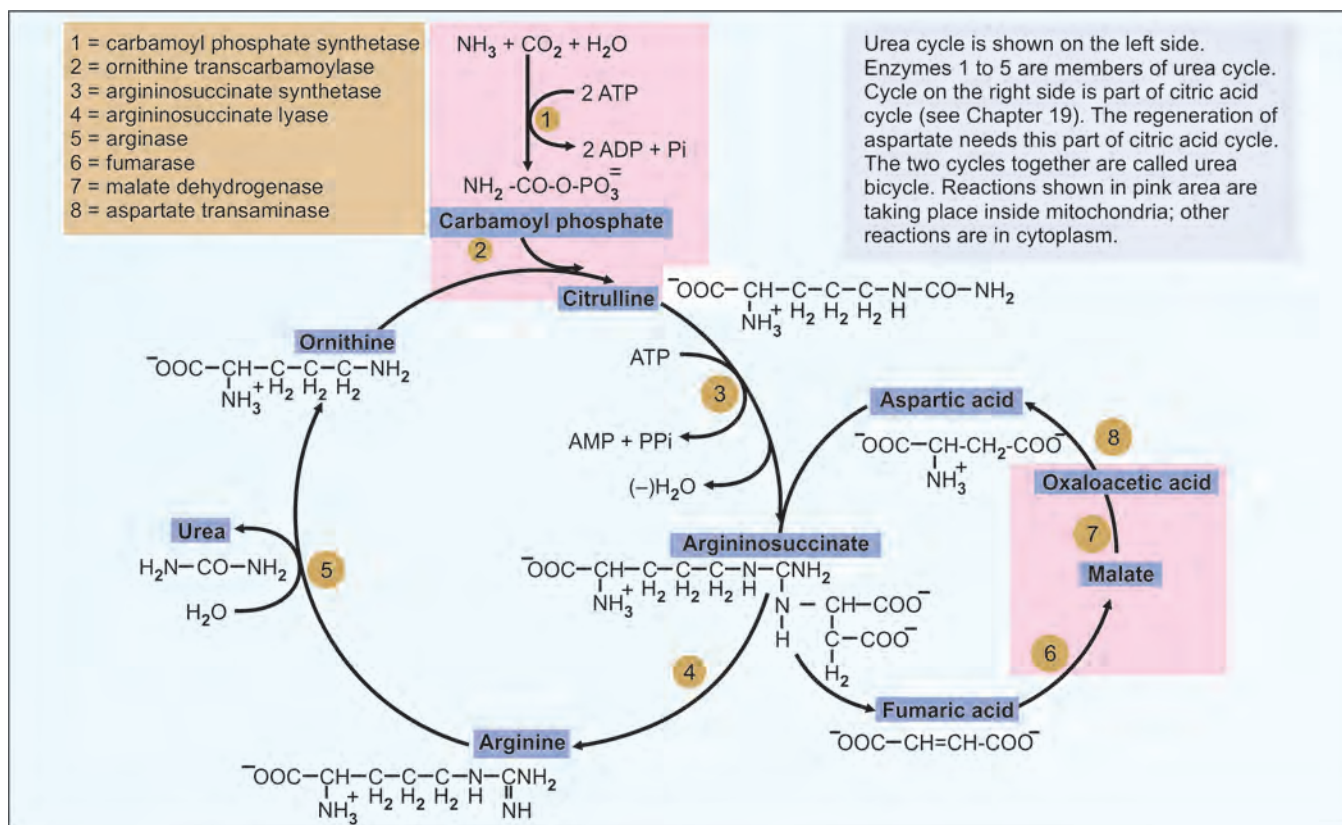


Fig. 15.13: Urea cycle and its relation with citric acid cycle

Elevated levels of ammonia are associated with high glutamine levels in CSF and blood.

4. Argininosuccinate synthetase deficiency is characterized by hyperammonemia, citrullinemia and citrullinuria (1–2 g/day). CSF citrulline levels are also elevated.
5. **Argininosuccinate lyase deficiency** leads to argininosuccinic acidemia and therefore metabolic acidosis. Hyperammonemia is less severe and argininosuccinate is elevated in CSF and excreted in urine. A typical clinical feature is friable tufted hair (trichorrhexis nodosa).
6. **Arginase deficiency** is the most mild variety with accumulation and excretion of arginine (hyperargininemia and argininuria) are seen. Symptoms appear by 2–4 years of age.

The accumulation of ammonia in blood (normally less than 50 µg/dL) and body fluids results in toxic symptoms. Nowadays, defects in enzymes of urea cycle are detected in neonatal blood by estimating metabolites by tandem mass spectrometry.

**Brain is very sensitive to ammonia.** Different clinical disorders are shown in Table 15.3. Child may be put on a low protein diet and frequent small feeds are given. Attempts may be made to eliminate the amino nitrogen in other forms, e.g. as hippuric acid (Benzoyl conjugate of glycine) or phenyl acetyl glutamine.

Since **Citrulline** is present in significant quantities in milk, breast milk is to be avoided in citrullinemia.

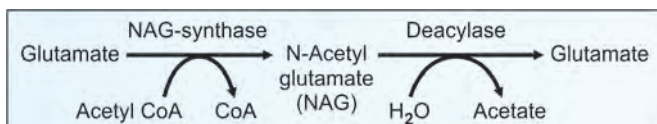


Fig. 15.14: NAG synthesis and breakdown

## Hepatic Coma (Acquired Hyperammonemia)

In diseases of the liver, hepatic failure can finally lead to hepatic coma and death. Hyperammonemia is the characteristic feature of liver failure. The condition is also known as portal systemic encephalopathy. Normally, the ammonia and other toxic compounds produced by intestinal bacterial metabolism are transported to liver by portal circulation and detoxified by the liver. But when there is portal systemic shunting of blood, the toxins bypass the liver and their concentration in systemic circulation rises.

The signs and symptoms are mainly pertaining to CNS dysfunction (altered sensorium, convulsions), or manifestations of failure of liver function (ascites, jaundice, hepatomegaly, edema, hemorrhage, spider nevi).

The management of the condition is difficult. A low protein diet and bowel disinfection using antibiotics and clearance by lactulose, withholding hepatotoxic drugs and maintenance of electrolyte and acid-base balance are the main lines of management.

## Urea Level in Blood

In clinical practice, blood urea level is taken as an **indicator of renal function**. The normal urea level in plasma is from **20–40 mg/dL**. Blood urea level is increased where renal function is inadequate. Details of causes of uremia is given in Chapter 27. Urea level in blood may be theoretically increased when protein intake is very high. However, usually this will be only within the upper limit of the normal values.

Urinary excretion of urea is 15 to 30 g/day (6–15 grams nitrogen/day). This corresponds to the breakdown of

TABLE 15.3: Urea cycle disorders

Diseases	Enzyme deficit	Features
Hyper ammonemia type I	CPS-I	Very high NH <sub>3</sub> levels in blood. Autosomal recessive. Mental retardation. Incidence is 1 in 100,000
Hyper ammonemia type II	(OTC) Ornithine transcarbamoylase	Ammonia level high in blood. Increased glutamine in blood, CSF and urine. Orotic aciduria due to channelling of carbamoyl phosphate into Pyrimidine synthesis. X-linked
Hyper ornithinemia	Defective ornithine transporter protein	Failure to import ornithine from cytoplasm to mitochondria. Defect in ORNT1 gene. Hyperornithinemia, hyperammonemia and homocitrullinuria is seen (HHH syndrome). Decreased urea in blood. Autosomal recessive condition
Citrullinemia	Argininosuccinate	Autosomal recessive inheritance. High blood levels of synthetase ammonia and citrulline. Citrullinuria (1–2 g/day)
Argininosuccinic aciduria	Argininosuccinate lyase	Argininosuccinate in blood and urine. Friable brittle tufted hair (Trichorrhexis nodosa). Incidence 3/200,000
Hyper argininemia	Arginase	Arginine increased in blood and CSF. Instead of arginine, cysteine and lysine are lost in urine. Incidence 1 in 100,000

40 to 80 grams of proteins per day. Urea constitutes 80% of urinary organic solids.

## Hyperammonemia

Measurement of ammonia levels is a very critical parameter for the assessment of a variety of genetic and acquired conditions. The most important genetic causes of hyperammonemia are urea cycle disorders and organic acidurias (Fig. 15.18). Organic acidurias usually present with life-threatening metabolic acidosis and hyperammonemia; whereas urea cycle disorders often have metabolic alkalosis along with hyperammonemia. Ammonia levels may be elevated in hepatic coma (hepatic encephalopathy). In this condition liver function tests will also often be grossly abnormal. Other conditions where ammonia is elevated include cor pulmonale, pulmonary emphysema and renal failure. A low protein diet and bowel disinfection using antibiotics will reduce bacterial load. Then, lactulose administration can reduce ammonia level by reducing intestinal production of ammonia.

## ONE-CARBON METABOLISM

One-carbon (1C) groups play a pivotal role in donating carbon atoms for synthesis of different types of compounds. The different one-carbon groups of the 'one-carbon pool' of the body are:

1. **Formyl** group
2. **Formimino** group
3. **Methenyl** group
4. **Hydroxymethyl** group
5. **Methylene** group
6. **Methyl** group (Table 15.4).

The one-carbon groups, except methyl group, are carried by tetrahydrofolic acid (THFA). THFA is produced from folic acid (see Chapter 38). N<sup>5</sup> and N<sup>10</sup> atoms of THFA carry the one-carbon groups. The attachment of methylene (—CH<sub>2</sub>—) group is shown in Figure 15.15.

**TABLE 15.4: One-carbon compounds**

Group	Structure	Carried by
Formyl	—CHO	N <sup>5</sup> -formyl-THFA and N <sup>10</sup> -formyl-THFA
Formimino	—CH=NH	N <sup>5</sup> -formimino-THFA
Methenyl	=CH—	N <sup>5</sup> ,N <sup>10</sup> -methenyl-THFA
Hydroxymethyl	—CH <sub>2</sub> OH	N <sup>10</sup> -hydroxymethyl-THFA
Methylene	—CH <sub>2</sub> —	N <sup>5</sup> ,N <sup>10</sup> -methylene-THFA
Methyl	—CH <sub>3</sub>	N <sup>5</sup> -methyl-THFA and methyl cobalamin

## Generation of One-Carbon Groups

The one-carbon groups are contributed to the one-carbon pool by amino acids.

1. **Serine** to glycine (Serine hydroxymethyl transferase reaction, see Fig. 16.1) is the primary contributor for methylene THFA.
2. **Glycine** cleavage system also produces methylene groups is the glycine cleavage system (see Fig. 16.3).
3. **Histidine** contributes to N<sup>5</sup>-formimino THFA through FIGLU (see step 4, Fig. 18.13).
4. **Tryptophan** donates formyl-THFA (see step 1, Fig. 18.8).
5. **Choline** and betaine are donors of hydroxy methyl groups (see Chapter 16).

As serine is converted to choline, 3 one-carbon units are used up. During the conversion of choline to glycine, these methyl groups are recovered (see Chapter 16). Hence this pathway is called the "**salvage pathway**" for one-carbon units.

## Interconversion of One-Carbon Groups

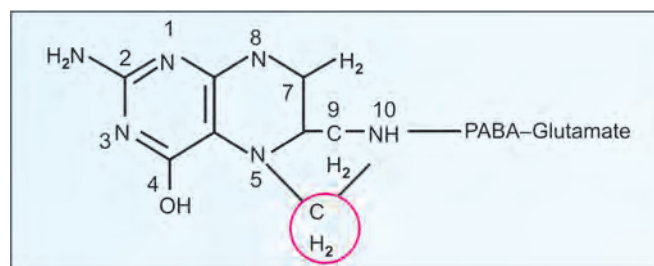
The different one-carbon groups are interconvertible as shown in Figure 15.16. All one-carbon units are ultimately siphoned into methyl-THFA. This is because, the reductase reaction (Fig. 15.16) is an **irreversible step**.

From methyl-THFA, the B<sub>12</sub> co-enzyme accepts the methyl group to form methyl cobalamin. It then transfers the methyl group to homocysteine to form methionine. This is one of the few reactions in human metabolism, where B<sub>12</sub> acts as a co-enzyme (Fig. 15.16). In B<sub>12</sub> deficiency, deficiency of folic acid is also observed; this is because, the transfer of methyl group from methyl-THFA does not occur. THFA is not regenerated; this is called **folate trap**.

## Utilization of One-carbon Groups

A summary of the generation and utilization of one-carbon groups is shown in Figure 15.19. The one-carbon units are used for synthesis of the following compounds:

1. **C2 of purine**
2. **Formylation of methionyl tRNA**
3. **C8 of purine**
4. **Glycine** (see Fig. 16.1)
5. **Serine**
6. **Choline** (see Fig. 16.12)
7. **Deoxy TMP** (Fig. 15.17).



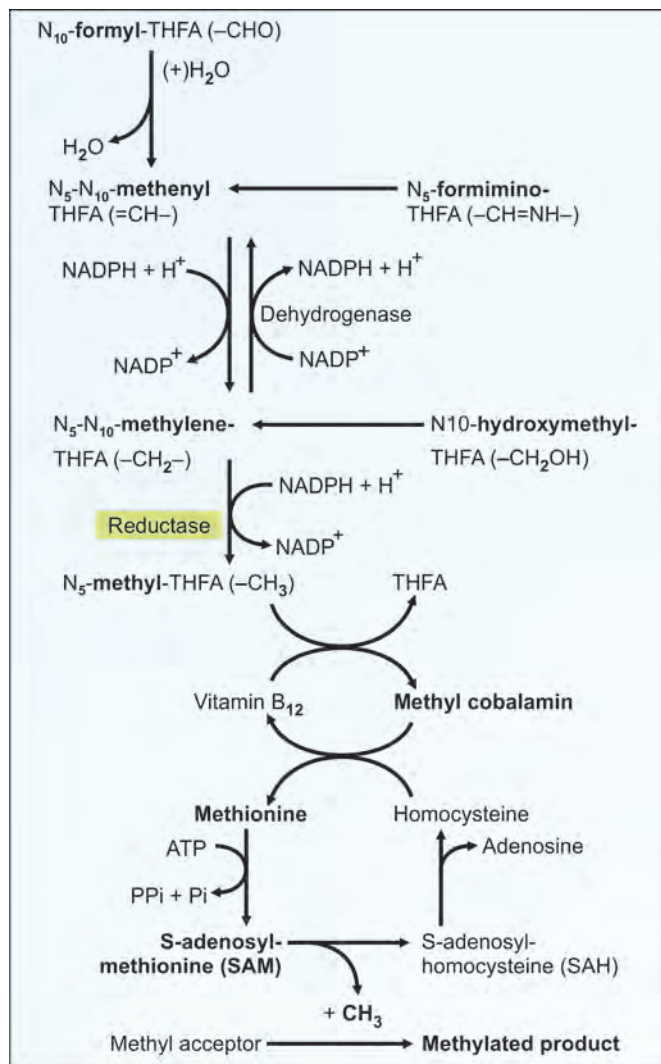
**Fig. 15.15:** Tetrahydrofolic acid (THFA). Methylene group is attached to N-5 and N-10



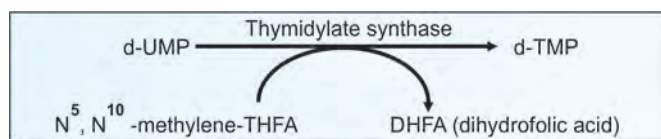
8. **Transmethylation reactions** including creatine, choline and epinephrine synthesis
9. Excreted as carbon dioxide.

### Clinical Case Study 15.1

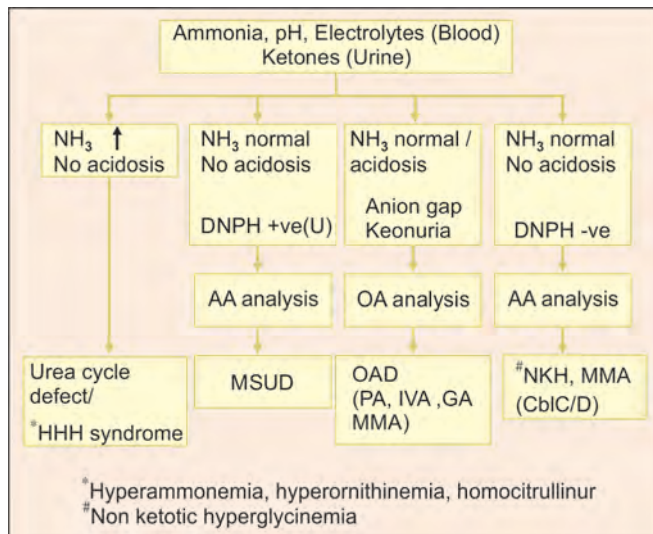
A 6-month-old infant began to vomit occasionally and ceased to gain weight. At 9 months of age he was readmitted



**Fig. 15.16:** Summary of one-carbon metabolism  
THFA = tetrahydrofolic acid

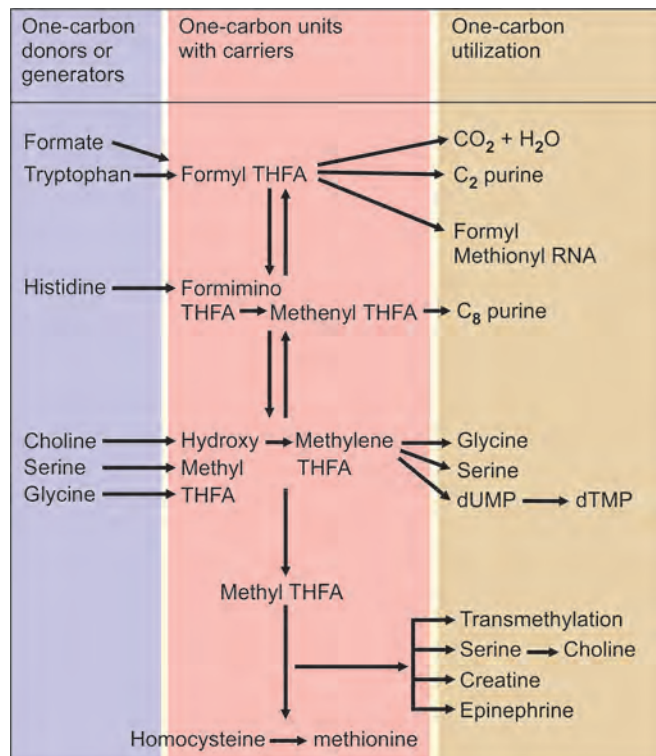


**Fig. 15.17:** Synthesis of thymidylic acid



**Fig. 15.18:** Differential diagnosis of hyperammonemia

OAD – Organic acid disorders, MSUD – Maple syrup urine disease, IVA – Isovaleric acidurias, MMA – Methylmalonic acidurias, PA – Propionic aciduria, GA – Glutaric aciduria, NKH – Non ketotic hyperglycinemia, HHH syndrome – Hyperammonemia hyperomithinemia homocitrullinuria syndrome, DNP test – Dinitro phenyl hydrazine test, AA – Amino acid, OA – Organic acid



**Fig. 15.19:** One-carbon generation and utilization

to the hospital. Routine examination and laboratory analysis were normal. After one week, he became drowsy, had fever, pulse was elevated, and there was hepatomegaly. EEG was done and was grossly abnormal. Blood ammonia was elevated and urine contained high amount of glutamine and uracil. What is the probable diagnosis? What is the pathogenic mechanism involved?

### Clinical Case Study 15.1 Answer

Hyperammonemia in this patient may be due to urea cycle disorder. Excessive excretion of uracil and/or orotic acid results from accumulation of carbamoyl phosphate, and is due to absence of the enzyme ornithine transcarbamoylase (OTC). Glutamine is normally converted to glutamate and ammonia by the kidneys; but when the level exceeds, it is excreted in urine.

Ornithine transcarbamoylase (OTC) deficiency is inherited as X-linked dominant condition and the disease is more severe in males. Drugs like valproate and corticosteroids increase the risk. Other causes of urea cycle disorders are carbamoyl phosphate-I deficiency (characterized by severe hyperammonemia in the newborn period), argininosuccinic acid synthetase deficiency (leading to citrullinemia and severe hyperammonemia), argininosuccinic acid lyase deficiency (leading to argininosuccinic aciduria, with rapid onset hyperammonemia in neonatal period) and arginase deficiency (leading to hyperargininemia, which is the least severe). NAG synthase (NAGS) deficiency mimics CPSI deficiency.

Clinical symptoms of urea cycle disorders are lethargy, anorexia, hyperventilation or hypoventilation, hypothermia, seizures and coma. Hyperammonemia may be triggered by illness or stress, which along with a normal anion gap, is the classical hallmark of urea cycle disorder. Definitive diagnosis depends on enzyme assay from liver biopsy specimen and genetic analysis.

Treatment includes dialysis to reduce ammonia levels, intravenous arginine chloride and nitrogen scavenger drugs (phenyl acetate, benzoate) to activate alternative pathways for ammonia excretion, and protein restricted diet. Chronic therapy includes protein restricted diet, phenyl butyrate, arginine, citrulline supplements, and if necessary, liver transplantation. Genetic counseling and prenatal diagnosis are advised.

## QUICK LOOK OF CHAPTER 15

1. Proteolytic enzymes are secreted as inactive zymogens. This prevents autodigestion of the secretory acini. As for example, Trypsinogen. The chief cells of the stomach secrete pepsin. Optimum pH for its activity is 2.0.
2. Pepsin catalyzes hydrolysis of the bonds formed by carboxyl groups of Phe, Tyr, Trp and Met.
3. Activation of trypsin is by 'enterokinase' present in the intestinal microvilli.
4. Acute pancreatitis is a condition resulting from premature activation of the zymogen trypsinogen inside the pancreas itself.
5. Trypsin catalyzes hydrolysis of the bonds formed by carboxyl groups of Arg and Lys.
6. Important proteolytic enzymes of the body are Pepsin, Trypsin, Chymotrypsin, Carboxypeptidase A and B and Elastase.
7. Amino acids have five different transport systems for their absorption viz. for neutral amino acids, for basic amino acids, for imino acids and glycine, for acidic amino acids and for beta amino acids.
8. Absorption of neutral amino acids in renal tubules and brain is by the 'gamma glutamyl cycle'.
9. Transaminases require pyridoxal phosphate (PLP) as cofactor.
10. Reactions that form ammonia in the body are transamination, transdeamination, oxidative deamination and non-oxidative deamination.
11. First line of defense against ammonia toxicity in the body is its trapping by glutamine, especially in the brain cells. Second line of defense is constituted by the urea cycle.
12. The two nitrogen atoms of urea are derived from ammonia and aspartic acid.
13. Carbamoyl synthase-I is the rate-limiting enzyme of the urea cycle. The reaction is irreversible.
14. Deficiency of all the urea-cycle enzymes is known. They constitute the set of disorders called 'urea-cycle defects'.
15. Normal plasma urea level is 20 – 40 mg/dL.
16. The one carbon units are; N<sup>5</sup> formyl THFA, N<sup>10</sup> formyl THFA, N<sup>5</sup>N<sup>10</sup> Methylene THFA, N<sup>5</sup>N<sup>10</sup> Methenyl THFA and N<sup>5</sup> methyl THFA.

# CHAPTER 16

## Simple, Hydroxy and Sulfur-containing Amino Acids (Glycine, Serine, Methionine, Cysteine)

### Chapter at a Glance

The reader will be able to answer questions on the following topics:

- Glycine
- Creatine, creatine phosphate and creatinine
- Serine, choline, selenocysteine
- Alanine
- Methionine
- Transmethylation reactions
- Cysteine
- Glutathione
- Homocysteine and homocystinurias
- Cystinosis
- Cystathioninuria

### ■ GLYCINE (GLY) (G)

It is the simplest amino acid. It is non-essential and is glucogenic. Glycine is formed from:

1. **Serine.** The beta carbon of serine is channeled into the one carbon pool, carried by THFA (tetrahydrofolic acid). The alpha carbon of serine becomes the alpha carbon of glycine (Fig.16.1).
2. **Threonine** by the activity of threonine aldolase (Fig.16.2).
3. **Glycine synthase.** Glycine can be synthesized by the glycine synthase reaction from  $\text{CO}_2$ ,  $\text{NH}_3$  and one carbon unit. This is the reversal of the glycine cleavage system. It is a multi-enzyme complex. It needs the co-enzymes, NAD, lipoamide, tetra hydro folic acid and pyridoxal phosphate (Fig.16.3).
4. **Glycine amino transferase** can catalyze the synthesis of glycine from glyoxalate and glutamate or alanine. This reaction strongly favors synthesis of glycine.

### Utilization of Glycine

#### Glycine Cleavage System

Glycine undergoes oxidative deamination (reversal of glycine synthase) to form  $\text{NH}_3$ ,  $\text{CO}_2$  and the one-carbon unit methylene THFA. (Fig. 16.3). This pathway is the major catabolic route for glycine. The glycine cleavage system is a **multi-enzyme complex** consisting of:

- A. Glycine decarboxylase with pyridoxal phosphate
- B. Lipoamide containing amino methyl transferase

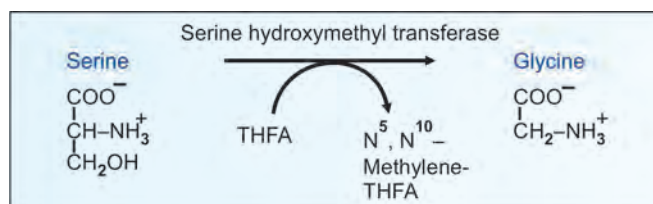


Fig. 16.1: Formation of glycine from serine

- C. Methylene THFA synthesizing enzyme  
 D.  $\text{NAD}^+$  dependent lipoamide dehydrogenase. This enzyme is attached to a H-protein.

### Glucogenic Pathway

Glycine is mainly channeled into the glucogenic pathway by getting first converted to **serine**. This is the reversal of serine hydroxy methyl transferase reaction (Fig.16.1). The serine is then converted to pyruvate by serine dehydratase (Fig.16.9).

### Special Metabolic Functions of Glycine

Glycine may be used for the biosynthesis of the following compounds (Fig.16.4):

- Creatine, creatine phosphate and creatinine
- Heme
- Purine nucleotides
- Glutathione
- Conjugating agent
- Neurotransmitter.

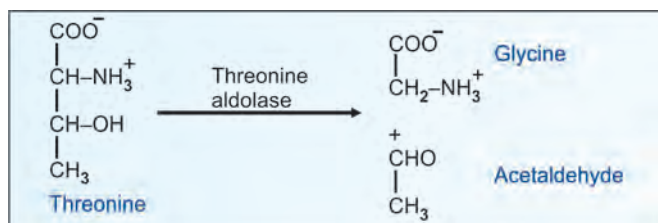


Fig. 16.2: Formation of glycine from threonine

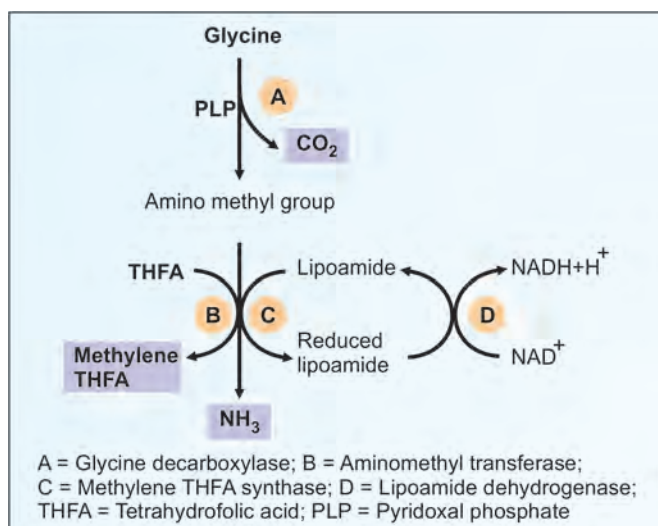


Fig. 16.3: Glycine cleavage system. Glycine is completely degraded to  $\text{CO}_2$ , ammonia and one-carbon unit methylene THFA. The reactions are readily reversible, when the enzymes are together called Glycine synthase

## CREATINE AND CREATINE PHOSPHATE

The word creatine is derived from the Greek term, *kreas*, which means flesh. Creatine constitutes about 0.5% of total muscle weight. It is synthesized from 3 amino acids, glycine, arginine and methionine.

- First step (Guanidoacetic acid):** In the **first reaction** the amidino group of arginine is transferred to glycine to form **guanidoacetic acid**, catalyzed by amido transferase (Step 1, Fig.16.5). It is seen in mitochondria of **kidney** and pancreas, but not in liver.
- Second step (Creatine):** Guanido acetic acid is methylated by S-adenosyl methionine (SAM) by methyl transferase to form **creatine**. This methylation reaction takes place in **liver** (Step 2, Fig.16.5).
- Third step (Creatine phosphate):** Creatine is phosphorylated to **creatine phosphate** (Step 3, Fig.16.5). The enzyme creatine kinase (CK) is present in **muscle**, brain and liver. The reaction needs hydrolysis of **ATP**. The stored creatine phosphate in the muscle serves as an immediate **store of energy in the muscle**. During muscle contraction, the energy is first derived from ATP hydrolysis. Thereafter, the ATP is regenerated by the hydrolysis of creatine phosphate (Fig.16.6). This is called the **Lohmann's reaction** (Lohmann, 1932).
- Fourth step (Creatinine):** The creatine phosphate may be converted to its anhydride, **creatinine** (Step 4, Fig.16.5). It is a non-enzymatic **spontaneous** reaction. Creatinine is excreted in urine. The blood

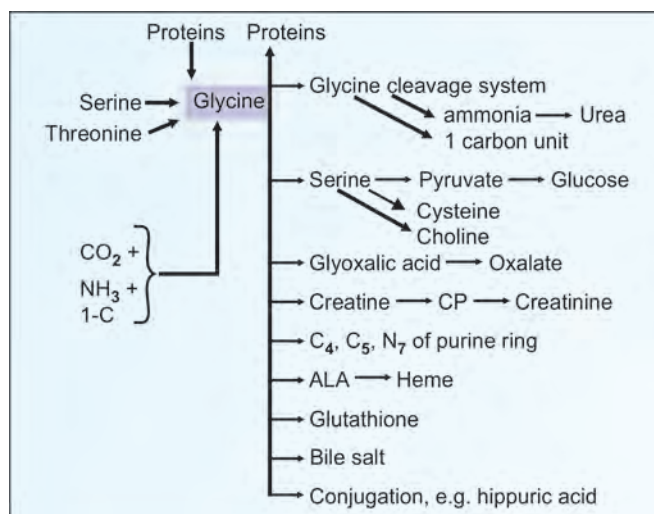


Fig. 16.4: Overview of glycine metabolism



level of creatine and creatinine, and urinary excretion of creatinine are more or less constant, as long as the muscle mass is not affected.

### Clinical Applications

- Normal serum creatinine level is 0.7 to 1.4 mg/dL and serum creatine level is 0.2–0.4 mg/dL.
- Urine contains negligible amounts of creatine in normal males. But in **muscular dystrophies**, the blood creatine and urinary creatinine are increased.

- Creatinine** level in blood is an indicator of **renal function** (see Chapter 27).
- The enzyme CK is clinically important as it is elevated in **myocardial infarction** (see Chapter 23).

Creatine and phosphocreatine serve not only as an intracellular buffer for adenosine triphosphate, but also as an energy shuttle for the movement of high-energy phosphates from mitochondrial sites of production to cytoplasmic sites of utilization. The spontaneous loss of creatine and of phosphocreatine to creatinine requires that creatine be continuously replaced; this occurs by a combination of diet and endogenous synthesis. Vegetarians obtain almost no dietary creatine. Creatine synthesis makes major demands on the metabolism of glycine, arginine, and methionine. Large doses of creatine monohydrate are widely taken, particularly by athletes, as an ergogenic supplement; creatine supplements are also taken by patients suffering from gyrate atrophy, muscular dystrophy, and neurodegenerative diseases. Children with inborn errors of creatine synthesis or transport present with severe neurological symptoms and a profound depletion of brain creatine. It is evident that creatine plays a critical, though underappreciated, role in brain function.

### Synthesis of Heme

The enzyme ALA synthase condenses glycine with succinyl CoA to form delta amino levulinic acid (ALA) (see Chapter 21). It is the key enzyme of heme synthesis.

### Synthesis of Purines

The whole molecule of glycine is incorporated into the purine ring (C4, C5 and N7) (see Chapter 43).

### Synthesis of Glutathione

Glutathione is a tripeptide formed from glutamic acid, cysteine and glycine. The functions of glutathione are described in the section on metabolism of cysteine.

### Glycine as a Conjugating Agent

- Bile acids.** Glycine is used to conjugate bile acids, to produce bile salts. Glycocholic acid and glycochenodeoxycholic acid are the main conjugated bile acids (see Fig. 13.20).

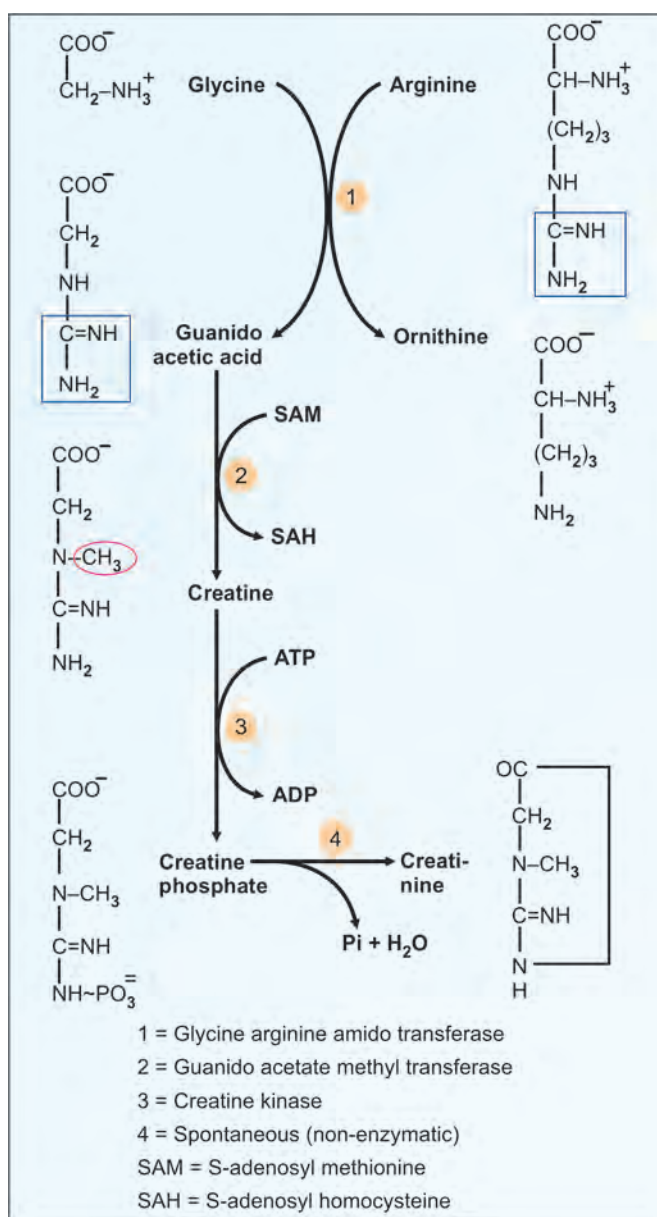


Fig. 16.5: Creatine metabolism

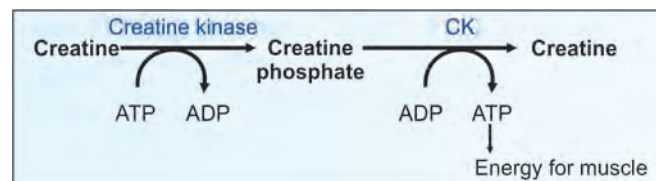


Fig. 16.6: Creatine phosphate, Lohmann's reaction

B. **Benzoic acid.** It is used in small amounts as preservative in foods. Glycine is used for detoxification of benzoic acid to form **hippuric acid** (see Chapter 41).

Glycine + Benzoyl CoA →

Benzoyl glycine (hippuric acid) + CoA

The conjugation occurs in liver and so it is an index of **liver function**. Hippuric acid was first isolated from horse urine, and hence the name.

## Glycine as a Neurotransmitter

Glycine is seen in the brainstem and spinal cord. Glycine opens chloride specific channels. In moderate levels glycine inhibits neuronal traffic; but at high levels it causes over-excitation.

## Glycine as a Constituent of Protein

Glycine is seen where the polypeptide chain bends or turns (beta bends or loops). In collagen, every 3rd amino acid is glycine.

## Metabolic Errors in Relation to Glycine

### Nonketotic Hyperglycinemia (NKH)

It is due to defect in **glycine cleavage system**. Glycine level is increased in blood, urine and CSF. Severe mental retardation and seizures are seen. There is no effective management.

Diagnosis is achieved by elevated CSF/blood glycine ratio. Diagnosis is important for genetic counseling. A variant of this condition is atypical nonketotic hyperglycinemia, where glycine levels are high but not as high as in NKH. Response to treatment is better in atypical NKH. Hyperglycinemia is also seen in organic acidurias.

## Primary Hyperoxaluria

- Increased excretion of oxalates is observed (up to 600 mg/day, compared to a normal of 50 mg/day). The oxaluria is due to increased production of oxalates. It is an autosomal recessive trait.
- The disease is due to a **protein targeting defect**. Normally, the enzyme alanine glyoxalate amino transferase (no.1 in Fig.16.7) is located in hepatic **peroxisomes**; but in these patients the enzyme is present in mitochondria (see also Box 46.1). So, enzyme is inactive.

- This leads to increased pool size of glyoxalate, and excess production of oxalate. Renal deposition of oxalates would cause nephrolithiasis, renal colic and hematuria. Extrarenal oxalosis may be seen in heart, blood vessels, bone, etc.
- Type 2** primary hyperoxaluria is a milder condition causing only urolithiasis and results from deficient activity of cytoplasmic glyoxalate oxidase (no.2 in Fig.16.7).
- The principle of management is to increase oxalate excretion by increased water intake. Also try to minimize dietary intake of oxalates by restricting the intake of leafy vegetables, sesame seeds, tea, cocoa, beet-root, spinach, rhubarb, etc.
- In normal persons, oxalate can arise from
  - glyoxalate metabolism,
  - from ingestion of leafy vegetables
  - from ascorbic acid degradation. The third source is minimal in human beings.

## SERINE (SER) (S)

Serine is an aliphatic hydroxy amino acid. It is nonessential and glucogenic. Sources of serine are:

- Phosphoglycerate:** This is the major source of serine in the body. The steps involve dehydrogenation, transamination and removal of phosphate group (Fig.16.8).
- From **glycine** by reversal of serine hydroxymethyl transferase reaction (Fig.16.1).
- Serine may also be formed by transamination of hydroxypyruvate with alanine.

Alanine + Hydroxypyruvate → Pyruvate + Serine

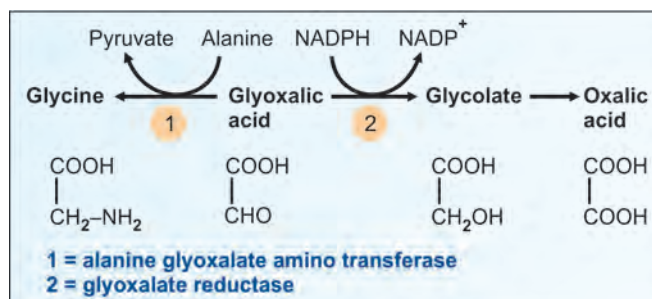


Fig. 16.7: Cause of oxaluria. Enzyme 1 is located in peroxisomes, but in patients it is located in cytoplasm and hence inactive

## Catabolism of Serine

1. Deamination to **pyruvate** (Fig. 16.9)
2. Transamination to **hydroxypyruvate**
3. Serine is **glucogenic**.

## Metabolic Functions of Serine

1. **One-carbon group:** Serine donates one-carbon group to the one-carbon pool. By the action of serine-hydroxymethyl-transferase enzyme, the one carbon group (methylene THFA) is removed from serine, and glycine is formed (Fig. 16.1).
2. **Cysteine:** Serine is used for the formation of cysteine (Fig.16.15).  
Serine + Homocysteine → Cysteine + Homoserine
3. **Alanine:** Serine is converted to alanine by dehydration followed by transamination.
4. Phosphatidyl serine (see Chapter 7).
5. **Drugs:** Serine analogs are used as drugs and they inhibit nucleotide synthesis (Fig.16.11). **Azaserine** is an anticancer drug and **cycloserine** is an antituberculous drug.

## Choline Synthesis

- A. Serine is decarboxylated to **ethanolamine** by a pyridoxal phosphate dependent decarboxylase (Fig. 16.10).

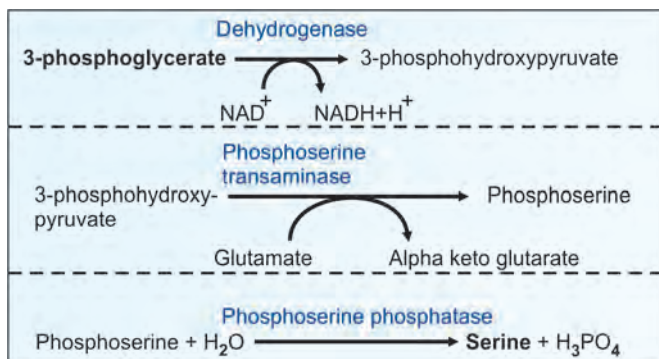


Fig. 16.8: Formation of serine

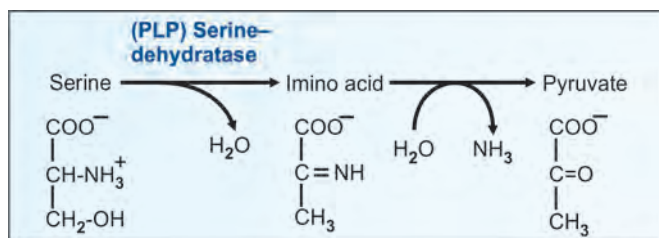


Fig. 16.9: Deamination of serine to pyruvate

Ethanolamine is further utilized for choline synthesis. Figure 16.12 shows the addition of 3 methyl groups to ethanol amine to form choline.

- B. Choline is used for **acetylcholine** synthesis, which is an important neurotransmitter.
- C. From choline, 3 one-carbon groups ( $-\text{CH}_3$ ) can be removed. So, choline is an important **one-carbon donor** (Fig. 16.12).

## Serine as a Component of Protein

- i. In **phosphoproteins**, serine serves to esterify phosphate groups, e.g. casein.
- ii. Glycogen phosphorylase is activated by phosphorylation, while pyruvate kinase and phosphofructokinase-2 are activated by dephosphorylation. This **covalent modification** serves as a mechanism of regulation of enzyme activity. The phosphate group is added by protein kinases which are serine/threonine kinases.
- iii. In **glycoproteins**, the carbohydrate groups are usually attached to the hydroxyl groups of serine or threonine residues of the protein. Serine forms the active group of many enzymes (serine proteases), e.g. trypsin and coagulation factors.

An overview of serine metabolism is given in Figure 16.13.

## Selenocysteine (SeCys) (21st amino acid)

Selenocysteine is abbreviated as SeCys. It is seen at the active site of the following enzymes: a) **Thioredoxin reductase**; b) **Glutathione**

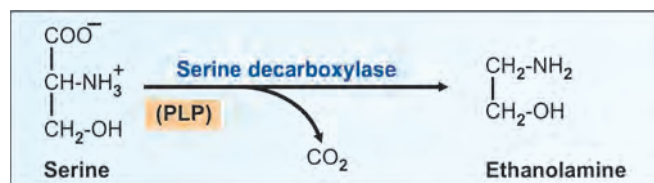


Fig. 16.10: Decarboxylation of serine

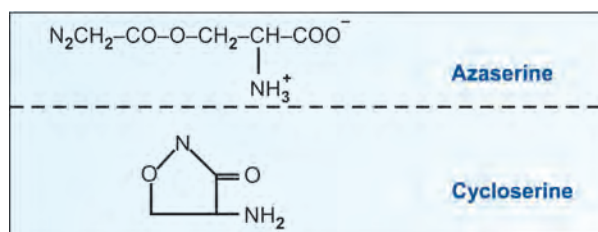
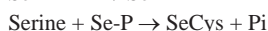


Fig. 16.11: Serine analogs



**peroxidase**, which scavenges peroxides; **c) De-iodinase** that removes iodine from thyroxine to make triiodothyronine and **d) Selenoprotein P**, a glycoprotein seen in mammalian blood. Replacement of Secys by Cys will lead to decreased activity of these enzymes. Deficiency of these enzymes may be related with atherosclerosis, as these enzymes have an antioxidant function. Their concentration falls in selenium deficiency.

Its structure is  $\text{COOH-CHNH}_2\text{-CH}_2\text{-SeH}$ . It is incorporated into protein during translation process. There is a tRNA, specific to carry Secys. The codon is UGA. Biosynthesis of selenocysteine is by replacing the oxygen of serine by selenium; this is done by two steps:



Secys is inserted as such during protein biosynthesis. Its genetic code is UGA. The tRNA-Sec is the specific tRNA, inserting SeCys. However, normally UGA code stands for stop signal. The code for SeCys is UGA, which is identified by a SeCys insertion element in the mRNA, with the help of a specific elongation factor. The tRNA-Sec is first charged with serine, then it is converted into SeCys. This is then inserted into the correct position, when protein is synthesized.

## ALANINE (ALA) (A)

Alanine is a non-essential **glucogenic** amino acid. Alanine can be formed by transamination of pyruvate. The enzyme is alanine amino transferase (ALT) (see Fig 3.18).

Pyruvate + Glutamate  $\rightarrow$  Alanine + alpha ketoglutarate  
This reaction requires **pyridoxal phosphate (PLP)**. ALT level in blood is increased in liver diseases; this **clinical**

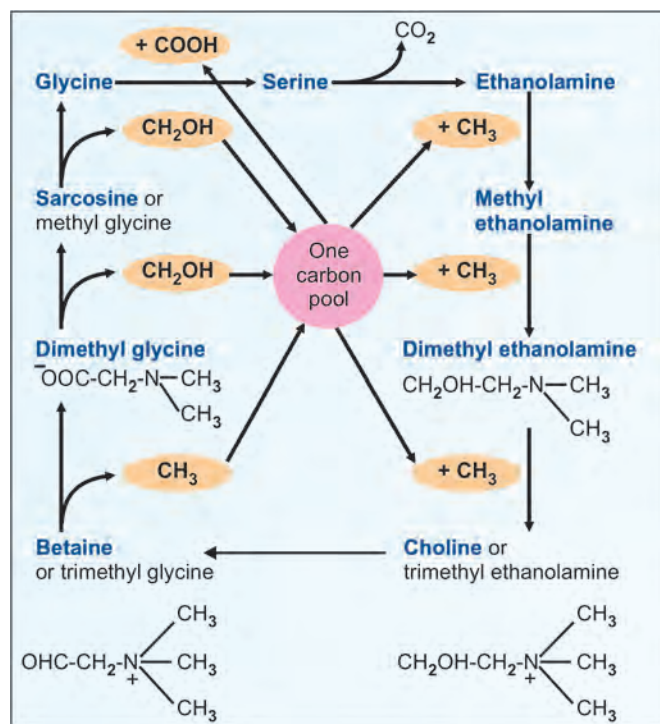


Fig. 16.12: Glycine-serine-choline cycle

**significance** is indicated in Chapter 23. Under conditions of starvation, the glucose alanine cycle is of special metabolic significance (see Fig. 9.30). Alanine is quantitatively the most important amino acid taken up by the liver from peripheral tissues, particularly from skeletal muscle. It forms a major participant in inter-organ transport of nitrogen (see Fig. 15.4).

## Beta alanine

Here the amino group is attached to the beta carbon atom. It is formed during the catabolism of the pyrimidine bases, cytosine and uracil (see Chapter 43). It is mainly used for the synthesis of Coenzyme A (see Chapter 37). In the degradation pathway, beta alanine is transaminated to malonate semialdehyde, then to malonyl CoA.

**Carnosine** is a dipeptide, formed by combination of beta alanine and histidine. Carnosine is a major constituent of muscles. It can activate myosin contraction. Hydrolysis of carnosine to beta alanine and histidine is done by carnosinase. Inherited deficiency of this enzyme will lead to **carnosinuria**.

Carnosine is methylated to form **anserine** which is a source of one-carbon units.

## THREONINE (THR) (T)

It is an essential amino acid. It is glucogenic. Threonine has 2 asymmetric carbon atoms, hence it has 4 diastereoisomers, namely, D-threonine, L-threonine, L-allothreonine and D-allothreonine. Threonine does not directly undergo transamination, but undergoes deamination forming alpha ketobutyric acid (reaction similar to serine, Fig. 16.9). The enzyme is threonine dehydratase. In turn, alpha ketobutyric acid can be oxidatively decarboxylated to propionyl CoA, then converted to succinyl CoA, which enters the gluconeogenesis pathway.

Threonine may be cleaved by threonine aldolase to give rise to glycine plus acetaldehyde. The latter is acted upon by aldehyde dehydrogenase to form acetate, which is converted to acetyl CoA by thio kinase.

The OH group of threonine residue in protein serves to provide a site for phosphorylation (as in the case of serine). This OH group also

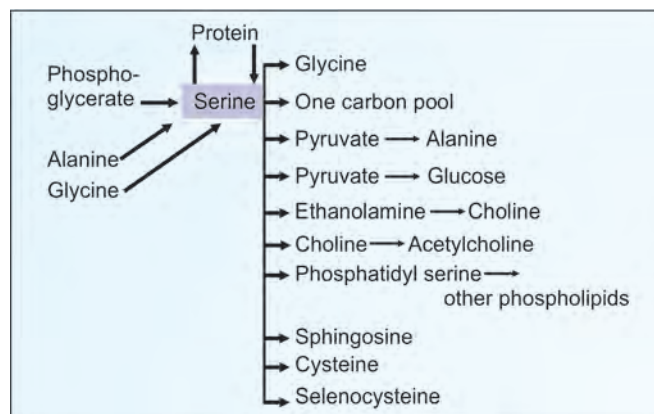


Fig. 16.13: An overview of serine metabolism



serves for combining carbohydrate residues to proteins, so as to make glycoproteins.

## METHIONINE (MET) (M)

It is **sulfur-containing, essential, glucogenic** amino acid. Degradation of methionine results in the synthesis of cysteine. The sparing action of cysteine on methionine is thus explained.

Metabolism of sulfur-containing amino acids may be studied under the following major headings:

- Activation of methionine and transmethylation
- Conversion of methionine to cysteine
- Degradation of cysteine.

- Activation of methionine to SAM:** In the major pathway, methionine is activated to 'active methionine' or S-adenosyl methionine (SAM). The adenosyl group is transferred to the sulfur atom (Step 1, Fig. 16.14). This is done by the enzyme, **methionine adenosyl transferase (MAT)**. There are 3 isoenzymes for MAT, out of which 1 and 3 are of hepatic origin. SAM is the main source of methyl groups in the body.
- Methyl transfer.** In methionine, the thio-ether linkage (C-S-C) is very stable. In SAM, due to the presence of a high energy bond, the methyl group is labile, and

may be transferred easily to other acceptors (Step 2, Fig.16.14; and Table 16.1).

- Homocysteine.** From the S-adenosyl homocysteine (SAH), the adenosyl group is removed to form homocysteine, which is the higher homologue of cysteine (Step 3, Fig.16.14).
- Methionine synthesis.** Homocysteine can be converted to methionine by addition of a methyl group. This methyl group is donated from **one-carbon pool** with the help of vitamin B<sub>12</sub> (Step 4, Fig.16.14).
- Homocysteine degradation:** Homocysteine condenses with serine to form **cystathionine**. This is catalyzed by pyridoxal phosphate dependent cystathionine-beta **synthase** (No.5, Fig. 16.15). Absence of this enzyme leads to **homocystinuria**.
- Cysteine synthesis:** In the next step cystathionine is hydrolyzed by **cystathionase** to form cysteine and homoserine (No.6, Fig. 16.15). Net result is that the **SH group from methionine is transferred to serine to form cysteine**. This is called **trans-sulfuration** reaction.
- Final oxidation:** Homoserine is deaminated and then decarboxylated to propionyl CoA. It finally enters into the TCA cycle as succinyl CoA (see Chapter 12), which is converted to glucose.

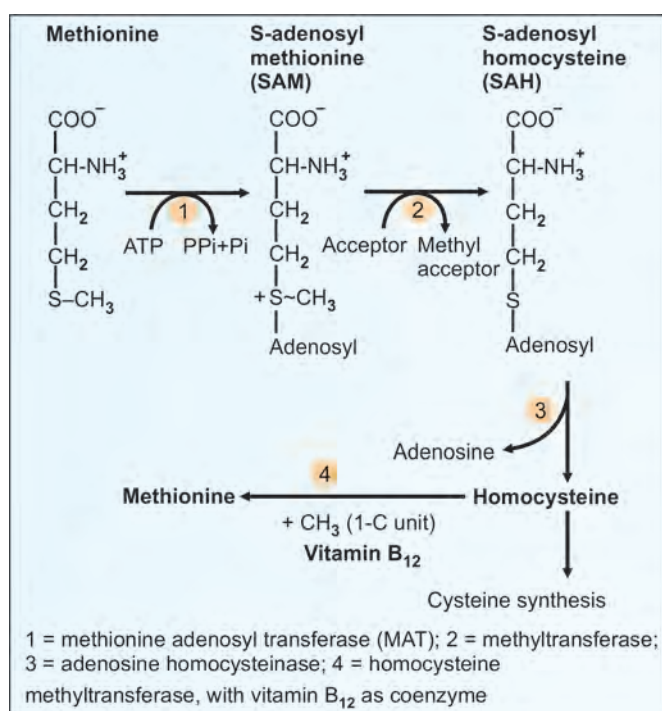


Fig. 16.14: Formation of active methionine

## Methionine in Transmethylation Reactions

The methylation reactions are shown in Table 16.1. Some important products are:

- Creatine** (Fig. 16.5)
- Epinephrine** (see Fig. 18.4)
- Choline** (Fig. 16.12)
- Melatonin** (see Fig. 18.10)

TABLE 16.1: Transmethylation reactions

Methyl acceptor	Methylated product
Guanidinoacetic acid	Creatine
Nicotinamide	N-methyl nicotinamide
Norepinephrine	Epinephrine
Epinephrine	Metanephrine
Norepinephrine	Normetanephrine
Ethanolamine	Choline
Carnosine	Anserine
Acetyl serotonin	Melatonin
Serine	Choline
Histidine	Methyl histidine
Lysine	Methyl lysine
tRNA	Methylated tRNA

These reactions are called **methyl transfer reactions**, and these are carried out with the help of **S-adenosyl methionine (SAM)** (Step 2, Fig. 16.14). Methyl groups are originally derived from the one carbon pool (Details in Chapter 15). The methyl-THFA can transfer the methyl group to homocysteine (Step 4, Fig.16.14). **Vitamin B<sub>12</sub>** is the co-enzyme for the reaction. This would account for the deficiency of folic acid associated with B<sub>12</sub> deficiency (folate trap). SAM is the methyl donor for all the transmethylation reactions.

A summary of methionine metabolism is shown in Figure 16.16. The roles played by vitamins are also shown in that figure.

## ■ CYSTEINE (CYS) (C)

It is non-essential and **glucogenic**. Cysteine is present in large quantity in keratin of hair and nails.

**Formation** of Cysteine is by using the carbon skeleton contributed by serine and sulfur originating from methionine. Methionine → SAM → SAH → Homocysteine → Cystathionine → Cysteine (Figs 16.15 and 16.16). See Trans-sulfuration, item No.6, under methionine degradation.

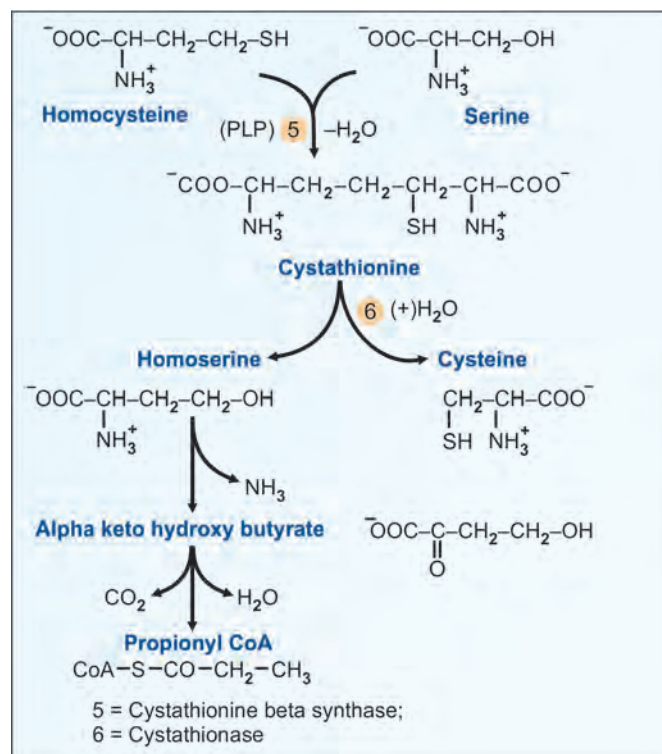


Fig. 16.15: Cysteine formation

## Degradation of Cysteine

1. **Transamination:** Cysteine is transaminated to form beta mercapto pyruvic acid and finally pyruvate (Fig.16.17). The beta mercapto pyruvate can transfer the S to CN to form thiocyanate (SCN).
2. The sulfur may be removed either as **H<sub>2</sub>S** or elemental sulfur or as **sulfite**.
3. Cysteine on **decarboxylation** gives beta **mercapto ethanolamine** (Fig.16.18). This is used for synthesis of **co-enzyme A** (see Chapter 37).

## Metabolic Functions of Cysteine

### Formation of Glutathione

Glutathione is gamma glutamyl cysteinyl glycine (Fig. 16.19). Glutathione is generally abbreviated as GSH, to indicate the reactive SH group. It was isolated in 1921 by Sir Frederick Hopkins (Nobel prize, 1929).

Glutamate + Cysteine → gamma glutamyl cysteine

Glutamyl cysteine + glycine → glutathione

Both steps need hydrolysis of each ATP.

### Amino Acid Transport

The role of glutathione in the absorption of amino acid is shown in Figure 15.3.

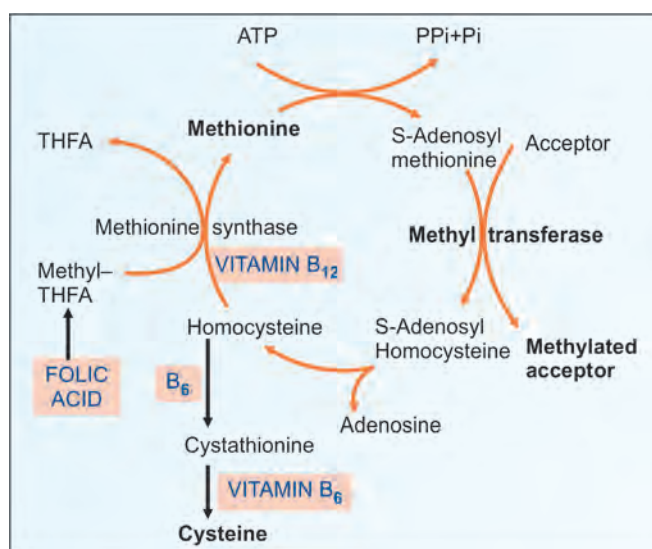
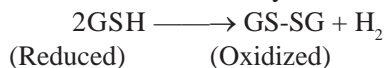


Fig. 16.16: Summary of methionine to cysteine conversion. Note the role played by vitamins

### Co-enzyme Role

Metabolic role of GSH is mainly in reduction reactions



The hydrogen released is used for reducing other substrates.

A few examples are shown below:

- i. Maleylacetoacetate  $\rightarrow$  fumarylacetoacetate
- ii. Cysteic acid  $\rightarrow$  taurine (Fig. 16.22)
- iii. (Iodine)  $\text{I}_2 + 2\text{GSH} \rightarrow 2\text{HI} + \text{GS-SG}$

### RBC Membrane Integrity

Glutathione is present in the RBCs. This is used for inactivation of free radicals formed inside RBC. The enzyme is **glutathione peroxidase**, a selenium containing enzyme (GPx in Fig.16.21). The glutathione is regenerated by an NADPH dependent **glutathione reductase** (GR in Fig.16.21). The NADPH is derived from the glucose-6-phosphate (GPD) shunt pathway. The occurrence of hemolysis in GPD deficiency is attributed to the decreased regeneration of reduced glutathione (see Chapter 33).

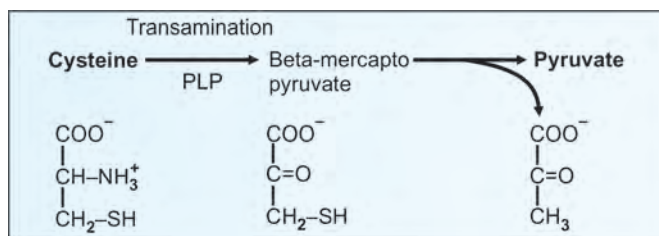


Fig. 16.17: Pyruvate formation from cysteine

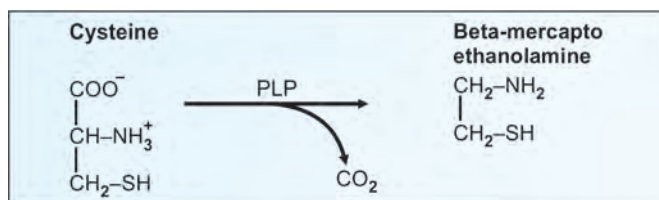


Fig. 16.18: Decarboxylation of cysteine

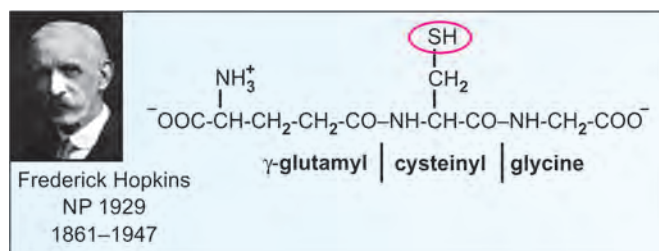
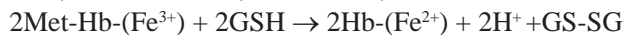


Fig. 16.19: Glutathione

### Met-hemoglobin

The met-Hb is unavailable for oxygen transport. Glutathione is necessary for the reduction of met-hemoglobin (ferric state) to normal Hb (ferrous state).



### Conjugation for Detoxification

Glutathione helps to detoxify several compounds by transferring the cysteinyl group, e.g.

- a. organophosphorus compounds
- b. halogenated compounds
- c. nitrogenous substances (chlorodinitrobenzene)
- d. heavy metals
- e. drug metabolism.

The reaction is catalyzed by **glutathione-S-transferase** (GST) (step 1 in Fig.16.20). GST is seen in all tissues, especially in liver. GST is a dimer; and each chain may be any one out of 4 polypeptides; so there are 6 iso-enzymes. These are named as A, B, C, D, E and AA. Moreover, many polymorphic forms of GST are also described.

### Activation of Enzymes

Many enzymes having SH groups in the active site are kept in the active form by the glutathione. Such enzymes are active in the reduced form. Glutathione keeps the enzymes in reduced, active state.

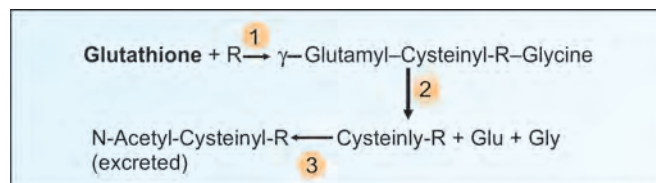


Fig.16.20: Detoxification by glutathione

1 = Glutathione-S-transferase (GST); 2 = peptidase; 3 = acetylase

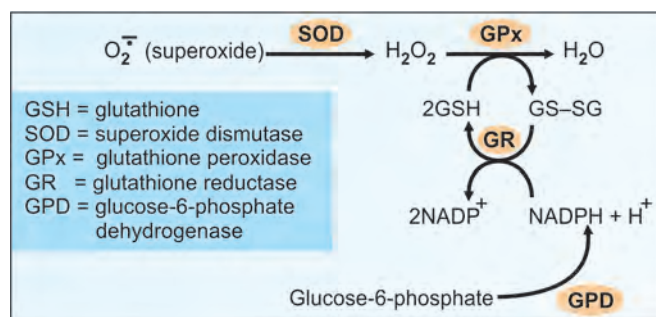
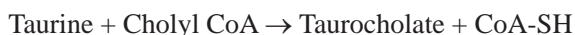


Fig. 16.21: Free radical scavenging



### Formation of Taurine

Cysteine is oxidized to cysteic acid (step 1, Fig.16.22) and then decarboxylated to form taurine (step 2). Alternatively cysteine is oxidized to cysteine sulfinic acid. It is then decarboxylated by a decarboxylase to hypotaurine which in turn is oxidized to taurine. Taurine is used for conjugation of bile acids.



Taurine is a modulator of calcium fluxes, calcium binding and movement. In the CNS it is an inhibitory neurotransmitter.

Taurine is widely distributed in animal tissues. It is found in bile and large intestine. Taurine has multiple functions in the body including conjugation of bile acids, antioxidant role, osmoregulation, membrane stability and calcium signaling. It is important for the development of cardiovascular system, development and function of skeletal system, eyes and central nervous system. Some reports suggest it can be used as treatment for cirrhosis and essential hypertension in experimental animals.

### Keeping the Correct Structure of Proteins

Cysteine residues in polypeptide chains form disulfide bridges to make active proteins, e.g. insulin (see Chapter 4) and immunoglobulins (see Chapter 55). Protein disulfide isomerase forms these disulfide bonds. A summary of the methionine and cysteine metabolism is shown in Box 16.1.

### Metabolism of Sulfur

The sulfur present in body may be either **organic** sulfur as a component of proteins (sulfur-containing amino acids) or as part of sulfatides and glycosaminoglycans (GAG). **Inorganic** sulfur is derived from the sulfur-containing amino acids by trans-sulfuration or desulfuration reactions. The  $\text{H}_2\text{S}$  derived from cysteine may be oxidized to sulfites and thiosulfates and further oxidized to sulfate. The excretory forms of sulfur in urine are:

- inorganic sulfates,
- organic or ethereal sulfates, and
- neutral sulfur.

### Formation of Active Sulfate

Active sulfate or Phosphoadenosine phospho-5'-sulfate (PAPS) is formed by the reaction between ATP and  $\text{SO}_4$  and the sulfate is attached to the ribose-5'-phosphate (Fig.16.23). PAPS is used for various sulfuration reactions, e.g. synthesis of sulfatides, glycosaminoglycans, etc.

## ■ CYSTINURIA

Cystinuria is one of the inborn errors of metabolism included in the Garrod's tetrad. It is an autosomal **recessive** condition. The disorder is attributed to the **deficiency in transport of amino acids** (Table 16.2). Signs and symptoms include

- Abnormal excretion of cystine and to a lesser extent lysine, ornithine and arginine. Hence the condition is also called **Cystine-lysineuria**.
- Crystalluria and calculi formation. In acidic pH, cystine crystals are formed in urine (Fig. 16.24A).

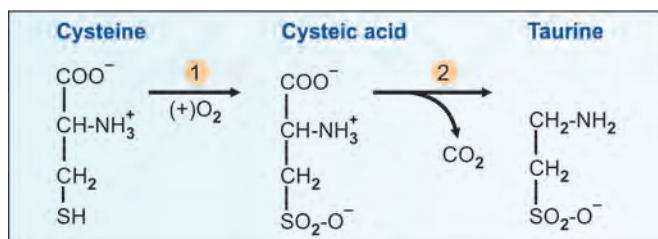
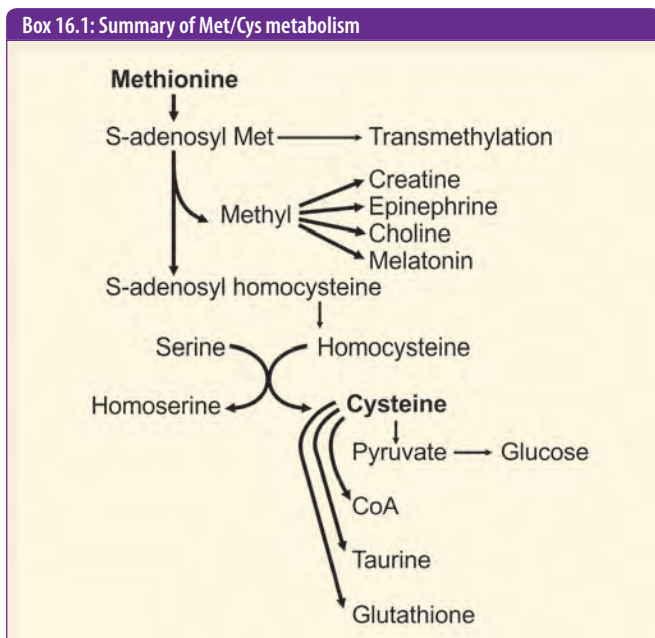


Fig. 16.22: Formation of taurine from cysteine

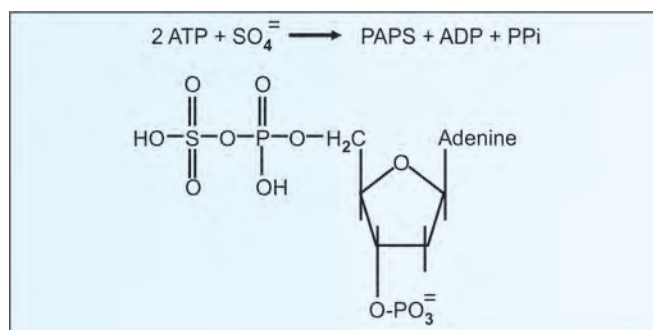


Fig. 16.23: Phosphoadenosine phospho sulfate (PAPS)



- iii. Obstructive uropathy, which may lead to renal insufficiency (Fig. 16.24).
- iv. Treatment is to increase urinary volume by increasing fluid intake. Solubility of cystine is increased by alkalinization of urine by giving sodium bicarbonate.

### Cyanide-Nitroprusside Test

It is a screening test. Urine is made alkaline with ammonium hydroxide and sodium cyanide is added. Cystine, if present, is reduced to cysteine. Then add sodium nitroprusside to get a magenta-red colored complex. Specific amino aciduria may be confirmed by chromatography.

### Cystinosis

It is a familial disorder characterized by the widespread deposition of cystine crystals in the lysosomes. Cystine accumulates in liver, spleen,

bone marrow, WBC, kidneys, cornea and lymph nodes (Table 16.2). There is an abnormality in transport of cystine which is responsible for the accumulation. It is an autosomal recessive condition. Microscopy of blood shows cystine crystals in WBCs. Treatment policies are to give adequate fluid so as to increase urine output, alkalinization of urine by sodium bicarbonate, as well as administration of D-penicillamine.

### Hypermethioninemias

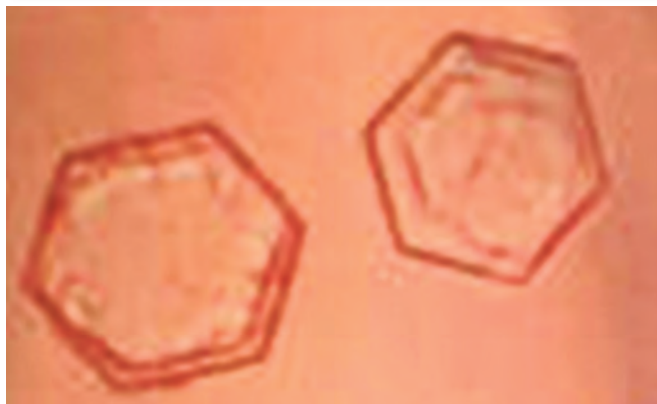
Causes of hypermethioninemia are:

1. Impaired utilization
2. Excessive remethylation of homocysteine
3. Secondary to hepatic dysfunction.

**Oasthouse syndrome** is due to malabsorption of methionine. Such children excrete methionine, aromatic amino acids and branched chain amino acids in urine.

**TABLE 16.2:** Amino acidurias related to sulfur containing amino acids

	<i>Cystinuria</i>	<i>Homocystinuria</i>	<i>Cystathioninuria</i>
Deficiency in	Transport system	Cystathionine synthase	Cystathionase
Mental retardation	–	+++	+++
Tissue deposition	–	–	–
Ectopia lentis	–	+	–
Thrombosis	–	+	–
Renal insufficiency	Late	–	–
Renal calculi and crystalluria	+	–	–
Amino aciduria	Cystine	Homocysteine	Cystathionine
Amino acid increased in blood	–	Methionine, Homocysteine	Cystathionine
Nitroprusside test	++	+++	–
Supplement	Fluid and alkali	Cysteine Pyridoxine	Cysteine
Restrict	--	Methionine	Met



**Fig. 16.24A:** Cystine crystals in urine

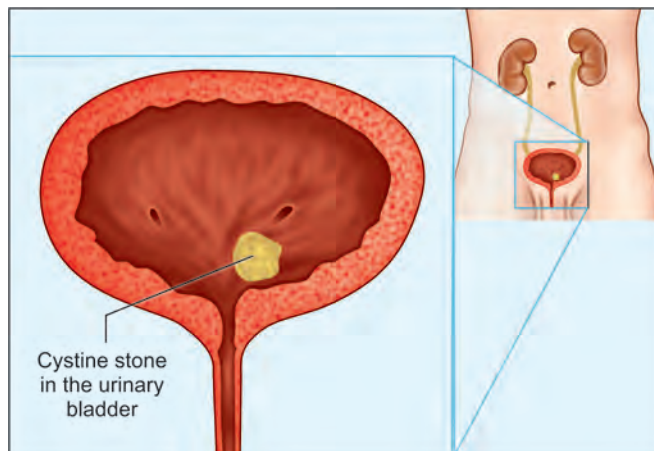
### HOMOCYSTINURIAS

First described in 1962, these are the latest in the series of inborn errors of metabolism. All of them are autosomal recessive conditions. Incidence is 1 in 200,000 births.

Normal homocysteine level in blood is 5–15 micromol/L. In diseases, it may be increased to 50 to 100 times. Moderate increase is seen in aged persons, vitamin B<sub>12</sub> or B<sub>6</sub> deficiency, tobacco smokers, alcoholics and in hypothyroidism. Substantial increase is noticed in congenital diseases.

Large amounts of homocysteine are excreted in urine. In plasma, homocysteine (with -SH group) and homocysteine (disulfide, -S-S- group) exist. Both of them are absent in normal urine; but if present, it will be the homocysteine (disulfide) form.

If homocysteine level in blood is increased, there is increased risk for coronary artery diseases. Clinical importance is shown in Box 16.2. Other important diseases



**Fig. 16.24B:** Cystine stone in the bladder

associated with hyperhomocysteinemia are neurological disorders (stroke), pre-eclampsia of pregnancy, chronic pancreatitis, etc.

The following are the causes of congenital homocystinurias:

### Cystathionine Beta Synthase Deficiency

- i. It causes elevated plasma levels of methionine and homocysteine. There is increased excretion of methionine and homocysteine in urine. Plasma cysteine is markedly reduced.
- ii. General symptoms are **mental retardation** and **Charley Chaplin gait**. Skeletal deformities are also seen.
- iii. In eyes, **ectopia lentis** (subluxation of lens), myopia and glaucoma may be observed.
- iv. Homocysteine causes activation of Hageman's factor. This may lead to increased platelet adhesiveness and life-threatening intravascular **thrombosis**.
- v. **Cyanide-nitroprusside** test will be positive in urine. Urinary excretion of homocysteine is more than 300 mg/24 h. Plasma homocysteine and methionine levels are increased.
- vi. **Treatment** is a diet **low in methionine** and rich in cysteine. Sometimes the affinity of apo-enzyme to the co-enzyme is reduced. In such cases, pyridoxal phosphate, the co-enzyme given in large quantities (500 mg) will correct the defect.

### Cobalamin Deficiency

The enzyme, N<sup>5</sup>-methyl-THFA-homocysteine-methyl-transferase is dependent on vitamin B<sub>12</sub>. Therefore, vitamin B<sub>12</sub> deficiency may produce

#### Box 16.2: Homocysteine and heart attacks

An increase of 5 micromol/L of homocysteine in serum elevates the risk of coronary artery disease by as much as cholesterol increase of 20 mg/dL. Homocysteine interacts with lysyl residues of collagen interfering with collagen cross linking. Homocysteine interacts with lysyl aldehyde groups on collagen and bind to fibrillin producing endothelial dysfunction. Many patients with homocysteinemia also have Marfanoid features since the protein fibrillin is defective. It forms homocysteine thiolactone, a highly reactive free radical which thiolates LDL particles. These particles tend to aggregate, are endocytosed by macrophages and increase the tendency for atherogenesis.

Providing adequate quantity of pyridoxine, vitamin B<sub>12</sub> and folic acid will keep homocysteine in blood at normal levels.

Maternal hyperhomocysteinemia is known to increase the chances of neural tube defects in fetus. So, high doses of folic acid are advised in pregnancy.

alteration in methionine metabolism. Blood contains increased level of homocysteine, but methionine level is low. Urine contains homocysteine.

### Deficient N<sup>5</sup>, N<sup>10</sup>-Methylene THFA Reductase

This enzyme catalyzes the reaction N<sup>5</sup>, N<sup>10</sup>-methylene-THFA to N<sup>5</sup>-methyl-THFA (Fig.16.16). Deficiency of this enzyme leads to reduced methionine synthesis with consequent increase in homocysteine level in urine. Behavioral changes and vascular abnormalities may be observed. Folate supplementation is beneficial. **MTHFR gene polymorphism (MTHFR C677T)** is seen in **hyperhomocysteinemia**.

### Cystathioninuria

It is due to **cystathionase deficiency**. It is an autosomal recessive condition. **Mental retardation**, anemia, thrombocytopenia, and endocrinopathies accompany this condition. Less severe forms may be seen in conditions interfering with homocysteine remethylation, in B<sub>12</sub> deficiency and in impaired folate metabolism. Acquired Cystathioninuria may be due to pyridoxine deficiency. It may also be seen in liver diseases and after thyroxine administration. Diagnosis rests on cyanide-nitroprusside test (negative) and detection of cystathionine in urine. Large quantities of pyridoxine (200–400 mg) may be beneficial.

### Acquired Hyperhomocysteinemias

- a. Nutritional deficiency of vitamins, such as cobalamin, folic acid and pyridoxine.
- b. Metabolic: Chronic renal diseases, hypothyroidism.
- c. Drug induced: Folate antagonists, vitamin B<sub>12</sub> antagonists; pyridoxine antagonists; estrogen antagonists, nitric oxide antagonists.

Table 16.2 shows the salient features of these amino acidurias.

### Clinical Case Study 16.1

A 36-year-old woman reported with a dull pain in the left flank which was radiating towards left leg. She reports fever and inability to pass urine for the last few days. Similar history of illness was reported in the last 6 months. She was anemic and abdomen was tender. Routine urinalysis revealed presence of RBC, pus cells, WBC casts, characteristic hexagonal crystals and amino acids. What is the probable cause? What is the pathogenesis of the condition?

### Clinical Case Study 16.2

An adolescent girl presents with subluxation of lens and mental retardation. On examination, she is tall and thin with elongated limbs. Mild scoliosis was present with

pectus excavatum and genu valgum. One of her sisters had similar complaints. What is the likely disorder? What is the basis of the disease?

### Clinical Case Study 16.1 Answer

The likely cause is cystinuria. Cystinuria is characterized by build-up of cystine stones or crystals in kidneys and bladder. Patients with cystinuria cannot properly reabsorb cystine into their bloodstream and the amino acid accumulates in their urine. As urine becomes more concentrated, excess cystine forms crystals that can lodge in bladder or kidneys. Cystine can also combine with calcium to form larger stones. They can block passage of urine and this can also lead to infections.

Symptoms are recurrent nephrolithiasis and obstruction of urine flow. This can produce severe, sudden onset of flank pain, blood in urine, infection which can produce fever, WBC in urine and in advanced cases, renal failure.

The disease is inherited as autosomal recessive. Diagnostic tests are sodium nitroprusside test; cystine stones are detected by X-rays as they are radiopaque or by CT of kidneys. Traditionally intravenous pyelogram (IVP) was used. Microscopy reveals flat hexagonal crystals of cystine.

Treatment is aimed at eliminating stones and preventing new stones. Dietary sodium and protein restriction increases cystine excretion. Urine alkalization improves cystine solubility. Severe cases need surgical intervention.

In the condition cystinosis, excess cystine crystals accumulate in eyes and kidneys. This is a lysosomal storage disorder and is also inherited as autosomal recessive condition. There is mutation in the gene CTNS, which codes for the protein cystinosin, the lysosomal cystine transporter. Symptoms include excessive urination, followed by poor growth, photophobia and renal failure by age 6. Cystinosis is the common cause of renal Fanconi syndrome. There is loss of large amounts of salt and other minerals in urine. Definitive diagnosis is by measurement of WBC cystine levels. The drug cysteamine is used to clear cystine. Replenishment of lost fluid and electrolytes, as well as high doses of vitamin D and phosphorus is needed.

### Clinical Case Study 16.2 Answer

Likely cause is homocystinuria. Classical homocystinuria is due to the deficiency of enzyme, CBS. It is inherited as an autosomal recessive condition. Common clinical features

are failure to thrive, developmental delay, ectopia lentis (subluxation of lens), severe myopia, cataracts, retinal detachment and optic atrophy during infancy and early childhood. Progressive mental retardation may be there, but in some individuals intelligence may be normal. Skeletal abnormalities may resemble Marfan syndrome. Generalized osteoporosis may be present. Thromboembolic episodes involving large and small vessels, especially those of the brain, are common and may be seen at any age. Elevated homocysteine level (hyperhomocysteinemia) is an independent risk factor for coronary artery disease, cerebrovascular diseases, peripheral arterial disorders as well as deep vein thrombosis. During pregnancy, it can lead to neural tube defects in embryo and pre-eclampsia in pregnant mother.

Diagnosis is by amino acid screen in urine and blood (homocysteine and methionine are elevated, cystine will be low), liver biopsy and enzyme assay, skeletal X-ray, skin fibroblast enzyme assay, standard ophthalmic testing and genetic testing. Treatment with high doses of pyridoxine, folic acid, B<sub>12</sub> and betaine reduces homocysteine levels.

## QUICK LOOK OF CHAPTER 16

1. Glycine may be formed from serine, threonine and by the action of the enzyme glycine synthase.
2. Glycine is used in the biosynthesis of heme, creatine, purine and glutathione.
3. Stored creatine phosphate acts as an immediate source of energy in the muscle. ATP is generated by its hydrolysis by Lohmann's reaction.
4. Serine occurs in the active sites of many proteolytic enzymes, such as Trypsin and Chymotrypsin. Such enzymes are called 'serine proteases'.
5. Major metabolic role of alanine is to provide substrate for gluconeogenesis.
6. Methionine is activated to S-adenosyl methionine (SAM). This participates in transmethylation reactions.
7. Cysteine is a component of the tripeptide Glutathione.
8. Glutathione helps in amino acid transport, acts as a coenzyme for reduction reactions, maintains RBC membrane integrity and helps in detoxification.
9. Cystinuria is an inborn metabolic disorder resulting from deficiency of amino acid transporter. Symptoms include crystalluria, uropathy and secondary infections.
10. Cystathionuria is due to cystathionase deficiency. Mental retardation, anemia and endocrinopathies accompany this condition.

# CHAPTER 17

## Acidic, Basic and Branched Chain Amino Acids

(Glutamic acid, Aspartic acid, Glutamine, Asparagine, Lysine, Arginine, Nitric Oxide, Valine, Leucine, Isoleucine)

### Chapter at a Glance

The reader will be able to answer questions on the following topics:

- Glutamic acid
- Glutamine
- Aspartic acid
- Asparagine
- Lysine
- Arginine, nitric oxide
- Ornithine, polyamines
- Valine, leucine, isoleucine

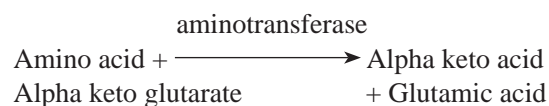
### Acidic Amino Acids and their Amides

The acidic amino acids are glutamic acid and aspartic acid. Glutamine and asparagine are the corresponding amides formed by addition of ammonia to the extra-carboxyl group to form an amide. All the four amino acids are used for protein synthesis and serve important metabolic functions. Since glutamic acid and aspartic acid remain ionized at the physiological pH, they are often referred to as glutamate and aspartate.

#### GLUTAMIC ACID (GLU) (E)

Glutamic acid was isolated by Ritthausen in 1866. It plays a central role in the metabolism of amino acids. It is generated during transamination reactions.

1. **Transamination reactions:** Most amino acids transfer their amino group to alpha keto glutaric acid to form glutamic acid (see Fig. 15.8).



2. Glutamic acid is also formed during the metabolism of histidine, proline and arginine.
3. **Oxidative deamination:** Glutamic acid is deaminated to form alpha keto glutarate by the enzyme glutamate dehydrogenase with the help of  $\text{NAD}^+$  (see Fig. 15.9).  
 $\text{Glutamic acid} \longrightarrow \text{Alpha keto glutarate} + \text{NH}_3$   
With the help of NADPH, this reaction is reversible, so that glutamic acid can be synthesized.
4. **Glucogenic:** Glutamic acid enters the TCA cycle as  $\alpha$  ketoglutarate, gets converted to oxaloacetate and enters the glucogenic pathway.
5. **N-acetyl glutamate (NAG)** is a positive modifier of carbamoyl phosphate synthetase-I in the mitochondria.  
 $\text{Glutamic acid} + \text{Acetyl CoA} \rightarrow \text{NAG} + \text{CoASH}$



6. **Glutamine:** (See below)
7. **Gamma carboxy glutamic acid (GCGA)** is present in prothrombin. The gamma carboxyl group is added as a post-translational modification, which needs vitamin K (see Chapter 36).
8. **Excitatory neurotransmitter.** Neurons contain NMDA (N-methyl-D-aspartate) receptor, named after a drug that selectively binds to it. Stimulation of NMDA receptors by glutamate opens calcium channel, leading to stimulation of NOS (nitric oxide synthase). This results in transient production of NO<sup>•</sup> (**nitric oxide**). NO<sup>•</sup> binds with high affinity to the guanyl cyclase; the active guanyl cyclase raises the cellular level of cyclic GMP in neighboring neurons. Thus neurons are excited.
9. **Glutathione:** Glutamate is a constituent of the tripeptide glutathione (see Fig. 16.19). It is used by bacteria for folic acid synthesis. Glutamic acid metabolism is summarized in Figure 17.4.
10. Glutamic acid is decarboxylated to GABA.
11. Glutamic acid is used by bacteria for folic acid synthesis.

### Gamma Amino Butyric Acid (GABA)

- A. Metabolism:** Glutamic acid on decarboxylation gives rise to gamma amino butyric acid (GABA). (Step 1, Fig. 17.2). Part of the glutamate in the brain can be shunted through the GABA pathway and catabolized to succinate (Steps 2 and 3, Fig. 17.2).
- B. GABA is an inhibitory neurotransmitter** because it opens the **chloride channels** in post-synaptic membranes in CNS.
- C. Pyridoxal phosphate:** Both the formation and catabolism of GABA requires pyridoxal phosphate as co-enzyme (Steps 1 and 2, Fig. 17.2). Therefore, in pyridoxine deficiency the metabolism of glutamate by the GABA shunt pathway is affected.
- D.** Since GABA is an inhibitory transmitter, a low level of GABA or deficiency of pyridoxal phosphate would lead to **convulsions**. Sodium **valproate** which inhibits GABA oxidase is used in the treatment of epilepsy.
- E.** Congenital **deficiencies** of GABA amino transferase and succinic semialdehyde dehydrogenase (leading to hydroxy butyric aciduria) are reported, but are very rare.

### GLUTAMINE (GLN) (Q)

Glutamine was isolated as free amino acid from beetroot by Schulze and Bosshard in 1833. Glutamine was identified as a member of all proteins by Charles Chibnall and Manayath Damodaran in 1932.

1. It is a **glucogenic** amino acid. It is synthesized from glutamic acid (Fig. 17.1).
2. The amidation of glutamic acid to glutamine is catalyzed by **glutamine synthetase**. Glutamic acid can react with a molecule of NH<sub>3</sub> in presence of ATP (Fig. 17.1). This reaction is important in ammonia trapping in brain as well as for transport of ammonia in a nontoxic form (see Chapter 15).
3. Glutamine is hydrolyzed to glutamate and NH<sub>3</sub> by the enzyme glutaminase. This reaction is seen in the renal tubular cells. This **ammonia reacts with H<sup>+</sup>** to buffer acids excreted in urine (see Chapter 29).

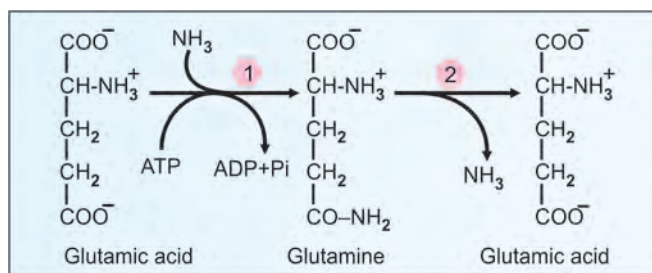


Fig. 17.1: 1 = glutamine synthetase; 2 = glutaminase

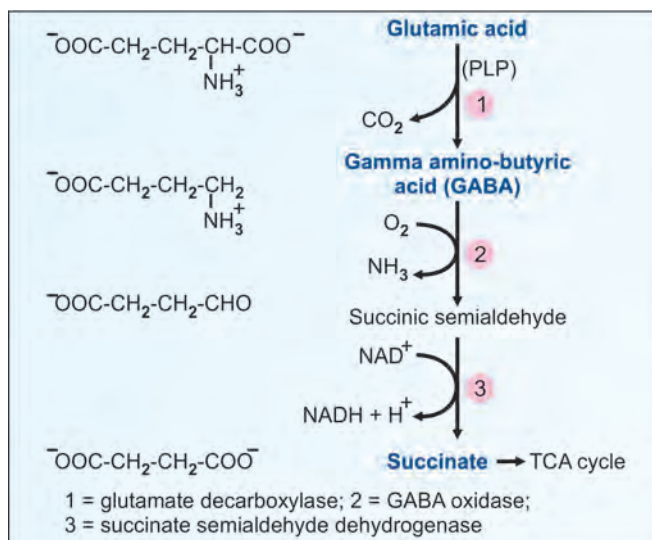


Fig. 17.2: GABA metabolism

- Major fate of glutamine is to be hydrolyzed to glutamate and  $\text{NH}_3$  (Fig. 17.1). Glutamic acid is then deaminated to alpha ketoglutarate and enters TCA cycle for further catabolism.
- The N atoms **3 and 9** of **purines** are derived from glutamine (see Chapter 43).
- Glutamine is the source of **3rd N of pyrimidine**.
- Glutamine is the source of  $\text{NH}_2$  group of **guanine** and **cytosine** (see Chapter 43).
- Glutamine is a **conjugating agent**, e.g. production of phenyl acetyl glutamine (see phenylketonuria, Chapter 18).
- Glutamine donates the amino group of amino sugars and amide group of nicotinamide. Glutamine metabolism is summarized in Figure 17.4.

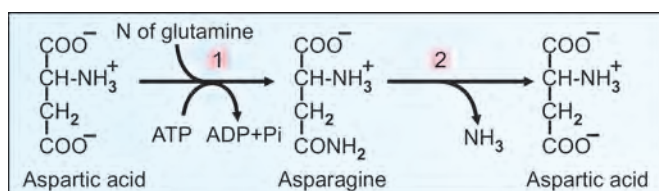


Fig. 17.3: Asparagine synthesis and breakdown. 1 = asparagine synthetase; 2 = asparaginase. Compare these reactions with those of Figure 17.1

### GABA, NMDA Receptors, Neurotransmitters

Glutamate receptors are synaptic receptors and are located primarily on the membranes of neuronal cells. Glutamate is an important neurotransmitter. Glutamate receptors are responsible for glutamate mediated post synaptic excitation of neural cells. They are important for neural communication, memory formation, learning and regulation. Defects in glutamate receptors are implicated in a number of neurodegenerative diseases.

The NMDA receptor is a non-specific cationchannel and it allows transport of ions like  $\text{Ca}^{++}$ ,  $\text{Na}^+$  and  $\text{K}^+$  and is blocked by  $\text{Mg}^{++}$ . It plays a critical role in synaptic plasticity, a cellular mechanism for learning and memory. The receptor is activated by binding of glutamate (or aspartate) and glycine. They also mediate excitotoxic neuronal death. Antagonists of NMDA receptors are used as anesthetics. Examples are amantadine, ketamine, nitrous oxide, dextromethorphan and ethanol. NMDA receptors are modulated by a large number of endogenous and other exogenous compounds. NMDA receptor agonists include D cycloserine, L aspartate, D serine and L alanine.

### GLUTAMATE TRANSPORTERS

L-Glutamate (Glu) is the major excitatory neurotransmitter in the mammalian CNS and five types of high-affinity Glu transporters (EAAT1–5) have been identified. The transporters EAAT1 and EAAT2 in glial cells are responsible for the majority of Glu uptake while neuronal EAATs appear to have specialized roles at particular types of synapses. Dysfunction of EAATs is specifically implicated in the pathology of neurodegenerative conditions such as amyotrophic lateral sclerosis, epilepsy, Huntington's disease, Alzheimer's disease and ischemic stroke

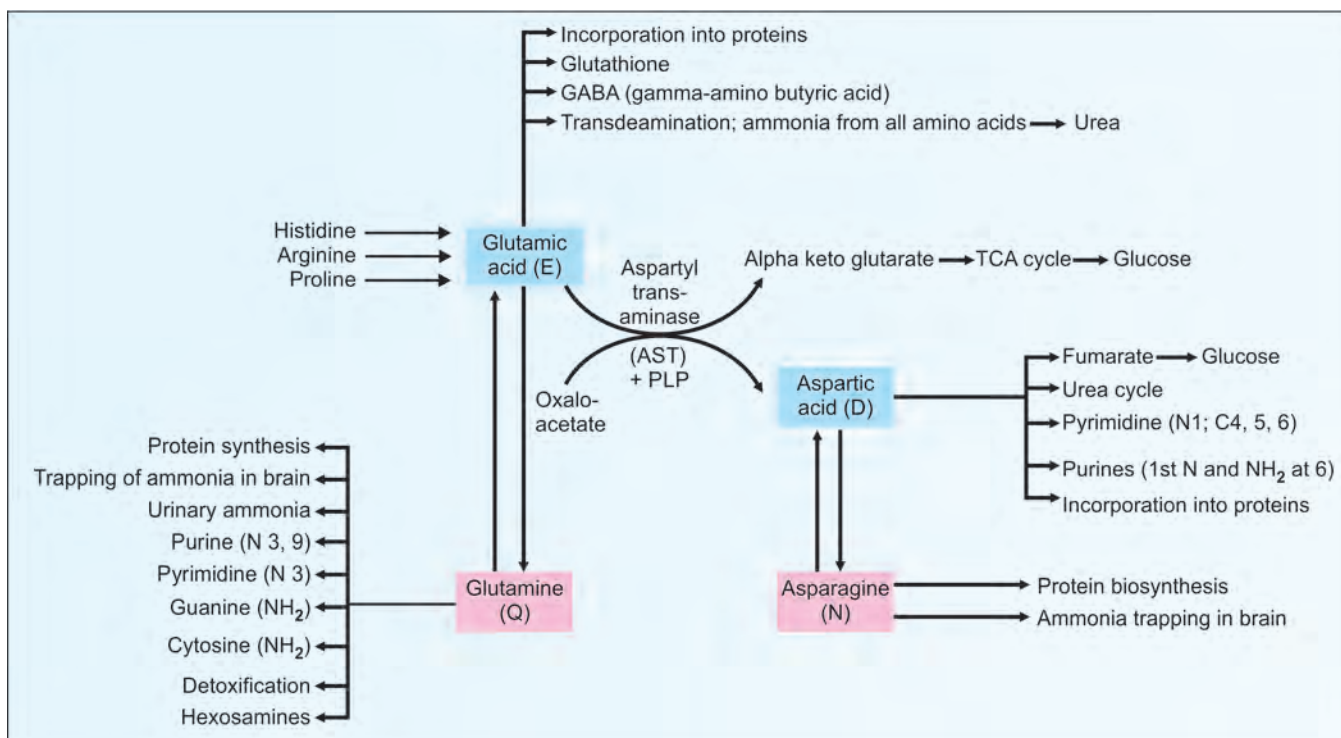
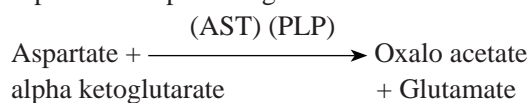


Fig. 17.4: Summary metabolisms of aspartic acid, asparagine, glutamic acid, and glutamine

injury, and thus treatments that can modulate EAAT function may prove beneficial in these conditions. Recent advances have been made in our understanding of the regulation of EAATs, including their trafficking, splicing and post-translational modification.

## ■ ASPARTIC ACID (ASP) (D)

1. It was isolated by Kreisler in 1869. It is a non-essential, **glucogenic** amino acid.
2. Aspartate, on transamination gives rise to oxalo acetate which initiates the TCA cycle. Aspartate amino transferase (AST) transfers the amino group of aspartate to alpha ketoglutarate to form oxalo acetate.



3. The clinical significance of AST is described in Chapter 23. AST is increased in cardiac ischemia and in hepatic diseases.
4. **Malate aspartate shuttle** transfers the cytoplasmic NADH into mitochondria for oxidation in the electron transport chain (see Fig. 20.5).
5. Aspartic acid is an important member of **urea cycle** (see Fig. 15.12). It directly contributes its **alpha amino group** to the urea molecule.
6. The carbon skeleton of aspartate can also enter the glucogenic pathway as fumarate.  

$$\text{Citrulline} + \text{Aspartate} \longrightarrow \text{Arginine} + \text{Fumarate}$$
7. Aspartate is used for the synthesis of **purines** (1st nitrogen and 6th NH<sub>2</sub> group) (see Fig. 43.10).
8. The whole molecule of aspartate is incorporated into the **pyrimidine ring** (1st nitrogen and carbons 4, 5, 6) (see Fig 43.17). Aspartic acid metabolism is summarized in Figure 17.4.

## ■ ASPARAGINE (ASN) (N)

It is so named because it is originally isolated from asparagus. Vauquelin and Robiquet in 1906 isolated asparagine. It was shown to be a member of all proteins by Manayath Damodaran in 1932. Aspartate reacts with ammonia to form asparagine (Fig. 17.3). This is a reaction similar to formation of glutamine. But glutamine (and not ammonium ion) provides the nitrogen atom. Asparagine can be hydrolyzed to aspartate and NH<sub>3</sub> by asparaginase. L-**asparaginase** is an anticancer drug against leukemias and lymphomas, because those cells cannot synthesize asparagine; the enzyme will destroy the available asparagine in the blood; so the cancer cells will die. Asparagine is a **glucogenic** amino acid (Fig. 17.4).

### Dicarboxylic Amino Aciduria

A few cases have been reported. The manifestations may vary; some having mental retardation and hypoglycemia, while others were

asymptomatic. The defect is attributed to the defect in renal tubular reabsorption of glutamate and aspartate.

## Lysine (lys) (K)

Drechsel in 1889 isolated lysine; Hopkins in 1907 showed its essentiality for growth; Schryver and Buston in 1925 identified hydroxylysine. Lysine is an essential basic amino acid. It is **deficient in cereals**. It does not undergo transamination. Lysine is predominantly **ketogenic**. Alpha keto glutarate combines with lysine to form **Saccharopine**, from which glutamate is removed. This catabolic pathway further proceeds through the intermediates of aminoadipic acid, alpha keto adipic acid, glutaryl CoA, crotonyl CoA and finally into the pathway of odd numbered fatty acids. **Hyperlysinemias** result from congenital deficiency of any of the enzymes of the above pathway. Mental retardation and cortical degeneration are seen in these conditions. Lysine serves the following functions:

- a. Lysine and **hydroxy lysine** residues of collagen and elastin are important in cross linking (see Chapter 58). Hydroxyl group is usually attached to the delta carbon atom of lysine.
- b. The epsilon amino group of lysine can form Schiff bases, thus **linking to proteins**, e.g. Pyridoxal phosphate with transaminases.
- c. Negative charge of epsilon amino group of lysine forms **salt bridges** with oppositely charged groups. This is important in maintenance of quaternary structure of proteins, e.g. Hb.
- d. Lysine is found in large quantities in histones, the basic protein associated with nucleic acids.
- e. Lysine is the precursor of **carnitine**. Synthesis of carnitine from protein bound lysine may be outlined as follows: Protein bound lysine + 3SAM → 3SAH + Protein bound Trimethyl lysine → Free Trimethyl lysine → (hydroxylase) → Hydroxy trimethyl lysine → (aldolase) → glycine + gamma butyryl betaine → (hydroxylase) → Carnitine.
- f. Bacterial putrefaction (decarboxylation) of lysine in the intestine gives rise to **cadaverine**.

## ■ ARGININE (ARG) (R)

1. Schulze and Steiger in 1886 isolated Arginine. Ackroyd and Hopkins showed its essentiality for growth in 1916. Arginine contains guanidinium group.
2. It is a highly basic, **semi-essential** amino acid. Arginine is **glucogenic**. The catabolic pathway of arginine is shown in Figure 17.5.



Ferid Murad  
NP 1998  
b. 1936



Robert Furchgott  
NP 1998  
1916–2009



Louis Ignarro  
NP 1998  
b. 1941



- In the urea cycle, where arginase splits arginine into urea and **ornithine** (see Fig. 15.12). Ornithine is then transaminated to glutamate semi-aldehyde and then to glutamate.
- Congenital deficiency of ornithine amino transferase causes elevated plasma and urinary ornithine; this leads to atrophy of the retina.
- Congenital deficiency of mitochondrial ornithine-citrulline antiporter leads to hyper-ornithinemia-hyperammonemia syndrome.
- Arginine reacts with glycine to form guanidoacetic acid which is methylated to **creatine** (see Fig.16.5).
- Arginine is the precursor of **nitric oxide** which is an important signal molecule in the body.

### Therapeutic Potential of Arginine

Arginine has important functions in cell division, wound healing, immune function and release of hormones in addition to its role in urea cycle. It is used in the treatment of erectile dysfunction, dentine hypersensitivity, abnormally high blood pressure (especially during high-risk pregnancies) as well as certain other conditions where vasodilation is required (since arginine is a precursor to nitric oxide). L-arginine is considered to be a sign of a healthy endothelium. However, some studies suggest that L-arginine can worsen lung inflammation and asthma. Other side effects of L-arginine are indigestion, nausea, headache, diarrhea, gout, blood abnormalities, allergies, ulcers. It should be used with caution in patients with diabetes mellitus, cardiac patients, pregnant and nursing women.

## NITRIC OXIDE (NO<sup>•</sup>)

It is a toxic pollutant of air and automobile exhausts. But now it is shown to possess more potential biological functions than any other known molecule. In 1977, Ferid Murad showed that the vasodilatory effect of nitroglycerine is due to the release of NO<sup>•</sup>. In 1980, Robert Furchgott showed that “endothelium derived relaxing factor” (EDRF) is required for arterial dilatation. In 1987, Louis Ignarro showed that EDRF is chemically NO<sup>•</sup>. They were awarded Nobel Prize in 1998.

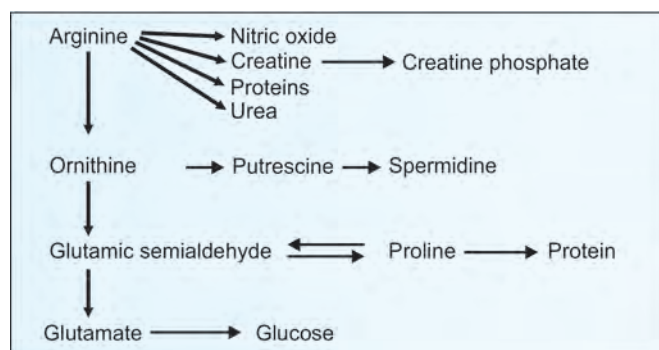


Fig. 17.5: Metabolism of arginine and ornithine

## Chemistry

Nitric oxide is an uncharged molecule having an unpaired electron, so it is a highly reactive “free radical”. So it is correctly written with a superscript dot (NO<sup>•</sup>) (see Chapter 33). Half-life is very short, only about 0.1 second.

## Synthesis of Nitric Oxide

Nitric oxide is formed from arginine by the enzyme **nitric oxide synthase (NOS)**. It contains heme, FAD, FMN and tetrahydrobiopterine. The enzyme utilizes NADPH and

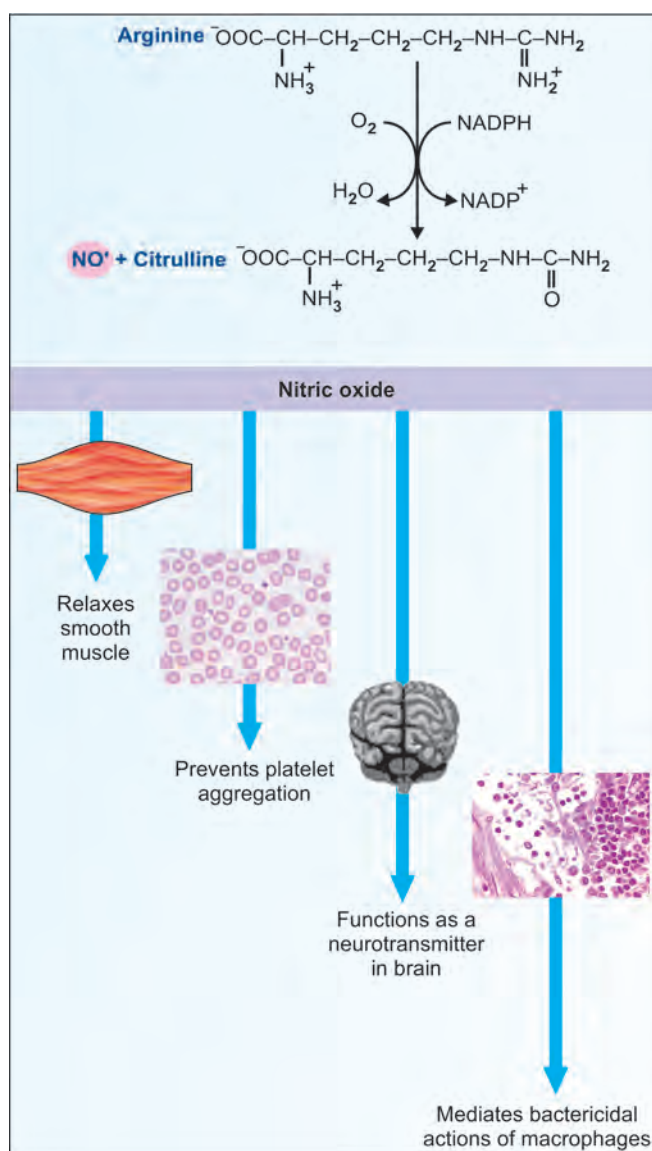


Fig. 17.6: Nitric oxide synthase (NOS) reaction. The enzyme contains heme, FAD, FMN and tetrahydro biopterine. It utilizes NADPH



molecular oxygen. Calmodulin is required to modulate its activity. The guanidino nitrogen of arginine is incorporated into NO<sup>•</sup>. From the molecular oxygen, one atom is added to NO<sup>•</sup> and the other into citrulline. Therefore, the enzyme is a di-oxygenase (Fig.17.6).

### Metabolic Fate

NO<sup>•</sup> combines with oxygen to form NO<sub>2</sub>. These **nitrites** are excreted through urine. Reacting with hemoglobin, NO<sup>•</sup> is converted to NO<sub>3</sub><sup>-</sup>; and **nitrates** are also excreted in urine. Very low quantity of NO<sup>•</sup> is expelled through lung. On exposure to superoxide anion (O<sub>2</sub><sup>-</sup>), nitric oxide (NO<sup>•</sup>) is converted to a highly reactive free radical, **peroxy nitrite** (OONO<sup>•</sup>), which causes lipid peroxidation, cell injury and cell death.

### Iso-enzymes of NOS

There are 3 isoforms of NOS, these are products of 3 different genes. All forms are seen in almost all tissues.

**Neuronal NOS:** NOS-1 or nNOS or neuronal NOS is seen in central and peripheral neurons. Nitrogenic neurons are seen especially in cerebellum and gastrointestinal tract. It is mainly a cytoplasmic enzyme. It is activated by calcium. The gene for neuronal NOS is seen on chromosome 12.

**Macrophage NOS:** NOS-2 or iNOS or inducible NOS or macrophage NOS is mainly seen in macrophages and neutrophils; but is also present in hepatocytes. It is induced by cytokines (interleukin-1 and tumor necrosis factor) and during inflammation. It is a cytoplasmic enzyme. Calcium does not activate this iso-enzyme. Gene for iNOS is on chromosome 17.

**Endothelial NOS:** NOS-3 or eNOS or endothelial NOS is seen in endothelial cells, platelets, endocardium and myocardium. In these sites, the NO<sup>•</sup> is constantly produced and released, so as to have arterial relaxation. It is localized in the plasma membrane. It is activated by calcium. The gene for endothelial NOS is on chromosome 7.

### Mechanism of Action of Nitric Oxide

NO diffuses to the adjacent smooth muscle and activates **guanylate cyclase**. Increased level of **cyclic GMP** activates protein kinase in smooth muscles, which causes dephosphorylation of myosin light chains, leading to relaxation of muscles. Thus NO is a **vasodilator**.

### Physiological Actions of Nitric Oxide

1. **Blood vessels:** NO<sup>•</sup> is a potent vasodilator. The normal blood pressure is maintained by the NO<sup>•</sup> liberated by endothelial NOS (NOS<sub>e</sub>). NO<sup>•</sup> causes cerebral, coronary, renal and muscle arteries to dilate. A deficiency of NO<sup>•</sup> is associated with hypertension. Excessive production of NO<sup>•</sup> results in refractory hypotension, which may be seen in patients with septicemic shock.

2. **Central nervous system:** In CNS, NOS<sub>n</sub> isoform is present. Glutamate acts on N-methyl-D-aspartate (NMDA) receptors to cause a long-standing calcium influx. This activates NOS<sub>n</sub>. NO<sup>•</sup> stimulates the releasing hormones (CRH, GHRH and LHRH).
3. **Macrophages:** Macrophages contain the isoform NOS<sub>i</sub> (i stands for inducible). This enzyme produces NO<sup>•</sup> and peroxy nitrite; which are lethal to **micro-organisms**. NO<sup>•</sup> production in macrophage is induced by interleukin and tumor necrosis factor.
4. **Platelets:** NO<sup>•</sup> inhibits adhesion of platelets and so depresses platelet functions.
5. **Intestinal system:** NO<sup>•</sup> is a non-adrenergic and non-cholinergic (NANC) neurotransmitter, especially in gastrointestinal tract and urogenital tract. It relaxes smooth muscles and leads to reduced gastrointestinal motility and relaxation of sphincters. A deficiency of NO producing neurons with decreased motility is responsible for infantile hypertrophic pyloric stenosis and Hirschsprung's disease.

### Nitric Oxide in Diseases and Treatment

1. **Angina pectoris:** Nitroprusside can directly release NO<sup>•</sup>. Nitroglycerin (glyceryl trinitrite) requires glutathione to produce NO<sup>•</sup>. These will dilate coronary arteries; and are beneficial in treating angina pectoris.
2. **Pulmonary hypertension:** Inhalation of NO<sup>•</sup> is useful in the treatment of pulmonary hypertension and high altitude pulmonary edema. NO<sup>•</sup> produces pulmonary vasodilatation, without lowering systemic blood pressure.
3. **Impotence:** NO<sup>•</sup> relaxes smooth muscles in the corpus cavernosum and increases blood flow into the penis and makes it erect. **Sildenafil citrate** (Viagra) selectively inhibits the specific phosphodiesterase type 5 (PDE-5); thus inhibiting hydrolysis of cGMP; and increasing the concentration of cGMP in corpus cavernosum.
4. **Shock:** Induction of NOS from macrophages is increased in sepsis and is responsible for severe vasodilation and shock. This hypotension is refractory and not responding to vasoconstrictor drugs.
5. **Enhancers of NO<sup>•</sup> activity:** S-nitro-glutathione (**GS-NO**) is a NO<sup>•</sup> donor which inhibits platelet agglutination. N-acetyl cysteine (NAC) is a glutathione precursor; it protects NO<sup>•</sup> from being metabolized by free radical scavengers, and hence enhances NO<sup>•</sup> activity.
6. **Antagonists of nitric oxide:** Development of specific inhibitors of different isoforms of NOS promises therapeutic uses.

N-monomethyl arginine (NMMA) competitively inhibits NOS. ADMA (asymmetric dimethyl-arginine), an endogenous arginine analogue acts as an NOS inhibitor; ADMA is seen to be increased in hyper-homocysteinemia and pre-eclampsia. In eclampsia, the hypertension is due to the lowered production of NO.

## POLYAMINES

Polyamines are **putrescine, spermidine and spermine**. They are aliphatic amines. Humans synthesize about 0.5 mmol of spermine per day. They are synthesized from **Ornithine**.

Details of synthesis are given in Figure 17.7. Key enzyme of polyamine synthesis is **ornithine decarboxylase (ODC)** (step 4). It requires pyridoxal phosphate, and is induced by steroid hormones. ODC gene is on chromosome no.2. The genes for the enzyme SAM decarboxylase (step 2) are on chromosomes 6 and X. This enzyme has **pyruvate** (not PLP) as the prosthetic group; it is the only mammalian example; known to contain bound pyruvate.

**DFMO** (difluoromethyl ornithine) is a powerful inhibitor of polyamine synthesis. It is an example of **suicide inhibition** (see Chapter 5). African sleeping sickness and Indian Kala-azar are produced by parasites, trypanosomes. In these parasites, the half-life of ODC is many hours. DFMO inhibits polyamine synthesis, so parasites cannot divide, and the immune system of the host can kill them. The half-life of ODC in man is only 5 minutes. So, enzyme molecules are constantly synthesized, and hence the drug will not affect human beings. DFMO is also useful against pneumocystis carinii parasite infection, which is common in AIDS.

## Biochemical Functions of Polyamines

Polyamines are required for protein biosynthesis. The translation initiation factor eIF-4D contains one **hypusine residue**, which is formed by addition of butylamine moiety from spermidine to lysine. IF-4D is the only known protein containing hypusine.

Several roles are suggested for polyamines, e.g. cell proliferation, stabilization of ribosomes and DNA, synthesis of DNA and RNA, protection of DNA against depurination, etc. Polyamine concentration is increased in **cancer** tissues. Polyamines are **growth factors** in cell culture systems. Methylthioadenosine (MTA) (step 3) has growth inhibitory activity.

TABLE 17.1: Biogenic amines

Substrate	Decarboxylated product, amine	Chapter No.
Serine	Ethanol amine → Choline	16
Tyrosine	Tyramine	18
DOPA	Dopamine	18
Tryptophan	Tryptamine	18
5-OH-tryptophan	Serotonin	18
Histidine	Histamine	18
Ornithine	Putrescine	17
Lysine	Cadaverine	17
Cysteine	Taurine	16

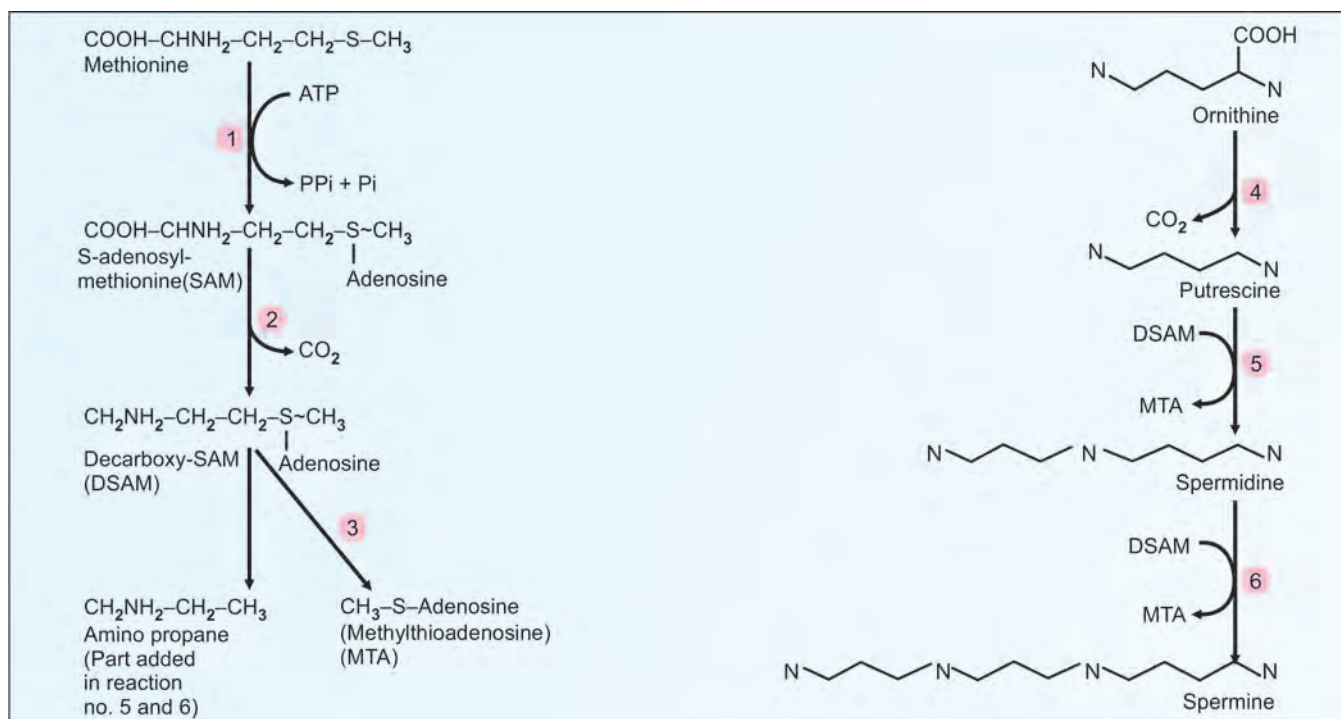


Fig. 17.7: Polyamine synthesis; 1= methionine adenosyl transferase; 2= SAM decarboxylase; 3= reaction coupled with 5 and 6; 4= Ornithine decarboxylase; 5= Spermidine synthase; 6= Spermine synthase. SAM= S-adenosyl methionine; DSAM= decarboxy-SAM; MTA= methyl thio adenosine

Decarboxylation of lysine produces **cadaverine**, which is also seen in mammalian tissues. It is also sometimes included in the list of polyamines.

### Biogenic Amines

They are generally synthesized by decarboxylation of amino acids. A list of biogenic amines are shown in Table 17.1. They are basic in nature. They have diverse biological functions, which are described in appropriate chapters.

## BRANCHED CHAIN AMINO ACIDS (BCA)

Leucine was discovered from cheese by Proust in 1818. Ehrlich isolated isoleucine in 1903 and Emil Fischer isolated valine in 1906.

Valine (Val) (V) is glucogenic; Leucine (Leu) (L) is ketogenic while Isoleucine (Ile) (I) is both ketogenic and glucogenic. All the three are **essential** amino acids. Leucine is the major ketogenic amino acid. These amino acids serve as an alternate source of **fuel for the brain** especially under conditions of starvation.

All the three amino acids undergo similar sequence of reactions. These are summarized in Table 17.2. In this pathway, the second enzyme is **branched chain alpha keto acid dehydrogenase**. It is a complex of decarboxylase, transacylase and dihydrolipoyl dehydrogenase. So, this resembles pyruvate dehydrogenase (see Fig. 9.22).

### Maple Syrup Urine Disease (MSUD)

- i. It is also called branched chain ketonuria. The incidence is 1 per 1 lakh births. The name originates

from the characteristic smell of urine (similar to burnt sugar or maple sugar) due to excretion of branched chain keto acids.

- ii. The basic biochemical defect is **deficient decarboxylation** of branched chain keto acids (BKA) (reaction 2 in Table 17.2 and Fig. 17.8).
- iii. **Clinical findings:** Disease starts in the first week of life. It is characterized by convulsions, **severe mental retardation**, vomiting, acidosis, coma and death within the first year of life.
- iii. **Laboratory findings:** Urine contains **branched chain keto acids**, valine, leucine and isoleucine. Rothera's test is positive, but unlike in cases of ketoacidosis, even boiled and cooled urine will give the test. Diagnosis depends on enzyme analysis in cells. Diagnosis should be done prior to 1 week after birth.
- iv. **Treatment:** Giving a diet low in branched chain amino acids. Mild variant is called **intermittent** branched chain ketonuria. This will respond to high doses of thiamine. This is because the decarboxylation of the BKA requires **thiamine**. Liver transplantation has been successfully tried in some cases of MSUD.

### Isovaleric Aciduria

Here leucine catabolism is affected. Severe metabolic acidosis and neurological deficit are seen. It is often fatal in early childhood. The characteristic offensive odor of urine is the first sign of the abnormal excretion of this metabolite. Very high amounts of abnormal metabolites are excreted in urine. The defect lies in reaction No. 3 of Table 17.2.

**TABLE 17.2:** Catabolism of branched chain amino acids

No.	Reaction and co-enzymes	Valine	Leucine	Isoleucine
1.	Transamination to produce branched chain $\alpha$ -keto acid	Alpha keto isovaleric acid	Alpha keto isocaproic acid	Alpha keto beta methyl valeric acid
2.	Oxidative decarboxylation with the help of CoA, NAD <sup>+</sup> and branched chain alpha keto acid dehydrogenase (lacking in maple syrup urine disease)	Iso butyryl CoA	Isovaleryl CoA	Alpha methyl butyryl CoA
3.	FAD dependent dehydrogenation	Methyl acrylyl CoA	$\beta$ -methyl crotonyl CoA	Tiglyl CoA
4.	Individual reactions	+ H <sub>2</sub> O; remove CoA to form beta-hydroxy isobutyrate	+ CO <sub>2</sub> with the help of biotin to form beta methyl glutaconyl CoA	+ H <sub>2</sub> O to form alpha methyl beta hydroxy butyryl CoA
5.	Individual reactions	NAD dependent dehydrogenase; to form Methyl malonyl CoA	Hydrolysis; beta hydroxy beta methyl glutarylCoA(HMG CoA)	NAD dependent dehydrogenation; alpha methyl acetoacetylCoA
6.	End - products	B12-Coenzyme to form succinyl CoA	HMG CoA lyase to form acetoacetate and acetyl CoA	Cleavage to form acetyl CoA and propionyl CoA

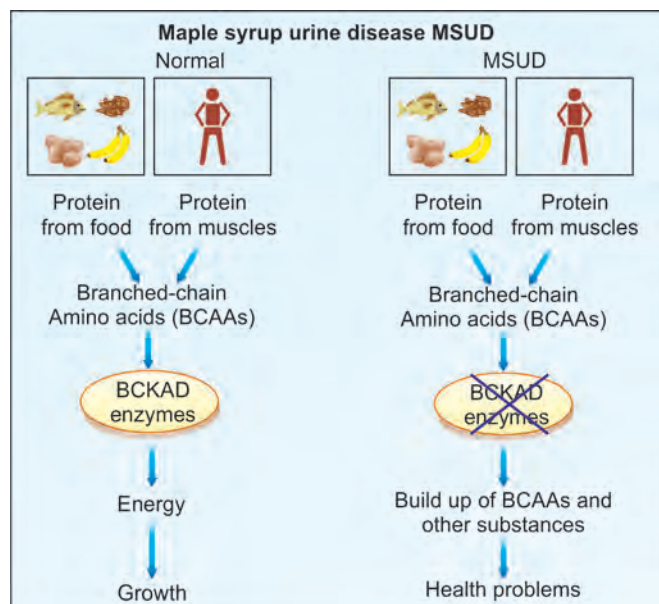


Fig.17.8: Pathology of maple syrup urine disease

### Clinical Case Study 17.1

Patient 1 presented at 3 months of age with excessive irritability, abnormal posturing since birth and delayed developmental milestones. There is history of sibling death at Day 15 of life. The clinician reported abnormal urine odor. Laboratory analysis revealed ketonuria and metabolic acidosis. HPLC analysis of amino acid showed elevated leucine, isoleucine and valine. Child died immediately afterwards.

Patient 2 presented at Day 12 with metabolic acidosis, abnormal urine odor, ketonuria and hepatosplenomegaly.

Blood and urine studies revealed elevated levels of valine, isoleucine and leucine. Aggressive treatment was started including branched chain amino acid restricted diet and supplementation. Patient has survived until 3 years of age, without any episode of exacerbation afterwards. Levels of leucine, isoleucine and valine came down to normal level.

What is the diagnosis? What is the significant difference between the two patients?

### Clinical Case Study 17.1 Answer

The diagnosis is maple syrup urine disease. In the case of the first patient (Patient 1), diagnosis was delayed and hence treatment could not be instituted and the baby died. But in the second case (Patient 2) diagnosis and treatment was started early in life and outcome was better. These two case studies indicate the importance of early diagnosis and treatment in MSUD.

### QUICK LOOK OF CHAPTER 17

1. Arginine is the precursor of Nitric oxide ( $\text{NO}^\cdot$ ) by the action of NO synthase.
2.  $\text{NO}^\cdot$  synthase has three isoforms; neuronal, inducible and endothelial.
3.  $\text{NO}^\cdot$  is a potent vasodilator and participates in macrophage mediated antimicrobial activity.  $\text{NO}^\cdot$  is used in treatment of pulmonary hypertension and erectile dysfunction.



# CHAPTER 18

## Aromatic Amino Acids (Phenylalanine, Tyrosine, Tryptophan, Histidine, Proline) and Amino Acidurias

### Chapter at a Glance

The reader will be able to answer questions on the following topics:

- Phenylalanine
- Tyrosine
- Melanin
- Catecholamines, synthesis and metabolism
- Phenyl ketonuria, alkaptonuria, albinism
- Tryptophan
- NAD<sup>+</sup> synthesis
- Serotonin, melatonin
- Histidine, histamine, proline, hydroxyproline
- Amino acidurias

### PHENYLALANINE (PHE) (F)

Phenylalanine is an **essential**, aromatic amino acid. The need for phenylalanine becomes minimal, if adequate tyrosine is supplied in the food. This is called the **sparing action** of tyrosine on phenylalanine. It is **partly glucogenic and partly ketogenic**. Phenylalanine was isolated by Schulze in 1879 and Tyrosine by Liebig in 1846. In 1913, Abderhalden showed the essentiality of phenylalanine.

#### Step 1: Phenylalanine to Tyrosine

The reaction involves addition of a hydroxyl group to the aromatic ring, by **phenylalanine hydroxylase** (step 1, Fig.18.1). It needs NADPH, NADH and tetrahydrobiopterin as co-enzymes. As this is an irreversible reaction, tyrosine cannot replenish phenylalanine. Hence, phenylalanine is essential in food.

It is a mixed function oxidase (**mono-oxygenase**). One molecule of O<sub>2</sub> is needed in this reaction; out of which one atom is incorporated in the OH group and the other is reduced to water. This reaction also needs

the electron carrier **tetrahydrobiopterin**, which is regenerated by the reduction of dihydrobiopterin by a reductase using **NADPH** (step 1A, Fig. 18.1).

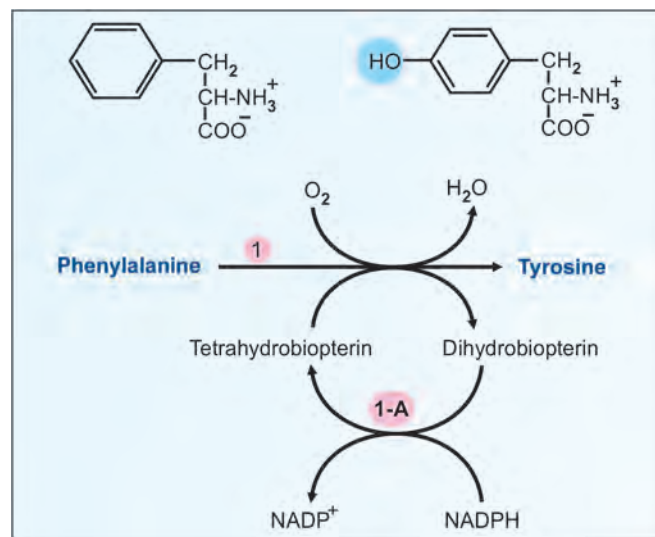


Fig. 18.1: Phenylalanine catabolism; 1 = Phenylalanine hydroxylase; 1-A = NADPH dependent reductase

## TYROSINE (TYR) (T)

Tyrosine is an aromatic amino acid. It is synthesized from phenylalanine, and so is a non-essential amino acid. The need for phenylalanine becomes minimal, if adequate tyrosine is supplied in the food. This is called the **sparing action** of tyrosine on the phenylalanine. Tyrosine is **partly glucogenic and partly ketogenic**.

### Catabolism of Tyrosine (and Phenylalanine)

#### Step 2: Transamination

Degradative pathway of phenylalanine and tyrosine are the same, since phenylalanine is converted to tyrosine and then metabolized. Tyrosine is transaminated to give para-hydroxyphenylpyruvic acid by **tyrosine transaminase** (step 2, Fig.18.2). It is **pyridoxal phosphate** dependent. It is induced by glucocorticoids.

#### Step 3: Production of Homogentisic acid

The next step (No. 3, Fig. 18.2) is catalyzed by para-hydroxyphenylpyruvate **hydroxylase**. It is a di-oxygenase, which means that both oxygen atoms are incorporated into the product. It is a **copper** containing enzyme. Interestingly, the reaction involves shifting of the side chain from para position to meta position. A new OH group is freshly added to the para position to give rise to 2,5-dihydroxyphenyl acetic acid or **homogentisic acid**. **Ascorbic acid** is helpful in this reaction.

#### Step 4: Cleavage of Aromatic Ring

Homogentisic acid **oxidase** opens the ring (step 4, Fig.18.2). It is also a di-oxygenase with an **iron atom** at the active site. The product is 4- maleyl acetoacetate.

#### Step 5: Isomerization

It then undergoes cis to trans isomerization to form fumaryl acetoacetate by an **isomerase** (step 5, Fig.18.2). The isomerase requires **glutathione** (GSH) as a cofactor.

#### Step 6: Hydrwolysis

Fumaryl acetoacetate is then hydrolyzed to fumarate and acetoacetate by a **hydrolase** (step 6, Fig.18.2). This results in the production of a glucogenic product (**fumarate**) and a ketone body (**acetoacetate**). Hence, phenylalanine and tyrosine are **partly glucogenic and partly ketogenic**.

### Important Specialized Products from Tyrosine

1. Melanin
2. Catecholamines (epinephrine)
3. Thyroxine

#### Synthesis of Melanin

Melanin pigment gives the black color to the skin and hair (Greek word Melan means black). There is only one enzyme

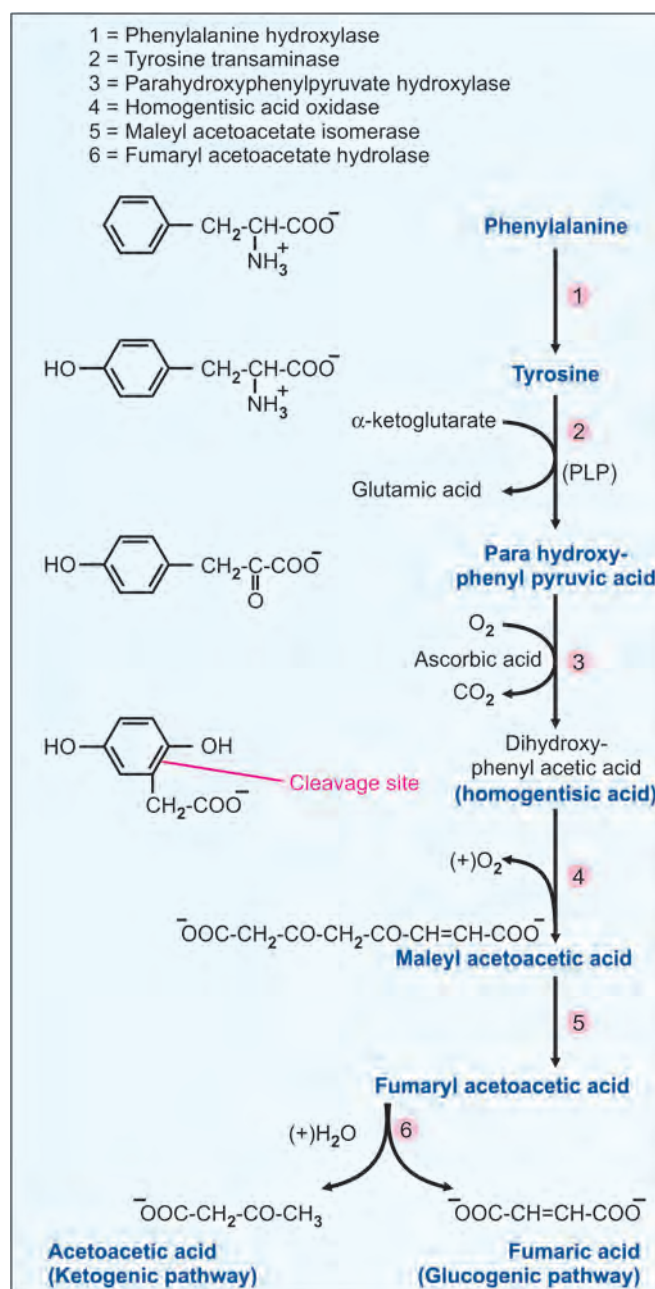


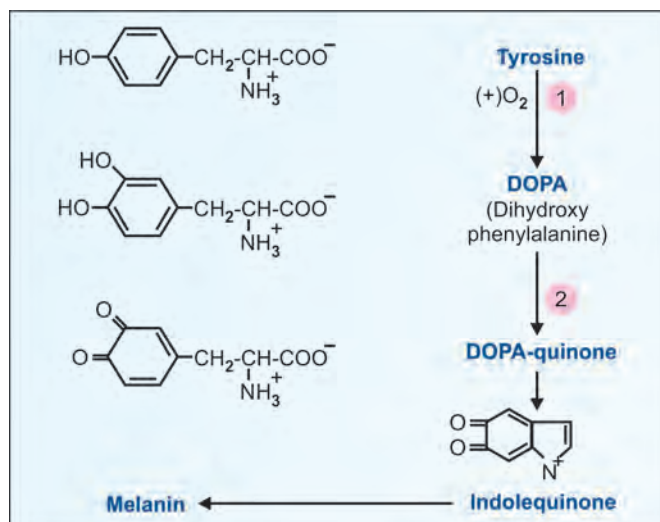
Fig. 18.2: Catabolism of phenylalanine and tyrosine

involved, which catalyzes the first two steps. The remaining reactions are non-enzymatic and occur spontaneously.

- i. **Formation of DOPA:** The first step is the hydroxylation of tyrosine by **tyrosinase**. It is a mono-oxygenase containing **copper** (step 1, Fig. 18.3). Molecular  $O_2$  is used for the reaction, of which one atom is incorporated in the product, to form dihydroxyphenyl alanine or DOPA (Box 18.1).
- ii. **Formation of DOPA quinone:** Tyrosinase again acts on DOPA to form dopaquinone (step 2, Fig. 18.3).
- iii. **Formation of indolequinone:** It is converted to indolequinone through a series of reactions involving decarboxylation and oxidation of the side chain. The indolequinone is polymerized to form melanin. Melanin is a group of polymers of random structure formed from indolequinone. Melanin when reduced changes from black to a tan color.

## Regulation of Color of Skin

Melanocytes in the deeper layers of epidermis synthesize melanin in granular form in melanosomes. The color of



**Fig. 18.3:** Melanin synthesis pathway; 1 and 2 steps have the same enzyme, tyrosinase

### Box 18.1: Tyrosinase and tyrosine hydroxylase

Both these enzymes will add hydroxyl group to tyrosine to produce dihydroxyphenylalanine (**DOPA**).

**Tyrosinase** is present in melanoblasts. The enzyme produces DOPA, which is used for melanin synthesis.

Tyrosine hydroxylase is present in adrenal medulla and the DOPA thus generated is used for catecholamine synthesis. Thus even in tyrosinase deficient person (albinism) synthesis of the catecholamines is normal.

the skin depends upon the distribution of melanoblasts, the concentration of melanin and its state of oxidation. The extracellular granules are later dispersed under the influence of melanocyte stimulating hormone (MSH). Alpha MSH has 13 amino acids, which constitute the amino terminal part of ACTH. Therefore, MSH has weak ACTH activity and ACTH has weak MSH activity. Melanin pigment is found in retina and ciliary body, which gives the characteristic color of the eye.

## Synthesis of Catecholamines

Catecholamines are derived from tyrosine. They are so named because of the presence of catechol nucleus. They include epinephrine, nor-epinephrine and dopamine. They are produced by the adrenal medulla and sympathetic ganglia.

- i. **Tyrosine hydroxylase:** Tyrosine is first hydroxylated to dihydroxyphenylalanine (**DOPA**) by tyrosine

### Box 18.2: Clinical applications of melanin

- i. **Copper deficiency:** Since tyrosinase is a copper containing enzyme, there may be disturbances in pigmentation during copper deficiency. Hair synthesized at the time of deficiency may be depigmented. If copper deficiency is intermittent, alternate black and white regions may be seen in the hair (flag-type of hair).
- ii. **Malignant melanoma:** Melanoblasts, especially in junctional nevi, may multiply to give rise to malignant melanoma. Melanogen may be excreted through urine in such conditions. Such urine if kept in a test tube, the upper part of the tube becomes black due to oxidation to melanin.
- iii. **Leukoderma:** When tyrosinase or melanin forming cells or both are absent from epidermis, leukoderma (white patches) results.
- iv. **Graying** of hair is also due to the disappearance of melanocytes from the hair root.
- iv. **Albinism:** Albinism and leukoderma are different. In albinism, tyrosinase is absent in melanocytes all over the body. See later in this chapter.



Arvid  
Carlsson  
NP 2000  
b.1923



Paul  
Greengard  
NP 2000  
b.1925



Eric R  
Kandel  
NP 2000  
b.1929



Ulf von  
Euler  
NP 1970  
1905–1983

hydroxylase (step 1, Fig.18.4). It is different from tyrosinase involved in melanin synthesis which catalyzes a similar reaction (Fig. 18.3 and Box 18.1). The tyrosine hydroxylase requires tetrahydrobiopterine and NADPH (similar to phenylalanine hydroxylase).

- ii. **DOPA-decarboxylase:** DOPA is decarboxylated to form **Dopamine** by DOPA-decarboxylase, a pyridoxal phosphate dependent enzyme (step 2, Fig.18.4). It is a catecholamine.

Dopamine is an inhibitor of **prolactin** secretion. It is also an important neurotransmitter especially in extra-pyramidal tract, substantia nigra and striatal tract.

In **Parkinsonism**, the dopamine content in brain is reduced. As dopamine will not enter into the brain cells,

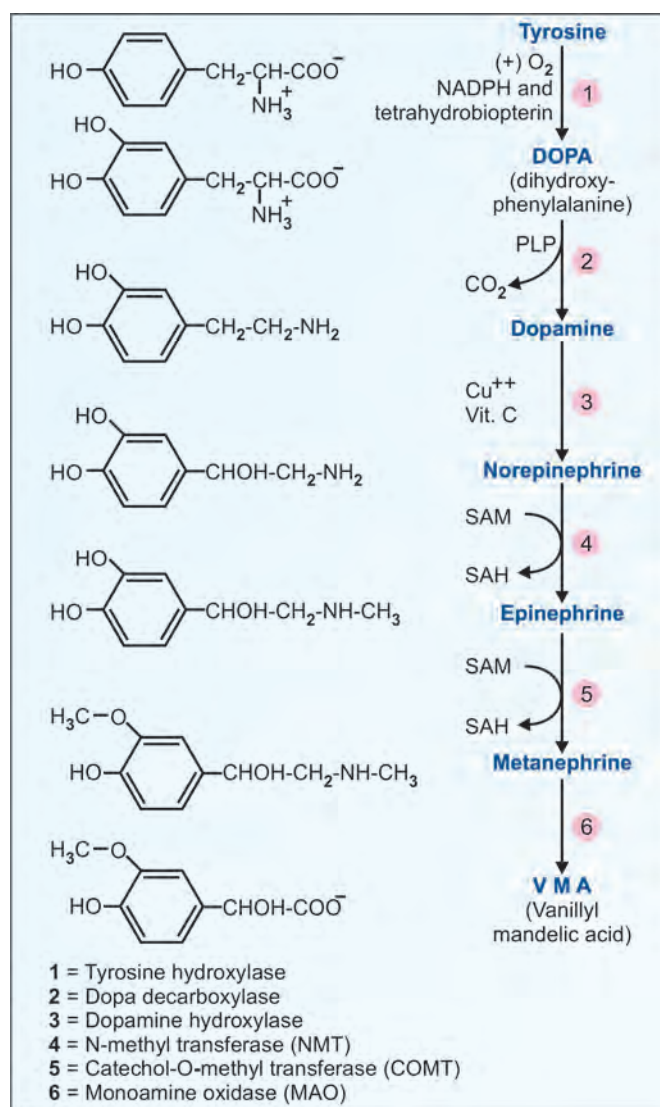


Fig. 18.4: Metabolism of catecholamines

the precursor, L-Dopa is used as a drug in Parkinsonism.

**Alpha methyl dopa** will inhibit dopa decarboxylase and prevent production of epinephrine; so it is an antihypertensive drug.

Arvid Carlsson established dopamine as a neurotransmitter and developed L-dopa as a drug for the treatment of Parkinson's disease. Paul Greengard demonstrated that Dopamine-AMP-Regulated-Phospho-protein (DARPP32) is necessary for the phosphorylation cascade, leading to neuronal excitability. Eric Kandel showed that the DARPP32 dependent phosphorylation is the basis of short-term and long-term memory. All the three scientists were awarded Nobel Prize in 2000. Norepinephrine was identified as a neurotransmitter in 1946 by Ulf von Euler, who was awarded Nobel prize in 1970.

- iii. **Norepinephrine:** Dopamine is further hydroxylated to norepinephrine or noradrenaline (step 3, Fig.18.4). The term "nor" denotes that the molecule does not contain the "R" or methyl group.
- iv. **Epinephrine:** In the next step, norepinephrine is methylated by the enzyme **N-methyl transferase** (NMT) to epinephrine or adrenaline (step 4, Fig. 18.4). S-adenosyl methionine (SAM) is the methyl donor. It is mainly produced by adrenal medulla and adrenergic nerve endings. It is stored in chromaffin granules and released into blood. Epinephrine and Adrenaline are the two names for the same hormone (Box 18.3).

## Actions of Epinephrine

- i. Epinephrine and norepinephrine increase the blood pressure.

### Box 18.3: Two names

Epinephrine and adrenaline are two names for the same hormone. John Jacob Abel discovered "epinephrine" in 1901. In the same year, Japanese-born chemist Jokichi Takamine, working independently, isolated the same hormone, which he called "adrenalin." It was first marketed as Adrenaline for therapeutic use. Hence the word adrenaline is more used in clinical practice, while the term epinephrine is more favored in academic circles.



John Jacob Abel  
1857–1938



Jokichi Takamine  
1854–1922



Sir Archibald Garrod  
1857–1936



Julius Axelrod  
NP 1970  
1912–2004



- ii. Adrenaline also increases the rate and force of myocardial contraction.
- iii. Epinephrine causes relaxation of smooth muscles of bronchi.
- iv. Adrenaline is anti-insulin in nature, it increases glycogenolysis and stimulates lipolysis.
- v. Adrenaline is released from adrenal medulla in response to flight, fight, fright, exercise and hypoglycemia.

### Degradation of Adrenaline

- i. The half-life of epinephrine is very short, only 2–5 minutes. Epinephrine is catabolized in tissues, by **catechol-O-methyl transferase (COMT)** (step 5, Fig.18.4) to metanephrine.
- ii. It is then acted upon by **monoamine oxidase (MAO)** (step 6). MAO will oxidatively deaminate compounds having the amino group attached to the terminal carbon atom. The major end product is 3-hydroxy-4-methoxy mandelic acid or **vanillyl mandelic acid (VMA)**.
- iii. Normal level of excretion of VMA is 2–6 mg/24 h. It is increased in **pheochromocytoma** (epinephrine excess) and in **neuroblastoma** (norepinephrine excess).
- iv. **VMA estimation:** Patient is asked to refrain from intake of chocolate, coffee, banana, vanilla ice-creams, citrus fruits (lime and orange). These items contain vanillin, which produces very high values of VMA in urine. Patient should not take aspirin and other drugs containing phenol ring. 24-hour-urine is collected. This is because urinary excretion of VMA is not continuous. From urine, VMA is extracted by ethyl acetate. It is oxidized with metaperiodate to convert VMA to vanillin. This extracted with toluene. The color is read at 360 nm. Nowadays, VMA is also estimated by antibody method.

### Synthesis of Thyroid Hormones

Tyrosine residues are iodinated to form 3-mono-iodo-tyrosine (MIT) and 3,5-di-iodo-tyrosine (DIT). These are coupled to give rise to 3,5,3'-tri-iodo-thyronine (T3) and 3,5,3',5'-tetra-iodo-thyronine or thyroxine (T4). (see Chapter 47).

### Tyramine

Tyrosine is decarboxylated to tyramine by intestinal bacteria. Tyramine is present in chocolate, cocoa, wine, dried fish, processed meat, buttermilk, cheese, yeast, beans, peas, papaya and peanut. These may precipitate an attack of **migraine** in susceptible individuals.

## PHENYLKETONURIA (PKU)

1. Deficiency of **phenylalanine hydroxylase** (Fig.18.1) is the cause for this disease. The genetic mutation may

be such that either the enzyme is not synthesized, or a non-functional enzyme is synthesized.

2. It is a recessive condition. Frequency of PKU was considered to be 1 in 10,000 births; but recent introduction of better diagnostic facilities showed that the incidence is as high as 1 in 1,500 births (WHO, 2003). Incidence of PKU in India is lesser than western countries; only 1 in 25,000 births.
3. There are 5 types of PKU described. Type I is the classical one, described below. It is due to phenylalanine hydroxylase deficiency. Types II and III are due to deficiency of dihydrobiopterin reductase. Type IV and V are due to the deficiency of the enzyme synthesizing biopterin. Since tetrahydrobiopterin is the co-enzyme required for serotonin and dopamine, the decreased level of these neurotransmitters may also result in the neurological symptoms. Phenylalanine hydroxylase gene is located in chromosome no.12; and dihydrobiopterin reductase gene in chromosome no.4.

### Biochemical Abnormalities

- A. Phenylalanine cannot be converted to tyrosine. So, phenylalanine accumulates. Phenylalanine level in blood is elevated.
- B. So alternate minor pathways are opened (Fig.18.5A). Phenylketone (**phenylpyruvate**), phenyllactate and phenylacetate are excreted in urine.

### Clinical Manifestations

- A. The classical PKU child is **mentally retarded** with an IQ of 50. About 20% inmates of lunatic asylum may have PKU.
- B. Agitation, hyperactivity, tremors and **convulsions** are often manifested. This may be because phenylalanine interferes with neurotransmitter synthesis.
- C. The child often has **hypopigmentation**, explained by the inhibition of tyrosinase.

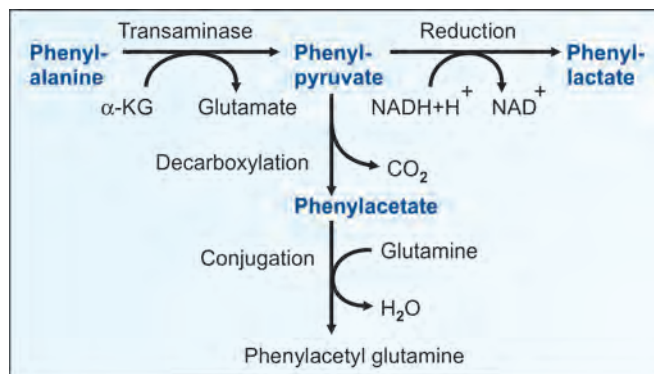


Fig. 18.5A: Alternate pathways in phenylketonuria

- D. Phenyllactic acid in sweat may lead to mousy body odor.

## Laboratory Diagnosis

- A. **Blood phenylalanine:** Normal level is 1 mg/dL. In PKU, the level is >20 mg/dL. This may be demonstrated by chromatography. **Tandem mass spectroscopy** is the most reliable test; but is costly.
- B. **Guthrie test** is a rapid screening test. See Box 18.4 and Figure 18.5B.
- C. **Ferric chloride test:** Urine of the patient contains phenylketones about 500–3000 mg/day. This could be detected by adding a drop of ferric chloride to the urine. A transient blue-green color is a positive test. But this is a less reliable test.
- D. **DNA probes** are now available to diagnose the defects in phenylalanine hydroxylase and dihydrobiopterin reductase.

## Treatment

- A. **Early detection** is very important. About 5 units of IQ are lost for each 10-week delay in starting the treatment.
- B. The treatment is to provide a diet containing **low phenylalanine** (10–20 mg/kg body weight per day).

### Box 18.4: Tests for phenylketonuria

Guthrie test was developed in 1961 by Robert Guthrie (1916–1995). It is a rapid screening test. Certain strains of *Bacillus subtilis* need phenylalanine as an essential growth factor. Bacteria cannot grow in a medium devoid of phenylalanine. Bacterial growth is proportional to the phenylalanine content in the patient's blood.

Guthrie was the father of a mentally challenged child and had a niece with PKU. He developed a rapid diagnostic screening test for PKU.

Earlier in 1934, Asbjorn Folling, a Norwegian biochemist introduced the use of ferric chloride test in urine of a mentally retarded child with decreased skin pigmentation and mousy odor of urine.

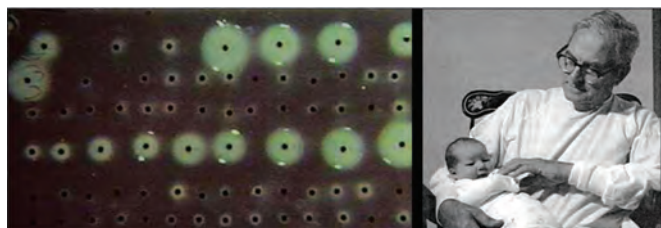


Fig. 18.5B: Guthrie test. Robert Guthrie is shown in right side

Food based on tapioca (cassava) will have low phenylalanine content.

- C. This special diet is to be continued during the first decade of life; after which the child can have a normal diet. Life long compliance of special diet is advised, though not mandatory.
- D. Female child, on growing to adulthood may become pregnant. Then again special diet is to be given, because the increased phenylalanine level will affect the brain development of the fetus.

## Phenyl Ketonuria Carrier State

The PKU is recessive; the disease is manifested only in homozygous state. In heterozygous (carrier) state, the phenylalanine hydroxylase enzyme is sufficient to metabolize normal levels of phenylalanine. But when phenylalanine (4 g) is injected intravenously, the carriers will show increased level in the blood (**phenylalanine load test**).

Phenylalanine levels are very high in blood and they are excreted as phenylketones in urine. Maternal hyperphenylalaninemia is seen in women who do not have proper phenylalanine level control during pregnancy. Infants born to such mothers can have a variety of disorders including cardiac defects; death may occur in utero.

## ALKAPTONURIA

The term alkaptonuria arises from the Arabic word alkapton for 'alkali' and Greek word 'to suck up oxygen greedily in alkali'. This is based on the observation that the **urine becomes black** on standing when it becomes alkaline. Sir Archibald Garrod in 1902 reported that patients complain that their underwears are getting blackened. Garrod concluded that the disease is inherited and it is due to the deficiency of the enzyme required for further metabolism of homogentisic acid. Alkaptonuria and albinism are two inborn errors included in **Garrod's tetrad**; the other two being pentosuria and cystinuria. Garrod introduced the term "**inborn errors of metabolism**" in 1908. The condition had been vividly described by Zactus Luxtanus in 1649. Egyptian mummies dating back 2000 BC had pigmented cartilages due to alkaptonuria.

## Biochemical Defect

1. Alkaptonuria is an autosomal **recessive** condition with an incidence of 1 in 250,000 births.
2. The metabolic defect is the deficiency of **homogentisate oxidase** (step 3, Fig. 18.2 and item 3,

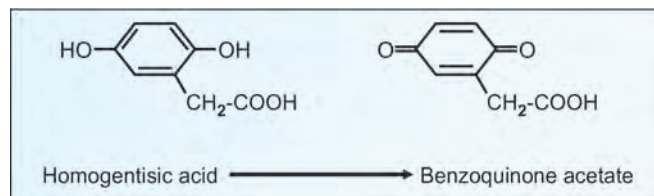


Fig. 18.6A: Oxidation of homogentisic acid

Fig.18.7). This results in excretion of **homogentisic acid** in urine.

- It is compatible with fairly normal life. The only abnormality is the **blackening of urine** on standing. The homogentisic acid is oxidized by polyphenol oxidase to **benzoquinone acetate** (Fig.18.6A). It is then polymerized to black colored **alkaptonone bodies**.
- By the 3rd or 4th decade of life, patient may develop **ochronosis** (deposition of alkaptonone bodies in intervertebral discs, cartilages of nose, pinna of ear) (Fig.18.6B). Black pigments are deposited over the connective tissues including joint cavities to produce arthritis.
- No specific treatment is required. But minimal protein intake with phenylalanine less than 500 mg/day is recommended.

### Diagnosis of Alkaptonuria

- Urine becomes black on standing** when it becomes alkaline. Blackening is accelerated on exposure to sunlight and oxygen. The urine when kept in a test tube will start to blacken from the top layer (Fig.18.6B).
- Ferric chloride test** will be positive for urine.
- Benedict's test** is strongly positive. Therefore, alkaptonuria comes under the differential diagnosis of reducing substances in urine (see Chapter 24).

Alkaptonuria is a more common condition in India. Even though it is not life-threatening, patients can have severe arthritis later in life. Diagnosis is suggested by blackish discoloration of urine, a positive Benedict's test, silver nitrate reduction and detection of elevated homogentisic acid

by GC/MS (Gas Chromatography/Mass Spectrometry). Treatment with pHPPA oxidase inhibitors have been tried.

### ALBINISM

- The Greek word, albino means white. Albinism is an autosomal recessive disease with an incidence of 1 in 20,000 population (Fig.18.7).
- Tyrosinase** is completely absent, leading to defective synthesis of melanin.
- The ocular fundus is hypopigmented and iris may be gray or red. There will be associated **photophobia**, **nystagmus** and decreased visual acuity.
- The skin has low pigmentation, and so skin is sensitive to UV rays. The skin may show presence of nevi and **melanomas**. Hair is also white.
- Manifestations are less severe in tyrosinase positive type, where the abnormality is in the uptake of tyrosine by melanocytes.

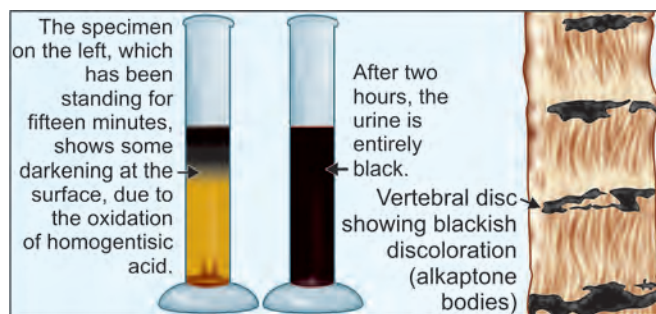


Fig. 18.6B: Left side, urine of alkaptonuria; Right side alkatone bodies deposited in vertebral disc of patient

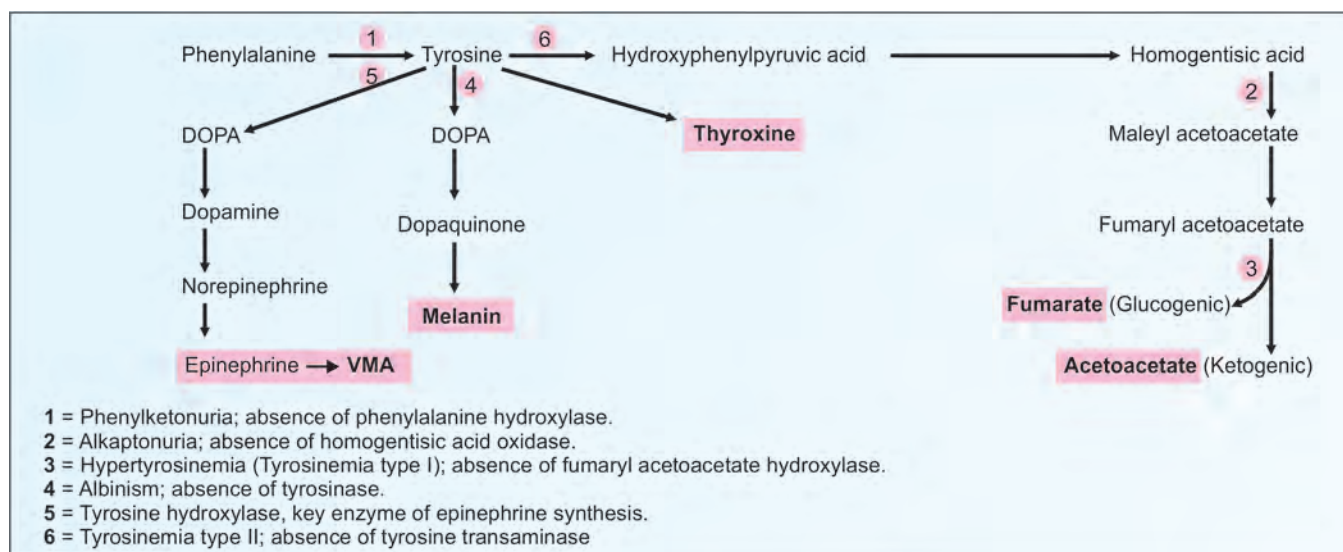


Fig. 18.7: Summary of tyrosine metabolism



6. Albinism may be produced by the following causes:
  - a. Melanocyte deficiency secondary to a failure of melanoblasts to colonize the skin.
  - b. Failure of melanocytes to form melanosomes
  - c. Due to tyrosinase deficiency, melanin is not produced in the melanosomes
  - d. Failure of melanosomes to form melanin owing to substrate deficiency
  - e. Failure of melanosomes to store melanin or to transport melanin to keratinocytes
  - f. Excessive destruction of functional melanosomes.

## HYPERTYROSINEMIAS

### Hepatorenal Tyrosinemia (Tyrosinemia Type I)

- i. It is also called as tyrosinosis. It is an autosomal recessive condition with an incidence of 1.5 per 1,000 births. It is due to a deficiency of enzyme **fumaryl acetoacetate hydrolase** (step no. 5 in Fig.18.2 and item 3, Fig.18.7).
- ii. Symptoms manifest by the first 6 months of life and death occurs rapidly. Cabbage like odor and hypoglycemia and eventual liver failure are seen. There may be mild mental retardation.
- iii. Urine contains tyrosine, para-hydroxyphenylpyruvic acid (p-HPPA) and hydroxyphenyllactic acid; and serum shows tyrosine.
- iv. Tyrosine and phenylalanine restricted diet is advised.

### Oculocutaneous Tyrosinemia (Tyrosinemia Type II)

It is due to deficiency of tyrosine amino transferase (tyrosine transaminase) (step no. 2, Fig.18.2). Mental retardation, keratosis of palmar surface, painful corneal lesions and photophobia are seen. There is increased excretion of tyrosine and tyramine in urine. A diet low in protein is advised.

### Neonatal Tyrosinemia (Tyrosinemia Type III)

This is due to the absence of the enzyme para-hydroxyphenylpyruvate hydroxylase (step no.3, Fig.18.2). This deficiency may cause transient hypertyrosinemia in the new born; this will respond to administration of ascorbic acid and dietary protein restriction.

A variant of the above disease is called **Hereditary p-HPPA Oxidase Deficiency**. This is a more aggressive condition. It is characterized by neurological abnormalities and excretion of tyrosine, para-hydroxy phenylpyruvic acid (p-HPPA), hydroxyphenyllactic acid and hydroxy phenylacetic acid in urine.

### Hawkinsinuria

It is an autosomal dominant trait, and is due to dysfunction of p-HPPA oxidase. It is characterized by excretion of hawkinsin in urine, a derivative of p-HPPA.

A summary of phenylalanine and tyrosine metabolism is shown in Figure18.7.

## TRYPTOPHAN (TRP) (W)

### Substances Produced from Tryptophan are

1. Alanine (glucogenic)
2. Acetoacetyl CoA (ketogenic)
3. Formyl group (One-carbon unit)
4. Niacin and NAD<sup>+</sup>
5. Serotonin
6. Melatonin
7. Hydroxyindoleacetic acid (excretory product)
8. Indican (excretory product).

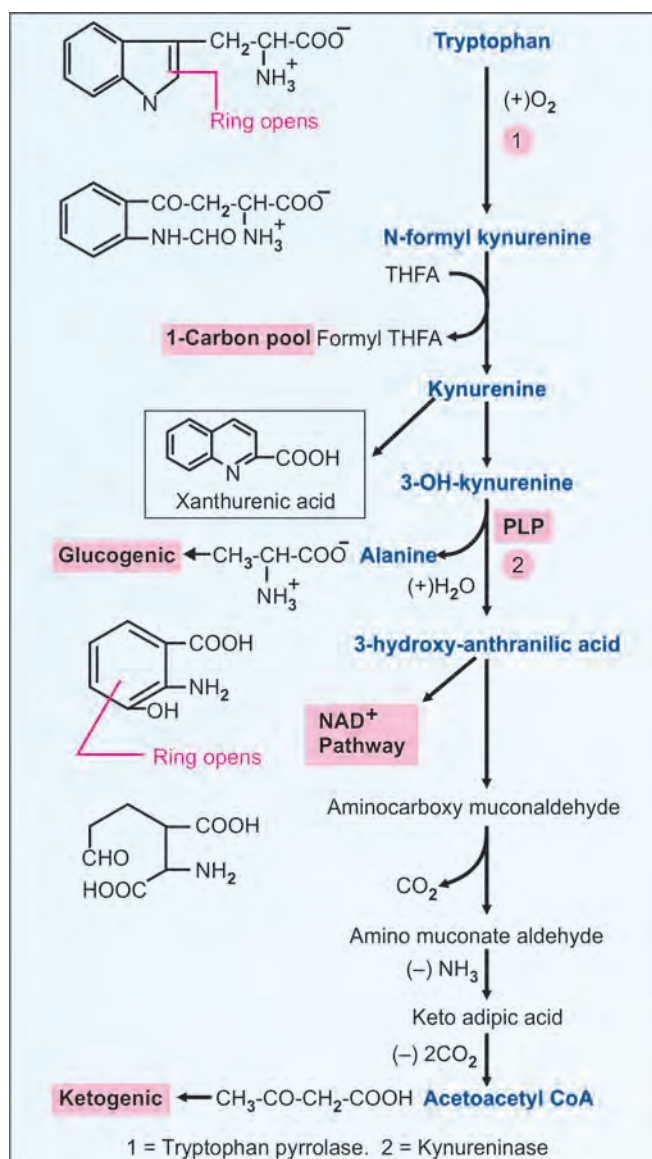


Fig. 18.8: Metabolism of tryptophan



## Major Catabolic Pathway of Tryptophan

- In 1890, Ernst Stadmann discovered tryptophan; Hopkins determined the structure in 1901, and established its essentiality for growth in 1906. Tryptophan is an aromatic, essential amino acid with an **indole ring**.
- The major metabolic fate of tryptophan is to be oxidized by **tryptophan pyrrolase** (tryptophan dioxygenase) (step 1, Fig. 18.8). It is a hemoprotein. The enzyme is inducible by corticosteroids.
- In this major pathway, the total 11 carbon atoms of tryptophan are catabolized as formyl group (1C which enters the one carbon pool), alanine (3C, entering the glucose pathway) and acetoacetate (4C, going to ketogenic pathway). So, tryptophan is both **glucogenic and ketogenic**. The remaining 3 carbons are removed as 3 CO<sub>2</sub> molecules.
- In the major pathway, **kynureninase** is an enzyme dependent on pyridoxal phosphate (enzyme 2,

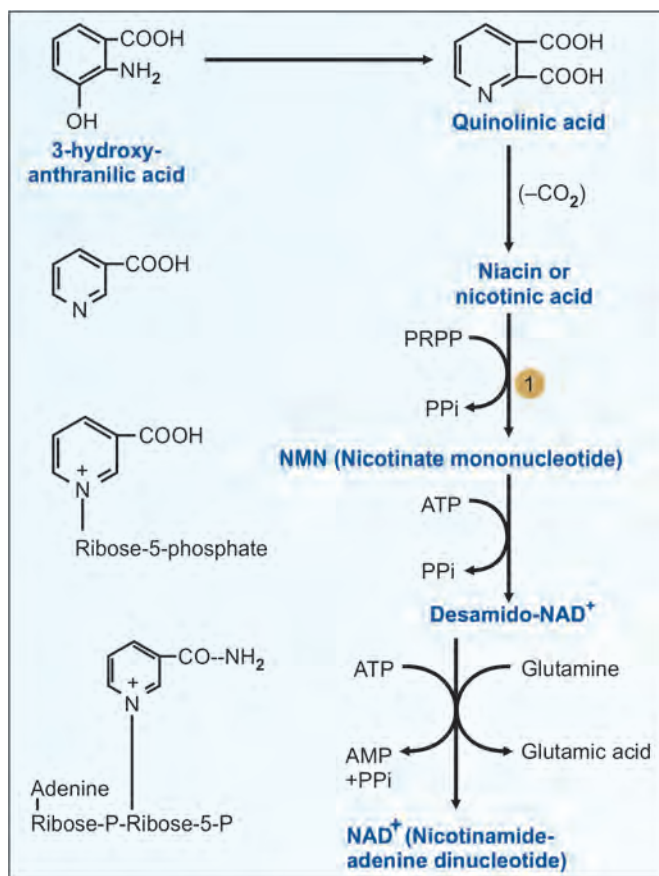


Fig. 18.9: Synthesis of niacin from tryptophan; PRPP= phosphoribosyl pyrophosphate. (1) = quinolinate phosphoribosyl transferase

Fig. 18.8). Therefore, in vitamin B<sub>6</sub> deficiency, the pathway at this level is blocked. This leads to **niacin deficiency** and manifestations of pellagra.

- The accumulated kynurenine is shunted to xanthurenic acid. So, in pyridoxal deficiency, **xanthurenic acid** (Fig. 18.8) is excreted in urine.

## Nicotinic Acid Pathway of Tryptophan

- About 97% molecules of tryptophan are metabolized in the major pathway. About 3% molecules are diverted at the level of 3-hydroxyanthranilic acid, to form NAD<sup>+</sup> (Fig.18.9).
- The enzyme, QPRT (**quinolinate phosphoribosyl transferase**) (step 1, Fig.18.9) is the rate-limiting step.
- About **60 mg of tryptophan** will be equivalent to **1 mg of nicotinic acid**. The development of pellagra like symptoms (see Chapter 37) in the maize eating population is due to tryptophan deficiency in maize.
- Hydroxyanthranilate production is dependent on pyridoxal phosphate (step 3, Fig. 18.8). Hence in vitamin B<sub>6</sub> deficiency, **nicotinamide deficiency** is also manifested.

## Serotonin

- Serotonin (5-hydroxytryptamine) is produced in the brain, mast cells, platelets and gastrointestinal tract mucosa.
- Tryptophan is first hydroxylated by **tryptophan hydroxylase** (step 1, Fig.18.10). This reaction is very much similar to phenylalanine hydroxylase (Fig. 18.1). The co-enzyme is tetrahydrobiopterine. The tetrahydrobiopterine is regenerated using NADPH.
- In the next step, 5-hydroxytryptophan is decarboxylated to 5-hydroxytryptamine (5HT), (serotonin). The enzyme, **decarboxylase** requires **pyridoxal phosphate** (step 2, Fig. 18.10).
- The effect of serotonin is dependent on the amount of serotonin available at the synaptic site. Part of the serotonin released is again taken up (reuptake). **Selective serotonin reuptake inhibitors (SSRI)** are widely used in the treatment of psychiatric disorders.

## Functions of Serotonin

- Serotonin is an important neurotransmitter in brain. In brain cells, serotonin is in bound form. **Reserpine** causes rapid release; this leads to calming effect

and depression. On the other hand, 5-HT is an anti-depressant.

- When ordinary proteins are taken, all amino acids are available in blood. This causes traffic jam in the amino acid transport systems in brain cells. Tryptophan, the bulkiest amino acid is therefore taken up very slowly.
- However, when carbohydrate-rich diet is taken, insulin secretion is increased, which will lower the amino acid concentration in blood. So tryptophan easily enters the brain cells. When tryptophan is

available in brain in excess quantity, serotonin may be generated to induce sleep.

- Carbohydrates will induce sleep, while protein-rich foods will cause alertness.**
- Serotonin level is found to be low in patients with **depressive psychosis**. Serotonin is involved in mood, sleep, appetite and temperature regulation. It increases gastrointestinal motility.
- Sensitivity to pain is reduced by serotonin.

### Catabolism of Serotonin

**Monoamine oxidase (MAO)** converts serotonin to **5-hydroxyindoleacetic acid (HIAA)** (step 3, Fig. 18.10). MAO will oxidatively deaminate compounds having an amino group attached to a carbon atom. This is similar to degradation of epinephrine (step 6, Fig.18.4). **MAO inhibitors** (e.g. iproniazid) will cause mood elevation. Small portion of serotonin is conjugated with sulfate or with glucuronic acid, and excreted through urine.

### Carcinoid Tumors

- Serotonin is produced by **argentaaffin cells** of the gastrointestinal tract and is necessary for GIT motility. These cells may grow into locally malignant **argentaaffinomas**, otherwise known as **carcinoid tumors**. These tumors develop in small intestine or in the appendix. Serum level of serotonin is increased in carcinoid tumors (>40 mg/dL). (Sometimes, oat cell carcinoma of lungs may also show increased serotonin secretion).
- The patient complains of flushing, sweating, intermittent diarrhea and often has fluctuating hypertension.
- Normally, about 1% tryptophan molecules are channelled to serotonin synthesis. But in carcinoid syndrome, up to 60% is diverted to serotonin. Therefore, **niacin deficiency** (pellagra) may also be seen in carcinoid syndrome.
- HIAA (5-Hydroxyindoleacetic acid) in urine:** After stopping all medications for 72 hours, collect random fresh urine. Exclude dietary sources of 5 HIAA

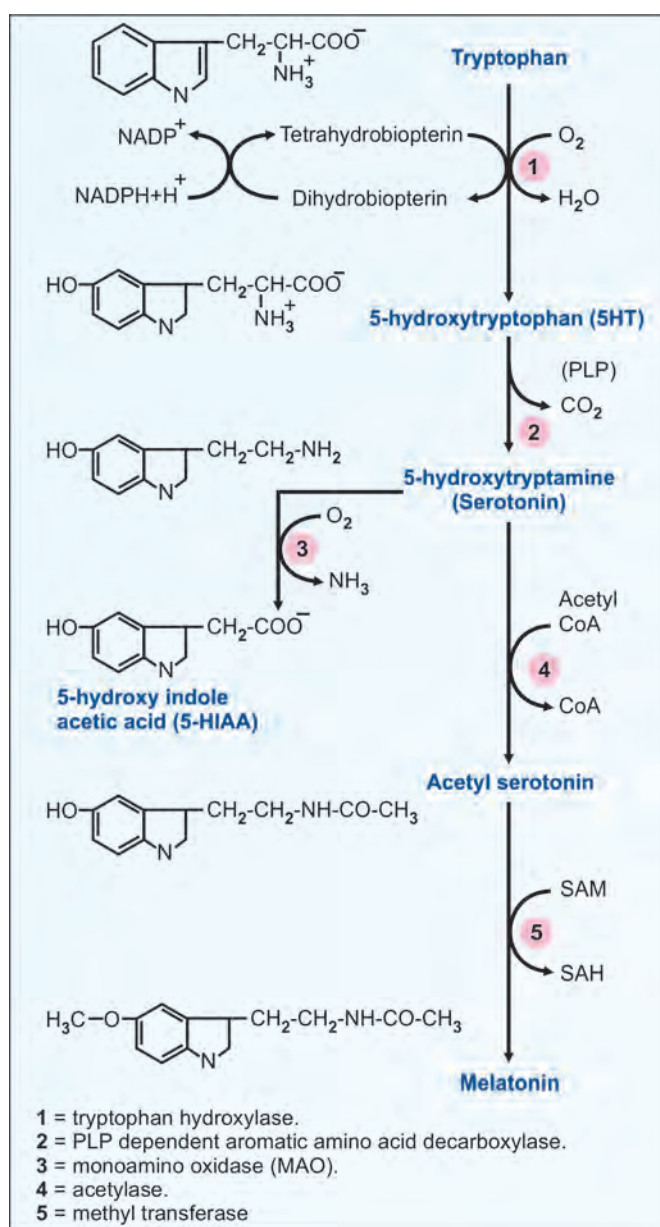


Fig. 18.10: Serotonin and melatonin synthesis

#### Box 18.5: Melanin and melatonin are different

**Melanin** is the pigment of hair and skin; it is synthesized from Tyrosine (Fig.18.3).

**Melatonin** is a neurotransmitter synthesized from tryptophan (Fig. 18.10).

(Avocado, banana, red plum, pineapple, tomato, cough syrup containing glycerol guaiacolate, drugs like indomethacin). Normal value is 2–7 mg/day. It is increased in carcinoid tumors in the gut or bronchus, tropical sprue, Whipple's disease, oat cell carcinoma of the bronchus. If urine 5 HIAA exceeds 25 mg/day, diagnosis of carcinoid syndrome can be made. Metastatic carcinoid tumor (functioning) shows higher values (>350 mg/day). Since 5 HIAA secretion may be intermittent, repeated testing is required. It is decreased in depression, small intestinal resection, phenylketonuria and Hartnup disease.

## Melatonin

- Serotonin is acetylated (step 4, Fig. 18.10).
- Further methylated with the help of S-adenosyl methionine (SAM) (step 5, Fig.18.10 and Box 18.5).
- Pineal gland** produces melatonin. It is intimately connected with the diurnal variations, sleep wake cycles and the **biological rhythms**.
- Melatonin blocks MSH and ACTH secretions. The activity of melatonin as a neurotransmitter was

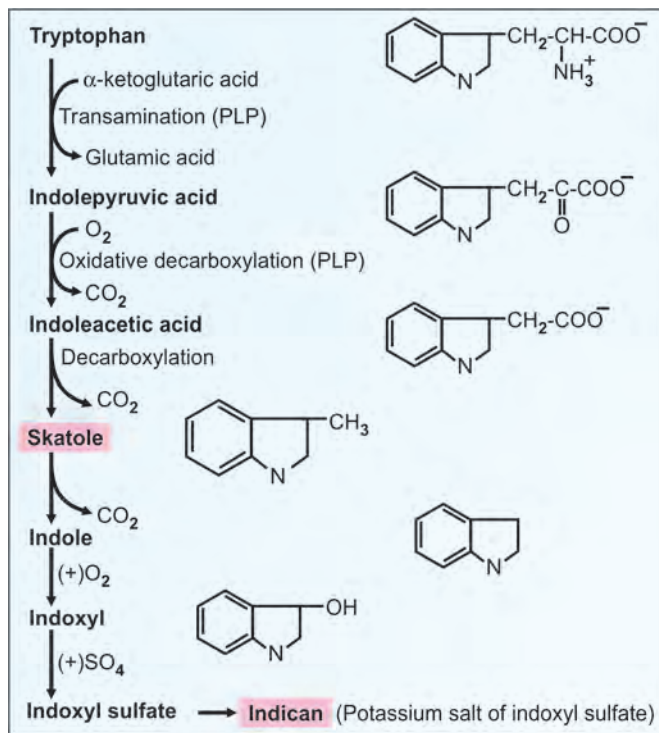


Fig. 18.11: Major excretory products of tryptophan

discovered by Julius Axelrod who was awarded Nobel prize in 1970.

## Putrefaction of Tryptophan

Intestinal bacterial putrefaction of tryptophan results in the production of several indole compounds (Fig. 18.11). These are mainly excreted in the feces as **skatoxyl**. Some part is absorbed, detoxified and excreted in urine as indoxyl and indican. **Indican** is the potassium salt of indoxyl sulfate. The foul smell of feces and the natural color of urine is due to these compounds. Normal excretion of indican in urine is 4–20 mg/day, which is increased in Hartnup's disease.

Liver and intestinal bacteria can convert tryptophan to **tryptamine**, and then to indole-acetate. The major urinary excretory products of tryptophan are 5-hydroxy indole acetate and indole-3-acetate.

## Hartnup's Disease

- The name originates after the first family in whom the disease was described. It is an inherited autosomal **recessive** disease.
- Absorption of aromatic amino acids from intestine as well as reabsorption from renal tubules are defective. So amino acids are excreted in urine.
- The **pellagra** like symptoms are due to the deficiency of niacin derived from tryptophan. The common manifestations are dermatitis and ataxia.
- A diagnosis is based on **aminoaciduria** and increased excretion of indole compounds detected by the **Obermeyer test**.
- Patients improve when put on a high protein diet with supplementation of niacin and minimum exposure to sunlight. The neuropsychiatric manifestations of Hartnup's disease are said to be responsible for the

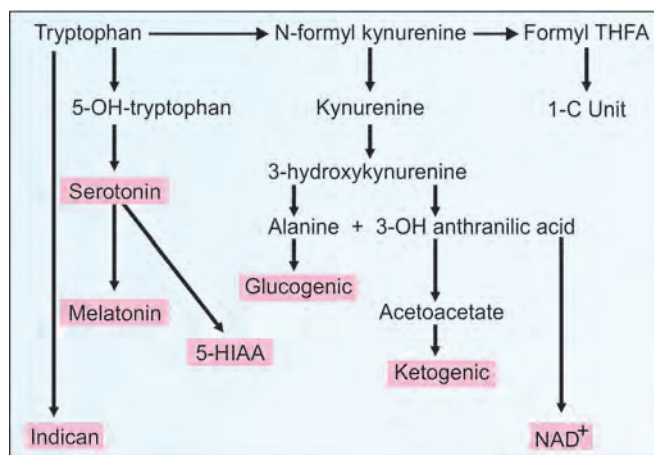


Fig. 18.12: Summary of tryptophan metabolism



sadistic and bizarre behavior of emperors like Nero and Caligula.

### Nonphysiological Hypertryptophanuria

True hypertryptophanuria can be caused either by a defect in the conversion of tryptophan to kynurenine or by an abnormality in renal amino acid transport. True hypertryptophanuria can be caused by a defect in the conversion of tryptophan to kynurenine (Hartnup disease) or by an abnormality in renal amino acid transport (e.g. Tada disease). The literature describing potential interferences by therapeutic drugs should be consulted when nonphysiological amino acid concentrations are obtained.

A summary of tryptophan metabolism is shown in Figure 18.12.

## HISTIDINE (HIS) (H)

Histidine has an imidazole ring. It is a **semi-essential** basic amino acid. Its pK value is 6.1; and hence in proteins, histidine is responsible for the maximum **buffering** action.

Histidine is first non-oxidatively deaminated by histidase to form urocanic acid (step 1, Fig. 18.13). It is then hydrated to imidazolone propionic acid (step 2) and then hydrolysed to formimino glutamic acid (FIGLU) (step 3, Fig. 18.13). FIGLU is cleaved into N5-formimino-THFA and glutamic acid (step4, Fig. 18.13). Glutamic acid is transaminated to alpha keto glutarate which can be

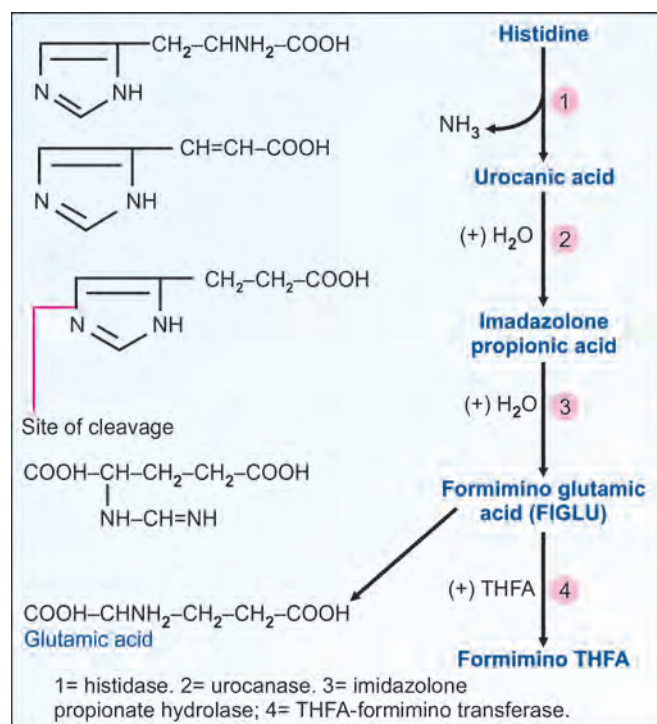


Fig. 18.13: Metabolism of histidine

converted to glucose. So histidine is **glucogenic**. Histidine contributes to the **one carbon pool**.

When **folic acid** is deficient, **FIGLU is excreted** in urine. Histidine can undergo transamination with pyruvate to form imidazole pyruvate and alanine.

## Histamine

Histamine is formed from histidine by decarboxylation, catalyzed by histidine decarboxylase (step 1, Fig. 18.14). The effects of histamine are summarized in Table 18.1. Smooth muscle contraction, enhanced vascular permeability, increased **acid secretion** are the important actions. So, histamine causes fall in blood pressure.

The major cells producing histamine are platelets, mast cells and basophils. Certain antigens, such as penicillin will elicit IgE antibodies that are fixed on the mast cells. When the next dose of penicillin is injected, it reacts with

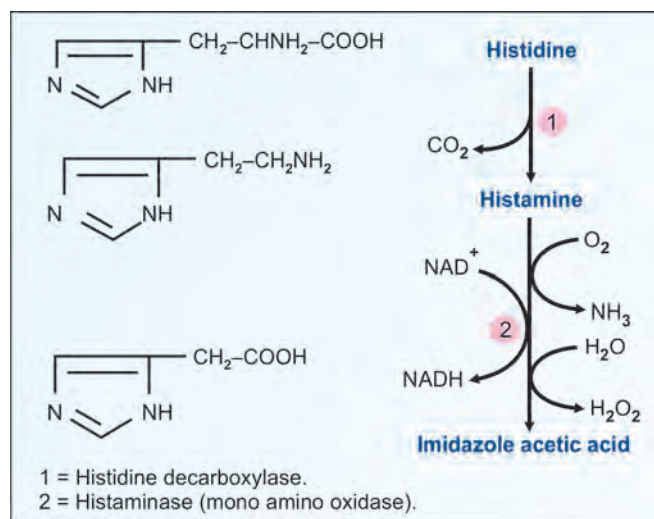


Fig. 18.14: Metabolism of histamine

TABLE 18.1: Summary of action of histamine

	Tissue	Effect
1.	Blood vessels	Pulmonary venous dilation; superficial temporal artery dilation (migraine). Large veins, smaller venules and capillaries are dilated
2.	Cardiovascular system	Fall in BP; increased capillary permeability
3.	Heart	Chronotropic and inotropic effect on heart, coronary artery flow is increased
4.	Smooth muscles	Direct stimulant; contraction of bronchial muscles; bronchospasm
5.	Exocrine glands	Stimulates gastric acid secretion



the antibodies; and degranulation of mast cells takes place. Histamine and slow reacting substance (SRS) are released. This leads to peripheral vasodilatation, fall in blood pressure and **anaphylaxis**.

**Antihistamines** are drugs which block histamine receptors. They are used to control allergic and anaphylactic reactions. The stimulant effect of histamine on gastric acid secretion is by acting on H<sub>2</sub> receptors. Hence, H<sub>2</sub> receptor antagonists are used in the treatment of acid peptic ulcers of stomach.

### Histidinemia

It is an autosomal **recessive** disease. The deficiency of **histidase** leads to accumulation of histidine in blood and body fluids and increased excretion of imidazole pyruvic acid in urine. The clinical features include **mental retardation** and delayed speech development. A low histidine diet may have some effect.

### Urocanic Aciduria

It is due to the deficiency of urocanase. Urocanic acid and histidine are excreted in urine. Clinical manifestations are minimal.

### Imidazole Aminoaciduria

It has dominant type inheritance. The defect is in the transport mechanism in kidney tubules. Cerebromacular and **retinal degeneration** may cause blindness.

## Folic Acid Deficiency

Folic acid is the co-enzyme for the conversion of FIGLU to glutamate. Block in this step leads to increased excretion of FIGLU in urine.

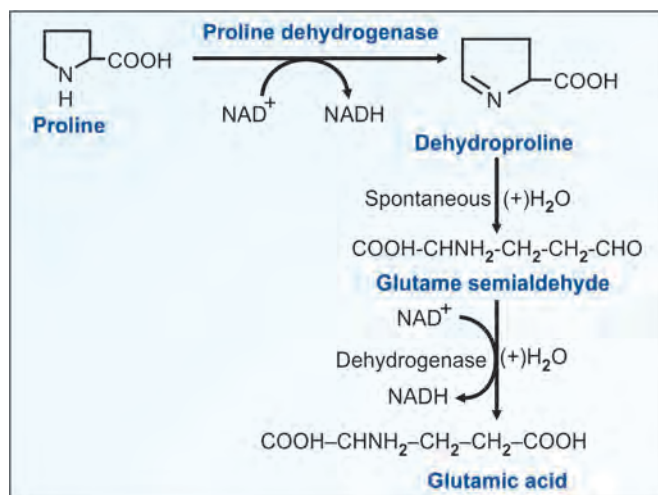


Fig. 18.15: Degradation of proline

### FIGLU Excretion Test

It is a sensitive indicator for folic acid deficiency. About 5 g of histidine is given three times at 4-hourly intervals. Urine is collected for 24 hours after the initial dose. Normally less than 30 mg of FIGLU is excreted per day; the value is increased in folate deficiency.

## PROLINE (PRO) (P) AND HYDROXYPROLINE

Proline is a non-essential glucogenic amino acid. The catabolic pathway of proline is described in Figure 18.15. Proline does not participate in the transaminase reaction. Proline is made into glutamate, which enters the citric acid cycle for complete oxidation. In proline dehydrogenase deficiency leads to an inborn error of metabolism named as type I hyperprolinemia. Deficiency of glutamate semialdehyde dehydrogenase, causes type II hyperprolinemia. Both conditions are benign.

Proline can be synthesized from glutamic acid with minor modification of the catabolic pathway. For synthesis of proline, glutamate is first activated by phosphorylation with the help of ATP. Glutamate phosphate is reduced by NADPH to glutamate semialdehyde, which on removal of water will give rise to pyrroline-5-carboxylate. It has a double bond in the ring. It is further reduced with the help of NADPH to form proline.

Proline is incorporated into the protein, and then hydroxylated to hydroxy proline, by the enzyme **prolyl hydroxylase**. The hydroxylation requires molecular oxygen, ascorbate, iron and alpha keto glutarate, which is decarboxylated to succinate. One atom of oxygen molecule is incorporated into proline and the other into succinate.

**Hydroxyproline** is catabolized more or less similar to proline. The pathway is, hydroxyproline to pyrroline-3-hydroxy-5-carboxylate, to hydroxy-glutamate semialdehyde, to hydroxy-glutamate, to keto-hydroxy glutarate, which is broken by an aldolase to **glyoxalate** and pyruvate. Deficiency of hydroxy proline dehydrogenase will lead to **hyperhydroxyprolinemia**. It is also a benign condition.

Proline and 4-hydroxy proline confer strength to fibrous proteins like collagen, elastin, keratin, etc. (see Chapter 58). In **vitamin C deficiency**, hydroxyproline synthesis is reduced, causing decreased strength of fibers, leading to scurvy. The excretion of hydroxyproline in urine is increased in tumors infiltrating bones and in diabetic patients due to enhanced rate of protein catabolism.

## Fate of Carbon Skeletons of Amino Acids

During catabolism of carbon skeletons, amino acids may enter into the TCA cycle, when they can be converted to glucose. In other words, those amino acids, which give rise to citric acid cycle intermediates can be made into glucose. Hence, those amino acids entering into TCA cycle, or at pyruvic acid level are called **glucogenic** amino acids. This is shown in Figure 18.16.

On the other hand, those amino acids which produce acetyl CoA are called **ketogenic** amino acids. Acetyl CoA entering into the TCA cycle, is completely oxidized. Therefore, **there is no net synthesis of glucose from acetyl CoA**. So, acetyl

CoA is not entering into the gluconeogenesis pathway. Acetyl CoA, however, can give rise to ketone bodies. Thus, **amino acids entering as acetyl CoA are known as ketogenic amino acids**. These amino acids are shown in Figure 18.16.

But some amino acids are shown in both the lists. **Phenylalanine, tyrosine, tryptophan and isoleucine** are both **glucogenic and ketogenic**. This is because, during their metabolism, part of the carbon skeleton will enter into some of the TCA cycle intermediates; while the other part will generate acetyl CoA (Fig. 18.16).

## AMINOACIDURIAS

Aminoacidurias are clinically very important. It is estimated that about 20 to 25% of the inmates of psychiatric hospitals are suffering from one of the aminoacidurias. Most of them manifest as **mental retardation**. It is important to remember that the mental retardation could be prevented, if the condition is diagnosed immediately after the birth, and adequate treatment is started. Delay in diagnosis for each week will appreciably reduce the intelligence quotient.

Several inborn errors of metabolism with neurological defects are associated with cerebral dysmorphogenesis. This may be due to:

- Accumulation of neurotoxic intermediate, e.g. non-ketotic hyperglycinemia (NKH), sulfite oxidase deficiency
- Defective energy metabolism; PDH deficiency
- Defective membrane and cell signalling pathways, e.g. Smith's disease.
- Defects of subcellular organelle, e.g. peroxisomal biogenesis disorders.

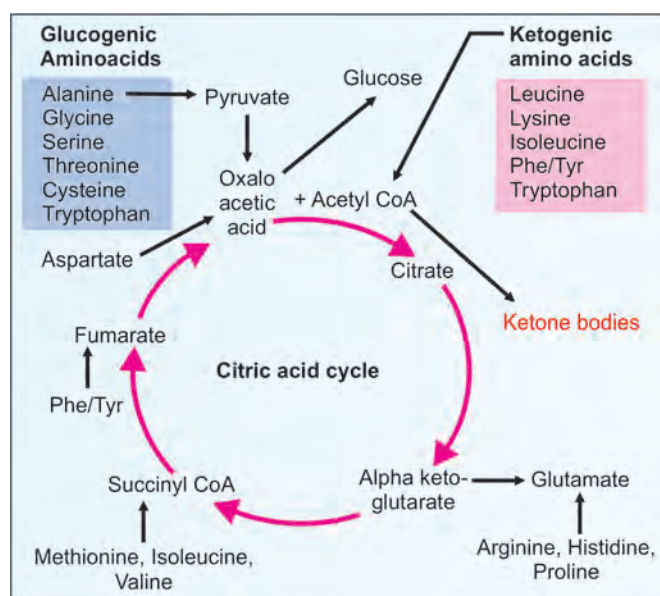


Fig. 18.16: Metabolic fates of amino acids

## Clinical Case Study 18.1

A 50-year-old man with 2 years history of refractory hypertension and occasional panic attacks reported to the clinic with sudden episode of pounding headache. There was excessive sweating. He had similar attacks earlier. Family history is positive for hypertension. On examination, BP was 170/90 mm Hg and pulse was 72/min. Weight was 80 kg. He was taking beta blockers. Other examination findings were unremarkable. 24 hours VMA was elevated (12.0 mg/day). What is the probable diagnosis?

## Clinical Case Study 18.1 Answer

Patient is suffering from pheochromocytoma, a catecholamine-producing tumor of sympathetic or parasympathetic nervous system. Catecholamines are degraded by two enzymes, COMT and MAO and the final product is VMA, vanillylmandelic acid. This is increased in pheochromocytoma (and paraganglioma, another similar tumor).

Pheochromocytoma usually is seen around the age of 40, though it can set in at any time. The “rule of ten” for pheochromocytoma states that 10% are bilateral, 10% are extra-adrenal, and 10% are malignant. Up to 25% may be familial. It may be part of a syndrome known as multiple endocrine neoplasia (MEN). Common laboratory investigations are 24 hours urinary VMA, metanephrine (total and fractionated), and plasma metanephrines.

Clinical features are varied, but the classic triad of symptoms is episodes of palpitations, headaches and profuse sweating. Both benign and malignant pheochromocytomas can recur (after surgery) and hence long-term follow-up is important. Recurrence rate is also 10%.

## QUICK LOOK OF CHAPTER 18

- Phenylalanine is an essential amino acid. It has a sparing action on Tyrosine.
- Tetrahydrobiopterine is an important co-factor for phenylalanine hydroxylase, deficiency of which can lead to inborn metabolic defect.
- Biologically important products from tyrosine are melanin, catecholamines and thyroid hormones.
- Tyrosinase requires copper, while tyrosine hydroxylase requires tetrahydrobiopterine as co-factor.
- L-Dopa, an inhibitor of DOPA decarboxylase is used in the treatment of Parkinson's disease.

6. The end product of epinephrine metabolism is Vanillyl Mandelic acid (VMA). Its excretion is increased in pheochromocytoma and neuroblastoma.
7. Phenylketonuria (PKU) is an inborn error of metabolism, caused by defective Phenylalanine hydroxylase enzyme. The disease manifests with profound mental retardation, convulsions and hypopigmented skin.
8. Alkaptonuria is due to deficiency of homogentisate oxidase. There is excretion of urine that darkens on standing.
9. Absence of tyrosinase leads to 'albinism'.
10. Tryptophan produces biologically important products viz Nicotinic acid, Serotonin and Melatonin.
11. Serotonin is an important neurotransmitter. It is catabolized to 5 HIAA, it is increased in carcinoid tumors.
12. Melatonin produced in the pineal gland, regulates the biological rhythms and sleep-wake cycle.
13. Decarboxylation of histidine produces histamine. It is a stimulator of gastric secretion, both acid and enzymes.
14. FIGLU excretion test is used to assess folic acid deficiency.
15. Glucogenic amino acids are: Glycine, Alanine, Valine, Serine, Threonine, Aspartic acid, Glutamic acid, Asparagine, Glutamine, Methionine, Cysteine, Arginine, Histidine, Proline.
16. Ketogenic amino acids are; Leucine, Lysine
17. Partially glucogenic and partially ketogenic amino acids are: Phenyl alanine, Tyrosine, Tryptophan, Isoleucine
18. Aminoacidurias are inborn metabolic disorders, which lead to mental retardation in most cases. Early detection and prompt management helps prevent complications.

# CHAPTER 19

## Citric Acid Cycle

### Chapter at a Glance

The reader will be able to answer questions on the following topics:

- Citric acid cycle
- Regulation of citric acid cycle
- Significance of citric acid cycle
- Integration of metabolism

Before 1937, Car Martias, Fray Knoop and Albert Szent-Gyorgyi had elucidated most of the reactions described in this chapter. The complete cycle was proposed by Sir Hans Krebs in 1937 (Nobel prize, 1953). The cycle is therefore named after him. Please note that the name is **Krebs cycle (there is no apostrophe)**. Krebs proposed the original name as TCA (tricarboxylic acid) cycle, because he was not sure whether citric acid is a member of the cycle. “Nature” journal rejected the paper submitted by Krebs for publication in 1937, but he got it published in “Enzymologia”. Later, Ogston (1948) showed that the tricarboxylic acid in question is indeed citric acid, and so the name Citric Acid cycle was given later. Scheele in 1780 had isolated citric acid from citrus fruits.

### Functions of the Citric Acid Cycle

1. The final common oxidative pathway that oxidizes acetyl CoA to CO<sub>2</sub>.
2. The source of reduced co-enzymes that provide the substrate for the respiratory chain.
3. The link between catabolic and anabolic pathways (amphibolic role).
4. Provides precursors for synthesis of amino acids and nucleotides.
5. Components of the cycle have a direct or indirect controlling effects on key enzymes of other pathways.

### Reactions of the Cycle Preparatory Steps

Acetyl CoA enters the cycle, and is completely oxidized. During this process, energy is trapped. The **sources of acetyl CoA** are shown in Figure 19.1. **Pyruvate** derived from glycolysis is oxidatively decarboxylated to acetyl CoA by the **pyruvate dehydrogenase** (see Fig. 9.22). This is the link between the TCA cycle and glycolysis. The pyruvate dehydrogenase reaction occurs in the mitochondria. Pyruvate with the help of a carrier can enter the mitochondria from the cytoplasm. The acetyl CoA derived from beta oxidation is formed in the mitochondria

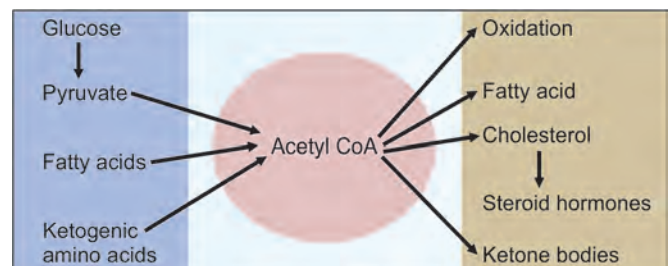


Fig. 19.1: Sources and utilization of acetyl CoA



itself. All the enzymes of citric acid cycle are located inside the **mitochondria**.

### First Step: Formation of Citric Acid

The 4 carbon, **oxaloacetate** condenses with 2 carbon, **acetyl CoA** to form 6 carbon compound, the citrate (a tricarboxylic molecule). The enzyme is **citrate synthase** (step 1, Fig. 19.2). The hydrolysis of the thioester bond in acetyl CoA drives the reaction forward. This is an irreversible step. However, body can reverse this step by another enzyme, ATP-citrate lyase (see Fig. 12.13).

### Second Step: Formation of Isocitrate

Citrate is isomerized to isocitrate by **aconitase** (step 2, Fig. 19.2). This reaction is a two-step process. At first, one water molecule is removed from citrate forming **cis-aconitate**; a **transient** compound with a very short half-life. Immediately, one water molecule is added to aconitate to form isocitrate. Thus, the position of the hydroxyl group is shifted.

### Third Step: Formation of Alpha Keto Glutarate

- This reaction is a two-step process, both catalyzed by the same enzyme, **isocitrate dehydrogenase** (step 3, Fig. 19.2). In the first part of the reaction, isocitrate is dehydrogenated to form **oxalosuccinate**. It is an unstable compound, which undergoes spontaneous decarboxylation to form alpha keto glutarate.
- The **NADH generated** in this step is later oxidized in electron transport chain (ETC) to generate **ATPs**.
- Isocitrate (6 carbons) undergoes **oxidative decarboxylation** to form alpha keto glutarate (5 carbons). In this reaction, one molecule of **CO<sub>2</sub> is liberated**.
- The isocitrate dehydrogenase has isoenzymes; the mitochondrial form utilizes **NAD<sup>+</sup>**, while cytoplasmic enzyme is **NADP<sup>+</sup>** dependent.



Carl  
Wilhelm  
Scheele  
1742–1789



Albert  
Szent-Gyorgyi  
NP 1937  
1893–1986



Alexander  
George  
Ogston  
1911–1996



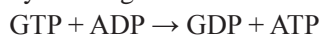
Hans Adolf  
Krebs  
NP 1953  
1900–1981

### Fourth Step: Formation of Succinyl CoA

- Next, alpha keto glutarate is **oxidatively decarboxylated** to form succinyl CoA by the enzyme **alpha keto glutarate dehydrogenase** (step 4, Fig. 19.2).
- The **NADH** thus generated enters into ETC to generate **ATPs**.
- Another molecule of **CO<sub>2</sub> is removed** in this step.
- This is the **only irreversible step** in the whole reaction cycle.
- The enzyme alpha keto glutarate dehydrogenase is a **multienzyme complex** having 3 enzyme proteins and 5 co-enzymes. This is similar to the pyruvate dehydrogenase reaction (Compare Fig. 19.3 with Fig. 9.22). The first two enzyme activities are similar to the corresponding components of Pyruvate dehydrogenase complex and the 3rd enzyme is the same in both complexes. This reaction is summarized in Figure 19.3.

### Fifth Step: Generation of Succinate

The next reaction involves a **substrate level phosphorylation** whereby a high energy phosphate is generated from the energy trapped in the thioester bond of succinyl CoA. The enzyme is **succinate thiokinase** (step 5, Fig. 19.2). A molecule of GDP is phosphorylated to **GTP** and succinate is formed. The GTP can be converted to ATP by reacting with an ADP molecule:



Succinyl CoA metabolism is shown in Figure 12.11.

### Sixth Step: Formation of Fumarate

Succinate is dehydrogenated to fumarate, an unsaturated dicarboxylic acid, by **succinate dehydrogenase** (step 6, Fig. 19.2). The hydrogen atoms are accepted by **FAD**. The **FADH<sub>2</sub>** then enters into ETC to generate **ATPs**. The enzyme is a flavoprotein. The succinate dehydrogenase is competitively inhibited by malonate (see Fig. 5.19).

### Seventh Step: Formation of Malate

The formation of malate from fumarate is catalyzed by **fumarase** (step 7, Fig. 19.2). The reaction involves the addition of a water molecule. Only L-malate is formed.

### Eighth Step: Regeneration of Oxaloacetate

Finally malate is oxidized to oxaloacetate by **malate dehydrogenase** (step 8, Fig. 19.2). The coenzyme is **NAD<sup>+</sup>**.

The **NADH** is generated in this step, which enters the electron transport chain, when **ATPs** are produced. The oxaloacetate can further condense with another acetyl CoA molecule and the cycle continues (Fig. 19.2).

### Oxaloacetate as a Junction Point

- Oxaloacetate may be viewed as a **catalyst**, which enters into the reaction, causes complete oxidation of acetyl CoA and comes out of it without any change.

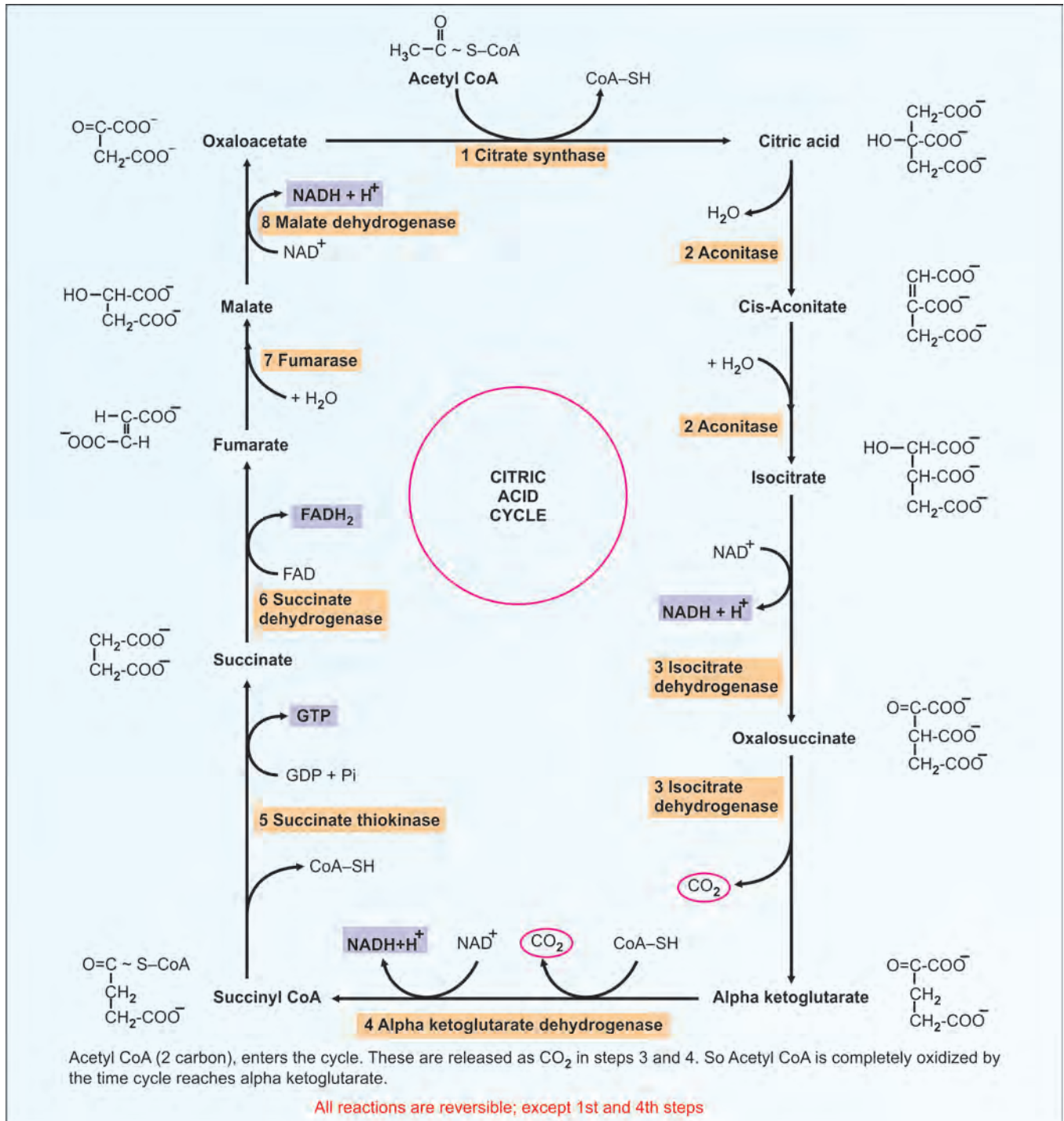


Fig. 19.2: Krebs cycle or citric acid cycle or tricarboxylic acid cycle

- ii. Oxaloacetate is an important junction point in metabolisms. Various reactions of oxaloacetate are shown in Figure 19.4. Significance of citric acid cycle is shown in Box 19.1.

## Complete Oxidation of Acetyl CoA

### CO<sub>2</sub> Removal Steps

During the citric acid cycle, two carbon dioxide molecules are removed in the following reactions:

- A. **Step 3**, oxalosuccinate to alpha ketoglutarate
- B. **Step 4**, alpha ketoglutarate to succinyl CoA (Fig.19.5).

Acetyl CoA contains 2 carbon atoms. These two carbon atoms are now removed as CO<sub>2</sub> in steps 3 and 4. Net result is that **acetyl CoA is completely oxidized during one turn of cycle.**

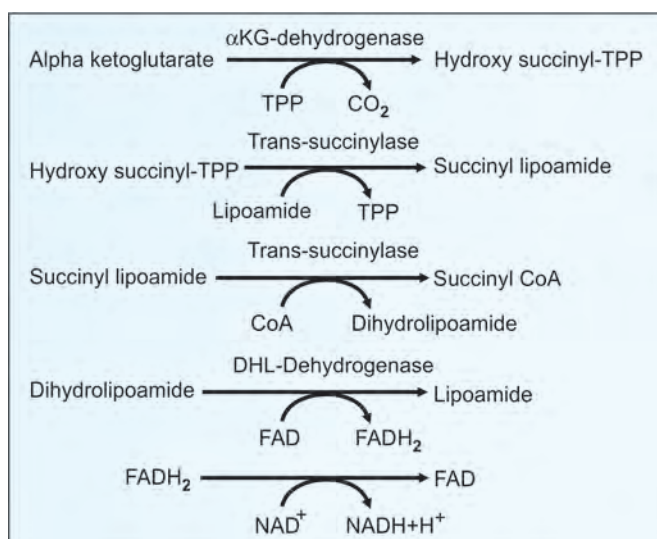


Fig. 19.3: Alpha ketoglutarate dehydrogenase reaction; compare it with Figure 9.22

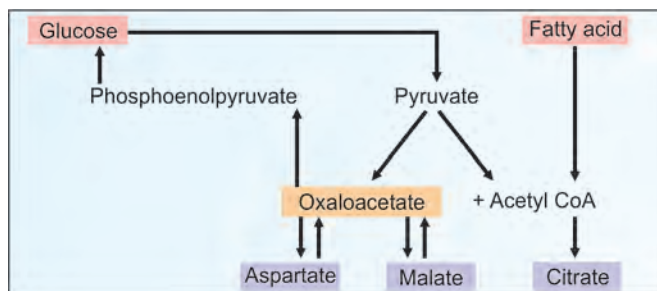


Fig. 19.4: Reactions of oxaloacetate

## ATP Generating Steps in TCA Cycle

There are 3 NADH molecules generated during one cycle, each of them will give rise to 2 ½ ATPs on oxidation by electron transport chain (ETC); so altogether they will give  $3 \times 2 \frac{1}{2} = 7 \frac{1}{2}$  (7.5) high energy phosphates. The FADH<sub>2</sub> will generate 1½ molecules of ATP. In addition, one molecule of GTP (equivalent to one molecule of ATP) is formed by **substrate level phosphorylation**. Hence, per turn of the cycle, **10 high energy phosphates** are produced. These steps are marked in Figure 19.5 and in Table 19.1. The summary is shown in Table 19.2.

**Note:** Recent work shows that in the electron transport chain, NADH produces only 2.5 ATPs and FADH only 1.5 ATPs. The old values are also given for comparison in Table 19.1.

Alpha ketoglutarate dehydrogenase reaction is the only one **irreversible step** in the cycle. The free energy changes of the reactions of the cycle are such that the cycle will operate spontaneously in the clockwise direction.

Only about 33% of energy liberated is trapped as ATP. The rest is used to keep the body temperature at a higher level than the environment.

## Final Common Oxidative Pathway

Citric acid cycle may be considered as the final common oxidative pathway of all foodstuffs. As shown in Figure 19.9, all the major ingredients of food stuffs are finally oxidized through the TCA cycle.

Almost all the biochemical processes use ATP for meeting energy needs—muscle contraction, active transport, biosynthetic reactions, etc. A thermodynamically unfavorable reaction when coupled with hydrolysis of ATP becomes favorable.

### Box 19.1: Significance of citric acid cycle

1. Complete oxidation of acetyl CoA
2. ATP generation
3. Final common oxidative pathway
4. Integration of major metabolic pathways
5. Fat is burned on the wick of carbohydrates
6. Excess carbohydrates are converted as neutral fat
7. No net synthesis of carbohydrates from fat
8. Carbon skeletons of amino acids finally enter the citric acid cycle
9. Amphibolic pathway
10. Anaplerotic role.



**TABLE 19.1:** ATP generation steps

Step No	Reactions	Co-enzyme	ATPs (old-calculation)	ATPs (new calculation)
3	Isocitrate → alpha keto glutarate	NADH	3	2.5
4	Alpha keto glutarate → succinyl CoA	NADH	3	2.5
5	Succinyl CoA → Succinate	GTP	1	1
6	Succinate → Fumarate	FADH <sub>2</sub>	2	1.5
8	Malate → Oxalo acetate	NADH	3	2.5
	Total		12	10

**TABLE 19.2:** Stoichiometry of the TCA cycle

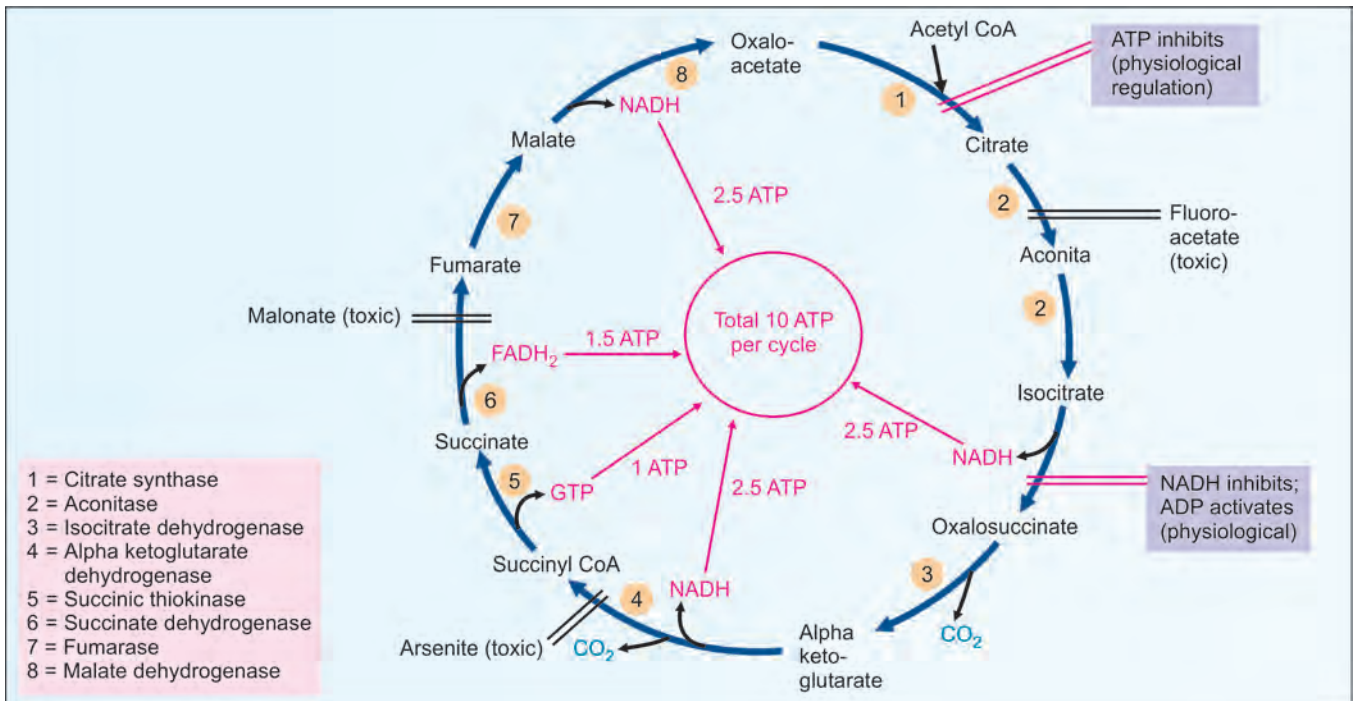
Acetyl CoA	}	→	}	2 CO <sub>2</sub> + CoA-SH
Oxaloacetate				Oxaloacetate
FAD				FADH <sub>2</sub>
3NAD <sup>+</sup>				3 NADH
GDP + Pi				GTP
GTP				

## Integration of Major Metabolic Pathways

- Carbohydrates** are metabolized through glycolytic pathway to pyruvate, then converted to acetyl CoA, which enters the citric acid cycle.
- Fatty acids** through beta oxidation, are broken down to acetyl CoA and then enters this cycle.
- Glucogenic amino acids** after transamination enter at some or other points in this cycle (Fig. 19.9). Ketogenic amino acids are converted into acetyl CoA.
- The integration of metabolism is achieved at junction points by key metabolites (Fig. 19.9). Several pathways can converge at this point with the result that carbon atoms from one source can be used for synthesis of another. Important intermediates are **pyruvate, acetyl CoA** and **oxaloacetate** (Figs 19.1 and 19.4).

## Fat is Burned on the Wick of Carbohydrates

The oil in a lamp by itself cannot be lighted; the flame needs a wick (Fig. 19.6). Similarly in the body, oxidation of fat



**Fig. 19.5:** Summary of Krebs citric acid cycle. Enzymes are numbered. Reactions number 3 and 4 are carbon dioxide elimination steps. Physiological regulatory steps are: Step No.1 (citrate synthase) is physiologically inhibited by ATP. Step No.3 (ICDH) is inhibited by NADH and activated by ADP. Steps where energy is trapped are marked with the co-enzyme and the number of ATP generated during that reaction. A total of 10 ATPs are generated during one cycle. Recent work shows that in the electron transport chain, NADH may produce only 2 1/2 ATPs and FADH only 1 1/2 ATPs



(acetyl CoA) needs the help of oxaloacetate. One passage of cycle oxidizes acetyl CoA into two  $\text{CO}_2$  molecules. Here oxaloacetate acts as a true catalyst; it enters the cycle and is regenerated at the end. The major source of oxaloacetate is pyruvate (carbohydrate). Hence, carbohydrates are absolutely required for oxidation of fats, or **fats are burned in the fire of carbohydrates**.

### Excess Carbohydrates are Converted as Neutral Fat

Excess calories are deposited as fat in adipose tissue. The pathway is glucose to pyruvate to acetyl CoA to fatty acid. However, **fat cannot be converted to glucose** because pyruvate dehydrogenase reaction (pyruvate to acetyl CoA) is an **absolutely irreversible** step (Fig. 19.7).

### No Net Synthesis of Carbohydrates from Fat

Acetyl CoA entering in the cycle is completely oxidized to  $\text{CO}_2$  by the time the cycle reaches succinyl CoA (Fig. 19.2). So, acetyl CoA is completely broken down in the cycle. Thus acetyl CoA cannot be used for gluconeogenesis. Therefore, there is no net synthesis of carbohydrates from fat (Fig. 19.7).

### Amino Acids Finally Enter the TCA Cycle

Some amino acids, such as leucine, catabolized to acetyl CoA; **are not converted to glucose**, because *pyruvate*



Fig. 19.6: Flame needs a wick; oxidation of fat needs carbohydrate

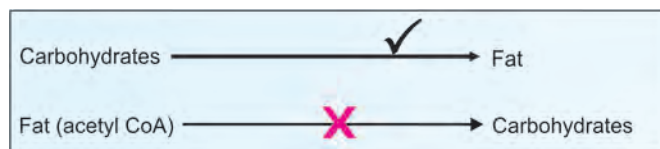


Fig. 19.7: Fat cannot be converted to glucose

to acetyl CoA reaction is irreversible. The acetyl CoA molecules either enter the TCA cycle and are completely oxidized, or are channeled to ketone body formation. Hence, they are called as **ketogenic amino acids** (Fig. 19.9). Glucogenic amino acids get converted to intermediates of TCA cycle.

### Amphibolic Pathway

All other pathways, such as beta oxidation of fat or glycogen synthesis are either catabolic or anabolic. But TCA cycle is truly amphibolic (**both catabolic and anabolic**) in nature. (Greek, amphi = both). There is a continuous influx (pouring into) (Fig. 19.9) and a continuous efflux (removal) of 4-carbon units from the TCA cycle (Fig. 19.8). In a traffic circle, many roads converge and traffic flows towards one direction. Since various compounds enter into or leave from TCA cycle, it is sometimes called as “**metabolic traffic circle**”. Important anabolic reactions related with citric acid cycle are:

- Oxaloacetate is the precursor of aspartate
- Alpha ketogutarate can be made into glutamate
- Succinyl CoA is used for synthesis of heme
- Mitochondrial citrate is transported to cytoplasm, where it is cleaved into acetyl CoA, which then is the starting point of fatty acid synthesis (see Fig. 12.13).

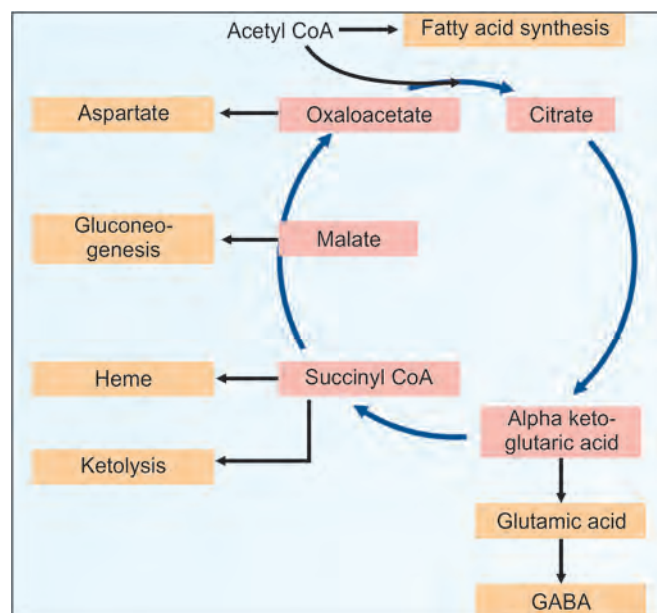


Fig. 19.8: Efflux of TCA cycle intermediates

## Anaplerotic Role of TCA Cycle

The citric acid cycle acts as a source of precursors of biosynthetic pathways, e.g. heme is synthesized from succinyl CoA and aspartate from oxaloacetate. To counterbalance such losses, and to keep the concentrations of the 4-carbon units in the cell, anaplerotic reactions are essential. This is called anaplerotic role of TCA cycle (Greek word, ana = up; plerotikos = to fill). Anaplerotic reactions are “filling up” reactions or “influx” reactions or “replenishing” reactions which supply 4-carbon units to the TCA cycle (Fig. 19.9). The important anaplerotic reactions are:

- Pyruvate to oxaloacetate by pyruvate carboxylase enzyme (Fig. 9.24). It needs ATP.
- Glutamate is transaminated to alpha keto glutarate; and aspartate to oxaloacetate. Other important amino acids entering the TCA cycle are shown in Figure 19.9.
- Pyruvate can be carboxylated to malate by NADP<sup>+</sup> dependent malic enzyme.

## REGULATION OF CITRIC ACID CYCLE

### Citrate and Citrate Synthase

The formation of citrate from oxalo acetate and acetyl CoA is an important part of control (step 1, Fig. 19.5). ATP

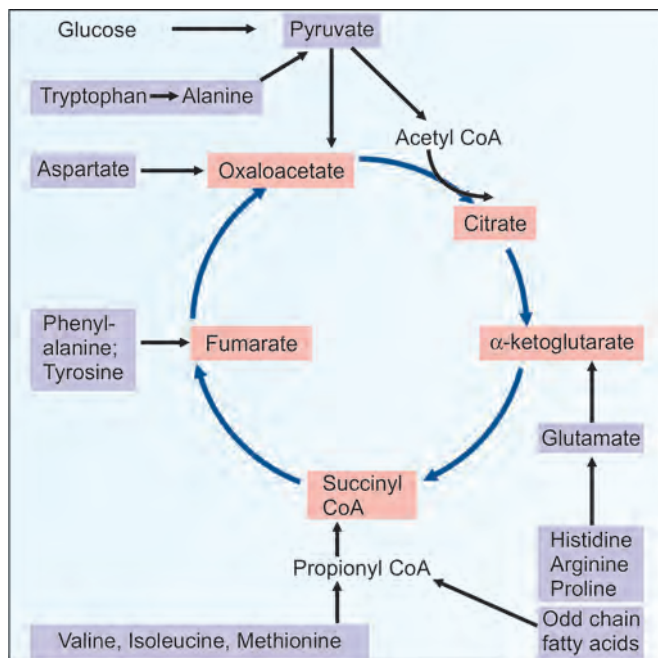


Fig. 19.9: Influx of TCA cycle intermediates

acts as an allosteric inhibitor of citrate synthase. Citrate allosterically inhibits PFK, the key enzyme of glycolysis; stimulates fructose-1,6-bisphosphatase, a key enzyme of gluconeogenesis and activates acetyl CoA carboxylase, key enzyme of fatty acid synthesis.

### Availability and Cellular Need of ATP

When the energy charge of the cell is low, the cycle operates at a faster rate. **The cycle is tightly coupled to the respiratory chain providing ATP.** The Krebs cycle is the largest generator of ATP among metabolic pathways.

**Anaerobiasis** (hypoxia) will inhibit ETC, when NADH and FADH<sub>2</sub> are accumulated, which in turn will cause inhibition of TCA cycle.

### Isocitrate Dehydrogenase

Step 3, (Fig. 19.5). ADP acts as a positive modifier enhancing the binding of substrate. NADH is an inhibitor.

### Alpha Keto Glutarate Dehydrogenase

It is inhibited by succinyl CoA and NADH.

Regulation of the TCA cycle, like that of glycolysis, occurs at both the level of entry of substrates into the cycle as well as at the key reactions of the cycle. Fuel enters the TCA cycle primarily as acetyl-CoA. The generation of acetyl-CoA from carbohydrates is, therefore, a major control point of the cycle. This is the reaction catalyzed by the PDH complex.

The PDH complex is inhibited by acetyl CoA and NADH and activated by non-acetylated CoA (CoASH) and NAD<sup>+</sup>. The pyruvate dehydrogenase activities of the PDH complex are regulated by their state of phosphorylation. This modification is carried out by a specific kinase (PDH kinase) and the phosphates are removed by a specific phosphatase (PDH phosphatase). The phosphorylation of PDH inhibits its activity and, therefore, leads to decreased oxidation of pyruvate. PDH kinase is activated by NADH and acetyl CoA and inhibited by pyruvate, ADP, CoASH, Ca<sup>2+</sup> and Mg<sup>2+</sup>. The PDH phosphatase, in contrast, is activated by Mg<sup>2+</sup> and Ca<sup>2+</sup>.

Since three reactions of the TCA cycle as well as PDH utilize NAD<sup>+</sup> as co-factor, the cellular ratio of NAD<sup>+</sup>/NADH has a major impact on the flux of carbon through the TCA cycle.

Substrate availability can also regulate TCA flux. This occurs at the citrate synthase reaction as a result of reduced availability of oxaloacetate. Product inhibition also controls the TCA flux, e.g. citrate inhibits citrate synthase,  $\alpha$ -KGDH is inhibited by NADH and succinyl-CoA. The key enzymes of the TCA cycle are also regulated allosterically by Ca<sup>2+</sup>, ATP and ADP.

The operation of citric acid cycle has an obligatory requirement for Thiamine since both PDH and Alpha KGDH reactions require TPP as co-enzyme.

It is suggested at present that the enzymes of the TCA cycle are closely physically associated with one another, so that intermediates can pass from the active site of one enzyme to the next-channeling of substrate. A new term “metabolon” has been coined to indicate such arrangement of enzymes of a pathway.

## Inhibitors of TCA Cycle

The above-said mechanisms are physiological and regulatory in nature. But the following are toxic or poisonous (non-physiological) agents which inhibit the reactions. These are shown in Figure 19.5.

- A. **Aconitase** (citrate to aconitate) is inhibited by fluoroacetate. This is non-competitive inhibition.
- B. **Alpha ketoglutarate dehydrogenase** (alpha keto glutarate to succinyl CoA) is inhibited by Arsenite. This again is non-competitive inhibition.
- C. **Succinate dehydrogenase** (succinate to fumarate) is inhibited by malonate; this is competitive inhibition.

## Metabolic Defects Related to Krebs Cycle

Though extremely rare, some enzyme deficiency states have been found to affect the operation of TCA cycle. These are given in Table 19.3.

### Hypoxia Inducible Factor 1(HIF1)

HIF1 is a transcription factor. Normally it upregulates the enzymes and proteins that enhance glycolysis when the conditions are anaerobic, i.e. when oxygen availability is low (hypoxia). The hydroxylation and subsequent degradation of HIF1 in proteasomes prevents the stimulation of glycolysis; but if it is not degraded, glycolysis increases. The increased

rate of aerobic glycolysis in cancer cells (glucose $\rightarrow$ lactate) even in the presence of oxygen is mediated by HIF1.

The metabolic component of cancer (enhanced aerobic glycolysis) has been established as the abnormal activities of three enzymes of TCA cycle namely succinate dehydrogenase, fumarase and PDH kinase (the enzyme which phosphorylates PDH). The possibility of controlling the rate of proliferation of cancer cells at the metabolic component is being explored now.

## QUICK LOOK OF CHAPTER 19

1. Citric acid cycle is the final common oxidative pathway that oxidizes acetyl CoA to CO<sub>2</sub>. It also acts as a link between catabolic and anabolic pathways (amphibolic role).
2. Citric acid cycle is the source of reduced co-enzymes (that form substrate for respiratory chain) as well as precursors for synthesis of proteins and nucleotides (anaplerotic pathway).
3. The sources of acetyl CoA are pyruvate (from glycolysis) fatty acids (beta oxidation), and ketogenic amino acids.
4. All enzymes of the cycle are located inside the mitochondria.
5. 3 NADH molecules are generated in the cycle at steps 3, 4 and 8. One FADH<sub>2</sub> is formed at steps 6 and one GTP is formed at step 5.
6. Both the carbon atoms of acetyl CoA are removed as CO<sub>2</sub> at steps 3 and 4.
7. 10 molecules of ATP are produced per turn of the TCA cycle (1 FADH<sub>2</sub> = 1.5 ATP, 3 NADH = (3x2.5= 7.5 ATP, 1 GTP = 1 ATP). It is the main generator of ATP among metabolic pathways.
8. Alpha ketoglutarate dehydrogenase is the only irreversible step in the TCA cycle.
9. Oxaloacetate is the true catalyst, which enters and leaves the cycle unchanged.
10. Oxidation of fat (acetyl CoA) needs help of oxaloacetate whose major source is pyruvate (carbohydrates). In other words, fats are burnt in the fire of carbohydrates.
11. Fat cannot be converted to glucose, as Pyruvate to acetyl CoA is an irreversible step.
12. The TCA cycle is regulated by cellular need of ATP.
13. Deficiency of pyruvate dehydrogenase causes lactic acidosis and neurological disorders.

**TABLE 19.3:** Metabolic defects of oxidative metabolism

Enzymes	Reactions catalyzed	Abnormalities
Pyruvate dehydrogenase	Pyruvate $\rightarrow$ acetyl CoA	Lactic acidosis Neurological disorders
Acyl CoA-dehydrogenase	Fatty acylCoA $\rightarrow$ alpha, beta-unsaturated fatty acyl CoA	Organic aciduria, glutaric aciduria, acidosis, hypoglycemia Electron flow from FAD $\rightarrow$ CoQ affected
Pyruvate carboxylase	Pyruvate $\rightarrow$ Oxaloacetate	Oxaloacetate needed for sparking TCA cycle is deficient. Lactic acidosis, hyperammonemia and hyperalaninemia

# CHAPTER 20

## Biological Oxidation and Electron Transport Chain

### Chapter at a Glance

The reader will be able to answer questions on the following topics:

- Redox potentials
- Biological oxidation
- Enzymes and co-enzymes
- High energy compounds
- Organization of electron transport chain
- Chemiosmotic theory
- Proton pump
- ATP synthase
- Inhibitors of ATP synthesis

### Stages of Oxidation of Foodstuffs

#### First Stage

Digestion in the gastrointestinal tract converts the macromolecules into small units. For example, proteins are digested to amino acids. This is called **primary metabolism** (Fig. 20.1).

#### Second Stage

The products of digestion are absorbed, catabolized to smaller components, and ultimately oxidized to  $\text{CO}_2$ . The reducing equivalents are mainly generated in the mitochondria by the final common oxidative pathway, citric acid cycle. In this process,  $\text{NADH}$  and  $\text{FADH}_2$  are generated. This is called **secondary or intermediary metabolism**.

#### Third Stage

These reduced equivalents ( $\text{NADH}$  and  $\text{FADH}_2$ ) enter into the **electron transport chain (ETC)**, or **Respiratory chain**,

where energy is released. This is the **tertiary metabolism** or **Internal respiration** or cellular respiration (Fig. 20.1). The energy production by complete oxidation of one molecule of glucose is 2850 kJ/mol and that of palmitate is 9781 kJ/mol. This energy is then used for synthetic purpose in the body (Fig. 20.2).

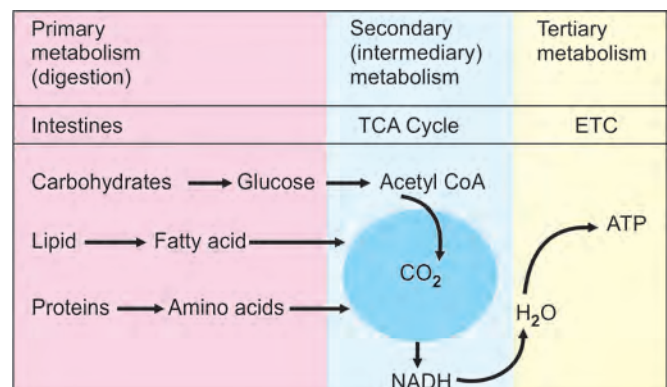


Fig. 20.1: Oxidation of foodstuffs in three stages



**Phototrophs** harvest the energy of light (plants). **Chemotrophs** harvest energy from oxidation of fuel molecules. Principles of bioenergetics and thermodynamics are described in Chapter 1.

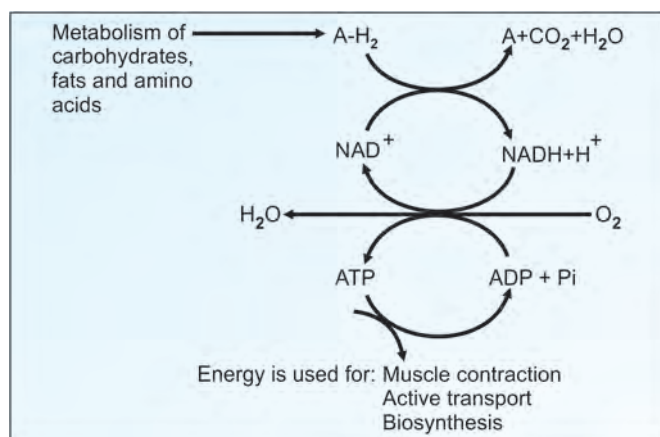
## REDOX POTENTIALS

Redox potential of a system is the electron transfer potential  $E_0'$ . **Oxidation is defined as the loss of electrons and reduction as the gain in electrons.** When a substance exists both in the reduced state and in the oxidized state, the pair is called a **redox couple**.

The redox potential of this couple is estimated by measuring the electromotive force (EMF) of a sample half cell connected to a standard half cell. The sample half cell contains one molar solution each of the reductant and oxidant. The **reference standard** half cell has 1 M  $H^+$  solution in equilibrium with hydrogen gas at one atmosphere pressure. The reference half cell has a reduction potential of zero mV.

### Negative and Positive Redox Potential

When a substance has lower affinity for electrons than hydrogen, it has a negative redox potential. If the substance has a positive redox potential, it has a higher affinity for electrons than hydrogen. Thus NADH, a strong reducing agent, has a negative redox potential ( $-0.32\text{ V}$ ), whereas a strong oxidant like oxygen has a positive redox potential ( $+0.82\text{ V}$ ). Table 20.1 gives the redox potentials of some of the important redox couples of the biological system. A summary is shown in Box 20.1.



**Fig. 20.2:** ATP generation. Food is catabolized; energy from food is trapped as ATP; it is then used for anabolic reactions

## Substrate Level Phosphorylation

Here energy from a high energy compound is directly transferred to nucleoside diphosphate to form a triphosphate without the help of electron transport chain, e.g.

- Bisphosphoglycerate kinase (see Fig. 9.11);
- Pyruvate kinase (see Fig. 9.13)
- Succinate thiokinase (see Fig. 19.2).

ATP generation is coupled with a more exergonic metabolic reaction.

## BIOLOGICAL OXIDATION

The transfer of electrons from the reduced co-enzymes through the respiratory chain to oxygen is known as biological oxidation. Energy released during this process is trapped as ATP. This coupling of oxidation with phosphorylation is called **oxidative phosphorylation**. In the body, this oxidation is carried out by successive steps of **dehydrogenations**.

### Electron Transport Chain

The electron flow occurs through successive dehydrogenase enzymes, together known as electron transport chain (ETC). **The electrons flow from electronegative potential ( $-0.32$ ) to electropositive potential ( $+0.82$ ).** A summary is shown in Figure 20.13.

**TABLE 20.1:** Redox potentials

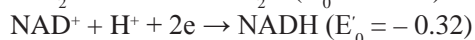
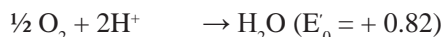
Oxidant	Reductant	$E_0'$ (in V)
$NAD^+$	$NADH + H^+$	$-0.32$
Cytochrome $b^{+++}$	Cytochrome $b^{++}$	$+0.07$
Co-enzyme Q	Coenzyme $QH_2$	$+0.10$
Cytochrome $c^{+++}$	Cytochrome $c^{++}$	$+0.22$
Cytochrome $a^{+++}$	Cytochrome $a^{++}$	$+0.29$
$O_2 + 2H$	$H_2O$	$+0.82$

### Box 20.1: Summary of bioenergetics

- Free energy** is a measure of the energy available to perform useful work
- $\Delta G$  can predict the direction of a chemical reaction
- Chemical reactions can be coupled, which allows an energetically unfavorable reaction to conclusion
- $\Delta G$  measured under physiological conditions may be different from that at a standard state.

## Energetics of Oxidative Phosphorylation

The  $E'_0$  and  $G^0$  of biological oxidation may be calculated as follows:



When these two equations are computed;



$$\Delta G^0 = -nF E'_0 = -2 \times 23.06 \times 1.14 = -52.6 \text{ kcal/mol}$$

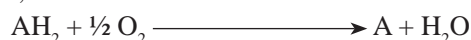
The free energy change between  $\text{NAD}^+$  and water is equal to 53 kcal/mol. This is so great that, if this much energy is released at one stretch, body cannot utilize it. Hence, with the help of ETC assembly, the total energy change is released in small increments so that energy can be trapped as **chemical bond energy, ATP** (Fig.20.2).

## ENZYMES AND CO-ENZYMES

All the enzymes involved in this process of biological oxidation belong to the major class of oxidoreductases. They can be classified into the following 5 headings:

### Oxidases

These enzymes catalyze the removal of hydrogen from substrates, but only **oxygen can act as acceptor** of hydrogen, so that water is formed.



This group includes **Cytochrome oxidase** (terminal component of ETC), tyrosinase, polyphenol oxidase, catechol oxidase and monoamine oxidase.

### Aerobic Dehydrogenases

These enzymes catalyze the removal of hydrogen from a substrate, but oxygen can act as the acceptor. These enzymes are flavoproteins and the product is usually **hydrogen peroxide**.



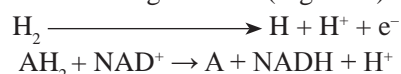
These flavoproteins contain either **FMN or FAD** as prosthetic group. Examples are L-amino acid oxidase which catalyzes the oxidative deamination of L-amino acids (see Chapter 15) and Xanthine oxidase (see Chapter 43).

### Anaerobic Dehydrogenases

These enzymes catalyze the removal of hydrogen from a substrate but **oxygen cannot** act as the hydrogen acceptor. They therefore require co-enzymes as acceptors of the

hydrogen atoms. When the substrate is oxidized, the co-enzyme is reduced.

- a.  **$\text{NAD}^+$  linked dehydrogenases:**  $\text{NAD}^+$  is derived from nicotinic acid, a member of the vitamin B complex (see Chapter 37). When the  $\text{NAD}^+$  accepts the two hydrogen atoms, one of the hydrogen atoms is removed from the substrate as such. The other hydrogen atom is split into one hydrogen ion and one electron. The electron is also accepted by the  $\text{NAD}^+$  so as to neutralize the positive charge on the co-enzyme molecule. The remaining hydrogen ion is released into the surrounding medium (Fig. 20.3).



The  $\text{NAD}^+$  linked dehydrogenases are (Fig. 20.13):

- Glyceraldehyde-3-phosphate dehydrogenase
  - Isocitrate dehydrogenase
  - Malate dehydrogenase
  - Glutamate dehydrogenase
  - Beta hydroxyacyl CoA dehydrogenase
  - Pyruvate dehydrogenase
  - Alpha ketoglutarate dehydrogenase.
- b.  **$\text{NADP}^+$  linked dehydrogenases:**  $\text{NADPH}$  cannot be oxidized with concomitant production of energy.  $\text{NADPH}$  is used in **reductive biosynthetic** reactions like fatty acid synthesis and cholesterol synthesis. An example of  $\text{NADPH}$  linked dehydrogenase is the glucose-6-phosphate dehydrogenase (see Fig. 10.11)
- c.  **$\text{FAD}$ -linked dehydrogenases:** When  $\text{FAD}$  is the co-enzyme, (unlike  $\text{NAD}^+$ ), both the hydrogen atoms are attached to the flavin ring. Examples:
- Succinate dehydrogenase (see step 6, Fig. 19.2)
  - Fatty acyl CoA dehydrogenase (see Fig. 12.9)
  - Glycerolphosphate dehydrogenase (Fig. 20.6)
- d. **Cytochromes:** All the cytochromes, except cytochrome oxidase, are anaerobic dehydrogenases. (Cytochrome oxidase is an oxidase, see above).

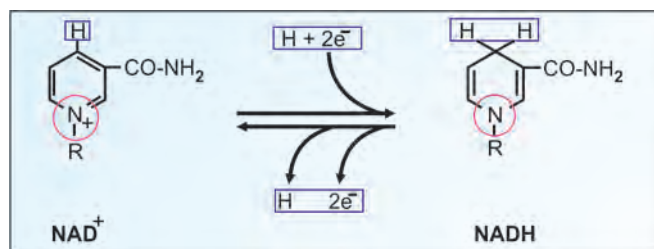
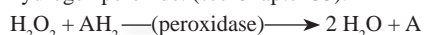


Fig. 20.3:  $\text{NAD}^+$  accepts  $\text{H}_2$

All cytochromes are hemoproteins having iron atom. Cytochrome b, cytochrome c1, and cytochrome c are in mitochondria while cytochrome P-450 and cytochrome b5 are in endoplasmic reticulum.

### Hydroperoxidases

- a. **Peroxidase:** Examples of peroxidases are glutathione peroxidase in RBCs (a selenium containing enzyme), leukocyte peroxidase and horse radish peroxidase. Peroxidases remove free radicals like hydrogen peroxide. (see Chapter 33).

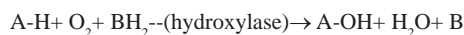


- b. **Catalase:** Catalases are hemoproteins. Peroxisomes are subcellular organelles having both aerobic dehydrogenases and catalase.



### Oxygenases

- a. **Mono-oxygenases:** These are otherwise called mixed function oxidases. Here, one oxygen atom is incorporated into the substrate and the other oxygen atom is reduced to water. These enzymes are also called **hydroxylases** because OH group is incorporated into the substrate.



i. Phenylalanine hydroxylase

ii. Tyrosine hydroxylase

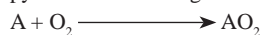
iii. Tryptophan hydroxylase (see Chapter 18)

iv. **Microsomal** cytochrome P-450 mono-oxygenase is concerned with **drug metabolism**.

v. **Mitochondrial** cytochrome P-450 mono-oxygenase. The figure "450" denotes that it absorbs light at 450 nm, when the heme combines with carbon monoxide. It is required for steroid hydroxylation in adrenal cortex, testis and ovary.

v. Nitric oxide synthase (see Chapter 17)

- b. **Di-oxygenases:** They are enzymes which incorporate both atoms of a molecule of oxygen into the substrate, e.g. tryptophan pyrrolase and homogentisic acid oxidase (see Chapter 18).



## HIGH ENERGY COMPOUNDS

These compounds when hydrolyzed will release a large quantity of energy, that is, they have a large  $\Delta G^{0'}$ . The



Karl  
Lohmann  
1898–1978



Fritz Lipmann  
NP 1953  
1899–1986



Alexander Todd  
NP 1957  
1907–1997

high energy bond in compounds is usually indicated by a squiggle bond (~). The free energy of hydrolysis  $\Delta G^{0'}$  of an ordinary bond varies from  $-1$  to  $-6$  kcal/mol. For example, glucose-6-phosphate has a free energy of only 13.8 kJ/mol ( $-3.3$  kcal/mol). On the other hand, the free energy of high energy bonds varies from  $>25$  kJ/mol ( $-7$  to  $-15$  kcal/mol). High energy compounds are listed in Table 20.2.

### Adenosine Triphosphate (ATP)

- ATP is the **universal currency of energy** within the living cells. Structure of ATP is shown in Fig. 5.3.
- The hydrolysis of ATP to ADP (under standard conditions) releases  **$-30.5$  kJ/mol or  $-7.3$  kcal/mol** ( $\Delta G^{0'} = -7.3$ ). The energy in the ATP is used to drive all endergonic (biosynthetic) reactions. The energy efficiency of the cell is comparable to any machine so far invented. ATP captures the chemical energy

**TABLE 20.2: High-energy compounds**

Energy rich compound	Energy release in kJ/mol	$\Delta G^{0'}$ in kcal/mol
Phosphate Compounds		
1. Nucleotides: (ATP, GTP, UTP, UDP-glucose)		
ATP to AMP + PPi	- 45.6 kJ	-10.7 kcal
ATP to ADP + Pi	- 30.5	- 7.3
2. Creatine phosphate		
	- 43.1	-10.5
3. Arginine phosphate		
4. 1,3-bisphosphoglycerate		
	- 49.4	-10.1
5. Phosphoenolpyruvate		
	- 61.9	-14.8
6. Inorganic pyrophosphate		
		- 7.3
7. Carbamoyl phosphate		
	- 51.4	-12.3
8. Aminoacyl adenylate (aminoacyl AMP)		
Sulfur Compounds		
9. CoA derivatives:		
Acetyl CoA		- 7.5
Succinyl CoA		
Fatty acyl CoA		
HMG CoA		
10. S-adenosyl methionine (SAM)		
		- 7.0
11. Adenosine phosphosulfate (active sulfate)		

released by the combustion of nutrients and transfers it to synthetic reactions that require energy.

- iii. At rest,  $\text{Na}^+\text{-K}^+$ -ATPase (see Chapter 2) uses up one-third of all ATP formed. Other energy requiring processes are, biosynthesis of macromolecules, muscle contractions, cellular motion using kinesin, dyenin etc.
- iv. ATP is continually being hydrolyzed and regenerated. An average person at rest consumes and regenerates ATP at a rate of approximately 3 molecules per second, i.e. about 1.5 kg/day!

At this juncture, it is interesting to review different types of reactions undergone by ATP.

1.  $\text{Glucose} + \text{ATP} \rightarrow \text{Glucose-6-phosphate} + \text{ADP}$   
Here ATP is hydrolyzed to ADP level and phosphate is incorporated in the product.
2.  $\text{Pyruvate} + \text{CO}_2 + \text{ATP} \rightarrow \text{Oxaloacetate} + \text{ADP} + \text{Pi}$   
Here ATP is hydrolyzed to ADP level, but phosphate is released.
3.  $\text{Fatty acid} + \text{CoA} + \text{ATP} \rightarrow \text{Fatty acyl CoA} + \text{AMP} + \text{PPi}$   
The ATP is hydrolyzed to AMP level, but pyrophosphate is released.
4.  $\text{Ribose-5-P} + \text{ATP} \rightarrow \text{Phosphoribosyl pyrophosphate} + \text{AMP}$   
Although ATP is hydrolyzed to AMP level, the pyrophosphate is added to the substrate.
5.  $\text{Amino acid} + \text{ATP} \rightarrow \text{Aminoacyl adenylate} + \text{PPi}$   
Here AMP group is incorporated into the product.
6.  $\text{Methionine} + \text{ATP} \rightarrow \text{S-adenosyl methionine} + \text{PPi} + \text{Pi}$   
Here adenosyl group is incorporated into the product.

Cyrus Fiske and Yellapragada Subbarao discovered ATP in 1929; Karl Lohmann showed its importance in muscle contraction in 1929. In 1941, Fritz Lipmann (Nobel prize, 1953) showed that ATP is the universal carrier of chemical energy in the cell and coined the expression “energy rich phosphate bonds”. Alexander Todd (Nobel Prize 1957) elucidated its structure.

## Creatine Phosphate

Phosphocreatine (Creatine phosphate or CP) provides a high energy reservoir of ATP to regenerate ATP rapidly by the Lohmann’s reaction, catalyzed by creatine kinase.

$\text{ATP} + \text{Creatine} \rightarrow \text{Phosphocreatine} + \text{ADP} + \Delta G^\circ$   
43.1 kJ/mol (–10.5 kCal/mol).

The reaction is mitochondrial and of special significance in the myocardium which has a high energy



Yellapragada Subbarao (1895–1948). His article is the 4th most cited paper in the world literature. Born in Andhra Pradesh, he studied medicine in Madras, and conducted research at USA. He discovered ATP, assayed phosphates and isolated tetracyclins and many other drugs.

requirement, about 6 kg of ATP per day. Energy transfer to the heart’s myofibrils is by creatine kinase energy shuttle, since being a smaller molecule than ATP, CP can rapidly diffuse from the myocardium to the myofibrils.

## Structure of Mitochondrion

The electron transport chain is functioning inside the mitochondria. The mitochondrion is a subcellular organelle having the outer and inner membranes enclosing the matrix (Fig. 20.4). The inner membrane is highly selective in its permeability, containing specific transport proteins. Certain enzymes are specifically localized in mitochondria (Table 20.3). The **inner membrane** contains the respiratory chain and translocating systems. The knob like protrusions represent the ATP synthase system (Fig. 20.4).

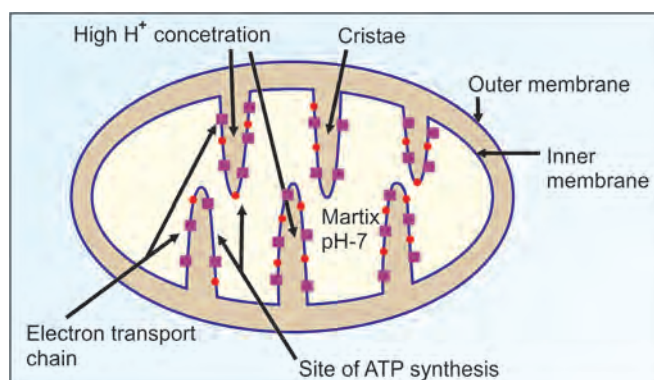


Fig. 20.4: Mitochondria

TABLE 20.3: Location of enzymes in mitochondria

<b>Mitochondria, outer membrane:</b>
Monoamino oxidase
Acyl CoA synthetase
Phospholipase A2
<b>In between outer and inner membrane:</b>
Adenylate kinase
Creatine kinase
<b>Inner membrane, outer surface:</b>
Glycerol-3-phosphate dehydrogenase
<b>Inner membrane, inner surface:</b>
Succinate dehydrogenase
Enzymes of respiratory chain
<b>Soluble matrix:</b>
Enzymes of citric acid cycle
Enzymes of beta oxidation of fatty acid



Inner and outer mitochondrial membrane differs greatly in their composition. Inner membrane is 22% cardiolipin and contains no cholesterol, whereas outer membrane is similar to cell membrane, with less than 3% cardiolipin and 45% cholesterol.

## ORGANIZATION OF ELECTRON TRANSPORT CHAIN

- In the Electron transport chain, or respiratory chain, the electrons are transferred from NADH to a chain of electron carriers. The electrons flow from the more electronegative components to the more electropositive components.
- All the components of electron transport chain (ETC) are located in the **inner membrane of mitochondria**.
- There are four distinct multi-protein complexes; these are named as **complex-I, II, III and IV**. These are connected by two mobile carriers, **co-enzyme Q** and **cytochrome c**.
- The arrangement is schematically represented in Figure 20.7. The sequence of reaction is depicted in Box 20.2.

## NADH Generation

The NADH is generated during intermediary metabolism (Fig. 20.13). A detailed list of the reactions using NADH is given in Box 37.3.

### Malate Aspartate Shuttle

**Mitochondrial membrane is impermeable to NADH.** The NADH equivalents generated in glycolysis are therefore to be transported from cytoplasm to mitochondria for oxidation. This is achieved by malate-aspartate shuttle or malate shuttle, which operates mainly in liver, kidney and heart. The cycle is operated with the help of enzymes **malate dehydrogenase (MDH)** and **aspartate aminotransferase** (Fig. 20.5). From one molecule of NADH in the mitochondria, 2½ ATP molecules are generated.

### Glycerol-3-phosphate Shuttle

In skeletal muscle and brain, the reducing equivalents from cytoplasmic NADH are transported to mitochondria as FADH<sub>2</sub> through glycerol-3-

#### Box 20.2: Summary of electron flow in ETC

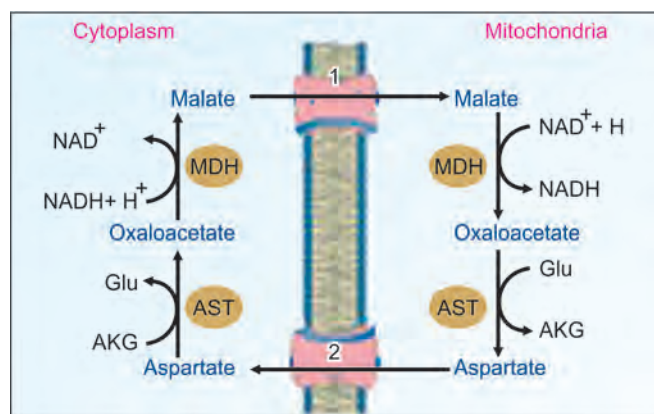
Complex I: NADH → FMN → Fe-S → Co Q →  
 Complex II: Succinate → FAD → Fe-S → Co Q →  
 Complex III: Co Q → Fe-S → cyt.b → cyt.c1 → cyt. c  
 Complex IV: Cyt. c → cyt a-a3 → O<sub>2</sub>

phosphate shuttle (Fig. 20.6). Hence **only 1½ATPs are generated** when this system is operating.

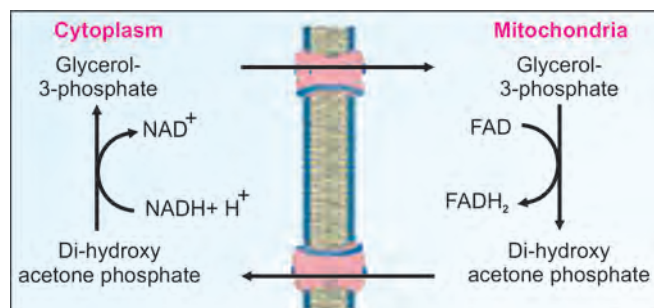
## ETC Complex-I

- It is also called **NADH-CoQ reductase or NADH dehydrogenase complex**. It is tightly bound to the inner membrane of mitochondria.
- It contains a flavoprotein (Fp), consisting of FMN as prosthetic group and an iron-sulfur protein (Fe-S). NADH is the donor of electrons, FMN accepts them and gets reduced to FMNH<sub>2</sub> (Fig. 20.8). Two electrons and one hydrogen ion are transferred from NADH to the flavin prosthetic group of the enzyme.  

$$\text{NADH} + \text{H}^+ + \text{FMN} \rightarrow \text{FMNH}_2 + \text{NAD}^+$$
- The electrons from FMNH<sub>2</sub> are then transferred to Fe-S. The electrons are then transferred to co-enzyme Q (ubiquinone) (CoQ).
- Overall function of this complex is to collect the pair of electrons from NADH and pass them to CoQ. The reactions are shown in Figure 20.8.



**Fig. 20.5:** Mitochondrial transport of NADH by malate-aspartate shuttle MDH = malate dehydrogenase; AST = aspartate amino transferase; Glu= glutamic acid; AKG = alpha ketoglutaric acid; 1= malate transporter; 2=glutamate aspartate transporter



**Fig. 20.6:** Glycerol-3-phosphate shuttle in muscle and brain

- v. There is a large negative free energy change; the **energy released is 12 kcal/mol**. This is utilized to drive **4 protons** out of the mitochondria.

## Complex II or Succinate-Q-Reductase

The reaction in Complex-II is represented in Fig. 20.9. The electrons from  $\text{FADH}_2$  enter the ETC at the level of coenzyme Q. This step does not liberate enough energy to act as a proton pump. In other words, substrates oxidized by FAD-linked enzymes bypass complex-I.

The three major enzyme systems that transfer their electrons directly to ubiquinone from the FAD prosthetic group are:

- Succinate dehydrogenase, (see step 6, Fig. 19.2)
- Fatty acyl CoA dehydrogenase (see step 1, Fig. 12.9)
- Mitochondrial glycerol phosphate dehydrogenase (Fig. 20.6).

## Co-enzyme Q

- The ubiquinone (Q) is reduced successively to semi-quinone (QH) and finally to quinol ( $\text{QH}_2$ ).

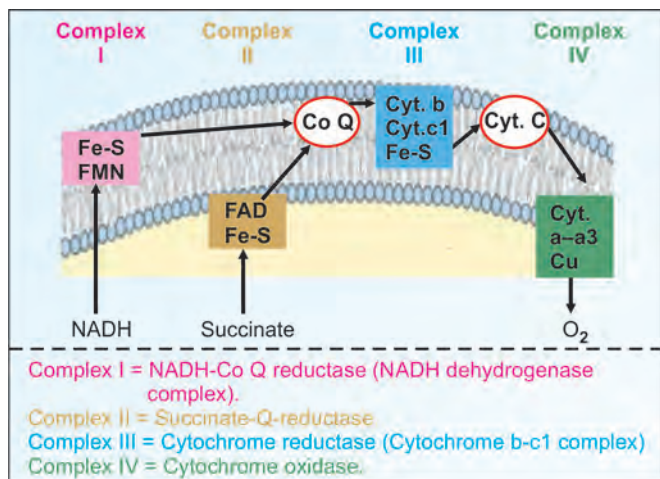


Fig. 20.7: Summary of electron flow

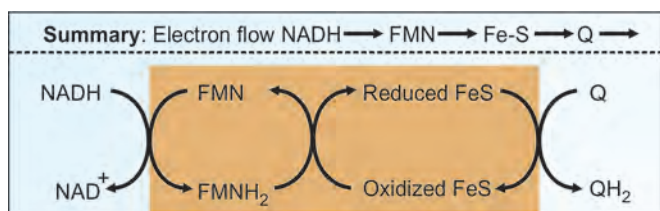


Fig. 20.8: Complex I or NADH-CoQ reductase (NADH dehydrogenase complex)

- It accepts a pair of electrons from  $\text{NADH}$  or  $\text{FADH}_2$  through complex-I or complex-II respectively (Figs 20.7 and 20.13).
- Co-enzyme Q is a quinone derivative having a long isoprenoid tail. The chain length of the tail is different in various species, mammals have 10 isoprene units (Fig. 20.10). Two molecules of cytochrome c are reduced.
- The **Q cycle** thus facilitates the switching from the two electron carrier ubiquinol to the single electron carrier cytochrome c.

## Complex III or Cytochrome Reductase

- This is a cluster of iron-sulfur proteins, **cytochrome b** and **cytochrome c1**, both contain **heme** prosthetic group. The sequence of reaction inside the Complex III is shown in Figure 20.11.
- During this process of transfer of electron, the iron in heme group shuttles between  $\text{Fe}^{3+}$  and  $\text{Fe}^{2+}$  forms.
- The free energy change is—10 kcal/mol; and **4 protons are pumped out**.

## Cytochrome c

It is a peripheral membrane protein containing one **heme** prosthetic group. The term cytochrome is derived from Greek,

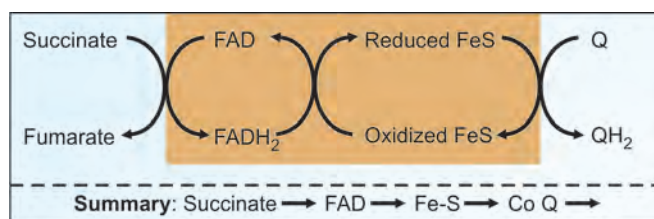


Fig. 20.9: Complex II; Succinate-Q-reductase

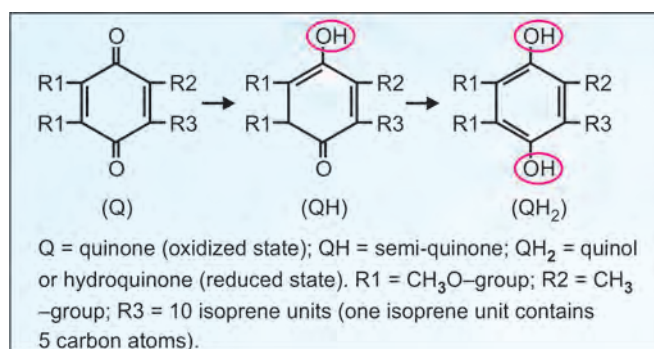


Fig. 20.10: Addition of  $\text{H}^+$  to co-enzyme Q

meaning cellular colors. It is one of the highly conserved proteins among different species. Axel Theorell (Nobel prize, 1955) isolated it. Cytochrome c collects electrons from Complex III and delivers them to Complex IV.

### Complex IV or Cytochrome Oxidase

- i. It contains different proteins, including **cytochrome a and cytochrome a3**. The Complex IV is tightly bound to the mitochondrial membrane.
- ii. The reaction is depicted in Figure 20.12. Four electrons are accepted from cytochrome c, and passed on to molecular oxygen.  

$$4 \text{H}^+ + \text{O}_2 + 4 \text{Cyt. c-Fe}^{2+} \rightarrow 2 \text{H}_2\text{O} + 4 \text{Cyt. c}^{3+}$$
- iii. **2 protons are pumped out** to the inter-membrane space.
- iv. Cytochrome oxidase has 4 redox centers, namely, a, a3, CuA and CuB. The electron transfer in this complex is as shown



Cytochrome oxidase contains two heme groups and two copper ions. The two heme groups are denoted as **cytochrome-a** and **cytochrome a-3**. The functional unit of the enzyme is a single protein, and is referred to as cytochrome **a--a3**.

The sequential arrangement of members of electron transport chain is shown in Box 20.2 and Fig. 20.13.

### P : O Ratio

The **P:O ratio** is defined as the number of inorganic phosphate molecules incorporated into ATP for every atom of oxygen consumed. When a pair of electrons from NADH reduces an atom of oxygen ( $\frac{1}{2} \text{O}_2$ ), 2.5 mol of ATP are formed per 0.5 mol of  $\text{O}_2$  consumed. In other words, the P:O ratio of NADH oxidation is 2.5; The P:O value of  $\text{FADH}_2$  is 1.5.

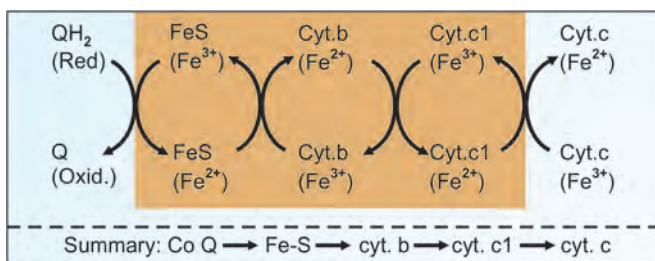


Fig. 20.11: Complex III or cytochrome reductase (cytochrome b-c1 complex) of respiratory chain

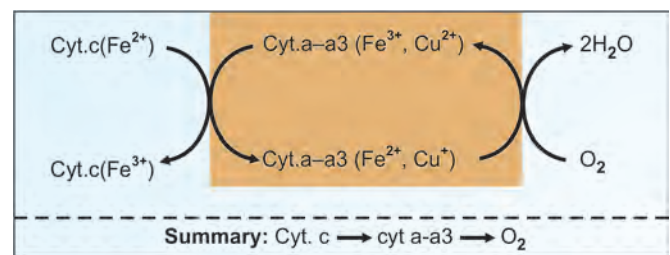


Fig. 20.12: Complex IV (cytochrome oxidase) of respiratory chain

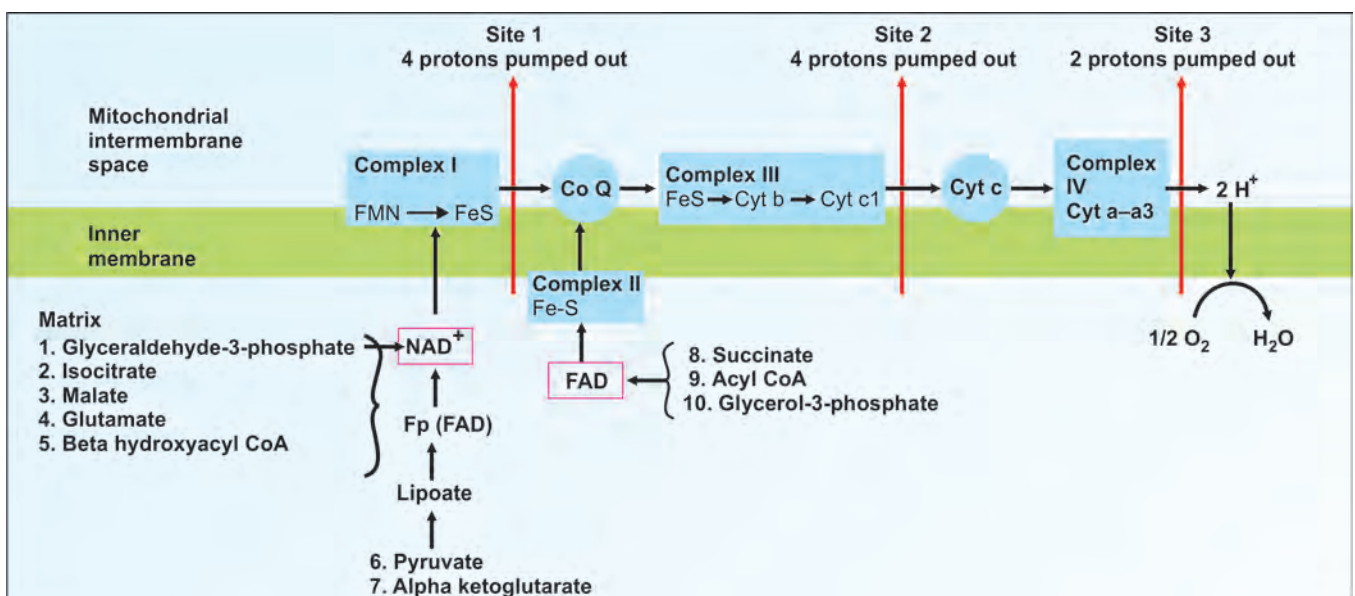


Fig. 20.13: Components and sequence of reactions of electron transport chain



## Current Concept, Energetics of ATP Synthesis

The free energy released by electron transport through complex I to IV must be conserved in a form that ATP synthase can perform energy coupling. The energy of electron transfer is used to drive protons out of the matrix by the complexes I, III and IV that are proton pumps. The proton gradient thus created is maintained across the inner mitochondrial membrane till electrons are transferred to oxygen to form water. The electrochemical potential of this gradient is used to synthesize ATP.

According to the estimated free energy of synthesis, it was presumed that around 3 protons are required per ATP synthesized. Hence, when one NADH transfers its electrons to oxygen, 10 protons are pumped out. This would account for the synthesis of approximately 3 ATP. Similarly the oxidation of 1  $\text{FADH}_2$  is accompanied by the pumping of 6 protons, accounting for 2 molecules of ATP. However, Peter Hinkle recently proved that the actual energy production is less, because there is always leakage of protons. This results in harnessing of energy required for the production of 2.5 ATP from NADH and 1.5 ATP from  $\text{FADH}_2$ .

The synthesis of one ATP molecule is driven by the flow of 3 protons through the ATP synthase (see below). When NADH is oxidized, 10 hydrogen ions (protons) are pumped out (Fig. 20.13). According to recent findings, one NADH may generate only 2.5 ATP; and one  $\text{FADH}_2$  may generate only 1.5 ATP. So, one molecule of glucose will generate only 32 ATPs. The traditional values and the new values are compared in Table 20.4. (Please note that there is no change in the values of ATP generation by substrate level phosphorylation).

Energy efficiency of glucose oxidation giving 32 molecules of ATP and palmitate giving 106 molecules of ATP is given as 34% and 33 % respectively.

**TABLE 20.4:** ATP generation, old and new values

ATP generation by oxidation of	Old value	Presently accepted
NADH	3	2.5
$\text{FADH}$	2	1.5
Glucose	38	32
Acetyl CoA	12	10
Palmitate	129	106

## Sites of ATP Synthesis

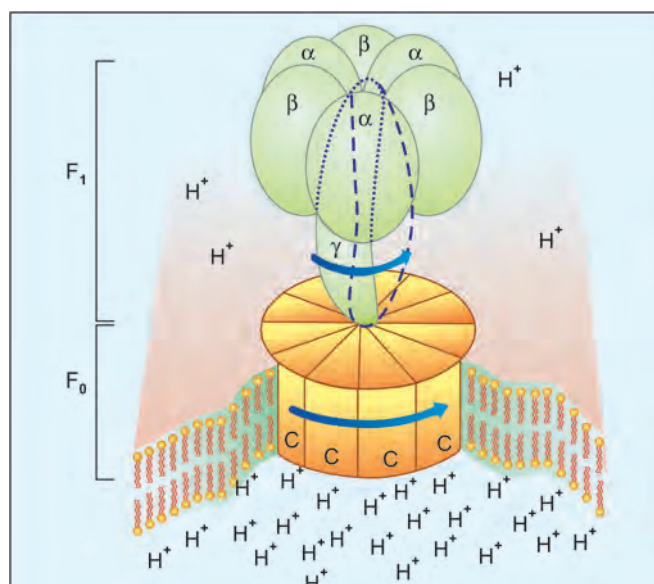
Traditionally, the sites of ATP synthesis are marked, as site 1, 2 and 3, as shown in Figure 20.13. But now it is known that ATP synthesis actually occurs when the proton gradient is dissipated, and not when the protons are pumped out (Fig. 20.15).

## CHEMIOSMOTIC THEORY

The coupling of oxidation with phosphorylation is termed **oxidative phosphorylation**. Peter Mitchell in 1961 (Nobel prize, 1978) proposed this theory to explain the oxidative phosphorylation. The transport of protons from inside to outside of inner mitochondrial membrane is accompanied by the generation of a proton gradient across the membrane. Protons ( $\text{H}^+$  ions) accumulate outside the membrane, creating an **electrochemical potential** difference (Fig. 20.15). This proton motive force drives the synthesis of ATP by ATP synthase complex (Fig. 20.14).

## Proton Pump and ATP Synthesis

The proton pumps (complexes I, III and IV) expel  $\text{H}^+$  from inside to outside of the inner membrane. So, there is high  $\text{H}^+$  concentration outside the inner membrane. This causes  $\text{H}^+$  to enter into mitochondria through the channels ( $\text{F}_0$ ); this proton influx causes ATP synthesis by ATP synthase. A summary is shown in Figure 20.15.



**Fig. 20.14:** ATP synthase. Protons from outside pass through the pore of  $\text{F}_0$  into the matrix, when ATP is synthesized



The pH outside the mitochondrial inner membrane is 1.4 units lower than inside. Further, outside is positive relative to the inside (+0.14 V) (Fig. 20.15). The proton motive force (PMF) is 0.224 V corresponding to a free energy change of 5.2 kcal/mol of protons.

## ATP Synthase (Complex V)

It is a protein assembly in the inner mitochondrial membrane. It is sometimes referred to as the **5th Complex** (Figs 20.14 and 20.15). Proton pumping ATP synthase (otherwise called F1-Fo ATPase) is a multisubunit transmembrane protein. It has two functional units, named as F1 and Fo. It looks like a *lollipop* since the membrane embedded Fo component and F1 are connected by a protein stalk.



Axel HT  
Theorell  
NP 1955  
1903–1982

Peter D  
Mitchell  
NP 1978  
1920–1992

Paul D  
Boyer  
NP 1997  
b. 1918

John E  
Walker  
NP 1997  
b. 1941

**Fo Unit:** The “o” is pronounced as “oh”; and not as “zero”. The “o” stands for **oligomycin**, as Fo is inhibited by oligomycin. Fo unit spans inner mitochondrial membrane. It serves as a proton channel, through which protons enter into mitochondria (Fig. 20.14). Fo unit has 4 polypeptide chains and is connected to F1. Fo is water insoluble whereas F1 is a water soluble peripheral membrane protein.

**F1 Unit:** It projects into the matrix. It catalyzes the ATP synthesis (Fig. 20.14). F1 unit has 9 polypeptide chains, (3 alpha, 3 beta, 1 gamma, 1 sigma, 1 epsilon). The alpha chains have binding sites for ATP and ADP and beta chains have catalytic sites. ATP synthesis requires  $Mg^{++}$  ions.

**Mechanism of ATP synthesis:** Translocation of protons carried out by the Fo catalyzes the formation of phospho-anhydride bond of ATP by F1. Coupling of the dissipation of proton gradient with ATP synthesis (oxidative phosphorylation) is through the interaction of F1 and Fo.

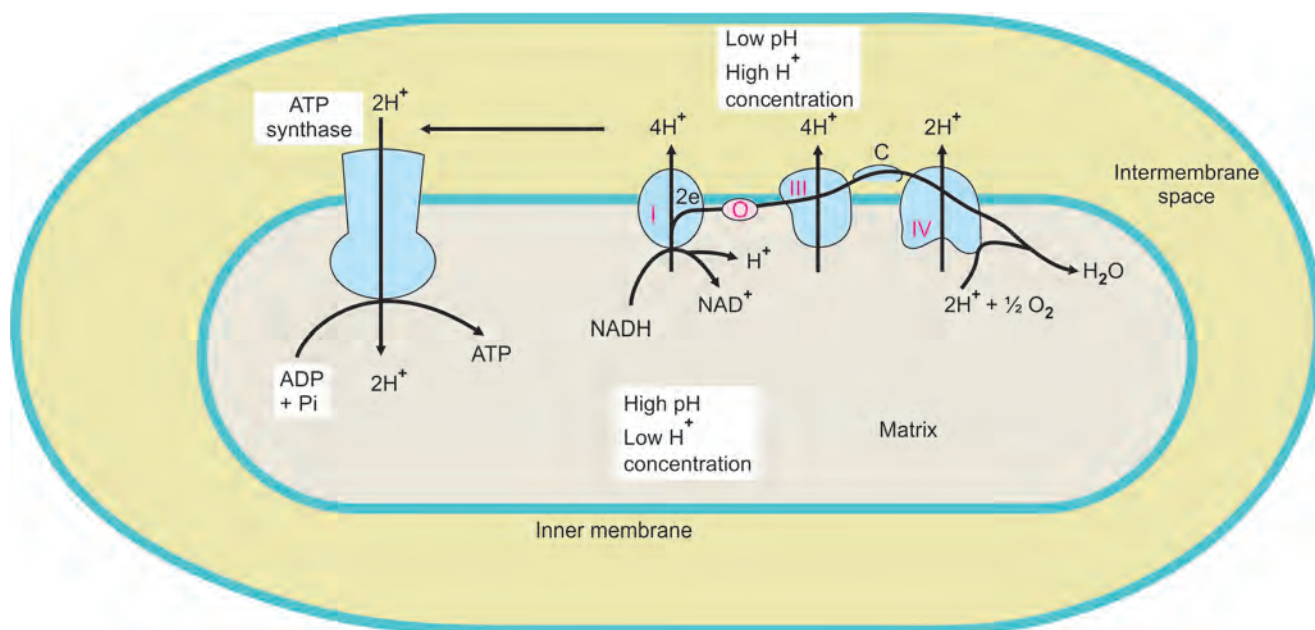
## Binding Change Mechanism

The **binding change mechanism** proposed by Paul Boyer (Nobel prize, 1997) explains the synthesis of ATP by the proton gradient. The ATP synthase is a “molecular machine”, comparable to a “water-driven hammer, minting coins”. Fo is the wheel; flow of protons is the waterfall and the structural changes in F1 lead to ATP coin being minted for each turn of the wheel. The F1 has 3 conformation states for the alpha-beta functional unit:

O state—Does not bind substrate or products

L state—Loose binding of substrate and products

T state—Tight binding of substrate and products



**Fig. 20.15:** Summary of ATP synthesis. One mitochondrion is depicted, with inner and outer membranes. ETC complexes will push hydrogen ions from matrix into the intermembrane space. So, intermembrane space has more  $H^+$  (highly acidic) than matrix. So, hydrogen ions tend to leak into matrix through Fo. Then ATPs are synthesized. I, II, III, IV = components of ETC

According to this theory, the three beta subunits (catalytic sites), are in three functional states: **O form** is open and has no affinity for substrates. **L form** binds substrate with sluggish affinity. **T form** binds substrate tightly and catalyzes ATP synthesis.

As protons translocate to the matrix, the free energy is released, and this is harnessed to interconvert these 3 states. The bond is synthesized in the T state and ATP is released in the O state. The sequence of events is as follows:

1. ADP and Pi bind to L binding site
2. L to T conversion is by energy driven conformational change that catalyzes the formation of ATP
3. T state reverts to O state when ATP is released
4. L state is regenerated for further ADP binding.

For the complete rotation of F1 head through the 3 states, 10 protons are translocated.

Protons entering the system, cause conformational changes in the F1 particle. Initially the ADP and Pi are loosely bound to the catalytic site on F1. As the Fo accepts protons, the affinity for ADP is increased (step 1, Fig. 20.16). Further conformational change induces catalytic activity, and ATP is synthesized (step 2, Fig. 20.16). This moves protons to the matrix side. As the ATPs are released, the original conformation of the enzyme is assumed (step 3, Fig. 20.16). Then ADP is again bound and the cycle repeats (step 4, Fig. 20.16). The energy surplus produced by the proton gradient is stored as chemical energy in ATP. The energy requiring step is not at the synthesis of ATP, but energy is required for the conformational changes.

## Regulation of ATP Synthesis

The **availability of ADP** regulates the process. When ATP level is low and ADP level is high, oxidative phosphorylation proceeds at a rapid rate. This is called **respiratory control** or acceptor control. The major source of NADH and FADH<sub>2</sub> is the citric acid cycle, the rate of which is regulated by the energy charge of the cell.

Since electron transport is directly coupled to proton translocation, the flow of electrons through the electron transport system is regulated by the magnitude of the PMF. The higher the PMF, the lower the rate of

electron transport, and vice versa. Under resting conditions, with a high cell energy charge, the demand for new synthesis of ATP is limited and, although the PMF is high, flow of protons back into the mitochondria through ATP synthase is minimal. When energy demands are increased, such as during vigorous muscle activity, cytosolic ADP rises and is exchanged with intramitochondrial ATP via the transmembrane adenine nucleotide carrier ADP/ATP translocase. Increased intramitochondrial concentrations of ADP cause the PMF to become discharged as protons pour through ATP synthase, regenerating the ATP pool. Thus, while the rate of electron transport is dependent on the PMF, the magnitude of the PMF at any moment simply reflects the energy charge of the cell. In turn the energy charge, or more precisely ADP concentration, normally determines the rate of electron transport by mass action principles.

## Inhibitors of ATP Synthesis

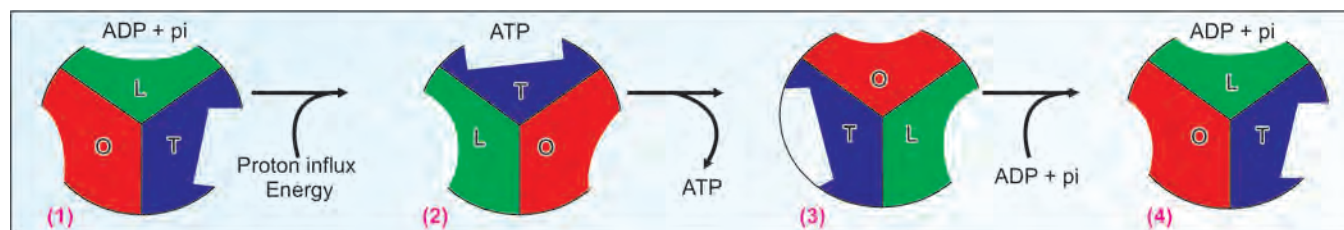
*Site Specific Inhibitors (Table 20.5; Fig. 20.17)*

*Inhibitors of Oxidative Phosphorylation*

- Attractyloside** inhibits the translocase whereas **oligomycin** inhibits the Fo (Table 20.5).
- Ionophores are lipid-soluble compounds that increase the permeability of lipid bilayers to certain ions. There are two types of ionophores; mobile ion carriers (e.g. **valinomycin**) and channel formers (e.g. **gramicidin**). Valinomycin allows potassium to permeate mitochondria and dissipate the proton gradient.
- The toxicity of cyanide is due to its inhibitory effect on the terminal cytochrome, which brings cellular respiration to a standstill.

*Uncouplers of Oxidative Phosphorylation*

Uncouplers will allow oxidation to proceed, but the energy instead of being trapped by phosphorylation is dissipated as heat. This is achieved by removal of the proton gradient. (Table 20.5; Fig. 20.17).



**Fig. 20.16:** The binding change mechanism for ATP synthase. F1 has 3 chemically identical but conformationally distinct functional states. "O" means open conformation with no affinity for substrates and is catalytically inactive. "L" binds ligands loosely and catalytically sluggish. "T" binds ligands tightly and catalytically active. 1= ADP and Pi binds to "L" site. Then energy dependent conformational change occurs. 2= ATP is synthesized; conformation is again changed. 3= ATP is released with conformation change. 4= old conformation regained and cycle continues

**TABLE 20.5:** Compounds which affect electron transport chain and oxidative phosphorylation

1. Complex I to Co-Q specific inhibitors
i. Alkylguanides (guanethide), hypotensive drug
ii. Rotenone, insecticide and fish poison
iii. Barbiturates (amobarbital), sedative
iv. Chlorpromazine, tranquilizer
v. Piericidin, antibiotic
2. Complex II to Co-Q
i. Carboxin
3. Complex III to cytochrome c inhibitors
i. BAL (British anti-lewisite), antidote of war gas
ii. Naphthoquinone
iii. Antimycin
4. Complex IV inhibitors
i. Carbon monoxide, inhibits cellular respiration
ii. Cyanide (CN <sup>-</sup> )
iii. Azide (N <sub>3</sub> <sup>-</sup> )
iv. Hydrogen sulfide (H <sub>2</sub> S)
5. Site between succinate dehydrogenase and Co-Q
i. Carboxin, inhibits transfer of ions from FADH <sub>2</sub>
ii. Malonate, competitive inhibitor of succinate DH
6. Inhibitors of oxidative phosphorylation
i. Atractyloside, inhibits translocase
ii. Oligomycin, inhibits flow of protons through Fo
iii. Ionophores, e.g. Valinomycin
7. Uncouplers
i. 2,4-dinitrophenol (2,4-DNP)
ii. 2,4-dinitrocresol (2,4-DNC)
iii. CCCP (chlorocarbonyl cyanide phenyl hydrazone)
8. Physiological uncouplers
i. Thyroxine, in high doses
ii. Thermogenin in brown adipose tissue

Sometimes, the uncoupling of oxidative phosphorylation is useful biologically. In hibernating animals and in newborn human infants, the liberation of heat energy is required to maintain body temperature. In **Brown adipose tissue**, thermogenesis is achieved by this process.

**Thermogenin**, a protein present in the inner mitochondrial membrane of adipocytes, provides an alternate pathway for protons. It is one of the uncoupling proteins (UCP).

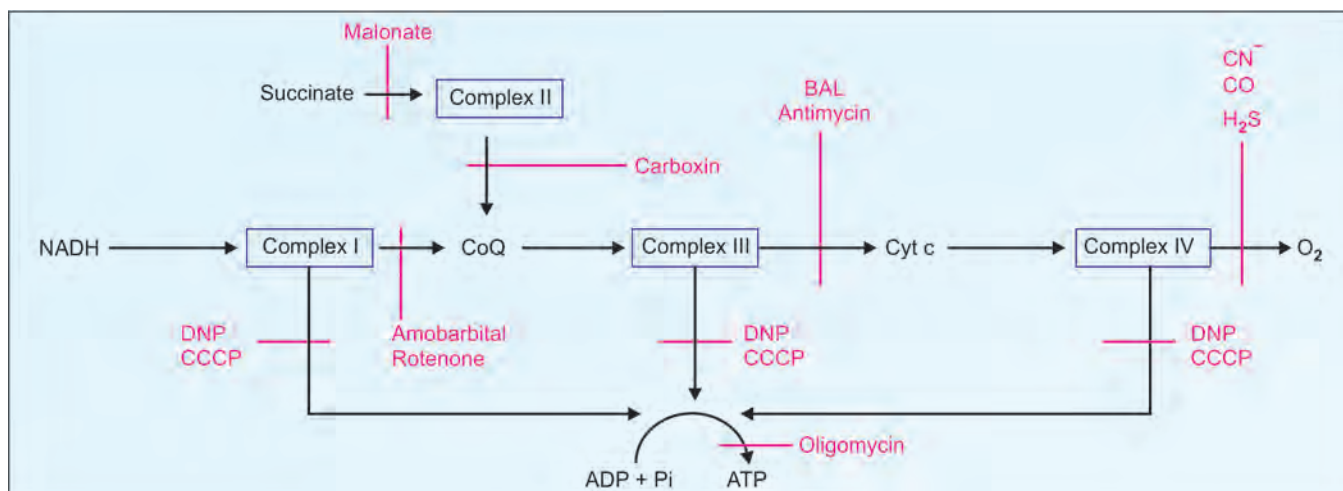
**Thyroxine** is also known to act as a physiological uncoupler.

### How does Shivering Produce Heat?

Shivering is due to muscle contraction, it increases ATP hydrolysis. During proton entry for ATP synthesis, electron transport chain is stimulated. Oxygen consumption increases as well as heat dissipation through electron transport chain.

### Brown Adipose Tissue and Heat Generation

The uncoupling of proton flow releases the energy of the electrochemical proton gradient as heat. This process is a normal physiological function of brown adipose tissue. Brown adipose tissue gets its color from the high density of mitochondria in the individual adipose cells. Newborn babies contain brown fat in their neck and upper back that serves the function of nonshivering thermogenesis. The muscle contractions that take place in the process of shivering not only generate ATP but also produce heat. Nonshivering thermogenesis is a hormonal stimulus for heat generation without the associate muscle contractions of shivering. The process of thermogenesis in brown fat is initiated by the release of free fatty acids from the triglycerides stored in the adipose cells.



**Fig. 20.17:** Inhibitors of electron transport chain and oxidative phosphorylation. Abbreviations are shown in Table 20.5

The mitochondria in brown fat contain a protein called **thermogenin** (also called uncoupling protein, UCP). Thermogenin acts as a channel in the inner mitochondrial membrane to control the permeability of the membrane to protons. When norepinephrine is released in response to cold sensation it binds to  $\alpha$ -adrenergic receptors on the surface of brown adipocytes triggering the activation of adenylate cyclase. Activated adenylate cyclase leads to increased production of cAMP and the concomitant activation of cAMP-dependent protein kinase (PKA) with the result being phosphorylation and activation of hormone-sensitive lipase. The released free fatty acids bind to thermogenin triggering dissipation of proton gradient. Phosphorylation is uncoupled from oxidation leading to release of the energy of the gradient as heat.

### Specific Inhibitors of ETC

**Doxorubicin** binds to cardiolipin, and directly affects oxidative phosphorylation. It inhibits succinate oxidation, inactivates cytochrome oxidase, interacts with CoQ, affects ion pumps and inhibits ATP synthase. This results in decreased ATP levels and mildly swollen mitochondria. It decreases the mitochondrial ability to sequester calcium ions and increases free radicals leading to mitochondrial membrane damage. It can also affect cardiac function by other mechanisms. End effect can be heart failure.

**Cyanide:** It is present in air as HCN and in soil and water as cyanide salts (NaCN). Most of the cyanide in air comes from vehicle exhausts. CNS is the prime target for cyanide toxicity. Acute ingestion of large amounts can lead to convulsions, coma and death following a brief period of CNS stimulation, whereas low amounts can lead to light headedness, breathlessness, dizziness, numbness and headaches. Basically it binds to  $Fe^{3+}$  ion in heme of cytochrome a-a3 component of cytochrome c oxidase.

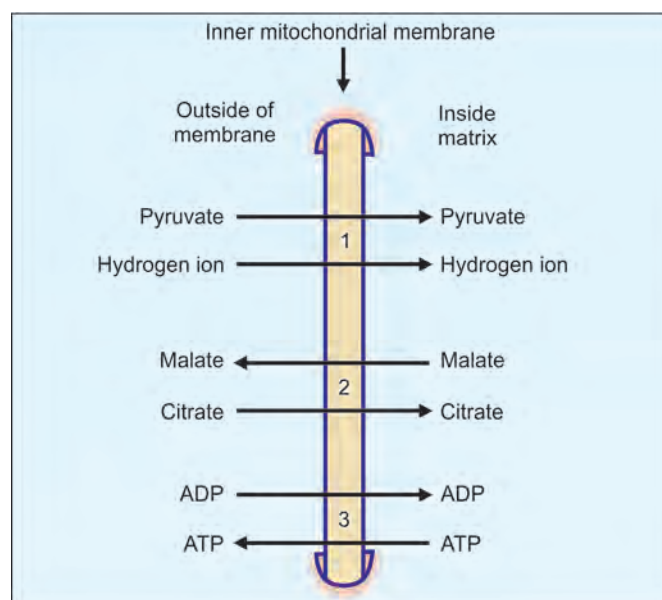
**Cassava** contains cyanogens, and improper processing of cassava can result in retention of higher levels of cyanogens and potential toxic effects. HCN is released from cyanogens by  $\beta$  glucosidases present in plants and intestinal bacteria. Small levels can be detoxified in the liver by rhodanase enzyme, and inactive thiocyanates are formed. Cyanoglycosides like amygdalin may also be found in edible plants, such as almonds, apricots, peaches, plums, cherries, sorghum, soybeans, spinach, lima beans, sweet potatoes, maize, millet, sugarcane and bamboo shoots.

### Mitochondrial Transport Systems

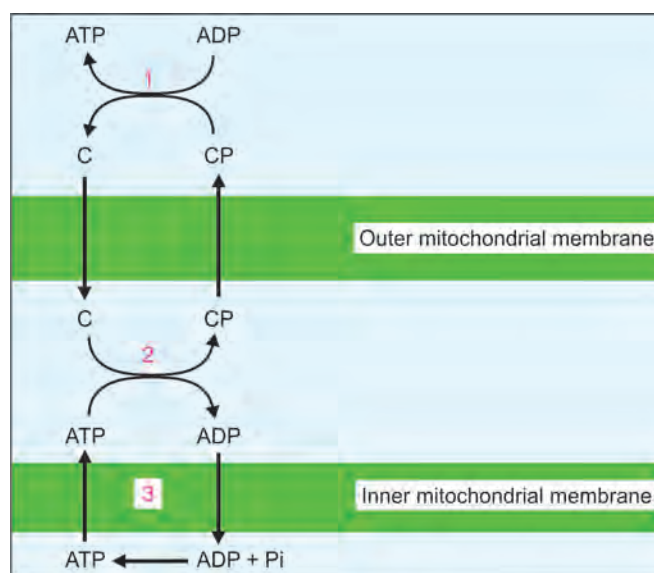
The inner membrane is highly selective in its permeability characteristics. So, there are several trans-membrane protein systems, to transport specific molecules in and out of the mitochondrial membrane. Some important transporters are shown in Figure 20.18. Pyruvate carrier is a symport system (pyruvate and hydrogen ions to same side). Tricarboxylate carrier is an antiport system, carrying malate and citrate in opposite directions (Fig. 20.18). Certain enzymes are specifically localized in mitochondria (Table 20.3).

### Creatine Phosphate Shuttle

ATP generated inside the mitochondria is brought outside the mitochondria by the creatine phosphate shuttle (Fig. 20.19). ATP is first transported through inner mitochondrial membrane by adenine nucleotide transporter. Then the high energy bond of ATP is exchanged with creatine by mitochondrial iso-enzyme of creatine phosphate. The creatine phosphate thus generated is then transported through the pores of outer mitochondrial membrane. Inside the cytoplasm, creatine phosphate is again exchanged with ATP by muscle iso-enzyme of creatine phosphate.



**Fig. 20.18:** Important mitochondrial membrane transporters  
1 = PYT (pyruvate transporter); 2 = TCT (tricarboxylate transporter);  
3 = ANT (adenine nucleotide transporter).



**Fig. 20.19:** Creatine phosphate shuttle

1 = CKm (muscle creatine kinase); 2 = CKmt (mitochondrial creatine phosphate); 3 = ANT (adenine nucleotide transporter);  
C = creatine; CP = creatine phosphate



## Diseases Associated with Mitochondria

Mitochondrial DNA is inherited cytoplasmically and is therefore **transmitted maternally** (see Table 46.6). OXPHOS (oxidative phosphorylation) diseases are described in Chapter 46. Mutations in mitochondrial DNA are responsible for the following diseases.

1. Lethal infantile mitochondrial ophthalmoplegia
2. Leber's hereditary optic neuropathy (LHON)
3. Myoclonic epilepsy
4. Mitochondrial encephalomyopathy lactic acidosis stroke like episodes (MELAS)

Unlike nuclear DNA, there are hundreds of copies of mitochondrial genes per cell (heteroplasmy). Leber's hereditary optic neuropathy is characterized by blindness in young males. It is caused by a single base mutation in NADH Coenzyme Q reductase. Streptomycin-induced deafness is also found to be due to a mutation in the mitochondrial rRNA.

## Mitochondrial Permeability Transition Pore (MPTP)

Cytochrome c is also the mediator of **apoptosis** (programmed cell death). Since cytochrome c is a peripheral membrane protein, it is loosely bound to mitochondria. So, it is released from the mitochondria when the mitochondrial membrane permeabilization (MMP) occurs. This can happen in response to an oxidant stress due to ROS, increase in calcium concentration in mitochondria or any other form of stress. As the membrane permeability increases, there is transient opening of a mitochondrial permeability transition pore (MPTP). However, if the injury is only transient, the pore closes.

But if the pore remains open, it results in dissipation of mitochondrial proton gradient, ATP depletion and release of cytochrome c. This Cytochrome c acts as a trigger for apoptosis by forming an **apoptosome complex** with other pro-apoptotic factors. The initiator caspase is then activated leading to activation of effector caspases, and finally the cell death (Fig. 20.20).

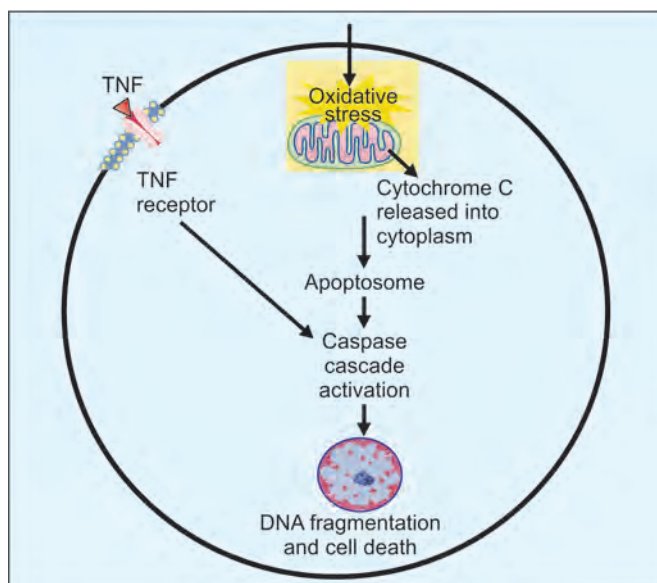


Fig. 20.20: Role of mitochondria in apoptosis

Reperfusion injury can also result from generation of ROS which leads to activation (opening) of MPTP and resultant events can lead to necrosis. In myocardial and cerebral ischemia, the core of the damaged tissue undergoes necrosis, but the surrounding tissue which is not initially damaged can undergo delayed apoptosis.

MPTP is located at the contact site between the inner and outer mitochondrial membranes. It is made up of **Voltage Dependent Anion Channel (VDAC)** located in the outer membrane, **Adenine Nucleotide Translocase (ANT)** located in the inner membrane and **Cyclophilin-D (CyP-D)**.

## Clinical Case Study 20.1

A 68-year-old female in a hypertensive crisis is being treated in the intensive care unit (ICU) with intravenous nitroprusside for 48 hours. The patient's blood pressure was brought back down to normal levels; however, she was complaining of a burning sensation in her throat and mouth followed by nausea and vomiting, diaphoresis, agitation, and dyspnea. An arterial blood gas revealed a significant metabolic acidosis. A serum test suggests a metabolite of nitroprusside, thiocyanate, is at toxic levels.

1. What is the likely cause of her symptoms?
2. What is the biochemical mechanism of this problem?
3. What is the treatment for this condition?

## Clinical Case Study 20.2

A 55-year-old man was treated in the ICU with intravenous nitroprusside for hypertensive crisis for 48 hours. BP was restored, but he had a burning sensation in his throat and mouth, followed by nausea and vomiting, excessive sweating, agitation and dyspnea. There was a sweet almond smell in his breath and arterial blood gas analysis revealed severe metabolic acidosis. What is the likely condition? How is it treated? What is the pathogenesis?

## Clinical Case Study 20.1 Answer

Diagnosis: Cyanide poisoning from toxic dose of nitroprusside.

Biochemical mechanism: Cyanide inhibits mitochondrial cytochrome oxidase, blocking electron transport and preventing oxygen utilization. Lactic acidosis results secondary to anaerobic metabolism.

Treatment: Supportive therapy, oxygen, and antidotal therapy with sodium nitrite, and sodium thiosulfate.

Clinical correlation: Malignant hypertension is diagnosed when there is elevated blood pressure (systolic levels of 220 mm Hg and/or diastolic blood pressures exceeding

120 mm Hg). The symptoms may include severe headache, neurological deficits, chest pain, or heart failure. Hypertensive emergencies require immediate lowering of the blood pressure to lower levels.

One hazard of abruptly lowering the blood pressure is causing hypotension and subsequent ischemia to the brain or heart. Sodium nitroprusside induces a smooth fall in blood pressure. One side effect of sodium nitroprusside is that its metabolite is thiocyanate, and with prolonged use, cyanide poisoning may result, which inhibits the electron transport chain. Thus, in clinical practice, short-term nitroprusside is used.

### Clinical Case Study 20.2 Answer

Patient is most probably suffering from cyanide poisoning. Cyanide inhibits mitochondrial cytochrome oxidase, blocks the electron transport chain and prevents oxygen utilization. Lactic acidosis is secondary to anaerobic metabolism. Cellular oxygen metabolism is impaired and can produce death within minutes. Nitroprusside therapy, which is the drug of choice for hypertensive emergency, on prolonged usage can produce cyanide poisoning. Hence, in clinical practice, nitroprusside is used only for short term.

Causes for cyanide poisoning include smoke inhalation from residential or industrial fires, metal trades, mining, electroplating, jewelry manufacture and X-ray film recovery. It can occur during fumigation of ships, warehouses, etc. and are also used commonly as suicidal agents, especially by terrorists and healthcare and laboratory workers. Cyanide affects all body tissues and attaches to many metalloenzymes, rendering them inactive.

Treatment includes administration of amyl nitrite, sodium nitrite and sodium thiosulfate, increasing oxygen concentration in inspired air and sodium bicarbonate therapy. Amyl and sodium nitrites induce methemoglobin formation, it combines with cyanide and reduces its toxicity. Sodium thiosulfate converts cyanide to thiocyanate and which is excreted in urine. Hydroxocobalamin combines

with cyanide to form cyanocobalamin which is excreted through urine. Sodium bicarbonate reduces lactic acidosis.

### QUICK LOOK OF CHAPTER 20

1. Oxidation of food stuff occurs in 3 stages—primary metabolism where macromolecules are converted to smaller units, secondary metabolism where reducing equivalents are formed and tertiary metabolism where energy is released.
2. Oxidation is loss of electrons and reduction is gain of electrons. A pair that exists in both oxidized and reduced state is a redox couple.
3. In substrate level phosphorylation, energy from high-energy compound is directly transferred to NDP to form NTP without the help of electron transport chain.
4. Transfer of electrons from reduced co-enzymes through respiratory chain to  $O_2$  is known as Biological Oxidation.
5. The energy released is trapped as ATP. This coupling of oxidation with phosphorylation is called Oxidative phosphorylation. All enzymes of biological oxidation are oxidoreductases.
6. Electron flow occurs through successive dehydrogenase enzymes (located in the inner mitochondrial membrane), together known as Electron Transport Chain; the electrons are transferred from higher to lower potential.
7. NADH is impermeable to mitochondrial membrane. Hence it is transferred via malate-aspartate shuttle in liver, kidney and heart as NADH reducing equivalents and in skeletal muscles as  $FADH_2$  through glycerol 3-phosphate shuttle.
8. The ETC has 4 distinct multiprotein complexes –viz; complex I, II, III and IV connected by two mobile carriers to Co Q and cytochrome c.
9. Inhibitors of oxidative phosphorylation include atractyloside and oligomycin. Cyanide inhibits terminal cytochrome and brings cellular respiration to stand still.

# CHAPTER 21

## Heme Synthesis and Breakdown

### Chapter at a Glance

The reader will be able to answer questions on the following topics:

- Structure of heme
- Biosynthesis of heme
- Porphyrins
- Bilirubin metabolism
- Plasma bilirubin
- Jaundice

Red blood cells (RBC) are biconcave discs, with a diameter of about 7 microns. RBCs live for about 120 days in peripheral circulation, during which time they traverse about 160 km! In a 70 Kg person, there will be about  $25 \times 10^{12}$  RBCs and 750 g of hemoglobin (Hb). 100 ml blood contains about **14.5 g of Hb**. Mature RBC is non-nucleated; **have no mitochondria and does not contain TCA cycle enzymes**. However, the glycolytic pathway is active which provides energy and 2, 3-bisphosphoglycerate (2, 3-BPG). The HMP shunt pathway provides the NADPH. Human **erythropoietin**, a glycoprotein with molecular weight of 34 kD, is the major stimulator of erythropoiesis. It is synthesized in kidney and is released in response to hypoxia. RBC formation in the bone marrow requires amino acids, iron, copper, folic acid, vitamin B12, vitamin C, pyridoxal phosphate, and pantothenic acid; they are used as hematinics in clinical practice.

### STRUCTURE OF HEME

Hemoglobin is a **conjugated protein** having heme as the prosthetic group and the protein, globin. It is a tetrameric protein with 4 subunits, each subunit having a prosthetic heme group and the globin polypeptide.

The polypeptide chains are usually **two alpha and two beta** chains. Hemoglobin has a molecular weight of about 67,000 Daltons. Each gram of Hb contains **3.4 mg of iron**.

Heme is present in:

- a. Hemoglobin
- b. Myoglobin
- c. Cytochromes
- d. Peroxidase
- e. Catalase
- f. Tryptophan pyrrolase
- g. Nitric oxide synthase.

Heme is produced by the combination of iron with a porphyrin ring. Chlorophyll, the photosynthetic green pigment in plants is magnesium-porphyrin complex.

### Structure of Heme

- i. Heme is usually pronounced as “heem”. Heme is a derivative of the porphyrin. **Porphyrins** are cyclic compounds formed by fusion of **4 pyrrole rings** linked by methenyl (=CH-) bridges (Fig. 21.1).



Hans Fischer  
NP 1930  
1881–1945

- ii. Since an atom of iron is present, heme is a **ferroprotoporphyrin**. The pyrrole rings are named as I, II, III, IV and the bridges as alpha, beta, gamma and delta. The possible areas of substitution are denoted as 1 to 8 (Fig. 21.2 and Table 21.1).
- iii. When the substituent groups have a symmetrical arrangement (1, 3, 5, 7 and 2, 4, 6, 8) they are called the I series. The III series have an asymmetrical distribution of substituent groups (1, 3, 5, 8, and 2, 4, 6, 7).
- iv. **Type III** is the most predominant in biological systems. It is also called series 9, because Fischer, the pioneer in porphyrin chemistry has placed it as the 9th in a series of 15 possible isomers. Hans Fischer synthesized heme in laboratory in 1920 (Nobel prize, 1930). The usual substitutions are:

**TABLE 21.1:** Porphyrins of biological importance. See also Figure 21.3 for the structure of heme

Name of porphyrin	Order of substituents from 1st to 8th positions
Uroporphyrin I	A,P,A,P,A,P,A,P
Uroporphyrin III	A,P,A,P,A,P,P,A
Coproporphyrin I	M,P,M,P,M,P,M,P
Coproporphyrin III	M,P,M,P,M,P,P,M
Protoporphyrin III	M,V,M,V,M,P,P,M

(A = acetyl; P = propionyl; M = methyl; V = vinyl)

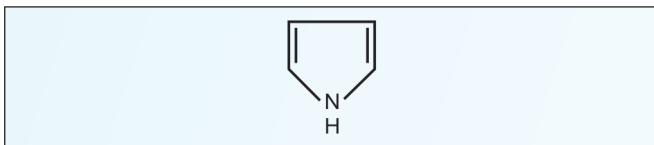


Fig. 21.1: Pyrrole ring

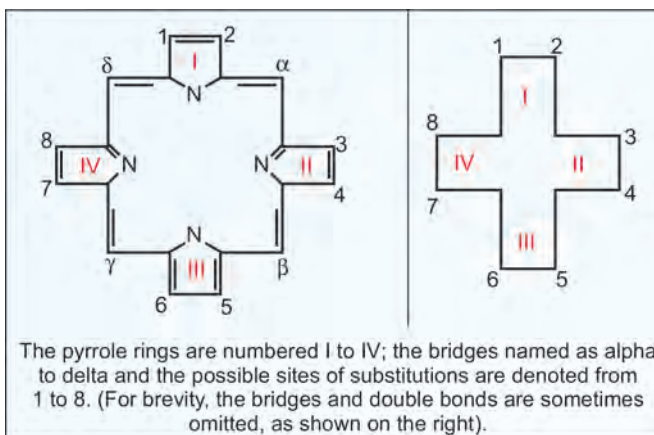


Fig. 21.2: Porphyrin ring

- a. Propionyl ( $-\text{CH}_2-\text{CH}_2-\text{COOH}$ ) group  
 b. Acetyl ( $-\text{CH}_2-\text{COOH}$ ) group  
 c. Methyl ( $-\text{CH}_3$ ) group  
 d. Vinyl ( $-\text{CH}=\text{CH}_2$ ) group.

Complete structure of heme is shown in Figure 21.3.

## BIOSYNTHESIS OF HEME

Heme can be synthesized by almost all the tissues in the body. Heme is synthesized in the normoblasts, but not in the matured erythrocytes. The pathway is partly cytoplasmic and partly mitochondrial.

### Step 1: ALA Synthesis

The synthesis starts with the condensation of succinyl CoA and glycine in the presence of **pyridoxal phosphate** to form delta amino levulinic acid (ALA) (Fig. 21.4). Hence anemia may be manifested in pyridoxal deficiency. The enzyme **ALA synthase** is located in the mitochondria and is the **rate-limiting** enzyme of the pathway.

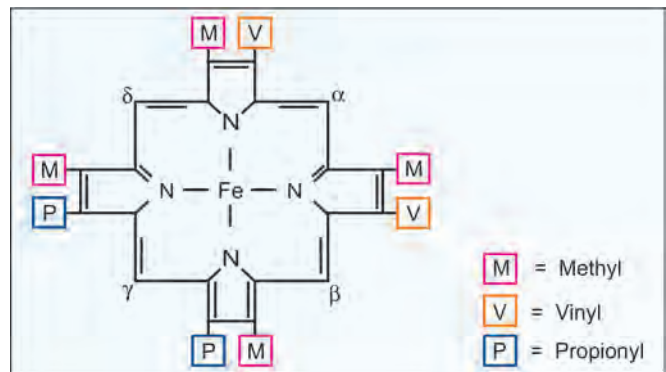


Fig. 21.3: Structure of heme

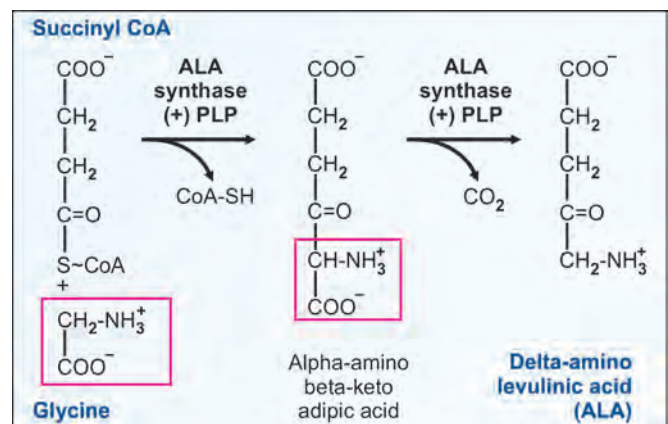


Fig. 21.4: Step 1 in heme synthesis



There are two forms of ALAS. ALAS1 is considered a house-keeping gene and is expressed in all cells. ALAS2 is an erythroid-specific form of the enzyme and is expressed only in fetal liver and adult bone marrow. The ALAS1 gene is located on chromosome 3, whereas the ALAS2 gene is located on the X chromosome. Deficiencies in ALAS2 result in a disorder called X-linked sideroblastic anemia, XLSA. Sideroblasts are erythroblasts with non-heme iron-containing organelles, called siderosomes. XLSA has also been called congenital sideroblastic anemia, hereditary sideroblastic anemia, hereditary iron-loading anemia, X-linked hypochromic anemia, hereditary hypochromic anemia, and hereditary anemia.

### Step 2: Formation of PBG

Next few reactions occur in the cytoplasm. Two molecules of ALA are condensed to form porphobilinogen (PBG). The condensation involves removal of 2 molecules of water and the enzyme is **ALA dehydratase** (Fig. 21.5, step 2). Porphobilinogen is a monopyrrole. The enzyme contains zinc and is **inhibited by lead**.

### Step 3: Formation of UPG

Condensation of 4 molecules of the PBG, results in the formation of the first porphyrin of the pathway, namely uroporphyrinogen (UPG). Condensation occurs in a head-to-tail manner, so that a linear tetrapyrrole is produced; this is named as **hydroxy methyl bilane** (HMB). The enzyme catalyzing this reaction is PBG-deaminase (otherwise called Uroporphyrin I synthase or HMB synthase). HMB molecule will cyclize spontaneously to form uroporphyrinogen I. It is converted to **uroporphyrinogen III** by the enzyme, uroporphyrinogen III synthase. When the fusion occurs, the III series of isomers are predominantly formed; and only the **III series** are further utilized. The pyrrole rings are joined together by methylene bridges (-CH<sub>2</sub>-), which are derived from the alpha carbon of glycine. During this deamination reaction 4 molecules of ammonia are removed (Fig. 21.5, step 3). Porphyrinogens are colorless, but are readily oxidized to porphyrins, which are colored compounds.

### Step 4: Synthesis of CPG

The UPG-III is next converted to coproporphyrinogen (CPG-III) by decarboxylation. Four molecules of CO<sub>2</sub> are eliminated by uroporphyrinogen **decarboxylase**. The acetate groups (CH<sub>2</sub>-COOH) are decarboxylated to methyl (CH<sub>3</sub>) groups (Fig. 21.5, step 4).

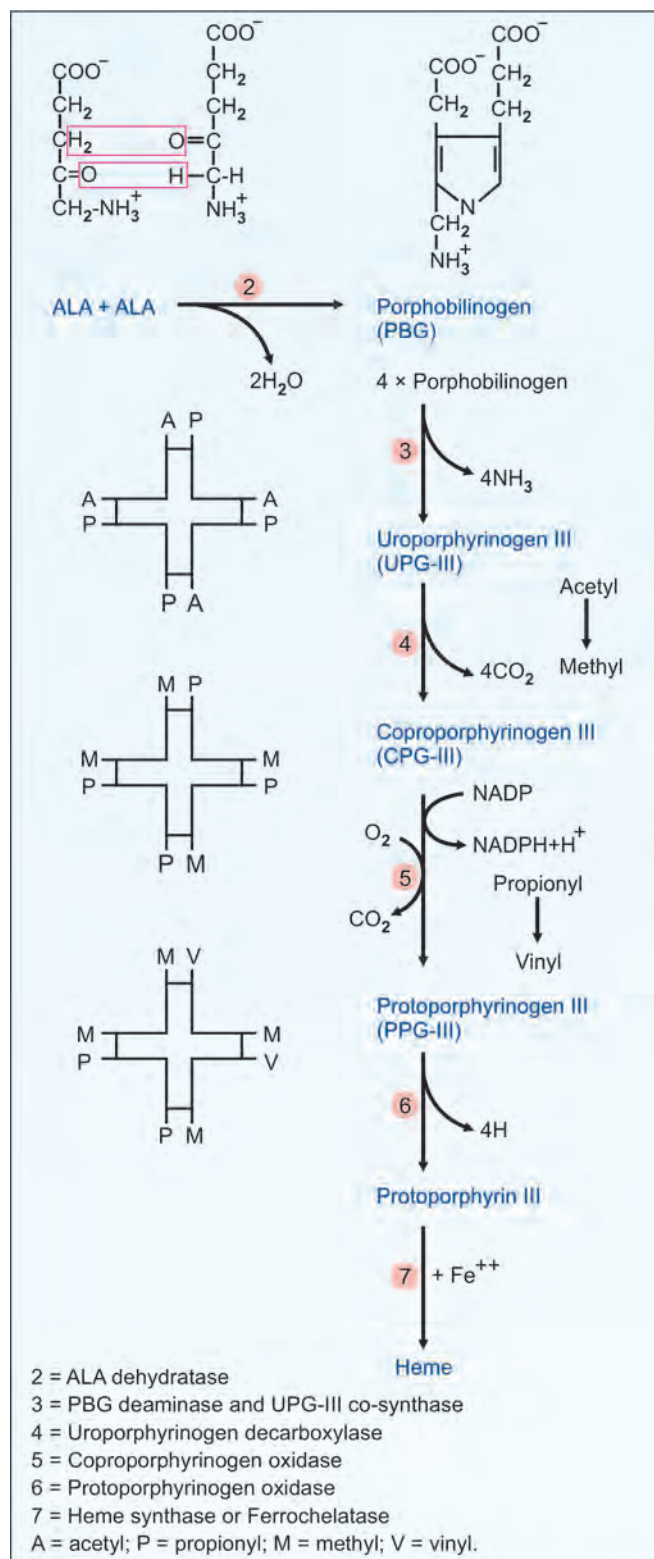


Fig. 21.5: Steps of heme synthesis

### Step 5: Synthesis of PPG

Further metabolism takes place in the mitochondria. CPG is oxidized to protoporphyrinogen (PPG-III) by coproporphyrinogen **oxidase**. This enzyme specifically acts only on type III series, and not on type I series. Two propionic acid side chains are oxidatively decarboxylated to vinyl groups (step 5, Fig. 21.5). This reaction requires molecular oxygen.

### Step 6: Generation of PP

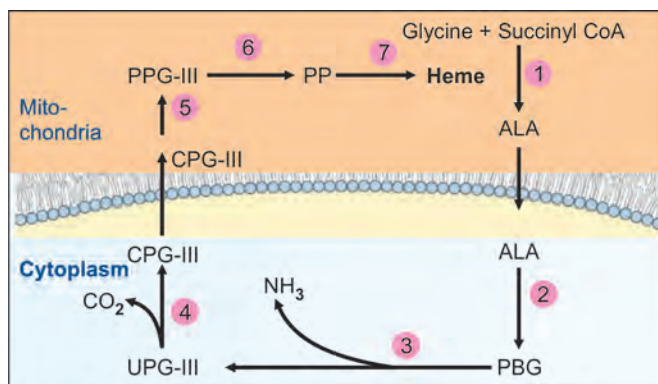
The protoporphyrinogen-III is oxidized by the enzyme protoporphyrinogen **oxidase** to protoporphyrin-III (PP-III) in the mitochondria. The oxidation requires molecular oxygen. The methylene bridges ( $-\text{CH}_2-$ ) are oxidized to methenyl bridges ( $-\text{CH}=\text{}$ ) and colored porphyrins are formed. Protoporphyrin-9 is thus formed.

### Step 7: Generation of Heme

The last step in the formation of heme is the attachment of ferrous iron to the protoporphyrin. The enzyme is **heme synthase** or **ferrochelatase**, which is also located in mitochondria.

Iron atom is coordinately linked with 5 nitrogen atoms (4 nitrogen of pyrrole rings of protoporphyrin and 1st nitrogen atom of a histidine residue of globin). The remaining valency of iron atom is satisfied with water or oxygen atom (Fig. 21.7). A summary of the pathway is shown in Figure 21.6.

When the ferrous iron ( $\text{Fe}^{2+}$ ) in heme gets oxidized to ferric ( $\text{Fe}^{3+}$ ) form, **hematin** is formed, which loses the

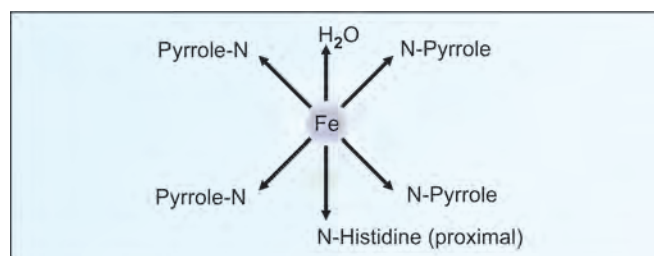


**Fig. 21.6:** Summary of heme biosynthesis. The numbers denote the enzymes. Part of synthesis is in mitochondria, and the rest in cytoplasm

property of carrying the oxygen. Heme is red in color, but hematin is dark brown.

### Regulation of Heme Synthesis

1. **ALA synthase** is regulated by **repression** mechanism. **Heme** inhibits the synthesis of ALA synthase by acting as a co-repressor (see Fig. 47.8).
2. ALA synthase is also **allosterically** inhibited by hematin. When there is excess of free heme, the  $\text{Fe}^{2+}$  is oxidized to  $\text{Fe}^{3+}$  (ferric), thus forming hematin.
3. The **compartmentalization** of the enzymes (Fig. 21.6) of heme synthesis makes the regulation easier. The rate-limiting enzyme is in the mitochondria. The steps 1, 5, 6, and 7 are taking place inside mitochondria, while the steps 2, 3 and 4 are in cytoplasm.
4. Drugs like **barbiturates** induce heme synthesis. Barbiturates require the heme containing cytochrome P450 for their metabolism. Out of the total heme synthesized, two thirds are used for cytochrome P450 production.
5. The steps catalyzed by ferrochelatase and ALA dehydratase are inhibited by **lead**.
6. **INH** (Isonicotinic acid hydrazide) that decreases the availability of pyridoxal phosphate may also affect heme synthesis.
7. High cellular concentration of **glucose** prevents induction of ALA synthase. This is the basis of administration of glucose to relieve the acute attack of porphyrias.
8. ALA synthase (ALAS) have both erythroid and non-erythroid (hepatic) forms. Erythroid form is called ALAS2; it is not induced by the drugs that affect ALAS1. Erythroid form does not produced feedback inhibition by heme.



**Fig. 21.7:** In the heme molecule, iron atom is co-ordinately linked with nitrogen atoms

## Shunt Bilirubin

When  $^{15}\text{N}$  or  $^{14}\text{C}$  labeled glycine is injected, this is incorporated into heme and into RBCs. After 100–120 days, when RBCs are lysed, the radiolabeled Hb level is decreased, along with consequent rise in radioactive bilirubin. However, about 15% of radioactive bilirubin is excreted within about 10 days (Fig. 21.8). This is called **Shunt bilirubin**. This is the formation of bilirubin from heme in bone marrow, without being incorporated into Hb. This is the result of ineffective erythropoiesis. In porphyrias, especially in the erythropoietic varieties, the shunt bilirubin will be increased.

## Disorders of Heme Synthesis

**Porphyrias** are a group of inborn errors of metabolism associated with the biosynthesis of heme. (Greek ‘porphyria’ means purple). These are characterized by increased production and excretion of porphyrins and or their precursors (ALA + PBG). Most of the porphyrias are inherited as autosomal dominant traits (Table 21.2). Porphyrias may be broadly grouped into 3 types:

- Hepatic porphyrias
- Erythropoietic porphyrias
- Porphyrias with both erythropoietic and hepatic abnormalities.

This classification is based on the major site, where the enzyme deficiency is manifested. The clinical manifestations vary. Porphyrias in general, are **not associated with anemia**.

## Acute Intermittent Porphyria (AIP)

- It is inherited as an autosomal **dominant** trait. **PBG-deaminase** (uroporphyrinogen-I-synthase) is deficient (Table 21.2 and Fig. 21.9A).
- This leads to a secondary increase in activity of ALA synthase, since the end-product inhibition is not effective.
- The levels of **ALA and PBG are elevated** in blood and urine. As they are colorless compounds, urine is colorless when voided, but the color is increased on standing due to photo-oxidation of PBG to porphobilin. Hence, urine samples for PBG estimation should be freshly collected and transported in dark bottles. Porphyrins are not excreted or elevated in blood; so there is no photosensitivity.
- As the name indicates, the symptoms appear intermittently and they are quite vague. Hence, it is at

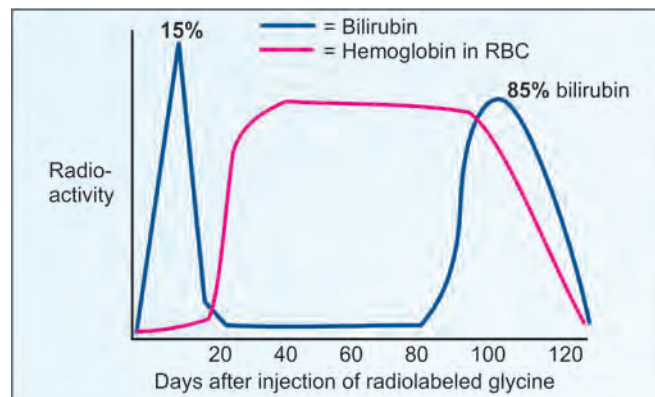


Fig. 21.8: Shunt bilirubin

**TABLE 21.2:** Features of important types of porphyrias

Type	Enzyme defect	Inheritance	Excretion in urine	Other salient features
Acute intermittent porphyria (AIP)	PBG-deaminase (UPG-1 synthase) (enzyme 3)	Autosomal dominant	Precursors, ALA and PBG. No color on voiding	Most common porphyria (1 in 10,000). Hepatic porphyria. Abdominal and neurological manifestations. No photosensitivity
Congenital erythropoietic porphyria	UPG-cosynthase (enzyme 3b)	Autosomal recessive	UP and CP; Portwine appearance	Marked photosensitivity. Erythrodonia. Incidence, rare
Porphyria cutanea tarda	UPG-decarboxylase (enz 4)	Autosomal dominant	Uroporphyrins. Urine colored	Second most common; incidence 1 in 25,000. Photosensitivity (Fig. 21.9B)
Hereditary coproporphyrin	CPG-III-oxidase (enzyme 5)	Autosomal dominant	UP and CP excreted in urine and feces. Colored urine	Symptoms similar to AIP; but milder. Photosensitivity is also seen
Hereditary protoporphyria	Heme synthase or Ferrochelatase (enzyme 7)	Autosomal dominant	Neither porphyrins nor precursors are excreted in urine	Protoporphyrin increased in plasma, RBCs and feces. RBCs show fluorescence

PBG = Porphobilinogen; CP = Coproporphyrin; ALA = delta amino levulinic acid; UP = uroporphyrins. (Enzyme numbers are given as shown in Figure 21.9)



times called the “little imitator”. Most commonly, patients present with **acute abdominal pain**. The patients often land up with the surgeon as a case of acute abdomen and on several instances exploratory laparotomies are done.

5. Women have less severe manifestations before menarche and after menopause. Thus, the female sex hormones have a stimulatory effect on ALA synthase.
6. An attack is precipitated by starvation and symptoms are alleviated by a high carbohydrate diet. Drugs like barbiturates, which are known to induce ALA synthase, can precipitate an attack.
7. Another group may have **neurological** manifestations like sensory and motor disturbances, confusion and agitation. Some patients may present with psychiatric problems and may be treated accordingly. It is said that King George III (1760–1820) was suffering from mania due to porphyria. Many of his obstinate decisions, including the ones which led to war of American independence, were made when he had acute attacks of intermittent porphyria.

### ALA Synthase (ALAS) Deficiency

It is the key enzyme of the pathway. (See enzyme No.1 in Fig. 21.9A) It is inhibited by heme in nonerythroid cells. Defective gene leads to **Pyridoxine responsive sideroblastic anemia**. Administration of

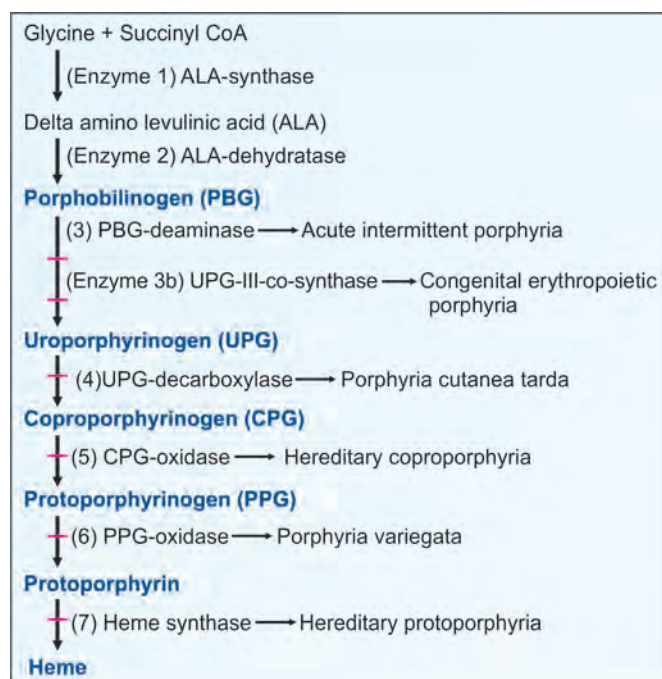


Fig. 21.9A: Enzyme deficiencies in porphyrias

porpyrinogenic drugs (barbiturates, ethanol, anticonvulsants) depletes heme; so feedback inhibition on ALAS is removed. This in turn leads to excessive production of heme intermediaries causing neurological porphyrias. Porphyrin precursors and porphyrins in urine and feces are normal. Definitive diagnosis is by demonstration of mutation in erythroid ALA synthase.

### ALA Dehydratase (Porphobilinogen Synthase) Deficiency

See enzyme No.2 in Figure 21.9A. This condition is very rare. Features are similar to AIP (abdominal pain and neuropathy). Differential diagnosis are lead poisoning (inhibit ALA dehydratase) and tyrosinemia type I (accumulation of succinyl acetone which is structurally similar to ALA). Characteristic features are increased plasma ALA, increased urine ALA and coproporphyrin III, decreased ALAD in erythrocytes. Prenatal diagnosis is by ALAD activity in cultured chorionic villi.

### Congenital Erythropoietic Porphyria

It is inherited as an autosomal **recessive** trait. (Table 21.2). (See enzyme No. 3b in Fig. 21.9A) Normally the type III isomer is produced in larger amounts, but in this condition, type I isomer is formed considerably. They are converted to porphyrins type I. This would lead to ineffective feedback inhibition which further increases the rate of formation of type I porphyrins.

Their level in blood increases leading to **photosensitivity**. Their excretion in urine makes the **urine dark red** in color (portwine appearance). The major manifestations relate to the skin due to the photosensitization by the presence of porphyrins in the capillaries. Reactive oxygen species (free radicals) are the cause for cell destruction (see Chapter 33). Repeated attacks of **dermatitis** and scarring lead to a typical facial deformity often referred to as ‘monkey face’. Repeated ulceration and scarring may cause mutilation of nose, ear and cartilage. This may mimic leprosy. When UV light is reflected on to teeth a red fluorescence is seen; this is called **erythrodontia**.

### Ferrochelatase Deficiency (Erythropoietic Protoporphyria)

See enzyme No.7 in Figure 21.9A. It is characterized by increased free protoporphyrin in RBC and decreased ferrochelatase activity in cultured lymphocytes. RBCs exhibit red fluorescence at 620 nm.



Fig. 21.9B: Porphyria cutanea tarda



Accumulation of porphyrin precursors, ALA and porphobilinogen leads to neurovisceral manifestations. Accumulated uroporphyrin and coproporphyrin cause delayed bullous lesions. On the other hand, being more lipophilic, protoporphyrin associates with cell membranes and causes burning sensation and inflammatory reaction in skin exposed to sun. Hence biochemical diagnosis of porphyria will be considered based on the major clinical features, namely; a) **neurovisceral** and b) **cutaneous** manifestations. The salient features of different types of porphyrias are given in Table 21.2.

### Acquired Porphyrias

Porphyria can result from **lead poisoning**. Most of the paints contain lead more than the permitted levels. Children suck painted toys; and they get the poison. Causes of acquired porphyrias are listed in Table 21.3. The toxic effect of lead is due to inhibition of ferrochelatase. So, there is decreased level of heme with consequent increased activity of ALA synthase. A characteristic difference from congenital porphyrias is that there is associated anemia in the acquired variety.

### Diagnosis of Porphyrias

To demonstrate porphyrins, UV fluorescence is the best technique. The presence of porphyrin precursor in urine is detected by Ehrlich's reagent. When urine is observed under ultraviolet light; porphyrins if present, will emit strong red fluorescence. The diagnostic importance of the heme precursors is shown in Table 21.4.

### Porphyrias and Absorption Bands

In **porphyrias** (uroporphyrin, coproporphyrin and protoporphyrin), the 4 pyrrole rings are joined by methenyl (-CH=) bridges and they are colored compounds. The iron atom in the centre of porphyrin is hexavalent and bonded to the 4 pyrrole nitrogens by coordinate valencies. The double bonds are resonating and therefore keep shifting their position. When the

ferrous iron ( $\text{Fe}^{2+}$ ) in heme gets oxidized to ferric ( $\text{Fe}^{3+}$ ) form, **hematin** is formed, which loses the property of carrying the oxygen. Heme is red in color, but hematin is dark brown. When hemoglobin or porphyrin solutions are viewed through a spectroscope, the absorbed wavelengths are seen as dark bands. All porphyrins will have an absorption band near 400 nm; this distinguishing band is called the **Soret band**, after its discoverer.

## CATABOLISM OF HEME

### Generation of Bilirubin

- The end-products of heme catabolism are bile pigments (Box 21.1). Bilirubin has no function in the body and is excreted through bile. The senescent RBCs breakdown liberating the hemoglobin.
- From hemoglobin, the globin chains are separated, they are hydrolyzed and the amino acids are channeled into the body amino acid pool. The iron liberated from heme is re-utilized (Fig. 21.10).
- The porphyrin ring is broken down in reticulo-endothelial (RE) cells of liver, spleen and bone marrow to bile pigments, mainly bilirubin (Fig. 21.10).
- About 6 g of Hb is broken down per day, from which about 250 mg of bilirubin is formed. From myoglobin and other heme containing proteins, another 50 mg of bilirubin is formed. Approximately 35 mg of bilirubin is formed from 1 g of Hb. A total of 300 mg of bilirubin is formed every day; of which 80% is from destruction of old RBCs, 10% from ineffective erythropoiesis and

**TABLE 21.3:** Causes of acquired porphyrias

Conditions/agents	Enzyme inhibited
Ethanol, lead, some malignancies	PBG synthase (ALA accumulated)
Some malignancies synthase (PBG and ALA accumulated)	Hydroxymethyl bilane
Chronic renal failure some malignancies	UPG decarboxylase (UP accumulated)
Diet, liver disease chronic renal failure some malignancies hexochlorobezene, lead, mercury, arsenic	CPG oxidase (CP accumulated)
Iron deficiency anemia, lead, aluminium	Ferrochelatase (PP accumulated)

PBG = porphobilinogen; ALA = amino levulinic acid; PBG = porphobilinogen; UPG = uroporphyrinogen; UP = uroporphyrin; CPG = coproporphyrinogen; CP = coproporphyrin; PP = protoporphyrin

**Box 21.1:** Bile pigments and bile salts

**Bile pigments** are Bilirubin and Biliverdin. They are the breakdown products of heme; they are useless excretory products.

**Bile salts** are the sodium salts of bile acids (glycocholate and taurocholate). They are produced from cholesterol; they help in the absorption of fat.

Both bile pigments and bile salts are present in the bile.

**TABLE 21.4:** Urinary excretion of porphyrias

	Upper limit of normal excretion value		Increased in
	Urine $\mu\text{g}/24 \text{ hr}$	Feces $\mu\text{g}/\text{g}$	
ALA	4000	Nil	AIP
PBG	1500	Nil	AIP
CP	200	50	CEP, HCP
UP	25	50	Acquired porphyria, CEP
PP	Nil	100	Acquired porphyrias

the rest 10% from degradation of myoglobin and other heme containing proteins.

- v. **Microsomal heme oxygenase system:** Heme is degraded primarily by a microsomal enzyme system; heme oxygenase. It requires molecular oxygen and NADPH; for the regeneration of NADPH cytochrome c is required. The enzyme is induced by heme. The oxygenase enzyme specifically catalyzes the cleavage of the **alpha methenyl bridge**, which is linking the pyrrole rings I and II. The alpha methenyl bridge is quantitatively liberated as **carbon monoxide** (Fig. 21.11).
- vi. The  $\text{Fe}^{++}$  liberated is oxidized to  $\text{Fe}^{+++}$  and taken up by transferrin.
- vii. The linear tetrapyrrole formed is **biliverdin** which is green in color. In mammals it is further reduced to **bilirubin**, a red-yellow pigment, by an NADPH dependent biliverdin reductase (Fig. 21.11). But birds, amphibians and rabbits excrete the green biliverdin itself.

### Transport to Liver

- i. The liver plays the central role in the further disposal of the bilirubin (Fig. 21.12 and 21.13). The bilirubin formed in the reticuloendothelial cells is insoluble in water. The lipophilic bilirubin is therefore transported in plasma bound to **albumin**.
- ii. One molecule of albumin can bind 2 molecules of bilirubin. 100 mL of plasma can transport up to 25 mg of bilirubin.
- iii. Albumin binds bilirubin in loose combination. So when present in excess, bilirubin can easily dissociate from albumin. The binding sites for bilirubin on albumin can be occupied by aspirin, penicillin, etc. Such drugs

can, therefore, displace bilirubin from albumin. Hence, care should be taken while administering such drugs to newborn babies to avoid **kernicterus**.

- iv. When the albumin-bilirubin complex reaches the sinusoidal surface of the liver, the bilirubin is taken up. The uptake is a carrier mediated active process.

### Conjugation in Liver

- i. Inside the liver cell, the bilirubin is conjugated with glucuronic acid, to make it **water-soluble**. (Fig. 21.12). The first carbon of glucuronic acid is combined with the carboxyl group of the propionic acid side chains of the bilirubin molecule. About 80% molecules are in the **diglucuronide** form, while 20% are monoglucuronides.
- ii. Drugs like primaquine, novobiocin, chloramphenicol, androgens and pregnanediol may interfere in this conjugation process and may cause jaundice.

### Excretion of Bilirubin to Bile

The water-soluble conjugated bilirubin is excreted into the bile by an active process and this occurs against a concentration gradient. This is the **rate-limiting step** in

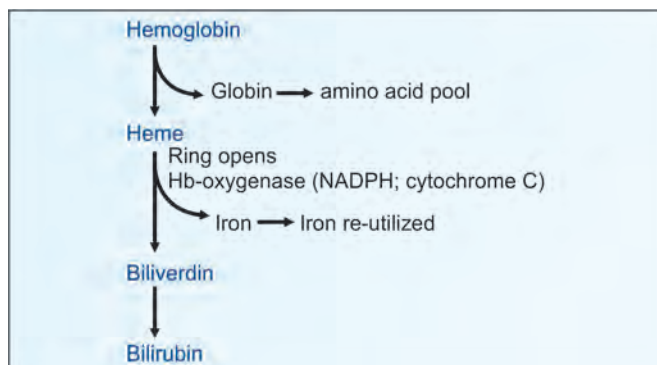


Fig. 21.10: Catabolic pathway of hemoglobin

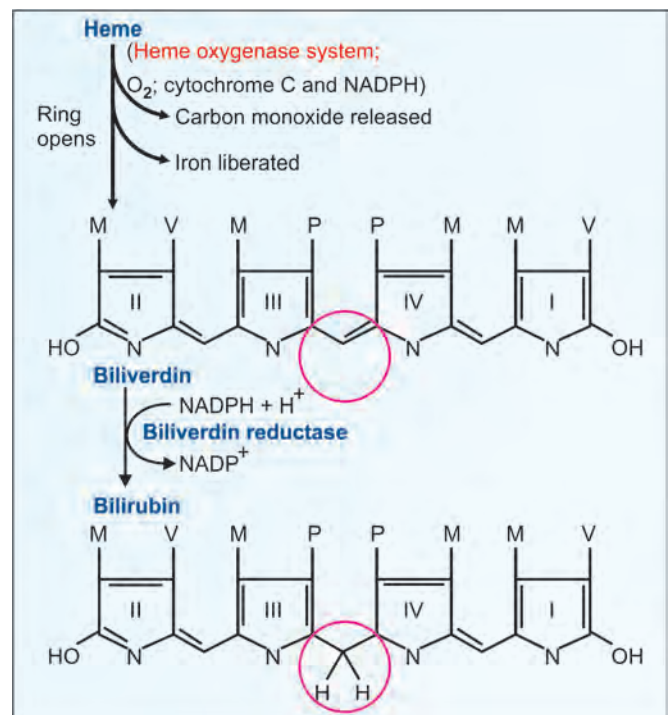


Fig. 21.11: Breakdown of heme

the catabolism of heme. It is induced by phenobarbitone. Excretion of conjugated bilirubin into bile is mediated by an ATP binding cassette protein which is called **Multispecific organic anion transporter** (MOAT), located in the plasma membrane of the biliary canaliculi. This protein is very similar to the **Multidrug resistance protein** (MRP-2).

### Fate of Conjugated Bilirubin in Intestine

- The conjugated bilirubin reaches the intestine through the bile. Intestinal bacteria **deconjugate** the conjugated bilirubin.
- This free bilirubin (36 hydrogen atoms) is further reduced to a colorless tetrapyrrole **urobilinogen** (UBG) (44 hydrogen) (Fig. 21.13).
- Further reduction of the vinyl substituent groups of UBG leads to formation of mesobilinogen and **stercobilinogen** (SBG) (48 hydrogen). The SBG is mostly excreted through feces (250–300 mg/day) (Fig. 21.13).

### Enterohepatic Circulation

About 20% of the UBG is reabsorbed from the intestine and returned to the liver by portal blood. The UBG is again re-excreted (**enterohepatic circulation**) (Fig. 21.13). Since the UBG is passed through blood, a small fraction is excreted in urine (less than 4 mg/day).

### Final Excretion

- UBG and SBG are both colorless compounds but are oxidized to colored products, urobilin (42 hydrogen) or stercobilin (46 hydrogen) respectively by atmospheric oxidation. (Table 21.5).
- Both urobilin and stercobilin are present in urine as well as in feces. The normal color of feces is due to these compounds.

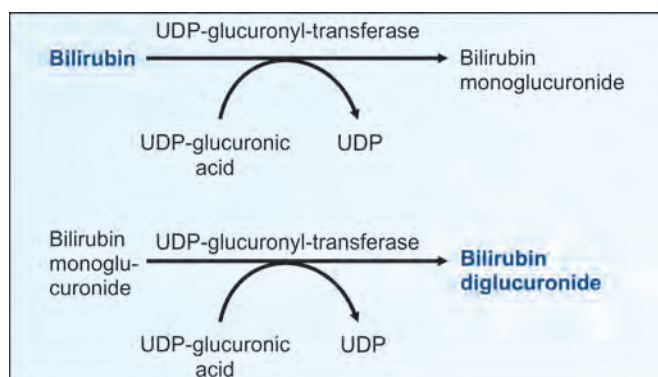


Fig. 21.12: Production of bilirubin diglucuronide

- Black color is seen in constipation. If intestinal flora is decreased by prolonged administration of antibiotics, bilirubin is not reduced to bilinogens, and in the large gut, it is re-oxidized by  $O_2$  to form biliverdin. Then green tinged feces is seen, especially in children.

### Plasma Bilirubin

- Normal plasma bilirubin level ranges from **0.2–0.8 mg/dL**. The unconjugated bilirubin is about 0.2–0.6 mg/dL, while conjugated bilirubin is only 0–0.2 mg/dL.
- If the plasma bilirubin level exceeds 1 mg/dL, the condition is called **hyperbilirubinemia**. Levels between 1 and 2 mg/dL are indicative of **latent jaundice**.
- When the bilirubin level exceeds 2 mg/dL, it diffuses into tissues producing yellowish discoloration of sclera, conjunctiva, skin and mucous membrane resulting in **jaundice**. Icterus is the Greek term for jaundice.

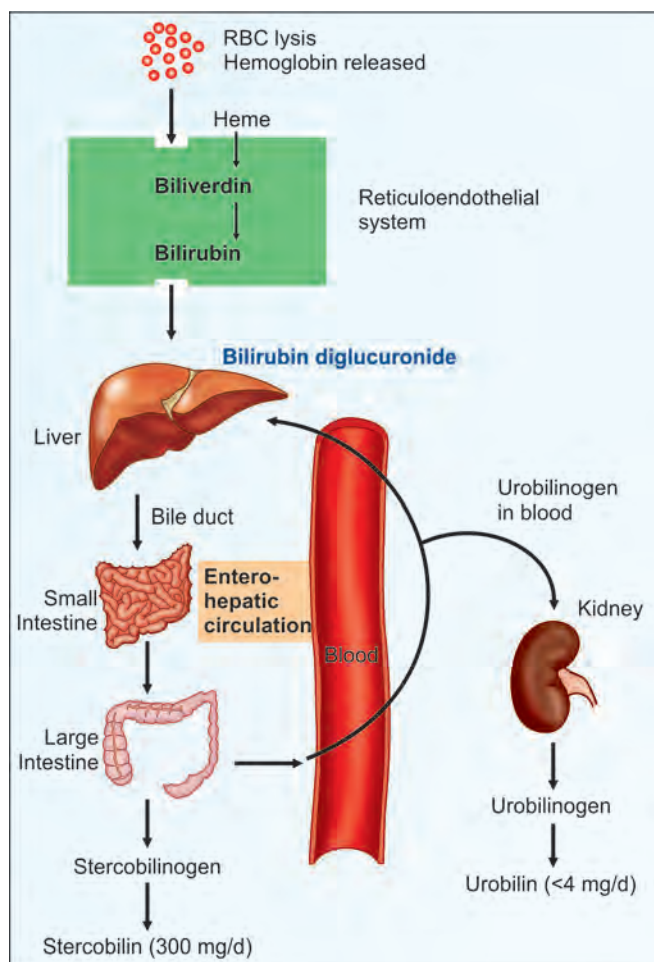


Fig. 21.13: Production and excretion of bilirubin

## Van Den Bergh Test for Bilirubin

Properties of bilirubin are shown in Table 21.6. Bilirubin reacts with *dialo reagent* (diazotized sulfanilic acid) to produce colored azo pigment. At pH 5, the pigment is purple in color. Conjugated bilirubin, being water soluble gives the color immediately; hence called **direct reaction**. Free bilirubin is water insoluble. It has to be extracted first with alcohol, when the reaction becomes positive; hence called **indirect reaction**.

## Tests for Bile Pigments

Bilinogens (UBG and SBG) react with **Ehrlich's** aldehyde reagent (para dimethyl amino benzaldehyde) to form red color. Oxidizing agents readily oxidize bilirubin to biliverdin to form a green color. In **Fouchet's test**, urine is heated with barium sulfate which adsorbs bilirubin. Ferric chloride oxidizes bilirubin to produce a green color. In **Gmelin's** test, nitric acid is used as the oxidizing agent. The bilinogens (UB and SB) form complexes with zinc ions which exhibit brilliant green fluorescence. This is the basis for **Schlesinger's** reaction. It is negative in normal urine. These findings are summarized in Table 21.7.

**TABLE 21.5:** Bilirubin and its reduction products

	Number of hydrogen atoms	Color
Bilirubin (BR)	36	Red-yellow
Mesobilirubin (MB)	40	Yellow
Urobilinogen (UBG)	44	Colorless
Stercobilinogen (SBG)	48	Colorless
Urobilin (UB)	42	Orange-brown
Stercobilin (SB)	46	Dark brown

**TABLE 21.6:** Properties of conjugated and free bilirubin

	Free bilirubin	Conjugated bilirubin
In water	Insoluble	Soluble
In alcohol	Soluble	Soluble
Normal plasma level	0.2 – 0.6 mg/dL	0 – 0.2 mg/dL
In bile	Absent	Present
In urine	Always absent	Normally absent
Absorption from GIT	Absorbed	Not absorbed
Diffusion into tissue	Diffuses	Does not diffuse
van den Berg's test	Indirect positive	Direct positive

## HYPERBILIRUBINEMIAS

Depending on the nature of the bilirubin elevated, the condition may be grouped into conjugated or unconjugated hyperbilirubinemia. Based on the cause it may also be classified into congenital and acquired.

### Congenital Hyperbilirubinemias

They result from abnormal uptake, conjugation or excretion of bilirubin due to inherited defects.

#### Crigler-Najjar Syndrome

Here the defect is in **conjugation**. In type 1 (congenital non-hemolytic jaundice), there is severe deficiency of **UDP glucuronyl transferase**. The disease is often fatal and the children die before the age of 2. Jaundice usually appears within the first 24 hours of life. Unconjugated bilirubin level increases to more than 20 mg/dL, and hence **kernicterus** results.

The type 2 disease is a milder form; only the second stage of conjugation is deficient. When barbiturates are given, some response is seen and jaundice improves.

The gene encoding bilirubin-UDP glucuronyl transferase is a part of large gene complex present in chromosome number 2. This contains 13 substrate-specific exons, each with its own promoter. Exon A1 is involved with conjugation of bilirubin.

#### Gilbert's Disease

It is inherited as an autosomal dominant trait. The defect is in the **uptake of bilirubin** by the liver. Bilirubin level is usually around 3 mg/dL, and patient is asymptomatic, except for the presence of mild jaundice.

#### Dubin-Johnson Syndrome

It is an autosomal **recessive** trait leading to defective excretion of conjugated bilirubin; so conjugated bilirubin in blood is increased. The disease results from the defective ATP-dependent organic **anion transport** in bile canaliculi. There is a mutation in the MRP-2 protein which is

**TABLE 21.7:** Tests for bile pigments

Bile pigments	Fouchet's; Gmelin's; van den Berg	Ehrlich's test	Schlesinger's test
Bilirubin	+ve	-ve	-ve
Bilinogens (UBG)	-ve	+ve	-ve
Bilins (UB + SB)	-ve	-ve	+ve



responsible for transport of conjugated bilirubin into bile. The bilirubin gets deposited in the liver and the liver appears black. The condition is referred to as **Black liver jaundice**.

In normal persons, when 250 mg BSP (Brom sulfthalein) is given intravenously, blood contains only 5% of original value at 45 minutes, and only 2% at 2hr. BSP is taken up by hepatocytes, conjugated and then excreted through liver. In *Dubin-Johnson's syndrome*, the BSP level in serum at 2 hours is more than the value at 45 minutes. This is because by 45 minutes, BSP is taken by hepatocytes, and hence blood level is reduced. But excretory defect for conjugated BSP leads to regurgitation into plasma. Hence higher value at 2 hours.

### Rotor Syndrome

It is a similar condition, but the exact defect is not identified. Bilirubin excretion is defective, but there is no staining of the liver. It is an autosomal recessive condition.

## Acquired Hyperbilirubinemias

### Physiological Jaundice

It is also called as neonatal hyperbilirubinemia. In all new born infants after the 2nd day of life, mild jaundice appears. This transient hyperbilirubinemia is due to an accelerated rate of destruction of RBCs and also because of the immature hepatic system of conjugation of bilirubin. In such cases, bilirubin does not increase above 5 mg/dL. It disappears by the second week of life.

### Breast Milk Jaundice

In some breast-fed infants, prolongation of the jaundice has been attributed to high level of an estrogen derivative in maternal blood, which is excreted through the milk. This would inhibit the glucuronyl transferase system. Sulfa and such other drugs may release bilirubin from albumin, and may cause jaundice in newborn.

## Hemolytic Jaundice

### Hemolytic Disease of the Newborn

- i. This condition results from incompatibility between maternal and fetal blood groups. Rh positive fetus may produce antibodies in Rh negative mother. In **Rh incompatibility**, the first child often escapes. But in the second pregnancy, the Rh antibodies will pass from mother to the fetus. They would start destroying the fetal red cells even before birth.

- ii. Sometimes the child is born with severe hemolytic disease, often referred to as **erythroblastosis fetalis**.
- iii. When blood level is more than 20 mg/dL, the capacity of albumin to bind bilirubin is exceeded. In young children before the age of 1 year, the blood-brain barrier is not fully matured, and therefore free bilirubin enters the brain (**Kernicterus**). It is deposited in brain, leading to mental retardation, fits, toxic encephalitis and spasticity.
- iv. If the child develops hemolytic disease, child may be given exchange transfusion along with phototherapy and barbiturates. **Phototherapy** with blue light (440 nm wavelength) isomerize insoluble bilirubin to more soluble isomers. These can be excreted through urine without conjugation.

### Hemolytic Diseases of Adults

This condition is seen in increased rate of hemolysis. It usually occurs in adults. The characteristic features are increase in **unconjugated bilirubin** in blood, absence of bilirubinuria and excessive excretion of UBG in urine and SBG in feces (Table 21.7). Common causes are:

- i. Congenital spherocytosis
- ii. GPD deficiency
- iii. Autoimmune hemolytic anemias
- iv. Toxins like carbon tetrachloride.

## Hepatocellular Jaundice

The most common cause is viral hepatitis, caused by Hepatitis Viruses A, B, C, D or E. In pure hepatocellular disease, conjugation in liver is decreased and hence **free bilirubin** is increased in circulation. However, inflammatory edema of cell often compresses intracellular canaliculi at the site of bile formation and this produces an element of obstruction. When conjugated bilirubin level also increases, mixed type of jaundice results. Bilirubinuria also occurs. The UBG level in urine may be normal or decreased in hepatocellular jaundice (Table 21.8).

## Obstructive Jaundice

**Conjugated bilirubin** is increased in blood, and it is excreted in urine. If there is complete obstruction, UBG will be decreased in urine or even absent (Fig. 21.13 and Tables 21.8). In total obstruction of biliary tree, the bile does not enter the intestine. Since no pigments are entering

into the gut, the feces become clay colored. The common causes of obstructive jaundice are:

- a. Intrahepatic cholestasis. This may be due to:
  - i. Chronic active hepatitis
  - ii. Biliary cirrhosis
  - iii. Lymphomas
  - iv. Primary hepatoma
  - v. Obstructive stage of viral hepatitis.
- b. Extrahepatic obstruction. This may be due to:
  - i. Stones in the gallbladder or biliary tract
  - ii. Carcinoma of head of pancreas
  - iii. Enlarged lymph glands in the porta hepatis. More details on different types of jaundice are given in Chapter 26.

## Bilirubin Toxicity

Bilirubin has been shown to inhibit DNA synthesis, uncouple oxidative phosphorylation, and inhibit ATPase activity in brain mitochondria. Bilirubin also inhibits a variety of different classes of enzymes including dehydrogenases, electron transport proteins, hydrolases, and enzymes of RNA synthesis, protein synthesis and carbohydrate metabolism. All of these toxic effects of bilirubin are reversed by binding to albumin. In fact, albumin plays a vital role in the disposition of bilirubin in the body by keeping the compound in solution and transporting it from its sites of production (primarily bone marrow and spleen) to its site of excretion which is the liver.

### Clinical Case Study 21.1

A 21-year-old healthy male college student went to celebrate his birthday with some friends at a bar. His friends convinced him to have his first beer since he just turned 21.

**TABLE 21.8:** Differential diagnosis of jaundice

	<i>Hemolytic jaundice</i>	<i>Hepato-cellular jaundice</i>	<i>Obstructive jaundice</i>
Blood, free bilirubin	Increased	Increased	Normal
Blood, conj. bilirubin	Normal	Increased	Increased
Blood, ALP	Normal	Increased	Very high
Urine, bile salts	Nil	Nil	Present
Urine, conj. bilirubin	Nil	Present	Present
Urine, bilinogens	Increased	Present	Nil
Fecal urobilinogen	Increased	Decreased	Absent

Normal values: unconjugated (free) (indirect) bilirubin 0.2–0.7 mg/dL and conjugated (direct) bilirubin 0.1–0.4 mg/dL. A rise in serum bilirubin above 1 mg/dL is abnormal (latent jaundice); but jaundice appears only if the level goes above 2 mg/dL.

After consuming the beer, he began to experience intense, worsening abdominal pain that was nonspecific in location and described as cramping. Nausea and vomiting then ensued and he was taken to the ER.

Upon arrival to the ER, he was found to be very anxious with hallucinations. He was noted to be hypertensive, tachycardic, and diaphoretic. Peripheral neuropathy was also noticed on examination. Initial laboratory test revealed a normal CBC, drug screen, and EtOH level. Serum and urine aminolevulinic acid (ALA) and phorbilinogen (PBG) were both found to be elevated.

What is the likely diagnosis?

What is the underlying biochemical problem?

### Clinical Case Study 21.2

The following are the biochemical values in a patient. What is your probable diagnosis?

Serum bilirubin—13.0 mg%

Conjugated bilirubin—6.0 mg%

Unconjugated bilirubin—7.0 mg%

Serum alkaline phosphatase—280 IU/L

SGOT—250 U/L

SGPT—370 U/L

Urine bile salts—Negative, Bile pigments—Positive

(+++), Urobilinogen—Positive

Feces stercobilinogen—Positive

### Clinical Case Study 21.3

Comment on the following laboratory results obtained in a patient and give your probable diagnosis.

Serum bilirubin—9.0 mg%

Conjugated bilirubin—7.5 mg%

Unconjugated bilirubin—1.5 mg%

SGOT—80 U/L

SGPT—90 U/L

ALP—140 KA Units

Urine bile salts—Positive (++) , Bile pigments—Positive

(++), Urobilinogen—Negative

Feces stercobilinogen—Negative

### Clinical Case Study 21.4

Comment on the following laboratory results and give your provisional diagnosis.

Serum bilirubin—9.0 mg%

Conjugated bilirubin—0.5 mg%

Unconjugated bilirubin—8.5 mg%  
 SGOT—26 U/L  
 SGPT—30 U/L  
 ALP—8 KA Units  
 Urine bile salts—Negative, Bile pigments—Negative,  
 Urobilinogen—Positive (+++)  
 Feces stercobilinogen—Positive (+++)

### Clinical Case Study 21.5

A 42-year-old obese lady presented with intolerance to fatty food and pain in the right abdominal region. On examination, her eyes were yellowish and stools had clay colored appearance. The doctor ordered some laboratory tests.

The results obtained were as follows:

Serum bilirubin—25.0 mg%  
 SGOT—35 U/L  
 SGPT—40 U/L  
 ALP—400 IU/L

What is the probable diagnosis?

### Clinical Case Study 21.6

A newborn baby presented with yellowish discoloration of skin and conjunctiva after 3 days of birth. The neonatologist advised phototherapy. The child became normal. What is the type of jaundice? What are the tests to be done in this child? Why did phototherapy benefit the child? What are the other types of jaundice that may be seen in a newborn baby?

### Clinical Case Study 21.1 Answer

**Diagnosis:** Porphyria (likely acute intermittent porphyria).

**Biochemical problem:** Enzymatic deficiency in heme biosynthetic pathway.

**Clinical correlation:** Patients often are asymptomatic unless exposed to factors that increase production of porphyrias (drugs, alcohol, sunlight). Erythropoetic varieties primarily present with photosensitivity.

Hepatic porphyrias present with primarily neurovisceral symptoms such as: abdominal pain, nausea and vomiting, tachycardia and hypertension, peripheral neuropathy, and mental symptoms (hallucinations, anxiety, seizures).

Diagnosis is confirmed with elevated levels of ALA and PBG in the urine and serum. Treatment is supportive with avoidance of triggers in the future.

### Clinical Case Study 21.2 Answer

Hepatocellular jaundice.

### Clinical Case Study 21.3 Answer

Obstructive jaundice. Causes are discussed in the text.

### Clinical Case Study 21.4 Answer

Hemolytic jaundice. Causes are discussed in the text.

### Clinical Case Study 21.5 Answer

Obstructive jaundice due to gallstones.

### Clinical Case Study 21.6 Answer

Hemolytic disease of the newborn. See text for description on the congenital types of jaundice.

## QUICK LOOK OF CHAPTER 21

1. Hemoglobin—the oxygen transporter is a 67 Kd tetrameric conjugated protein with heme as prosthetic group and globin polypeptide (2  $\alpha$  and 2  $\beta$  chains).
2. Heme is a derivative of porphyrin, which is a cyclic compound formed by the fusion of 4 pyrrole rings, linked by methenyl bridges and has an iron atom at its center.
3. Regulation of heme synthesis is by repression of ALA synthase by heme and high cellular concentration of glucose prevents ALA synthase induction. Barbiturates induce the enzyme. ALA synthase is also allosterically inhibited by hematin.
4. Porphyrias are the class of metabolic disorders associated with heme synthesis. AIP occurs due to deficiency of PBG deaminase. Congenital erythropoietic porphyria is due to imbalance in activities of uroporphyrinogen I synthase and co-synthase. Acquired porphyries result from lead poisoning.
5. Normal plasma bilirubin levels range from 0.2–0.8 mg/dL and can be detected by van den Bergh's test.
6. Congenital hyperbilirubinemias include, Gilbert's disease where bilirubin uptake is defective, Crigler-Najjar syndrome where conjugation is defective Dubin-Johnson syndrome where defect is in excretion of conjugated bilirubin.
7. Acquired hyperbilirubinemias or Jaundice may be physiological jaundice, hemolytic jaundice, hepatocellular jaundice and obstructive jaundice.

# CHAPTER 22

## Hemoglobin (Structure, Oxygen and Carbon Dioxide Transport, Abnormal Hemoglobins)

### Chapter at a Glance

The reader will be able to answer questions on the following topics:

- Structure of hemoglobin
- Oxygen dissociation curve
- Transport of carbon dioxide
- Fetal hemoglobin
- Carboxy hemoglobin
- Met-hemoglobin
- Hemoglobinopathies
- Sickle cell anemia
- Thalassemias
- Myoglobin
- Anemias

Marcello Malpighi described the RBCs in 1665. Felix Hoppe-Seyler in 1862 isolated pure hemoglobin. Christian Bohr in 1904 discovered that hemoglobin is the transporter of oxygen. In 1912, Kuster established the structure of hemoglobin. Hans Fischer synthesized heme in laboratory in 1920 (Nobel prize, 1930). Perutz (Nobel prize, 1962) studied the three-dimensional structure of hemoglobin.

### STRUCTURE OF HEMOGLOBIN

- Normal level of Hemoglobin (Hb) in blood in males is **14–16 g/dL** and in females, 13–15 g/dL. Hb is globular in shape. The adult Hb (HbA) has 2 alpha chains and 2 beta chains. Molecular weight of HbA is **67,000 Daltons** (66,684 to be exact).
- Hb F (fetal Hb) is made up of 2 alpha and 2 gamma chains. Hb A2 has 2 alpha and 2 delta chains. Normal adult blood contains 97% HbA, about 2% HbA2 and about 1% HbF.
- Alpha chain gene is on chromosome 16 while the beta, gamma and delta chains are on chromosome 11.
- Each alpha chain has 141 amino acids. The beta, gamma and delta chains have 146 amino acids. The N-terminal and C-terminal end amino acids are shown in Table 22.1.
- There are 36 histidine residues in Hb molecule; these are important in buffering action. The 58th residue in alpha chain is called **distal histidine**, because it is far away from the iron atom. The 87th residue in alpha chain is called **proximal histidine**, because it lies nearer to the iron atom (Fig. 22.1).



Marcello Malpighi  
1628–1694



Felix Hoppe-Seyler  
1825–1895



Max Perutz  
NP 1962  
1914–2002



Donald van Slyke  
1883–1971



- vii. The alpha and beta subunits are connected by relatively weak non-covalent bonds like van der Waals forces, hydrogen bonds and electrostatic forces.

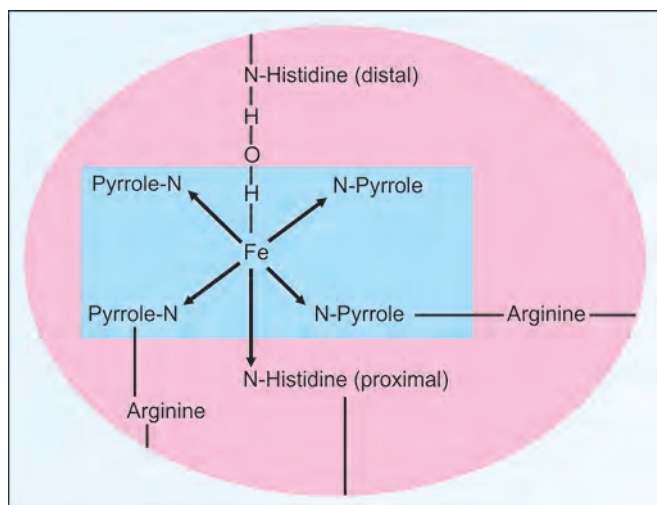
### Attachment of Heme with Globin Chain

- There are 4 heme residues per Hb molecule, one for each subunit in Hb. The 4 heme groups account for about 4% of the whole mass of Hb. The heme is located in a hydrophobic cleft of globin chain (Fig. 22.1).
- The iron atom of heme occupies the central position of the porphyrin ring. The reduced state is called ferrous ( $\text{Fe}^{2+}$ ) and the oxidized state is ferric ( $\text{Fe}^{3+}$ ). The ferrous iron has **6 valencies** and ferric has 5 valencies. In hemoglobin, **iron remains in the ferrous state** (Box 22.1).
- Iron carries oxygen:** The iron is linked to the pyrrole nitrogen by 4 coordinate valency bonds and a fifth one to the imidazole nitrogen of the **proximal histidine** (Fig. 22.1). In oxy-Hb, the 6th valency of iron binds the

$\text{O}_2$ . The oxygen atom directly binds to Fe, and forms a hydrogen bond with an imidazole nitrogen of the distal histidine. In deoxy-Hb, a water molecule is present between the iron and distal histidine (Fig. 22.1). As the porphyrin molecule is in resonance, central iron atom is linked by coordinate bond. The **distal histidine** lies on the side of the heme ring (Fig. 22.1).

The nonpolar vinyl groups of the heme are buried deep in the hydrophobic interior of globin chain. The charged or polar substituent groups of the porphyrin are oriented towards the hydrophilic outer surface of the subunit. The propionic acid residues of the porphyrin ring form electrostatic bonds with two separate arginine residues of the globin (Fig. 22.1). In a deoxy hemoglobin molecule, iron atoms between alpha and beta chains are 25 Å apart, and between 2 beta chains are 33.4 Å apart (1 Å = 0.1 nm). When oxygenation occurs, the iron moves to 0.1 Å of the plane of the heme ring.

Discovery of carbon dioxide by Joseph Black in 1757 and that of oxygen by Priestley in 1771. In 1775, Lavoisier showed that interchange of oxygen is taking place in lungs. In 1837, Theodor Bischoff showed the presence of carbon dioxide and oxygen in blood. The effect of carbon dioxide on respiration was studied by Haldane in 1905, and that of pH by Hasselbalch in 1912. In 1925, blood gas analysis was done by Donald van Slyke.



**Fig. 22.1:** Linkage of heme with globin. Pink circle represents the globin chain. Blue rectangle represents the protoporphyrin ring

### TRANSPORT OF OXYGEN BY HEMOGLOBIN

Hemoglobin has all the requirements of an ideal respiratory pigment (Barcroft):

- It can transport large quantities of oxygen
- It has great solubility
- It can take up and release oxygen at appropriate partial pressures
- It is a powerful buffer.

### Oxygen Dissociation Curve (ODC)

- The ability of hemoglobin to load and unload oxygen at physiological  $p\text{O}_2$  (partial pressure of oxygen) is shown by the oxygen dissociation curve (ODC) (Fig. 22.3). Hemoglobin is oxygenated and not oxidized (Box 22.1).

**TABLE 22.1:** Amino acid sequence of globin

Hb chain	Amino acid sequence number								
	1	58	63	87	92	141		145	146
Alpha	Val	Distal His	-	Proximal His	-	Last Arg		Nil	Nil
Beta	Val	-	Distal His	-	Proximal His	-		Tyr	Last His
Gamma	Gly	-	Distal His	-	Proximal His	-		Tyr	Last His
Delta	Val	-	Distal His	-	Proximal His	-		Tyr	Last His

- ii. At the oxygen tension in the pulmonary alveoli, the Hb is **97% saturated** with oxygen. Normal blood with 15 g/dL of Hb can carry  $1.34 \times 15 = 20$  mL of  $O_2$ /dL of blood.
- iii. In the tissue capillaries, where the  $pO_2$  is only 40 mm Hg, theoretically, Hb saturation is 75%. Thus under NTP conditions, blood can release only 22% (Fig. 22.3A).
- iv. But actually in tissue capillaries, where  $pO_2$  is 40 mm Hg, the Hb is about **60% saturated**. So physiologically, 40% of oxygen is released (Fig. 22.3C).
- v. The  $pO_2$  in inspired air is 158 mm Hg; in alveolar air 100 mm Hg; in the blood in lungs,  $pO_2$  is 90 mm Hg; and in capillary bed, it is 40 mm Hg. In tissues, oxygen is liberated from hemoglobin. In lung capillaries, oxygen is taken up by the hemoglobin. Oxygen carriage of hemoglobin is schematically depicted in Figure 22.4. The following factors will affect the oxygen dissociation curve.

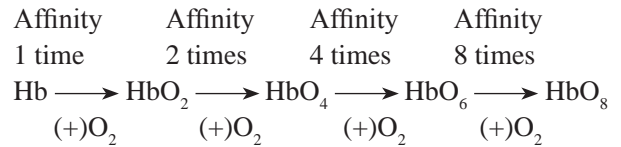
### Heme-Heme Interaction and Cooperativity

- i. The sigmoid shape of the oxygen dissociation curve (ODC) is due to the allosteric effect, or cooperativity. The equilibrium of Hb with oxygen is expressed by the Hill equation (AV Hill, Nobel prize, 1922).
- ii. The binding of oxygen to one heme residue increases the affinity of remaining heme residues for oxygen

#### Box 22.1: Oxygenation and oxidation

When hemoglobin carries oxygen, the Hb is oxygenated. The iron atom in Hb is still in the ferrous state. Oxidized hemoglobin is called Met-Hb; then iron is in ferric state and the oxygen carrying capacity is lost.

(**homotropic** interaction) (Fig. 22.3B). This is called **positive cooperativity**.

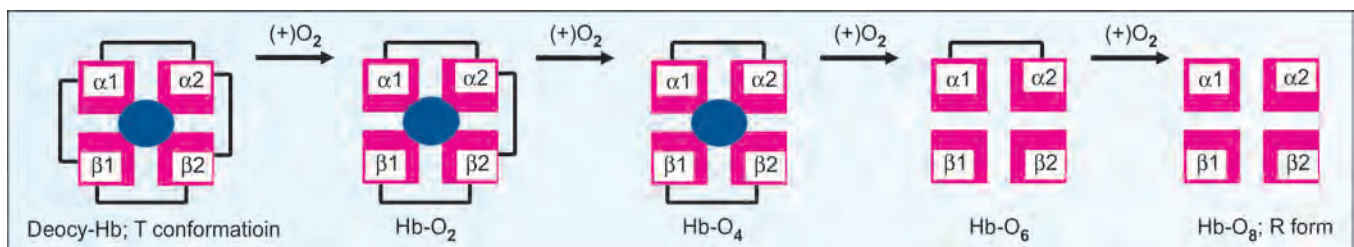


- iii. Thus each successive addition of  $O_2$ , increases the affinity of Hb to oxygen synergistically.
- iv. Similarly, binding of 2,3-BPG at a site other than the oxygen binding site, lowers the affinity for oxygen (**heterotropic** interaction).
- v. The quaternary structure of oxy-Hb is described as **R (relaxed)** form; and that of deoxy-Hb is **T (tight)** form.
- vi. When oxygenation occurs the salt bonds are broken successively. Thus, on oxygenation, the hemoglobin molecule can form two similar dimers.
 
$$(2x \text{ alpha}) + (2x \text{ beta}) \longrightarrow 2 \times (\text{alpha-beta})$$

(deoxy-Hb)
(oxy-Hb)
- vii. **Alteration of Structure:** The T conformation of deoxyhemoglobin is maintained by C-terminal arginine carboxyl group of alpha-1 with amino group of lysine (132nd residue) in alpha-2 and C-terminal arginine group of alpha-1 with carboxyl group of aspartic acid (131residue) in alpha-2. These alpha-1 and alpha-2 bridges cannot be formed in oxyhemoglobin. During oxygen uptake, the T form switches to the R form with disruption of the salt bridges (Fig. 22.2). Hemoglobin subunits are moved relative to one another. During oxygenation, the alpha1-beta2 interface shows movement. The two subunits slip over each other. The binding of the iron to oxygen is now stronger. Hence, the R form has a higher affinity for oxygen.

### Effect of pH and $pCO_2$

- i. When the  $pCO_2$  is elevated, the  $H^+$  concentration increases and pH falls. In the tissues, the  $pCO_2$  is high and pH is low due to the formation of metabolic acids like lactate. Then the affinity of hemoglobin for  $O_2$



**Fig. 22.2:** Diagrammatic representation of the subunit interaction in hemoglobin. Pink rectangles represent Hb monomers. Black connection lines represent salt bridges. As oxygen is added, salt bridges are successively broken and finally 2,3-BPG is expelled. Simultaneously the T (taught) conformation of deoxy-Hb is changed into R(relaxed) conformation of oxy-Hb. Blue circle represents 2,3-bisphosphoglycerate (BPG)

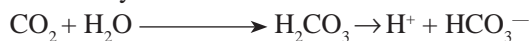
is decreased (the ODC is shifted to the right) and so, more  $O_2$  is released to the tissues (R  $\rightarrow$  T change takes place) (Fig. 22.3C).

- ii. In the lungs, the opposite reaction is found, where the  $pCO_2$  is low, pH is high and  $pO_2$  is significantly elevated. More  $O_2$  binds to hemoglobin and the ODC is shifted to the left. Moreover, T  $\rightarrow$  R change is seen.

### The Bohr Effect

- i. The influence of pH and  $pCO_2$  to facilitate oxygenation of Hb in the lungs and deoxygenation at the tissues is known as the Bohr effect (1904).
- ii. Binding of  $CO_2$  forces the release of  $O_2$ .
- iii. When the  $pCO_2$  is high,  $CO_2$  diffuses into the red blood cells. The carbonic anhydrase in the red cells favors the formation of carbonic acid ( $H_2CO_3$ ).

Carbonic anhydrase



- iv. When carbonic acid ionizes, the intracellular pH falls. The affinity of Hb for  $O_2$  is decreased and  $O_2$  is unloaded to the tissues.

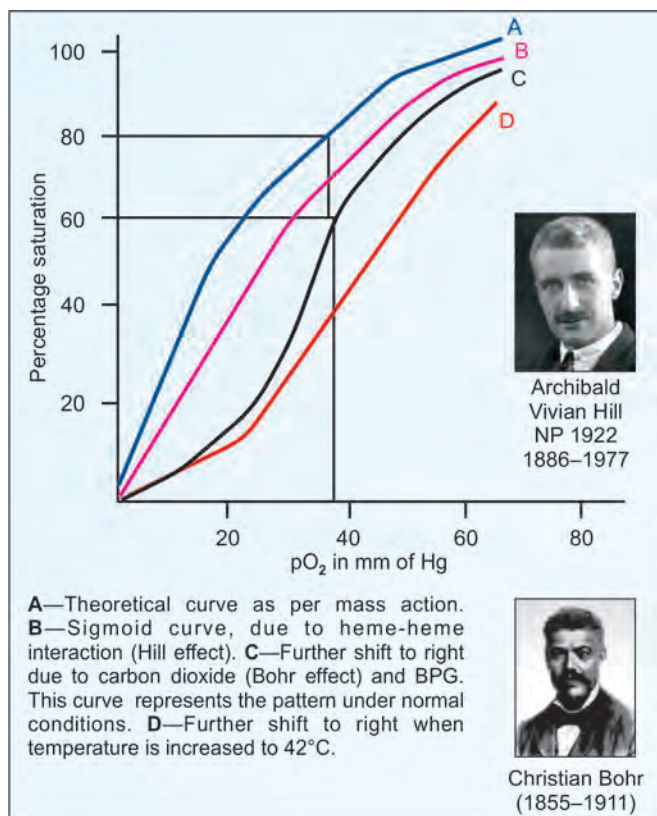


Fig. 22.3: Oxygen dissociation curve (ODC)

### The Chloride Shift

- i. When  $CO_2$  is taken up, the  $HCO_3^-$  concentration within the cell increases. This would diffuse out into the plasma. Simultaneously, chloride ions from the plasma would enter the cell to establish electrical neutrality. This is called **chloride shift or Hamburger effect** (Fig. 22.5). Thus on venous side, RBCs are slightly bulged due to the higher chloride ion concentration.
- ii. When the blood reaches the lungs, the reverse reaction takes place. The deoxy-hemoglobin liberates protons. These would combine with  $HCO_3^-$  to form  $H_2CO_3$  which is dissociated to  $CO_2$  and  $H_2O$  by the carbonic anhydrase. The  $CO_2$  is expelled. As  $HCO_3^-$  binds  $H^+$ , more  $HCO_3^-$  from plasma enters the cell and  $Cl^-$  gets out (reversal of chloride shift) (Fig. 22.6).

### Effect of Temperature

The term  $p50$  means, the  $pO_2$  at which Hb is half saturated (50%) with  $O_2$ . The  $p50$  of normal Hb at  $37^\circ C$  is of 26 mm Hg. Elevation of temperature from  $20^\circ$  to  $37^\circ C$  causes 88%

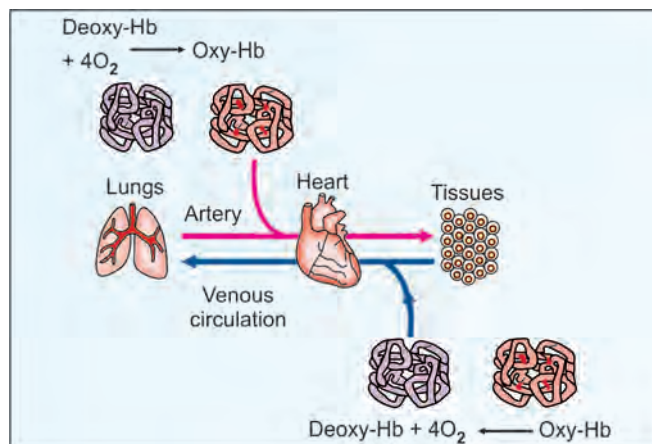


Fig. 22.4: In tissues oxy-Hb releases oxygen

increase in p50. Metabolic demand is low when there is relative hypothermia. Shift in ODC to left at low temperature results in release of less O<sub>2</sub> to the tissues. On the other hand, under febrile conditions, the increased needs of O<sub>2</sub> are met by a shift in ODC to right (Fig. 22.3D).

### Effect of 2,3-BPG

- i. Normally the 2,3-bisphosphoglycerate level is  $15 \pm 1.5$  mg/g Hb. The 2,3-BPG concentration is higher in young children compared to the elderly.
- ii. The 2,3-BPG is produced from 1,3-BPG, an intermediate of glycolytic pathway (see Fig. 9.20).
- iii. The 2,3-BPG, preferentially binds to deoxy-Hb and stabilizes the T conformation. When the T form reverts to the R conformation, the 2,3-BPG is ejected. During oxygenation, BPG is released (Fig. 22.2).
- iv. The high oxygen affinity of fetal blood (HbF) is due to the inability of gamma chains to bind 2,3-BPG.

### Adaptation to High Altitude

1. Increase in the number of RBCs
2. Increase in concentration of Hb inside RBCs
3. Increase in BPG.

### Laboratory Diagnosis

When hemoglobin is examined spectroscopically, oxy-Hb has 2 absorption bands at 540 and 580 nm. When sodium hydrosulfite is added, deoxygenation occurs, the color changes to purple, and the absorption spectrum has only a single broad band at 565 nm. On re-oxygenation by vigorous shaking of the test tube, the absorption spectrum changes to the original.

## TRANSPORT OF CARBON DIOXIDE

At rest, about 200 mL of CO<sub>2</sub> is produced per minute in tissues. The CO<sub>2</sub> is carried by the following 3 ways:

### Dissolved Form

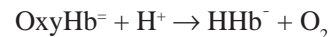
About 10% of CO<sub>2</sub> is transported as dissolved form.



The hydrogen ions thus generated, are buffered by the buffer systems of plasma.

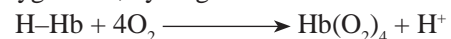
### Isohydric Transport of Carbon Dioxide

- i. Isohydric transport constitutes about 75% of CO<sub>2</sub>. It means that there is minimum change in pH during the transport. The H<sup>+</sup> ions are buffered by the deoxy-Hb and this is called the **Haldane effect**.
- ii. **In tissues:** Inside tissues, pCO<sub>2</sub> is high and carbonic acid is formed. It ionizes to H<sup>+</sup> and HCO<sub>3</sub><sup>-</sup> inside the RBCs. The H<sup>+</sup> ions are buffered by deoxy-Hb and the HCO<sub>3</sub><sup>-</sup> diffuses out into the plasma. In order to maintain ionic equilibrium, chloride ions are taken into RBC (**chloride shift**, Fig. 22.5). Thus, the CO<sub>2</sub> is transported from tissues to lungs, as plasma bicarbonate, without significant lowering of pH. The H<sup>+</sup> are bound by N-terminal NH<sub>2</sub> groups and also by the imidazole groups of **histidine** residues.
- ii. **Oxy-Hb is more negatively charged than deoxy-Hb:** The iso-electric point of oxy-hemoglobin is 6.6, while that of deoxy-Hb is 6.8. Thus oxy Hb is more negatively charged than deoxy Hb. The reaction in tissues may be written as



Therefore, some cation is required to remove the extra negative charge of Oxy-Hb. So H<sup>+</sup> are trapped (Fig. 22.5). Hemoglobin binds 1 proton for every 2 oxygen molecules released. Or, 1 millimol of deoxy Hb can take up 0.6 mEq of H<sup>+</sup>, produced from 0.6 mmol of carbonic acid.

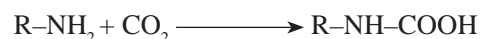
- iii. **In the lungs:** In lung capillaries, where the pO<sub>2</sub> is high, oxygenation of hemoglobin occurs. When 4 molecules of O<sub>2</sub> are bound and one molecule of hemoglobin is fully oxygenated, hydrogen ions are released.



- iv. The protons released in the RBC combine with HCO<sub>3</sub><sup>-</sup> forming H<sub>2</sub>CO<sub>3</sub> which would dissociate to CO<sub>2</sub>, that is expelled through pulmonary capillaries.
- v. As the HCO<sub>3</sub><sup>-</sup> level inside the erythrocyte falls, more and more HCO<sub>3</sub><sup>-</sup> gets into the RBC, and chloride diffuses out (**reversal of chloride shift**) (Fig. 22.6).

### Carriage as Carbamino-Hemoglobin

The rest 15% of CO<sub>2</sub> is carried as carbamino-hemoglobin, without much change in pH. A fraction of CO<sub>2</sub> that enters into the red cell is bound to Hb as a carbamino complex.





The N-terminal amino group (valine) of each globin chain forms carbamino complex with carbon dioxide. Deoxy-hemoglobin binds  $\text{CO}_2$  in this manner more readily than oxy-hemoglobin.

Clinical applications are shown in Box 22.2.

## Fetal Hemoglobin (HbF)

- HbF has 2 alpha chains and 2 gamma chains. Gamma chain has 146 amino acids.
- The differences in physicochemical properties when compared with HbA are:
  - Increased solubility of deoxy HbF
  - Slower electrophoretic mobility for HbF

### Box 22.2: Clinical applications of oxygen dissociation curve

- In all hypoxic states, the  $\text{O}_2$  affinity is decreased with a shift in ODC to the right and an increase in 2,3-BPG inside RBC. The **adaptation** to the high altitude where  $\text{pO}_2$  is low, includes increased pulmonary ventilation, polycythemia and increase in 2,3-BPG level with a shift in ODC to right.
- In **anemia**, where the total concentration of Hb is reduced, increased oxygen unloading alone will ensure proper oxygenation of tissues.
- In many cases 2,3-BPG level varies inversely as the hemoglobin concentration.
- In chronic **pulmonary diseases** and cyanotic cardiac diseases also the 2,3-BPG level is increased ensuring maximum unloading of  $\text{O}_2$  to tissues.
- The red cell 2,3-BPG level is decreased in **acidosis** and increased in **alkalosis**. Hence, the expected shift in ODC to the right or left is not observed.
- Transfusion of large volumes of stored blood, which has a low level of 2,3-BPG can lead to sudden hypoxia, since it can cause a left-shifted ODC.

- Increased resistance of HbF to alkali denaturation
- HbF has decreased interaction with 2,3-BPG.

- The ODC of fetus and newborn are shifted to left. This increase in  $\text{O}_2$  affinity is physiologically advantageous in facilitating transplacental oxygen transport. The major reason is the diminished binding of 2,3-BPG to HbF. When  $\text{pO}_2$  is 20 mm Hg, the HbF is 50% saturated.
- The synthesis of HbF starts by 7th week of gestation; it becomes the predominant Hb by 28th week. At birth, 80% of Hb is HbF. During the first 6 months of life, it decreases to about 5% of total. There is a rapid post-natal rise in 2,3-BPG content of RBC. However, HbF level may remain elevated in children with anemia and beta thalassemia, as a compensatory measure.

## Molecular Basis of HbF to HbA Switch

The molecular mechanism of “switching off” gamma chain synthesis and “switching on” beta chain synthesis is still not completely understood. However, recent studies have shown the regulatory effects of transcription factors like KLF1 (Krupel like factor 1) and BCL II A (B cell lymphoma/leukemia IIA) on the switch from HbF to HbA. These factors have a repressive effect on gamma globin chain gene. Further studies using gene knockout mice explores the therapeutic potential of inducing the expression of gamma chain gene in beta thalassemia and sickle cell anemia using RNA interference targeting KLF1 gene. KLF positively regulates BCLIIA expression which binds directly to beta globin chain locus.

## Hemoglobin A2

It is a normal hemoglobin; it is about 2% of total Hb. It has 2 alpha chains and 2 delta chains. The delta chain has sequence homology with beta chain. In beta thalassemia, as a compensation, HbA<sub>2</sub> is increased. The iso-electric pH of

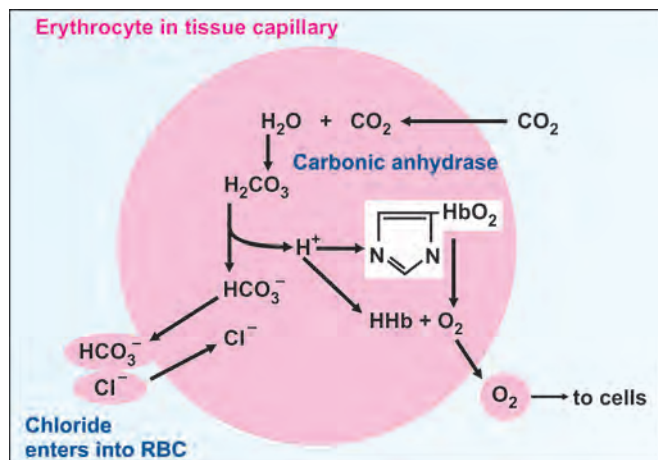


Fig. 22.5: Chloride shift; reactions in tissues

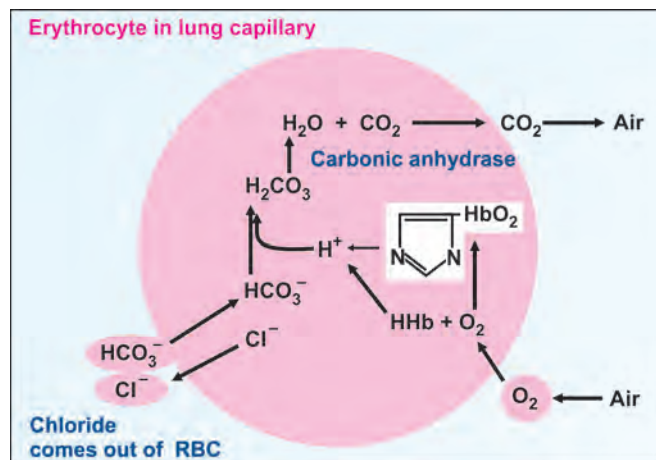


Fig. 22.6: Chloride shift; reactions in lungs

HbA<sub>2</sub> is 7.4, while HbA has the pI value of 6.85. So, HbA<sub>2</sub> is slower moving on electrophoresis.

### Embryonic Hemoglobins

Several hemoglobins are found during fetal life, but absent in adult life. Examples are Hb Gower-1 (2 zeta and 2 epsilon chains); Gower-2 (2 alpha chains and 2 epsilon chains); Hb Portland (2 gamma and 2 delta chains). Embryonic hemoglobins are produced from 3rd to 8th weeks of gestation, when the site of erythropoiesis is in liver.

## HEMOGLOBIN DERIVATIVES

Hemoglobin derivatives are formed by the combination of different ligands with the heme part, or change in the oxidation state of iron. Oxy-Hb is dark red, deoxy-Hb is purple, met-Hb is dark brown, CO-Hb is cherry red and sulph-Hb is green in color. Normally concentration of deoxy-Hb is less than 5% of the total Hb. If the level increases **cyanosis** occurs.

### Carboxy-Hemoglobin (Carbon Monoxy Hb) (CO-Hb)

- Hemoglobin binds with carbon monoxide (CO) to form carboxy-Hb. The affinity of CO to Hb is 200 times more than that of oxygen. It is then unsuitable for oxygen transport.
- When one molecule of CO binds to one monomer of the hemoglobin molecule, it increases the affinity of others to O<sub>2</sub>; so that the O<sub>2</sub> bound to these monomers are not released. This would further decrease the availability of oxygen to the tissues.
- Carbon monoxide poisoning:** CO is a colorless, odorless, tasteless gas generated by incomplete combustion. CO poisoning is a major occupational hazard for workers in mines. Breathing the automobile exhaust in closed space is the commonest cause for CO poisoning. The carboxy-Hb level in normal people is 0.16%. An average smoker has an additional 4% of CO-Hb. One cigarette liberates 10–20 mL carbon monoxide into the lungs.
- Clinical manifestations:** Clinical symptoms manifest when carboxy-Hb levels exceed 20%. Symptoms are breathlessness, headache, nausea, vomiting, and pain in chest. At 40–60% saturation, death can result.
- Administration of O<sub>2</sub> is the treatment. In severe cases, oxygen under high pressure (hyperbaric oxygen) is helpful.

- The absorption bands of carboxy-Hb is similar to that of oxy-Hb. But on adding a reducing agent like sodium dithionite, it fails to convert carboxy-Hb to deoxy-Hb; whereas oxy-Hb is converted.

### Met-hemoglobin (Met-Hb)

- When the ferrous (Fe<sup>++</sup>) iron is oxidized to ferric (Fe<sup>+++</sup>) state, met-Hb is formed.
- Small quantities of met-Hb formed in the RBCs are readily reduced back to the ferrous state by met-Hb reductase enzyme systems. About 75% of the reducing activity is due to enzyme system using **NADH** and cytochrome b5 (Fig. 22.7).
- Another 20% of the reducing activity is due to **NADPH** dependent system.
- Glutathione** dependent Met-Hb-reductase accounts for the rest 5% activity.

### Met-hemoglobinemias

Normal blood has only less than 1% of met-hemoglobin. It has markedly decreased capacity for oxygen binding and transport. An increase in met-hemoglobin in blood, (met-hemoglobinemia) is manifested as **cyanosis**. Causes may be congenital or acquired.

### Congenital Met-hemoglobinemia

Cytochrome b5 reductase deficiency is characterized by cyanosis from birth. Presence of Hb variants like HbM can cause congenital met-hemoglobinemia. 10–15% of hemoglobin may exist as met-hemoglobin. Oral administration of methylene blue, 100–300 mg/day or ascorbic acid 200–500 mg/day decreases met-Hb level to 5–10% and reverses the cyanosis.

### Acquired or Toxic Met-hemoglobinemia

- Met-hemoglobinemia may develop by intake of water containing nitrates or due to absorption of aniline dyes.

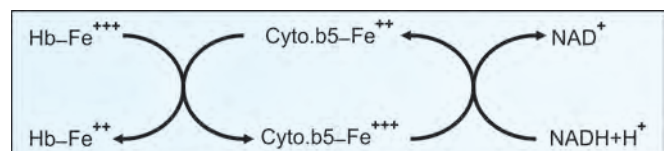


Fig. 22.7: Met-hemoglobin reductase system

Aniline dye workers have been known to develop met-hemoglobinemia.

- ii. Drugs which produce met-hemoglobinemia are—acetaminophen, phenacetin, sulfanilamide, amyl nitrite, and sodium nitroprusside.
- iii. **Glucose-6-phosphate dehydrogenase deficiency:** In persons with this enzyme deficiency, the condition may be manifested even with small doses of drugs. In such persons, NADPH is not available in the RBC. Therefore in such individuals, disease is manifested easily (see Chapter 23). In such patients, intravenous leukomethylene blue 2 mg/kg is effective, which will substitute for the NADPH.

### Laboratory Analysis

Ferricyanide can oxidize oxy- or deoxy-Hb to met-Hb. The color changes to dark brown and absorption spectra show a band in the red with its center at 633 nm, while the bands for Oxy-Hb persist. Sodium hydrosulfite or dithionite reconverts met-Hb to oxy-Hb.

### Hemin Crystals

When iron is oxidized to  $Fe^{+++}$ , it has a net positive charge. It can combine with negatively charged chloride, to form hemin or hematin chloride. Hemin crystals can be prepared from even very old blood stains in medicolegal cases. Blood or eluted blood stains are heated with Nippe's fluid (1% solution of KCl, KBr and KI in glacial acetic acid) over a glass slide, when dark brown rhombic crystals are seen under the microscope. The test is sensitive, but is answered by the heme part of blood of all species.

### Sulf-hemoglobinemia

When hydrogen sulfide acts on oxy-hemoglobin, sulf-hemoglobin is produced. It can occur in people taking drugs like sulfonamides, phenacetin, acetanilide, dapson, etc. It cannot be converted back to oxy-hemoglobin. It is seen as basophilic stippling of RBC, throughout its lifespan.

#### Box 22.3: Hemoglobinopathy and thalassemia

Abnormalities in the primary sequence of globin chains lead to **hemoglobinopathies**, e.g. HbS.

Abnormalities in the rate of synthesis would result in **thalassemias**. In other words, normal globin chains in abnormal concentrations result in thalassemias e.g. beta thalassemia.

### Nitric Oxide

Hemoglobin binds nitric oxide (NO) with high affinity similar to binding of carbon monoxide (CO). The NO is delivered at its site of action, i.e. capillary endothelium. The positive cooperative effect and effect of  $H^+$  also play a role in the binding and delivery of NO. Binding of NO by hemoglobin increases its half-life. The heme iron preferentially binds NO in the T conformation. When hemoglobin acquires the R conformation, the NO is transferred to a cysteinyl SH group on the beta chain and then to the SH group of a small molecule like GSH, when R form reverts to T state. The X-S-NO complex is biologically very potent and even under low oxygen tension delivers NO to tissue capillaries.

### Glycated Hemoglobin

Described in detail in Chapter 24.

## HEMOGLOBIN (GLOBIN CHAIN) VARIANTS

In humans, alpha chain genes are located on chromosome No. 16 and beta type genes are clustered in chromosome No. 11.

### Hemoglobinopathies

Hundreds of hemoglobin variants leading to hemoglobinopathies have been discovered (Box 22.3). The variants may be either alpha chain variants or beta chain variants. In addition, although rare, gamma and delta chain variants have also been described (Table 22.2).

The hemoglobin variants may be classified into 5 major types, based on their clinical manifestations.

**TABLE 22.2:** Important hemoglobinopathies

Hemoglobin	Point mutation position	Amino acid substitution	Codon and base substitution
HbS	Beta 6	Glu → Val	GAG → GUG
HbC	Beta 6	Glu → Lys	GAG → AAG
HbE	Beta 26	Glu → Lys	GAG → AAG
HbD (Punjab)	Beta 121	Glu → Gln	GAG → CAG
HbM	Proximal or distal histidine in $\alpha$ or $\beta$ chains	His → Tyr	CAC → UAC

### Sickle Syndromes

- A. Sickle-cell trait (AS)
- B. Sickle-cell disease with SS, SC, SD, SO varieties and S beta thalassemia.

### Unstable Hemoglobins

Congenital Heinz body anemia; Hb Zurich.

Unstable Hb variants have an increased tendency to denature and hence tend to form molecular aggregates within cells which lead to increased hemolysis. Heinz bodies are stained purple with cresyl violet. Their occurrence in RBC indicates that the cells have been subjected to oxidative stress. The membrane bound Heinz bodies alter the surface of the red cells, creating indentations. As a result, they have a tendency of getting trapped in the spleen. So, lifespan of the RBC is reduced. Patients will have moderate to severe anemia.

### Hemoglobins with Abnormal Oxygen Affinity

- A. High affinity—Polycythemia (familial): Hb Chesapeake
- B. Low affinity—Cyanosis (familial): HbM.

### Structural Variations Leading to Thalassemia

- A. Alpha thalassemia—Hb Constant spring, delta beta thalassemia, Hb Lepore
- B. Beta thalassemia: Hb Quong size (Hb QS)

### Non-symptomatic Hemoglobin Variants

HbP, Q, N, J, etc.

### Hemoglobin S (HbS) (Sickle Cell Hemoglobin)

Of the hemoglobin variants, HbS constitutes the **most common** variety worldwide. In 1949 Linus Pauling (Nobel prize, 1954) established that a hemoglobin with abnormal electrophoretic mobility is responsible for the sickling disease.

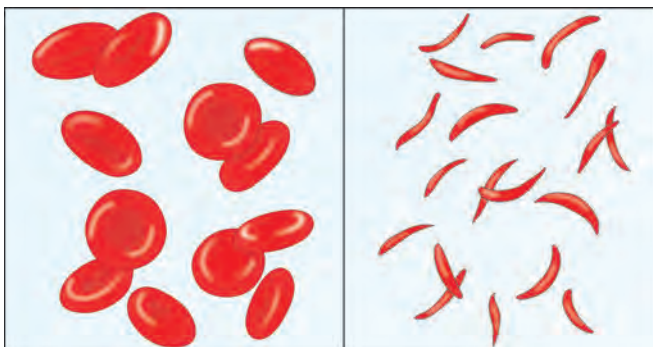


Fig. 22.8A: Left side, normal RBCs. Right side, sickle cells

### Sickle Cell Disease

- i. The glutamic acid in the **6th position** of beta chain of HbA is changed to valine in HbS (Fig. 22.8C). This single amino acid substitution leads to polymerization of hemoglobin molecules inside RBCs. This causes a distortion of cell into sickle shape (Fig. 22.8A).
- ii. The substitution of hydrophilic glutamic acid by hydrophobic valine causes a localized stickiness on the

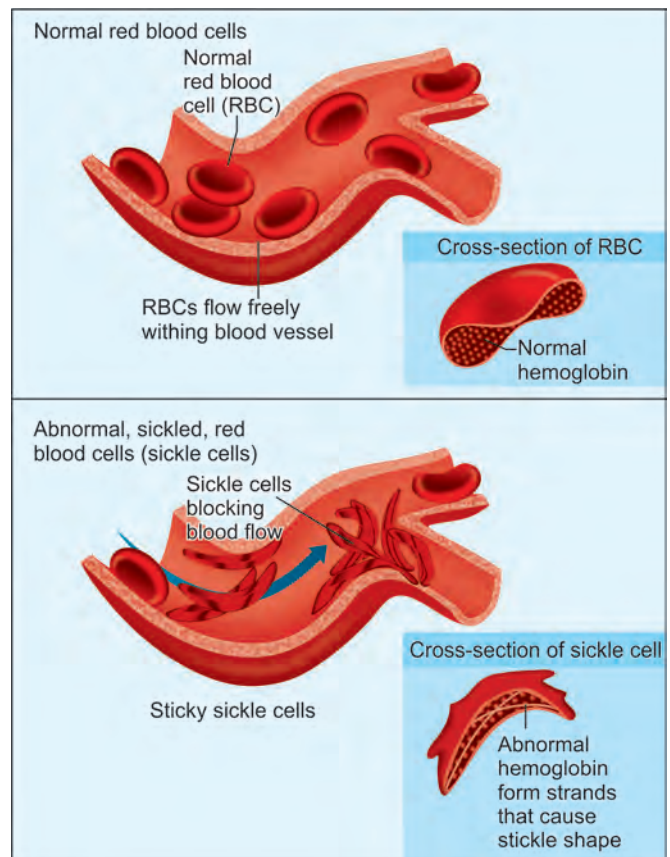


Fig. 22.8B: Mechanism of vascular occlusion in sickle cell anemia

Molecular differences of HbA, HbS and HbC								
<b>HbA</b>								
Val	His	Leu	Thr	Pro	Glu	Glu	Lys	~~~~~
1	2	3	4	5	6	7	8	
<b>HbS</b>								
Val	His	Leu	Thr	Pro	Val	Glu	Lys	~~~~~
1	2	3	4	5	6	7	8	
<b>HbC</b>								
Val	His	Leu	Thr	Pro	Lys	Glu	Lys	~~~~~
1	2	3	4	5	6	7	8	

Fig. 22.8C: Molecular changes in HbS and HbC



surface of the molecule (Fig. 22.9). The deoxygenated HbS may be depicted with a protrusion on one side and a cavity on the other side, so that many molecules can adhere and polymerize.

- iii. HbA and HbF will prevent sickling, because they do not co-polymerize with HbS. HbS can bind and transport oxygen. The sickling occurs under deoxygenated state.
- iv. The sickled cells form small plugs in capillaries. Occlusion of major vessels can lead to infarction in organs like spleen (Fig. 22.8B). Death usually occurs in the second decade of life.
- v. The heterozygous state is very common in Central and West Africa as well as in East and Central parts of India. Tribals all over India show an increased incidence of SS and AS. The slave trade has played an important role in spreading the gene from Africa to different parts of America.

### Sickle Cell Trait

- i. In heterozygous (AS) condition, 50% of Hb in the RBC is normal. Therefore, the sickle cell trait as such does not produce clinical symptoms. Such persons can have a normal lifespan.
- ii. At higher altitudes, **hypoxia** may cause manifestation of the disease. Chronic **lung disorders** may also produce hypoxia-induced sickling in HbS trait.

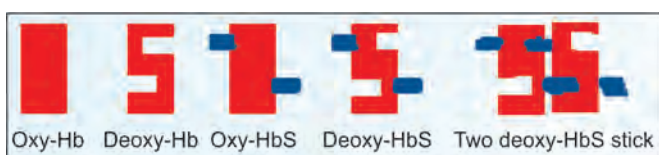


Fig. 22.9: Sticky patches on HbS molecule

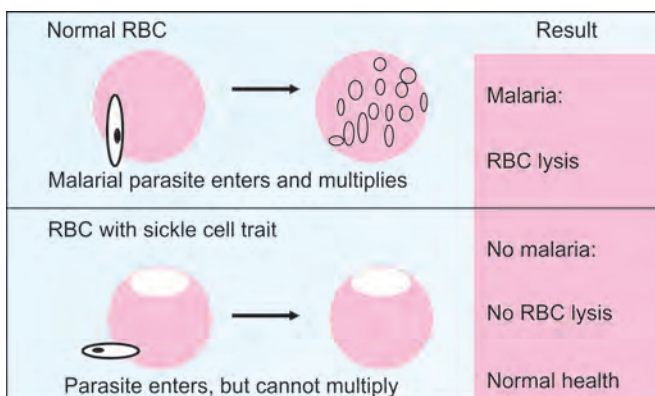


Fig. 22.10: Sickle cell trait protects from malaria

- iii. In the electrophoresis, the abnormal HbS can be detected along with normal Hb in persons with HbS trait (Fig. 22.11).
- iv. **HbS gives protection against malaria:** The high incidence of the sickle cell gene in population coincides with the area endemic for malaria. HbS affords protection against *Plasmodium falciparum* infection (Fig. 22.10). Hence the abnormal gene was found to offer a biologic advantage.

### Electrophoresis

Electrophoresis at alkaline pH shows a slower moving band than HbA. At pH 8.6, carboxyl group of glutamic acid is negatively charged. Lack of this charge on HbS makes it less negatively charged, and decreases the electrophoretic mobility towards positive pole (Fig. 22.11). At acidic pH, HbS moves faster than HbA. In sickle cell trait, both the bands of HbA and HbS can be noticed (Fig. 22.11).

### Sickling Test

A blood smear is prepared. Add a reducing agent such as sodium dithionite. Blood smear examined under the microscope shows sickled RBCs (Fig. 22.8A).

### Management of Sickle Cell Disease

Repeated blood transfusions may be required in severe anemia. But this can lead to iron overload and cirrhosis. Treatment with anti-sickling agents like hydroxyurea, cyanate and aspirin, that interfere with polymerization are tried. Sodium butyrate will induce HbF production with clinical improvement.

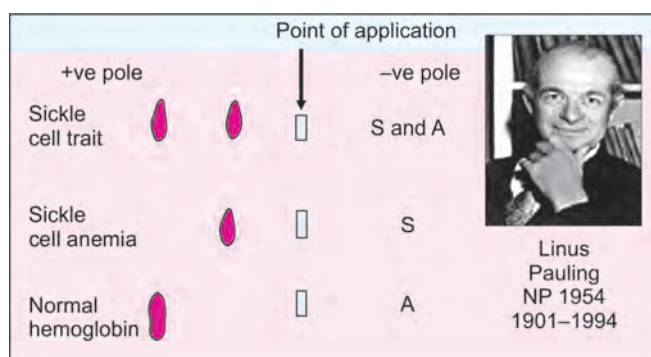


Fig. 22.11: Electrophoresis at pH 8.6

### Hemoglobin E

It is the **second most prevalent** hemoglobin variant. It is due to the replacement of beta 26 glutamic acid by Lysine (Table 22.2). It is primarily seen in orientals of South-East Asia (Thailand, Myanmar, Bangladesh, etc). The variant is very prevalent in West Bengal in India. Heterozygotes are completely asymptomatic. HbE has similar mobility as of A2 on electrophoresis.

### Hemoglobin C

In normal HbA, 6th amino acid in beta chain is glutamic acid; it is replaced by lysine in HbC (Table 22.2 and Fig. 22.8C). The presence of HbC is seen mostly in the black race. AC heterozygotes do not show any clinical manifestations. But those who are double heterozygous for HbS and HbC (SC) have a moderate disease. Homozygotes (CC) have a mild to moderate hemolytic anemia. The HbC is slower moving than HbA on electrophoresis at alkaline pH.

### Hemoglobin D

It does not produce sickling. HbD Punjab results from replacement of beta 121 glutamic acid by glutamine (HbD Punjab) (Table 22.2). HbD migrates similar to HbS on electrophoresis. HbSD disease is a severe condition. HbD Punjab is the commonest Hb variant seen in Punjabi population.

### M-Hemoglobins (Hb M)

These are a group of variants, where the substitution occurs in the proximal or distal histidine residues of alpha or beta chains.

Alpha 58 His → Tyr (Hb M Boston)

Beta 92 His → Tyr (Hb M Hyde Park)

As a result, the heme has a tendency to get oxidized to hemin, forming **met-hemoglobin**. Oxygen binding is decreased. This would result in **cyanosis**.

### Inheritance of Hemoglobin Variants

- They are inherited as codominant/**recessive** traits. One beta chain gene is inherited from each parent. If both parents are heterozygous for S, (the abnormal gene), there is 50% chance that the child will be AS, 25% chance for AA and 25% chance for SS genotype (inheritance is described in Chapter 42).
- If the genotype is SS, all the Hb molecules produced are abnormal, and hence disease is manifested.

- If one parent is heterozygous for HbS and another for C or beta thalassemia, 25% chances are that the child will be a double heterozygote (Fig. 22.12).
- An individual inherits only 2 beta chain genes; but **4 alpha chain genes** are inherited. So, the alpha chain variants constitute only 25% of the total hemoglobin in circulation and are less likely to produce impairment of red cell function (codominant inheritance). Thus beta chain disease is more common and more severe than alpha chain disease.

## THALASSEMIAS

- The name is derived from the Greek word, "thalassa", which means "sea". Greeks identified this disease present around Mediterranean sea. It is the most common genetic disease and has a carrier frequency of about 7% across the globe. The disease is also prevalent in India.
- Thalassemia may be defined as the normal hemoglobins in abnormal proportions (Box 22.3). The gene function is abnormal, but there is no abnormality in the polypeptide chains.
- Reduction in alpha chain synthesis is called alpha thalassemia, while deficient beta chain synthesis is beta thalassemia. Other types like delta-beta thalassemia, Hb Lepore, hereditary persistence of HbF (HPF) are related conditions.

### Beta Thalassemia

Beta thalassemia is more common than alpha variety. Beta type is characterized by a decrease or absence of synthesis of beta chains. As a compensation, gamma or delta chain synthesis is increased.

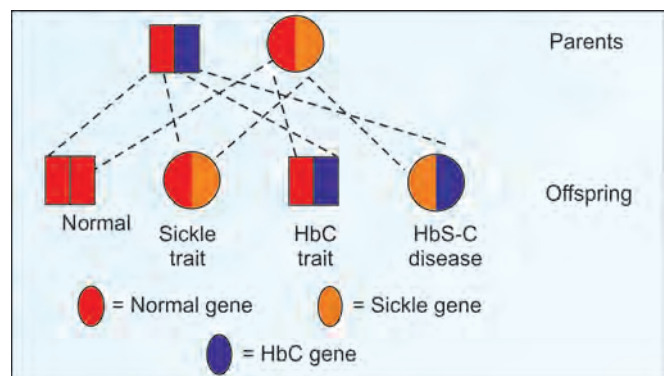


Fig. 22.12: Inheritance of HbS-C disease

### Inheritance

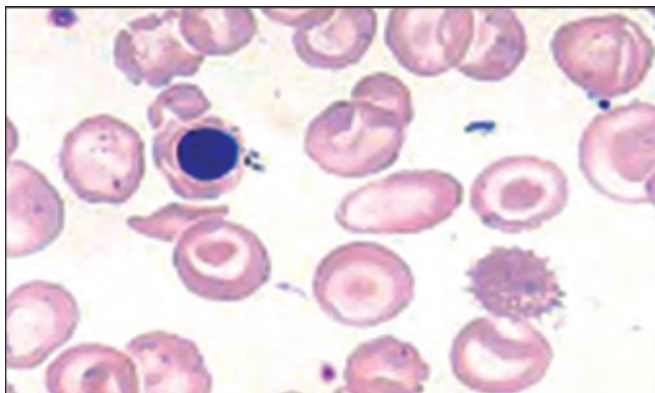
Beta thalassemias are phenotypically described as beta (+) or beta (o) depending on whether there is beta chain synthesis or not. Beta (o) thalassemia may result from base substitutions. Beta (+) thalassemias are produced from defects in post-transcriptional processing of mRNA.

### Alpha Thalassemias

They may result from different types of gene deletions. Since there are two pairs of alpha genes per cell, a single gene deletion in one chromosome or a pair of genes in the chromosomes does not have much effect on a chain production. Alpha thalassemia is rarer because alpha chain deficiency is incompatible with life.

### Thalassemia Syndromes

- i. These syndromes are mainly seen in people of Asian, African and Mediterranean origin. All cases of thalassemias are characterized by **deficiency of HbA** synthesis.
- ii. Hypochromic microcytic anemia.
- iii. In homozygous state, clinical manifestations are severe, and hence called **Thalassemia major**. There will be nucleated RBCs in peripheral circulation (Fig. 22.13).
- iv. In heterozygous conditions, the clinical signs and symptoms are minimal; they are called **Thalassemia minor**.
- v. The synthesis of unaffected chains occurs at the normal rate. Since they do not have complementary chains to bind, they form aggregates and precipitate



**Fig. 22.13:** Thalassemia. Nucleated RBC, target cells, spherocytosis, poikilocytosis are seen

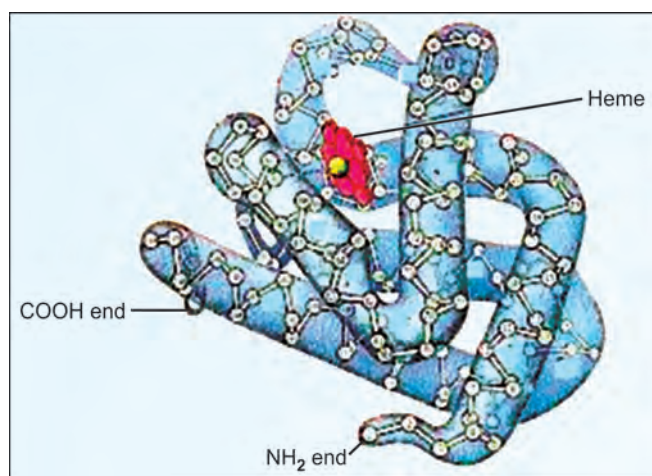
- within the cell. These precipitates or **inclusion bodies** lead to membrane damage and destruction of red cells.
- vi. The co-existence of HbS and beta thalassemia trait is fairly common.
  - vii. Homozygous beta thalassemia is characterized by severe anemia, hypersplenism and hepatosplenomegaly. The marrow in the skull bones expand producing the “hair-on-end appearance” described in X-ray.
  - viii. Repeated transfusion is the only available treatment. This may lead to iron overload. Splenectomy may also lessen the anemia. Marrow transplantation has been successfully tried in a few cases.

### Hemoglobin Lepore

It is composed of 2 alpha chains and 2 delta-beta chimeric chains. The N-terminal made up of delta chain and C-terminal is made of beta chain. Nonhomologous crossing over of the chromosomes is the cause for this chimera.

### MYOGLOBIN

- i. It is seen in muscles. Myoglobin (MB) content of skeletal muscle is 2.5 g/100 g; of cardiac muscle is 1.4 g% and of smooth muscles 0.3 g%.
- ii. Mb is a **single polypeptide** chain (Fig. 22.14). Human Mb contains 152 amino acids with a molecular weight of 17,500 Daltons.
- iii. One molecule of Mb can combine with 1 molecule of oxygen. The Hb carries oxygen from lungs to tissue



**Fig. 22.14:** Myoglobin chain



capillaries, from where oxygen diffuses into tissues. In the muscles, the oxygen is taken up by Mb for the sake of tissue respiration.

- iv. Mb has **higher affinity for oxygen** than that of Hb. The  $pO_2$  in tissue is about 30 mm of Hg, when Mb is 90% saturated. At this  $pO_2$ , Hb saturation will be only 50%.
- vii. In severe physical exercise,  $pO_2$  in muscles lowers to 5 mm Hg, when myoglobin releases all the bound oxygen.
- viii. Mb has a high oxygen affinity while Bohr effect, cooperative effect and 2,3-BPG effect are absent.

### Myoglobin in Urine and Blood

Severe crush injury causes release of myoglobin from the damaged muscles. Being a small molecular weight protein, Mb is excreted through urine (myoglobinuria). Urine color becomes dark red.

Myoglobin will be released from myocardium during myocardial infarction (MI), and is seen in serum. Serum

myoglobin estimation is one of the biomarkers for MI (see Chapter 23).

## ANEMIAS

In India, anemia is the most common medical problem. Perhaps about 75% of patients attending a primary health center may have signs and symptoms directly or indirectly related to anemia. Anemia results when the Hb concentration in blood is reduced. Normal value for Hb in normal male is 14 to 16 g/dL and in female 13 to 15 g/dL. If the Hb level is below 10 g/dL, it is a severe condition.

The most common cause for anemia in India, is **iron deficiency** which is described in Chapter 39. A list of other causes is given in Box 22.4. Common symptoms of anemia are shown in Figure 22.15.

### HEMOLYTIC ANEMIA

Erythrocyte having 7–8 microns in diameter, can pass through 3 micron diameter capillaries.

Red cell deformability is influenced by 3 cellular components:

1. Cell shape or cell geometry: ratio of cell surface area to cell volume, higher SA/V value facilitate deformation
2. Cytoplasmic viscosity, which is primarily regulated by the MCHC (mean corpuscular hemoglobin concentration)
3. Membrane deformability and stability.

Normal human RBC has a volume of 90 femtoliters (fl) and a surface area of 140  $\mu m^2$ . If the red cells were a sphere of identical volume, it would have a surface area of only 98  $\mu m^2$ . Thus the discoid

#### Box 22.4: Causes of anemias

1. **Hemolysis due to Impaired Production of RBCs**
  - a. **Defect in heme synthesis:** Nutritional deficiency of iron, copper, pyridoxal phosphate, folic acid, vitamin  $B_{12}$  or vitamin C. Lead will inhibit heme synthesis.
  - b. **Defect in regulators:** Erythropoietin synthesis is reduced in chronic renal failure.
  - c. **Defect in stem cells:** Aplastic anemia due to drugs (e.g. Chloramphenicol), infections or malignant infiltrations.
2. **Hemolysis due to Intracorporeal Defect**
  - a. **Hemoglobinopathies** such as HbS, HbC, HbM
  - b. **Thalassemias**—major and minor
  - c. **Abnormal shape:** Spherocytosis and elliptocytosis.
  - d. **Enzyme deficiencies:** Deficiency of glucose-6-phosphate dehydrogenase (see Chapter 23).
3. **Hemolysis due to Extracorporeal Causes**
  - a. **Infections:** Malarial parasites
  - b. **Autoimmune hemolysis:** Antibodies are seen against RBC membrane components.
  - c. **Isoimmune hemolysis:** Rh incompatibility.
  - d. **Hemolysis due to drug sensitization:** Many drugs (e.g. alpha-methyl dopa, quinine) may fix on RBC membrane, and produce antibodies against the altered membrane.
4. **Hemorrhage**  
Hematuria, hematemesis, hemoptysis, peptic ulcer metrorrhagia and hemorrhoides are the usual causes for hemorrhage. Hemophilia (absence of AHG) and thrombocytopenia are other major causes for bleeding tendencies.

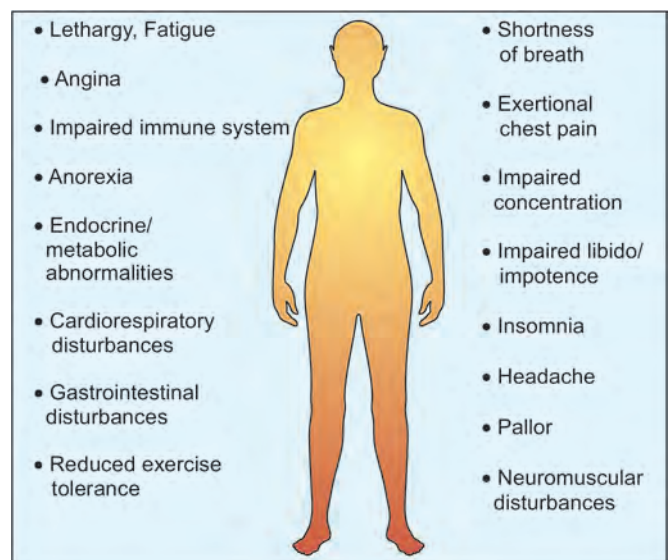


Fig. 22.15: Common symptoms of anemia



shape provides an extra 43% that allows the red cell to undergo extensive deformation. Normal RBC can undergo large radial extension of up to 230% of its original radial dimension; but an increase of even 3% in surface area results in cell lysis.

### Clinical Case Study 22.1

During a winter day morning, an elderly couple were taken to the emergency department, when their son noticed that they were both in a confused state. The couple had been in good health. The previous night was bitterly cold, and so the elderly couple kept the coal furnace in the bedroom throughout the night. In the morning, they both complained that they had severe headache, confusion, fatigue and nausea.

On arrival at the emergency department, both patients were afebrile with normal vital signs. Their lips appeared to be very red. Both patients were slightly confused. The physical examinations were within normal limits. Carboxyhemoglobin levels were elevated.

1. What is the most likely cause of these patients' symptoms?
2. What is the biochemical rationale for 100% O<sub>2</sub> being the treatment of choice?

### Clinical Case Study 22.2

A 15-year-old Indian aboriginal girl presents to the emergency room with complaints of bilateral thigh and hip pain. The pain has been present for 1 day and is steadily increasing in severity. Acetaminophen and ibuprofen have not relieved her symptoms. She denies any recent trauma or excessive exercise.

She reported fatigue and burning sensation during urination. She reports having similar pain episodes in the past, sometimes requiring hospitalization. On examination, she is afebrile. Her conjunctiva and mucosal membranes are slightly pale in color. She has nonspecific bilateral anterior thigh pain with no abnormalities appreciated. The remainder of her examination is completely normal. Her white blood cell count is elevated at 17,000/mm<sup>3</sup>, and her hemoglobin (Hb) level is decreased to 7.1 g/dL. The urinalysis demonstrated an abnormal number of numerous bacteria.

1. What is the most likely diagnosis?
2. What is the molecular genetics behind this disorder?
3. What is the pathophysiologic mechanism of her symptoms?

### Clinical Case Study 22.3

A 25-year-old female presents to her obstetrician at 12-weeks gestation. This is her first pregnancy, and she is concerned about her baby and the risk of inheriting a "blood" disease like others in her family. Her brother had died at age 10 due to severe anemia.

Her ultrasound confirmed an intrauterine pregnancy at 12-weeks gestation. The patient's hemoglobin level shows a hypochromic, microcytic anemia. Hemoglobin electrophoresis demonstrated increased fetal hemoglobin level, a pattern consistent with  $\alpha$ -thalassemia minor.

1. What is the molecular genetics behind this disorder?
2. What was the likely test and what is the biochemical basis?

### Clinical Case Study 22.1 Answer

Most likely cause: Carbon monoxide poisoning (increase carboxyhemoglobin level).

Rationale for treatment: Administration of 100% O<sub>2</sub> displaces CO from hemoglobin.

Carbon monoxide binds very avidly to hemoglobin. It is a colorless and odorless gas and may arise from internal combustion engines, fossil-fueled home appliances (heaters, furnaces, stoves). It does not give warning signs. The patient generally has confusion and symptoms of O<sub>2</sub> deprivation, but not the symptoms of dyspnea, since the hemoglobin is saturated. The lips are a distinct red color as a result of the hemoglobin being "oxygenated." However, because CO binds so avidly to the hemoglobin, no transfer of O<sub>2</sub> occurs in the peripheral tissue. Treatment is thus 100 percent O<sub>2</sub> to displace the CO from the hemoglobin.

### Clinical Case Study 22.2 Answer

Most likely diagnosis: Sickle cell disease (pain crisis).

Biochemical mechanism of disease: Single amino acid substitution on hemoglobin beta chain, inherited in an autosomal recessive fashion. The sickled red blood cells cause infarction of bone, lung, kidney, and other tissue from vaso-occlusion.

The patient's description of pain is typical of a sickle cell pain crisis. Often infection is a trigger, most commonly pneumonia or a urinary tract infection. Here, symptoms are consistent with a urinary tract infection, indicated by

burning with urination (dysuria). Her white blood cell count is elevated in response to the infection. The low hemoglobin level is consistent with sickle cell anemia. Since she is homozygous (both genes coding for sickle hemoglobin), both her parents have sickle cell trait (heterozygous) and thus do not have symptoms. The diagnosis can be established with hemoglobin electrophoresis.

### Clinical Case study 22.3 Answer

Molecular genetics: Impaired production of  $\beta$  globin peptide chain.

Likely test: Oligonucleotide probe. After chorionic villus sampling is performed, a radioactive probe can be used and hybridized with specific genetic mutations in the fetus' deoxyribonucleic acid (DNA), allowing for prompt detection and prenatal diagnosis.

The most common cause of anemia is iron deficiency. Another common cause of microcytic anemia is thalassemia. Certain ethnic groups have higher incidence of thalassemia.

The microcytic (small red blood cell size) anemia with elevated hemoglobin A2 and F is consistent with  $\beta$ -thalassemia minor. Patients with  $\beta$ -thalassemia major (Cooley anemia) typically have severe anemia requiring frequent transfusions and shortened life expectancy. Infants will appear healthy after birth, but as the hemoglobin F levels fall, the infant becomes severely anemic.

## QUICK LOOK OF CHAPTER 22

1. Hemoglobin (Hb) is a globular protein containing 2 alpha 2 beta (HbA), 2 alpha 2 gamma (HbF), 2 alpha 2 delta (HbA2). Alpha chain has 141 amino acids while beta, gamma and delta have 146 amino acids.
2. The quaternary structure of oxy Hb is R form, while that of deoxy Hb is T form, which is stabilized further by 2,3 BPG.
3. The ability of Hb to load and unload  $O_2$  at physiological  $pO_2$  is shown by the  $O_2$  dissociation curve and its sigmoid shape is due to the allosteric effect (cooperativity). The influence of pH and  $pCO_2$  to facilitate oxygenation of Hb in lungs and deoxygenation at the tissue is known as Bohr effect. Entry of  $Cl^-$  from plasma to cells to establish neutrality for the  $HCO_3^-$  out to the plasma is called Chloride shift.
4. HbF moves slower than HbA on electrophoresis, is resistant to alkali denaturation, has decreased interaction with 2,3 BPG.
5. Hb S is sickle cell Hb resulting from a Glu-Val substitution at the 6<sup>th</sup> position on the beta chain. HbS gives protection against malaria.
6. Thalassemias are caused due to functional abnormality of alpha or beta chains of Hb. Homozygous states exhibit Thalassemia major while heterozygous state exhibit Thalassemia minor.



# SECTION C

## Clinical and Applied Biochemistry

- Chapter 23 Clinical Enzymology and Biomarkers
- Chapter 24 Regulation of Blood Glucose; Insulin and Diabetes Mellitus
- Chapter 25 Hyperlipidemias and Cardiovascular Diseases
- Chapter 26 Liver and Gastric Function Tests
- Chapter 27 Kidney Function Tests
- Chapter 28 Plasma Proteins
- Chapter 29 Acid-Base Balance and pH
- Chapter 30 Electrolyte and Water Balance
- Chapter 31 Body Fluids (Milk, CSF, Amniotic Fluid, Ascitic Fluid)
- Chapter 32 Metabolic Diseases
- Chapter 33 Free Radicals and Antioxidants
- Chapter 34 Clinical Laboratory; Quality Control
- Chapter 35 General Techniques for Separation, Purification and Quantitation





# CHAPTER 23

## Clinical Enzymology and Biomarkers

### Chapter at a Glance

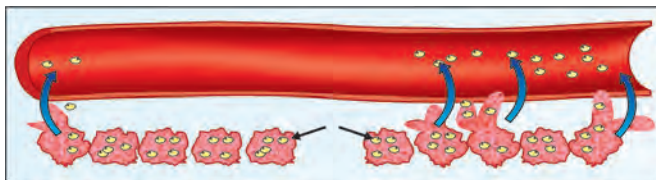
The reader will be able to answer questions on the following topics:

- Lactate dehydrogenase
- Creatine kinase
- Alkaline phosphatase
- Acid phosphatase
- Prostate specific antigen
- Cholinesterase
- Glucose-6-phosphate dehydrogenase
- Amylase and lipase
- Enzymes used as therapeutic agents

### CLINICAL ENZYMOLOGY

Plasma contains many functional enzymes, which are actively secreted into plasma. For example, enzymes of blood coagulation.

On the other hand, there are a few **non-functional enzymes** in plasma, which are coming out from cells of various tissues due to normal wear and tear. Their normal levels in blood are very low; but are drastically increased during cell death (necrosis) or disease (Fig. 23.1A). Therefore, assays of these enzymes are very useful in **diagnosis of diseases**.



**Fig. 23.1A:** Increased plasma levels of intracellular enzymes due to cell damage

### Cardiac Biomarkers

A biomarker is a clinical laboratory test which is useful in detecting dysfunction of an organ. Cardiac biomarkers are used to detect cardiac diseases, which may be:

- a. Acute coronary syndrome resulting from myocardial ischemia
- b. Congestive cardiac failure due to ventricular dysfunction (Box 23.1). The different markers are used to:
  - i. Detect myocardial ischemia at the earliest
  - ii. Monitor the progression of the condition
  - iii. Predict the risk in cardiac dysfunction.

#### Box 23.1. Cardiac markers tested in

- i. Any chest pain
- ii. Unstable angina
- iii. Suspicious ECG changes
- iv. History suggestive of myocardial infarction
- v. Following surgical coronary revascularization
- vi. Patients with hypotension and dyspnea

Commonly used biomarkers for early detection of acute myocardial infarction are:

1. Cardiac troponins, TnI and TnT
2. Creatine kinase, CK-MB
3. Of these, troponins and CK-MB are the most sensitive and specific markers, whereas myoglobin though sensitive, is nonspecific (other markers are listed in Box 23.2). Predictors of risk in cardiac disease are of two types:
  - a. For predicting the onset of ischemia
  - b. Those which quantify the ventricular damage.

The risk predictors mainly include the atherogenic lipoproteins in plasma along with the inflammatory marker like hsCRP (high sensitive C reactive protein). These are described in Chapter 25.

## CREATINE KINASE (CK)

### Reference Values

It catalyzes the reaction shown in Figure 23.1B. It was called as creatine phosphokinase in old literature. **Normal serum** value for CK is 15–100 U/L for males and 10–80 U/L for females.

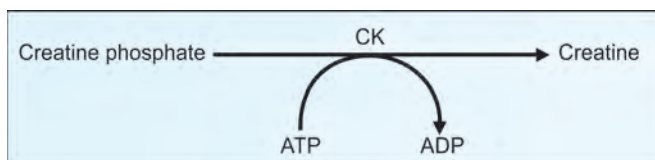


Fig. 23.1B: Creatine kinase reaction

#### Box 23.2. Markers for cardiac diseases

Serial testing of the following cardiac enzymes is usually done to guide the prognosis (Box 23.1). No single marker can successfully identify or exclude acute MI within the first 6 hours.

- i. Creatine kinase (CK-MB)
- ii. Cardiac troponin I (CTI) and Cardiac troponin T (CTT). These are not true enzymes.
- iii. Brain natriuretic peptide (BNP). It is a reliable marker of ventricular function.
- iv. Lactate dehydrogenase (LDH) and aspartate amino transferase (AST) were previously used as markers of myocardial function, but no more used in clinical practice. Markers for Risk for future cardiac event are described in Chapter 25.

## CK and Heart Attack

- i. CK value in serum is increased in **myocardial infarction**. The time course is shown in Figure 23.2 and Table 23.1. The CK level starts to rise **within 3–6 hours** of infarction.
- ii. Therefore, CK estimation is very useful to **detect early cases**, where ECG changes may be ambiguous. A second peak may indicate another ischemic episode.
- iii. The CK level is not increased in hemolysis or in congestive cardiac failure; and therefore CK has an advantage over LDH. The area under the peak and slope of initial rise are proportional to the size of infarct.

## Iso-enzymes of CK

- i. CK is a dimer; each subunit has a molecular weight of 40 kD. The subunits are called B for brain and M for muscle. Therefore, three iso-enzymes are seen in circulation. See Table 23.2.
- ii. Normally CK2 (heart iso-enzyme) is only 5% of the total activity. Even doubling of the value of CK2

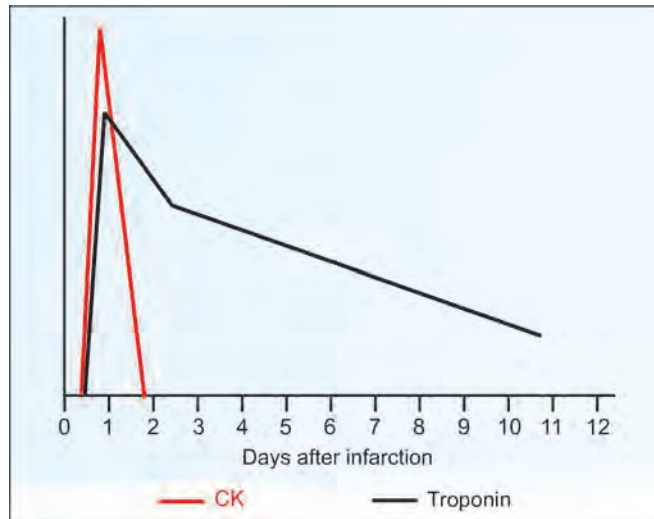


Fig. 23.2: Time course of elevation of CK-MB and cardiac troponins in blood of myocardial infarction patients

TABLE 23.1: Markers of myocardial infarction

Marker	Onset	Peak	Duration
CK-MB	3–6 hours	18–24 hours	36–72 hours
Troponins	4–10 hours	18–24 hours	8–14 days
Myoglobin	1–4 hours	6–7 hours	24 hours

(MB) iso-enzyme may not be detected, if total value of CK alone is estimated. Hence the estimation of **MB-isoenzyme** is the best diagnostic marker in myocardial infarction.

## CK and Muscle Diseases

- i. The level of CK in serum is very much elevated in **muscular dystrophies** (500–1500 IU/L)
- ii. In female carriers of X-linked muscular dystrophy (heterozygous), CK is moderately raised.
- iii. CK level is highly elevated in crush injury, fracture and acute cerebrovascular accidents.
- iv. **Estimation of total CK is employed in muscular dystrophies and MB iso-enzyme is estimated in myocardial infarction.**

## CARDIAC TROPONINS (CTI/CTT)

They are not enzymes. However, Troponins are now accepted as specific markers for **myocardial infarction**, and hence discussed here. Some more details on troponin are given in Chapter 58. Measurement of cardiac troponins has become one of the main tests in early detection of an ischemic episode and in monitoring the patient.

- i. The troponin complex consists of 3 components; troponin C (calcium binding subunit), troponin I (actomyosin ATPase inhibitory subunit), and troponin T (tropomyosin binding subunit).
- ii. Troponin I (TnI) is encoded by 3 different genes, giving rise to 3 isoforms; the "slow" and "fast" moving forms are skeletal variety. Cardiac isoform is specific for cardiac muscle; the amino acid sequence is different in skeletal muscle isoform. Cardiac isoform of cTnT and cTnI are mainly (95%) located in myofibrils and the remaining 5% is cytoplasmic. Circulating isoforms may be ternary complexes (TIC) or binary complexes (IC) or free subunits of I and T. They are generally identified and quantitated by immunological (ELISA or immunoturbidimetric) reactions. Troponins are seen in skeletal and cardiac muscles, but not in smooth muscles.
- iii. **Troponin I** is released into the blood **within 4 hours** after the onset of symptoms of myocardial ischemia; **peaks at 14–24 hours** and remains elevated for 3–5

days postinfarction. Therefore, CTI is very useful as a marker at any time interval after the heart attack. It is not increased in muscle injury; whereas CK2 may be elevated in some muscle injury. The initial increase is due to liberation of the cytoplasmic fraction and sustained elevation is due to the release from myofibrils.

- iv. Serum level of **Troponin T** (TnT) increases **within 6 hours** of myocardial infarction, peaks at **72 hours** and then remains elevated up to 10–14 days.
- v. Cardiac troponin elevations at lower concentrations than the 99th percentile value used for MI diagnosis may identify patients who have not had an MI but still have a risk of having an adverse cardiac event.
- vi. Elevated cTn levels indicate cardiac injury, including acute coronary syndrome (ACS), stroke, pulmonary embolism, sepsis, acute perimyocarditis, acute heart failure, and tachycardia. Therefore, more precise tests are needed. To satisfy this necessity, high sensitive TnT (hsTnT) has been developed. It enables determination of very low cTn concentrations. The higher sensitivity of this assay has allowed for improved identification of patients with AMI presenting in the first 3 hour following symptom onset. Even small increases are associated with a higher risk of death and other adverse outcomes. Two measurements of hsTnT are required for the assessment of patients with chest pain; the first measurement should be at presentation and the second sample should be measured 6 hours after. However, if the second sample does not show an incremental rise yet and clinical suspicion remains, then a further sample should be taken 12 hours after presentation. A rise of 20–100% is equivocal and needs further evaluation. Greater than 100% rise is consistent with myocardial infarction. Increase may not be seen if patients present 24 hours after development of symptoms. The reporting units for hsTnT should be ng/L. Concentrations of hs-cTnT >4 ng/L improve the prediction of death but not subsequent AMI in unselected patients presenting with acute chest pain.

**TABLE 23.2:** Characteristics of iso-enzymes of CK

Iso-enzyme	Electrophoretic mobility	Tissue of origin	Mean percentage in blood
MM(CK3)	Least	Skeletal muscle	80%
MB(CK2)	Intermediate	Heart	5%
BB(CK1)	Maximum	Brain	1%

## LACTATE DEHYDROGENASE (LDH) (LD)

### Reference Values

The LDH will convert pyruvate to lactate (see Chapter 9). Normal value of LDH in serum is 100–200 U/L. Values in the upper range are generally



seen in children. Strenuous exercise will slightly increase the value. LDH level is 100 times more inside the RBC than in plasma, and therefore minor amount of hemolysis will result in a false positive test.

### LDH and Heart Attack

In myocardial infarction, total LDH activity is increased, while **H4 iso-enzyme** is increased 5–10 times more. The magnitude of the peak value as well as the area under the graph will be roughly proportional to the size of the myocardial infarct.

### Differential Diagnosis

Increase in total LDH level is seen in hemolytic anemias, hepatocellular damage, muscular dystrophy, carcinomas, leukemias, and any condition which causes necrosis of body cells. Since total LDH is increased in many conditions, the study of iso-enzymes of LDH is of great importance.

### Iso-enzymes of LDH

- LDH enzyme is a tetramer with 4 subunits. But the subunit may be either H (heart) or M (muscle) polypeptide chains. Although both of them have the same molecular weight (32 kD), there are minor amino acid variations.
- So, 5 combinations of H and M chains are possible; H4, H3M, H2M2, M3H and M4 varieties, forming 5 iso-enzymes. All these 5 forms are seen in all persons. The iso-enzymes are usually separated by cellulose acetate **electrophoresis** at pH 8.6 (Table 23.3). The bands are identified by adding the reactants (NAD<sup>+</sup>, phenazine methosulphate) finally producing a color reaction (with nitroblue tetrazolium) which may be quantitated by a scanner.
- M4 form is seen in skeletal muscles while **H4 form is seen in heart**.
- Normally LDH-2 (H3M1) concentration in blood is greater than LDH-1 (H4); but this pattern is reversed in myocardial infarction; this is called **flipped pattern**. LDH has only limited diagnostic value because of its nonspecific nature.

### Brain Natriuretic Peptide (BNP)

The natriuretic peptide family consists of three peptides: Atrial natriuretic peptide (ANP), brain natriuretic peptide (BNP), and C-type natriuretic peptide (CNP). The clinical significance of CNP is not clear.

ANP is produced primarily in the cardiac atria. BNP is present in human brain, but more in the cardiac ventricles. Human pro-BNP contains 108 amino acids. It is cleaved by enzymes within cardiac myocytes into the active C-terminal BNP (32 amino acids) and an inactive peptide (pro-BNP 1–76). Both are seen in circulation. These natriuretic peptides defend against excess salt and water retention.

Patients with congestive heart failure have high plasma concentrations of ANP and BNP. The concentrations are correlated with the extent of ventricular dysfunction. High concentrations of BNP predict poor long-term survival. The role of C-type natriuretic peptide, if any, in heart failure is not known. In breathlessness, BNP test helps in the differentiation of the cause as heart failure or obstructive lung disease. Patients with COPD and worsening of their cor pulmonale with signs of RV volume overload (including edema and ascites) had increased BNP levels, and, indeed, these patients had increased mortality. The best marker of ventricular dysfunction is pro-BNP.

Commercial kits are available to assess the level of BNP as well as the amino terminal of the pro-hormone (NT-proBNP). Normal level of NT-proBNP is less than 400 ng/L. Less than 250 ng make heart failure highly unlikely.

BNP and NT-proBNP are released by the cardiac muscle in response to various stimuli, such as increased cardiac wall tension from pressure and volume overload in the heart. The system has a strong diuretic effect, promotes vasodilation, and facilitates cardiovascular remodeling and response to ischemia.

### Other Markers for Myocardial Infarction

- Myoglobin** is raised after myocardial infarction; but it is not specific and is raised during various other conditions including muscle injuries. It has the advantage of responding very rapidly, rising and falling earlier than CK-MB or troponin. A negative value will exclude infarction, and is useful in the early hours of chest pain (Table 23.1).
- Myeloperoxidase** (MPO) is a biomarker of inflammation and oxidative stress produced by neutrophils, monocytes, and endothelial cells. Concentrations of MPO predict mortality in patients with chronic heart failure. MPO has been shown to consume endothelial-derived nitric oxide, to convert LDLs to their

**TABLE 23.3:** Characteristic features of LDH iso-enzymes

No. of iso-enzyme	Subunit make up of iso-enzyme	Electrophoretic mobility at pH 8.6	Activity at 60°C for 30 minutes	Tissue from which iso-enzyme has originated	Percentage in human serum (Mean)
LDH-1	H4	Fastest	Not destroyed	Heart muscle	30%
LDH-2	H3M1	Faster	Not destroyed	RBC	35%
LDH-3	H2M2	Fast	Partially destroyed	Brain	20%
LDH-4	H1M3	Slow	Destroyed	Liver	10%
LDH-5	M4	Slowest	Destroyed	Skeletal muscle	5%

proatherogenic forms, and to counteract the antiatherogenic effects of HDLs, thus propagating the development of atherosclerosis. MPO is an indicator of higher mortality in MI patients.

- c. **Ischemia modified albumin (IMA)** is another candidate cardiac marker. Myocardial ischemia alters the N-terminus of albumin reducing the ability of cobalt to bind to albumin. IMA measures ischemia in the blood vessels and thus returns results in minutes rather than traditional markers of necrosis that take hours. It has low specificity; therefore generating high number of false positives. A negative value is highly useful, as it rules out the possibility of MI.
- d. **Glycogen phosphorylase iso-enzyme BB (GPBB)** is an iso-enzyme of glycogen phosphorylase. Glycogen phosphorylase exists in 3 isoforms. The GP-BB isoform exists in heart and brain tissue. During ischemia, GP-BB is converted into a soluble form and is released into the blood. A rapid rise in blood levels can be seen in myocardial infarction and unstable angina. GP-BB elevated 1–3 hours after process of ischemia.
- e. **Pregnancy-associated plasma protein A (PAPP-A)** Increased PAPP-A in circulation correlates with poor outcome in acute coronary syndrome (ACS) and in stable coronary artery disease. PAPP-A is a zinc metalloproteinase. Increased PAPP-A has been shown with poor prognosis in ACS or MI patients who remained cTnI negative.
- f. Recently diagnostic **nanochips** are being developed, which can identify the heart attack within minutes.

## Enzyme Profiles in Liver Diseases

Please see Box 23.3.

### ALANINE AMINO TRANSFERASE (ALT)

- i. In old literature, it was called as serum glutamate pyruvate transaminase (SGPT). The enzyme needs pyridoxal phosphate as co-enzyme. Details of the reaction are shown in Figure 3.18.
- ii. **Normal serum** level of ALT for male is 13–35 U/L and for female is 10–30 U/L. Very high values (300 to 1000 U/L) are seen in **acute hepatitis**, either toxic or viral in origin (infective hepatitis).
- iii. Both ALT and AST levels are increased in liver disease, but ALT > AST. Rise in ALT levels may be noticed several days before clinical signs such as jaundice are manifested.

#### Box 23.3. Enzyme profile in liver diseases

Enzymes commonly studied for diagnosis of liver diseases are:

1. Alanine amino transferase (ALT)
2. Alkaline phosphatase (ALP)
3. Nucleotide phosphatase (NTP)
4. Gamma glutamyl transferase (GGT).

- v. Moderate increase (50 to 100 U/L) of ALT may be seen in chronic liver diseases such as cirrhosis, hepatitis C and non-alcoholic steatohepatitis (NASH).

### ASPARTATE AMINO TRANSFERASE (AST)

- i. In old literature, it was called as serum glutamate oxaloacetate transaminase (SGOT). AST needs pyridoxal phosphate (vitamin B<sub>6</sub>) as co-enzyme.
- ii. Normal serum level of AST is 8–20 U/L. The level is elevated in **myocardial infarction**.
- iii. It is significantly elevated in **liver diseases**. A marked increase in AST may be seen in primary hepatomas.
- iv. In alcoholic hepatitis AST may be higher than ALT since mitochondrial enzyme is also liberated.

### ALKALINE PHOSPHATASE (ALP)

- i. ALP is a nonspecific enzyme which hydrolyzes aliphatic, aromatic or heterocyclic compounds. The pH optimum for the enzyme reaction is between 9 and 10. It is activated by magnesium and manganese. Zinc is a constituent ion of ALP.
- ii. It is produced by **osteoblasts** of bone, and is associated with the calcification process (see Chapter 35). It is localized in cell membranes (**ecto-enzyme**), and is associated with transport mechanisms in liver, kidney and intestinal mucosa.
- iii. **Normal serum** value of ALP is 40–125 U/L. In children, the upper level of normal value may be more, because of the increased osteoblastic activity in children.
- iv. **Moderate (2–3 times) increase** in ALP level is seen in **hepatic diseases** such as infective hepatitis, alcoholic hepatitis or hepatocellular carcinoma (see Chapter 26).
- v. **Very high levels of ALP** (10–12 times of upper limit) may be noticed in **extrahepatic obstruction** (obstructive jaundice) caused by gallstones or by pressure on bile duct by carcinoma of head of pancreas. **Intrahepatic cholestasis** may be caused by viral hepatitis or by drugs (chlorpromazine). ALP is produced by epithelial cells of biliary canaliculi and obstruction of biliary passage with consequent irritation of epithelial cells leads to secretion of ALP into serum.
- vi. **Drastically high levels of ALP** (10–25 times of upper limit) are also seen in **bone diseases** where

osteoblastic activity is enhanced such as Paget's disease (osteitis deformans), rickets, osteomalacia, osteoblastoma, metastatic carcinoma of bone and hyperparathyroidism.

### Iso-enzymes of Alkaline Phosphatase

1. **Alpha-1 ALP** moves in alpha-1 position, it is synthesized by epithelial cells of biliary canaliculi. It is about 10% of total activity and is increased in obstructive jaundice.
2. **Alpha-2 heat labile ALP** is stable at 56°C; but loses its activity when kept at 65°C for 30 minutes. It is produced by hepatic cells. This liver iso-enzyme forms about 25% of total ALP.
3. **Alpha-2 heat stable ALP** will not be destroyed at 65°C, but is **inhibited by phenylalanine**. It is of placental origin, which is found in blood in normal pregnancy. An iso-enzyme closely resembling the placental form is characteristically seen in circulation in about 15% cases of carcinoma of lung, liver and gut and named as **Regan iso-enzyme** (after the first patient in whom it was detected) or **carcinoplacental iso-enzyme**. Normal level is only 1% of the total ALP.
4. **Pre-beta ALP** is of bone origin and elevated levels are seen in **bone diseases**. This is heat labile (destroyed at 56°C, 10 min). This constitutes about 50% of normal ALP activity. Heat labile bone iso-enzyme of alkaline phosphatase (BAP) is a marker of bone disease.
5. **Gamma-ALP** is inhibited by phenylalanine and originates from intestinal cells. It is increased in ulcerative colitis. About 10% of plasma ALP originates from intestine.
6. **The leukocyte alkaline phosphatase (LAP)** is significantly decreased in chronic myeloid leukemia. It is increased in lymphomas.

### Nucleotide Phosphatase (NTP)

1. It is also known as 5' nucleotidase. This enzyme hydrolyses 5' nucleotides to corresponding nucleosides at an optimum pH of 7.5. **Nickel ions** inhibit NTP but not ALP.
2. It is a marker enzyme for plasma membranes and is seen as an **ecto-enzyme** (enzyme present on the cell membrane).
3. Normal NTP level in serum is 2–10 IU/L. It is moderately increased in hepatitis and highly elevated in **biliary obstruction**. Unlike ALP, the level is unrelated with osteoblastic activity and therefore is unaffected by bone diseases.

### Gamma Glutamyl Transferase (GGT)

1. The old name was gamma glutamyl transpeptidase. It can transfer gamma glutamyl residues to substrate. In the body it is used in the synthesis of glutathione (see Chapter 16). GGT has 11 iso-enzymes. It is seen in liver, kidney, pancreas, intestinal cells and prostate gland.
2. **Normal serum** value of GGT is 10–30 U/L. It is moderately increased in infective hepatitis and prostate cancers.
3. GGT is clinically important because of its sensitivity to detect **alcohol abuse**. GGT is increased in alcoholics even when other liver function tests are within normal limits. GGT level is rapidly decreased within a few days when the person stops to take alcohol. Increase in GGT level is generally proportional to the amount of alcohol intake.

### Acid Phosphatase (ACP)

1. It hydrolyzes phosphoric acid ester at pH between 4 and 6. **Normal serum** value for ACP is 2.5–12 U/L.
2. ACP is secreted by prostate cells, RBC, platelets and WBC.
3. The prostate iso-enzyme is inactivated by **tartaric acid**. Normal level of tartrate labile fraction of ACP is 1 U/L.
4. ACP total value is increased in **prostate cancer** and highly elevated in bone metastasis of prostate cancer. In these conditions, the tartrate labile iso-enzyme is elevated. This assay is very helpful in follow-up of treatment of prostate cancers. So, ACP is an important **tumor marker** (see Chapter 57).
5. Since blood cells contain excess quantity of ACP, care must be taken to prevent hemolysis while taking blood from the patient. Prostate massage may also increase the value. So blood may be collected for ACP estimation before rectal examination of patient.

### PROSTATE SPECIFIC ANTIGEN (PSA)

1. It is produced from the secretory epithelium of prostate gland. It is normally secreted into seminal fluid, where it is necessary for the liquefaction of seminal coagulum.
2. It is a serine protease, and is a 32 kD glycoprotein. In blood, it is bound to alpha-2-macroglobulin and alpha-1-antitrypsin; a very small fraction is in the free form also.
3. Normal value is 1–5 µg/L. It is very specific for prostate activity. Values above 10 µg/L is indicative of prostate cancer.

## Cholinesterase (ChE)

- i. **Acetyl cholinesterase** or true ChE or Type 1 ChE can act mainly on acetyl choline. It is present in **nerve endings and in RBCs**. Newly formed RBC will have high levels of ChE which is slowly reduced according to the age of the cell. Therefore, ChE level in RBCs will be proportional to the reticulocyte count.
- ii. **Organophosphorus insecticides** (Parathione) irreversibly inhibit ChE in RBCs. Measurement of ChE level in RBCs is useful to determine the amount of exposure in persons working with these insecticides.
- iii. **Pseudocholinesterase** or type II ChE is nonspecific and can hydrolyze acyl esters. It is produced mainly by **liver cells**. Succinyl choline is a widely used muscle relaxant. It is a structural analog of ACh, and so competitively fixes on post-synaptic receptors of ACh. **Succinyl choline** is hydrolyzed by the liver ChE within 2–4 minutes. But in certain persons the ChE activity may be absent; this is a genetically transmitted condition. In such individuals, when succinyl choline is given during surgery, it may take hours to get the drug metabolized. Very prolonged '**scoline apnea**' may result in 'nightmare of anesthetist'.

## GLUCOSE-6-PHOSPHATE DEHYDROGENASE (GPD)

1. It is a dimer with identical subunits. It is an important enzyme in the hexose monophosphate shunt pathway of glucose (see Chapter 10). It is mainly used for production of NADPH.
2. Hydrogen peroxide is continuously formed inside the RBC. Peroxide will destroy RBC cell membrane. Glutathione and NADPH will prevent this process. Therefore, NADPH is very essential for preserving the RBC integrity.
3. **Drug-induced hemolytic anemia:** Normal value of GPD in RBC is 6–12 U/g of Hb. This is reduced in drug induced hemolytic anemias. In the GPD deficient individuals, RBC lifespan may be reduced, but there will be no disease manifestations. But when certain drugs (aspirin, mepacrine, primaquine, sulfa) are taken by such individuals, there will be sudden damage to RBCs. Primaquin stimulates peroxide formation.

In GPD deficient cells, the level of NADPH is low, leading to unchecked build up of peroxides resulting in premature cell lysis. This drug-induced hemolytic anemia is characteristic of GPD deficiency. Fava beans (star beans, corner beans) may also induce hemolytic anemia, which is called favism.

4. **Carrier state has biological advantage:** The gene for GPD is located in **X-chromosome**. Therefore, hemizygous males and homozygous females will manifest the disease, while heterozygous females are carriers. In heterozygous condition, where one gene is abnormal and the allelic form is normal, the GPD level in RBC is half the normal value. GPD deficiency seems to protect the person from falciparum **malaria**. The malarial parasites require NADPH for optimal growth. Thus GPD deficiency has a selective advantage in malaria infested regions (see Chapters 10 and 22).
5. **Met-hemoglobinemia:** NADPH is also necessary for reduction of met-hemoglobin (oxidized form) to hemoglobin (see Chapter 22). Hence in GPD deficient individuals, met-hemoglobinemia may also be manifested.
6. Nearly 400 variants (isoforms) of GPD are described. Some of the variants have decreased enzyme activity.

## AMYLASE

1. This enzyme splits starch to maltose. It is activated by calcium and chloride ions. It is produced by pancreas and salivary glands.
2. Normal serum value is 50–120 IU/L. The value is increased about 1000 times in **acute pancreatitis** which is a life-threatening condition. The peak values are seen between 5–12 hours after the onset of disease and returns to normal levels within 2–4 days after the acute phase has subsided.
3. Moderate increase in serum levels are seen in chronic pancreatitis, mumps (parotitis) and obstruction of pancreatic duct.
4. Normal value of **amylase in urine** is less than 375 U/L. It is increased in acute pancreatitis. It is increased on the 1st day and remains to be elevated for 7–10 days.



## LIPASE

Hydrolyzes triglyceride to beta-monoglyceride and fatty acid. The enzyme is present in pancreatic secretion. The level in blood is highly elevated in **acute pancreatitis** and this persists for 7–14 days. Thus lipase remains elevated longer than amylase. Moreover, lipase is not increased in mumps. Therefore, lipase estimation has advantage over amylase. It is moderately increased in carcinoma of pancreas, biliary diseases and perforating peptic ulcers.

## ENOLASE

It is a glycolytic enzyme. Neuron-specific enolase (NSE) is an iso-enzyme seen in neural tissues and Apudomas. NSE is a **tumor marker** (see Table 57.8) for cancers associated with neuroendocrine origin, small cell lung cancer, neuroblastoma, pheochromocytoma, medullary carcinoma of thyroid, etc. It is measured by RIA or ELISA.

Enzyme patterns in some important diseases are given in Box 23.4. Important enzymes in body fluids are shown in Table 23.5.

### Aldolase (ALD)

It is a tetrameric enzyme with A and B subunits; so there are 5 iso-enzymes. It is a glycolytic enzyme. Normal range of serum is 1.5–7 U/L. It is drastically elevated in muscle damages such as progressive muscular dystrophy, poliomyelitis, myasthenia gravis and multiple sclerosis. It is a very sensitive early index in muscle wasting diseases.

### Ceruloplasmin

It is otherwise called Ferroxidase, and is described in detail in Chapter 28. Normal serum level is 25–50 mg/dL. It is estimated by the ability of ceruloplasmin to oxidize paraphenylene diamine to a purple compound, which is colorimetrically read at 530 nm. Modern techniques based on radial immunodiffusion or immunoturbidimetric methods are also available. Since it is an acute phase protein, it is increased in all inflammatory conditions, collagen diseases, malignancies and pregnancy. A value less than 20 mg/dL is pathognomonic of Wilson's hepatolenticular degeneration, in which copper toxicity is manifested (see under copper, Chapter 39).

## Enzymes as Therapeutic Agents

**Streptokinase** (from *Streptococcus*) or **Urokinase** (from urine) can lyse intravascular clots and are therefore used in myocardial infarction. **Pepsin** and **trypsin** are given to patients with defective digestion. **Asparaginase** is used as an anticancer drug. A list of therapeutically useful enzymes is given in Table 23.4.

Recombinant human tissue plasminogen activator (alteplase) under the trade name Activase® is used in the treatment of heart attack,

### Box 23.4: Enzyme patterns (enzyme profiles) in diseases

#### I. Hepatic diseases

1. *Alanine amino transferase (ALT)*  
Marked increase in parenchymal liver diseases
2. *Aspartate amino transferase (AST)*  
Increase in muscle disease; not specific
3. *Alkaline phosphatase (ALP)*  
Marked increase in obstructive liver disease
4. *Gamma glutamyl transferase (GGT)*  
Increase in obstructive and alcoholic liver
5. *Nucleotide phosphatase (NTP)*  
Elevated in liver dysfunction with cholestasis

#### II. Myocardial infarction

1. *Creatine kinase (CK-MB)*  
Starts to rise within 3–6 hours
2. *Cardiac troponins (cTnT and cTnI)*  
Starts to rise within 4–6 hour
3. *High sensitive TnT (hsTnT)*  
Starts to rise within 3 hours
4. *BNP and NTproBNP*  
Indicate heart failure
5. *AST and LDH*  
Have only historical importance

#### III. Muscle diseases

1. *Creatine kinase (CK-MM)*  
Marked increase in muscle diseases  
CK-MM fraction is elevated
2. *Aldolase (ALD)*  
Earliest enzyme to rise, but not specific

#### IV. Bone diseases

1. *Alkaline phosphatase (ALP)*  
Marked elevation in rickets and Paget's disease  
Heat labile bone isoenzyme (BAP) is elevated

#### V. Prostate cancer

1. *Prostate specific antigen (PSA)*  
Marker for prostate cancer.  
Mild increase in benign prostate enlargement
2. *Acid phosphatase (ACP)*  
Marker for prostate cancer. Metastatic bone disease especially from a primary from prostate. Inhibited by L tartrate.

TABLE 23.4: Therapeutic use of enzymes

Enzyme	Therapeutic application
1. Asparaginase	Acute lymphoblastic leukemia
2. Streptokinase	To lyse intravascular clot
3. Urokinase	Do
4. Streptodornase	DNase; applied locally
5. Pancreatin (trypsin and lipase)	Pancreatic insufficiency; oral administration
6. Papain	Anti-inflammatory
7. Alpha1-antitrypsin	AAT deficiency; emphysema

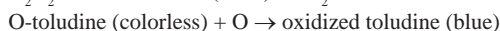
it produces clot lysis. A variety of other enzymes are used in treatment of genetic diseases. Some of them which have been used successfully are Adagen® (pegadernase bovine) used for the treatment of SCID due to ADA deficiency, Ceredase® (alglucerase) for treatment of Gaucher's disease, Pulmozyme® (dornase a) for cystic fibrosis, and Oncospar® (pegasparase) in acute lymphatic leukemia (ALL). Enzymes with promising results include (1) lysozymes have antiviral effects, (2) superoxide dismutase and catalase, as antioxidants. But they have not fulfilled their promise in clinical trials.

### Enzymes Used for Diagnosis

A list of enzymes used in clinical laboratory is given in Tables 23.5 and 23.6. Methods for blood analyte estimations are made specific by using enzymes. For example, **glucose oxidase** is used to estimate glucose. **Urease** will act only on urea, and therefore, it is conveniently used to quantitate urea in biological fluids. The presence of antibody in circulation is identified by fixing them on antigen and identified by a second antibody tagged with **peroxidase**. These enzymes are effective to produce a color reaction. **ELISA test** is described in detail in Chapter 35. **Restriction endonucleases** are used to cut DNA at specific sites; and applied in recombinant DNA technology, Southern blotting, and other advanced techniques (Chapter 49).

### Immobilized Enzymes

Enzymes have been fixed or rendered insoluble by attaching them to insoluble matrix such as plastic beads or cellulose strips. These strips are used for detection of abnormal substances in blood or urine. For example, a strip of paper coated with immobilized **glucose oxidase** (GOD) and peroxidase (POD) enzymes is used for detection of glucose in urine. The following reactions take place:



Similarly immobilized urease, hexokinase, amylase, etc. are also used for diagnostic purpose.

### Related Topics

Tumor markers are described in Chapter 57.

## Clinical Case Study 23.1

A patient presented with acute chest pain of half hour duration. The biochemical analysis reports are as follows

**TABLE 23.5:** Enzymes in other body fluids

Enzyme	Clinical significance
Adenosine deaminase in pleural fluid	Elevated in tuberculous pleural effusion, but not in malignant effusion
Lactate dehydrogenase in CSF, pleural fluid, ascitic fluid	Elevated levels indicate the presence of a malignant tumour. But not diagnostic, as the enzyme is not tissue specific

Blood Glucose – 350 mg%, Serum Cholesterol – 288 mg%, SGOT – 55 U/L, SGPT – 15 U/L. CPK and LDH were elevated. Give your provisional diagnosis. What are the other markers which can be estimated in this case?

## Clinical Case Study 23.2

A 40-year-old obese female presents to the emergency center with complaints of worsening nausea, vomiting and abdominal pain. Her pain is located in the midepigastic area and right upper quadrant. Her pain is presently constant and sharp in nature but previously was intermittent and cramping only after eating “greasy” foods. On examination, she has a temperature of 37.8°C with otherwise normal vital signs. She has significant midepigastic and right upper-quadrant tenderness. Some guarding is present. Her abdomen is otherwise soft with no distention and active bowel sounds. Laboratory values were normal except for increased liver function tests, white blood cell count, and serum amylase. Ultrasound of the gallbladder revealed numerous gallstones and a thickening of the gallbladder wall. What is the most likely diagnosis? What is the role of amylase in digestion?

## Clinical Case Study 23.1 Answer

Myocardial infarction. Cardiac troponins, myoglobin.

## Clinical Case Study 23.2 Answer

**Diagnosis:** Gallstone pancreatitis.

**Role of amylase:** Enzyme for carbohydrate metabolism, used to digest glycogen and starch.

**Acute pancreatitis** is an inflammatory process in which pancreatic enzymes are activated and cause autodigestion

**TABLE 23.6:** Enzymes used for diagnostic purpose

Enzyme	Used for testing
Urease	Urea
Uricase	Uric acid
Glucose oxidase	Glucose
Peroxidase	Glucose; Cholesterol
Hexokinase	Glucose
Cholesterol oxidase	Cholesterol
Lipase	Triglycerides
Horse radish peroxidase	ELISA
Alkaline phosphatase	ELISA
Restriction endonuclease	Southern blot; RFLP
Reverse transcriptase	Polymerase chain reaction (RT PCR)

of the gland. In the United States, **alcohol use is the most common cause**, and episodes are often precipitated by binge drinking. The next most common cause is biliary tract disease, usually passage of a gallstone into the common bile duct. Hypertriglyceridemia is also a common cause, and that occurs when serum triglyceride levels are greater than 1000 mg/dL, as is seen in patients with familial dyslipidemias or diabetes. When patients appear to have “idiopathic” pancreatitis, that is, no gallstones are seen on ultrasound, and no other predisposing factor can be found, biliary tract disease is still the most likely cause: Either biliary sludge (microlithiasis), or sphincter of Oddi dysfunction. **Abdominal pain is the cardinal symptom of pancreatitis**, and it is often severe, typically in the **upper abdomen with radiation to the back**. The pain is often relieved by sitting up and bending forward and is exacerbated by food. Patients also **commonly have nausea and vomiting**, also precipitated by oral intake. The treatment includes nothing by mouth, intravenous hydration, pain control, and monitoring for complications.

## ■ QUICK LOOK OF CHAPTER 23

1. Clinically useful enzymes in diagnosis and prognosis of myocardial infarction are CK, CTI / CTT, AST and LDH.
2. ALT, AST, ALP, GGT and NTP are clinically useful markers in hepatic diseases.
3. ALP is also a useful marker in bone diseases.
4. GGT is used an indicator of alcohol abuse and as a marker of alcoholic liver cirrhosis.
5. ACP and PSA are used in the diagnosis of prostate cancer.
6. PSA values higher than 10 mg/L is indicative of prostate cancer.
7. Cholinesterase (ChE) is used as a marker in organophosphorus insecticide poisoning.
8. Pancreatic amylase is a marker of acute pancreatitis.
9. Therapeutically useful enzymes are streptokinase or urokinase, asparaginase, hyaluronidase, alpha1 antitrypsin, pepsin and trypsin.
10. Some examples of enzymes used in diagnostic methods are peroxidase, glucose oxidase and alkaline phosphatase.

# CHAPTER 24

## Regulation of Blood Glucose; Insulin and Diabetes Mellitus

### Chapter at a Glance

The reader will be able to answer questions on the following topics:

- Factors maintaining blood glucose
- Normal plasma glucose level
- Effects of hormones on glucose level
- Oral glucose tolerance test (OGTT)
- Diagnostic criteria for diabetes mellitus
- Impaired glucose tolerance
- Reducing substances in urine
- Benedict's test
- Insulin, synthesis and secretion
- Physiological action of insulin
- Glucagon
- Diabetes mellitus types
- Metabolic derangements in diabetes
- Clinical aspects of diabetes mellitus
- Laboratory investigations in diabetes
- Glycated hemoglobin

### REGULATION OF BLOOD GLUCOSE

The maintenance of glucose level in blood within narrow limits is a very finely and efficiently regulated system. This is important, because it is essential to have continuous supply of glucose to the brain. It can utilize ketone bodies to some extent, brain has an obligatory requirement for glucose. RBC and renal medulla are also dependent on glucose for meeting their fuel needs. Factors maintaining the blood glucose are shown in Box 24.1 and Figures 24.1 and 24.3.

#### Post-prandial Regulation

Following a meal, glucose is absorbed from the intestine and enters the blood. The rise in the blood glucose level

stimulates the secretion of **insulin** by beta cells of islets of Langerhans of pancreas. The uptake of glucose by

#### Box 24.1. Factors maintaining blood sugar

1. The plasma glucose level at an instant depends on the balance between glucose entering and leaving the extracellular fluid
2. Hormones maintain this balance (Fig. 24.1)
3. The major factors which cause **entry of glucose** into blood are:
  - a. Absorption from intestines
  - b. Glycogenolysis (breakdown of glycogen)
  - c. Gluconeogenesis
  - d. Hyperglycemic hormones (glucagon, steroids)
4. Factors leading to **depletion of glucose** in blood are:
  - a. Utilization by tissues for energy
  - b. Glycogen synthesis
  - c. Conversion of glucose into fat (lipogenesis)
  - d. Hypoglycemic hormone (insulin)



most extrahepatic tissues, except brain is dependent on insulin. Moreover, insulin helps in the storage of glucose as glycogen or its conversion to fat (Fig. 24.2A).

### Regulation in Fasting State

- i. Normally, 2 to 2½ hours after a meal, the blood glucose level falls to near fasting levels. It may go

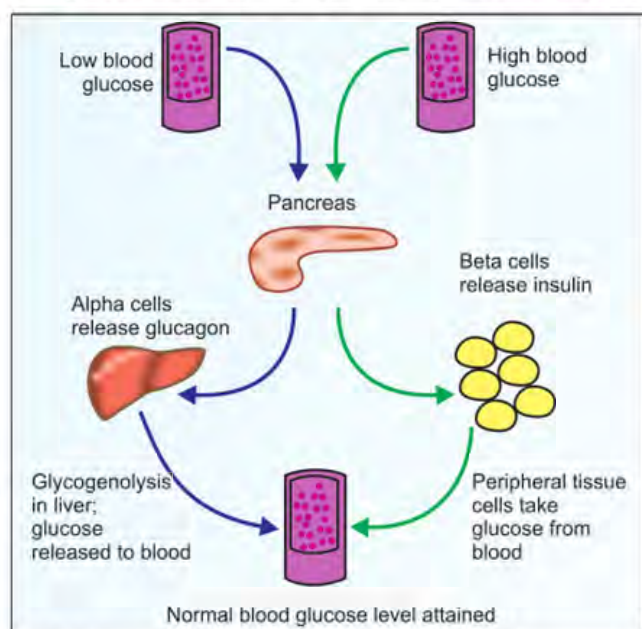


Fig. 24.1: Homeostasis of blood glucose

down further; but this is prevented by processes that contribute glucose to the blood.

- ii. For another 3 hours, hepatic **glycogenolysis** will take care of the blood sugar level.  
 iii. Thereafter, **gluconeogenesis** will take charge of the situation (Figs 24.2A and B).  
 iv. Liver is the major organ that supplies the glucose for maintaining blood glucose level (Fig. 24.1).  
 v. **Hormones** like glucagon, epinephrine, glucocorticoids, growth hormone, ACTH and thyroxine will keep the blood glucose level from falling. They are referred to as anti-insulin hormones or hyperglycemic hormones. An overview of the regulatory mechanism is shown in Figure 24.3. Effects of hormones are shown in Box 24.2.

### Determination of Glucose in Body Fluids

Estimation of glucose is the most common analysis done in clinical laboratories. The blood is collected using an anticoagulant (potassium oxalate) and an inhibitor of glycolysis (sodium fluoride).

Fluoride inhibits the enzyme, enolase, and so glycolysis on the whole is inhibited. If fluoride is not added, cells will utilize glucose and false low value may be obtained. Capillary blood from finger tips may also be used for glucose estimation by strip method.

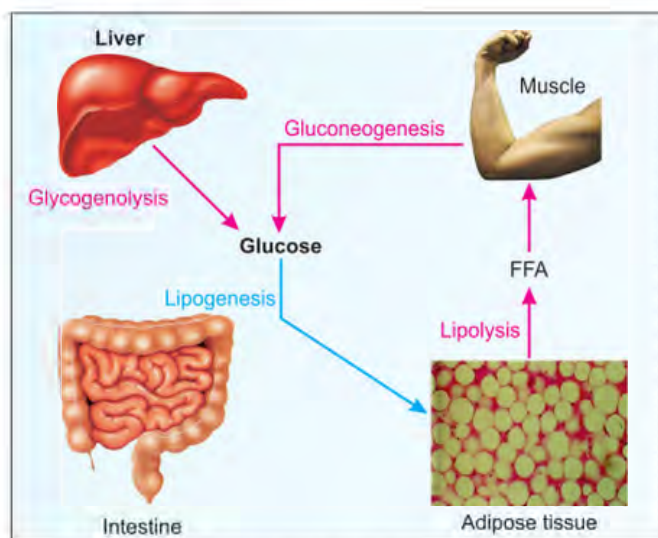


Fig. 24.2A: Blood glucose regulation during fasting state (high Glucagon). In fasting state, blood glucose level is maintained by glycogenolysis and gluconeogenesis; further, adipose tissue releases free fatty acids as alternate source of energy. Red arrows indicate activation; blue arrow indicates inhibition

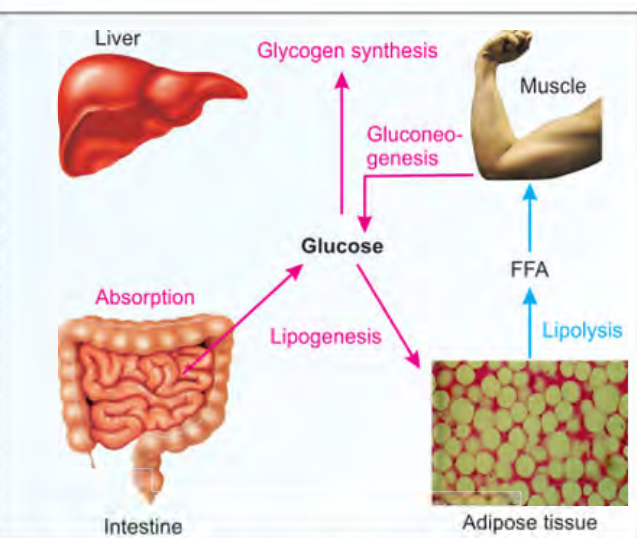


Fig. 24.2B: Blood glucose regulation during post-prandial state (high Insulin). In post-prandial state, glucose level is high; then blood glucose level is lowered by tissue utilization, glycogen synthesis and lipogenesis. Red arrows indicate activation; blue arrow indicates inhibition



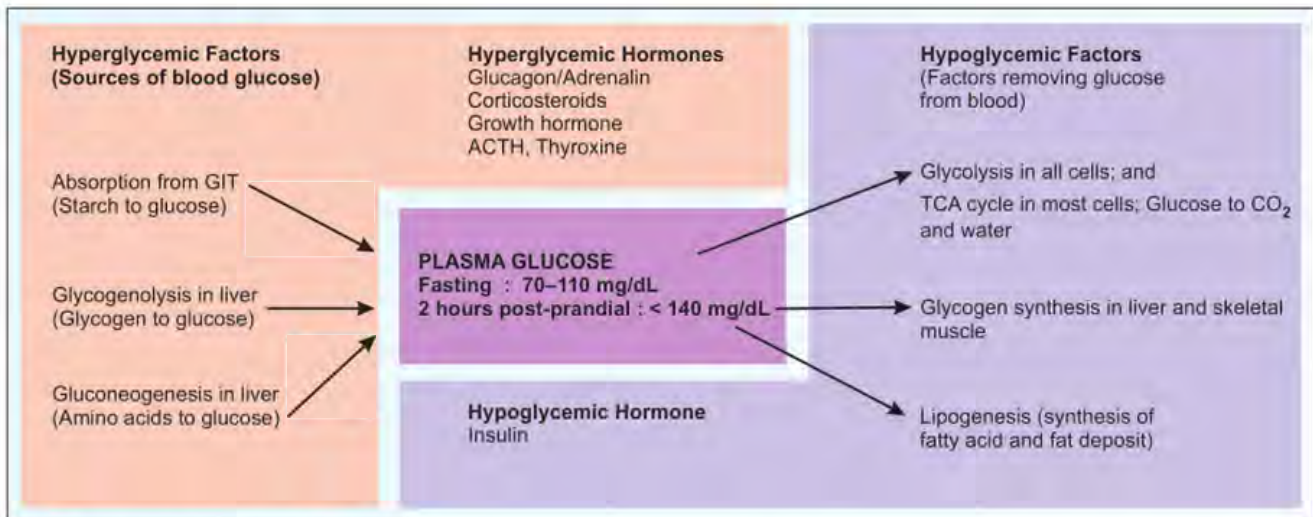


Fig. 24.3: Overview of regulation of blood sugar

#### Box 24.2: Effects of hormones on glucose level in blood

- A. Effect of insulin (hypoglycemic hormone)
  1. Lowers blood glucose
  2. Favors glycogen synthesis
  3. Promotes glycolysis
  4. Inhibits gluconeogenesis
- B. Glucagon (hyperglycemic hormone)
  1. Increases blood glucose
  2. Promotes glycogenolysis
  3. Enhances gluconeogenesis
  4. Depresses glycogen synthesis
  5. Inhibits glycolysis (Details given below)
- C. Cortisol (hyperglycemic hormone)
  1. Increases blood sugar level
  2. Increases gluconeogenesis
  3. Releases amino acids from the muscle
- D. Epinephrine or Adrenaline (hyperglycemic)
  1. Increases blood sugar level
  2. Promotes glycogenolysis
  3. Increases gluconeogenesis
  4. Favors uptake of amino acids
- E. Growth hormone (hyperglycemic)
  1. Increases blood sugar level
  2. Decreases glycolysis
  3. Mobilizes fatty acids from adipose tissue

### Enzymatic Method

This is highly specific, giving 'true glucose' values (fasting **70–110 mg/dL**). Present day autoanalyzers can use only the enzymatic methods. The autoanalyzers use either plasma or serum as the specimen and not whole blood.

The **glucose oxidase (GOD)** method is the one most widely used. Glucose oxidase is very specific; it

converts glucose to gluconic acid and hydrogen peroxide. Peroxidase converts the H<sub>2</sub>O<sub>2</sub> into H<sub>2</sub>O and nascent oxygen. The oxygen oxidizes a colorless chromogenic substrate (e.g. ortho dianisidine) to a colored one; the color intensity is directly proportional to concentration of glucose. The newer automated systems use hexokinase method.

As a modification, the above GOD reaction mixture is immobilized on a plastic film (**dry analysis**). One drop of blood is placed over the reagent. The color is developed within one minute. The intensity of dye is measured by reflectance photometry. The instrument is named as **glucometer**. It is useful for patients to have self-analysis at home. But the instrument is less accurate.

### Commonly Employed Terms Regarding Glucose

1. Blood sugar analyzed at any time of the day, without any prior preparations, is called **random blood sugar**.
2. Sugar estimated in the early morning, before taking any breakfast is called **fasting blood sugar**. Fasting state means, glucose is estimated after an overnight fast (12 hours after the food) (post-absorptive state).
3. The test done about 2 hours after a good meal is called **post-prandial blood sugar** (Latin = after food).
4. When blood glucose level is within normal limits, it is referred to as **normoglycemia**. When values are above the normal range, it is known as **hyperglycemia**. When values are below the normal range, it is called **hypoglycemia**. (Greek, hyper = above; hypo = below).



- When the blood sugar is below 50 mg/dL, it is a very serious condition. Hyperglycemia is harmful in the long run; while hypoglycemia even for a short while is dangerous, and may even be fatal.
- The plasma values are slightly higher than whole blood glucose values because RBCs contain less water (73%) than plasma (93%).
- The ability of a person to metabolize a given load of glucose is referred to as **glucose tolerance**.

### Conducting the Glucose Tolerance Test

- At about 8 am, a sample of blood is collected in the fasting state. Urine sample is also obtained. This is denoted as the "0" hour sample.
- Glucose load dose:** The dose is **75 g anhydrous glucose** (82.5 g of glucose monohydrate) in 250–300 mL of water. This dose is fixed for an adult, irrespective of body weight. (When the test is done in children, the glucose dose is adjusted as 1.75 g/kg body weight). In order to prevent vomiting, patient is asked to drink it slowly (within about 5 minutes). Flavoring of the solution will also reduce the tendency to vomit.
- Sample collection:** As per current WHO recommendations, 2 samples are collected, one at fasting ("0" hr sample) and 2-hour post-glucose load. Urine samples may also be collected along with these blood samples. This is sufficient to get a correct assessment of the patient.

### Normal Values and Interpretations

As per WHO recommendation, In a normal person, fasting plasma glucose is **70–110 mg/dL**. The present day tendency is to view values above 100 mg/mL as suspicious. According to the recommendations of the American Diabetic Association, the revised upper limit is 100 mg/dL, above which a person has to be further tested periodically. Currently the International Diabetes Federation says that a value more than 100 mg/dL is one of the criteria for the metabolic syndrome.

Following the glucose load, the level rises and reaches a peak within 1 hour and then comes down to normal fasting levels by 2 to 2½ hours. This is due to the secretion of insulin in response to the elevation in blood glucose. None of the urine sample shows any evidence of glucose. Diagnostic criteria for diabetes mellitus are given in Table 24.1 and Box 24.3. Oral glucose tolerance test and physiological tolerance test are different (Box 24.4).

**TABLE 24.1:** The plasma sugar levels in OGTT in normal persons and in diabetic patients

	Normal persons	Criteria for diabetes	Criteria for diagnosing IGT
<b>Fasting</b>	< <b>110 mg/dL</b> <(6.1 mmol/L)	> <b>126 mg/dL</b> >(7.0 mmol/L)	<b>110 to 126</b> mg/dL
<b>1 hr (peak) after glucose</b>	< <b>160 mg/dL</b> <(9 mmol/L)	Not prescribed	Not prescribed
<b>2 hr after glucose</b>	< <b>140 mg/dL</b> <(7.8 mmol/L)	> <b>200 mg/dL</b> >(11.1 mmol/L)	<b>140 to</b> 199 mg/dL

#### Box 24.3: Diagnostic criteria for diabetes mellitus

- If the fasting plasma sugar is more than 126 mg/dL, on more than one occasion (Table 24.1)
- Or, if 2-hr post-glucose load value of OGTT is more than 200 mg/dL (even at one occasion)
- Or, if both fasting and 2-hr values are above these levels, on the same occasion
- If the random plasma sugar level is more than 200 mg/dL, on more than one occasion. Diagnosis should not be based on a single random test alone; it should be repeated
- Glycated hemoglobin (Glyco-Hb) or HbA1c level more than 6.5% at any occasion. As per the recommendations of American Association of Clinical Chemistry and American Diabetes Association, HbA1c level is the preferred method for initial diagnosis of diabetes mellitus.

#### Box 24.4: Post-glucose load values and post-prandial values are different

Oral glucose tolerance test (OGTT) is always non-physiological, where glucose is administered in a large dose. But it is a very standard test, and is useful for diagnosis. In this test, the blood sugar reaches a **peak value at 1 hour** and comes back to fasting value by about 2 hour. These are referred to as **post-glucose load values**.

This OGTT is different, and should not be confused, with the **physiological tolerance test** often employed in clinical practice. Here fasting blood sample is taken; then patient is asked to take a heavy breakfast (instead of glucose load). This will certainly mimic what is happening in daily life. The blood sample at 2 hours after the meal is also taken; when the result is referred to as post-prandial (Latin, after food) value. In normal persons, the 2-hr post-prandial value will be less than 140 mg/dL.

### Classical Oral Glucose Tolerance Test (OGTT)

The above mentioned method is sufficient to assess the condition of most of the patients, and modern day tendency is to take only 2 blood samples, as described above. However, in selected cases, the conventional OGTT is employed, where 6 blood samples are taken, and the procedure is given below. Glucose tolerance test is artificial, because in day to day life, such a large quantity of glucose does not enter into blood. However, the GTT



is a well-standardized test, and is highly useful to diagnose diabetes mellitus in doubtful cases.

### Indications for OGTT

1. Patient has symptoms suggestive of diabetes mellitus; but fasting blood sugar value is inconclusive (between 100 and 126 mg/dL).
2. During pregnancy, excessive weight gaining is noticed, with a past history of big baby (more than 4 kg) or a past history of miscarriage.
3. To rule out benign renal glucosuria.

### Contraindications for OGTT

1. There is no indication for doing OGTT in a person with confirmed diabetes mellitus.
2. GTT has no role in follow-up of diabetes. It is indicated only for the initial diagnosis.
3. The test should not be done in acutely ill patients.

### Preparation of the Patient

1. The patient is instructed to have good carbohydrate diet for 3 days prior to the test. Further, diet containing about 30–50 g of carbohydrate should be taken on the evening prior to the test. This is important. Otherwise carbohydrates may not be tolerated even in a normal person.
2. Patient should avoid drugs likely to influence the blood glucose levels, for at least 2 days prior to the test. Patient should abstain from smoking during the test. Strenuous exercise on the previous day is to be avoided.
3. Patient should not take food after 8 PM the previous night. Should not take any breakfast. This is to ensure 12 hours fasting.
4. The patients are advised to remain in the hospital during the waiting period of two hours without any active exercise. The practice of leaving the hospital and rushing back at the end of 2 hours should be discouraged.

### Difference Between Modern and Classical GTT

Glucose load given is the same in both instances. In the classical procedure, the blood and urine samples are collected at  $\frac{1}{2}$  an hour intervals for the next 2½ hours. (Total six samples, including 0-hr sample). Glucose is estimated in all the blood samples. Urine samples are tested for glucose qualitatively. In modern times, only 2 blood samples are collected.

Figure 24.4 represents the graph, when plasma glucose values are plotted on the vertical axis against the time of collection on the horizontal axis.

### Causes for Abnormal GTT Curve

#### Impaired Glucose Tolerance (IGT)

It is otherwise called as **Impaired Glucose Regulation (IGR)**. Here blood sugar values are above the normal level, but below the diabetic levels (Table 24.1).

In IGT, the fasting plasma glucose level is between 110 and 126 mg/dL and 2-hour post-glucose value is between 140 and 200 mg/dL (Fig. 24.4).

Such persons need careful follow-up because IGT progresses to frank diabetes at the rate of 2% patients per year.

#### Impaired Fasting Glycemia (IFG)

In this condition, fasting plasma sugar is above normal (between 110 and 126 mg/dL); but the 2-hour post-glucose value is within normal limits (less than 140 mg/dL). These persons need no immediate treatment; but are to be kept under constant check up.

#### Gestational Diabetes Mellitus (GDM)

This term is used when carbohydrate intolerance is noticed, for the first time, during a pregnancy. **A known diabetic patient, who becomes pregnant, is not included in this category.**

In all antenatal women, a glucose challenge test is done between 22 and 24 weeks of pregnancy by giving an oral glucose load of 50 g of glucose regardless of the time. If the 2-hour post-glucose value is more than 140 mg/dL, the test is positive. An OGTT with 75 g glucose load should be done to confirm or exclude GDM. Some obstetricians prefer to do an OGTT without a screening test with 75 g of glucose. In these cases, three blood samples are drawn, fasting, 1 hour and 2 hour post-glucose load.

Women with GDM are at increased risk for subsequent development of frank diabetes. GDM is associated with an increased incidence of **neonatal mortality**. Maternal hyperglycemia causes the fetus to secrete more insulin,

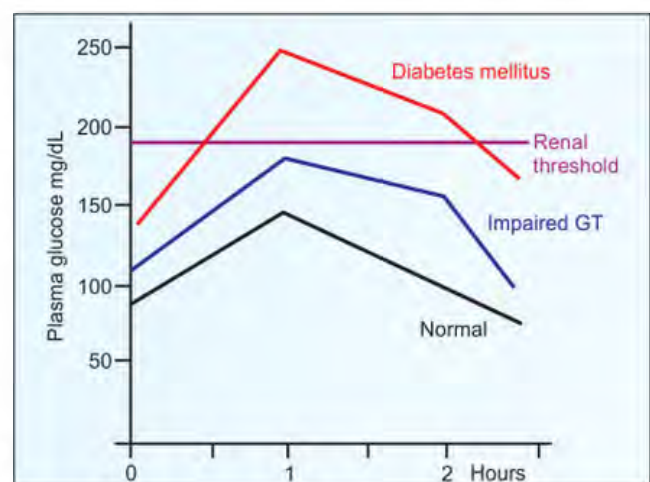


Fig. 24.4: Oral glucose tolerance test (OGTT)



causing stimulation of fetal growth and increased birth weight. After the child birth, the women should be reassessed.

### Alimentary Glucosuria

Here the fasting and 2-hour values are normal; but an exaggerated rise in blood glucose following the ingestion of glucose is seen. This is due to an increased rate of absorption of glucose from the intestine. This is seen in patients after a **gastrectomy** or in **hyperthyroidism**.

### Renal Glucosuria

**Normal renal threshold for glucose is 175–180 mg/dL.** If blood sugar rises above this, glucose starts to appear in urine.

Generally, the increased blood sugar level is reflected in urine. But when renal **threshold is lowered**, glucose is excreted in urine. Renal tubular reabsorption is lowered, as the SGLT2 is abnormal. In these cases, the blood sugar levels are within normal limits. This is called renal glycosuria.

Renal threshold is lowered physiologically in **pregnancy**; it is a harmless condition; it will not progress. About 10% pregnant women show renal glucosuria in the last trimester of pregnancy.

Renal glucosuria is associated with renal diseases with renal tubular transport defects; e.g. **Fanconi's syndrome**. In these cases glucosuria is seen along with amino aciduria and phosphaturia.

In some cases, renal threshold may be increased when glucose will not appear in urine, even though blood sugar is elevated. Here GFR is decreased with minimal or no impairment of tubular reabsorption. This is seen in old age (arteriosclerosis) and in Kimmelsteil-Wilson Syndrome (**diabetic nephrosclerosis**).

### Factors Affecting GTT

1. Insulin level: GTT is used to detect insulin deficiency.
2. Carbohydrate starvation. Therefore, patient is advised to take carbohydrate-rich diet for 3 days before test.
3. Exercise. Patient is advised to take rest during and prior to the test.
4. In liver diseases, curve is elevated and prolonged.
5. In acute infections, cortisol is secreted, and so curve is elevated and prolonged.
6. In hyperthyroidism there will be steep rise in curve. A flat curve is seen in hypothyroidism.

### Corticosteroid Stressed GTT

Cortisone (100 mg) in 2 divided doses are given orally, 8 hours and 2 hours prior to the test. Then glucose is given orally. Normal blood sugar values in

this test will be at 1 hour < 180 mg/dL and at 2 hour < 160 mg/dL. The values will be high in persons who are in pre-diabetic state or in persons prone to get diabetes in future. The cortisone primed test has very limited use, and is seldom done nowadays.

### Intravenous GTT

This test is done in patients with suspected malabsorption, where results of oral GTT may not be conclusive. Then patient is advised to fast for 12 hours. In the morning 25 g of glucose in 100 mL sterile distilled water is given as intravenous injection within 5 minutes. Completion of infusion is taken as 0 time. Blood samples are taken at 10 minute intervals for the next hour. Peak value is reached within a few minutes (200–250 mg/dL). The value reaches 100 mg/dL by 45–60 minutes in normal persons.

## REDUCING SUBSTANCES IN URINE

Normally glucose is not excreted in urine. But if blood sugar is **more than 180 mg/dL**, urine contains glucose. The blood level of glucose above which glucose is excreted is called **renal threshold**.

The excretion of reducing substances in urine is detected by a positive **Benedict's test**. (See Chapter 6). About 0.5 mL of urine is boiled with 5 mL Benedict's reagent for 2 minutes (or kept for 2 minutes in water bath which is already boiling). The formation of a precipitate is observed on cooling. The test is semi-quantitative and the color of the precipitate roughly parallels the concentration of reducing sugar. Blue color indicates the absence of sugar in urine. The green precipitate means 0.5%; yellow (1%); orange (1.5%) and red indicates 2% or more of sugar (1% means 1 g per 100 mL). Nowadays, strips are available, which when dipped in urine will give the color, if it contains sugar.

**Any reducing sugar will give a positive Benedict's test.** So differentiation of various sugars, which may be present in urine has practical importance. Such conditions together are sometimes called as "mellituria". The substances in urine answering Benedict's test are enumerated in Table 24.2. Differential diagnosis of a positive Benedict's test is shown in Box 24.5.

**TABLE 24.2:** Reducing substances in urine

Sugars	Noncarbohydrates
Glucose	Homogentisic acid
Fructose	Salicylates
Lactose	Ascorbic acid
Galactose pentoses	Glucuronides of drugs



**Box 24.5. Differential diagnosis of reducing substances in urine**

1. Glucosuria
  - a. Diabetes mellitus
  - b. Transient glucosuria
  - c. Alimentary glucosuria
  - d. Renal glucosuria
2. Fructosuria
  - a. Deficiency of fructokinase
  - b. Fructose intolerance (aldolase B deficiency) (see Chapter 10)
3. Lactosuria
4. Galactosuria (deficiency of galactose-1-phosphate uridyl transferase) (see Chapter 10)
5. Pentosuria (xylulosuria) (see Chapter 10)
6. Non-carbohydrate reducing substances
  - a. Glucuronides, salicylate
  - b. Ascorbic acid (vitamin C)
  - c. Homogentisic acid

When reducing sugars are excreted in urine, the condition is referred to as **glycosuria**. To denote the excretion of specific sugars the suffix 'uria' is added to the name of the sugar, e.g. **glucosuria**, fructosuria, lactosuria. Glucosuria means glucose in urine; glycosuria means any sugar in urine. Since glucose is the most common reducing sugar excreted in urine, the term glycosuria is often (though incorrectly) used to denote the excretion of glucose.

### Hyperglycemic Glucosuria

- i. When blood glucose level exceeds the renal threshold (175–180 mg/dL), glucose is excreted in urine. **Diabetes mellitus** is the most common cause.
- ii. **Transient glucosuria**. It may occur in some people due to emotional stress. Excessive secretion of anti-insulin hormones like cortisol (anxiety) and thyroid hormone may cause glucosuria. Once the stress is removed, the glucosuria disappears.
- iii. **Renal glucosuria**



Frederick Banting (Right) NP 1923 (1891–1941)  
Charles Best (left) 1899–1978  
Marjorie (middle)



John James Richard Macleod NP 1923 1876–1935



James Bertram Collip 1892–1965



Frederick Sanger b. 1918 NP 1958 and 1980

- iv. **Alimentary glucosuria**; both are described under glucose tolerance test.

### Lactosuria

It is the second most common reducing sugar found in urine. It is observed in the urine of normal women during 3rd trimester of pregnancy and lactation. The condition is harmless. In pregnancy, it is important to distinguish lactosuria from glucosuria when gestational diabetes mellitus is suspected. Methyl amine test will be positive for lactose. To 5 mL of urine 1 mL of methylamine in sodium hydroxide is added. When kept at 56°C for 30 minutes, red color develops indicating the presence of lactose.

### Fructosuria

In hereditary fructose intolerance, due to the absence of the enzyme Aldolase B, fructose is not metabolized, and so excreted in urine (see Chapter 10). Seliwanoff's test will distinguish glucose and fructose. The reagent is resorcinol in HCl. 3 mL of the reagent and 0.5 mL of urine is heated for 30 seconds (up to boiling point). The appearance of red color indicates the presence of fructose.

### Galactosuria

Urine contains galactose in patients with absence of galactose-1-phosphate uridyl transferase (see Chapter 10). Mucic acid test will be positive. Boiling the urine with nitric acid will lead to formation of crystals of mucic acid when either lactose or galactose is present.

### Pentosuria

- i. Essential pentosuria is characterized by the excretion of **L-xylulose** in urine due to deficiency of any of the two enzymes, xylitol dehydrogenase or xylulose reductase (see Chapter 10). It is a harmless condition.
- ii. Rarely alimentary pentosuria may occur due to ingestion of cherries, berries and plums.
- iii. Bial's test will be positive. The reagent contains orcinol in HCl. 0.5 mL of urine and 5 mL of Bial's reagent are heated to boil. A green color indicates the presence of pentoses.

### Non-carbohydrate Reducing Compounds

- i. **Glucuronides**: Many drugs, e.g. isometonic acid, para-amino salicylate, penicillin, cephaloxin, nalidixic acid are excreted



Paul Langerhans 1847–1888



Josef von Mering 1849–1908



Oskar Minkowski 1858–1931



John Abel 1857–1938



as conjugates of glucuronic acid. In alkaline conditions, the glucuronic acid is released, which is a powerful reducing agent. So, Benedict's test will be positive.

- ii. **alkylates** Salicylic acid is conjugated with glycine and excreted in urine. This can give a positive test. But test becomes negative when the drug is withdrawn.
- iii. **Ascorbic acid** Ascorbic acid or vitamin C is a very common ingredient of many tonics. Persons taking such tonics will excrete ascorbic acid in urine. It is a powerful reducing agent. This may cause confusion, as the Benedict's test is positive in such normal individuals.
- iv. **Homogentisic acid** It is an intermediate in the catabolism of the amino acids phenylalanine and tyrosine. It is excreted in **Alkaptonuria**, an inborn error of metabolism (see Chapter 18). This causes a yellow precipitate when treated with Benedict's reagent. This can be distinguished by a positive ferric chloride test.

## Insulin

The word "insulin" is derived from Latin, *insula*, meaning island (islet). In 1869, Langerhans identified the alpha and beta cells in islets of pancreas. In 1889, von Mering and Minkowski produced experimental diabetes by pancreatectomy. In 1922, Banting and Best extracted insulin from pancreas. Insulin was the first hormone to be isolated in a pure form. They injected the extract to a diabetic dog, Marjorie, who was kept alive by regular insulin injections. For this work Banting was awarded Nobel prize in 1923. But Best was deleted in the list and instead John Macleod, the Director of the institution was awarded the Nobel prize. As a compensation, Banting declared that half his share of the prize will go to Best. Macleod declared that half of his share of prize will go to JB Collip, Professor of Medicine, Toronto Hospital, who first administered insulin to his patients. In 1927, Abel crystallized the insulin. In 1954, Sanger studied the amino acid sequence of insulin; it was the first protein in which complete amino acid sequencing was done. For this work Sanger got Nobel prize in 1958. Insulin is the first protein produced by recombinant DNA technology (1982).

## Structure of Insulin

Insulin is a protein hormone with 2 polypeptide chains. The A chain has 21 amino acids and B chain has 30 amino acids. These two chains are joined together by two interchain disulfide bonds, between A7 to B7 and A20 to B19. There is also an intrachain disulfide link in A chain between 6th and 11th amino acids (See Chapter 4, Fig. 4.4). Species variation is restricted to amino acids 8, 9 and 10 of A chain and C terminal of B chain.

## Biosynthesis of Insulin

- i. Insulin is a protein synthesized and secreted by the beta-cells of the islets of Langerhans of the pancreas.
- ii. The insulin is synthesized as a larger precursor polypeptide chain, the **pre-pro-insulin**. It has 109 amino acids. It is rapidly converted to pro-insulin in the endoplasmic reticulum by removal of leader sequence of 23 amino acid residues.
- iii. The **pro-insulin** with 86 amino acids is transported to Golgi apparatus where it is cleaved by a protease (Fig. 24.5). Thus

**-p peptide** or connecting peptide with 33 amino acids is removed. (The number of amino acids in C peptide may vary according to species). Insulin with 51 amino acids is thus formed (Fig. 24.5).

## Secretion of Insulin

Insulin secretion occurs in two phases. The first phase secretion is in response to an elevation of glucose level. The GLUT2 with a high  $K_m$  for glucose allows the entry of glucose into the beta cell which is phosphorylated by glucokinase and further metabolized producing ATP. The closure of ATP sensitive potassium channels leads to depolarization and resultant opening of calcium channels. The influx of calcium causes insulin containing secretory vesicles to fuse with cell membrane and release insulin into the blood. The insulin in turn promotes metabolism of glucose thus lowering glucose level.

The insulin is packed into granules. The molecules take the shape of a hexamer with 2 zinc ions and one calcium ion. Approximately 50 units of insulin is secreted per day. Normal insulin level in blood is 5–15 micro units/mL. Proinsulin contributes 5 to 10% of the total insulin measured in plasma. *roinsu in has a out one third io o ica acti it* as that of insulin. Insulin and C-peptide are synthesized and secreted in equimolar quantities. Therefore, measurement of C-peptide is an index of rate of secretion of insulin. Mutations causing changes in amino acid sequence at the cleavage points can lead to familial **p ro-insulinemia**.

## Factors Increasing Insulin Secretion

1. **Glucose** Glucose is the major stimulant of insulin secretion. As blood glucose level increases, the insulin secretion also correspondingly increases. Glucose induces a biphasic response to insulin secretion. A discharge of insulin from the beta cell storage pool occurs during the initial rapid phase of insulin release within first 2 minutes. The second phase of insulin release lasting for 5–10 minutes is of smaller magnitude and is due to discharge of newly synthesized hormone. The beta cells have **GLUT receptors** (see Chapter 8), through which glucose is absorbed. This is oxidized, so that more ATP is made available. ATP stimulates an **AT Binding cassette** protein (ABC protein) which is referred to as Sulfanyl Urea Receptor (SUR). Simultaneously potassium channels are closed and calcium channels are opened (Fig. 24.6). Increased intracellular **calcium** causes the insulin secretion.

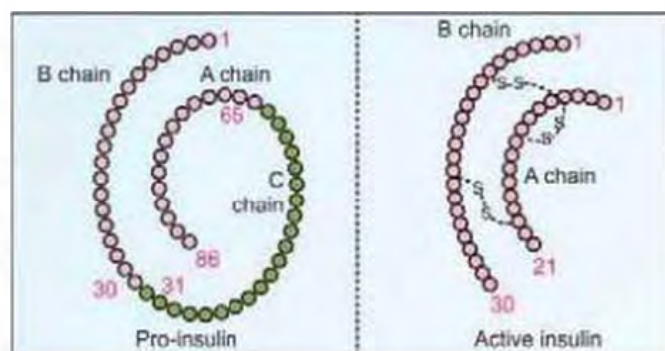


Fig. 24.5: Insulin biosynthesis



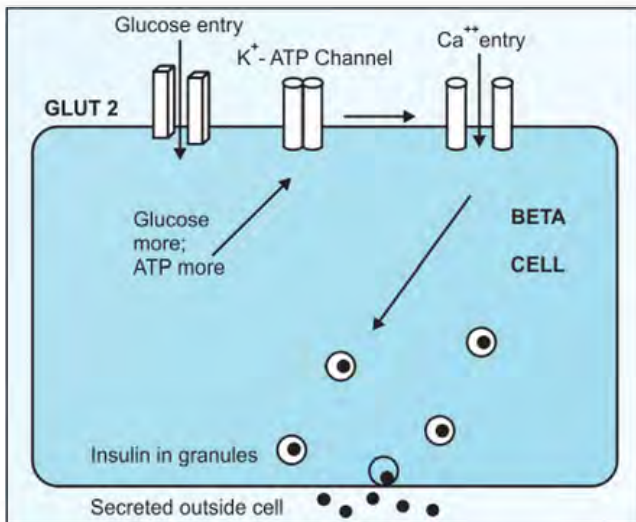


Fig. 24.6: Mechanism of Insulin secretion

2. **Gastrointestinal hormones:** Insulin secretion is enhanced by secretin, pancreaticozymin and gastrin. After taking food, these hormones are increased.
3. **Proteins and amino acids:** Leucine and arginine are stimulants.
4. Parasympathetic and beta-adrenergic stimulation.
5. Glucagon and growth hormone.
6. **Drug:** Tolbutamide.
7. **Incretin hormones:** The **incretins** are hormones that work to **increase insulin secretion**. Nutrient intake stimulates the secretion of the gastrointestinal incretin hormones, glucagon-like peptide-1 (GLP-1) and glucose-dependent insulinotropic polypeptide (GIP). The predominant incretin hormone is GLP-1. GIP has 41–42 amino acids. It is cleaved from its precursor peptide, ProGIP. GLP-1 has 30–31 amino acids, and is cleaved from the proglucagon precursor. GIP is secreted from the K cells in duodenum. GLP-1 is secreted by the L cells, mainly in the ileum. These peptides bind to the GIP or GLP receptors to bring the biological actions.

Glucose in the small intestine stimulates incretin release. Incretins are carried through the circulation to their target tissue: the **pancreatic beta cells**. Incretin stimulation of beta cells causes them to secrete more insulin in response to the same amount of blood glucose. An impaired incretin system, characterized by decreased responsiveness to GIP and markedly reduced GLP-1 concentration, occurs in individuals with type 2 diabetes mellitus (DM). In such cases, administration of GLP-1 improves glycemic control.

The GLP-1 suppresses glucagon secretion, slows gastric emptying, increases satiety, and reduces food intake. GLP-1 is rapidly degraded by the enzyme dipeptidyl peptidase-4 (DPP-4). DPP-4 inhibitors, such as sitagliptin and saxagliptin increase endogenous GLP-1 concentration. An advantage of DPP-4 inhibitors is that they can be taken orally, unlike the GLP-1 agonists, which are peptides and must be injected. Liraglutide, given by SC injection, is a new medication for the treatment of patients with type 2 diabetes. It leads to weight reduction in DM patients. It makes patients feel more full and satisfied with less food. It also reduces

the speed by which the stomach empties. GLP-1 is further described in Chapter 54.

Somatostatin produced by delta cells of pancreas, controls the production of insulin and glucagon. It reduces the secretion of insulin, glucagon and growth hormone.

Visfatin and adiponectin are produced by adipose tissue and have opposite effects on insulin resistance. Visfatin activates the insulin receptor, and increased circulating concentrations have been reported in insulin-resistant states, including obesity and type 2 diabetes mellitus. In contrast, serum adiponectin concentration is inversely correlated with insulin resistance and is reduced in obesity and type 2 diabetes mellitus. In gestational diabetes mellitus (GDM), maternal serum adiponectin is reduced, whereas the concentration of visfatin has been reported to be generally increased. Adiponectin is further described in Chapter 40.

### Factors Decreasing Insulin Secretion

1. **Epinephrine:** During stressful conditions and during exercise, adrenal medulla releases adrenaline. This suppresses insulin release, and at the same time, mobilizes glucose from liver for energy purpose.
2. Alpha adrenergic stimulation.

### Degradation of Insulin

Insulin is rapidly degraded by the liver. **Plasma half-life is less than 5 minutes**. An insulin specific protease (insulinase) is involved in the degradation of insulin.

## Mechanisms of Action of Insulin

### Insulin Receptors

Insulin acts by binding to a plasma **membrane receptor** on the target cells. Insulin receptor is a glycoprotein with 4 subunits: 2 alpha and 2 beta subunits. The alpha units (135 kD) are located on the extracellular side, to which insulin binds. The beta subunits (95 kD) traverse the membrane and are exposed on the cytoplasmic side (Fig. 24.7). Beta subunit has tyrosine kinase activity (receptor tyrosine kinase). In obesity, the number of receptors are decreased and target tissue becomes less sensitive to insulin (diabetes mellitus type 2).

### Signal Transduction

Insulin binds to the alpha subunit of the receptor. Oligomerization of the monomeric receptor around the bound ligand (insulin) occurs. This would trigger the tyrosine kinase activity of the beta subunit. Autophosphorylation and activation of receptor occurs on specific tyrosine residues. The activation of the insulin receptor tyrosine kinase initiates a kinase cascade. The phosphorylated sites act as docking sites for insulin receptor substrates –IRS1 and IRS2 which are proteins with a common structural motif.



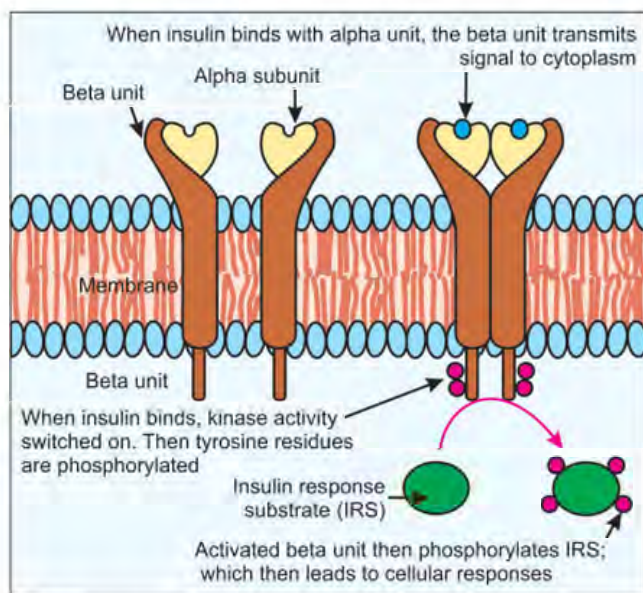


Fig. 24.7: Insulin receptor

A lipid kinase PI3 kinase phosphoinositide 3 kinase binds to phosphorylated sites on IRS1 which converts Phosphatidylinositol diphosphate (PIP<sub>2</sub>) to PIP<sub>3</sub> (Phosphatidylinositol-3,4,5 triphosphate). The PIP<sub>3</sub> in turn activates a PDK1 (PIP<sub>3</sub> dependent kinase), a protein kinase which phosphorylates and activates kinases like Akt (protein Kinase B) by phosphorylation.

The active PKB recruits GLUT4 to cell surface and stimulate glycogen synthesis by its action through GSK3.

The insulin signaling is terminated by the action of specific protein phosphatases that dephosphorylate the proteins and lipids to their initial state. These are serine phosphatases and lipid phosphatases

The activation of insulin action by regulation of gene transcription is mediated through the MAP kinase pathway (Mitogen activated protein kinase).

### Gene Transcription (New Enzyme Synthesis)

Insulin acts at the transcriptional level to regulate synthesis of more than 100 proteins.

- A. Insulin **induces** the following enzymes:
- Glucokinase
  - Pyruvate kinase
  - Phosphofructokinase
  - Acetyl CoA carboxylase
- B. Insulin **represses** the following enzymes:
- Glucose-6-phosphatase
  - Phosphoenolpyruvate carboxykinase
  - Fructose-1,6-bisphosphatase

### Activation of Enzymes

Insulin activates the existing molecules of enzymes by covalent modification (phosphorylation or dephosphorylation). There are more than 50 enzymes activated by this mechanism. A small selected list is shown in Table 24.3. Insulin activates protein phosphatase I (PPI) which dephosphorylates enzyme proteins.

### DNA Synthesis

Through the IRS-1 pathway, (see signal transduction) insulin increases DNA synthesis, cell growth and anabolism. In all the above mentioned pathways, intracellular mediators have been implicated in insulin action. These are Ca<sup>++</sup> and cyclic AMP. Insulin activates phosphodiesterase and thereby decreases cAMP. So, reactions dependent on cAMP are inhibited, e.g. glycogen phosphorylase (see Chapter 10).

### Glucose Uptake

Insulin increases the recruitment of GLUT4 in cells.

## Physiological Actions of Insulin (Metabolic Effects of Insulin)

Insulin plays a central role in regulation of the metabolism of carbohydrates, lipids and proteins (Table 24.4).

### Uptake of Glucose by Tissues

Insulin facilitates the membrane transport of glucose. Facilitated diffusion of glucose in muscle is enhanced by insulin. In diabetes mellitus, the transporter, GLUT4 is reduced (see Chapter 9). However, glucose uptake in liver (by GLUT2) is independent of insulin.

TABLE 24.3: Insulin acting through covalent modification

Enzyme	Activity	Mechanism
Glycogen synthase	Increase	Dephosphorylation
Pyruvate dehydrogenase	Increase	Dephosphorylation
Pyruvate kinase	Increase	Dephosphorylation
Acetyl CoA carboxylase	Increase	Dephosphorylation
HMG CoA reductase	Increase	Dephosphorylation



**TABLE 24.4:** Biological effects of insulin

Metabolism	Key enzyme	Action of insulin on the enzyme	Direct effect	Overall effect
Carbohydrate	Translocase	Stimulation	Glycolysis favored	Hypoglycemia
	Glucokinase	Stimulation		
	Phosphofruktokinase	Stimulation		
	Pyruvate kinase	Stimulation		
	Pyruvate carboxylase	Inhibition	Gluconeogenesis depressed	
	PEPCK	Inhibition		
	Fructose-1,6-bisphosphatase	Inhibition		
	Glucose-6-phosphatase	Inhibition	Glycogen deposition	
	Glycogen synthase	Activation		
	Glycogen phosphorylase	Inactivation		
GPD	Stimulation	Generation of NADPH		
Lipid	Acetyl CoA carboxylase	Stimulation	Lipogenesis favored	Glucose is used for lipogenesis; glucose lowered Decreased ketogenesis
	Glycerol kinase	Stimulation	Lipolysis inhibited	
	Hormone sensitive lipase	Inhibition		
	HMG CoA reductase	Stimulation	Cholesterol synthesis	
Protein	Transaminases	Inhibition	Catabolism inhibited	General anabolism
	Ornithine transcarbamoylase	Inhibition	Protein synthesis favored	
	RNA polymerase			
	and ribosome assembly	Favored		

### Utilization of Glucose

- i. **Glycolysis is stimulated by insulin.** The activity and amount of key glycolytic enzymes (glucokinase, phosphofruktokinase and pyruvate kinase) are increased.
- ii. Glycogen synthase enzyme is activated, and so insulin favors glucose storage as glycogen (see Chapter 10).
- iii. Insulin favors synthesis of fatty acid from glucose and so glucose utilization is increased.

### Hypoglycemic Effect

- i. Insulin lowers the blood glucose level by promoting utilization and storage.
- ii. **Gluconeogenesis is inhibited** by insulin by repressing the key enzymes, pyruvate carboxylase (PC) phosphoenolpyruvate carboxykinase (PEPCK) and glucose-6-phosphatase (see Chapter 9).
- iii. Insulin **inhibits glycogenolysis** by favoring the inactivation of glycogen phosphorylase and inhibiting glucose-6-phosphatase. The net effect of all these three mechanisms, blood glucose level is lowered.

### Lipogenesis

- i. Lipogenesis is favored by providing more acetyl CoA by pyruvate dehydrogenase reaction.
- ii. Insulin increases the activity of **acetyl CoA carboxylase** and provides glycerol for esterification of fatty acids to TAG (see Chapter 12).
- iii. Insulin also provides NADPH by increasing the GPD activity of the HMP shunt pathway.

### Anti-lipolytic Effect

- i. Insulin inhibits lipolysis in adipose tissue due to inhibition of **hormone sensitive lipase**.
- ii. The increased level of FFA in plasma in diabetes is due to the loss of this inhibitory effect on lipolysis.

### Anti-ketogenic Effect

- i. Insulin depresses **HMG CoA synthase** and so ketogenesis is decreased.
- ii. Moreover, in presence of insulin, acetyl CoA is completely utilized in the citric acid cycle, because oxaloacetate generated from glucose is available in plenty. Insulin also favors fatty acid synthesis from acetyl CoA.

- iii. All these factors reduce the availability of acetyl CoA, so that production of ketone bodies reduced.

#### Other General Effects

- Protein synthesis is promoted and degradation is retarded.
- It is an **anabolic** hormone.
- Insulin stimulates replication of cells. In fact, insulin is an essential growth factor for all mammalian cells. These effects are summarized in Table 24.4.

## HYPERGLYCEMIC HORMONES

- Glucagon
- Epinephrine or Adrenaline
- Glucocorticoids
- Adrenocorticotrophic hormone (ACTH)
- Growth hormone
- Thyroxine

All these are anti-insulin hormones.

## GLUCAGON

It is a polypeptide hormone with 29 amino acids. It is secreted by the alpha cells of pancreas. **Enteroglucagon** is a peptide hormone secreted by duodenal mucosa, having same immunological and physiological properties of glucagon. Glucagon is synthesized as a longer proglucagon



Bernardo  
Houssay  
NP 1947  
1887–1971



Hermann  
von Fehling  
1812–1885



Otto Olof  
Folin  
1867–1934



Stanley Rossiter Benedict (1884–1936) discovered the Benedict's Reagent in 1908, while working as a PhD student at Yale University. He was Professor of Physiological chemistry in Cornell University Medical College from 1912 till death.

precursor. Glucagon has a half-life in plasma at about 5 minutes. It is inactivated in the liver. The major regulator of secretion of glucagon is glucose. An increase in blood glucose level inhibits secretion of glucagon.

## Physiological Actions of Glucagon

- Glucagon is the most potent **hyperglycemic** hormone. It is **anti-insulin** in nature. Therefore, the net effect is decided by the insulin-glucagon ratio (Fig. 24.8).
- Glucagon is mainly **glycogenolytic**. The active form of glycogen phosphorylase is formed under the influence of glucagon. Liver is the primary target for the glycogenolytic effect of glucagon.
- It depresses glycogen synthesis.
- Gluconeogenesis** is favored by glucagon by inducing enzymes like PEPCK, glucose-6-phosphatase and fructose-1,6-bisphosphatase.
- Glucagon **increases plasma free fatty acid** level. In adipose tissue glucagon favors **beta-oxidation**, as it activates carnitine acyl transferase. The mitochondrial acetyl CoA level increases.
- Ketogenesis** is favored.

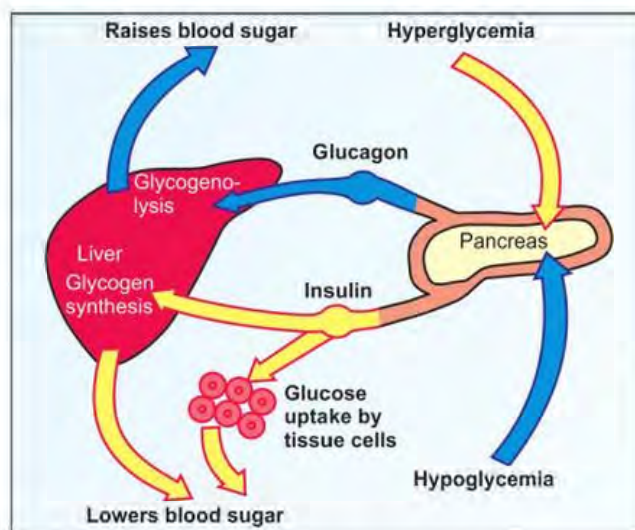


Fig. 24.8: Combined action of insulin and glucagon will keep the blood sugar level within normal limits. High blood sugar stimulates insulin secretion (yellow pathway). Low blood sugar causes glucagon secretion (blue pathway)



### Mechanism of Action

Glucagon combines with a membrane bound receptor. This activates the GDP-bound G-protein, by converting it into GTP form (see Chapter 50). The alpha subunit of the G protein dissociates from the beta and gamma subunits. The alpha subunit binds to GTP. The GTP-G protein will in turn activate adenylate cyclase to convert ATP to cAMP. Cyclic AMP is the second messenger, which combines with the regulatory subunit of the protein kinase so that the catalytic subunit is free to act. The active protein kinase will phosphorylate enzyme proteins and alter their activity: covalent modification and activation of glycogen phosphorylase, inactivation of glycogen synthase, etc.

### Anti-insulin Hormones

- Regulation of carbohydrate metabolism in general depends on the balance between insulin and anti-insulin hormones. A summary is given in Box 24.2. See also Table 24.5.
- Glucocorticoids** act mainly by stimulating gluconeogenesis.
- But **growth hormone** antagonizes insulin in many key metabolic reactions (Table 24.5). Bernado Houssey demonstrated that in pancreatectomised animals, the requirement of insulin was about 100 units per day. When anterior pituitary was also ablated in such animals, the requirement of insulin came down to 10 units or so. This shows that growth hormone antagonizes insulin. Houssey was awarded Nobel prize in 1947.

### DIABETES MELLITUS

The term is derived from the Greek words *dia* (=through), *bainein* (=to go) and *diabetes* literally means pass through. The disease causes loss of weight as if the body mass is passed through the urine. The Greek word, *mellitus*, means sweet, as it is known to early workers, that the urine of the patient contains sugar. Diabetes mellitus is a disease known

from very ancient times. Charaka in his treatise (circa 400 BC) gives a very elaborate clinical description of *madhumeha* (= sweet urine). He had the vision that carbohydrate and fat metabolisms are altered in this disease. In Western literature, Thomas Willis in 1670 noticed the sweet taste of diabetic urine. In 1838, Bouchardt and Peligot proved that the sugar of diabetic urine is the same as that present in grape sugar. A crude test for urine sugar was first developed by Trommer in 1841. Qualitative test for urine sugar was perfected by Hermann Fehling (1848) and semi-quantitative test by Stanley Benedict (1908). Folin in 1919 identified a method for quantitative determination of sugar in blood.

Diabetes mellitus is a metabolic disease due to absolute or relative **insulin deficiency**. Diabetes mellitus is a common clinical condition. About 10% of the total population, and about 1/5th of persons above the age of 50, suffer from this disease. It is a major cause for morbidity and mortality. Insulin deficiency leads to increased blood glucose level. In spite of this high blood glucose, the entry of glucose into the cell is inefficient. Hence all cells are starved for glucose.

**Criteria for diagnosis** of diabetes mellitus are shown in Table 24.1, and under glucose tolerance test. The disease may be classified as follows (WHO recommendation, 1999):

### Type 1 Diabetes Mellitus

(formerly known as **Insulin-dependent** diabetes mellitus; IDDM). About 5% of total diabetic patients are of type 1. Here circulating insulin level is deficient. It is subclassified as:

- Immune mediated and
- Idiopathic.

**TABLE 24.5:** Comparison of action of insulin and anti-insulin hormones

Metabolism	Key enzymes	Insulin	Glucagon	Glucocorticoids	Growth hormone
Glycolysis	GK, PFK and PK	Stimulation			Inhibition
Gluconeogenesis	PEPCK, G6 Pase, F-bisphosphatase	Inhibition	Stimulation	Stimulation	Stimulation
Glycogen synthesis	Glycogen synthase	Activation	Inhibition		
Glycogenolysis	Phosphorylase	Inactivation	Activation		
Lipolysis	Hormone sensitive lipase	Inhibition	Stimulation	Stimulation	Stimulation
Ketogenesis	Carnitine acyl transferase	Inhibition	Stimulation		Stimulation
Protein breakdown	Transaminases	Inhibition		Stimulation	
Protein synthesis		Anabolism		Catabolism	Anabolism
Blood sugar level		Decreases	Increases	Increases	Increases



## Type 2 Diabetes Mellitus

(Formerly known as **non-insulin dependent** diabetes mellitus; NIDDM). Most of the patients belong to this type. Here circulating insulin level is normal or mildly elevated or slightly decreased, depending on the stage of the disease. This type is further classified as:

- a. Obese
- b. Non-obese

## Diabetic Prone States

- a. Gestational diabetes mellitus (GDM);
- b. Impaired glucose tolerance (IGT);
- c. Impaired fasting glycemia (IFG)
- d. Metabolic syndrome (described below)

## Secondary to Other Known Causes

- a. Endocrinopathies (Cushing's disease, thyrotoxicosis, acromegaly);
- b. Drug induced (steroids, beta blockers, etc.);
- c. Pancreatic diseases (chronic pancreatitis, fibro-calcular pancreatitis, hemochromatosis, cystic fibrosis)
- d. Anti-insulin receptor autoantibodies (Type B insulin resistance)
- e. Mutations in the insulin gene or insulin receptor gene (acanthosis nigricans)
- f. MODY (Maturity Onset Diabetes of Young).

MODY was previously considered to be a third form of type 2 diabetes. However, with the discovery of specific mutations leading to MODY, it is now classified under secondary diabetes. MODY is characterized by onset prior to age 25, impaired beta cell function and insulin resistance. Mutations of about 10 different genes have been correlated with the development of MODY. Some of these mutations are described below:

**MODY1:** The transcription factor, hepatic nuclear factor-4 $\alpha$  (HNF-4 $\alpha$ ; gene symbol, HNF4A), otherwise called transcription factor-14 (TCF14). Genes known to be regulated by HNF-4 $\alpha$  include the insulin gene, glucose-6-phosphatase, GLUT2, the liver pyruvate kinase isoform (L-PK) which is also expressed in the pancreas, glyceraldehyde-3-phosphate dehydrogenase (G3PDH) and aldolase B. MODY1 is characterized by a normal response to insulin but an impaired insulin secretory response in the presence of glucose.

**MODY2:** Pancreatic glucokinase.

**MODY3:** The transcription factor HNF-1 $\alpha$  (gene symbol, HNF1A), otherwise called hepatocyte transcription factor-1 (TCF1). It regulates the GLUT2 and L-PK genes.

**MODY4:** The transcription factor insulin promoter factor-1 (IPF-1), otherwise called PDX1 (pancreas duodenum homeobox-1).

**MODY5:** The transcription factor HNF-1 $\beta$  (Gene symbol, HNF1B), otherwise called hepatocyte transcription factor-2 (TCF2).

Mutations in this gene are associated with pancreatic hypoplasia, defective kidney development and genital malformations.

- g. Many other genetic syndromes have either diabetes as a salient feature; these include Down syndrome, Klinefelter syndrome (XXY males), Turner syndrome, myotonic dystrophy, muscular dystrophy, Huntington disease, Friedreich ataxia, Prader-Willi syndrome and Cockayne syndrome

## Type 1 Diabetes Mellitus (T1DM)

- i. It is due to **decreased insulin production**. Circulating insulin level is very low. These patients are dependent on insulin injections. Onset is usually below 30 years of age, most commonly during adolescence. They are more prone to develop ketosis.
- ii. An **autoimmune basis** is attributed to most of these cases. Circulating antibodies against insulin is seen in 50% cases, and antibodies against islet cell cytoplasmic proteins are seen in 80% cases. Type 1 diabetes mellitus is an autoimmune disease in which pathologic, autoreactive T cells of the immune system attack the insulin-secreting pancreatic islets of Langerhans. Cytotoxic T cells, which bear the CD8 protein on their membrane, kill islets, thereby leading to lifelong dependence on insulin for affected patients. Over time, poorly controlled blood glucose levels inevitably result in early illness and early death. Insulin and the 65-kD isoform of glutamic acid decarboxylase (GAD) are major autoantigens in patients with type 1 diabetes. GAD is a naturally occurring protein found in the brain and in insulin-secreting islets of the pancreas. It is a self protein that functions as an autoantigen in patients with type 1 diabetes. The self proteins can be subject to attack not only by autoreactive T cells but also by autoantibodies to GAD. A variety of other autoantibodies, such as the insulinoma-associated-2 autoantibody (IA-2), insulin autoantibody (IAA), and islet-specific glucose-6-phosphatase-related protein (IGRP) are also seen.
- iii. There is excessive secretion of glucagon in IDDM patients. Normally, hyperglycemia leads to reduced glucagon secretion. However, in patients with IDDM, glucagon secretion is not suppressed by hyperglycemia. The resultant inappropriately elevated glucagon levels exacerbates the metabolic defects.

## Type 2 Diabetes Mellitus (T2DM)

- i. 95% of the patients belong to this type. The disease is due to the decreased biological response to insulin, otherwise called **insulin resistance**. So, there is a relative insulin deficiency.
- ii. Type 2 disease is commonly seen in individuals above 40 years. These patients are less prone to develop ketosis.



- iii. About 60% of patients are **obese**. These patients have insulin resistance and **high/normal plasma insulin** levels.
- iv. Insulin resistance develops as a consequence of excess accumulation of fat in liver and skeletal muscle. The free fatty acid level increases, exceeds the capacity of mitochondrial oxidation and spill over to cytoplasm where it is re-esterified. The consequent increase in diacylglycerol (DAG), a second messenger, leads to activation of a protein kinase C (PKC). Phosphorylation of IRS by PKC reduces the normal signal transduction by insulin leading to insulin resistance.

When there is insulin resistance (IR), the beta cells respond by synthesizing more proinsulin and insulin to overcome the resistance. Processing of excess proinsulin leads to stress in endoplasmic reticulum (ER stress), which provokes an unfolded protein response (UPR) in the cell. This attempt fails when the ER stress is persistent and excessive and apoptosis is triggered. The resultant beta cell destruction leads to development of full-fledged type 2 diabetes mellitus.

- v. A high-caloric diet coupled with a sedentary lifestyle are the major contributing factors in the development of the insulin resistance and pancreatic beta-cell dysfunction. A major susceptibility locus for type 2 diabetes, named as NIDDM1, is located on chromosome 2. The first gene identified in the NIDDM1 locus is calpain 10 (CAPN10). Genetic variants in CAPN10 may alter insulin secretion or insulin action as well as the production of glucose by the liver. Lipoprotein (a) or Lp(a) (see Chapter 25) is associated inversely with risk of type 2 diabetes. Increased concentrations of serum CD163 predict increased risk of type 2 diabetes in the general population and may be useful for identification of high-risk overweight individuals.

## Metabolic Syndrome (MetS)

It is a combination of abdominal obesity, atherogenic dyslipidemia (hypertriglyceridemia and low HDL cholesterol), elevated blood pressure and elevated plasma glucose. The characteristic features are abdominal obesity, insulin resistance and decreased glucose tolerance (Box 24.6). The body cannot properly use glucose even in presence of normal insulin level. In other words, body cannot use insulin efficiently. Therefore, the metabolic syndrome is also called the **insulin resistance syndrome**. Syndrome X and cardiometabolic syndrome are other terms used to describe the same condition. People with MetS are at increased risk of coronary heart disease and type 2

### Box 24. 6. Criteria for diagnosis of metabolic syndrome

- i. Elevated waist circumference: (For men >90 cm and for women, >80 cm).
- ii. Elevated triglycerides: >150 mg/dL
- iii. Reduced HDL ("good") cholesterol: For men, <40 mg/dL; for women, < 50 mg/dL
- iv. Elevated blood pressure: >130/85 mm Hg
- v. Elevated fasting glucose: >100 mg/dL
- vi. Insulin resistance (hyperinsulinemia)
- vii. Additional parameters include coagulation abnormalities, hyperuricemia, microalbuminuria non-alcoholic steato-hepatitis (NASH) and increased CRP
- viii. Diagnosis is made, if the first criterion and any two of other criteria are present.

diabetes. The MetS has become increasingly common in the developing countries.

Some people are genetically predisposed to insulin resistance. Acquired factors, such as excess body fat and physical inactivity, can elicit insulin resistance and the metabolic syndrome in these people. Most people with insulin resistance have abdominal obesity. Diagnostic criteria are shown in Box 24.6.

Abdominal obesity, the most prevalent manifestation of metabolic syndrome, is a marker of 'dysfunctional adipose tissue'. Obesity and adipocytokines are discussed in Chapter 40.

### Management of Metabolic Syndrome

- i. Weight loss to achieve a desirable weight.
- ii. Moderate exercise every day.
- iii. Reduced intake of saturated fats, trans fatty acids and cholesterol.

## Metabolic Syndrome (MetS) and Polycystic Ovary Syndrome (PCOS)

They have overlapping features. The common factors are insulin resistance and obesity. In PCOS there is hyperandrogenism. Those with PCOS have an increased risk for coronary vascular disease as in patients with MetS. PCOS may be corrected to some extent by lifestyle modification during the adolescent age by weight reduction and exercise. A higher prevalence of PCOS is seen in women with type 2 diabetes mellitus. Overweight adolescents with PCOS are at increased risk of developing impaired glucose tolerance and type 2 diabetes mellitus.



### Derangements in Carbohydrate Metabolism

Insulin deficiency decreases the uptake of glucose by cells. The insulin dependent enzymes are also less active. Net effect is an **inhibition of glycolysis and stimulation of gluconeogenesis** leading to **hyperglycemia**.

### Derangements in Lipid Metabolism

- i. Enhanced lipolysis leads to high FFA levels in plasma and consequent accumulation of fat in liver leading to NAFLD (Non alcoholic fatty liver disease).
- ii. More acetyl CoA is now available, which cannot be efficiently oxidized by TCA cycle, because the availability of oxaloacetate is limited. The stimulation of gluconeogenesis is responsible for the depletion of oxaloacetate.
- iii. The excess of acetyl CoA therefore, is diverted to ketone bodies, leading to **ketogenesis** (see Chapter 12). This tendency is more in type 1 disease.
- iv. There is **hyperlipidemia**, especially an increase in NEFA, TAG and cholesterol in plasma.

### Derangement in Protein Metabolism

Increased breakdown of proteins and amino acids for providing substrates for gluconeogenesis is responsible for muscle wasting.

## Clinical Presentations in Diabetes Mellitus

### Cardinal Symptoms

1. When the blood glucose level exceeds the renal threshold glucose is excreted in urine (**glucosuria**).
2. Due to osmotic effect, more water accompanies glucose (**polyuria**).
3. To compensate for this loss of water, thirst center is activated, and more water is taken (**polydipsia**).
4. To compensate the loss of glucose and protein, patient will take more food (**polyphagia**).
5. The loss and ineffective utilization of glucose leads to breakdown of fat and protein. This would lead to **loss of weight**. Important differential diagnosis for weight loss are diabetes mellitus, tuberculosis, hyperthyroidism, cancer and AIDS.
6. Often the presenting complaint of the patient may be **chronic recurrent infections**, such as boils, abscesses, etc. Any person with recurrent infections

should be investigated for diabetes. When glucose level in extracellular fluid is increased, bacteria get good nutrition for multiplication. At the same time, macrophage function of the host is inefficient due to lack of efficient utilization of glucose. In India, **tuberculosis** is commonly associated with diabetes.

## ACUTE METABOLIC COMPLICATIONS

### Diabetic Keto Acidosis

Ketosis is more common in type 1 diabetes mellitus. Ketone body formation and explanations for ketosis are described in Chapter 11. Normally the blood level of ketone bodies is less than 1 mg/dL and only traces are excreted in urine (not detectable by usual tests). But when the rate of synthesis exceeds the ability of extrahepatic tissues to utilize them, there will be accumulation of ketone bodies in blood. This leads to **ketonemia**, excretion in urine (**ketonuria**) and smell of **acetone** in breath. All these three together constitute the condition known as **ketosis**.

### Diagnosis of Ketosis

The presence of ketosis can be established by the detection of ketone bodies in urine by **Rothera's test**. Supportive evidence may be derived from estimation of serum electrolytes, acid-base parameters and glucose estimation. **Rothera's Test:** Saturate 5 mL of urine with solid ammonium sulfate. Add a few drops of freshly prepared sodium nitroprusside followed by 2 mL of liquor ammonia along the sides of the test tube. Development of a purple ring indicates the presence of ketone bodies in urine. Strip tests based on the same principle are also available.

American Diabetes Association (ADA) criteria for DKA include serum glucose above 250 mg/dL, serum anion gap >10 mEq/L, bicarbonate below 18 mEq/L, serum pH less than 7.30, and presence of ketosis. In the past, measuring these parameters required both arterial blood gas and serum chemistry results. Today, many laboratories have implemented blood gas analyzers that report not only standard ABG measurements, such as serum pH and bicarbonate, but also analytes like sodium, potassium, and glucose. It is better clinically to report beta-hydroxybutyrate than ketones (acetone and acetoacetate). The reason is, in ketoacidosis, beta-hydroxybutyrate rises first and acetoacetate and acetone actually drop a little. So serum or urine ketone measurements using semi-quantitative methods may mislead.



### Differential Diagnosis of Ketosis

The urine of a patient with **diabetic** ketoacidosis will give positive Benedict's test as well as Rothera's test. But in **starvation** ketosis, Benedict's test is negative, but Rothera's test will be positive.

### Causes for Ketosis

- Diabetes mellitus:** Combination of hyperglycemia, glucosuria, ketonuria and ketonemia is called **diabetic ketoacidosis (DKA)**. Diabetes mellitus is the most common cause for ketosis. Even though glucose is in plenty, the **deficiency of insulin** causes accelerated lipolysis and more fatty acids are released into circulation. Oxidation of these fatty acids increases the acetyl CoA pool. Enhanced gluconeogenesis restricts the oxidation of acetyl CoA by TCA cycle, since availability of oxaloacetate is less.
- Starvation:** In starvation, the dietary supply of glucose is decreased. Available oxaloacetate is channeled to gluconeogenesis. The increased rate of lipolysis is to provide alternate source of fuel. The excess acetyl CoA is converted to ketone bodies. The high **glucagon** favors ketogenesis. **Hyperemesis** (vomiting) in early pregnancy may also lead to starvation-like condition and may lead to ketosis.

In both diabetes mellitus and starvation, the oxaloacetate is channeled to gluconeogenesis; so the availability of oxaloacetate is decreased. Hence, acetyl CoA cannot be fully oxidized in the TCA cycle. Oxaloacetate is diverted for gluconeogenesis; then citric acid cycle cannot function optimally. Thus, on

the one hand, acetyl CoA is generated in excess; on the other hand, its utilization is reduced. This excess acetyl CoA is channeled into ketogenic pathway (Fig. 24.9).

### Consequences of Ketosis

- Metabolic acidosis.** Acetoacetate and beta-hydroxy butyrate are acids. When they accumulate, metabolic acidosis results. (See Chapter 29). There will be increased **anion gap**.
- Reduced buffers.** The plasma bicarbonate is used up for buffering of these acids.
- Kussmaul's respiration.** Patients will have typical acidotic breathing due to compensatory hyperventilation.
- Smell of acetone** in patient's breath.
- Osmotic diuresis** induced by ketonuria may lead to dehydration.
- Sodium loss.** The ketone bodies are excreted in urine as their sodium salt, leading to loss of cations from the body.
- High potassium:** Due to lowered uptake of potassium by cells in the absence of insulin.
- Dehydration.** The sodium loss further aggravates the dehydration.
- Coma.** Hypokalemia, dehydration and acidosis are contributing for the lethal effect of ketosis.

### Management of Ketosis

- Parenteral administration of insulin and glucose by intravenous route to control diabetes.
- Intravenous bicarbonate to correct the acidosis.
- Correction of water imbalance by normal saline.

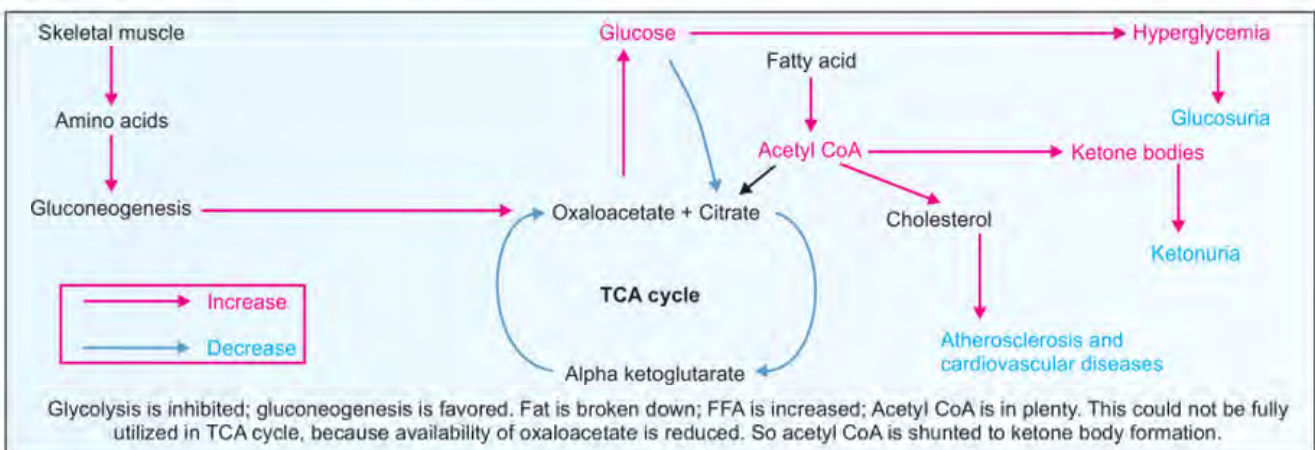


Fig. 24.9: Metabolic derangements in diabetes mellitus



4. Correction of electrolyte imbalance: Insulin induces glycogen synthesis and along with that extracellular potassium is transferred back to intracellular compartment. This may cause dangerous hypokalemia, which should be promptly corrected.
5. Treatment of underlying precipitating causes, such as infection.

## Lactic Acidosis

It is another acute complication. It occurs due to overproduction and or under-utilization of lactic acid. Overproduction can result from an increased rate of anaerobic glycolysis due to hypoxia. Under-utilization may be due to impairment of TCA cycle. Lactic acidosis is seen when diabetic patients are treated with biguanides. This drug inhibits TCA cycle and gluconeogenesis (Box 24.7).

## Chronic Complications of Diabetes Mellitus

When there is hyperglycemia, proteins in the body may undergo glycation. It is a non-enzymatic process. Glucose forms a **Schiff base** with the N-terminal amino group of proteins (Fig. 24.10). This is reversible. Later, **Amadori rearrangement** takes place to form ketoamines, when the attachment becomes irreversible. The overall reaction is called **Maillard reaction**. The glycation first occurs in circulating proteins like hemoglobin, albumin and LDL and then to extracellular proteins. The advanced glycation

### Box 24.7. What is lactic acidosis?

Lactate is the normal end product of anaerobic glycolysis. All tissues can produce lactate and liver can metabolise it. The blood level seldom exceeds 1.5 mmol/L. Under conditions of decreased oxygen availability, as in vigorous exercise, the rate of lactate production increases. The term lactic acidosis denotes a pathological state, when the lactate level in blood is more than 5 mmol/L. So blood pH is low, with decreased levels of bicarbonate. Collection of blood for lactate estimation has to be done avoiding tissue hypoxia, so that falsely elevated values are not obtained.

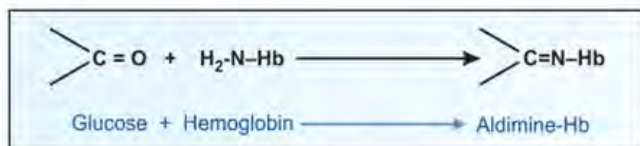


Fig. 24.10: Formation of Hb A1c

end products (AGE) deposition in tissues and endothelium lead to all the chronic complications of diabetes mellitus.

1. **Vascular diseases:** Atherosclerosis in medium sized vessels, **plaque formation** and consequent intravascular thrombosis may take place. If it occurs in cerebral vessels, the result is paralysis. If it is in coronary artery, myocardial infarction results. In the case of small vessels, the process is called **microangiopathy**, where endothelial cells and mural (cement) cells are damaged. Amyloglycans are deposited in mural cells, so that cementing ability is lost. This leads to microangiopathy, which may lead to diabetic retinopathy and nephropathy.
2. **Complications in eyes:** Early development of **cataract** of lens is due to the increased rate of sorbitol formation, caused by the hyperglycemia. Retinal microvascular abnormalities lead to **retinopathy** and blindness.
3. **Neuropathy:** Peripheral neuropathy with paresthesia is very common. Decreased glucose utilization and its diversion to sorbitol in Schwann cells may be one cause for neuropathy. Another reason proposed is the production of advanced glycation end products. Neuropathy may lead to risk of foot ulcers and gangrene. Hence, care of the feet in diabetic patients is important.
4. **Kimmelsteil-Wilson syndrome** is another complication of diabetes, resulting from nephrosclerosis, characterized by proteinuria and renal failure. Persistent hyperglycemia leading to glycation of basement membrane proteins may be the cause of nephropathy.
5. **Pregnancy:** Diabetic mothers tend to have big babies, because insulin is an anabolic hormone. Chances of abortion, premature birth and intrauterine death of the fetus are also more, if the diabetes is not properly controlled.

## Hyperosmolar Nonketotic Coma

It can result due to elevation of glucose to very high levels (900 mg/dL or more). This would increase the osmolality of extracellular fluid (ECF). Osmotic diuresis leads to water and electrolyte depletion. The coma results from dehydration of cerebral cells due to hypertonicity of ECF.

## Laboratory Investigations in Diabetes

Random blood sugar estimation and oral glucose tolerance tests are used for the diagnosis (Table 24.1).



### Blood Glucose Level

For monitoring a diabetic patient, periodic check of fasting and post-prandial blood glucose are to be done at least once in 3 months. Blood glucose level has to be maintained within the normal limits. Persistent hyperglycemia is the most important factor, which leads to chronic complications.

### Complete Lipid Profile

Total cholesterol, triglycerides, HDL and LDL cholesterol levels may be done once in 6 months (see Chapter 13 and 25).

### Kidney Function Tests

Blood urea and serum creatinine may be done at least twice an year (see Chapter 27).

### Micro-albuminuria and Frank Albuminuria

Presence of albumin (50 to 300 mg/day) in urine is known as micro-albuminuria (see Chapter 27). It is a predictor of progressive renal damage. Albumin more than 300 mg/day indicates overt diabetic nephropathy. Micro-albuminuria is to be checked at least once in an year.

### Glycated Hemoglobin

- i. The best index of long-term control of blood glucose level is measurement of glycated hemoglobin or glycohemoglobin.
- ii. Enzymatic addition of any sugar to a protein is called "glycosylation", while non-enzymatic process is termed "glycation".
- iii. **When once attached, glucose is not removed from hemoglobin.** Therefore, it remains inside the erythrocyte, throughout the lifespan of RBCs (120 days) (Fig. 24.11).
- iv. The glycated hemoglobins are together called HbA1 fraction. Out of this 80% molecules are HbA1c, where glucose is attached to the N-terminal valine of beta chain of hemoglobin. The rest of molecules are HbA1a1, where fructose-1,6-bisphosphate and HbA1a2, where glucose-6-phosphate are attached. When glycation

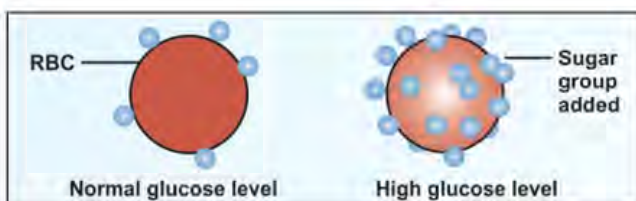


Fig. 24.11: Glycation is parallel to the blood glucose

takes place at the internal lysine residues of alpha or beta chains, it is called HbA1d. All the HbA1 groups are fast hemoglobins, having increased electrophoretic mobility. Routine clinical assays are carried out by chromatography. Immunoturbidimetric method is employed because it is simple and easier. The value of HbA1c is expressed as a fraction of the total Hb. Routine clinical assays are now carried out by high performance liquid chromatography (HPLC).

### Interpretation of Glycohemoglobin Values

- i. The determination of glycated hemoglobin is not for diagnosis of diabetes mellitus; but only for monitoring the response to treatment. The Hb A1c level **reveals the mean glucose level over the previous 10–12 weeks.** It is unaffected by recent food intake or recent changes in blood sugar levels. The estimation should be done at least every 3 months in all diabetic patients; however, it is better to do once in every month, so as to analyze the effectiveness of the treatment.
- ii. Normally the level of Hb A1c is less than 5.5%. The value 5.5% denotes very good control of diabetes by treatment measures; 7% means adequate control; 8% inadequate control and 9% means very poor control. Any value above 5.5% is to be closely watched and values between 5.6 and 6.4 are to be considered as impaired glucose tolerance. 6.5% and above means the person is diabetic.
- iii. Based on the results of the A1c-derived Average Glucose (ADAG) value study, it is recommended to express the values as **estimated average glucose, or eAG.** This method is intended to help healthcare providers report HbA1c results to patients using the same units (mg/dL) that patients see routinely in blood glucose measurements. Thus, HbA1c value of 5.5% represents average glucose level of 110 mg/dL; 6% represents level of 126 mg/dL; 7% means 154 mg; 8% means 183 mg; 9% means 212 mg; and HbA1c 10% equals 240 mg/dL.
- iv. An elevated glycohemoglobin indicates **poor control of diabetes mellitus.** The risk of retinopathy and renal complications are proportionately increased with elevated glycated hemoglobin value. Reduction in 1% of glycoHb will decrease long-term complications to an extent of 30%. Fluctuations of HbA1c are postulated to be responsible for long-term complications of diabetes like retinopathy and nephropathy.
- v. In column chromatography methods, HbA1c and HbF moves similarly, so abnormal high values are seen in thalassemia, even



though the patient is non-diabetic. On the other hand, HbA1c values are lowered in sickle cell anemia (HbSS, HbSC and HbCC), even though the patient is having diabetes. More recent technique, immunoturbidimetric measurement will remove the above false readings. However, any type of anemia, where RBC lifespan is reduced, will reflect in lowered HbA1c value, because the time averaged value is less.

- vi. HbA1c value increases by 0.1% with every 10 years of age. Therefore, values for elderly patients will significantly differ from young adults. Moreover, some individuals have HbA1c values that are higher than expected from measurements of blood glucose; they are called **rapid glycoators**. Such increased glycation contributes to the risk of microvascular complications, and so HbA1c value is a better index for future complications.
- vii. Advantages of HbA1c over fasting blood sugar estimation are (1) For HbA1c, fasting sample is not required; the test may be done at any time. This adds convenience to the patient. (2) Low intraindividual variability < 2%. (3) HbA1c sample is stable; while blood sugar level is lowered unless precautions are taken. (4) HbA1c value is not altered by acute factors, while many factors will affect blood sugar values. (5) HbA1c reflects long-term glucose control, while blood sugar estimation will show the result of a particular time only. (6) HbA1c is a better index for predicting complications. Because of all these reasons, HbA1c has become the preferred test nowadays.

### Fructosamines

Along with other proteins, albumin is also glycated in diabetes mellitus. Glycated albumin is more correctly called as **fructosamine albumin**. As half-life of albumin is about 20 days, gluco-albumin concentration reflects the glucose control over a recent past, for a period of last 2–3 weeks. Estimation of serum fructosamine is preferred in gestational diabetes mellitus.

### Advanced Glycation End Products (AGEs, AGEP)

These are found in the tissues of diabetic patients. Such glycation of matrix proteins, when once occurred, is completely irreversible. Glycation of collagen alters the properties, cross linking is increased and **elasticity** of collagen is lost. In diabetes, the dihydroxy acetone phosphate (an intermediary of glycolysis), is converted to methyl glyoxal, which facilitate protein adduct formation and consequent protein inactivation. Adhesion of plasma proteins in the altered blood vessels leads to accumulation of LDL, and consequent **atherosclerosis**. In diabetic vascular tissues the concentration of AGE is 4 times than normals. Microvascular damage in diabetes is attributed to AGEs. Uptake of AGEs by macrophages will lead to production of inflammatory cytokines.

Study reveals that increased AGEs are associated with oxidative stress in the elderly groups. Such AGEs formation might have a role in **cataract formation**, which, in diabetic patients, occurs more commonly as compared with non-diabetic cataract patients. The rate of formation of AGEs is proportional to the square of glucose concentration. Excessive formation and accumulation of AGEs lead to cross linking of extracellular proteins, altered matrix interactions and modification of DNA structure and function. **Aminoguanidine** is an inhibitor of the formation of AGEs; this may reduce the complications of diabetes mellitus.

## Management of Diabetes Mellitus

1. **Diet and exercise:** This is the first line of treatment. A diabetic patient is advised to take a balanced diet with high protein content, low calories, devoid of refined sugars and low saturated fat, adequate PUFA, low cholesterol and sufficient quantities of fiber. Vegetables are the major sources of minerals, vitamins and fiber. Low-carbohydrate ketogenic diet (LCKD) was found to be quite promising in controlling diabetes mellitus. LCKD has a significant beneficial effect in ameliorating the diabetic state and helping to stabilize hyperglycemia.
 

Alpha glucosidase inhibitor, acarbose inhibits the alpha-glucosidases present in the small intestinal brush border. So absorption of glucose is reduced. This allows the pancreas to more effectively regulate insulin secretion. It is effective at reducing fasting plasma glucose (FPG) levels and levels of glycosylated hemoglobin (HbA1c).
2. **Oral hypoglycemic agents:** There are several types of oral hypoglycemic agents (OHA) now in use. The conventional types are sulfonylurea and biguanides (Metformin) used in type 2 DM. Other groups include glitazones, dipeptidyl peptidase inhibitors, which are often combined with the conventional drugs.
3. **Insulin injections:** Insulin is the drug of choice in type 1 disease. It is also used in type 2 disease, where oral drugs are not sufficient. The availability of human insulin prepared by recombinant DNA technology has markedly improved the response of patients.
4. Prevention of complications.

## Hypoglycemia

Hyperglycemia causes harm; but hypoglycemia is **fatal**. A fall in plasma glucose less than 50 mg/dL is life-threatening (Fig. 24.12). Causes of hypoglycemia are:

1. **Overdose of insulin:** This is the most common cause. The differentiation of hypoglycemic coma from



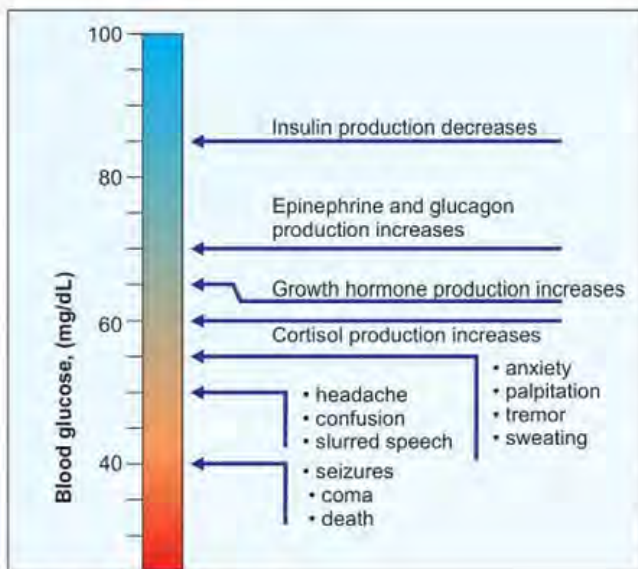


Fig. 24.12: Hypoglycemia is fatal

hyperglycemic coma (ketosis) is important, since treatment is exactly opposite. The diagnosis is mainly based on blood glucose estimation.

2. **Post-prandial hypoglycemia:** 2–3 hours after a meal, transient hypoglycemia is seen in some persons. This is due to over-secretion of insulin.
3. **Insulinoma:** Insulin secreting tumors are rare.
4. **Von Gierke's disease** (see Chapter 10).

### Clinical Case Study 24.1

A 45-year-old obese male had a tooth infection. Prior to extraction he was advised to have a routine blood and urine examination. The results were:

Total WBC count: 35,000/cmm

Differential count: P70, L20, E7, M2, B1

ESR: 45 mm/hr

Urine albumin: Trace

Urine sugar: Orange precipitate

Urine ketone bodies: Nil

Urine bile salts: Nil

Urine bile pigments: Nil.

- A. What are the further investigations to be done in this patient? Explain the rationale behind each test.
- B. When the diagnosis is confirmed and treatment started, how will you monitor the patient?
- C. What are the possible complications that can be avoided by proper monitoring of the patient?

### Clinical Case Study 24.2

A person is brought to the Emergency Department in a comatose state. The following test results were obtained Blood sugar – 400 mg%, Benedict's test (Urine) – Red precipitate, Rothera's test (Urine) – Positive, Serum Bicarbonate – 12 mEq/L, Plasma pH – 7.14. What is your probable diagnosis?

### Clinical Case Study 24.3

A person is brought to the Emergency Department in a comatose state. The following test results were obtained – Blood sugar – 40 mg%, Benedict's test (Urine) – Negative, Rothera's test (Urine) – Negative, Serum Bicarbonate – 12 mEq/L, Plasma pH – 7.14. What is your probable diagnosis?

### Clinical Case Study 24.4

A 19-year-old with 4 year history of juvenile diabetes mellitus was brought to the Emergency Department in state of coma. The following laboratory results were obtained – Blood sugar – 1300 mg%, Plasma pH – 7.1, pCO<sub>2</sub> – 13 mm Hg, Pulse rate – 120/min, Respiratory rate – 28/min. What is your probable diagnosis? What is the pathophysiology of the above condition?

### Clinical Case Study 24.5

A 55-year-old man with long standing diabetes mellitus presented with fever, pruritis, delirium and low urine output. His blood urea level was 135 mg% and urea clearance was 35 mL/min. What is the most likely diagnosis?

### Clinical Case Study 24.6

A 52-year-old woman with a medical history of hepatitis B, hyperlipidemia, hypertension and anemia, presented to the medicine department for a routine visit. Laboratory tests 3 months previously had revealed an impaired fasting glucose concentration of 118 mg/dL [reference interval, 70–110 mg/dL]. Therefore, a hemoglobin HbA<sub>1c</sub> analysis was performed. The initial HbA<sub>1c</sub> evaluation by HPLC showed an HbA<sub>1c</sub> value of 12.8% (reference interval, 4.0–5.5.0%). What are the various types of methods used for measuring HbA<sub>1c</sub>? How do Hb variants interfere with each of these HbA<sub>1c</sub> methods? What actions should be taken when a spurious HbA<sub>1c</sub> result is present?



**Clinical Case Study 24.7**

A 40-year-old male was brought to the emergency room complaining of dizziness and weakness. History revealed that he had skipped breakfast. Random blood sugar value was 40 mg%. What is the probable diagnosis?

**Clinical Case Study 24.8**

A 40-year-old man presented with complaints of frequent episodes of dizziness and numbness in legs. On examination, he is obese, leads a sedentary lifestyle, has a BP of 200/120 mm Hg, has fasting hyperglycemia, hyperinsulinemia, dyslipidemia and glucose intolerance. What is the diagnosis? What is the pathogenesis involved?

**Clinical Case Study 24.9**

A 30-year old woman during her second pregnancy had a glucose tolerance test and the results are:

Fasting glucose level: 125 mg/dL

1 hr glucose level: 210 mg/dL

2 hr value: 170 mg/dL.

- Plot a GTT graph with these results.
- Comment on the GTT results.
- What will be the result of Benedict's test with the urine sample collected along with each blood sample?
- How will you follow up the patient?
- What is the importance of assessing the glucose tolerance in a pregnant lady?
- How do you rule out lactosuria in this case?

**Clinical Case Study 24.10**

An apparently healthy man, on a routine checkup, was found to have fasting blood sugar of 80 mg/dL, and urine showed no abnormal constituents. After a heavy breakfast of one-and-half hours, his blood sugar was 140 mg/dL and urine sample at that time was positive for Benedict's test.

- What is the diagnosis?
- How do you further investigate?
- What is the line of treatment?
- What is the course of this disease?

**Clinical Case Study 24.1 Answer**

Likely diagnosis is uncontrolled diabetes mellitus. Often, diabetes is noticed by a routine urine examination. Fasting

and postprandial blood sugar should be estimated on this patient (See chapter 24 for further details).

**Clinical Case Study 24.2 Answer**

Diabetic ketoacidosis (DKA).

**Clinical Case Study 24.3 Answer**

Starvation ketosis.

**Clinical Case Study 24.4 Answer**

Diabetic ketoacidosis (DKA).

**Clinical Case Study 24.5 Answer**

Diabetic nephropathy.

**Clinical Case Study 24.6 Answer**

In an effort to determine if the unusual HbA1c result was due to potential hemoglobinopathies, Hb variant analysis was done and presence of HbS and HbF identified. In this particular case, increased HbF caused the abnormal HbA1c value. HbA1c assays can be divided into methods that use molecular charge (HPLC and electrophoresis) and methods that use molecular structure (immunoassays). Hb variants (or their glycosylated forms) may interfere with HbA1c assays based on HPLC and electrophoresis by coeluting/comigrating with Hb A and/or HbA1c. When a spurious HbA1c result is obtained, the possibility of interference by Hb variants should be considered. Fructosamine and daily testing of glucose may be used to monitor glycemic control. These alternative tests may also be used for patients who have an altered erythrocyte lifespan and changes in the degree of glycation. HbA1c testing cannot be used for these individuals.

**Clinical Case Study 24.7 Answer**

Patient has hypoglycemia, probably due to fasting. Under physiological conditions, brain derives fuel from glucose. Hypoglycemia is considered when blood glucose falls to below 60 mg%. Symptoms begin at this concentration of glucose; brain symptoms appear when glucose level falls below 50 mg%. CNS symptoms include behavioral changes, confusion, fatigue, seizures, loss of consciousness, and if severe and prolonged, death.



Spontaneous hypoglycemia may be (1) fasting, and (2) postprandial. Fasting hypoglycemia may be subacute or chronic and usually presents with neuroglycopenia. Postprandial hypoglycemia is usually acute and symptoms of neurogenic autonomic discharge like sweating, palpitations, anxiety and tremulousness are seen.

There are many causes for hypoglycemia. Fasting hypoglycemia may be due to drugs (e.g. insulin), critical illness (hepatic, renal and cardiac, sepsis), endocrine problems, insulinoma, endogenous hyperinsulinism, other  $\beta$  cell disorders, autoimmune disorders and certain inborn errors of metabolism. Post-prandial hypoglycemia may be due to alimentary (post-gastrectomy), galactosemia, hereditary fructose intolerance and idiopathic.

Treatment of hypoglycemia is oral glucose or IV glucose.

### Clinical Case Study 24.8 Answer

The patient has “insulin resistance syndrome” or metabolic syndrome. Metabolic syndrome is multi-factorial in origin; there are 6 major factors involved, abdominal obesity, atherogenic dyslipidemia, hypertension, insulin resistance (with or without the presence of glucose intolerance), proinflammatory state and prothrombotic state.

The defect may be due to: (1) Prereceptor pathology—mutations in insulin molecule, anti-insulin antibodies, (2) receptor defects—decreased number of receptors, reduced insulin binding, insulin receptor mutations, insulin receptor blocking antibodies, (3) postreceptor defects—defective signal transduction, mutations in GLUT4, (4) combination of defects, (5) other pathologies—Werner syndrome, ataxia telangiectasia, lipodystrophic states, etc. (6) increased production of insulin antagonists, and (7) glucose intolerance.

Other laboratory tests helpful are apoB, hs-CRP, fibrinogen, uric acid, urine microalbumin and liver function tests. Treatment includes treating insulin resistance, lipid abnormalities, prothrombotic state, hypertension, impaired fasting glucose and lifestyle modifications. Diet and exercise are the keystones to the clinical management.

### Clinical Case Study 24.9 Answer

Gestational diabetes mellitus (see Chapter 24).

### Clinical Case Study 24.10 Answer

Renal glycosuria. Normal renal threshold for glucose is 180 mg/dL, (see Chapter 24).

## QUICK LOOK OF CHAPTER 24

1. Major factors that cause entry of glucose into blood are; absorption from intestines, glycogenolysis and gluconeogenesis.
2. Major factors that cause depletion of glucose in blood are; utilization by tissues, glycogenesis and conversion to fat.
3. Hyperglycemic hormones are Glucagon, Cortisol, Adrenaline and Growth hormone. Insulin is a hypoglycemic hormone.
4. Indications for an oral glucose tolerance test (OGTT) are; patient with symptoms suggestive of diabetes mellitus, excess weight gain during pregnancy and to rule out benign glycosuria.
5. Contraindications for an OGTT are; known case of diabetes mellitus, to follow prognosis of diabetes mellitus and performing on acutely ill patients.
6. Conditions that can be assessed by OGTT are impaired glucose tolerance, impaired fasting glycemia, gestational diabetes, alimentary glucosuria and renal glucosuria.
7. Reducing substances in urine other than glucose are fructose, lactose, galactose, pentoses, homogentisic acid, salicylates, glucuronides and ascorbic acid.
8. Insulin has the following biochemical effects: increases uptake of glucose by cells, enhances utilization of glucose, hypoglycemic, antilipolytic, antiketogenic and favors lipogenesis.
9. Insulin acts via a specific insulin receptor present on cells of insulin responsive tissues. This affects a signal transduction pathway, which leads to regulation of gene transcription, DNA synthesis and activation of enzymes.
10. Diabetes mellitus is of two types. Type 1 and Type 2. Type 1 is also known as insulin dependent (IDDM), while the type 2 was previously known as non-insulin dependent diabetes mellitus (NIDDM)
11. Secondary diabetes mellitus can be; manifested in endocrine disorders (Cushing's syndrome, Thyrotoxicosis), drug induced (beta blockers, steroids), seen in pancreatic diseases (chronic pancreatitis).
12. Diabetic ketoacidosis (DKA), lactic acidosis and hypoglycemia are acute metabolic complications of diabetes mellitus.
13. Retinopathy, neuropathy and vascular diseases are chronic complications of diabetes mellitus.
14. Glycated hemoglobin (HbA1c) is used as an index for long-term control of blood glucose level.

# CHAPTER 25

## Hyperlipidemias and Cardiovascular Diseases

### Chapter at a Glance

The reader will be able to answer questions on the following topics:

- Hyperlipidemias
- Atherosclerosis and coronary artery disease
- Risk factors for coronary artery disease
- Preventions of atherosclerosis
- Hypolipoproteinemias

### Clinical Significance of Cholesterol

Students should be familiar with cholesterol and lipoproteins described in detail in Chapter 12. A summary of lipoproteins is given in Table 25.1 and their metabolic relationships are shown in Figure 25.1. LDL is said to be “bad” cholesterol and HDL is “good” cholesterol (Fig. 25.2). The level of cholesterol in blood is related to the

development of atherosclerosis. Abnormality of cholesterol metabolism may lead to cardiovascular accidents and heart attacks.

### ATHEROSCLEROSIS

Greek word, sclerosis means hardening. Coronary artery obstruction and myocardial infarction are the number one

**TABLE 25.1:** Characteristics of different classes of lipoproteins

	<i>Chylomicron</i>	<i>VLDL</i>	<i>LDL</i>	<i>HDL</i>
Density g/L	<0.95	0.95–1.006	1.019–1.063	1.063–1.121
Diameter (nm)	500	70	25	15
Electrophoretic mobility %composition	origin	pre-beta	beta	alpha
Protein	2	10	22	30–60
TAG	83	50	10	8
Cholesterol	8	22	46	10–30
Apoproteins	A, B-48, C-II, E	B-100, C-II, E	B-100	A-I, C, E
Transport function	TAG from gut to muscle and adipose tissue	TAG from liver to muscle	Cholesterol liver to peripheral tissues	Cholesterol from peripheral tissues to liver



killers in the world. In India 20% deaths are due to coronary artery disease (CAD). It is estimated that by the year 2020, it will account for 33% of all deaths.

## Atherosclerosis and LDL

### Stage I: Formation of foam cells:

Increased levels of cholesterol for prolonged periods will favour deposits in the **subintimal region** of arteries. Aorta, coronary arteries and cerebral vessels are predominantly affected by the atherosclerotic process. The LDL cholesterol, especially **oxidized** LDL particles are deposited in the walls of arteries. Plasma LDL is mainly catabolized via apo-B-

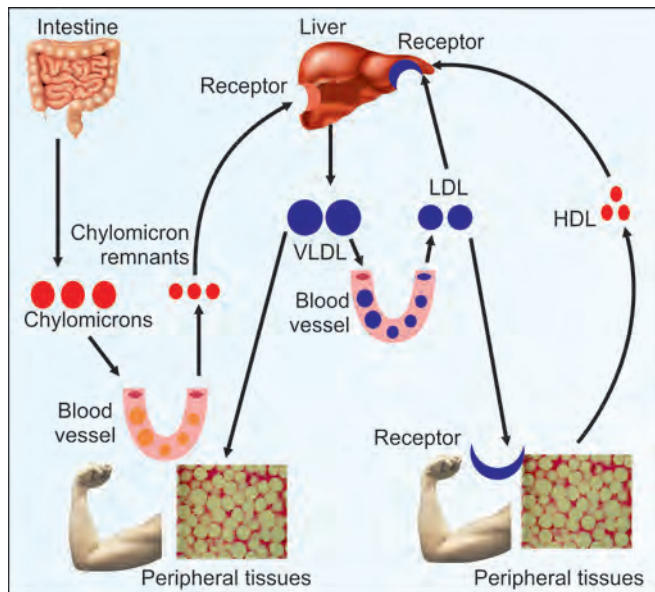


Fig. 25.1: Summary of lipoprotein metabolism

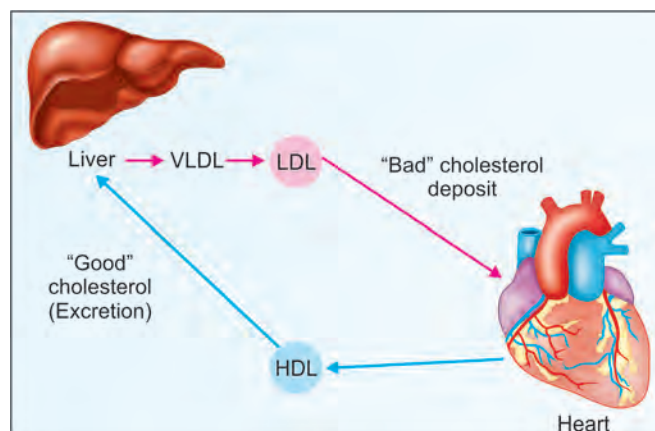


Fig. 25.2: Forward and reverse transport of cholesterol

LDL receptor pathway. But a small part of LDL particles are degraded by nonspecific uptake of macrophages. Free radical induced **oxidative damage** of LDL will accelerate this process. Later, the macrophages become overloaded with cholesterol, and these are then called **"foam cells"**. These form the hallmark of atherosclerotic plaques.

**Stage II: Progression of atherosclerosis:** Smooth muscle cells containing lipid droplets are seen in the lesion. During early stages of atherosclerosis, the condition is reversible if plasma lipid levels, especially LDL-cholesterol levels are lowered. But when lipid accumulates, the lesion progresses unchecked and the arterial changes become irreversible.

**Stage III: Fibrous proliferation:** Due to liberation of various **growth factors** by macrophages and platelets. Lipoproteins, glycosaminoglycans and collagen are accumulated. Thus there is a definite component of inflammation in atherosclerosis. This chronic infection leads to increased plasma high sensitive **C-reactive protein** (hs-CRP) (see Chapter 28)

**Stage IV: Advancing fibrous plaque:** This leads to narrowing of vessel wall when proliferative changes occur (Fig. 25.3). The blood flow through the narrow lumen is more turbulent and there is tendency for clot formation.

### Myocardial Infarction (MI)

Finally, a clot is formed which occludes one of the major vessels. **Thrombosis** in coronary artery leads to ischemia of the tissue supplied, due to hindrance to oxygen supply (Fig. 25.3). Finally **infarction** (death of tissue) occurs (Fig. 25.4). Along with this ischemia (decreased blood supply), instead of the normal aerobic conditions, anaerobic glycolysis takes preponderance. This leads to decreased ATP, increased NADH, accumulation of lactic acid and decreased pH in cardiac muscle cells. Net result is inefficient contraction of heart muscle, and if allowed to progress further, death of the muscle cells in the affected region.

Usually the diagnosis can be made from the clinical history, the electrocardiogram and cardiac markers (troponin T, CK-MB, etc, described in Chapter 23). Size of the infarct may be reduced by immediate administration of **Tissue plasminogen activator** (t-PA).

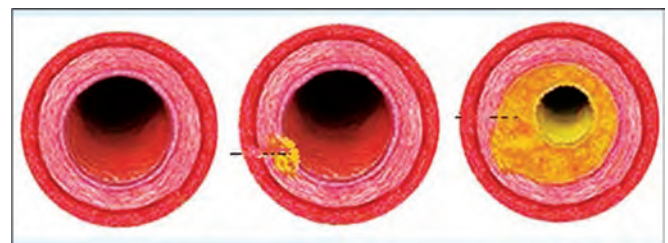
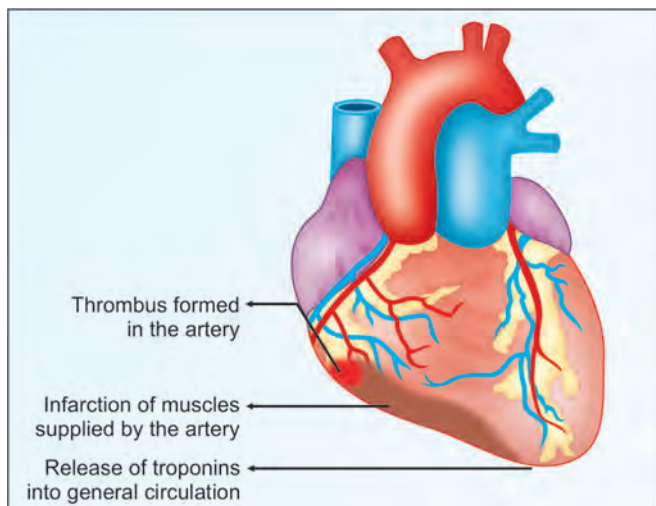


Fig. 25.3: Left, cut section of normal artery; middle, early plaque formation; right, advanced plaque formation





**Fig. 25.4:** Thrombosis in the artery leads to infarction of the area supplied by the artery

Oxidative modifications of sterols and fatty acids are involved in signaling pathways. These groups of molecules are known to regulate the activity of a special group of ligand-activated transcription factors, known as nuclear receptors. **Oxysterols** activate liver X receptor (LXR), while **oxidized fatty acids** regulate peroxisome proliferator-activated receptors (PPARs). These nuclear hormone receptors control the expression of their target genes upon ligand binding. The role of the receptors and natural or synthetic activators have been studied extensively in the initiation, development and progression of atherosclerosis. Both the receptors themselves and their activators have been shown to exert anti-atherogenic effects.

## PLASMA LIPID PROFILE

The sample of serum should be taken after 12–14 hours of **fasting**. In laboratories, **lipid profile** is assessed by estimating the following fractions in plasma.

1. Total cholesterol
2. HDL-cholesterol
3. LDL-cholesterol
4. Triglycerides

In special cases, the following apoproteins are also estimated.

5. Apo-B level
6. Apo-A-I level
7. Lp(a) level

Abnormal levels of serum cholesterol are seen in certain conditions; these are listed in Box 25.1. Box 25.2 gives the indications for checking the lipid profile.

## RISK FACTORS FOR ATHEROSCLEROSIS

See Box 25.3. A total cholesterol level below 200 mg/dL; the LDL cholesterol (direct) below 100 mg/dL and a non-

### Box 25.1: Clinical conditions in which serum cholesterol level is increased

1. *Diabetes mellitus*: Acetyl CoA pool is increased and more molecules are channeled to cholesterol.
2. *Obstructive jaundice*: The excretion of cholesterol through bile is blocked.
3. *Hypothyroidism*: The receptors for HDL on liver cells are decreased, and so excretion is not effective.
4. *Nephrotic syndrome*: Albumin is lost through urine, globulins (including lipoproteins) are increased as a compensatory mechanism.
5. *Familial hyperlipoproteinemias*: See Frederickson's classification (Table 25.4)

### Box 25.2: When should check lipid profile?

1. Suspected cardiovascular disease, coronary artery disease and peripheral vascular disease
2. All patients with diabetes mellitus, at least once in 6 months.
3. Thyroid, liver and renal diseases, where lipid metabolism may be altered.
4. All persons above 40, should be checked once in a year.

### Box 25.3: Risk factors for cardiovascular disease

#### Class 1: Modifiable risk factors; Interventions have been proved to lower CAD risk

1. Cigarette smoking
2. High total cholesterol
3. High LDL cholesterol
4. Low HDL cholesterol
5. High fat/cholesterol diet
6. Left ventricular hypertrophy (LVH)
7. Thrombogenic factors

#### Class 2: Modifiable risk factors; Interventions are likely to lower CAD risk

8. Lipoprotein (a) or Lp(a)
9. Diabetes mellitus
10. Hypertension
11. Physical inactivity
12. Obesity
13. High triglycerides
14. High homocysteine
15. Increased high-sensitivity-CRP (hs-CRP)
16. Stress

#### Class 3: Non-modifiable risk factors

17. Age
18. Male gender
19. Family history of CAD

HDL cholesterol below 130 mg/dL predicts no risk. The values are different in the presence of other risk factors like obesity, diabetes mellitus, hypertension, smoking, etc. The atheroprotective HDL-cholesterol should be more than 40

mg/dL in males and >50 mg/dL in females. Markers may be those for assessing acute cardiac injury or those used to identify long-term risks (Box 25.4)

## Serum Cholesterol Level

- i. In 1970s, data from the Framingham epidemiological study demonstrated that increase in serum cholesterol level is associated with and increased risk of death from CHD. For every 10% lowering of cholesterol, CHD mortality was reduced by 13%. Reduction of cholesterol may not only decrease the lipid content of the plaque, but can also reduce the accumulation of monocytes and macrophages.
- ii. In healthy persons, cholesterol level varies from 150 to 200 mg/dL (Table 25.2). If other risk factors are present, cholesterol level should be kept preferably **below 180 mg/dL**. Values around 220 mg/dL will have moderate risk and values above 240 mg/dL will need active treatment.
- iii. Females have a lower level of cholesterol which affords protection against atherosclerosis.

### Box 25.4: Cardiac markers

- A. Risk markers of cardiac disease (prediction) (see Chapter 25)
  1. Total cholesterol level in serum
  2. LDL cholesterol and Apo B100 level
  3. HDL cholesterol and Apo A1 level
  4. Plasma hsCRP
  5. Lp(a) level
  6. Serum triglycerides
  7. Blood HbA1c
  8. Serum homocysteine level
- B. Cardiac markers of acute coronary syndrome (see Chapter 23)
  1. Creatinine kinase (CK-MB)
  2. Cardiac troponins (cTnT and cTnI)
  3. High sensitivity troponin
  4. BNP and NTproBNP

**TABLE 25.2: CHD risk and lipid parameters**

	<i>Low risk (desirable level)</i>	<i>Borderline risk</i>	<i>High risk</i>
Total cholesterol (mg/dL)	<200	200–240	>240
LDL cholesterol (mg/dL)	<130	130–160	>160
HDL cholesterol (mg/dL)	>60	35–60	<35
Triglyceride (mg/dL)	<200	200–400	>400

- iv. Plasma cholesterol levels would tend to slowly rise after the 4th decade of life in men and postmenopausal women.

## LDL-Cholesterol Level

In 1988, the National Cholesterol Education Program (NCEP) identified elevated LDL-C as a primary risk factor for CHD. Blood levels **under 130 mg/dL** are desirable (Table 25.2). Levels between 130 and 159 are borderline; while above 160 mg/dL carry definite risk. Hence LDL is “**bad**” cholesterol (Fig. 25.2). Oxidized LDL initiates fatty streaks, which is the starting point of atheroma formation. Plaque instability and rupture are also associated with oxidised LDL. Plasma concentrations of small dense LDL (sd-LDL) are associated with the prevalence of cardiovascular events. Recently, simple homogeneous assay for sd-LDL-cholesterol has been developed.

## HDL-Cholesterol Level

The HDL level **above 60 mg/dL** protects against heart disease. (Table 25.2). Hence, HDL is “**good**” cholesterol. A level below 40 mg/dL increases the risk of CAD. For every 1 mg/dL drop in HDL, the risk of heart disease rises 3%. If the ratio of total cholesterol/HDL is more than 3.5, it is dangerous. Similarly, LDL:HDL ratio more than 2.5 is also detrimental. In some cases, even though patient may have high HDL, but may have dysfunctional HDL. Thus low lecithin-cholesterol acyl transferase activity is a strong positive risk marker for ischemic heart disease, independent of HDL-cholesterol. Hence, importance is for HDL activity and not for HDL concentration.

## Apoprotein Levels and Ratios

Apo A-I is a measure of HDL-cholesterol (good) and apo B measures LDL-cholesterol (bad). Ratio of **Apo B : A-I** is the most reliable index. The ratio of 0.4 is very good; the ratio 1.4 has the highest risk of cardiovascular accidents.

## Lp(a)

Lp(a) inhibits fibrinolysis. Levels more than 30 mg/dL increase the risk 3 times; and when increased Lp(a) is associated with increased LDL, the risk is increased 6 times. (See Lp(a) in Chapter 12). Nicotinic acid will reduce serum Lp(a) level.

## Non-HDL Cholesterol

A value of more than 160 mg/dL carries high risk (Box 25.5).

## High Sensitivity C Reactive Protein (hsCRP)

It is also called ultra sensitive CRP. It measures low levels of CRP using nephelometry or immunoturbidimetry technique. Since the method has high sensitivity, even small quantity (1–10 ng/dL) could be measured. It is a marker for risk for atherosclerosis and is used as a predictor for future myocardial infarction within the next 12 months. Because half of heart attacks and strokes happen in patients who do not have high levels of cholesterol in their blood, measurement of hs-CRP may help to identify patients who are at risk and may need medical treatment. The hs-CRP test clearly adds to the predictive value.

Less than 1 mg/L (0.1 mg/dL) is considered as low risk and single measurement is sufficient. Levels between 1–3 mg/L are border line, indicating some risk, and will need assessment of serial samples at 1 week intervals. Levels more than 3 mg/L is having high risk for future MI, and will need active medical intervention. If the hsCRP value is more than 10 mg/L, it indicates significant acute phase reaction, and is not indicative of any cardiac pathology. Thus, hsCRP is tested only when other inflammatory conditions are ruled out. Atherosclerosis has an inflammatory component, which causes production of CRP in small quantities. This CRP binds selectively to LDL, activates complement, resulting in plaque formation. CRP inhibits eNOS (Nitric oxide synthase), which causes endothelial dysfunction. Statin therapy is found to reduce hsCRP level as well as the incidence of MI.

CRP (C-reactive protein) is synthesized by liver in response to cytokine production (IL-6, IL-1) during tissue injury, inflammations, acute infections, collagen disorders and malignancy. Such inflammatory reactions will increase the CRP level up to 1,000 times of the original (50 or more mg/L). Standard CRP test is useful clinically to follow up of patients with such inflammatory diseases. hsCRP is also increased in metabolic syndrome, and has prognostic significance.

### Box 25.5: Non-HDL Cholesterol and evaluation of cardiovascular risk

Non HDL cholesterol or Atherogenic cholesterol = (LDL+ VLDL+ IDL+ Lpa). As per NCEP guidelines, the value of non-HDLC is important for the risk evaluation.

<130	(100–130) mg/dL	= Very little risk
<160	(130–160) mg/dL	= Border line high
<190	(160–190) mg/dL	= High risk
>190	mg/dl	= Very high risk

Another way of expressing the risk is as follows:

	LDL-C	Non HDL-C
Risk grade 1	<160mg/dL	<190mg/dL
Risk grade 2	<130	<160
Risk grade 3	< 100	<130

CRP directly participates in the atherothrombotic process capable of augmenting the innate inflammatory response, triggering expression of adhesion molecules, attenuating expression of endothelial NO synthase, inducing plasminogen activator inhibitor-1, and having a direct effect on arterial thrombosis. The free radicals oxidize PUFA present in LDL; this generates reactive fragments like 4-hydroxynonenal that forms adducts with lysine  $\alpha$ -amino groups of Apo-B, leading to formation of Modified LDL. This modified LDL is not recognized by liver, but is taken up by Macrophage Scavenger Receptors present on macrophages resulting in formation of foam cells, thus initiating the process of atherosclerosis.

## Serum Triglyceride

Normal level is 50–150 mg/dL. Blood level **more than 150 mg/dL** is injurious to health.

## Homocysteine Level

Plasma homocysteine above 15 m/L will increase the risk of coronary artery disease and stroke at a **younger age**. Administration of pyridoxine, vitamin B<sub>12</sub> and folic acid may lower the homocysteine level, but may not have any substantial benefit on clinical outcome.

## Diabetes Mellitus

Cardiovascular disease is responsible for 80% of total diabetic mortality. Diabetes is associated with an increase in small LDL particles, high TAG and low HDL levels. In the absence of insulin, hormone sensitive lipase is activated, more free fatty acids are formed, which are catabolized to produce acetyl CoA. These cannot be readily utilized, as the availability of oxaloacetate is reduced and citric acid cycle is sluggish. So acetyl CoA pool is increased, and it is channelled to cholesterol synthesis.

In diabetes, the atherogenicity of LDL is increased while atheroprotective effect of HDL is decreased. In diabetes mellitus, the TAG pool in the cell is high and the LDL particles formed from VLDL are of the small dense varieties, that are highly atherogenic. The glycation and oxidation of LDL will delay their catabolism and promote the uptake by macrophages, which is a dysregulated process. At the same time, the level of HDL in diabetic patients and those with metabolic syndrome is low. Glycation of Apo-A1 decreases its ability to stimulate LCAT, and thereby the esterification and efflux of cholesterol from the cells. The antioxidant effect (Paroxonase activity) of HDL is also decreased. The alterations in the level and properties of LDL and HDL together contribute to the increased risk for CAD in diabetes mellitus.

## Cigarette

Cigarette smoking is the most important modifiable risk factor for CAD (Box 25.3). Risk from smoking is dose dependant; depends on the age at which the person started smoking and the number of cigarettes smoked per day. Smoking enhances oxidation of LDL, reduces HDL, increases CRP and augments aggregation and adhesion of platelets. Nicotine of cigarette will cause lipolysis and thereby increase acetyl CoA and cholesterol synthesis. Nicotine also causes transient constriction of coronary and carotid arteries.

## Hypertension

Systolic blood pressure more than 160 further increases the risk of CAD. An increase in 10 mm of BP will reduce life expectancy by 10 years. Increase of 5 mm Hg of diastolic pressure is associated with 34% increase in stroke risk.

## Obesity and Sedentary Lifestyle

The classical description of Pickwick (in Pickwick papers) by Charles Dickens reminds of a person with high risk for CAD. People with “apple type” of obesity with a “Ganapathy” belly (truncal obesity) are more prone to get myocardial infarction. A person is obese when BMI exceeds 27.8 kg/m<sup>2</sup> in men and 27.3 kg/m<sup>2</sup> in women. Obesity is associated with substantially increased cardiovascular risk. Obesity causes glucose intolerance, insulin resistance, hypertension and dyslipidemia.

Adipose tissue releases a large number of bioactive mediators that influence insulin resistance, alterations in lipids, blood pressure, coagulation, fibrinolysis and inflammation, leading to endothelial dysfunction and atherosclerosis. A summary of adipose tissue function is given in Chapter 40.

## Other Factors

**Long chain saturated fatty acids** (e.g. stearic acid) induces pro-inflammatory responses and significantly impacts growth and viability of endothelial cells. They have harmful effects on the vascular system. Medium chain saturated fatty acids (C6:0 – C12:0) do not significantly affect endothelial cell growth.

## PREVENTION OF ATHEROSCLEROSIS

Almost 90% of CAD is predictable, preventable and curable. Lifestyle changes are require, which include regular

exercise, balanced diet, cessation of smoking, maintaining proper weight, control of hypertension, diabetes and dyslipidemia. The aim is to reduce total cholesterol below 180 mg/dL; to decrease LDL-cholesterol below 130 mg/dl and to keep HDL-cholesterol above 35 mg/dL (Box 25.6).

## Reduce Dietary Cholesterol

Cholesterol in the diet should be kept less than 200 mg per day. Eggs and meat contain high cholesterol. One egg yolk contains about 500 mg of cholesterol (Fig. 25.5A). One double omelet increases the blood cholesterol, 15 mg more than the original level.

## Vegetable Oils and PUFA

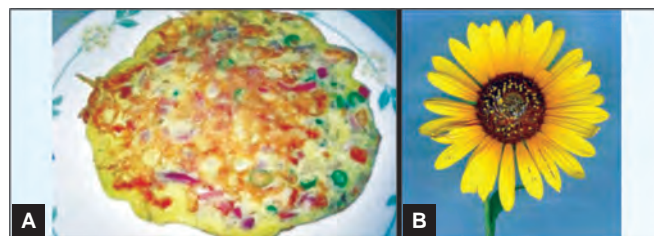
Vegetable oils (e.g. sunflower oil) and fish oils contain polyunsaturated fatty acids (PUFA). They are required for the esterification and final excretion of cholesterol. So PUFA is helpful to reduce cholesterol level in blood (Fig. 25.5B). **Omega-3 fatty acids** from fish oils reduce LDL and decrease the risk of CAD. Recommended intake of omega-3 fatty acid (fish oils) is 1 g/day (EPA and DHA combined).

## Moderation in Fat Intake

The accepted standard is that about 20% of total calories may be obtained from fat, out of which about one-third from saturated, another one-third from monounsaturated and the rest one-third from polyunsaturated fatty acids. The recommended daily allowance will be about **20–25 g of oils** and about 2–3 g of PUFA per day for a normal adult.

### Box 25.6: Treatment policy in high risk patients; Targets to be achieved

1. Reduce total cholesterol below 180 mg/dL
2. Decrease LDL-cholesterol below 130 mg/dL; In persons with documented CHD, the goal of therapy is to reduce LDL to below 100 mg/dL. In general, lowering of LDL cholesterol by 1 mg/dl (1 mmol/L) reduces the risk of cardiovascular disease by 25%
3. Keep HDL-cholesterol above 40 mg/dl.



**Figs 25.5A and B:** (A) Reduce dietary cholesterol by avoiding egg omelet; (B) Sunflower oil and other vegetable oils contain PUFA



## Green Leafy Vegetables

Due to their **high fiber content**, leafy vegetables will increase the motility of bowels and reduce reabsorption of bile salts (Fig. 25.6). Vegetables also contain plant sterols (**sitosterol**) which decrease the absorption of cholesterol. About 400 g/day of fruit and vegetables are desired.

## Avoid Sucrose and Cigarette

Cigarette smoking (Fig. 25.7) is the most important modifiable risk factor for CAD (Box 25.3). Sucrose will raise plasma triglycerides. High carbohydrate diet, especially sucrose, should be avoided by patients with hypercholesterolemia.

## Exercise

Regular moderate exercise (30 min per day) will lower LDL (bad cholesterol) and raise HDL (good cholesterol) levels in blood (Box 25.6). It will also reduce obesity. Individuals spending more than 2000 kcal/week in exercise are at a lower risk. Individuals who walked less than 1.5 km per day had a 2.6 times greater risk for CHD death, and 2.4 times greater risk for cancer.

## Hypolipidemic Drugs

- i. **HMGCoA reductase inhibitors** (“statins”): Atarvostatin and Simvastatin are popular drugs in this group. They are effective in reducing the cholesterol level and decreasing the incidence of CAD (Boxes 25.7 and 25.8).
- ii. **Bile acid binding resins** (Cholestyramine and Cholestipol) decrease the reabsorption of bile acids (Box 25.8).
- iii. **Probucol** increases LDL catabolism and prevents accumulation of LDL in arterial walls. So more cholesterol will be converted to bile acids, thus reducing the cholesterol level.



Fig. 25.6: Green leafy vegetables are very good to heart Fig. 25.7: Avoid cigarettes

- iv. **Nicotinic acid** inhibits lipolysis and so VLDL level is decreased. Nicotinic acid reduces plasma cholesterol and decreases serum Lp(a) levels. In addition, nicotinic acid administration strongly increases the circulating levels of HDLs.
- v. **Ezetimibe** is a drug which selectively inhibits absorption of cholesterol from mixed micelle (Box 25.8).
- vi. **Aspirin** is widely used to prevent thrombus formation, because of its anti-platelet activity (see Chapter 13).
- vii. Anti-oxidants such as **vitamin E** will minimize oxidation of LDL and so, atherosclerosis may be reduced.
- viii. Plant derived products having cholesterol-lowering action are enumerated in Box 25.9. The guggul (resins) from the Mukul myrrh tree (*Commiphora Mukul*) has cholesterol lowering action. The lipid component of this extract called guggulsterone (also called guggul lipid) is an antagonist of FXR. Guggulsterone

### Box 25.7: When to start statins?

1. All patients with established cardiovascular disease (secondary prevention).
2. Patients with diabetes mellitus, especially over 40 years of age.
3. Diabetes mellitus with other risk factors such as retinopathy, nephropathy, micro-albuminuria, hypertension.
4. Total cholesterol above 220 mg/dL or LDL more than 160 mg/dL or Total cholesterol : HDL ratio more than 6.
5. Family history of premature CVD.
6. Lifestyle alterations (exercise and diet) are not enough to reduce the cholesterol level.

### Box 25.8: Expected effect of drug therapy

	LDL	HDL	TG
Statins	-35%	+10%	–
Fibrates	-15%	+20%	–
Niacin	-20%	+25%	–
Cholestyramine	-20%	–	--
Ezetimibe	-20%	–	--

### Box 25.9: Plant derived products having cholesterol-lowering action

Plant derived fiber: Reduces serum cholesterol  
 Legumes: Reduces cholesterol even on high fat diet  
 Onion and garlic: Reduces serum cholesterol and TG  
 Embelia Ribes (Vidanga): Dried berries alone or along with amla has hypolipidemic effect  
 Commiphora Mukul (Guggulu): Hypolipidemic and cardioprotective  
 Cyperus Rotundus (Musta): Hypolipidemic; improves metabolic activity  
 Spices, flavinoids, red wine: Natural antioxidants prevent oxidative modification of LDL

has been shown to activate the pregnane X receptor (PXR), which is the receptor for lithocholic acid and other bile acid precursors. PXR activation leads to repression of bile acid.

- ix. **Fibrates (Gemfibrozil, Fenofibrate):** These compounds are derivatives of fibric acid. Fibrates result in the activation of PPAR- $\alpha$  (Peroxisome proliferator activated receptor) in liver and muscle. In the liver this leads to increased beta-oxidation of fatty acids, thereby decreasing the production of cholesterol-rich VLDLs, as well as increased clearance of chylomicron remnants, increased levels of HDLs and increased lipoprotein lipase activity which in turn promotes rapid VLDL turnover.

### Avoid Trans Fatty Acids (TFA)

Trans fatty acids (with double bonds having trans configuration) are formed during the partial hydrogenation of vegetable oils. They are widely used in food industry because of their long shelf-life. Trans fatty acids (TFA) are found to be more atherogenic than saturated fatty acids. TFA will alter membrane fluidity. TFA is also implicated in modulating metabolism. It alters secretion and composition of apo-B100 containing lipoproteins (LDL and VLDL). It increases catabolism of apo-A-I, decreases HDL and increases LDL levels. Hence Federal Drug Agency (FDA) in USA stipulates that TFA content of food items be given on the labels. Reducing the intake of TFA to 2–7 g/day is now strongly advised.

Clinical studies have suggested that DHA, (docosa hexenoic acid) and EPA, (eicosapentaenoic acid) lower triglycerides; slow the buildup of atherosclerotic plaques; as well as reduce the risk of heart attack and arrhythmias.

### Alcohol Reduces the Risk for Coronary Artery Diseases

In spite of the marginal beneficial effects claimed for moderate alcohol consumption, the deleterious effects on physical and mental health far outweigh them.

### PUFA, in Excess, may be Harmful

PUFA can definitely reduce cholesterol level. But there should be moderation. It is known that the diet should contain correct type and quantity; the optimum ratio of omega-6 to omega-3 fatty acids is 4:1. Very high intake of omega-6 oils will cause lowering of HDL, elevation of

plasma triglycerides, and will promote platelet aggregation. Vegetable oils (sunflower oil) containing PUFA are rich in omega-6 variety; while ghee and butter are low in omega-6. Omega-3 group is present in fish oils. Normal Indian diet consisting of cereals, pulses and vegetables provides “invisible oils”, which contains about 10 g of PUFA/day (out of which about 2 g is omega-3 and the rest 8 g is omega-6). Further intake of omega-6 oils is unnecessary and may be harmful.

The optimal **ratio for omega-6 to omega-3** in diet is 4:1. In an average Indian diet, this is about 30:1. In sunflower oil, this value is 160:1, and therefore, unnecessary addition of such vegetable oils will further deteriorate the condition. Coconut oil, although contains saturated fatty acids, the omega ratio is 3:1, and therefore superior to sunflower oil in this respect.

The general advice against the use of ghee and coconut oil needs re-evaluation. This mis-information arose, when long chain saturated fatty acids (LCSFA) were shown to increase cholesterol level. Since butter and coconut oil also contain saturated fatty acids, people equated them with LCSFA. Now it is known that ghee and coconut oil contain small chain (SCFA) and medium chain fatty acids. The drastic differences in metabolisms of LCFA and SCFA are given in Chapter 13. In summary, ghee and coconut oil, within normal limits, neither decrease nor increase cholesterol levels. But it is to be noted that consumption of ghee (any oil in general), increases the total fat intake as well as calorie intake. That is harmful. Again, moderation is the key.

In traditional Kerala cuisine, where coconut oil was the main cooking oil, only minimal amounts were used for seasoning at the end to ensure that the consumption of oils and fat were kept to a minimum.

## HYPOLIPOPROTEINEMIAS

### Abetalipoproteinemia

All apo-B containing lipoproteins are reduced since microsomal triglyceride transfer protein is defective. Hence TAG is not incorporated into VLDL and chylomicrons. (Table 25.3). Beta lipoprotein (LDL) is absent. Fat-soluble vitamins are not absorbed, causing mental and physical retardation. Serum levels of triglycerides, cholesterol and phospholipids are extremely low. Blindness may occur as a result of degenerative changes in retina. Erythrocytes have spiny projections (**acanthocytes**).

**TABLE 25.3:** Classification of hypolipoproteinemias

Disease	Lipoproteins	Cholesterol	Triacylglycerols	Clinical findings
Familial hypo beta lipoproteinemia	LDL decreased B-100 decreased	Decreased	Normal disease	Decreased risk of coronary artery
Abeta lipoproteinemia	VLDL↓; LDL↓↓ B-48↓; B-100↓↓	Markedly decreased	Decreased	Malabsorption; mental and physical retardation; acanthocytosis
Hypo alpha lipoproteinemia	HDL↓ A-I↓	Normal	Normal	Increased risk of coronary artery disease
Familial alpha Lp-deficiency	HDL↓↓ A-I↓↓	Normal	Normal	Increased risk of CAD

## Hypo-alpha-lipoproteinemia

This is inherited as an autosomal dominant trait. Serum HDL is decreased. There is increased risk for coronary artery diseases (Table 25.3).

## Tangier Disease

It was first described in patients from Tangier island in North-West Africa. It is a relatively benign, autosomal dominant condition. It is characterized by a defect in the efflux (flowing out) of cholesterol from cells, and reduction of HDL levels in the blood. The biochemical defect is the absence of “ATP-Binding Cassette Transporter-1” (ABCA-1), which is involved in transferring cellular cholesterol to HDL. So, plasma HDL is low and alpha band is most seen in electrophoresis. Cholesterol esters are accumulated in tissues. Manifestations are large orange yellow tonsils, muscle atrophy, recurrent peripheral neuropathies and atherosclerosis.

ABCA1 is involved in the transport of cholesterol out of cells when HDLs are bound to their cell surface receptor, SR-B1. One important consequence of the activity of ABCA1 in macrophages is that the efflux of cholesterol results in a suppression of inflammatory responses triggered by macrophages that have become foam cells due to cholesterol uptake. Defects in ABCA1 result in Tangier disease which is characterized by two clinical hallmarks; enlarged lipid-laden tonsils and low serum HDL.

ABCA1 is involved in the transport of cholesterol out of cells when HDLs are bound to their cell surface receptor, SR-B1. One important consequence of the activity of ABCA1 in macrophages is that the efflux of cholesterol results in a suppression of inflammatory responses triggered by macrophages that have become foam cells due to cholesterol uptake. Defects in ABCA1 result in Tangier disease which is

characterized by two clinical hallmarks; enlarged lipid-laden tonsils and low serum HDL.

## HYPERLIPIDEMIAS

The most widely accepted **Frederickson’s** classification is shown in Table 25.4. In all cases of hyperlipidemias, the elevated lipid fraction is either cholesterol or TAG or both.

The elevation of lipids in plasma leads to the deposition of cholesterol on the arterial walls, leading to **atherosclerosis**. (See under coronary artery diseases). The coronary and cerebral vessels are more commonly affected. Thromboembolic episodes in these vessels lead to **ischemic heart disease** and cerebrovascular accidents.

The deposition of lipids in subcutaneous tissue leads to **xanthomas**. The type of xanthoma depends on the nature of lipid deposited. **Eruptive xanthomata** are small yellow nodules associated with deposition of triglycerides. They disappear when the lipid level falls. **Tuberous xanthomata** are yellow plaques containing triglycerides and cholesterol, found mainly over the elbows and knees. **Xantheslasma** are lipid deposits under the periorbital skin and contain mainly cholesterol. **Tendinous xanthomata** are found over the tendons. Deposits of lipids in cornea lead to **corneal arcus**; indicating hyper cholesterolemia.

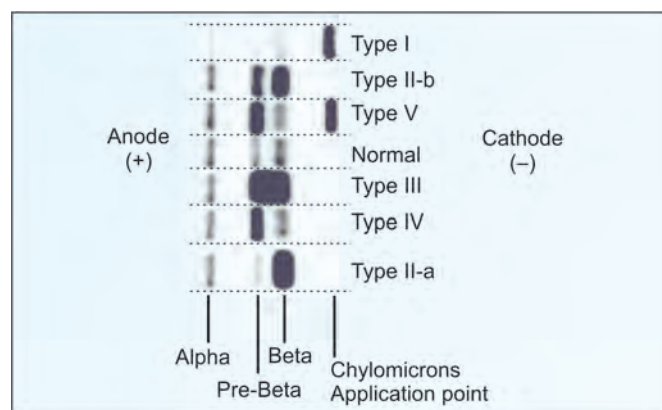
Hyperlipidemias, in the order of highest to lowest incidence are described below.

### Type II A (Primary Familial Hypercholesterolemia)

There is elevation of LDL. Patients seldom survive the second decade of life due to ischemic heart disease (Table 25.4 and Fig. 25.8). The cause is **LDL receptor** defect. Receptor deficiency in liver and peripheral tissues will result in the elevation of LDL levels in plasma, leading to

**TABLE 25.4:** Frederickson's classification of hyperlipoproteinemias (N = Normal; ↑ = Increased)

Type	Lipoprotein fraction elevated	Cholesterol level	TAG level	Appearance of plasma after 24 hr	Metabolic defect	Features	Management
Type I	Chylomicrons	N	↑↑	Creamy layer over clear plasma	Lipoprotein lipase deficiency	Eruptive xanthoma; hepatomegaly; Pain abdomen.	Restriction of fat intake. Supplementation with MCT
Type II A	LDL	↑↑	N	Clear	LDL Receptor defect; Apo B ↑	Atherosclerosis, coronary artery disease, Tuberos xanthoma	Low cholesterol diet. Decreased intake of saturated fat. Give PUFA and drugs like statins.
Type II B	LDL and VLDL	↑↑	↑	Slightly cloudy	Apo B ↑ Apo CII	Corneal arcus	Do
Type III	Broad beta-VLDL and Chylomicrons	↑↑	↑	Cloudy	Abnormal apo-E; Apo CII ↑	Palmar xanthoma. High incidence of vascular disease	Reduction of weight, restriction of fat and chol. Give PUFA and drugs
Type IV	VLDL	↑	↑↑	Cloudy or milky	Over production of VLDL; Apo CII ↑	Associated with diabetes, heart disease, obesity.	Reduction of body weight. Restrict carbo hydrate and cholesterol
Type V	VLDL Chylomicrons	N	↑↑	Creamy layer over milky plasma	Secondary to other causes	Chronic pancreatitis	High PUFA intake, hypocholesteremic drug

**Fig. 25.8:** Electrophoretic pattern of hyperlipidemias

hypercholesterolemia. The LDL receptor defect may be due to the following reasons.

1. **LDL receptor deficiency.**
2. **Defective binding** of B-100 to the receptor. A substitution of glutamine for arginine at 3500th amino acid results in poor binding to LDL receptors. This defect is known as B-3500 or **familial defective apo B**.
3. Receptor-LDL complex is not internalized.

Secondary type II hyperlipoproteinemia is seen in hypothyroidism, diabetes mellitus, nephrotic syndrome and cholestasis (Table 25.5).

### Type II B Hyperlipoproteinemia

There is elevation of both cholesterol and triglycerides with excessive production of apo-B. Therefore, LDL and VLDL are elevated. The abnormalities are manifested only by the third decade of life.

### Type IV (Familial Endogenous type)

This is due to over production of triglycerides by liver. The VLDL level in plasma is elevated. Cardiac manifestations are seen in the 4th decade of life. It may be associated with diabetes mellitus, obesity and impaired glucose tolerance.

### Type I

It is rare. It is due to lipoprotein lipase deficiency. It usually manifests in young age. A chylomicron band in fasting plasma is the characteristic finding. (See Table 13.6). Hepatomegaly, eruptive xanthoma and abdominal pain are seen. (Table 25.4 and Fig. 25.8).



**Type III**

It is very rare. It is due to increased levels of LDL and IDL. Beta lipoprotein floats on ultra centrifugation and a broad beta band is observed on electrophoresis. Palmar xanthomas and vascular disease are noticed.

**Type V**

Chylomicrons and VLDL are increased. Hypertriglyceridemia, usually secondary to other disorders like obesity, excessive alcohol intake, renal failure, pancreatitis, etc. are common (Table 25.5). Other causes of hyperlipoproteinemias include hepatic lipase defect, LCAT defect and Lp(a) excess and Wolman's disease (Table 25.6).

**Clinical Case Study 25.1**

A 48-year-old male presents to the clinic because of concerns about heart disease. He reports that his father died from a heart attack at age 46, and his older brother has also had a heart attack at age 46 but survived and is on medications for elevated cholesterol. The patient reports chest pain occasionally with ambulation around his house and is not able to climb stairs without significant chest pain and shortness of breath. The physical examination is normal, and the physician orders an electrocardiogram (ECG), exercise stress test, and blood work. The patient's cholesterol result comes back as 350 mg/dL (normal 200). The physician prescribes medication, which he states is directed at the rate limiting step of cholesterol biosynthesis.

**TABLE 25.5: Secondary hyperlipidemias**

	<i>Serum cholesterol</i>	<i>Serum triglyceride</i>
Diabetes	Increased	Increased
Nephrotic syndrome	Increased	Increased
Hypothyroidism	Increased	Increased
Biliary obstruction	Increased	Normal
Pregnancy	Normal	Increased
Alcoholism	Normal	Increased
Oral contraceptives	Normal	Increased

**TABLE 25.6: Minor causes for hyperlipoproteinemias**

<i>Defect</i>	<i>Effect</i>
Hepatic lipase <sup>-</sup>	VLDL, xanthoma, heart attack
LCAT deficiency	HDL is incapable of taking cholesterol to liver; cholesterol excretion is reduced
Lp(a) excess	Interferes with plasminogen activation; premature coronary heart diseases
Wolman's disease	Deficiency of cholesterol ester hydrolase in lysosomes; VLDL

What is the rate-limiting step of cholesterol metabolism?  
What is the class of medication prescribed?

**Clinical Case Study 25.2**

A 51-year-old male presents to the emergency center with chest pain. He states that he has had chest discomfort or pressure intermittently over the last year especially with increased activity. He describes the chest pain as a pressure behind his breastbone that spreads to the left side of his neck. Unlike previous episodes, he was lying down, watching television. The chest pain lasted approximately 15 minutes then subsided on its own. He also noticed that he was nauseated and sweating during the pain episode. He has no medical problems that he is aware of and has not been to a physician for several years. On examination, he is in no acute distress with normal vital signs. His lungs were clear to auscultation bilaterally, and his heart had a regular rate and rhythm with no murmurs. An electrocardiogram (ECG) revealed ST segment elevation and peaked T waves in leads II, III, and aVF. Serum troponin I and T levels are elevated. What is the most likely diagnosis? What biochemical shuttle may be active to produce more adenosine triphosphate (ATP) per glucose molecule?

**Clinical Case Study 25.3**

A 48-year-old male presented to OP with chest pain. Family history shows that his father died of a heart attack at the age of 46, and his elder brother also had a heart attack at the same age. The patient reports that he gets chest pain occasionally with ambulation and is not able to climb stairs without significant chest pain and shortness of breath. His plasma cholesterol level was 450 mg%. What is the possible diagnosis?

**Clinical Case Study 25.1 Answer**

**Diagnosis;** Hypercholesterolemia.

**Rate-limiting step:** The enzyme hydroxymethylglutaryl-CoA reductase (HMG-CoA reductase) catalyzes an early rate-limiting step in cholesterol biosynthesis.

**Likely medication:** HMG-CoA reductase inhibitor, otherwise known as "statin" medications.

**Clinical correlation:** Hyperlipidemia is one of the most treatable risk factors of atherosclerotic vascular disease. In particular, the level of the low-density lipoprotein (LDL) correlates with the pathogenesis of atherosclerosis. Exercise, dietary adjustments, and weight loss are the initial

therapy of hyperlipidemia. If these are not sufficient, then pharmacologic therapy is required. The exact LDL targets depend on the patient's risk of cardiovascular disease. For example, if an individual has had a cardiovascular event previously (heart attack or stroke), the LDL target is 100 mg/dL; 1 to 2 risk factors without prior events =130 mg/dL; and no risk factors =160 mg/dL.

### Clinical Case Study 25.2 Answer

**Likely diagnosis:** Acute myocardial infarction.

**Clinical correlation:** Patient's symptoms in this case are very typical of myocardial infarction, that is, chest pressure or chest pain, often radiating to the neck or to the left arm. The pain is usually described as deep and "squeezing chest pain." Cardiac muscle is perfused by coronary arteries with very little redundant or shared circulation; thus, occlusion of one coronary artery usually leads to ischemia or necrosis of the corresponding cardiac muscle. Laboratory confirmation of myocardial infarction (death of cardiac muscle) includes ECG showing elevation of the ST segment and/or increase of the cardiac enzymes. When there is insufficient oxygen available for the cardiac muscle, then the glycolytic pathway must be used, which leads to a very small amount of ATP per glucose molecule.

### Clinical Case Study 25.3 Answer

The patient might be suffering from familial hypercholesterolemia (FH). An LDL-C higher than 200 mg% in a patient less than 20 years is suggestive of heterozygous FH. It is an autosomal dominant condition where total cholesterol and LDL-C show severe elevation. Sometimes, it is also a moderate elevation. It carries a risk premature CAD and hence early detection and treatment are important. Exercise, dietary adjustments and weight loss are the initial steps, but if they fail drugs may be needed.

FH is due to a defect in LDL receptor. LDL receptor activity may be completely absent or up to 25% activity may

be present. There are 3 types; in the first type LDL receptor is absent, in the second type there is mutation in the terminal region so that binding is affected and in the third type, there is mutation in the C terminal region so that endocytosis is affected. Cholesterol synthesis continues even when plasma cholesterol is very high in these patients.

In children with FH, typically cholesterol levels may be above 600 mg%, and LDL-C may be 200 – 400 mg%. Foam cell formation, plaque cell formation and premature CAD are typical features. Cholesterol may accumulate in other areas, leading to xanthelasma and variety of xanthomas. Corneal arcus and valvular abnormalities are seen secondary to cholesterol deposition.

The condition may be homozygous (which is a rare condition, with an incidence of 1 in 1 million) or heterozygous (which is much more common, with an incidence of 1 in 500 persons). Men are more prone to develop CAD than women. Symptoms appear later in heterozygotes.

## QUICK LOOK OF CHAPTER 25

1. LDL carry cholesterol from the liver to the heart, while HDL carries cholesterol from the heart to the liver.
2. LDL is 'bad' cholesterol and HDL is 'good' cholesterol.
3. Higher concentration of Lipoprotein (a) or Lp(a) increases risk of a myocardial infarction.
4. Tangier's disease is caused by the deficiency of alpha lipoprotein. It is an example of hypolipoproteinemia.
5. Hypercholesterolemia is seen in diabetes mellitus, hypothyroidism and nephrotic syndrome.
6. Serum cholesterol above 200 mg %, cigarette smoking, hypertension, diabetes mellitus and high Lp(a) levels are risk factors for atherosclerosis.
7. Hypolipidemic drugs such as Clofibrate and Nicotinic acid lower serum cholesterol and are used in the treatment of hypercholesterolemia.
8. The ideal ratio of omega-6 to omega-3 in the diet is 4:1.

# CHAPTER 26

## Liver and Gastric Function Tests

### Chapter at a Glance

The reader will be able to answer questions on the following topics:

- Serum and urine bilirubin
- Tests based on synthetic function
- Enzymes indicating hepatocellular damage
- Gastric function and HCl secretion
- Gastric juice analysis

Biochemical tests are of immense value in diagnosis and monitoring of liver diseases. These tests are usually referred to as “liver function tests” (LFT). LFTs are the most widely performed biochemical tests in the laboratory. Important liver functions are listed in Table 26.1. Often abnormal liver function will lead to jaundice (Fig. 26.1).

A long list of tests was formerly included under this group and were classified based on the major functions of liver. (1) Excretion of bile pigments, bile salts, BSP (Bromsulphthalein) and ICG (Indocyanine green). (2) Metabolism of carbohydrates and amino acids. (3) Synthesis of serum proteins especially albumin and prothrombin. (4) Detoxification of ammonia and hippuric acid synthesis. (5) Serum enzymes, acting as markers of liver damage.

But nowadays, only clinically useful tests are being done. These liver function tests are broadly classified as

1. Tests to detect hepatic injury:
  - a. To detect the disease, whether mild or severe; whether acute or chronic.
  - b. To assess the nature of liver injury; hepatocellular or cholestasis.
2. Tests to assess hepatic function.

### Problems in Interpretation

- a. Normal LFT values need not indicate absence of liver disease, because liver has very large reserve capacity.

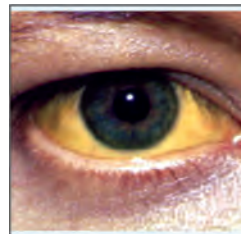
- b. Asymptomatic people may have abnormal LFT results. So interpretation should be based on clinical picture.

### FUNCTIONS OF LIVER

#### Synthetic Function

The plasma proteins albumin, alpha and beta globulins, clotting factors, carrier proteins, hormonal factors, growth factors, bile acids, cholesterol and phospholipids are the major biomolecules synthesized by the liver (Box 26.1).

Fluid distribution between intravascular and tissue spaces is controlled by oncotic pressure exerted by serum albumin (see Chapter 28).



Yellow color of sclera is seen in jaundice. Normal serum bilirubin value is 1 mg/dL. When it exceeds 2 mg/dL, bilirubin deposits in tissues.

Fig. 26.1: Jaundice

Carrier proteins/transport proteins are necessary for the transport and modulation of blood levels of functional form of trace elements like iron, copper, lipids and hormones (see Chapter 28).

Bile acids produced are used in the intestine to absorb lipid nutrients (fatty acids, fat-soluble vitamins) from the gut and also play a major role in the regulation of cholesterol in the blood.

Cholesterol forms the precursor of steroid hormones, bile acids and 7-dehydrocholesterol. Phospholipids form the backbone of membrane structure. Coagulation factors produced by the liver are essential for normal clotting mechanism.

### Carbohydrate Metabolism

Glucose may be metabolized through glycolysis, and then to citric acid cycle and oxidative phosphorylation to yield energy, if the cells are in need of ATP. If not, glucose can be stored as glycogen within the liver or it can be converted into more stable storage form as triglycerides. Homeostasis of blood glucose is described in Chapter 24.

### Amino Acid Metabolism

Proteins break down in the intestine and absorbed as amino acids which then reach liver by portal vein. There they may be utilized to form proteins of different kinds. Some of them are produced only in the liver, examples are albumin, alpha and beta globulins and coagulation factors I, II, V, VII, IX and X (see Box 26.1). Several proteins of acute phase reactants are produced in the liver, e.g. C-reactive protein (infectious diseases).

### Lipid Metabolism

Fatty acids will be catabolized to release acetyl CoA. It may be used in the TCA cycle and ETC to release energy or to act as a source of carbon for fatty acid and cholesterol synthesis in healthy individuals. A small portion of acetyl CoA is converted to ketone bodies (acetone, acetoacetic

acid and beta hydroxybutyric acid). Dietary lipids are repackaged and secreted into the systemic circulation as lipoproteins. The protein parts of the lipoproteins, apoproteins are synthesized by the liver only. Hence the liver has an important role in the distribution of lipids in the body. Lipoproteins are described in Chapter 12.

### Bilirubin Metabolism

The heme present in the hemoglobin and other proteins/enzymes (e.g. cytochromes) are eliminated only through liver (see Chapter 21). The lysis of red blood cells releases hemoglobin which splits to release globin and heme. The heme part is catabolized by microsomal heme oxygenase system of reticuloendothelial system to produce bilirubin. The bilirubin (unconjugated) thus formed is hydrophobic in nature hence it is transported in the blood by binding with albumin to reach the liver. In the liver, it is conjugated with glucuronic acid to form hydrophilic conjugated bilirubin and is excreted in bile into the intestine. Bacterial action (deconjugation and reduction) forms bilinogens (stercobilinogen, mesobilinogen and urobilinogen). About 20% of the urobilinogen is reabsorbed daily from the intestine to enter enterohepatic circulation to get re excreted into the intestinal lumen (enterohepatic circulation). A small fraction of urobilinogen enters the systemic circulation and gets filtered at the glomerulus and excreted in urine.

### Detoxification Functions

Liver plays a central role in detoxifying reactions.

**Exogenous substances:** Toxic substances entering from gut and parenteral route are mainly detoxified in the liver by different reactions like hydrolysis, hydroxylation, oxidation, carboxylation, reduction and demethylation. The detoxified products are more water soluble and thus easily excreted in urine. The cytochrome P450 enzyme system of hepatocyte is mainly concerned with drug metabolism; conversion of drugs into more soluble forms which in due course conjugate with compounds

#### Box 26.1: Major functions of liver

1. Synthetic function
  - a. Synthesis of plasma proteins (albumin, coagulation factors, many globulins)
  - b. Synthesis of cholesterol
  - c. Synthesis of triacyl glycerol
  - d. Lipoprotein synthesis
2. Metabolic function
  - a. Carbohydrates : Glycolysis; glycogen synthesis; glycogen breakdown; gluconeogenesis
  - b. Ketogenesis; fatty acid synthesis and breakdown
  - c. Protein catabolism
  - d. Citric acid cycle, production of ATP
3. Detoxification and excretion
  - a. Ammonia to urea
  - b. Bilirubin (bile pigment)
  - c. Cholesterol
  - d. Drug metabolites
4. Homeostasis: Blood glucose regulation
5. Storage function : Vitamin A, D, K, B<sub>12</sub>
6. Production of Bile salts; help in digestion

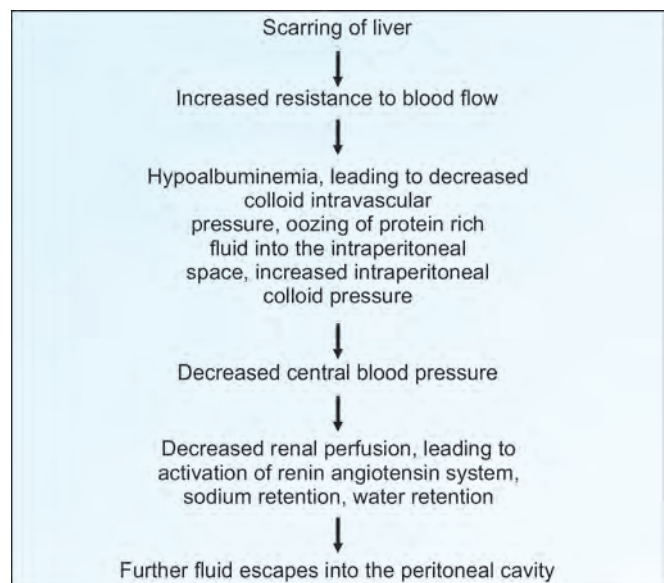


Fig. 26.2: Pathogenesis of ascites



like glycine, glucuronic acid and glutathione and finally excreted either in urine or through bile.

**Endogenous substances:** Disposal of bilirubin is already discussed. Ammonia produced from amino acid catabolism is detoxified by the liver to form less toxic urea. The key urea cycle enzymes are located entirely in liver.

### Excretory Functions

Substances detoxified by the liver are excreted through bile. About 3 liters of bile is produced daily and out of this 1 L is excreted and the rest is reabsorbed and circulated in the enterohepatic circulation. The bile contains bile salts, conjugated bilirubin, phospholipids and hormones. Major route of cholesterol excretion is through bile. The bile reaching the intestine facilitates the digestion and absorption of lipids and fat-soluble vitamins. Major functions of the liver are summarized in Box 26.1.

## CLINICAL MANIFESTATIONS OF LIVER DYSFUNCTION

### Jaundice

Jaundice is the yellowish discoloration of sclera, skin and mucous membrane. It is characteristic of liver disease but it will occur when rate of hemolysis is increased leading to elevation of serum bilirubin.

### Portal Hypertension

The entire venous drainage of gastrointestinal tract, the spleen, the pancreas and the gallbladder constitutes portal circulation with a pressure of 5 mm of Hg. Any obstruction in the course of portal circulation will cause portal hypertension. Causes:

- Presinusoidal—e.g. portal vein thrombosis
- Sinusoidal—cirrhosis
- Post sinusoidal—hepatic vein thrombosis

**Effects** of portal hypertension are:

- Due to increase in pressure, veins of portal system get dilated (varices). Liver becomes more dependent on arterial blood flow from hepatic artery.
- Portosystemic shunting leads to deterioration of the metabolic functions of the liver.

#### Box 26.2: Indications for liver function tests

- Jaundice
- Suspected liver metastasis
- Alcoholic liver disease
- Any undiagnosed chronic illness
- Annual checkup of diabetic patients
- Coagulation disorders
- Therapy with statins to check hepatotoxicity

- Hyperestrogenism is manifested as testicular atrophy, gynecomastia and palmar erythema.
- Failure of detoxification of ammonia by urea synthesis leads to hyperammonemia and hepatic encephalopathy.
- Decrease in albumin synthesis leads to hypoalbuminemia which predispose to oozing of fluid into the peritoneal cavity causing ascites.
- Diminished synthesis of clotting factors predisposes to bleeding.

**TABLE 26.1: Classification of liver function tests**

<b>A. Classification based on laboratory findings</b>	
Group I (tests of hepatic excretory function)	
i.	Serum—bilirubin; total, conjugated, and unconjugated
ii.	Urine—bile pigments, bile salts and urobilinogen
Group II: Liver enzyme panel (see Chapter 23) (These are markers of liver injury and/or cholestasis)	
i.	Alanine amino transferase (ALT)
ii.	Aspartate amino transferase (AST)
iii.	Alkaline phosphatase (ALP)
iv.	Gamma glutamyl transferase (GGT)
Group III: Plasma proteins (see Chapter 28) (Tests for synthetic function of liver)	
i.	Total proteins
ii.	Serum albumin, globulins, A/G ratio
iii.	Prothrombin time
Group IV: Special tests	
i.	Ceruloplasmin (see Chapters 28 and 39)
ii.	Ferritin (see Chapter 39)
iii.	Alpha-1-antitrypsin (AAT)
iv.	Alpha fetoprotein (AFP) (see Chapter 57)
<b>B. Classification based on clinical aspects</b>	
Group I: Markers of Liver Dysfunction	
i.	Serum bilirubin, total, conjugated
ii.	Urine: Bile pigments, bile salts and UBG
iii.	Total protein, serum albumin and A/G ratio
iv.	Prothrombin time
v.	Blood ammonia, when indicated
Group II: Markers of hepatocellular injury	
i.	Alanine amino transferase (ALT)
ii.	Aspartate amino transferase (AST)
Group III: Markers of cholestasis	
i.	Alkaline phosphatase
ii.	Gamma glutamyl transferase

- g. Loss of thrombolytic factors (e.g. antithrombin III) predisposes to hypercoagulability and venous thrombosis.

## Ascites

It is due to effusion of serous fluid into the abdominal cavity. It is a common presenting feature of cirrhosis. Most often it accompanies peripheral edema. Ascites may be due to causes not related to any pathology of liver. The biochemical parameter useful to differentiate ascites resulting from portal hypertension and other causes of ascites is the ratio of serum albumin: ascitic fluid albumin. If it is  $> 1.1$ , it is diagnostic of portal hypertension as the cause. Figure 26.2 explains the pathogenesis of ascites. Box 26.2 gives the indications of liver function tests. A detailed classification of the liver function tests (LFT) is shown in Table 26.1. Important liver function tests are described below:

## Markers of Hepatic Dysfunction

### Measurement of Bilirubin (Test of Excretory Function of Liver)

Bilirubin is the excretory product formed by the catabolism of heme. It is conjugated by the liver to form bilirubin diglucuronide and excreted through bile (see Chapter 21). Measurements of bilirubin as well as detection of bilirubin and urobilinogen in urine are important tests of liver function.

- i. Normal serum bilirubin level varies from **0.2 to 0.8 mg/dL**. The unconjugated bilirubin (bilirubin-albumin complex) (free bilirubin) (indirect bilirubin) varies from 0.2–0.7 mg/dL and conjugated bilirubin (direct bilirubin) 0.1–0.4 mg/dL. A rise in serum bilirubin above 1 mg/dL is abnormal (latent jaundice); but jaundice appears only if the level goes above 2 mg/dL.
- ii. The bilirubin is estimated by **van den Bergh reaction**, where diazotized sulfanilic acid (sulfanilic acid in HCl and sodium nitrite) reacts with bilirubin to form a

purple colored complex, azobilirubin. Normal serum gives a positive van den Bergh reaction.

- iii. When bilirubin is **conjugated**, the purple color is produced immediately on mixing with the reagent, the response is said to be van den Bergh **direct positive**.
- iv. When the bilirubin is **unconjugated**, the color is obtained only when alcohol is added, and this response is known as **indirect positive**.
- v. If both conjugated and unconjugated bilirubin are present in increased amounts, a purple color is produced immediately and the color is intensified on adding alcohol. Then the reaction is called **biphasic**.
- vi. In **Hemolytic** jaundice, unconjugated bilirubin is increased. Hence van den Bergh test is indirect positive. In **obstructive** jaundice, conjugated bilirubin is elevated, and van den Bergh test is direct positive. In **hepatocellular** jaundice, a biphasic reaction is observed, because both conjugated and unconjugated bilirubins are increased (see Chapter 21).

### Urinary Bilirubin

- i. In all cases of jaundice, urine should be examined for the presence of bile pigments (bilirubin), bile salts and urobilinogen.
- ii. Only conjugated bilirubin is soluble in water and is excreted in urine. Hence in prehepatic jaundice, when the unconjugated bilirubin is increased in blood, it does not appear in urine; hence called acholuric jaundice.
- iii. But in obstructive jaundice, conjugation of bilirubin is taking place, which cannot be excreted through the

**TABLE 26.2:** Urinary findings in jaundice

Type of jaundice	Bile pigment	Bile salt	Urobilinogen
Pre-hepatic (hemolytic)	Nil	Nil	++
Hepatocellular	++	+	Normal <sup>-</sup>
Post-hepatic (obstructive)	+++	++	Nil <sup>-</sup>

**TABLE 26.3:** Classification of jaundice

Type of bilirubin	Class of jaundice	Causes
Unconjugated	Prehepatic or hemolytic	Abnormal red cells; antibodies; drugs and toxins; thalassemia; hemoglobinopathies. Gilbert's syndrome; Crigler-Najjar syndrome
Unconjugated and conjugated	Hepatic or hepatocellular	Viral hepatitis; toxic hepatitis; intrahepatic cholestasis
Conjugated or obstructive	Post-hepatic	Extrahepatic cholestasis; gallstones; tumors of bile duct; carcinoma of pancreas; lymph node enlargement in porta hepatis

normal passage, and so it is regurgitated back into bloodstream; this is then excreted through urine. So in obstructive jaundice, urine contains bilirubin; hence in old literature, it is called choluric jaundice.

### Urinary Urobilinogen

- In cases of obstruction, bile is not reaching the intestine and so urobilinogen may be decreased or absent in urine.
- In hepatocellular jaundice, urobilinogen is initially elevated, then decreases or disappears when the obstructive stage sets in and reappears when obstruction is cleared.
- Urobilinogen is absent in urine, when there is obstruction to bile flow. The **first indication of recovery is the reappearance of urobilinogen in urine.**
- In hemolytic anemias, urobilinogen is increased.
- Bilirubin is detected by Fouchet's test and urobilinogen by Ehrlich's test. The findings in urine in different types of jaundice are shown in Table 26.2. Table 26.3 shows the classification and causes for jaundice. Table 26.4 gives the tests to distinguish different types of jaundice. Bilirubin synthesis, excretion and jaundice are described in detail in Chapter 21.

### Urine Bile Salts

Normally bile salts (sodium salts of taurocholic acid and glycocholic acid) are present in the bile; but are not seen in urine. Bile salts in urine are detected by **Hay's test**. Positive Hay's test indicates the obstruction in the biliary passages causing regurgitation of bile salts into the systemic circulation leading to its excretion in urine. Obstruction can occur in obstructive jaundice and also in hepatic jaundice due to obstruction of micro biliary channels caused by inflammation.

### Aminopyrine Excretion Test

Aminopyrine is metabolized by the liver by N-demethylation to give CO<sub>2</sub>. Using carbon (<sup>14</sup>C) labeled aminopyrine, the evolution of CO<sub>2</sub> corresponds to functioning liver cell mass. After an overnight fast, 2 mCi



van den Bergh  
1869–1943



Baruch Blumberg  
NP 1976  
1925–2011



Barry J Marshall  
NP 2005  
b. 1951



Robin Warren  
NP 2005  
b. 1937

**TABLE 26.4:** Tests useful to distinguish different types of jaundice

Specimen	Test	Pre-hepatic or hemolytic or retention jaundice	Hepatocellular jaundice	Post-hepatic or obstructive or regurgitation jaundice
Blood	Unconjugated bilirubin (van den Bergh indirect test)	++	++	Normal
	Conjugated bilirubin (van den Bergh direct test)	Normal	Excretion is rate-limiting. It is the first impaired activity. In early phase, it is increased	++
	Alkaline phosphatase (40–125 U/L)	Normal	2–3 times increased	10–12 times
Urine	Bile salt (Hay's test)	Absent	Absent	Present
	Conjugated bilirubin (Fouchet's)	Absent	Present	Present
	Urobilinogens (Ehrlich test)	+++	Increased in early cholestatic phase; Absent later decreased as production is low. Earliest manifestation of recovery is presence of bilinogen in urine	Absent
Feces	Urobilins	++	Normal or decreased	Clay colored

of amino ( $^{14}\text{C}$ ) pyrine and 2 mg unlabeled amino-pyrine are administered orally. The breath is allowed to pass through calcium sulfate for drying and then bubbled through a solution of 2 mL ethanol and 1 mL (1M) hyamine hydroxide containing 2 drops of phenolphthalein. The change in color of the indicator indicates absorption of  $\text{CO}_2$ . Then the activity of  $^{14}\text{CO}_2$  is measured in a scintillation counter. The  $^{14}\text{CO}_2$  excretion during the test period is reduced in liver diseases affecting parenchymal cells like cirrhosis, acute and chronic hepatitis and neoplasia.

### Causes of Jaundice

- i. Causes of jaundice are enumerated in Boxes 26.3 and 26.4. The most common cause for hepatocellular jaundice is infection with hepatitis viruses (viral hepatitis). It may be due to **hepatitis A virus (HAV)**,

#### Box 26.3: Causes of cholestatic liver disease

1. Extrahepatic cholestasis
  - Cholelithiasis (stone in gallbladder)
  - Carcinoma head of pancreas
  - Portal lymphadenopathy
  - Chronic pancreatitis
  - Biliary stricture
  - Parasites (liver flukes) (rare in India)
2. Intrahepatic cholestasis
  - Alcoholic cirrhosis
  - Primary biliary cirrhosis
  - Non-alcoholic steatohepatitis (NASH)
  - Viral hepatitis (cholestatic phase)
  - Protoporphyrria
  - Dubin-Johnson syndrome
3. Drugs
  - Androgens, Chlorpromazine
  - Chlorpropamide, Nitrofurantoin
  - Erythromycin, Phenytoin
  - Cyclosporine, Captopril

#### Box 26.4: Causes of hepatocellular damage

1. *Viruses*: HAV, HBV, HCV, Herpes, Adenovirus
2. Alcohol
3. *Toxins*: Carbon tetrachloride, Chloroform, Mushroom, Aflatoxin, Arsenic
4. *Immunological*: Autoimmune hepatitis, NASH
5. *General diseases*: Wilson's disease, Hemochromatosis, AAT deficiency, Porphyrias, Sarcoidosis, Amyloidosis
6. *Neoplasm*: Hepatocellular carcinoma, Metastatic liver disease, Lymphoma
7. *Bacterial infections*: TB, Leptospirosis, Brucella, Abscesses
8. *Parasites*: Helminths, Amebiasis, Plasmodia, Leishmania
9. *Drugs*: Salicylate, Tetracyclines, Methotrexate, Isoniazid, Rifampicin, Halothane, Methyldopa, Valproate

which is transmitted by the intake of contaminated food and water. Type A disease is usually self-limiting.

- ii. Infection by **hepatitis B virus (HBV)** is transmitted mainly through parenteral contamination by infected blood or blood products. The virus is highly contagious and can be destroyed only by boiling for 20 minutes. It is a DNA virus, which destroys the hepatic cells. The **surface antigen (HBs)** (also called Australia antigen, because it was first demonstrated in an Australian aborigine settled in USA) is seen in the circulation of patients. For his contributions in hepatitis prevention, Baruch Blumberg was awarded Nobel prize in 1976. About 5% of world populations are carriers of HBV. In most cases of hepatitis B infection, complete recovery is possible. In about 2–5 % cases, the disease passes on to a chronic carrier state. About 1% of cases progress to chronic cirrhosis and eventual hepatic failure. Infact, the most common cause for cirrhosis in developing countries is the hepatitis B virus. In a small fraction of such cases, development of hepatocellular carcinoma is also noticed. Thus HBV is an **oncogenic virus**. Medical personnel, including medical students, doctors, nurses and technicians are advised to take Hepatitis B vaccination.
- iii. Hepatitis viruses type A, B, C, D, E and G are identified. While A and E are transmitted by oral route; B,C,D and G are transmitted through parenteral route. Box 26.5 gives the serology to define the type of viral hepatitis. Serological markers of hepatitis B infection is shown in Box 26.6.

#### Box 26.5: Serology to define viral hepatitis type

Hepatitis A	Anti-HAV IgM
Hepatitis B acute	HBsAg, anti-HBc IgM
Hepatitis B chronic	HBsAg, HBeAg, HBV DNA
Hepatitis C	Anti-HCV and HCV RNA
Hepatitis D (delta)	HBsAg and anti-HDV
Hepatitis E	Anti-HEV

#### Box 26.6: Markers of hepatitis B infection

HBsAg	Surface antigen. Indicates acute infection. Persistence for >6 months means chronic infection
HBeAg	Viral replication. High infectivity
Anti-HBs antibody	Indicates immunity
Anti-HBe antibody	Resolution of acute infection
Anti-HBc IgM antibody	Acute infection
HBV DNA	Used to assess viral load



## Tests Based on Synthetic Function of Liver

### Serum Albumin Level

Almost all the plasma proteins except immunoglobulins are synthesized by the liver. Serum **albumin** (see Chapter 28) is quantitatively the most important protein synthesized by the liver, and reflects the extent of functioning liver cell mass.

Since albumin has a fairly long half-life of 20 days, in all chronic diseases of the liver, the albumin level is decreased. A reversal in A/G ratio is often the rule in cirrhosis, due to hypoalbuminemia and associated hypergammaglobulinemia (see Chapter 28).

Normal albumin level in blood is 3.5 to 5 g/dL; and globulin level is 2.5 to 3.5 g/dL.

The turnover rates of haptoglobin and transferrin are lesser than albumin; hence they are useful to identify recent changes in liver functions.

### Serum Globulins

They constitute immunoglobulins produced by B lymphocytes as well as alpha and beta globulins synthesized mainly by hepatocytes. Gamma globulins in the serum are increased in chronic liver diseases (chronic active hepatitis, cirrhosis). In cirrhosis, antibodies against intestinal bacteria are seen, since the cirrhotic liver cannot clear the bacteria reaching through circulation. Reference limits of serum immunoglobulins are shown in Appendix II. Ig G is increased in autoimmune hepatitis. Ig M is increased in primary biliary cirrhosis. Ig A is increased in alcoholic liver disease. Further details of immunoglobulins are given in Chapter 55.

### Prothrombin Time (PT)

Since prothrombin is synthesized by the liver, it is a useful indicator of liver function. The half life of prothrombin is 6 hours only; therefore PT indicates the present function of the liver. PT is prolonged only when liver loses more than 80% of its reserve capacity. Vitamin K deficiency is also a cause for prolonged prothrombin time. In case of liver disease, the PT remains prolonged even after parenteral administration of vitamin K.

### Alpha fetoprotein (AFP)

It is a normal component of fetal blood. It disappears after birth within a few weeks. It is a **tumor marker**. Mild elevation is suggestive of chronic hepatitis or cirrhosis; drastic increase is seen in hepatocellular carcinoma, germ cell tumors and teratoma of ovary. Elevated AFP in the maternal serum is seen in cases of fetal open **neural tube defects** and also in cases with multiple fetuses or fetal death. Low AFP is seen in maternal serum in cases of fetal Down syndrome. Immuno assay is employed to test AFP. Reference limits are, up to 1 year < 30 ng/mL and adults (males and non pregnant females < 15 ng/mL).

### Ceruloplasmin (Cp)

It is mainly synthesized by the hepatic parenchymal cells and a small part by lymphocytes. Level of Cp is increased in active hepatitis, biliary

cirrhosis, hemochromatosis and obstructive biliary disease. The level is decreased in **Wilson's hepatolenticular degeneration** (see Chapter 28).

### Transthyretin (Pre-albumin)

It is produced by the liver. It has a half-life of 2 days only. Hence it is a useful parameter to assess the hepatic function early in the course of liver disorders. Major function of this protein is to transport thyroxine and triiodothyronine.

### Alpha-1 Antitrypsin (AAT)

It is an acute phase reactant and is synthesized and secreted by the liver. AAT inactivates serum proteases (elastase and collagenase). Please see Chapter 28. It has got multiple alleles. PiZZ allele is characterized by deficient activity of this enzyme and individuals possessing such allele are prone for developing liver **cirrhosis**. Low levels are associated with neonatal cholestasis, progressive juvenile cirrhosis in children and micronodular cirrhosis in adults. Low levels are also seen in panlobular **emphysema**. It is increased in acute trauma, infections or after estrogen therapy and in many malignancies. Reference limits are shown in Appendix II.

### Haptoglobin

It is synthesized in the liver. It transports free hemoglobin in the plasma to reticuloendothelial system. The free Hb (not bound to haptoglobin) is freely filtered at the glomerulus and get precipitated in the tubules leading to damage to the kidney. Haptoglobin bound Hb complex being large cannot be filtered at the glomerulus and thus retained in the circulation. Haptoglobin bound Hb complex is degraded by the reticuloendothelial system leading to rapid depletion of haptoglobin from circulation in cases of exaggerated hemolysis. Low levels are seen with severe hepatocellular liver disease (deficient synthesis) and in hemolytic disease (increased rate of degradation). Being an acute phase reactant, its levels are high in inflammatory processes, trauma, infections, and myocardial infarction. Reference limits are shown in Appendix II. The turnover rates of haptoglobin and transferrin are lesser than albumin; hence they are useful to identify the recent changes in liver functions.

### Serum Electrophoresis

Abnormal electrophoretic patterns are shown in Figure 28.1. **Pre-albumin** is reduced in acute hepatitis. **Albumin** is decreased in cirrhosis. **Alpha-1 globulins** include glycoproteins and hormone binding globulins. This band is decreased in hepatocellular disease almost parallel to albumin. It is increased in febrile illnesses and malignancies. **Alpha-2 globulins and beta globulins**, when increased suggest biliary obstruction. This pattern will help to differentiate biliary cirrhosis from non-biliary cirrhosis. **Gamma globulins** are increased in cirrhosis. The rise in gamma globulin will have wide base, suggestive of polyclonal gammopathy. Moreover, the dip between beta and gamma globulin tends to be bridged.

## Tests Based on Serum Enzymes (Liver Enzyme Panel)

The enzymes used in the assessment of hepatobiliary disease may be divided into two groups: (a) Those indicating

hepatocellular damage and; (b) Those indicating cholestasis (obstruction).

### Enzymes Indicating Hepatocellular Damage

- i. Liver enzyme panel is described in detail in Chapter 23. Normal serum ALT (alanine amino transferase) is 10–35 IU/L.
- ii. The levels of **amino transferases** (ALT and AST) in serum are elevated in all liver diseases (Box 26.7).
- iii. **Very high levels** (more than 1000 units) are seen in acute hepatitis (viral and toxic).
- iv. The degree of elevation may reflect the extent of hepatocellular necrosis. In most cases the lowering of the level of transaminases indicates recovery, but a sudden fall from a very high level may indicate poor prognosis.
- v. Elevation of ALT is more in cases of hepatic disease compared to AST. But AST may be more than ALT in **alcoholic liver disease**. In alcoholic liver disease, the actual values show only mild elevation; but a ratio of AST/ALT more than two is quite suggestive.
- vi. **Moderate elevation** of amino transferases often between 100–300 U/L is seen in **alcoholic** hepatitis, autoimmune hepatitis, Wilson's disease and non-alcoholic chronic hepatitis (Box 26.8).
- vii. **Minor elevation** less than 100U/L is seen in chronic viral hepatitis (hepatitis C), fatty liver and in non-alcoholic steatohepatitis (**NASH**). In chronic hepatitis and cirrhosis of liver, serum ALT poorly correlates with the degree of liver cell damage.
- viii. A normal value need not rule out minor liver diseases. On the other hand, normal persons may have elevated ALT levels. This is seen especially in obese persons. 1% loss of weight will reduce ALT values by 8%.

### Markers of Obstructive Liver Disease

#### Alkaline Phosphatase (ALP)

- i. Very high levels of alkaline phosphatase (ALP) are noticed in patients with cholestasis or hepatic carcinoma. Bile duct obstruction induces the synthesis of the enzyme by biliary tract epithelial cells (see Chapter 23).
- ii. In **parenchymal diseases** of the liver, mild elevation of ALP is noticed. But in hepatitis, inflammatory edema produces an obstructive phase, during which ALP level is elevated. (Table 26.4).

#### Box 26.7: Clinical features of acute liver failure

##### Liver

Loss of metabolic function  
Decreased gluconeogenesis leading to hypoglycemia  
Decreased lactate clearance leading to lactic acidosis  
Decreased ammonia clearance leading to hyperammonemia  
Decreased synthetic capacity leading to coagulopathy  
Portal hypertension

##### Lungs

Adult respiratory distress syndrome

##### Adrenal gland

Inadequate glucocorticoid production contributing to hypotension

##### Bone marrow

Frequent suppression, especially in viral diseases

##### Circulating leukocytes

Impaired function contributing to sepsis

##### Brain

Hepatic encephalopathy  
Cerebral edema  
Intracranial hypertension

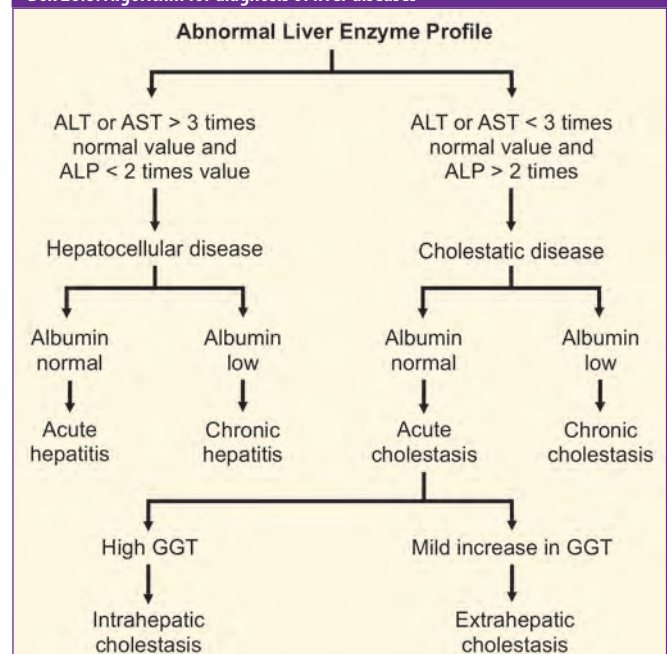
##### Heart

Subclinical myocardial injury

##### Kidney

Frequent dysfunction or failure

#### Box 26.8: Algorithm for diagnosis of liver diseases



- iii. Very high levels of ALP (10–12 times of upper limit) may be noticed in extrahepatic **obstruction** (obstructive jaundice) caused by gallstones or by pressure on bile duct by carcinoma of head of pancreas. Intrahepatic cholestasis may be due to virus (infective hepatitis) or by drugs (chlorpromazine). ALP is produced by epithelial cells of biliary canaliculi and obstruction of bile with consequent irritation of epithelial cells leads to secretion of ALP into serum.
- iv. Drastically high levels of ALP (10–25 times of upper limit) are seen in **bone diseases** where osteoblastic activity is enhanced. For example, Paget's disease (osteitis deformans), rickets, osteomalacia, osteoblastoma, metastatic carcinoma of bone and hyperparathyroidism.
- v. There are 6 iso-enzymes for ALP. The one, which is inhibited by phenylalanine is of placental origin. It is found in blood in normal pregnancy. An iso-enzyme closely resembling the placental form is characteristically seen in circulation in about 15% cases of carcinoma of lung, liver and gut and named as **Regan iso-enzyme** or carcinoplacental iso-enzyme (see Chapter 23).

### Gamma Glutamyl Transferase (GGT)

GGT is clinically important because of its sensitivity to detect **alcohol abuse**. GGT level in alcoholic liver disease roughly parallels the alcohol intake (see Chapter 23). Elevated levels of GGT are observed in chronic alcoholism, pancreatic disease, myocardial infarction, renal failure, chronic obstructive pulmonary disease and in diabetes mellitus. In liver diseases, GGT elevation parallels that of ALP and is very sensitive of biliary tract disease. Recent studies have shown elevated GGT levels in NASH also.

#### Box 26.9: Clinical significance of AST/ALT ratio

Normal AST: ALT ratio is 0.8. A ratio >2 is seen in

- Alcoholic hepatitis
- Hepatitis with cirrhosis
- Non-alcoholic steatohepatitis (NASH)
- Liver metastases
- Myocardial infarction
- Erythromycin treatment

A low ratio (ALT is higher) is seen in

- Acute hepatocellular injury
- Toxic exposure
- Extrahepatic obstruction (cholestasis)

### 5'-Nucleotidase

It is also called Nucleotide phosphatase (NTP). The level is increased in hepatobiliary disease and closely parallels the ALP levels (see Chapter 23). 5'-nucleotidase elevation is not noticed in childhood and pregnancy as in the case of ALP. Hence estimation is more specific for **obstructive liver disease**.

### Special Tests

- i. In special circumstances, special tests may be done to confirm the diagnosis. Some examples are: **Glutathione-S-transferase** activity is a very sensitive indicator of liver function.
- ii. **Alpha fetoprotein** (AFP) is a **tumor marker** (see Chapter 57). Its level in blood is markedly increased in hepatocellular carcinoma. In chronic hepatitis, there may be mild elevation.

## Tests for Metabolic Capacity of Liver

### Blood Ammonia

It is an index of urea synthesis by liver. It is a useful test in **hepatic encephalopathy**. The major source of ammonia in the blood is bacteria of gastrointestinal tract. It is produced by action of intestinal bacterial protease, urease and amino oxidase on the intestinal contents. The ammonia is later converted to urea by the liver, but this activity is considerably decreased in hepatic cell damage; or by the development of portocaval shunts causing portal blood to bypass the liver.

The ammonia level is an indicator of the capacity of the liver to eliminate ammonia generated in intestine. Raised ammonia in the serum/plasma is suggestive of **cirrhosis** and/or development of collateral circulation. It may occur with **portocaval anastomosis**.

Arterial blood should be used for blood ammonia estimation. Estimation of ammonia may be helpful to exclude or diagnose hepatic failure in patients with unexplained stupor or coma.

In neonates suspected to have urea cycle disorders (and in organic acidurias), ammonia estimation is indicated.

**Precautions:** Fasting plasma/serum is used for ammonia estimation. Stringent precautions are to be maintained. Vacutainers must be used and the blood withdrawn until it is full. Partial filling allows entry of air. Glutamine in the specimen is a source of ammonia contamination. This can be avoided by the placing the sample immediately in ice and centrifuging to separate plasma or serum and carry out the assay as soon as possible. EDTA or heparin can be used as anticoagulants. Enzymatic assay (with glutamate dehydrogenase) is done by photometry or by ammonia selective electrode. Reference limits of venous ammonia nitrogen are given in Appendix I.

The clinical features of acute liver failure are shown in Box 26.7.

### Other Rare Tests

Substances which are selectively metabolized by the liver were used to assess liver function previously, e.g. Galactose tolerance test, Bromsulphthalein excretion test, etc. As these are seldom used now in clinical practice, these tests are not described in this textbook.

### Immunological Tests in Liver Disease

**IgG** level is increased in chronic hepatitis, alcoholic and autoimmune hepatitis. It shows a slow and sustained increase in viral hepatitis. **IgM** shows marked increase in primary biliary cirrhosis and moderate increase in viral hepatitis and cirrhosis. **IgA** is increased in alcoholic cirrhosis and primary biliary cirrhosis.

**Autoantibodies:** Autoimmune chronic hepatitis is due to defective suppressor T cells leading to production of autoantibodies against hepatocyte surface antigens (Table 26.5). Commonly encountered autoantibodies in hepatic autoimmune disorders are:

- Antinuclear antibodies
- Double stranded DNA
- Smooth muscle (actin) antibody
- Asialoglycoprotein receptor autoantibody
- Antimitochondrial antibody

High titers of antimitochondrial antibodies are seen in primary biliary cirrhosis. Moreover anti smooth muscle antibodies and antinuclear antibodies are seen in chronic active hepatitis. The increase in these globulin fractions (IgM and IgG) may cause a reversal of A/G ratio. These tests only indicate the autoimmune component in these diseases and are not specific markers of autoimmune liver disease.

### Selection of Tests

Liver function tests are the most common group of biochemical tests done to diagnose and monitor the course of liver disease. The increased incidence of infectious diseases like viral hepatitis and leptospirosis requires these tests to be done in all patients with unexplained illness.

#### Box 26.10: Liver regeneration

Prometheus was punished for stealing fire from the Gods. As punishment he was chained to rocks and his liver was pecked by vultures everyday. However, he survived. How?

About 90% of liver can be removed and still the remaining liver cells re-enter cell cycle and divide replacing the lost cells within weeks. The story tells us that this ability of liver cells to regenerate was known even from ancient days.

**TABLE 26.5:** LFT in autoimmune hepatitis

	Cases not in active state	Active or advanced
Serum bilirubin	Normal	3 – 10 mg%
Albumin	Normal	Decreased
Globulin	< 2.5 g %	> 2.5 g%)
ALP	Normal	Increased
Transaminases	<100 U/L	100 – 1000 U/L
PT	Prolonged	Prolonged
Autoantibodies anti LKM1	ANA,	ANA, smooth muscle ab

Several different tests are to be done for overall assessment of the liver function. Table 26.6 gives the different tests and the alterations in different types of liver diseases.

**TABLE 26.6:** Overview of liver function tests

Parameter	Remarks
Serum albumin	In chronic liver disease
Serum globulins	Increase in chronic hepatitis
PT	Prolonged in liver disease
PT + vitamin K	Prolonged in hepatocellular If PT normal, cholestasis
Alpha fetoprotein	Increase in carcinoma
Ceruloplasmin	Decrease in Wilson's disease, Menke's disease
Transthyretin	To assess nutritional status
Alpha-1 antitrypsin	Decrease in neonatal cholestasis, progressive juvenile cirrhosis, micronodular cirrhosis
Haptoglobin Transferrin	Severe hepatocellular disease cirrhosis.
Lipoprotein X	Increase in cholestasis
Galactose	Half-life >12 minutes in tolerance test cirrhosis, infective hepatitis
Amino acids	Increased aromatic amino acids + branched chain aminoacids in hepatic coma; both increased in cirrhosis
Serum bilirubin	See Table 26.4.
Urine bilirubin	See Table 26.4
Urine urobilinogen	See Table 26.2
Plasma bile acids	Post-prandial rise in hepatic dysfunction; increased fasting level in portosystemic shunting
Urine bile salts	Positive in post-hepatic jaundice and hepatic jaundice
Ammonia	Increase in cirrhosis, portocaval anastomosis
<b>Transaminases</b>	
Viral hepatitis	ALT and AST increased
Chronic active hepatitis	N or slight increase
Cholestasis	Slight increase
Alcoholic hepatitis	ALT/AST ratio reversed
ALP	Increase in cholestasis
GGT	Increase in cholestasis



Most commonly employed liver function tests in clinical practice are serum bilirubin, albumin, ALP, ALT, AST and GGT. Cholesterol level in blood is also increased in obstructive jaundice due to defective excretion through bile. In general, ALT and ALP distinguishes the pattern of liver disease. Albumin determines the chronicity and prothrombin time determines the severity of liver dysfunction (Box 26.10).

## Gastric and Pancreatic Function Tests

These tests are now rarely done since the introduction of endoscopy and imaging techniques have reduced their usefulness. However, they are included since some of these tests are still in use and may be done in selected cases.

### Gastric Function Tests

The gastric mucosa has different types of cells: (a) The mucous secreting surface epithelial cells, (b) The oxyntic or parietal cells which secrete acid, and (c) The chief cells or peptic cells that secrete enzymes.

### Mechanism of HCl Secretion

- i. The daily volume of gastric secretion is around 2000 mL. The HCl secreted by the parietal cells is of high concentration (0.15 M) with a pH as low as 0.8.

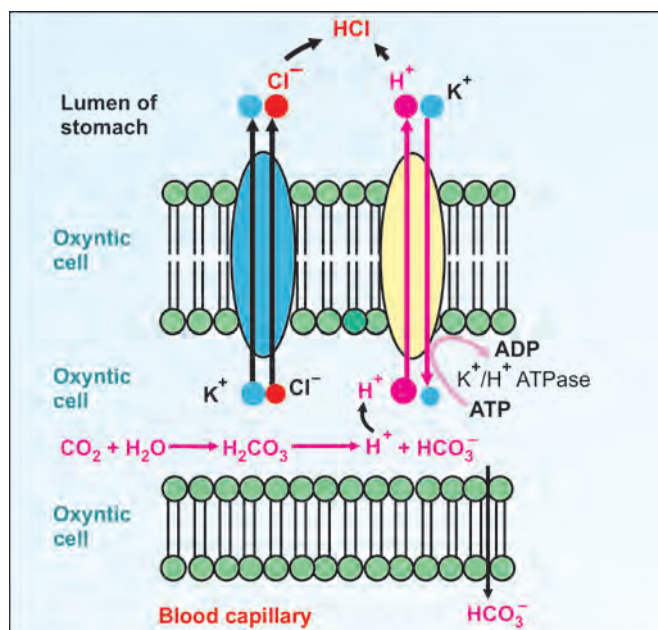


Fig. 26.3: Hydrochloric acid secretion

- ii. The parietal cells transport protons against a concentration gradient at the extracellular fluid pH of 7.4. It is an energy requiring process.
- iii. The K<sup>+</sup> activated ATPase is necessary for the production of HCl (Fig. 26.3). It is located on the luminal side of the plasma membrane.
- iv. The H<sup>+</sup> ions are generated within the cell by ionization of carbonic acid. The carbonic anhydrase is active in the parietal cells.
- v. One molecule of ATP is hydrolyzed for every molecule of H<sup>+</sup> secreted (Fig. 26.3). The hydrolysis of ATP is coupled with an exchange of K<sup>+</sup> for H<sup>+</sup>. The hydrogen ions are then secreted into gastric lumen.
- vi. Side by side with the H<sup>+</sup> to K<sup>+</sup> exchange, bicarbonate to chloride exchange is also taking place. When the bicarbonate level within the cell increases (formed from H<sub>2</sub>CO<sub>3</sub>), it is reabsorbed into blood stream, in exchange for Cl<sup>-</sup>. The chloride is then secreted into the lumen to form HCl.
- vii. This would account for the **alkaline tide** of plasma and urine, following hydrochloric acid secretion, immediately after meals (Fig. 26.4).

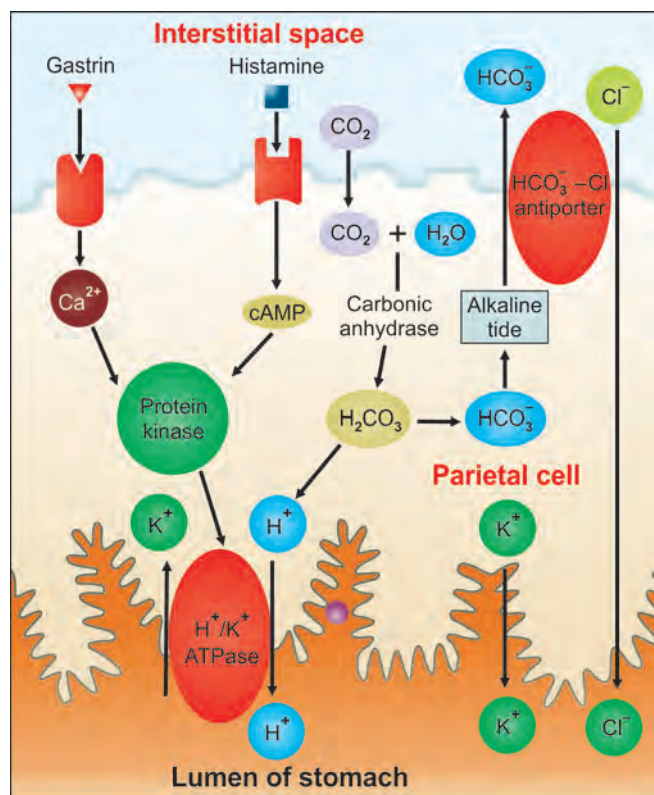


Fig. 26.4: Regulation of secretion of HCl

## Regulation of Acid Secretion

- i. **Gastrin**, the gastrointestinal peptide hormone secreted by G cells, stimulates secretion of HCl. The secretion of gastrin is cut off by acidic pH by a feedback regulatory control (Fig. 26.4).
- ii. The most potent stimulus for acid secretion is **histamine**, which acts through specific H<sub>2</sub> receptors on the gastric mucosa.

## Other Constituents of Gastric Secretions

The major enzyme present in gastric juice is **pepsin**. Its action on dietary proteins is indicated in Chapter 15. One of the functions of HCl is to activate the zymogen pepsinogen to pepsin by partial proteolysis. In addition, the HCl helps in the **absorption of iron** and calcium. The gastric juice also contains a glycoprotein required for the absorption of B<sub>12</sub>, the Castle's **intrinsic factor**.

## Assessment of Gastric Function

In **Fractional test meal** or FTM, the fasting stomach contents are aspirated and the secretion is stimulated by giving test meals. Different samples are collected and the acidity (free and total) of each sample is measured. The FTM is not done nowadays; but the modified version, though rare, is still in use. It is described below.

### Pentagastrin Stimulation Test

In the fasting condition, the gastric juice is aspirated through a Ryle's tube (Residual juice). The gastric juice secreted for the next 1 hour is collected as a single sample (**Basal secretion**). The gastric secretion is now stimulated by giving pentagastrin. It is a synthetic peptide having the biologically active sequence of gastrin. (Pentagastrin has the following structure: Butyl oxycarbonyl - beta Ala - Trp - Met - Asp - Phe - NH<sub>2</sub>). Pentagastrin is given in a dose of 6 mg/kg body weight. The gastric secretion is collected every 15 minutes for the next 1 hour.

**Basal acid output (BAO)** is the acid output in millimol per hour, in the basal secretion (in the absence of all intentional and avoidable stimulation).

**Maximal acid output (MAO)** is the acid output in millimol per hour, given by the sum of the acid output of the four 15-minute samples after the stimulation.

**TABLE 26.7:** Normal hydrochloric acid secretion

	Acid output in mmol/hour			
	Men		Women	
	Lower limit	Upper limit	Lower limit	Upper limit
Basal acid output	–	10	–	5.5
Maximal acid output	7	45	5	30
Peak acid output	12	60	8	40

**Peak acid output (PAO)** is the acid output in millimol per hour, given by the sum of the acid output of the 2 consecutive 15-minute samples having the highest acid content. The value is multiplied by 2 to get the value for 1 hour. Normal values are given in Table 26.7.

## Interpretations of Gastric Juice Analysis

- i. **Zollinger-Ellison syndrome**. This condition results from a gastrin secreting tumor (gastrinoma of the pancreas). There is no feedback regulation of gastrin secretion. There is very high level of gastric acid output along with elevated serum gastrin levels. In this condition, BAO is >15 mmol/h (may be as high as 150 mmol/h) and BAO/PAO ratio is 0.6 or higher.
- ii. In chronic duodenal ulcer, BAO, MAO and PAO are significantly elevated. BAO may vary from 4–6 mmol/h and a BAO/PAO ratio of more than 0.3 indicates increased basal secretory drive. Causes for hyperacidity and hypoacidity are shown in Box 26.11.

## Augmented Histamine Test

Histamine, the most potent stimulus of gastric secretion is given and the response in acid secretion is noted. The *augmented histamine test* (AHT) is done by giving 0.04 mg/kg of histamine subcutaneously, followed by collection of gastric contents. If the hypoacidity does not respond to histamine, it is said to be true hypoacidity or **histamine fast achlorhydria**.

This is characteristic of pernicious anemia. But in other cases of hypoacidity, gastric acid secretion occurs in response to histamine (false hypoacidity).

Histamine may produce hypotension. As a precaution, an initial dose of antihistamine may be given to block the H<sub>1</sub> receptor effects of histamine. Cimetidine blocks H<sub>2</sub> histamine receptors of stomach and helps in healing of peptic ulcers.

**Tubeless gastric analysis:** This avoids the discomfort of passing a stomach tube. It is used only as a screening test. Fasting secretion

### Box 26.11: Causes for hyper and hypoacidity

#### Hyperacidity is seen in

- i. Duodenal ulcer
- ii. Gastric cell hyperplasia
- iii. Carcinoid tumors
- iv. Zollinger-Ellison syndrome
- v. MEN (multiple endocrine neoplasia)
- vi. Excessive histamine production as in systemic mastocytosis and basophilic leukemia.

#### Hypoacidity is seen in

- i. Gastritis
- ii. Gastric carcinoma
- iii. Partial gastrectomy
- iv. Pernicious anemia
- v. Chronic iron deficiency anemia.

is stimulated by giving a histalogue. After 1 hour, a dye bound resin (Azure-A) is given orally. In the presence of HCl, the resin releases the dye. This release is proportional to the surrounding pH. The released dye is absorbed and later excreted through urine. The quantity of dye in urine provides an indication to the presence or absence of HCl.

### Other Relevant Clinical Laboratory Tests

- Serum **gastrin level** may be estimated by radioimmunoassay. In normal cases, the level is usually <10 pmol/L (<200 ng/L) and never above 50 pmol/L. In Zollinger-Ellison syndrome, the values may be more than 100 pmol/L.
- Occult blood** in gastric juice indicates gastric carcinoma, gastric ulcer or duodenal ulcer.
- The presence of bile and undigested food indicates the stagnation of food or regurgitation of bile.
- Gastric ulcers are perpetuated by the infection of *Helicobacter pylori*. Marshall and Warren were awarded Nobel Prize in 2005 for their discovery of the bacterium *H. pylori* and its role in acid peptic disease. The bacteria produce ammonia, with the help of bacterial urease. So, the organism can escape the attack of acidic gastric juice. *H. pylori* infection is identified by presence of urease enzyme in gastric biopsies and detecting *H. pylori* antibodies in serum.

### Pancreatic Function Tests

The exocrine pancreas secretes about 1000–2500 mL of juice in 24 hours. The fluid is alkaline and contains bicarbonate and enzymes. This secretion is under the control of the hormones, **Secretin** and **Cholecystokinin**. Secretin is produced under the stimulation of gastric HCl. Secretin produces a secretion with high bicarbonate content. Gastrin stimulates production of cholecystokinin (CCK), which in turn produces pancreatic secretion rich in enzymes. The major enzymes present in pancreatic juice are amylase, lipase and proteolytic enzymes (trypsin, chymotrypsin, carboxypeptidase, elastase) as their zymogens (see Chapter 15).

### Assessment of Pancreatic Function

**Measurement of pancreatic enzymes:** Amylase or alpha-1,4-glucosidase is the major enzyme which digests starch (see Chapter 23). The serum amylase contains the P (pancreatic) and S (salivary) iso-enzymes. These two can be distinguished by the inhibition test. A protein inhibitor, present in alcoholic extracts of wheat will selectively inhibit the S isoenzyme. Normal amylase level in serum is 50–120 units. The level rises within 5 hours of the onset of **acute pancreatitis** and the level reaches a peak within 12 hours. But the level need not parallel the severity of the disease. Within 2–4 days of the attack, the level returns to normal. As the serum amylase level starts falling, urinary amylase level rises. If the sample is collected too early, the serum amylase levels may not show the expected rise. If the sample is collected too late, again serum amylase may be low due

to necrosis of the pancreatic tissue. Calculation of clearance ratio will avoid these defects.

$$CR = \frac{\text{Urine amylase level}}{\text{Serum amylase level}} \times \frac{\text{Scr}}{\text{Ucr}} \times 100$$

CR is clearance ratio, Scr is serum creatinine level and Ucr is urinary creatinine level. In patients with acute pancreatitis, the ratio varies from 7 – 15%. The normal ratio is 1 – 4.4%

Amylase level in blood is mildly increased in cases of cholecystitis, peptic ulcer, diseases of mesentery and obstruction of intestine. A small percentage of patients with acute pancreatitis fails to show any rise. No significant change or only mild elevation is noticed in chronic pancreatitis.

**Macroamylasemia** is a condition characterized by persistent elevation of serum amylase activity with no apparent clinical symptoms of pancreatic disease. The amylase complexes with immunoglobulins, which prevents renal excretion. Macroamylasemia by itself is not a disease. But it may be an early marker of pancreatic disease.

**Serum lipase** is the major lipolytic enzyme which hydrolyzes glycerol esters of long chain fatty acids. The level in blood is highly elevated in **acute pancreatitis** and this persists for 7 – 14 days. Thus lipase remains elevated longer than amylase. Moreover, lipase is not increased in salivary diseases. Therefore, lipase estimation has advantage over amylase.

**Pancreatic elastase:** Another test for the diagnosis of pancreatic insufficiency is pancreatic elastase. ELISA test kits are available; a value of >200 µg in stool sample indicates normal exocrine pancreatic function and values <200 µg indicates exocrine pancreatic insufficiency.

**Other pancreatic enzymes:** A simple screening test for tryptic activity of feces may be done using serial dilutions of stool extract. Drops of serially diluted extract is placed on a piece of X-ray film along with a control sample. After an hour at 37°C, the extract is washed off, and the film examined for tryptic activity by noting translucency of the film.

**Secretin-cholecystokinin test:** In the fasting condition, the duodenal contents are first aspirated. Then secretin 1 unit/kg body weight is given followed by CCK. Again the duodenal contents are aspirated for 80 minutes at 10 minutes intervals. Each sample is analyzed for volume, bicarbonate content and amylase activity. If the bicarbonate secretion is more than 15 mmol/L at 30 minutes, the secretory capacity is normal.



Table 26.8 gives the normal response and abnormal pattern in diseases.

**Lundh test:** The test meal is composed of milk powder, vegetable oil and glucose to make 6% fat, 5% protein and 15% carbohydrate. After aspirating the duodenal contents, 500 mL of fluid meal is given. Then duodenal secretions are collected at 30 minutes intervals for 2 hours. The tryptic activity of duodenal aspirates are measured. Benzoyl arginine ethyl ester (BAEE) is incubated with the aspirate. The benzoic acid liberated after tryptic hydrolysis of the substrate is calculated. In chronic pancreatitis, the tryptic activity is decreased, but not in carcinoma of pancreas.

**Indirect tests** of pancreatic function include (a) Measurement of tumor markers like carcino-embryonic antigen (CEA), alpha feto protein (AFP), and pancreatic oncofetal antigen. (b) Fat balance studies. (c) Measurement of leucine aminopeptidase which is usually elevated in pancreatic carcinoma.

**Estimation of sweat electrolytes:** In pancreatic **fibrocystic disease**, sodium and chloride are increased in sweat. The disease is characterized by thick viscous secretion of exocrine glands, including pancreas, salivary, tracheal, bronchial and sweat glands. Pilocarpine is given into the skin to stimulate the secretion of sweat glands. The sweat is absorbed into a filter paper, which is weighed before and after the absorption. The difference in weight of the filter paper gives the weight of the sweat. From the specific gravity and weight, the volume is determined. Then sodium and chloride are eluted from the filter paper and separately determined. Sweat chloride levels of more than 60 mmol/L, on two separate occasions, is diagnostic of cystic fibrosis.

## STUDIES ON MALABSORPTION

**Malabsorption** may result from defective digestion or faulty absorption or from both. Reduction of absorptive surface may result from i) Celiac disease; ii) Gluten sensitive enteropathy; iii) Tropical sprue; iv) Ideopathic steatorrhea; v) Extensive surgical removal of ileum; vi) Crohn's disease or vii) Whipple's disease. Pancreatic disease can lead to defective digestion. The following tests are useful to assess the malabsorption states.

**Fat balance studies:** The estimation of fat in stool is done. When feces contains split fatty acids, it points to a normal pancreatic function, but defective absorption. On the other hand, if the fat excreted is neutral fat, it is due to defective digestion, and is more in favor of pancreatic disease.

**D-Xylose absorption test:** Xylose is absorbed easily, but not rapidly metabolized. Hence its blood level is an index of the rate of absorption. An oral dose (25 g) of xylose is given to the fasting patient. In normal

subjects, more than 23% of the administered dose should be excreted during the 5 hours, out of which 50% excretion should occur within the first 2 hours. In severe malabsorption, the total excretion is low. In mild malabsorption, it may only be delayed.

**Starch tolerance test:** A usual GTT is done on the first day (see Chapter 24). On the following day, 100 g soluble starch is given and the rise in glucose level is noted. In normal cases, the peak level in the starch test will be at least 80% of the peak level of usual GTT.

**Schilling test:** It is done to note the malabsorption of vitamin B<sub>12</sub>. One microgram of radiolabeled (<sup>60</sup>Co) vitamin B<sub>12</sub> is given orally. Then a flushing dose of non-radiolabeled B<sub>12</sub> is given parenterally to saturate free binding sites and ensure excretion of the labeled B<sub>12</sub>. If absorption is defective, radioactivity in urine is minimal, which may be enhanced by simultaneous oral administration of intrinsic factor (see Chapter 38, under vitamin B<sub>12</sub>).

## Clinical Case Study 26.1

A 45-year-old male with history of cirrhosis of the liver is brought to the emergency center by family members for acute mental derangements, disorientation alterations in personality and confusion over the last few days. Patient is vomiting blood. On examination, he is disoriented with evidence of icteric sclera. His abdomen is distended with a fluid wave appreciated. His urine drug screen and ethyl alcohol (EtOH) screen are both negative. A blood ammonia level was elevated, and all other tests have been normal.

What is the most likely cause of the patient's symptoms? What was the likely precipitating factor of the patient's symptoms? What is the cause for fluid in abdomen?

## Clinical Case Study 26.2

A 45-year-old female presents to the clinic with midepigastic pain and nausea/vomiting after eating "greasy meals". The symptoms gradually disappear, and return after some days. She denies any hematemesis. She had elevated cholesterol levels. On examination, she is afebrile with normal vital signs. Her physical examination is completely normal with no evidence of abdominal pain. An abdominal ultrasound is performed and revealed a few gallstones in the gallbladder. What factors would you need to consider to assess the need for cholecystectomy? What are gallstones made of? Can gallstones be seen on abdominal X-ray?

## Clinical Case Study 26.3

A 26-year-old female at 35 weeks gestation presents to the clinic with complaints of generalized itching (pruritis).

**TABLE 26.8: Pancreatic function tests**

	Volume (mL/h)	HCO <sub>3</sub> <sup>-</sup> (mmol/L/h)	Amylase (Unit/h)
Normal	150–200	70	200
Chronic pancreatitis	Decrease	Decrease	Decrease
Pancreatic	Normal	Decrease	Decrease carcinoma
Obstruction to pancreas duct	Decrease	Normal	Normal



She denies any change in clothing detergent, soaps, or perfumes. She denies nausea and vomiting. On physical examination, there are no rashes apparent on her skin. Blood test reveals slightly elevated serum transaminase and bilirubin levels. What is the patient's likely diagnosis? What are treatment options? What is the cause of the patient's generalized itching?

### Clinical Case Study 26.1 Answer

The likely cause is Cirrhosis.

Patient presents with cirrhosis, most probably, secondary to hepatitis virus infection, with acute mental status change coinciding with recent onset of hematemesis. Patient has an elevated serum ammonia level and otherwise negative workup. Hepatic encephalopathy (disorientation, etc.) is secondary to elevated ammonia levels. The precipitating factor is increased nitrogen load from upper gastrointestinal bleeding.

Cirrhosis is a chronic condition of the liver with diffuse parenchymal injury and regeneration leading to distortion of the liver architecture and increased resistance of blood flow through the liver. The patient usually manifests malaise, lethargy, palmar erythema, ascites, jaundice, and hepatic encephalopathy in the late stages. Toxins accumulating in the bloodstream affect the patient's mental status. The most common etiologies of cirrhosis are toxins such as alcohol, viral infections such as hepatitis B or C infection, or metabolic diseases in children (Wilson disease, hemochromatosis, or alpha-1-antitrypsin deficiency). As liver functions are reduced, albumin synthesis is lowered, which leads to ascites (fluid in abdomen).

### Clinical Case Study 26.2 Answer

#### Gallstones

**Surgical removal of gallbladder (cholecystectomy) is done when there is** frequent and severe attacks. **Components of gallstones are** cholesterol, calcium bilirubinate, and bile salts.

Mixed stones are much easier to see on plain film secondary to calcifications, comprising approximately 10 percent of gallstones. This individual fits the "classic" patient with gallbladder disease—female, middle-aged, overweight. The gallbladder stores bile salts produced by the liver. The gallbladder is stimulated to contract when food enters the small intestine; the bile salts then travel through the bile duct to the duodenum. The bile salts act to emulsify fats, helping with the digestion of fat. Gallstones form when the solutes in the gallbladder precipitate. Cholesterol stones are usually yellow-green in appearance and account for approximately

80% of gallstones. Stones made of bilirubin appear dark in color. Patients may have pain from the gallstones, usually after a fatty meal. The pain is typically epigastric or right upper quadrant and perhaps radiating to the right shoulder. If the gallbladder becomes inflamed or infected, cholecystitis can result. The stones can also travel through the bile duct and obstruct biliary flow leading to jaundice, or irritate the pancreas and cause pancreatitis.

### Clinical Case Study 26.3 Answer

#### Cholestasis of pregnancy

**Treatment options:** Oral antihistamines

**Etiology:** Cholestasis of pregnancy is a condition in which the normal flow of bile from the gallbladder is impeded, leading to accumulation of bile salts in the body. Generalized itching and, possibly, jaundice may result. It is speculated that the hormones such as estrogen and progesterone, which are elevated in pregnancy, cause a slowing of the gallbladder function, leading to this disorder. Uncomplicated cholestasis is usually diagnosed clinically by generalized itching in a pregnant woman, usually in the third trimester without a rash. Elevated serum bile salts, bilirubin and transaminase may also be seen. The usual treatment includes antihistamine medications for the itching. Liver function and may reduce the serum bile acid concentration. More severe cases may require bile salt binders such as cholestyramine or corticosteroids.

## QUICK LOOK OF CHAPTER 26

1. Bilirubin is estimated by van den Bergh reaction. Normal serum does not give a positive van den Bergh reaction.
2. When bilirubin is conjugated, the purple color is produced immediately on mixing with the reagent, the response is said to be van den Bergh direct positive. When the bilirubin is unconjugated, the color is obtained only when alcohol is added, and this response is known as indirect positive.
3. The most common cause for hepatocellular jaundice is the infection with hepatitis viruses (viral hepatitis).
4. Elevated levels of Gamma Glutamyl Transferase (GGT) are observed in chronic alcoholism, pancreatic disease, myocardial infarction, renal failure, chronic obstructive pulmonary disease and in diabetes mellitus.
5. High levels of alkaline phosphatase (ALP) are noticed in patients with cholestasis or hepatic carcinoma.

# CHAPTER 27

## Kidney Function Tests

### Chapter at a Glance

The reader will be able to answer questions on the following topics:

- Glomerular functions
- Tubular functions
- Abnormal constituents of urine
- Clearance tests: Inulin, creatinine and urea
- Proteinuria
- Tests for tubular functions

The major functions of the kidneys are to excrete metabolic waste products as well as to maintain water, pH, electrolyte balance, production of calcitriol and erythropoietin (Box 27.1). A decrease in kidney function is due to a reduction in the performance of nephrons. The functional unit of the kidney is the **nephron**, which is composed of the Bowman's capsule with the glomerular tuft of capillaries, the proximal convoluted tubule (PCT), loop of Henle, distal convoluted tubule (DCT) and collecting tubules.

### RENAL FUNCTION TESTS

The classification of renal functional tests are shown in Box 27.2.

#### Box 27.1: Functions of kidney at a glance

1. Excretion of urea and other waste products, such as creatinine, uric acid and metabolites of xenobiotics (Table 27.4)
2. Maintaining water balance
3. Excretion of sodium (effect on BP)
4. Excretion of potassium (effect on heart)
5. Excretion of hydrogen ions (maintenance of pH)
6. Activation of vitamin D (effect on bone)
7. Production of erythropoietin (effect on RBCs)
8. Filtration: 180 liters/day of water with all sodium, chloride, sugar and amino acids
9. Reabsorption: 178.5 liters reabsorbed; all glucose and amino acids reabsorbed; most of sodium and chloride reabsorbed.

### Glomerular Function

When the blood is perfused through the Bowman's capsule, an ultrafiltrate of the blood is produced in glomerulus, while the cells and proteins are retained in the blood. The sieves of the glomeruli are such that hemoglobin (mol wt 67,000 D) is passed through to be excreted in urine, while albumin (mol wt 69,000 D) is retained in the blood. Therefore, the earliest manifestation of the abnormal function of the glomeruli is the **appearance of albumin** in urine.

#### Box 27.2: Classification of renal function tests

- I. **To screen for kidney disease**
  - Complete urine analysis
  - Plasma urea and creatinine
  - Plasma electrolytes
- II. **To assess renal function:**
  - a. **To assess glomerular function**
    - Glomerular filtration rate
    - Clearance tests
    - Glomerular permeability
    - Proteinuria
  - b. **To assess tubular function**
    - Reabsorption studies
    - Secretion tests
    - Concentration and dilution tests
    - Renal acidification

## Glomerular Filtration Rate (GFR)

- GFR is decreased when BP is below 80 mm of mercury. The GFR is reduced when there is obstruction to the renal flow (calculi, enlarged prostate, etc.). It also decreases with age.
- The **renal blood flow** is about 700 mL of plasma or 1200 mL of blood per minute.
- The glomerular filtration rate (GFR) is 120–125 mL per minute in a person with 70 kg body weight.
- Glomerular filtrate formed is about 170 to 180 liters per day, out of which only 1.5 liters are excreted as urine. This means that most of the water content of glomerular filtrate is reabsorbed.

## Functions of the Tubules

- When the glomerular filtrate is formed, it contains almost all the crystalloids of plasma. In the proximal convoluted tubules, about 70% water, Na<sup>+</sup> and Cl<sup>-</sup> as well as 100% glucose, amino acids and K<sup>+</sup> are reabsorbed.
- Urea, phosphate and calcium are partially absorbed. (Table 27.1).
- The major processes occurring in renal tubules are the reabsorption or secretion of solutes and reabsorption of water. Table 27.3 shows the functions of different parts of the renal tubules.

## Renal Threshold and Tubular Maximum

- Compounds whose excretion in urine are dependent on blood level are known as **threshold substances**. At normal or low plasma levels, they are completely reabsorbed and are not excreted in urine. But when the blood level is elevated, the tubular reabsorptive

capacity is saturated, so that the excess will be excreted in urine (Table 27.2).

- The renal threshold of a substance is the plasma level above which the compound is excreted in urine.
- The maximum reabsorptive capacity of the substances is known as the **tubular maximum** or T<sub>m</sub>.
- For glucose, the renal threshold is 180 mg/dL and T<sub>m</sub> is 375 mg/min. In other words, glucose starts to appear in urine when blood level is more than 180 mg/dL, and all the glucose molecules above 375 mg are excreted in the urine. Table 50.3 gives a list of threshold substances.
- In abnormal conditions, the renal threshold may be lowered so that even at lower blood levels, compounds are excreted in urine, e.g. renal glycosuria (glucose); and renal tubular acidosis (bicarbonate).

## Reabsorption of Solute in Tubules

### Sodium

- In the proximal convoluted tubules, the reabsorption of sodium is by **co-transport mechanism**, accompanied by glucose, amino acids. These mechanisms are coupled with the activity of sodium-potassium-ATPase. There is passive transport of equivalent amounts of chloride to maintain the electrical neutrality. The net effect is the reabsorption of sodium chloride along with glucose, amino acids, etc.
- The co-transport of glucose is inhibited by ouabain and phlorhizin. The sodium-Pi co-transport system is inhibited by parathyroid hormone and facilitated by calcitriol.
- In addition, Na<sup>+</sup> to H<sup>+</sup> exchange system also exists in the PCT. This is an **antiport system**, where sodium ions are reabsorbed, in exchange for hydrogen ions. This also achieves a net reabsorption of bicarbonate (see Chapter 29). When hydrogen ions are to be conserved, sodium to potassium exchange occurs.

**TABLE 27.2:** Threshold value of some common substances excreted through urine

Substance	Threshold value plasma level
1. Glucose	180 mg/dL
2. Lactate	60 mg/dL
3. Bicarbonate	28 mEq/L
4. Calcium	10 mg/dL

**TABLE 27.1:** Handling of solutes by the renal tubules

Compound	Mode of handling by tubules	Relative concentration
Creatinine	Not reabsorbed; secreted in small amounts	GF = Urine
Uric acid	90% is first absorbed in PCT; but later secreted in DCT	GF ≅ Urine
Urea	About 40% reabsorbed in PCT	GF > Urine
Sodium	Partially reabsorbed	GF > Urine
Glucose	Completely reabsorbed	GF >> Urine
Amino acid	Completely reabsorbed	GF >> Urine

Abbreviation: (PCT = proximal convoluted tubules; DCT = distal convoluted tubules)

**TABLE 27.3:** Main functions of kidney tubules

Segment of nephron	Reabsorption of	Secretion of
Proximal convoluted tubule (PCT)	Sodium (85%), Chloride (85%), Bicarbonate (85%), Glucose (100%), Amino acids (100%), Uric acid, water (obligatory).	H <sup>+</sup> , Acids and bases, NH <sub>4</sub> <sup>+</sup> , Diodrast, PAH
Loop of Henle	Na <sup>+</sup> , Cl <sup>-</sup> , Ca <sup>++</sup> , Mg <sup>++</sup>	
Distal convoluted tubule (DCT)	Na <sup>+</sup> , Cl <sup>-</sup> , Water (facultative)	H <sup>+</sup> , K <sup>+</sup> , NH <sub>4</sub> <sup>+</sup> , Uric acid

### Calcium

About 90% of calcium is reabsorbed from the glomerular filtrate. However, the regulation of calcium balance is achieved at the distal convoluted tubules. The major factors regulating calcium reabsorption are parathyroid hormone and vitamin D (see Chapter 39).

### Uric acid

It is almost completely reabsorbed in the proximal convoluted tubules, by both active and passive carrier mediated processes. The drug, probenecid is secreted by the tubule, and competes with uric acid for reabsorption. Since probenecid increases uric acid excretion, it is uricosuric. There is also active secretion of uric acid into the tubules. About 85% of the excreted uric acid is derived by tubular secretion.

### Urea

Urea is freely filtered by the glomerulus, but about 40% is reabsorbed actively by the tubules. Rate of reabsorption of urea varies inversely with tubular flow and accounts for elevation of blood urea when renal function is low. The concentration of urea in urine is about 70 times that of plasma. Urea forms 80% of total urinary solutes. Urine is roughly a 2% solution of urea.

### Creatinine

Creatinine is neither reabsorbed nor secreted. The urinary concentration is about 70% that of plasma.

### Potassium

About 70% of potassium in the glomerular filtrate is reabsorbed by proximal convoluted tubules. Net secretion of  $K^+$  occurs at the distal tubules, in exchange for  $Na^+$  reabsorption, under the effect of aldosterone. However when the  $H^+$  concentration is increased,  $H^+$  ions are exchanged for sodium, instead of  $K^+$ . Table 27.4 gives the urinary excretion of solutes under normal conditions.

## Reabsorption of Water

- The osmolality of urine can vary between 60–1200 mosmol/kg (specific gravity = 1.003 to 1.032), depending on the water intake and state of hydration.
- The GFR is about 125 mL/min. In the proximal convoluted tubules, most of this is reabsorbed. Since  $Na^+$ ,  $Cl^-$  and  $HCO_3^-$  ions are absorbed, water has to move along with the solutes to maintain the osmolality. Hence, this is called **obligatory** reabsorption of water.
- By the time it reaches the loop of Henle, the filtrate is only 25 mL/min. Here sodium is again reabsorbed, but water absorption is less so that, urine, is hypotonic at this level.
- By the time urine reaches distal tubules, the flow rate is reduced to 16 mL/min. Here again water is reabsorbed,

but it is under the influence of ADH. Therefore, this is called **facultative** reabsorption of water.

- ADH secretion, in turn, is controlled by hypothalamic osmoreceptors. The osmolality of plasma is the stimulus for modulating ADH secretion.
- Thus, when urine reaches the collecting ducts, the flow rate is only about 1 mL/min, and the urine is hypertonic. Clinical applications of diuretics are shown in Box 27.3.

**TABLE 27.4:** Normal daily excretion of solutes

Compound	Total daily excretion under normal dietary intake	
Sodium	100–200 mmol	(2–4 g)
Potassium	50–70 mmol	(1.5–2 g)
Magnesium	4–8 mmol	(0.1–0.2 g)
Calcium	1.2–3.7 mmol	(0.1–0.3 g)
Phosphate	20–50 mmol	(0.7–1.6 g)
Chloride	100–250 mmol	
Bicarbonate	0–50 mmol	
Sulfate (inorganic)	40–120 mEq	(0.6–1.8 g)
Sulfate (organic)	—	(0.06–0.2 g)
Urea	15–30 g	(6–18 gN)
Creatinine	1–2 g	(0.3–0.8 gN)
Uric acid	0.5–0.8 g	(0.08–0.2 gN)
Ammonia	30–75 mEq	(0.04–1 gN)
Amino acids		(0.08–0.15 gN)

### Box 27.3: Clinical applications of diuretics

- Osmotic diuretics act by interfering with reabsorption of solute so that more water is obligatorily excreted along with the solute. Osmotic diuretics mainly act at the proximal convoluted tubules, e.g. **mannitol**.
- When carbonic anhydrase is inhibited, the dissociation of  $H_2CO_3$  to  $H_2O$  and  $CO_2$  is not taking place. Net effect is decreased reabsorption of bicarbonate, sodium and water. Thus **acetazolamide**, a carbonic anhydrase inhibitor, will cause diuresis.
- The **thiazide** group of diuretics act on distal convoluted tubules, inhibiting sodium reabsorption and therefore more water is excreted obligatorily.
- Furosemide** acts on the ascending limb of loop of Henle, inhibiting chloride reabsorption along with  $Na^+$  and water. So, chances of  $K^+$  depletion are present.
- Aldosterone antagonists (**Spiranolactone**) and potassium sparing diuretics (amiloride and triamterene) are also used as diuretics both inhibiting sodium reabsorption.
- In **congestive cardiac failure**, diuretics form an important part of therapy. When the heart is not working properly, water from extravascular space is not returning to vascular compartment causing edema (see Chapter 28, under albumin). This extra water may be removed by judicious use of diuretics.



## ABNORMAL CONSTITUENTS OF URINE

In clinical biochemistry, urine is tested and report is given on a urine sample. The procedure is called **urine analysis** or urinalysis. For details of the tests, the student may refer the practical textbook. The routine analysis of urine is the most popular test in hospital practice. The following parameters are usually checked when reporting on a urine sample.

### Physical Characteristics of Urine

- i. **Volume:** The average output of urine is about 1.5 liters per day. Urine volume may be increased in excess water intake, diuretic therapy, diabetes mellitus and in chronic renal diseases. Urine volume may be decreased in excess sweating, dehydration, edema of any etiology, kidney damage. Urine volume 1.5 L/24 h; typical in health, oliguria < 400 mL, anuria < 100 mL, polyuria > 3000 mL
- ii. **Appearance:** See Table 27.5.
- iii. **Odor:** Normal urine has a faintly aromatic smell due to presence of volatile organic acids. Urine in diabetic ketoacidosis may have fruity odor due to acetone.
- iv. **Color:** Normal urine is straw colored (amber-yellow) due to the pigment, urochrome. Presence of bilirubin makes urine yellow in jaundiced patients.
- v. **Specific gravity:** Normal specific gravity of urine is 1.015–1.025. Theoretical extremes are 1.003 to 1.032. The specific gravity will be decreased in excessive water intake, in chronic nephritis and in diabetes insipidus. It is increased in diabetes mellitus, in nephrosis and in excessive perspiration. In chronic renal failure, the specific gravity of urine is fixed at 1010. The earliest manifestation of renal damage may be the inability to produce concentrated urine. A summary of the findings is listed in Table 27.6. The reasons for false positive and false negative tests are shown in Table 27.7.

### Chemical Characteristics of Urine

#### Reaction to Litmus

The pH of urine varies from 5.5 to 7.5. If diet is rich in proteins, sulfuric and phosphoric acids are produced from amino acids, and the urine becomes acidic. If the diet is rich in vegetables, urine is alkaline because the organic acids (citric and tartaric) present in vegetables are converted to bicarbonate in the body.

#### Proteins

- i. Proteinuria is an important index of renal diseases. In normal urine, protein concentration is very low, which can not be detected by the usual tests. These proteins are secreted by the tubular epithelial cells.

**TABLE 27.5: Urine appearance**

Appearance	Significance
1. Clear	Normal urine is straw colored
2. Cloudy/Opalescent	Urine turns cloudy on standing due to precipitation of phosphates on refrigeration Presence of pus causes cloudiness
3. High color	Concentrated urine, Oxidation of urobilinogen to urobilin
4. Yellow	Bilirubinuria in jaundice B-complex intake
5. Smoky red	Presence of blood
6. Brownish red	Hemoglobinuria
7. Orange	High levels of bilirubin; Rifampicin
8. Red	Porphyria; Ingestion of red beet
9. Black urine	Alkaptonuria; Formic acid poisoning
10. Milky urine	Chyluria

**TABLE 27.6: Abnormalities detected in dipstick**

Test and normal range	Interpretations
1. Specific gravity 1.005–1.025	Low SG in renal tubular dysfunction; diabetes insipidus; polydypsia. High SG in inadequate water intake; volume depletion
2. pH 5.5–6.5	Low pH in high protein diet and acidosis, recent meal-alkaline tide, high pH in low protein diet
3. Blood	Menstruation, traumatic catheterization, glomerulonephritis, stones, tumor and trauma of urinary tract hemoglobinuria-hemolysis
4. Protein <150 mg/day	Fever, exercise, orthostatic proteinuria; glomerulonephritis, urinary tract infection, tubular diseases
5. Glucose	Diabetes mellitus, renal glucosuria; Fanconi's syndrome
6. Ketone bodies	Diabetes mellitus, starvation
7. Bilirubin	Hepatitis, obstructive jaundice
8. Urobilinogen <4 mg/day	Concentrated urine; hepatitis; intravascular hemolysis; low in obstructive jaundice
9. Bile salt	Obstructive jaundice
10. Nitrite	Urinary tract infection
11. Leukocyte esterase	Urinary tract infection, fever

- ii. The proteinuria is commonly assessed by the **heat and acetic acid test**. Now dipstick test is replacing the old methods. Microalbuminuria (see last part of this chapter) is detected by radial immunodiffusion or immunoturidimetry methods.
- iii. Measurement of urinary proteins may be carried out to:
- Establish renal disease
  - Define the nature of renal disease
  - Define the degree of renal dysfunction
  - Monitor the response to treatment.
- Proteinuria is described in detail under markers of glomerular permeability.

### Blood

**Hematuria** is seen in nephritis and postrenal hemorrhage. **Hemoglobinuria** is due to abnormal amount of hemolysis. Occultest tablets and Hemastix strips are available for rapid testing of blood in urine.

### Reducing Sugars (Glycosuria)

**Benedict's test** is described in Chapter 10. The test may be used as a semiquantitative method for sugar estimation

in urine. The approximate concentration of sugar will be 0.5 g/100 mL (green), 1 g% (yellow), 1.5 g% (orange) and 2 g% (red). Many substances may occur in urine which will cause reduction of Benedict's reagent. These are listed in Chapter 24. Dipstick is now replacing the old Benedict's test for detection of glucose in urine.

### Ketone Bodies

They are acetoacetic acid, beta hydroxybutyric acid and acetone. Ketonuria is seen in diabetes mellitus, starvation, persistent vomiting, von Gierke's disease and in alkalosis. Ketone bodies are analyzed by **Rothera's test**. Nowadays, ketostix strips are available for rapid test for ketone bodies.

### Bile Salts

Bile salts are present in urine during the early phase of obstructive jaundice (see Chapter 26). Their presence is identified by Hay's test.

### Bile Pigments

Bilirubin appears in urine during obstructive jaundice (see Chapters 21 and 26). It is detected by Fouchet's test.

### Urobilinogen

The oxidation of urobilinogen to urobilin is supposed to be the cause of the deepening of color of urine on standing. In hepatocellular jaundice, urobilinogen is absent in urine. The earliest sign of recovery is the re-appearance of urobilinogen in urine (see Chapter 26). It is identified by Ehrlich test or Schlesinger's test. Normal urine contains only traces of urobilinogen, so that the above two tests are only weakly positive. But, in hemolytic jaundice, where excretion of urobilinogen is increased, these tests will be frankly positive.

In addition to this routine analysis of urine, abnormal metabolites or metabolic intermediates may be tested in specific cases, e.g. amino acids, mucopolysaccharides. The estimation of 24-hour excretion of normal urinary constituent may also be done in specific cases, e.g. calcium in hyperparathyroidism, uric acid in hyperuricemia and phosphate in Fanconi's syndrome.

### Non-protein Nitrogen (NPN)

These include urea, creatinine and uric acid. The major route of excretion of these compounds is urine. In kidney dysfunction, the levels of these compounds are elevated in plasma. Of the three, **creatinine estimation is the most specific** and sensitive index of renal function.

**TABLE 27.7: Alterations in urine test results**

Test	False positive	False negative
SG	Contamination during collection and storage	None
pH	Increased while standing due to urease producing microorganism	
Blood	Hypochlorite; bacterial peroxidase	Ascorbic acid, nitrites
Protein	Fever, concentrated urine; cells; bacteria	Dilution of urine
Glucose	Oxidizing agents	Ascorbic acid
Ketones	Captopril; M-Dopa	Prolonged keeping
Bilirubin	Rifampicin; chlorpromazine	Ascorbic acid, sunlight
UBG	Alkaline urine, sulfonamides	Broad spectrum antibiotics; sunlight
LE	Oxidizing agents Trichomonas	Ascorbic acid Tetracyclins Cephalosporins Nitrofurantoin
Nitrites		Ascorbic acid Mycobacterium

SG = specific gravity; UBG = urobilinogen; LE = leukocyte esterase

Other minor components of NPN are urobilinogen, indican, ammonia and amino acids.

Estimation of NPN along with electrolytes (sodium, potassium) and assessment of acid-base balance are used as a panel of tests to indicate abnormalities in kidney function. Normal blood and urine levels of these parameters are shown in Table 27.8.

## MARKERS OF GLOMERULAR FILTRATION RATE

### Clearance Tests

Measurement of the clearance is predominantly a test of glomerular filtration rate (GFR) (Fig. 27.1). Measurement of glomerular filtration rate (GFR) provides the most useful general index for the assessment of the severity of renal damage. A decrease in the renal function is due to the loss of functional nephrons, rather than a decrease in the function of individual nephron. The relation between clearance value and GFR is shown in Table 27.9 and Figure 27.1. GFR is the product of filtration rate in single nephrons and the number of nephrons in both kidneys. Substantial kidney damage occurs before GFR is decreased.

GFR is also affected by age, sex, body size, protein intake and pregnancy. Normal GFR for young adults is 120–130 mL/mt/1.73M<sup>2</sup>. GFR is constant in a normal individual, but may vary even with normal kidney function. A decline with age is significant and more than 25% of people older than 70 years may have a GFR less than 60 mL/min. This may

**TABLE 27.8:** Common tests to assess kidney function

Constituent	Blood level or Urine excretion	Factors affecting urinary excretion
Urea	B= 15–40 mg/dL U= 15–30 g/day	Dietary proteins, protein catabolism, Renal blood flow
Creatinine	B=0.7–1.4 mg/dL(M) B = 0.4–1.3 mg/dL(F) U = 1–2 g/day	GFR, tubular secretion, age, sex, muscle mass
Uric acid	B= 3–7 mg/dL (M) B = 2–5 mg/dL (F) U= 0.5–0.8 g/day	Purine catabolism, tubular excretion
Sodium	B=135–142 mmol/L	State of hydration, dietary sodium, renal function
Potassium	B=3.5–5 mmol/L	Dietary potassium, acid base balance, renal function
Calcium	B=9–11 mg/dL	Dietary calcium, PTH, calcitonin, renal function

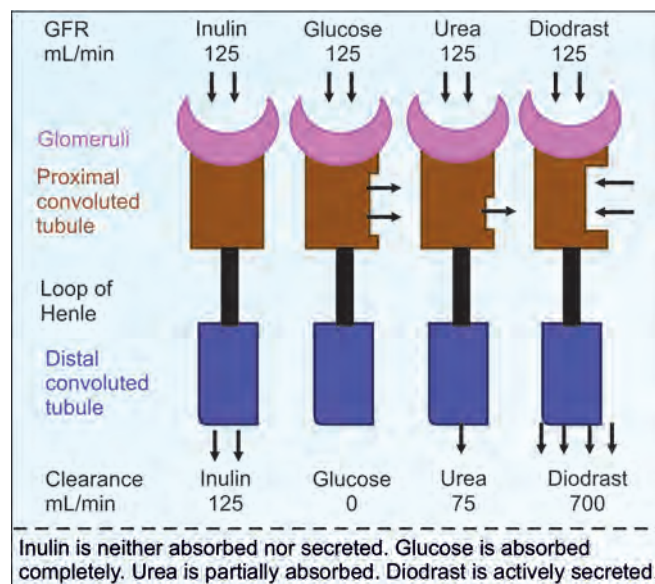
be due to decline with age or any systemic disease that may be coexisting.

GFR cannot be measured directly, it is estimated from the clearance of a filtration marker.

### Definition

- Clearance is defined as the volume of blood or **plasma completely cleared of a substance per unit time**.
- It is expressed as **milliliter of plasma per minute** (not as g or mg).
- Clearance estimates the amount of plasma that must have passed through the glomeruli per minute with complete removal of that substance to account for the substance actually appearing in the urine.

$$\text{Clearance} = \frac{\text{mg of substance excreted per minute}}{\text{mg of substance per mL of plasma}}$$



**Fig. 27.1:** Tubules handle substances differently

**TABLE 27.9:** Relationship of GFR with clearance

Mechanism	Result	Example
Urea	GFR = clearance	Inulin Creatinine
Substances filtered; neither reabsorbed nor excreted	GFR = clearance	Uric acid
Substance filtered; reabsorbed and excreted	Clearance < GFR	Urea
Substances filtered; partially reabsorbed	Clearance > GFR	Diodrast, PAH

It is calculated by using the formula:

$$C = \frac{U \times V}{P}$$

where U = concentration of the substance in urine; P = concentration of the substance in plasma or serum and V = the mL of urine excreted per minute. The value is expressed as mL/minute.

If the substance is freely filtered across the capillary wall, and neither secreted nor reabsorbed, then its clearance is equal to glomerular filtration rate. A substance which meets these requirements is an ideal filtration marker. If the substance is also secreted by the tubules, the clearance exceeds GFR. For those which are reabsorbed by tubules, clearance is less than GFR (Fig. 27.1).

Exogenous markers are inulin,  $^{51}\text{Cr}$ -labeled EDTA,  $^{99}\text{Tc}$ -labeled EDTA, etc. These are not used in clinical practice, since it involves administration of extraneous compounds.

Endogenous markers are urea and creatinine. None of these markers are ideal, but creatinine is the best out of all of them.

## Creatinine Clearance Test

### Importance of Creatinine Clearance

- i. Creatinine is a waste product, formed from creatine phosphate (see Chapter 16). This conversion is **spontaneous, non-enzymatic**, and is dependent on total muscle mass of the body. It is not affected by diet, age or exercise. Women and children excrete less creatinine than men, because of their smaller muscle mass. About 98% of creatine pool is in muscle. About 1.6% is converted to creatinine per day, which is rapidly excreted (Box 27.4).
- ii. Since the production is continuous, the blood level **will not fluctuate** much, making creatinine an ideal substance for clearance test.
- iii. Since creatinine excretion is a **constant** in a particular person, the urine creatinine is sometimes used to check whether the 24 hours urine sample does actually contain total urine volume or not. This is important when urine is collected from children and mentally retarded persons.
- iv. In order to circumvent the difficulty of urine collection, nowadays it is customary to express urinary concentration of other substances per gram of creatinine rather than per 24 hours urine.

### Reference Values of Creatinine

Adult males, 0.7 – 1.4 mg/dL

Adult females, 0.6 – 1.3 mg/dL

Children, 0.4 – 1.2 mg/dL.

The kidney reserve is such that about 50% kidney function must be lost before creatinine level in blood is raised. Serum level usually parallels the severity of the disease.

*Creatinine level more than 1.5 mg/dL indicates impairment of renal function.* Creatinine is quantitated by **Jaffe's test** (alkaline picrate). Test kit based on specific enzymatic reaction is also available.

### Procedure for Creatinine Clearance Test

Give 500 mL of water to the patient, to promote good urine flow. After about 30 minutes, ask to empty the bladder and discard the urine. Exactly after 60 minutes, again void the bladder and collect the urine, and note the volume. Take one blood sample. Creatinine level in blood and urine are tested and calculated.

$$\text{Uncorrected clearance} = (U/P) \times V$$

where U is the urine creatinine concentration, P is the plasma creatinine concentration and V is the urine flow in mL/min (The 24-hour urine collection is not necessary for the creatinine clearance test).

#### Box 27.4: Advantages and disadvantages of using creatinine clearance test as a GFR marker

##### Advantages

1. Extrarenal factors will rarely interfere.
2. Conversion of creatine phosphate to creatinine is spontaneous, non-enzymatic.
3. As the production is continuous, the blood level will not fluctuate. Blood may be collected at any time.
4. It is not affected by diet or exercise.

##### Disadvantages

1. Creatinine is filtered by glomeruli, and actively excreted by the tubules. Of the total excretion, about 10% is by tubular component. When the GFR is reduced, the secretion component is increased, and will viciate the results. The creatinine clearance is said to overestimate GFR by about 10–20 mL/min.
2. When GFR is severely reduced, extrarenal excretion increases. Then the major route becomes the degradation by intestinal bacterial flora.
3. Very early stages of decrease in GFR may not be identified by creatinine clearance (creatinine blind area).
4. Other prerenal, renal and postrenal causes will influence creatinine clearance (see under urea clearance).



It is useful to correct the clearance value with body surface area. This is important, especially in children, and persons with short or tall frame. Creatinine clearance corrected for surface area could be calculated as:

$$\frac{U \times V \times 1.73}{P \times A}$$

Reference values for creatinine level in blood and the creatinine clearance are shown in Table 27.10. When corrected for surface area, the creatinine clearance value will become comparable between males, females and children, which is about 100 mL/min/1.73 sq meter.

### Interpretation of Creatinine Clearance

- A decreased creatinine clearance is a very sensitive indicator of reduced **glomerular filtration rate**. Factors which will alter the creatinine level are indicated in Table 27.11.
- Clearance value up to 75% of the average normal value may indicate adequate renal function. In older people, the clearance is decreased.
- The importance of creatinine clearance is in the **early detection** of functional impairment of kidney without overt signs and symptoms. Changes in plasma creatinine which may not apparently indicate abnormal function may show gross changes in the value of clearance. For example, suppose the plasma creatinine level is 1 mg/dL and the clearance is 100 mL/minute. A rise in plasma creatinine by another mg (=2 mg/dL) will decrease the clearance value by 50%. Other substances will not show such a drastic drop in the clearance values.
- The test is very helpful in long term monitoring of patients with renal insufficiency (ups and downs) under a protein restricted diet.

### Estimated GFR (eGFR)

A simpler technique of estimating creatinine clearance and there by GFR is by using serum creatinine level. This would eliminate the need for timed urine collections. A commonly used formula is **Cockcroft-Gault equation**.

**TABLE 27.10:** Normal reference values

	Serum creatinine	GFR
Adult male	0.7 – 1.4 mg/dL	95 – 115 mL/min
Adult female	0.6 – 1.3 mg/dL	85 – 110 mL/min
Children	0.5 – 1.2 mg/dL	

$Ccr = (140 - \text{age in years}) \times \text{weight in Kg} (0.85 \text{ in females})/72 \times Pcr \text{ in mg/dL}$

The factor 0.85 is used in females assuming that they have 15% less muscle mass. The issue of overestimation cannot be eliminated by this calculation.

A more recent equation used in the MDRD (Modification of Diet in Renal Disease) study is more accurate. This equation directly estimates GFR.

The estimated GFR (eGFR) (mL/min/1.73m<sup>2</sup>) =  $186 \times (\text{Creatinine}/88.4) - 1.154 \times (\text{Age}) - 0.203 \times 0.742$  (if female)

eGFR can be used for staging of patients with chronic kidney disease. eGFR can only be used accurately in patients with chronic kidney disease and neither in healthy individuals, nor in children and obese people. The accuracy of plasma creatinine estimation is a major deciding factor in both equations.

### Creatinine Co-efficient

It is the urinary creatinine expressed in mg/kg body weight. The value is elevated in muscular dystrophy. Normal range is 20–28 mg/kg for males and 15–21 mg/kg for females.

### Cystatin C as a Filtration Marker

It is a marker which has advantages over serum creatinine. Cystatin C is a 13 kD (120 amino acids) non-glycosylated protein. Normal blood level of cystatin is 0.8 to 1.2 mg/L. It is seen in high concentrations in biological fluids, such as breast milk, tears, saliva and semen. It is expressed in virtually all organs of the body. It is the most abundant extracellular Cysteine protease inhibitors.

Creatinine is the most widely used biomarker of kidney function. But sometimes, it is inaccurate in detecting mild renal impairment. The tubular secretion contributes approximately 20% of the total creatinine excretion by the kidney, and this contribution can increase as GFR decreases. Serum creatinine does not increase until the GFR has moderately decreased. This insensitivity to moderate decreases in GFR is called **creatinine blind GFR area** (40–70 mL/min/1.73 m<sup>2</sup>).

**TABLE 27.11:** Factors affecting serum creatinine

Factors reducing serum creatinine	Factors increasing serum creatinine
Low muscle mass	Old age
Females	Males
Malnutrition	Renal diseases
Medicines	Glomerulonephritis
Thiazide	Pyelonephritis
Vancomycin	Renal failure
	Urinary obstruction
	Congestive cardiac failure
	Dehydration, shock
	Medicines
	Amphotericin B
	Cephalosporins
	Kanamycin

So, serum creatinine may not be a good parameter for determination of GFR, especially at lower levels of glomerular function.

On the other hand, Cystatin C is produced at a constant rate and is freely filtered by kidney glomeruli. It is completely reabsorbed; but degraded in the tubules; thus making it an excellent GFR marker. The blood levels are not dependent on age, sex, muscle mass or inflammatory processes. It is sensitive to changes in the so-called creatinine blind area of GFR (40–70 mL/min/1.73m<sup>2</sup>). So, serum level of cystatin is a better test for kidney function (GFR) than serum creatinine levels. Since, there is no tubular secretion of Cystatin C, it is extremely sensitive to minor changes in GFR in the earliest stages of chronic kidney diseases.

### Chronic Kidney Disease (CKD)

GFR < 60 mL/min/1.73 m<sup>2</sup> for 3 months or more with or without kidney damage indicates CKD. GFR calculated from serum creatinine and MDRD equation are used to grade CKD (Table 27.12A).

CKD is a silent killer, incidence is increasing worldwide. CKD is the progressive loss of renal function. CKD is a growing problem that affects approximately 12 % of the adult population. Kidney disease is very common, but silent, and progresses very slowly. Major risk factors of CKD are diabetes mellitus, hypertension, glomerular nephritis, urinary tract infection, autoimmune diseases, kidney stones and toxic effects of some drugs. Markers for CKD are serum creatinine, eGFR, microalbumin and Cystatin C. Cystatin C concentration contributes independently in predicting the risk of cardiovascular death or myocardial infarction (Tables 27.12A and B).

### Acute Kidney Injury (AKI)

AKI is the abrupt kidney dysfunction, usually due to renal tubular cell injury. It is characterized by rapid rise of serum creatinine and

**TABLE 27.12A:** Grading of chronic kidney disease

State	Grade	GFR mL/mt/1.73 m <sup>2</sup>
Minimal damage with normal GFR	1	>90
Mild damage with slightly low GFR	2	60–89
Moderately low GFR	3	30–59
Severely low GFR	4	15–29
Kidney failure	5	< 15

**TABLE 27.12B:** Kidney failure, early symptoms

Polyuria (passing more urine)
Nocturia (passing more urine during night)
Pedal edema, puffiness of face
High blood pressure
Unexplained anemia
Fatigue, lassitude and tiredness
Microalbuminuria
Mild elevation of serum creatinine

low urine output. Onset of AKI can be swift and often deadly. In AKI, serum creatinine (sCr), the current standard for assessing kidney function, can take hours or days to respond to acute kidney damage. Novel biomarkers of tubular injury, such as neutrophil gelatinase-associated lipocalin (NAGL), kidney injury molecule-1 (KIM-1), liver fatty acid binding protein (LFABP), and interleukin-18 (IL-18) may enable the early detection of acute kidney injury before or in the absence of a change in GFR. Out of these, urinary neutrophil gelatinase-associated lipocalin (uNGAL) is found to be the best to predict acute kidney injury. The uNGAL could be most useful when sCr is in the middle range. NAGL is a small molecule (molecular weight 25 kDa). It is found in neutrophils as well as in renal tubular epithelium, where its expression is dramatically increased in ischemic or nephrotoxic injury.

### New Biomarkers for Kidney Diseases

In patients with chronic kidney disease (CKD), blood levels of fibroblast growth factor-23 (FGF-23) rise in parallel with declining kidney function. FGF-23 inhibits renal reabsorption of phosphate, and excess phosphate has been shown to be associated with mortality. In patients with early stage CKD, FGF-23 showed a strong link to both end stage renal diseases (ESRD) and death. FGF-23 is linked with mortality than reduced eGFR and proteinuria. This suggests that FGF-23 is an extremely powerful biomarker.

### Urea Clearance Test

#### Importance of Urea Clearance

The urea clearance is less than GFR, because urea is partially reabsorbed (Fig. 27.1). Urea clearance is the number of mL of blood, which contains the urea excreted in a minute by kidneys.

#### Procedure

Allow the patient to have a normal breakfast. At 9 AM give a cup of water and the patient is instructed to void the bladder, and urine is discarded. At 10 AM bladder is completely emptied and the volume of urine is measured and the urine urea is estimated. A blood sample is taken and blood urea is also estimated.

#### Maximum Urea Clearance

The urea clearance is calculated by the formula

$$U \times V/P$$

where U = mg of urea per mL of urine; P = mg of urea per mL of plasma and V = mL of urine excreted per minute. This is called maximum urea clearance and the normal value is found to be 75 mL/min.

### Standard Urea Clearance

But the clearance value is decreased when V, the volume of urine, is less than 2 mL/min. Then, it is called standard urea clearance, where the normal value is found to be 54 mL/min, and is calculated as:

$$\frac{U \times \sqrt{V}}{P}$$

### Interpretation of Urea Clearance Value

- If the value is below 75% of the normal, it is considered to be **abnormal**. The values fall progressively with failing renal function.
- The clearance value may be abnormal even though the plasma urea values are within normal limits. The plasma urea values will start to rise only when the clearance value falls below 50% of the normal.
- Urea is normally reabsorbed from renal tubules and therefore, tubular function also affects urea clearance. Hence, creatinine clearance test is more preferred.
- Urea is freely filtered by the glomerulus and passively reabsorbed in both PCT and DCT. Urea clearance is less than GFR (Fig. 27.1).

## Blood Urea Level

### Normal Serum Urea Level

- Normal value is 20 – 40 mg/dL. Estimation of urea is done by enzymatic method using urease and glutamate dehydrogenase.
- Serum urea is sometimes expressed in terms of its nitrogen, because nitrogenous substances were analyzed by Kjeldahl method. Such expression of Urea-N or **blood urea nitrogen** (BUN) is very common in USA. Molecular weight of urea is 60 and each gram mol of urea contains 28 gram of nitrogen. Thus a serum concentration of 28 mg/dL of BUN is equivalent to 60 mg/dL of urea or 10 mmol/L of urea. BUN can be converted into urea by multiplying the figure by 2.14.

### Interpretation of Blood Urea Value

Urea is the end-product of protein metabolism (see Chapter 14). The serum concentration of urea generally increases as the **age** advances. The lower range is usually seen in young adults and the upper limit is normal for elderly people. Therefore, a value of 40 mg/dL in a patient of 25 years may be considered as suspicious, while the same value in a person of 60 years can be considered as perfectly normal. Causes for increased blood urea are enumerated in Box 27.5.

### Renal Diseases

- Serum urea is increased in all forms of kidney diseases. In **acute glomerulonephritis** values may be as high as 300 mg/dL.
- In early stages of **nephrosis**, serum urea may be normal, but in late stages serum urea increases along with decreasing renal function.
- In malignant **hypertension** and in chronic **pyelonephritis**, the values may reach very high levels. Prerenal and postrenal causes are shown in Box 27.5.

### Decreased Blood Urea

Urea concentration in serum may be low in late pregnancy, in starvation, in diet grossly deficient in proteins and in hepatic failure.

### Azotemia

Increase in the blood levels of NPN is referred to as azotemia and is the hallmark of kidney failure. BUN/Creatinine ratio can be used as a discriminator between prerenal and postrenal azotemia. A normal adult on a normal diet has a ratio between 12 – 20 mg BUN/mg of creatinine. Lower ratios denote acute renal tubular necrosis, low protein intake, starvation and severe liver disease. High plasma urea with normal creatinine and high BUN/creatinine ratio indicates prerenal azotemia. High ratios with high urea and creatinine suggests postrenal obstruction or prerenal azotemia superimposed on CKD.

### Uremic Syndrome

It is the terminal manifestation of renal failure. The effects of a group of toxins contribute to this situation. Increased urea will lead

#### Box 27.5: Causes for increased blood urea

- Prerenal conditions:
  - Dehydration: Severe vomiting, intestinal obstruction, diarrhea
  - Diabetic coma and severe burns
  - Fever and severe infections
- Renal diseases:
  - Acute glomerulonephritis
  - Nephrosis
  - Malignant hypertension
  - Chronic pyelonephritis
- Postrenal causes:
  - Stones in the urinary tract
  - Enlarged prostate
  - Tumors of bladder
- Medications:
  - ACE inhibitors
  - Acetaminophen
  - Aminoglycosides
  - Amphotericin B
  - Diuretics
  - NSAIDs

to carbamylation of proteins; increased uric acid causes uremic pericarditis; excess polyols is the basis of peripheral neuropathy; Beta-2 microglobulin is the reason for renal amyloidosis. When renal function fails, the assessment of residual renal function is done by a variety of tests (Box 27.6).

### Inulin Clearance

Inulin is a polysaccharide of fructose. It is not appreciably metabolized by the body. It is neither absorbed nor secreted by the tubules. Therefore, inulin clearance is a measure of GFR. The value of GFR as measured by inulin clearance is 125 mL/min. About 100 mL of sterile 10% solution of inulin is given as slow intravenous drip within 2 hours. Urine specimen formed during this period is collected totally. Blood sample is taken at the middle of the test. Inulin is estimated by resorcinol giving a red color. The test needs continuous infusion of inulin so as to keep the plasma level adequate. Since it involves administration of an extraneous compound, this procedure is not used routinely.

Inulin clearance (GFR) = 125 mL/min and urea clearance = 75 mL/min.

Therefore,

$$\frac{\text{inulin clearance} - \text{urea clearance}}{\text{glomerular filtration rate}} = \frac{125 - 75}{125} = 0.4$$

In other words, 40% of urea present in the glomerular filtrate is reabsorbed in the tubules.

### Diodrast Clearance

Diodrast is otherwise known as di-iodo pyridone acetic acid. It is a contrast medium usually used in taking X-ray of urinary tract. Diodrast and PAH (para-amino hippurate) are filtered and excreted, so that these substances are removed by one passage of the blood through kidney. PAH clearance is a measure of **renal plasma flow**. It is about 700 mL of plasma or 1200 mL of blood per minute and is about 1/4th of the total cardiac output.

Since, renal plasma flow is 700 mL/min and the GFR is 125 mL/min, it is obvious that about 1/5th of the plasma brought to the glomeruli becomes the glomerular filtrate. This is called the **filtration fraction**.

## MARKERS OF GLOMERULAR PERMEABILITY

The glomerulus acts as a selective filter of the blood passing through its capillaries. Passage of macromolecules is restricted based on their charge, size and shape. Molecules smaller than 5 kD, such as urea, glucose, creatinine and

electrolytes are freely filtered by the glomerulus. The glomerular membrane is such that albumin (mol wt 69 kD) is retained in the blood, but free hemoglobin (mol wt 67 kD) is filtered and excreted in urine.

The low molecular weight proteins are freely filtered, reabsorbed and catabolized by renal tubular cells. Normal urinary protein excretion is less than 150 mg/24 hours, made up of mostly **Tamm Horsfall glycoprotein**. The urine protein estimations are done by immunochemical methods. The appearance of significant quantities of proteins like albumin indicates increased glomerular permeability.

### Proteinuria

It may be of the following types:

- Increase in filtered load due to glomerular damage and vascular permeability—This is called glomerular proteinuria.
- Increased circulating concentration of low molecular weight proteins—(Overflow proteinuria).
- Decrease in reabsorptive capacity due to tubular damage—(Tubular proteinuria).

### Glomerular Proteinuria

The glomeruli of kidney are not permeable to substances with molecular weight more than 69,000 and so plasma proteins are absent in normal urine. When glomeruli are damaged or diseased, they become more permeable and plasma proteins may appear in urine. The smaller molecules of albumin pass through damaged glomeruli more readily than the heavier globulins. Albuminuria is always pathological. Large quantities (a few grams per day) of albumin are lost in urine in nephrosis. Small quantities are seen in urine in acute nephritis, strenuous exercise and pregnancy.

Overnight first voided sample (early morning urine-EMU) may be used for the measurement of protein. An EMU is preferred since it rules out the possibility of orthostatic albuminuria. Protein Creatinine ratio is calculated to decide whether the patient has nephrotic range proteinuria (>3.5) or not. The calculation of ratios is found to give better predictability of chronic kidney disease (CKD). Detection limit with Dipstick is 200–300 mg/L.

300 mg/day = Benign proteinuria  
300 mg – 1000 mg = Pathological proteinuria  
> 1000 mg/day = Glomerular proteinuria

Indications for quantitation are shown in Box 27.7.

#### Box 27.6: Parameters for residual renal function

Excretory function:	NPN – Plasma levels of urea, creatinine, uric acid
Endocrine function:	Hemoglobin, calcium and phosphate
Homeostasis:	pH and electrolytes; sodium, potassium, bicarbonate and chloride



### Microalbuminuria

It is also called minimal albuminuria or paucialbuminuria. It is identified, when small quantity of albumin (30–300 mg/day) is seen in urine. The test is not indicated in patients with overt proteinuria (+ve dipstick). Early morning midstream sample is preferred.

Microalbuminuria is an early indication of nephropathy in patients with diabetes mellitus and hypertension. Hence, all patients who are known diabetics and hypertensive should be screened for microalbuminuria. It is an early indicator of onset of nephropathy. The test should be done atleast once in an year.

It is expressed as **albumin-creatinine ratio**; normal ratio being,

Males < 23 mg/g of creatinine

Females < 32 mg/g of creatinine

Patients showing higher values on more than one occasion are considered to have microalbuminuria. Confirmed by overnight urine collection and calculation of albumin excretion rate. A value more than 20 µg/min confirms microalbuminuria. Administration of ACE inhibitors decreases the rate of microalbuminuria.

The selectivity of the membrane provides an assessment of glomerular damage. Protein selectivity index is the relative proportion of higher to lower molecular weight protein (Box 27.8). Microalbuminuria is detected by radial immunodiffusion or by enzyme linked immunosorbent methods.

### Overflow Proteinuria

When small molecular weight proteins are increased in blood, they overflow into urine. For example, hemoglobin having a molecular weight of 67,000 can pass through normal glomeruli, and therefore, if it exists in free form

(as in hemolytic conditions), hemoglobin can appear in urine (**hemoglobinuria**). Similarly, myoglobinuria is seen following muscle crush injury.

Yet another example is the Bence-Jones proteinuria. In about 20% cases of multiple myeloma (plasmacytoma), the light chains of immunoglobulins are produced abnormally. Being of smaller molecular weight, they are excreted in urine. These are called **Bence-Jones Proteins** (monoclonal light chains produced by plasmacytomas) (Chapter 49). When the urine is heated, at 45°C they start precipitating, at 60°C there is maximum precipitation, at 80°C these proteins start redissolving, and will form a clear solution at 100°C. The precipitate reforms on cooling. It is also detected by immunoprecipitation.

### Tubular Proteinuria

This occurs when functional nephrons are reduced, GFR is decreased and remaining nephrons are over-working. The tubular reabsorption mechanism is impaired, so low molecular weight proteins appear in urine. They are retinol binding protein (RBP) and alpha-1 microglobulin. Both are synthesized in liver and are readily filtered by the glomerulus. Tubular damage results in the release of intracellular components to the urinary tract and may be used as markers of tubular damage, e.g. beta-D-glucosaminidase, lysozyme.

### Nephron Loss Proteinuria

In CKD, there is a decrease in the number of functioning nephrons. The compensatory rise in glomerular filtration by other nephrons increases the filtered load of proteins. Even if there are no glomerular permeability changes, tubular proteinuria is seen.

### Urogenic Proteinuria

This is due to inflammation of lower urinary tract, when proteins are secreted into the tract. Accumulation of proteins in tubular lumen can trigger inflammatory reaction.

#### Box 27.7: Indications for quantitation of proteinuria

1. Diagnosis of nephrotic syndrome—Nephrotic syndrome is a triad of edema, hypoalbuminemia and proteinuria > 3 g/day. 24 hours urine protein, creatinine clearance and sodium should be measured for planning appropriate treatment.
2. Prognosis of progressive renal disease—It is a marker for assessing the progressive loss of renal function in renal disease; diabetic nephropathy, chronic glomerulonephritis, reflux nephropathy. Treatments that reduce proteinuria (like antihypertensive drugs) decrease rate of progression.
3. Diagnosis of early diabetic nephropathy—Early stages of diabetic nephropathy are characterized by increase in GFR, microalbuminuria and hypertension.

#### Box 27.8: Protein selectivity index

With more severe dysfunction in glomerular permeability, larger protein molecules get excreted in urine. In children, minimal change nephropathy causes selective proteinuria; non-selective proteinuria raises the possibility of other types of renal diseases. In adults, measurement of selectivity is of no apparent benefit.

Albumin/IgG clearance =  

$$\frac{\{\text{Urine [IgG]} \times \text{Serum [Albumin]}\}}{\{\text{Serum [IgG]} \times \text{Urine [Albumin]}\}} \times 100$$

Similarly, Transferrin/IgG clearance =  

$$\frac{\{\text{Urine [IgG]} \times \text{Serum [Transferrin]}\}}{\{\text{Serum [IgG]} \times \text{Urine [Transferrin]}\}} \times 100$$

A ratio of < 0.16 indicates highly specific proteinuria.

## TESTS FOR TUBULAR FUNCTION

### Specific Gravity of Urine

The simplest test of tubular function is the measurement of the specific gravity (SG) of urine. This is an indication of osmolality.

Specific gravity depends on the concentration of solutes, whereas osmolality depends on the number of osmotically active particles. Hence, in cases of proteinuria, the specific gravity is elevated considerably, but osmolality is only mildly elevated.

In moderate forms of kidney damage, the blood level of urea and creatinine may be within the normal limits. The inability to excrete the waste products may be counterbalanced by large urine output. Thus the **earliest manifestation** of renal disease may be difficulty in concentrating the urine.

### Measurement of Osmolality

The osmolality of urine samples vary widely from 60 mosmol/kg to 1200 mosmol/kg. A random urine sample may have an osmolality around 600 mosmol/kg and it increases to 850 after 12 hours fluid restriction. Simultaneous measurements of plasma and urine osmolality and calculation of the ratio of osmolality of urine/plasma is more helpful. Normally the ratio varies from 3–4.5. The normal value of plasma osmolality is 285–300 mosmol/kg. Osmolality is measured with an osmometer based on the depression of the freezing point of the sample. Patients with deficiency of ADH (Central diabetes insipidus) or a decreased response to ADH (Nephrogenic diabetes insipidus) will excrete urine with osmolality less than 300 mosmol/kg (Table 27.13).

### Concentration Test

- i. The patient is allowed no food or water after a meal at 6 PM. The next day at 7 AM, the bladder is emptied and specimen is discarded. A second specimen is collected at 8 AM and the specific gravity is measured.

**TABLE 27.13:** Osmolality in response to ADH

Condition	Urinary osmolality	Plasma osmolality	Response to ADH
Diabetes insipidus (central)	Decreased	Increased	Normal
Diabetes insipidus (nephrogenic)	Decreased	Increased	No response
Compulsive water drinking	Decreased	Decreased	Normal
Osmotic diuresis	Normal	Normal	Normal

- ii. If the specific gravity is more than 1.022 (osmolality exceeds 850 mosmol/kg), the patient has adequate renal function.
- iii. In normal persons, the SG may be as high as 1.032. During the concentration test osmolality should exceed 750 mosmol/kg.
- iv. As the disease progresses the urine specific gravity is fixed at and around 1.010 (300 mosmol/kg). It is then called **isosthenuria**.
- v. The measurement of the volume of urine excreted during the day and the night is another simple index of tubular function. Normally, night volume is only half of the day volume. But an increased excretion of urine at night or **nocturia** is an early indication of tubular dysfunction.
- vi. The concentrating capacity of the renal tubules can be assessed by measuring the specific gravity of EMU. A value of 1018 or more indicates normal renal concentrating capacity.

### Dilution Tests

The patient is not allowed to drink any water after midnight. Bladder is emptied at 7 AM and a water load is given (1200 mL over the next 30 minutes). Hourly urine samples are collected for the next 4 hours separately. Volume, specific gravity and osmolality of each sample are measured. A normal person will excrete almost all the water load within 4 hours and the specific gravity of at least one sample should fall to 1.003 and osmolality to 50 mosmol/kg. The test is more sensitive and less harmful than concentration test.

### Urinary Acidification

- i. The **most useful test** is acid loading test. It is indicated in unexplained hyperchloremic metabolic acidosis. Acidification defects may occur due to generalized tubular defects or due to genetically determined defects in ion pumps.
- ii. Give ammonium chloride at a dose of 0.1 g/kg body weight. It is given as an enteric coated preparation to decrease gastric irritation and vomiting. The ammonium chloride ( $\text{NH}_4\text{Cl}$ ) is dissociated into  $\text{NH}_4^+$  and  $\text{Cl}^-$ . In the liver the  $\text{NH}_4^+$  is immediately converted into urea. Therefore,  $\text{Cl}^-$  ions are counter balanced by  $\text{H}^+$  to produce  $\text{HCl}$ , a powerful acid. It is then excreted through urine so as to produce acidification. Urine is

collected hourly, from 2 to 8 hours after ingestion. The pH and acid excretion of each sample is noted. At least one sample should have a pH of 5.3 or less and ammonia excretion should be 30–90 mmol/hr.

- iii. In chronic renal failure the pH may be low, due to coexisting metabolic acidosis, but the ammonia excretion is less. In renal tubular acidosis, the pH 5.3 is not achieved. Liver disease is a contraindication to perform this test.

### Fractional Excretion of Bicarbonate

$(FE_{HCO_3}) = \{(\text{Urine } [HCO_3] \times \text{Plasma } [Creatinine]) / (\text{Plasma } [HCO_3] \times \text{Urine } [Creatinine])\} \times 100$ . Normal  $FE_{HCO_3}$  is < 15%. A level of > 20% confirms Type 2 (proximal) renal tubular acidosis.

### Fractional Excretion of Sodium (FENa)

It is the sodium clearance as a % of creatinine clearance. It is calculated as  $UNa/PNa/Ucr/Pcr \times 100$

When tubular conservation of Na is lost, FENa increases to greater than 3% of Ccr. FENa is <35% in prerenal and >50% in acute tubular necrosis. During hypovolemia, FENa decreases to less than 1% of Ccr. A spot urine sample and blood sample drawn at the same time is used for sodium and creatinine estimation.

### Fractional Excretion of Phosphate ( $FE_{PO_4}$ )

It is used in the diagnosis of hypophosphatemia (e.g. X-linked hypophosphatemic rickets).

Fractional phosphate excretion ( $FE_{PO_4}$ ) =  $C_p/C_{Cr} = (\text{Serum } [Creatinine] \times \text{Urine } [Phosphate]) / (\text{Urine } [Creatinine] \times \text{Serum } [Phosphate])$

**Fractional tubular reabsorption of phosphate (TRP)** is calculated as  $1 - FE_{PO_4}$

**Tubular maximum for phosphate reabsorption (TmP/GFR)** can be calculated as:

If  $TRP < 0.86$ ,  $TmP/GFR = TRP \times \text{Plasma P}$ .

If  $TRP > 0.86$ ,  $TmP/GFR = \{0.30 \times TRP / [1 - (0.8 \times TRP)]\} \times \text{Plasma Phosphate}$ .

Adult normal range for TmP/GFR is 0.80 – 1.35 mmol/L. Higher normal values are seen in children and infants. Low values are classically seen in X-linked hypophosphatemic rickets and in Osteogenic osteomalacia. Both disorders are due to overproduction or failure of inactivation of **phosphatonin**, a phosphaturic hormone.

TmP/GFR is increased in hypoparathyroidism. TmP/GFR is decreased in hyperparathyroidism. Reduced phosphate reabsorption seen in hypercalciuric stone formers as well as in other primary and secondary disorders of renal tubular function.

A summary of renal function tests is shown in Table 27.14.

### Immunological Tests in Renal Diseases

Tests done include:

1. Complement components
2. Immunoglobulins and serum electrophoresis for paraproteinemias
3. Cryoglobulins
4. Antineutrophil cytoplasmic antibodies (ANCA)
5. AntiGBM antibody
6. Free light chain assay with kappa: lambda ratio

Findings of complement tests are shown in Table 27.15.

Indications of testing complement are:

1. Acute nephritis syndrome
2. Renal failure with skin/neurological involvement
3. Suspected SLE
4. Endocarditis
5. Cryoglobulinemia

### Cryoglobulinemia

These are immunoglobulins precipitated on cooling, and redissolving on warming. Box 27.9 shows the conditions in which cryoglobulinemia is associated. Test for cryoglobulinemia is done in

1. Renal failure with unexplained hypocomplementemia or positive rheumatoid factor
2. Renal failure in association with skin and neurological involvement
3. Unexplained renal failure and proteinuria in patients
4. Raynaud-like symptoms due to complexes blocking blood vessels.

**TABLE 27.14:** Summary of renal function tests

Glomerular dysfunction		Tubular dysfunction	
Serum urea	↑	Urine concentration	↓
Serum creatinine	↑	Dilution test	abnormal
Inulin clearance	↓	Uric acid excretion	↓
Creatinine clearance	↓	Blood uric acid	↑
Urea clearance	↓		
PAH clearance	↓	Acidification of urine	↓
Proteinuria	present	Amino aciduria	present
Urine volume	↓	Urine volume	↑
Specific gravity	↑	Specific gravity	↓
Serum phosphate	↓	Serum phosphate	↓

**TABLE 27.15:** Pattern of complement in diseases

	C3	C4
Poststreptococcus GN	Low	Normal
SLE	Low	Low
Cryoglobulinemia	Low	Very low
Membranoproliferative	Low	Low
Subacute endocarditis	Low	Low

*Abbreviations:* C = complement; GN = glomerulonephritis; SLE = systemic lupus erythematosus.

### Antineutrophil Cytoplasmic Antibody (ANCA)

Autoantibodies directed against enzymes present in cytoplasm of human neutrophils. They are seen in all patients with small vessel vasculitis like Wegener's granulomatosis, Microscopic polyangeitis and crescentic glomerulonephritis. Negative ANCA does not rule out vasculitis, and false positive may also occur. Immunofluorescence is used to detect these antibodies. It is positive in small vessel vasculitis. Non-specific ANCA elevation may be seen in systemic infections and other autoimmune diseases.

### Antiglomerular Basement Membrane Antibody

Anti-GBM antibody is seen in acute nephritic syndrome as well as in Goodpasture's syndrome, where autoantibody against type IV collagen is found in the glomerular basement membrane and lungs. It causes rapidly progressive GN and lung hemorrhage. A negative test does not rule out disease, and renal biopsy may be needed.

### Clinical Case Study 27.1

A 55-year-old hypertensive complaints of dry, painful eyes and xerostomia for a few weeks. On examination, he was afebrile, BP 140/94 mm Hg, pulse 80/min. Facial and lower limb edema was present. Investigation results are – Fasting blood sugar 280 mg/dL, urine Benedict's test red precipitate, urine proteins +++, serum albumin 2.0 g/dL, serum cholesterol 280 mg/dL, serum creatinine 2.0 mg/dL, blood urea 120 mg/dL. Serum immunoglobulins were normal, tests for hepatitis antigens were negative, culture for bacteria and fungi revealed no growth. Serum electrophoresis showed increased  $\alpha$ -2 band. What is the possible diagnosis?

#### Box 27.9: Cryoglobulinemia are seen in

1. Chronic infections
  - Cytomegalo virus
  - Hepatitis C virus
  - Leprosy
  - Poststreptococcal glomerulonephritis
2. Malignancies
  - Chronic myeloid leukemia
  - Hodgkin's disease
  - Lymphoma
  - Multiple myeloma
  - Waldenstrom's macroglobulinemia
3. Autoimmune disease
  - Raynaud's disease
  - Rheumatoid arthritis
  - Scleroderma
  - Sjogren's syndrome
  - Systemic Lupus Erythematosis
  - Tropical splenomegaly syndrome

### Clinical Case Study 27.2

A 50-year-old patient was admitted for treatment of sore throat and pneumonia. He had poorly controlled diabetes mellitus and on admission blood urea was 140 mg/dL and serum creatinine was 2.8 mg/dL. He received 2.0 L fluid, but blood urea rose to 160 mg/dL and serum creatinine to 3.0 mg/dL. Urine output which was initially good dropped to 500 mL over a 24 hours period. Next day, he developed shortness of breath and lower extremity edema. Blood urea rose to 300 mg/dL and serum creatinine to 6.3 mg/dL. What is the probable diagnosis?

### Clinical Case Study 27.3

A 50-year-old man was admitted with loss of appetite, nausea, vomiting, difficulty of breathing and fatigue. History revealed that he had similar symptoms 5 years back and was diagnosed with hypertension and kidney failure. On examination, temperature was 36.8°C, respiratory rate was 22/min, pulse rate 64/min, BP was 170/100 mm Hg, marked pallor was present, chest and lungs showed bilateral basal rales, abdomen was soft, flat and tender. No other abnormality was detected. Patient was an occasional alcoholic, and a chronic smoker.

Laboratory investigations showed—Blood urea 65 mg/dL, serum creatinine 2.4 mg/dL, serum calcium 6.4 mg/dL, serum potassium 4.9 mg/dL, and serum sodium 139 mmol/L. Urine examination results were – Color straw colored, pH 5.0, specific gravity 1.020, appearance turbid, volume 900 mL/24 h, albumin 3+, sugar negative, pus cells 1-3/HPF, RBC – 1-2/HPF, and epithelial cells rare. What is the probable diagnosis?

### Clinical Case Study 27.4

A 15-year-old girl presents with bilateral leg edema, arthralgia and purpuric spots on the lower limbs. The laboratory analysis values were:

Hemoglobin	: 11.2 g/dL
Platelets	: 180,000/cu.mm
Total Count	: 9600/cu.mm
ESR	: 40 mm/h
Serum, creatinine	: 4 mg/dL
Urine, proteins	: +++
Urine, microscopy	: 30-35 RBCs per field

- A. What is the most probable diagnosis?
- B. What further tests do you suggest?



### Clinical Case Study 27.1 Answer

Proteinuria, hypoalbuminemia and hypercholesterolemia along with acute renal failure and edema are the classical presentation of nephrotic syndrome (nephrosis). Patient has diabetes mellitus and hypertension, and these may have caused nephrotic syndrome. Confirmation of diagnosis can be done by renal biopsy. Hypercoagulable state, hypovitaminosis D and immunodeficiency are associated features seen.

Causes of nephrotic syndrome are; (1) Primary – minimal change nephropathy, focal glomerulosclerosis, membranous nephropathy, hereditary nephropathies, and (2) Secondary – Diabetes mellitus, lupus erythematosus, amyloidosis, paraproteinemia viral infections like hepatitis B, C, HIV, etc., pre-eclampsia, vasculitis, drugs.

Treatment is based on treating protein loss, edema, hyperlipidemia, hypercoagulable state, associated nutritional deficiencies and protection from infections. Prognosis depends on cause, person's age and type and degree of renal damage caused at the time of initiating treatment.

### Clinical Case Study 27.2 Answer

The patient is suffering from acute renal failure (ARF), also referred to as acute kidney injury (AKI). A brief history of bacterial infection, rising urea and creatinine values, oliguria, edema and failed response to diuretics all point towards with diagnosis. Retention of nitrogenous waste products, oliguria, electrolyte and acid-base disturbances are clinical features of ARF. Causes for ARF are usually classified as prerenal, intrinsic and postrenal causes. Risk factors for ARF include hypertension, congestive heart failure, diabetes, multiple myeloma, chronic infection and myeloproliferative diseases.

Laboratory investigations include blood urea (or BUN, blood urea nitrogen), serum creatinine, myoglobin, free hemoglobin, uric acid, serum electrolytes (hyponatremia, hyperkalemia, hyperphosphatemia, hypocalcemia, hypermagnesemia and metabolic acidosis are seen in ARF), serological tests for antinuclear antibodies (ANA), hepatitis, antistreptolysin-O (ASO), cross reacting antibody produced by streptococci and complements, urine analysis (casts, myoglobin, hemoglobin, proteins, RBC and WBC or their casts, eosinophils, uric acid, calcium oxalate crystals) and urine electrolytes. Renal biopsy is indicated in patients in whom prerenal and postrenal causes have been ruled out and cause for intrinsic ARF is unclear.

### Clinical Case Study 27.3 Answer

The patient is suffering from chronic renal failure (CRF), also known as chronic kidney disease (CKD). The past history of hypertension and kidney failure goes against the diagnosis of ARF.

Decreased renal function interferes with kidneys' ability to maintain fluid and electrolyte balance. The ability to concentrate urine declines early and is followed by inability to excrete phosphate, acids and potassium. In advanced stages, urine cannot be diluted and urine osmolality is "fixed". Plasma levels of urea and creatinine are elevated rapidly, and abnormalities of calcium, phosphate, PTH, vitamin D, and renal osteodystrophy are seen. Moderate acidosis is seen. Anemia is normochromic-normocytic in nature. CKD is rarely reversible and leads to progressive decline in renal function.

Diagnostic tests are electrolytes, blood urea nitrogen (BUN) or blood urea, creatinine, phosphate, calcium, CBC and urinalysis. The definitive diagnostic tool is renal biopsy, but is not recommended when ultrasound indicates small, fibrotic kidneys.

Treatment includes (1) Control of underlying diseases, (2) Restriction of dietary protein, phosphate and potassium, (3) Vitamin D supplements, (4) Treatment of anemia and heart failure, and (5) dialysis for severe decrease in renal function.

### Clinical Case Study 27.4 Answer

Henoch-Schonlein Purpura. See description in this chapter for renal abnormalities

## QUICK LOOK OF CHAPTER 27

1. The GFR of a person with 70 kg body weight is 120–125 mL per minute.
2. Acetazolamide, a carbonic anhydrase inhibitor, will cause diuresis by decreasing reabsorption of bicarbonate, sodium and water.
3. The glomeruli of kidney are not permeable to substances with molecular weight more than 69,000.
4. Large quantities (upto a few grams per day) of albumin are lost in urine in nephrosis.
5. Microalbuminuria is seen as a complication of diabetes mellitus and hypertension.

6. Ketonuria may be detected by Rothera's test.
7. Non-protein Nitrogen includes urea, creatinine and uric acid. Minor components of NPN are urobilinogen, indican, ammonia and amino acids.
8. Clearance is defined as the quantity of blood or plasma completely cleared of a substance per unit time and is expressed as milliliter per minute.
9. Inulin is neither absorbed nor secreted by the tubules. Therefore, inulin clearance is a measure of GFR.
10. Creatinine co-efficient is the urinary creatinine expressed in mg/kg body weight. The value is elevated in muscular dystrophy. Normal range is 20–28 mg/kg for males and 15–21 mg/kg for females.
11. Maximum urea clearance is found to be 75 mL/min in normals.

# CHAPTER 28

## Plasma Proteins

### Chapter at a Glance

The reader will be able to answer questions on the following topics:

- Plasma proteins
- Electrophoresis
- Albumin, functions, clinical significance
- Hypoalbuminemia
- Globulins, alpha, beta, gamma
- Transport proteins in blood
- Acute phase proteins in blood
- Ceruloplasmin
- Alpha-1 antitrypsin
- Clotting factors

Total blood volume is about 4.5 to 5 liters in adult human being. If blood is mixed with an anticoagulant and centrifuged, the cell components (RBC and WBC) are precipitated. The supernatant is called plasma. About 55–60% of blood is made up of plasma.

- i. If blood is withdrawn without anticoagulant and allowed to clot, after about 2 hours liquid portion is separated from the clot. This **defibrinated plasma is called serum**, which lacks coagulation factors including prothrombin and fibrinogen.
- ii. **Total protein** content of normal plasma is **6 to 8 g/100 mL**.
- iii. The plasma proteins consist of **albumin (3.5 to 5 g/dL)**, **globulins (2.5 – 3.5 g/dL)** and fibrinogen (200– 400 mg/dL). The albumin : globulin ratio is usually between 1.2:1 to 1.5:1.
- iv. Almost all plasma proteins, except immunoglobulins are synthesized in liver. Plasma proteins are generally synthesized on membrane-bound polyribosomes. Most plasma proteins are glycoproteins.

v. In laboratory, separation can be done by salts. Thus, fibrinogen is precipitated by 10% and globulins by 22% concentration of **sodium sulfate**. Ammonium sulfate will precipitate globulins at half saturation and albumin at full saturation.

- vi. In clinical laboratory, total proteins in serum or plasma of patients are estimated by **Biuret method** (see Chapter 4). Albumin is quantitated by **Bromo cresol green (BCG)** method, in which the dye is preferentially bound with albumin, and the color is estimated colorimetrically.

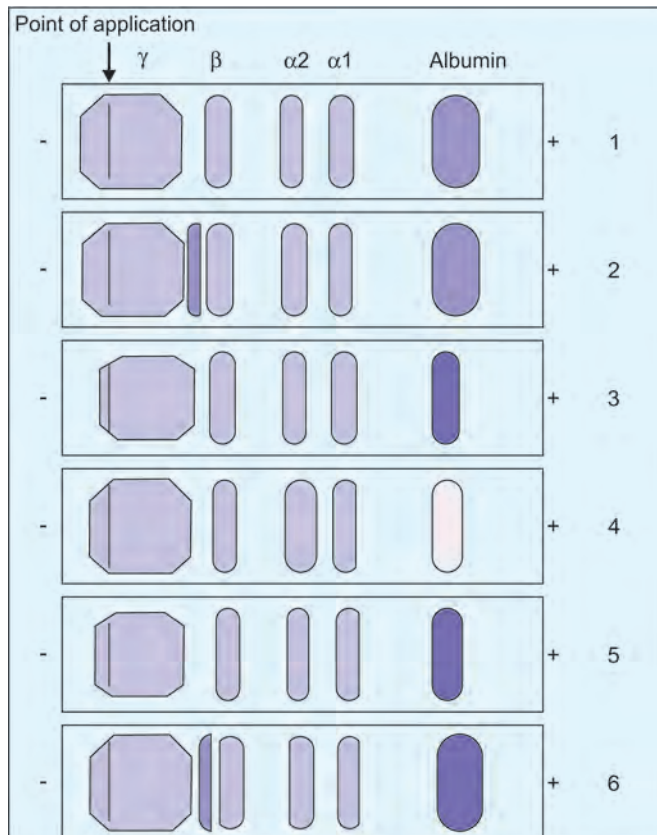
### ELECTROPHORESIS

In clinical laboratory, electrophoresis is employed regularly for separation of serum proteins. The term electrophoresis refers to the **movement of charged particles through an electrolyte when subjected to an electric field**. The details are given in Chapter 35. Normal and abnormal electrophoretic patterns are shown in Figures 28.1 and 28.2.

## Normal Patterns and Interpretations

- i. In agar gel electrophoresis, normal serum is separated into 5 bands. Their relative concentrations are given below:
 

Albumin	: 55–65%
Alpha-1 globulin	: 2–4%
Alpha-2 globulin	: 6–12%
Beta globulin	: 8–12%
Gamma globulin	: 12–22%
- ii. **Albumin has the maximum and gamma globulin has the minimum mobility** in the electrical field.
- iii. Gamma globulins contain the antibodies (immunoglobulins). Most of the alpha-1 fraction is made up of alpha-1 antitrypsin. Alpha-2 band is mainly made up by alpha-2 macroglobulin. Beta fraction contains low density lipoproteins.

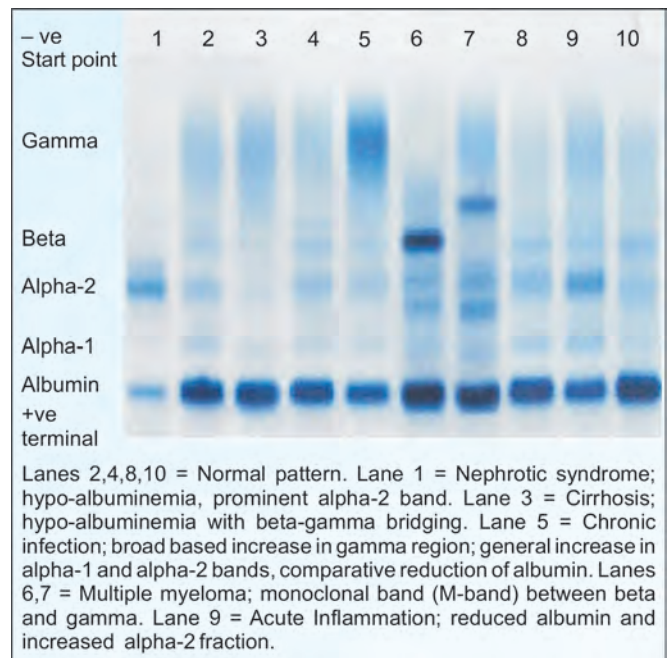


**Fig. 28.1A:** Serum electrophoretic patterns. 1 = Normal pattern; 2 = Multiple myeloma (M band) between  $\beta$  and  $\gamma$  region; 3 = Chronic infection, broad based increase in  $\gamma$  region; general increase in  $\alpha_1$  and  $\alpha_2$  bands; 4 = Nephrotic syndrome; hypoalbuminemia; prominent  $\alpha_2$  band; 5 = Cirrhosis of liver; decreased albumin; 6 = Plasma showing fibrinogen (normal condition). This may be mistaken for paraproteins

## Abnormal Patterns in Clinical Diseases

Various abnormalities can be identified in the electrophoretic pattern (Figs 28.1A and B).

1. **Chronic infections:** The gamma globulins are increased, but the increase is smooth and widebased.
2. **Multiple myeloma:** In **para-proteinemias**, a sharp spike is noted and is termed as **M-band**. This is due to monoclonal origin of immunoglobulins in multiple myeloma (Fig. 28.2).
3. **Fibrinogen:** Instead of serum, if plasma is used for electrophoresis, the fibrinogen will form a prominent band in the gamma region, which may be confused with the M-band.
4. **Primary immune deficiency:** The gamma globulin fraction is reduced.
5. **Nephrotic syndrome:** All proteins except very big molecules are lost through urine, and so alpha-2 fraction (containing macroglobulin) will be very prominent.
6. **Cirrhosis of liver:** Albumin synthesis by liver is decreased, with a compensatory excess synthesis of globulins by reticuloendothelial system. So albumin band will be thin, with a wide beta fraction; sometimes beta and gamma fractions are fused.



**Fig. 28.1B:** Serum electrophoretic patterns



7. **Chronic lymphatic leukemia**, gamma globulin fraction is reduced.
8. **Alpha-1 antitrypsin deficiency**: The alpha-1 band is thin or even missing.

## ALBUMIN

- i. The name is derived from the white precipitate formed when egg is boiled (Latin, albus = white). Albumin constitutes the major part of plasma proteins.
- ii. It has one polypeptide chain with 585 amino acids. It has a molecular weight of 69,000 D. It is elliptical in shape.
- iii. It is synthesized by hepatocytes; therefore, estimation of albumin is a **liver function test** (see Chapter 26). Albumin is synthesized as a precursor, and the signal peptide is removed as it passes through endoplasmic reticulum.
- iv. Albumin can come out of vascular compartment. So albumin is present in CSF and interstitial fluid.
- v. Half-life of albumin is about 20 days. Liver produces about 12 g of albumin per day, representing about 25% of total hepatic protein synthesis.

**Half-life:** Each plasma protein has a characteristic half-life in circulation; e.g. half-life of albumin is 20 days, and that of haptoglobin is 5 days. The half-life is studied by labeling the pure protein with radioactive chromium ( $^{51}\text{Cr}$ ). A known quantity of the labeled protein is injected into a normal person, and blood samples are taken at different time intervals. Half-life of a protein in circulation may be drastically reduced when proteins are lost in conditions, such as Crohn's disease (regional ileitis) or protein losing enteropathy.

## Functions of Albumin

### Colloid Osmotic Pressure of Plasma

- i. The total osmolality of serum is 278–305 mosmol/kg (about 5000 mm of Hg). But this is produced mainly by salts, which can pass easily from intravascular to extravascular space. Therefore, the osmotic pressure exerted by electrolytes inside and outside the vascular compartments will cancel each other. But proteins cannot easily escape out of blood vessels, and therefore, proteins exert the '**effective osmotic pressure**'. It is about 25 mm Hg, and 80% of it is contributed by albumin. The maintenance of blood volume is dependent on this effective osmotic pressure.
- ii. According to **Starling's hypothesis**, at the capillary end, the blood pressure (BP) or hydrostatic pressure expels water out, and effective osmotic pressure (EOP) takes water into the vascular compartment (Fig. 28.3).
- iii. At arterial end of the capillary, BP is 35 mm Hg and EOP is 25 mm; thus water is expelled by a pressure of 10 mm Hg. At the venous end of the capillary, EOP is 25 mm and BP is 15 mm, and therefore water is imbibed with a pressure of 10 mm. Thus, the number of water molecules escaping out at arterial side will be exactly equal to those returned at the venous side and therefore blood volume remains the same.
- iv. If protein concentration in serum is reduced, the EOP is correspondingly decreased. Then return of water into blood vessels is diminished, leading to **accumulation of water in tissues**. This is called **edema**.

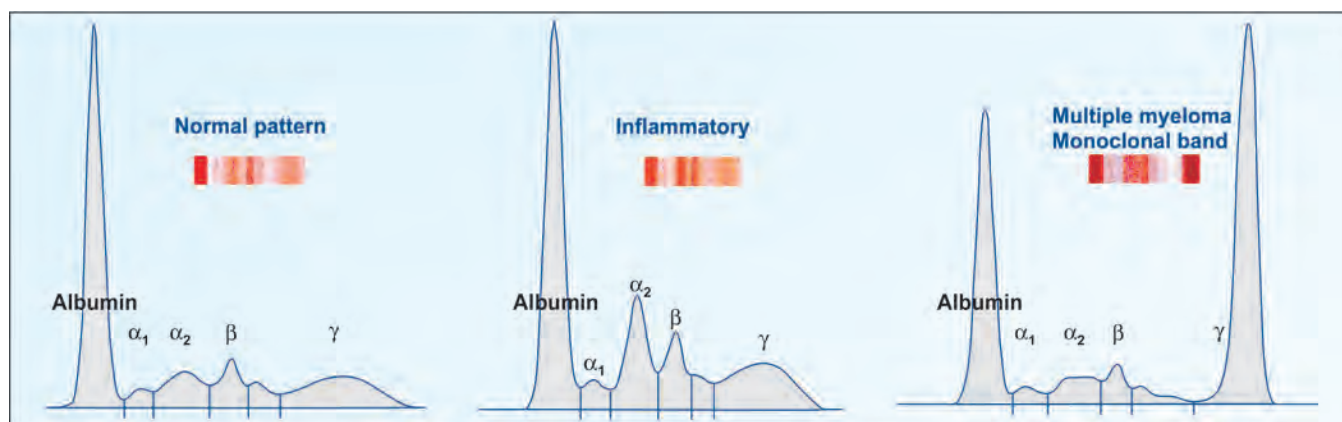


Fig. 28.2: Normal and abnormal electrophoretic patterns

- v. Edema is seen in conditions where albumin level in blood is less than 2 g/dL (see hypoalbuminemia).

### Transport Function

Albumin is the carrier of various hydrophobic substances in the blood. Being a watery medium, blood cannot solubilize lipid components.

- i. **Bilirubin** and **non-esterified fatty acids** are specifically transported by albumin.
- ii. **Drugs** (sulfa, aspirin, salicylate, dicoumarol, phenytoin).
- iii. **Hormones:** Steroid hormones, thyroxine.
- iv. **Metals:** Albumin transports copper. Calcium and heavy metals are non-specifically carried by albumin. Only the unbound fraction of drugs is biologically active.

### Buffering Action

All proteins have buffering capacity. Because of its high concentration in blood, albumin has maximum buffering capacity (see Chapter 29). Albumin has a total of 16 histidine residues which contribute to this buffering action.

### Nutritional Function

All tissue cells can take up albumin by pinocytosis. It is then broken down to amino acid level. So albumin may be considered as the transport form of essential amino acids from liver to extrahepatic cells. Human albumin is clinically useful in treatment of liver diseases, hemorrhage, shock and burns.

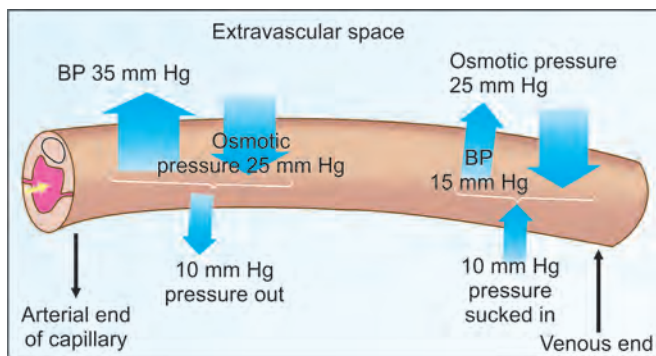


Fig. 28.3: Starling hypothesis

## Clinical Applications

### Blood Brain Barrier

Albumin-fatty acid complex cannot cross blood-brain barrier and hence fatty acids cannot be taken up by brain. The **bilirubin from albumin may be competitively replaced by drugs like aspirin**. Being lipophilic, unconjugated bilirubin can cross the blood brain barrier and get deposited in brain. The brain of young children are susceptible; free bilirubin deposited in brain leads to **kernicterus** and mental retardation (see Chapter 21).

### Drug Interactions

When two drugs having high affinity to albumin are administered together, there may be competition for the available sites, with consequent displacement of one drug. Such an effect may lead to clinically significant drug interactions, e.g. phenytoin-dicoumarol interaction.

### Protein-bound Calcium

Calcium level in blood is lowered in hypoalbuminemia. Thus, even though total calcium level in blood is lowered, ionized calcium level may be normal, and so tetany may not occur (see Chapter 39). Calcium is lowered by 0.8 mg/dL for a fall of 1 g/dL of Albumin.

### Therapeutic Use

Human albumin is therapeutically useful to treat burns, hemorrhage and shock.

### Edema

Hypoalbuminemia will result in **tissue edema** (see Starling's law).

- a. **Malnutrition**, where albumin synthesis is depressed (*generalized edema*)
- b. **Nephrotic** syndrome, where albumin is lost through urine (*facial edema*)
- c. **Cirrhosis** of liver (mainly *ascites*), where albumin synthesis is less and it escapes into ascitic fluid
- d. **Chronic congestive cardiac failure:** Venous congestion will cause increased hydrostatic pressure and decreased return of water into capillaries and so *pitting edema* of feet may result.

### Normal Value

Normal level of Albumin is 3.5–5 g/dL. Lowered level of albumin (hypoalbuminemia) has important clinical significance.

### Hypoalbuminemia

- Cirrhosis of liver:** Synthesis is decreased.
- Malnutrition:** Availability of amino acids is reduced and albumin synthesis is affected.
- Nephrotic syndrome:** Permeability of kidney glomerular membrane is defective, so that albumin is excreted in large quantities.
- Albuminuria:** Presence of albumin in urine is called albuminuria. It is always pathological. Large quantities (a few grams per day) of albumin is lost in urine in nephrotic syndrome. Small quantities are lost in urine in acute nephritis, and other inflammatory conditions of urinary tract. Detection of albumin in urine is done by heat and acetic acid test (see Chapter 27). In **microalbuminuria** or minimal albuminuria or paucialbuminuria, small quantity of albumin (30–300 mg/d) is seen in urine (Paucity = small in quantity).
- Protein losing enteropathy :** Large quantities of albumin is lost from intestinal tract.
- Analbuminemia** is a very rare condition, where defective mutation in the gene is responsible for absence of synthesis.

### Albumin-Globulin Ratio

In hypoalbuminemia, there will be a compensatory increase in globulins which are synthesized by the reticuloendothelial system. Albumin-globulin ratio (A/G ratio) is thus altered or even reversed. This again leads to edema.

### Hypoproteinemia

Since albumin is the major protein present in the blood, any condition causing lowering of albumin will lead to reduced total proteins in blood (hypoproteinemia).

### Hypergammaglobulinemias

#### Low Albumin Level

When **albumin level is decreased**, body tries to compensate by increasing the production of globulins from reticuloendothelial system.

### Chronic Infections

Gamma globulins are increased, but the increase is smooth and wide based (Fig. 28.1A).

### Multiple Myeloma

Drastic increase in globulins are seen in *para-proteinemias*, when a sharp spike is noted in electrophoresis. This is termed as **M-band** because of the monoclonal origin of immunoglobulins (Figs 28.1B and 28.2). The monoclonal origin of immunoglobulins is seen in multiple myeloma (see Chapter 55). Monoclonal gammopathies are characterized by the presence of a monoclonal protein, which can be detected by serum protein electrophoresis and typed by immunofixation electrophoresis. The light chains are produced in excess which is excreted in urine as Bence Jones proteins (BJP) when their serum level increases. Multiple myeloma is the most common type of monoclonal gammopathy. Free light chain assay along with kappa and lambda ratio in serum and urine is found to be very useful in early diagnosis, monitoring the response to treatment and prediction of prognosis.

## ■ TRANSPORT PROTEINS

Blood is a watery medium; so lipids and lipid soluble substances will not easily dissolve in the aqueous medium of blood. Hence such molecules are carried by specific carrier proteins. Their important features are summarized in Table 28.1.

- Albumin :** It is an important transport protein, which carries bilirubin, free fatty acids, calcium and drugs (see above).
- Pre-albumin or Transthyretin:** It is so named because of its faster mobility in electrophoresis than albumin. It is more appropriately named as **Transthyretin** or Thyroxine binding pre-albumin (**TBPA**), because it carries thyroid hormones, thyroxine (T<sub>4</sub>) and tri-iodo thyronine (T<sub>3</sub>). Its half-life in plasma is only 1 day.
- Retinol binding protein (RBP) :** It carries vitamin A (see Chapter 36). It is a low molecular weight protein, and so is liable to be lost in urine. To prevent this loss, RBP is attached to pre-albumin; the complex is large and will not pass through kidney glomeruli. It is a **negative acute phase** protein.
- Thyroxine binding globulin (TBG) :** It is the specific carrier molecule for thyroxine and tri-iodo thyronine. TBG level is increased in pregnancy; but decreased in nephrotic syndrome.

**TABLE 28.1:** Carrier proteins or transport proteins of plasma

Name	Plasma level	Molecular wt (Dalton)	Compound bound or transported	Electrophoretic mobility	Biological and clinical significance
Albumin	3.5–5 g/dL	69,000	Fatty acids, bilirubin, calcium, thyroxine, heavy metals, drugs e.g. aspirin, sulfa	Maximum anodal migration	Bilirubin competes with aspirin for binding sites on albumin
Prealbumin (Transthyretin)	25–30 mg/dL	54,000	Steroid hormones, thyroxine, retinol	Faster than albumin	Rich in tryptophan. Half-life is 1 day It is a negative acute phase protein Transports T3 and T4 loosely
Retinol binding protein (RBP)	3–6 mg/dL	21,000	Retinol (Vitamin A)	$\alpha_1$	Synthesized by liver. RBP has a short half-life. Level indicates vitamin A status Useful to assess the protein turn over rate
Thyroxine binding globulin (TBG)	1–2 mg/dL	58,000	Thyroxine	$\alpha_1$	Assessment of the binding sites on TBG is important in studying thyroid function It is synthesized in liver
Transcortin; Cortisol binding globulin (CBG)	3–3.5 mg/dL	52,000	Cortisol and Corticosterone	$\alpha_1$	Synthesized by liver. Increased in pregnancy. Free unbound fraction of hormone is biologically active
Haptoglobin (Hp)	40–175 mg/dL	100,000 to 400,000	Hemoglobin	$\alpha_2$	Synthesized in liver. Low level indicates hemolysis. Half-life of Hp is 5 days; but that of Hb-Hp is only 90 minutes. It is an acute phase protein (see Chapter 35)
Transferrin	200–300 mg/dL	76,500	Iron 33% saturated	$\beta$	Conserves iron by preventing iron loss through urine (see Chapter 35)
Hemopexin	50–100 mg/dL	57,000	Free heme	$\beta$	Helps in preventing loss of heme (and so iron also) from body (see Chapter 35)

- Transcortin:** It is also known as **Cortisol binding globulin (CBG)**. It is the transport protein for cortisol and corticosterone.
- Haptoglobin:** Haptoglobin (for hemoglobin), **Hemopexin** (for heme) and **Transferrin** (for iron) are important to prevent loss of iron from body.

## Polymorphism

The term polymorphism is applied when the *protein exists in different phenotypes in the population; but only one form is seen in a particular person*. Haptoglobin, transferrin, ceruloplasmin, alpha-1-antitrypsin and immunoglobulins exhibit polymorphism. For example, Haptoglobin (Hp) exists in three forms, Hp1–1, Hp2–1, and Hp2–2. Two genes, designated Hp<sup>1</sup> and Hp<sup>2</sup> are responsible for these polymorphic forms. Their functional capabilities are the same. These polymorphic forms are recognized by electrophoresis or by

immunological analysis. Study of polymorphism is useful for genetic and anthropological studies.

## ACUTE PHASE PROTEINS

The level of certain proteins in blood may increase 50 to 1000 folds in various inflammatory and neoplastic conditions. Such proteins are acute phase proteins. Important acute phase proteins are described below:

### C-Reactive Protein (CRP)

So named because it reacts with C-polysaccharide of capsule of pneumococci. CRP is a beta-globulin and has a molecular weight of 115–140 kD. It is synthesized in liver. It can stimulate complement activity and macrophage phagocytosis. When the inflammation has subsided, CRP quickly falls, followed by ESR (erythrocyte sedimentation rate). CRP level, especially **high sensitivity C-reactive**



**protein** level in blood has a positive correlation in predicting the risk of coronary artery diseases (see Chapter 25).

## Ceruloplasmin

- i. Ceruloplasmin is blue in color (Latin, caeruleus=blue). It is an alpha-2 globulin with molecular weight of 160,000 Daltons. It contains 6 to 8 **copper atoms** per molecule.
- ii. Ceruloplasmin is mainly synthesized by the hepatic parenchymal cells and a small portion by lymphocytes and macrophages. After the formation of peptide part (apo-Cp) copper is added by an intracellular ATPase and carbohydrate side chains are added to make it a glycoprotein (holo-Cp). The normal plasma half-life of holo-Cp is 4–5 days.
- iii. Ceruloplasmin is also called **Ferroxidase**, an enzyme which helps in the incorporation of iron into transferrin (see Chapter 39). It is an important antioxidant in plasma.
- iv. About 90% of copper content of plasma is bound with ceruloplasmin, and 10% with albumin. Copper is bound with albumin loosely, and so easily exchanged with tissues. Hence, **transport protein for copper is Albumin**.
- v. Lowered level of ceruloplasmin is seen in Wilson's disease, malnutrition, nephrosis, and cirrhosis.
- vi. Ceruloplasmin is an acute phase protein. **Increased plasma Cp levels** are seen in active hepatitis, biliary cirrhosis, hemochromatosis, and obstructive biliary disease, pregnancy, estrogen therapy, inflammatory conditions, collagen disorders and in malignancies. Drugs increasing the ceruloplasmin level are, estrogen and contraceptives.

**Reference blood levels** of ceruloplasmin are:

Adults	Males	22 – 40 mg/dL
	Females	25 – 60 mg/dL
Pregnancy		30 – 120 mg/dL

## Wilson's Disease

- a. Level is reduced to less than **20 mg/dL** in **Wilson's hepatolenticular degeneration**. It is an inherited autosomal recessive condition. Incidence of the disease is 1 in 50,000.
- b. The basic defect is a mutation in a gene encoding a **copper binding ATPase** in cells, which is required

for excretion of copper from cells. So, copper is not excreted through bile, and hence copper toxicity. Please also see Chapter 39, under copper metabolism.

- c. Increased copper content in hepatocyte inhibits the incorporation of copper to apo-ceruloplasmin. So ceruloplasmin level in blood is decreased.

## Clinical Features

- a. Accumulation in liver leads to hepatocellular degeneration and **cirrhosis**.
- b. Deposits in brain basal ganglia leads to **lenticular degeneration** and neurological symptoms.
- c. Copper deposits as green or golden pigmented ring around cornea; this is called **Kayser-Fleischer ring**.
- d. Treatment consists of a diet containing low copper and injection of D-penicillamine, which excretes copper through urine. Since zinc decreases copper absorption, zinc is useful in therapy.

## Alpha-1 Antitrypsin (AAT)

It is otherwise called **alpha-anti-proteinase** or **protease inhibitor**. It inhibits all serine proteases (proteolytic enzymes having a serine at their active center), such as plasmin, thrombin, trypsin, chymotrypsin, elastase, and cathepsin. **Serine protease inhibitors** are abbreviated as **Serpins**.

The AAT is synthesized in liver. It is a glycoprotein with a molecular weight of 50 KD. It forms the bulk of molecules in serum having **alpha-1** mobility. Normal serum level is 75 – 200 mg/dL. AAT deficiency causes the following conditions:

**Emphysema:** The incidence of AAT deficiency is 1 in 1000 in Europe, but uncommon in Asia. The total activity of AAT is reduced in these individuals. Bacterial infections in lung attract macrophages which release elastase. In the AAT deficiency, unopposed action of elastase will cause damage to lung tissue, leading to emphysema. About 5% of emphysema cases are due to AAT deficiency.

**Nephrotic syndrome:** AAT molecules are lost in urine, and so AAT deficiency is produced.

## Liver Cirrhosis

Deficiency of  $\alpha$ 1 antitrypsin is the most common genetic cause for liver disease in infants and children. It starts as “neonatal hepatitis syndrome” and may progress to liver failure and cirrhosis.  $\alpha$ 1 antitrypsin can be detected by serum electrophoresis.

### Alpha-2 Macroglobulin (AMG)

It is a tetrameric protein with molecular weight of 725 KD. It is the major component of alpha-2 globulins. It is synthesized by hepatocytes and macrophages. AMG inactivates all proteases, and is an important **in vivo anti-coagulant**. AMG is the carrier of many growth factors, such as platelet derived growth factor (PDGF). Normal serum level is 130–300 mg/dL. Its concentration is markedly increased (up to 2–3 g/dL) in **Nephrotic syndrome**, where other proteins are lost through urine.

### Negative Acute Phase Proteins

During an inflammatory response, some proteins are seen to be decreased in blood; those are called negative acute phase proteins. Examples are **albumin, transthyretin (pre-albumin), retinol binding protein and transferrin**.

Transferrin is a specific iron binding protein (see Chapter 39). It has a half-life of 7–10 days and is used as a better index of protein turnover than albumin.

Plasma contains many enzymes (see Chapter 23), protein hormones (see Chapter 50) and immunoglobulins (see Chapter 55). A comprehensive list of normal values for the substances present in blood is given in the Appendix II.

## ■ CLOTTING FACTORS

The word coagulation is derived from the Greek term, "coagulare" = to curdle. The biochemical mechanism of clotting is a typical example of **cascade activation**.

The coagulation factors are present in circulation as **inactive zymogen** forms. They are converted to their active forms only when the clotting process is initiated. This would prevent unnecessary intravascular coagulation. Activation process leads to a cascade amplification effect, in which one molecule of preceding factor activates 1000 molecules of the next factor. Thus within seconds, a large number of molecules of final factors are activated. The clotting process is schematically represented in Figure 28.4 and the characteristics of coagulation factors are shown in Table 28.2.

Several of these factors require calcium for their activation. The calcium ions are chelated by the gamma carboxyl group of glutamic acid residues of the factors, prothrombin, VII, IX, X, XI and XII. The **gamma carboxylation** of glutamic acid residues is dependent on vitamin K (see Chapter 33), and occurs after synthesis of the protein (post-translational modification).

### Prothrombin

It is a single chain zymogen with a molecular weight of 69,000 D. The plasma concentration is 10–15 mg/dL. The

prothrombin is converted to thrombin by Factor Xa, by the removal of N-terminal fragment.

### Thrombin

It is a serine protease with molecular weight of 34,000 D. The  $\text{Ca}^{++}$  binding of prothrombin is essential for anchoring the prothrombin on the surface of platelets. When the terminal fragment is cleaved off, the calcium binding sites are removed and so, thrombin is released from the platelet surface.

### Fibrinogen

The conversion of fibrinogen to fibrin occurs by cleaving of Arg-Gly peptide bonds of fibrinogen. Fibrinogen has a molecular weight of 340,000 D and is synthesised by the liver. Normal fibrinogen level in blood is 200–400 mg/dL. The fibrin monomers formed are insoluble. They align themselves lengthwise, aggregate and precipitate to form the clot. Fibrinogen is an **acute phase protein**.

### Fibrinolysis

Unwanted fibrin clots are continuously dissolved *in vivo* by Plasmin, a serine protease. Its inactive precursor is plasminogen (90 kD). It is cleaved into two parts to produce the active plasmin. Plasmin in turn, is inactivated by alpha-2 antiplasmin.

Tissue **plasminogen activator** (TPA) is a serine protease present in vascular endothelium. TPA is released during injury and then binds to fibrin clots. Then TPA cleaves plasminogen to generate plasmin, which dissolves the clots.

**Urokinase** is another activator of plasminogen. Urokinase is so named because it was first isolated from urine. Urokinase is produced by macrophages, monocytes and fibroblasts. **Streptokinase**, isolated from streptococci is another fibrinolytic agent.

### Clinical Significance

Thrombosis in coronary artery is the major cause of myocardial infarction (heart attack). If TPA, urokinase or streptokinase is injected intravenously in the early phase of thrombosis, the clot may be dissolved and recovery of patient is possible.

### Prothrombin Time (PT)

It evaluates the extrinsic coagulation pathway, so that if any of the factors synthesized by the liver (factors I, II, V, VII, IX and X) is deficient prothrombin time will be prolonged. It is the time required for the clotting of whole blood (citrate or oxalate) after addition of calcium and tissue thromboplastin. So, fibrinogen is polymerized to fibrin by thrombin.

It is commonly assessed by the "one stage prothrombin time of Quick" (named after the inventor). The results are expressed either in seconds or as a ratio of the plasma prothrombin time to a control plasma time. The normal

control PT is 9 – 11 seconds. A prolongation of 2 seconds is considered as abnormal. Values more than 14 seconds indicate impending hemorrhage. The PT is prolonged if any of the concerned factors are deficient. The present techniques express the prothrombin level as a ratio as INR (Internationalized ratio).

**Liver dysfunction** of acute onset will be reflected as prolonged prothrombin time. Out of 13 clotting factors, 11 are synthesized by the liver. Their synthesis is dependent on availability of vitamin K and normal hepatocellular function.

Prolonged PT may be the initial supportive laboratory parameter to diagnose an acute liver disease. Persistent and progressing prolonged PT is suggestive of fulminant liver failure.

PT measurements are useful to differentiate cholestasis and severe hepatocellular disease. When prolonged PT result is obtained; give vitamin K by intramuscular injection and after 4 hours recheck PT. If the PT becomes normal after vitamin K injection (which is needed for post-translational modification of prothrombin) the diagnosis of cholestasis can be made. If the PT is prolonged, the possibility is severe hepatocellular disease.

## ABNORMALITIES IN COAGULATION

### Hemophilia A (Classical Hemophilia)

This is an inherited **X-linked** recessive disease **affecting males and transmitted by females**. Male children of hemophilia patients are not affected; but female children will be carriers, who transmit the disease to their male offspring

(Fig. 28.5). This is due to the deficiency of **factor VIII (anti hemophilic globulin) (AHG)**. It is the commonest of the inherited coagulation defects.

There will be prolongation of clotting time. Hence, even trivial wounds, such as tooth extraction will cause excessive loss of blood. Patients are prone to internal bleeding into joints and intestinal tract.

Until recently the treatment consisted of administration of AHG, prepared from pooled sera every 3 months. Since this was not generally available, the usual treatment was to transfuse blood periodically, which may lead to eventual iron overload, hemochromatosis (see Chapter 39). Several hemophilia patients, receiving repeated transfusions became innocent victims of AIDS. Pure AHG is now being produced by recombinant technology and is the treatment of choice.

### Hemophilia B or Christmas Disease

It is due to **factor IX deficiency**. The Christmas disease is named after the first patient reported with this disease. Similar deficiencies of factors X and XI are also reported. In these diseases, the manifestations will be similar to classical hemophilia.

### Other Disorders

Acquired hypofibrinogenemia or afibrinogenemia may occur as a complication of premature separation of placenta or **abruptio placenta**.

**TABLE 28.2:** Factors involved in coagulation process

No.	Name	Molecular weight (Daltons)	Electrophoretic mobility	Activated by	Function
I	Fibrinogen	340,000	$\beta$ and $\gamma$	Thrombin	Forms the clot (fibrin)
II	Prothrombin	69,000	$\alpha_2$	Factor Xa	Activation of fibrinogen and factors XIII, VIII and V
IV	Calcium			—	Activation of factor II, VII, IX, X, XI and XII
V	Labile factor	200,000	$\beta\gamma$	Thrombin	Binding of prothrombin to platelet
VII	Proconvertin; serum prothrombin convertin antecedent (SPCA)	45,500		Thrombin	Activation of factor X
VIII	Antihemophilic globulin (AHG)	1,200,000	$\beta_2$	Thrombin	Activation of factor X
IX	Plasma thromboplastin-component (PTC); Christmas factor	62,000	$\alpha$	Factor XIa	Activation of factor X
X	Stuart Prower factor	59,000	$\alpha$	Factor IXa	Activation of prothrombin
XI	Plasma thromboplastin antecedent (PTA)	200,000	$\beta\gamma$	Factor XIIIa	Activation of factor IX
XII	Hageman factor	80,000		Kallikrein	Activation of factor XI
XIII	Fibrin stabilizing factor (Liki Lorand factor)	320,000		Thrombin	Stabilization of fibrin clot by forming cross links
	Prekallikrein	85,000	$\gamma$		Activation of factor XII

Proteolytic thromboplastic substances may enter from placenta to maternal circulation which set off the clotting cascade (**disseminated intravascular coagulation** or DIC). But the clots are usually degraded immediately by plasminolysis. Continuation of this process leads to removal of all available prothrombin and fibrinogen molecules leading to profuse **postpartum hemorrhage**.

In some cases of **carcinoma of pancreas**, trypsin is released into circulation leading to intravascular coagulation. This may be manifested as **fleeting thrombophlebitis**. Trousseau diagnosed his own fatal disease as cancer of pancreas when he developed thrombophlebitis. The combination of carcinoma of pancreas, migratory thrombophlebitis and consumption coagulopathy is termed as **Trousseau's triad**.

### Prothrombin G20210A Polymorphism

Another hereditary thrombophilia, the *G20210A* polymorphism in the prothrombin gene elevates the plasma concentrations of prothrombin (FII) without changing the amino acid sequence of the protein. Patients

with this mutation have PT and aPTT results that fall within the normal range, as well as normal functional clot-based studies. DNA studies will show a G-to-A substitution in the 3'-untranslated region of prothrombin gene at nucleotide 20210.

### Protein C and S Deficiency

These two vitamin K-dependent factors interrupt the activity of clotting factors V and VIII. Activated protein C is a proteolytic enzyme, while protein S is an essential co-factor.

### Antithrombin Deficiency

AT, formerly called AT III, is a vitamin K-independent glycoprotein that is a major inhibitor of thrombin and other coagulation serine proteases, including factors Xa and IXa. AT forms a competitive 1:1 complex with its target but only in the presence of a negatively charged glycosaminoglycan, such as heparin or heparin sulfate. Patients with AT deficiency will have little AT III activity as measured in a chromogenic assay.

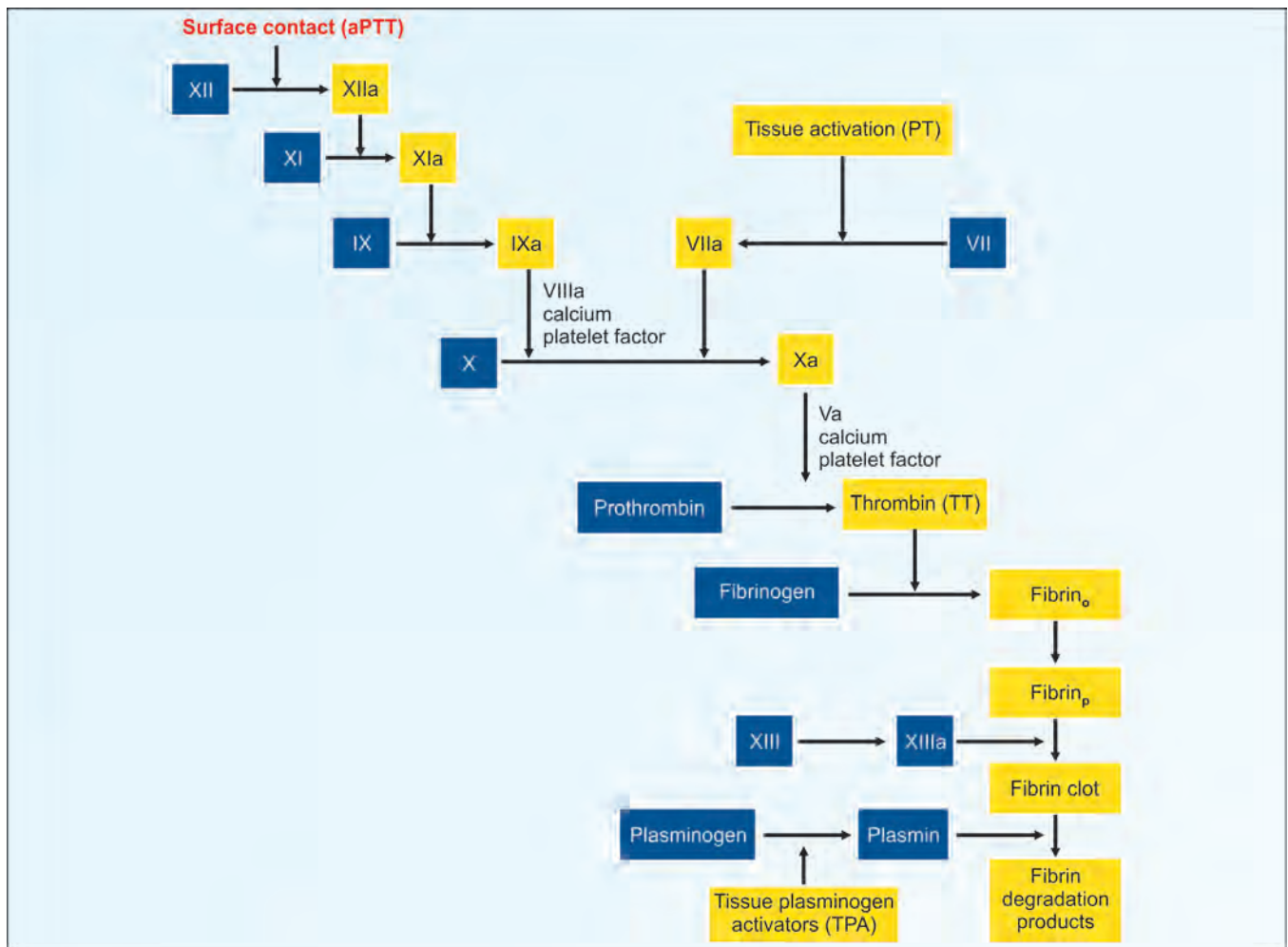


Fig. 28.4: Cascade pathway of coagulation



## Anticoagulants

They are mainly two types: 1. Acting in vitro to prevent coagulation of collected blood and 2. Acting in vivo to prevent and regulate coagulation.

The first group of anticoagulant removes calcium which is essential for several steps on clotting. Oxalates, citrate and EDTA belong to this group.

Heparin and antithrombin III are the major in vivo anticoagulants. The heparin-antithrombin complex exerts an inhibitory effect on the serine protease which activates the clotting factors. Alpha-2 macroglobulin has anticoagulant activity.

**Heparin** is also used as an anticoagulant for in vitro system, e.g. in dialysis and in thromboembolic diseases. It is also used in the treatment of intravascular thrombosis. Since vitamin K is essential for coagulation, antagonists to vitamin K are used as anticoagulants, especially for therapeutic purposes, e.g. Dicoumarol and Warfarin (see Chapter 36, under Vitamin K).

## Coagulation Tests

Laboratory tests for hemostasis typically require citrated plasma derived from whole blood. Specimens should be collected into tubes containing 3.2% sodium citrate (109 mM) at a ratio of 9 parts blood and 1 part anticoagulant. The purpose of the citrate is to remove calcium ions that are essential for blood coagulation (Table 28.3).

## Antiphospholipid Syndrome (APS)

It is frequently associated with a markedly prolonged aPTT, leading to a concern that the affected individual might be at risk for a major hemorrhage. Not only is this highly unlikely, but as a prothrombotic state, APLS is typically associated with venous thromboembolism and/or arterial thrombosis. The condition may also present with fetal loss or stillbirth, which occurs as a result of placental inflammation or thrombosis. Individuals with APLS have antibodies known as lupus anticoagulants (LA). These antibodies are directed to complexes of beta-2 glycoprotein I/phospholipid or prothrombin/phospholipid, and they interfere with and prolong in vitro clotting assays. In the body's vascular system, however, the presence of endothelial cells and leukocytes, as well as many other components that are absent from the simplified

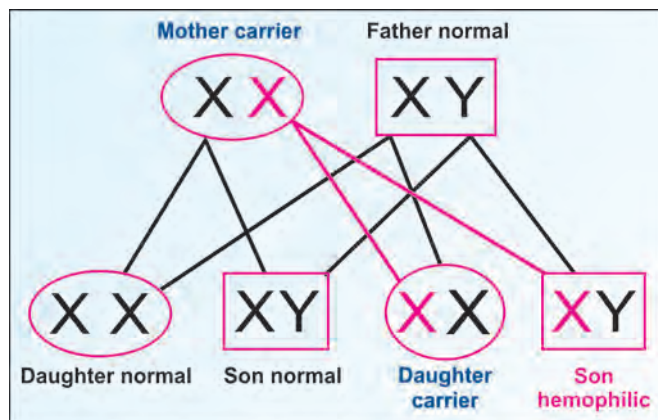


Fig. 28.5: Inheritance pattern of hemophilia

in vitro clotting assay, increase the likelihood of clotting. The classic laboratory findings in APLS patients are prolonged aPTT, and normal PT. Adding excess phospholipid to the aPTT assay, however, reduces the clotting time. This is the basis for the so-called LA assay. The APS is an important cause of acquired thromboembolic complications and pregnancy morbidity. APAs are also found in other autoimmune diseases, in patients receiving drugs such as procainamide and chlorpromazine, in patients with infections (HIV, hepatitis, malaria, and others), and also in association with malignancy.

## Clinical Case Study 28.1

A severe form of obstructive lung disease starting with dyspnea and leading to emphysema was found in several members of the same family. Blood analysis of the surviving members of the family revealed abnormally low concentration of  $\alpha 1$  antitrypsin. What is the basis of this condition?

## Clinical Case Study 28.2

A male child, born to a normal young couple, was found to develop hemorrhagic tendency quite early in life. History revealed that the mother was the only daughter of a family who did not have any male offspring during the past 2 generations.

- What are the possible causes?
- How will you explain the nature of inheritance?
- What is the advice to be given to the parents regarding bringing up the son and having another child.

## Clinical Case Study 28.1 Answer

Emphysema, a lung disease characterized by destruction of alveolar walls, has many causes including airway infections, cigarette smoking, air pollution and hereditary origin. Deficiency of  $\alpha 1$  antitrypsin leads to development of emphysema.  $\alpha 1$  antitrypsin makes up most of the proteins in  $\alpha 1$  globulin band during serum protein electrophoresis.

Lungs contain a natural enzyme called neutrophil elastase that digests damaged aging cells and bacteria and promotes healing of lung tissue. Being non-specific it can attack lung tissue itself; but  $\alpha 1$  antitrypsin protects against this process by destroying excess amount of this enzyme. Absence of  $\alpha 1$  antitrypsin can lead to destruction of lung tissue and emphysema.

Clinical features of  $\alpha 1$  antitrypsin deficiency include shortness of breath, reduced exercise tolerance, wheezing, recurrent respiratory infections and in advanced cases, difficulty in breathing. Smoking exacerbates the condition. About 10% of patients can have liver damage.

**TABLE 28.3:** Assays for clotting factors

Name	Parameter measured
Prothromin time (PT)	Time in seconds taken for the patient's sample to clot; thromboplastin reagent is added
Partial thromboplastin time (PTT)	A measure of how well patient's blood will clot
Activated partial thromboplastin time (aPTT)	Initiated by adding a negatively charged surface like silica to the plasma and a phospholipid extract that is free of tissue factor
Thrombin time (TT)	Assess hemostasis. Measures ability of fibrinogen to form fibrin strands in vitro. Exogenous thrombin is added to pre-warmed plasma
D-Dimer	Assess hemostatic function. D-Dimer is formed by degradation of fibrin clots by thrombin, activated factor XIII and plasmin. High level indicates increased risk of recurrent thromboembolism. High negative predictive value of thrombosis
Activated clotting time	Whole blood is mixed with a clot activator. Normally takes 70 – 180 seconds. Bedside monitoring of high dose heparin therapy
Anti-Xa test	Exogenous factor Xa and anti-thrombin (AT) in excess and chromogenic substrate for Xa. Heparin present complexes with AT and inactivates factor Xa. Any excess Xa will release the chromophore from the substrate. Adjustment of patient's heparin level
Coagulation factor assay	Determines the level of various coagulation factors. Factor deficient plasma is mixed with the specific factor being tested by adding patient's diluted citrated plasma. The patient's specimen supplies the missing factor and the assay is completed by performing a standard PT Calibrated by using standard reference plasma

Diagnosis is by estimation of  $\alpha_1$  antitrypsin levels, arterial blood gas analysis, chest X-ray, CT scan of chest, pulmonary function tests and genetic testing. Treatment involves supplementation of  $\alpha_1$  antitrypsin and antioxidants.

### Clinical Case Study 28.2 Answer

Hemophilia (see description in this chapter).

### QUICK LOOK OF CHAPTER 28

- Total plasma protein content is 6–8 g/dL of which albumin is 3.5–5 g/dL and the rest is globulin. Almost all plasma proteins are synthesized in the liver except immunoglobulins.
- On agar gel electrophoresis albumin has maximum mobility while gamma globulin has minimum mobility.
- In chronic infection, gamma globulins are increased smoothly, while in paraproteinemias, M band is seen. The alpha 2 fraction is increased in nephrotic syndrome while albumin is decreased in liver cirrhosis, malnutrition, nephrotic syndrome.
- Albumin contributes to colloid osmotic pressure of plasma, has buffering capacity and is a transport medium for various hydrophobic substances.
- Hyper gamma globulinemia is seen in conditions of hypoalbuminemia, chronic infection and para proteinemias.  
The transport proteins in blood are albumin, pre-albumin (transthyretin), RBP, TBG, transcortin and haptoglobin.
- Polymorphism is when the protein exists in different phenotypes in the population, but only one form is seen in a particular person. This is seen in haptoglobin, transferrin, ceruloplasmin, alpha1 antitrypsin and immunoglobulins.
- The levels of certain proteins in blood may increase 50 –100-fold in various inflammatory and neoplastic conditions. Such proteins are called acute phase proteins. For example, CRP, ceruloplasmin, haptoglobins, alpha1 acid glycoprotein, alpha1 antitrypsin and fibrinogen.
- Proteins that are decreased in blood during inflammatory response are called negative acute phase proteins. For example, albumin, transthyretin, transferrin.

# CHAPTER 29

## Acid-Base Balance and pH

### Chapter at a Glance

The reader will be able to answer questions on the following topics:

- Acids and bases
- pH
- Buffers
- Acid base balance in the body
- Bicarbonate buffer system
- Respiratory regulation of pH
- Renal regulation of pH
- Relation of pH and potassium
- Respiratory acidosis
- Metabolic acidosis
- Respiratory alkalosis
- Metabolic alkalosis

Hydrogen ions ( $H^+$ ) are present in all body compartments. Maintenance of appropriate concentration of hydrogen ion ( $H^+$ ) is critical to normal cellular function. The acid-base balance or pH of the body fluids is maintained by a closely regulated mechanism. This involves the body buffers, the respiratory system and the kidney. Some common definitions are given in Box 29.1. Functions of hydrogen ions include:

1. The gradient of  $H^+$  concentration between inner and outer mitochondrial membrane acts as the driving force for oxidative phosphorylation.
2. The surface charge and physical configuration of proteins are affected by changes in hydrogen ion concentration.
3. Hydrogen ion concentration decides the ionization of weak acids and thus affects their physiological functions.

### ACIDS AND BASES

#### Definition

The electrolyte theory of dissociation was proposed by Arrhenius (Nobel prize, 1903). According to the definition proposed by Bronsted, **acids are substances that are**



SPL  
Sorensen  
1868–1939

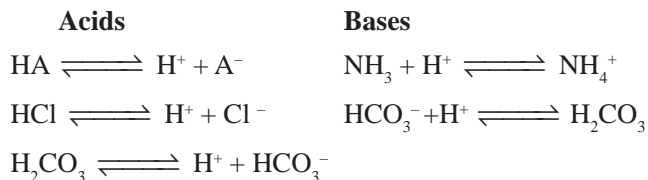


Svante Arrhenius  
NP 1903  
1859–1927



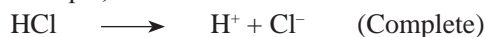
Johannes N  
Bronsted  
1879–1947

capable of donating protons and bases are those that accept protons. Acids are proton donors and bases are proton acceptors. A few examples are shown below:



## Weak and Strong Acids

- i. The extent of dissociation decides whether they are strong acids or weak acids. Strong acids dissociate completely in solution, while weak acids ionize incompletely, for example,



- ii. In a solution of HCl, almost all the molecules dissociate and exist as  $\text{H}^+$  and  $\text{Cl}^-$  ions. Hence the concentration of  $\text{H}^+$  is very high and it is a strong acid.
- iii. But in the case of a weak acid (e.g. acetic acid), it will ionize only partially. So, the number of acid molecules existing in the ionized state is much less, may be only 50%.

## Dissociation Constant

- i. Since the dissociation of an acid is a freely reversible reaction, at equilibrium the ratio between dissociated and undissociated particle is a constant. The dissociation constant ( $K_a$ ) of an acid is given by the formula,

$$K_a = \frac{[\text{H}^+][\text{A}^-]}{[\text{HA}]}$$

Where  $[\text{H}^+]$  is the concentration of hydrogen ions,  $[\text{A}^-]$  = the concentration of anions or conjugate base, and  $[\text{HA}]$  is the concentration of undissociated molecules.

- ii. The pH at which the acid is half ionized is called pKa of an acid which is constant at a particular temperature and pressure.
- iii. Strong acids will have a low pKa and weak acids have a higher pKa.

## Acidity of a Solution and pH

- i. The acidity of a solution is measured by noting the hydrogen ion concentration in the solution and obtained by the equation.

$$[\text{H}^+] = K_a \frac{[\text{acid}]}{[\text{base}]} \text{ or } \frac{[\text{HA}]}{\text{A}^-}$$

where  $K_a$  is the dissociation constant.

- ii. To make it easier, Sorensen expressed the  $\text{H}^+$  concentration as the negative of the logarithm (logarithm to the base 10) of hydrogen ion concentration, and is designated as the pH. Therefore,

$$\text{pH} = -\log [\text{H}^+] = \log \frac{1}{[\text{H}^+]}$$

- iii. Thus the **pH value is inversely proportional to the acidity**. Lower the pH, higher the acidity or hydrogen ion concentration while higher the pH, the acidity is lower (Table 29.1).
- iv. At a pH of 1, the hydrogen ion concentration is 10 times that of a solution with a pH 2 and 100 times that of a solution with a pH of 3 and so on. The **pH 7 indicates the neutral pH**, when the hydrogen ion



Lawrence J  
Henderson  
1878–1942



KA Hasselbalch  
1874–1962

### Box 29.1: Terms explained

Term	Definition and explanations
pH	Negative logarithm of hydrogen ion concentration. Normal value 7.4 (range 7.38–7.42)
Acids	Proton donors; $\text{pH} < 7$
Bases	Proton acceptors; $\text{pH} > 7$
Strong acids	Acids which ionize completely; e.g. HCl
Weak acids	Acids which ionize incompletely, e.g. $\text{H}_2\text{CO}_3$
pK value	pH at which the acid is half ionised; Salt : Acid = 1 : 1
Alkali reserve	Bicarbonate available to neutralise acids; Normal 24 mmol/L (range 22–26 mmol/L)
Buffers	Solutions minimize changes in pH

**TABLE 29.1:** Relation between hydrogen ions, hydroxyl ions and pH of aqueous solutions. Ionic product of water =  $[\text{H}^+][\text{OH}^-] = 10^{-14}$

$[\text{OH}^-]$ mols/liter	$[\text{H}^+]$ mols/liter	$\log$ $[\text{H}^+]$	$-\log[\text{H}^+]$ =pH	pOH	Inference
$1 \times 10^{13}$	$1 \times 10^1$	-1	1	13	Strong acid
$1 \times 10^{10}$	$1 \times 10^{-4}$	-4	4	10	Acid
$1 \times 10^7$	$1 \times 10^{-7}$	-7	7	7	Neutral
$1 \times 10^4$	$1 \times 10^{10}$	-10	10	4	Alkali
$1 \times 10^1$	$1 \times 10^{13}$	-13	13	1	Strong alkali



concentration is 100 nanomoles/liter. The pH meter is described in Chapter 35.

## The Effect of Salt Upon the Dissociation

- The relationship between pH, pKa, concentration of acid and conjugate base (or salt) is expressed by the **Henderson-Hasselbalch equation**,

$$\text{pH} = \text{pKa} + \log \frac{[\text{base}]}{[\text{acid}]} \quad \text{or} \quad \text{pH} = \text{pKa} + \log \frac{[\text{salt}]}{[\text{acid}]}$$

When  $[\text{base}] = [\text{acid}]$ ; then  $\text{pH} = \text{pKa}$

- Therefore, **when the concentration of base and acid are the same, then pH is equal to pKa**. Thus, when the acid is half ionized, pH and pKa have the same values.

## BUFFERS

### Definition

**Buffers are solutions which can resist changes in pH when acid or alkali is added.**

### Composition of a Buffer

Buffers are of two types:

- Mixtures of weak acids with their salt with a strong base or
- Mixtures of weak bases with their salt with a strong acid. A few examples are given below:
  - $\text{H}_2\text{CO}_3/\text{NaHCO}_3$  (Bicarbonate buffer)  
(carbonic acid and sodium bicarbonate)
  - $\text{CH}_3\text{COOH}/\text{CH}_3\text{COO Na}$  (Acetate buffer)  
(acetic acid and sodium acetate)
  - $\text{Na}_2\text{HPO}_4/\text{NaH}_2\text{PO}_4$  (Phosphate buffer)

### Factors Affecting pH of a Buffer

The pH of a buffer solution is determined by two factors:

- The value of pK:** The lower the value of pK, the lower is the pH of the solution.
- The ratio of salt to acid concentrations:** Actual concentrations of salt and acid in a buffer solution may be varying widely, with no change in pH, so long as the ratio of the concentrations remains the same.

### Factors Affecting Buffer Capacity

- On the other hand, the buffer capacity is determined by the actual **concentrations of salt and acid** present, as well as by their ratio.
- Buffering capacity is the number of grams of strong acid or alkali which is necessary for a change in pH of one unit of one litre of buffer solution.
- The buffering capacity of a buffer is defined as **the ability of the buffer to resist changes in pH when an acid or base is added**.

### How do Buffers Act?

- Buffer solutions consist of mixtures of a weak acid or base and its salt.
- To take an example, when hydrochloric acid is added to the acetate buffer, the salt reacts with the acid forming the weak acid, acetic acid and its salt. Similarly when a base is added, the acid reacts with it forming salt and water. Thus changes in the pH are minimized.
 
$$\text{CH}_3\text{-COOH} + \text{NaOH} \rightarrow \text{CH}_3\text{-COONa} + \text{H}_2\text{O}$$

$$\text{CH}_3\text{-COONa} + \text{HCl} \rightarrow \text{CH}_3\text{-COOH} + \text{NaCl}$$
- The buffer capacity is determined by the absolute concentration of the salt and acid. But the pH of the buffer is dependent on the relative proportion of the salt and acid (see the Henderson-Hasselbalch's equation).
- When the ratio between salt and acid is 10:1, the pH will be 1 unit higher than the pKa. When the ratio between salt and acid is 1:10, the pH will be 1 unit lower than the pKa.

### Application of the Equation

- The pH of a buffer on addition of a known quantity of acid and alkali can therefore be predicted by the equation.
- Moreover, the concentration of salt or acid can be found out by measuring the pH.
- The Henderson-Hasselbalch's equation, therefore has great practical application in clinical practice in assessing the acid-base status, and predicting the limits of the compensation of body buffers.

## Effective Range of a Buffer

A buffer is most effective when the concentrations of **salt and acid are equal** or when  $\text{pH} = \text{pK}_a$ . The effective range of a buffer is **1 pH unit higher or lower** than  $\text{pK}_a$ . Since the  $\text{pK}_a$  values of most of the acids produced in the body are well below the physiological pH, they immediately ionize and add  $\text{H}^+$  to the medium. This would necessitate effective buffering. Phosphate buffer is effective at a wide range, because it has 3  $\text{pK}_a$  values.

## ACID-BASE BALANCE

### Normal pH

The **pH of plasma is 7.4** (average hydrogen ion concentration of 40 nmol/L). In normal life, the variation of plasma pH is very small. The pH of plasma is maintained within a **narrow range of 7.38 to 7.42**. The pH of the interstitial fluid is generally 0.5 units below that of the plasma.

### Acidosis

If the pH is below 7.38, it is called acidosis. Life is threatened when the pH is lowered below 7.25. Acidosis leads to CNS depression and coma. Death occurs when pH is below 7.0.

### Alkalosis

When the pH is more than 7.42, it is alkalosis. It is very dangerous if pH is increased above 7.55. Alkalosis induces neuromuscular hyperexcitability and tetany. Death occurs when the pH is above 7.6.

## Volatile and Fixed Acids

- During the normal metabolism, the acids produced may be **volatile acids** like carbonic acid or nonvolatile (**fixed**) acids like lactate, keto acids, sulfuric acid and phosphoric acid.
- The metabolism produces nearly 20,000 milliequivalents (mEq) of carbonic acid and 60–80 mEq of fixed acids per day.
- The lactate and keto acids are produced in relatively fixed amounts by normal metabolic activity, e.g. 1 mol of glucose produces 2 mols of lactic acid.

- The dietary protein content decides the amount of sulfuric and phosphoric acids. The sulfoproteins yield sulfuric acid and phosphoproteins and nucleoproteins produce phosphoric acid. On an average about 3 g of phosphoric acid and about 3 g sulfuric acid are produced per day.
- The carbonic acid, being volatile, is eliminated as  $\text{CO}_2$  by the lungs. The fixed acids are buffered and later on the  $\text{H}^+$  are excreted by the kidney.

## Mechanisms of Regulation of pH

These mechanisms are interrelated. See Box 29.2.

## BUFFERS OF THE BODY FLUIDS

Buffers are the first line of defense against acid load. These buffer systems are enumerated in Table 29.2. The buffers are effective as long as the acid load is not excessive, and the alkali reserve is not exhausted. Once the base is utilized in this reaction, it is to be replenished to meet further challenge.

### Bicarbonate Buffer System

- The most important buffer system in the plasma is the bicarbonate-carbonic acid system ( $\text{NaHCO}_3/\text{H}_2\text{CO}_3$ ). It accounts for 65% of buffering capacity in plasma and 40% of buffering action in the whole body.

Box 29.2: Mechanisms of regulation of pH

First line of defense	: Blood buffers
Second line of defense	: Respiratory regulation
Third line of defense	: Renal regulation

TABLE 29.2: Buffer systems of the body

	Extracellular fluid	Intracellular fluid	Erythrocyte fluid
1.	$\frac{\text{NaHCO}_3}{\text{H}_2\text{CO}_3}$ (bicarbonate)	$\frac{\text{K}_2\text{HPO}_4}{\text{KH}_2\text{PO}_4}$ (phosphate)	$\frac{\text{K}^+\text{Hb}}{\text{H}^+\text{Hb}}$ (hemoglobin)
2.	$\frac{\text{Na}_2\text{HPO}_4}{\text{NaH}_2\text{PO}_4}$ (phosphate)	$\frac{\text{K}^+\text{Protein}}{\text{H}^+\text{Protein}}$ (protein buffer)	$\frac{\text{K}_2\text{HPO}_4}{\text{KH}_2\text{PO}_4}$ (phosphate)
3.	$\frac{\text{Na}^+\text{Albumin}}{\text{H}^+\text{Albumin}}$	$\frac{\text{KHCO}_3}{\text{H}_2\text{CO}_3}$	$\frac{\text{KHCO}_3}{\text{H}_2\text{CO}_3}$

- ii. The base constituent, bicarbonate ( $\text{HCO}_3^-$ ), is regulated by the kidney (**metabolic component**).
- iii. While the acid part, carbonic acid ( $\text{H}_2\text{CO}_3$ ), is under respiratory regulation (**respiratory component**).
- iv. The **normal bicarbonate** level of plasma is **24 mmol/L**. The normal  $\text{pCO}_2$  of arterial blood is 40 mm of Hg. The normal carbonic acid concentration in blood is 1.2 mmol/L. The  $\text{pKa}$  for carbonic acid is 6.1. Substituting these values in the Henderson-Hasselbalch's equation,

$$\text{pH} = \text{pKa} + \log \frac{[\text{HCO}_3^-]}{[\text{H}_2\text{CO}_3]}$$

$$7.4 = 6.1 + \log \frac{24}{1.2}$$

$$= 6.1 + \log 20 = 6.1 + 1.3$$

- v. Hence, the ratio of  $\text{HCO}_3^-$  to  $\text{H}_2\text{CO}_3$  at pH 7.4 is 20 under normal conditions. This is much higher than the theoretical value of 1 which ensures maximum effectiveness.
- vi. The bicarbonate carbonic acid buffer system is the most important for the following reasons:
  - a. Presence of bicarbonate in relatively high concentrations.
  - b. The components are under physiological control,  $\text{CO}_2$  by lungs and bicarbonate by kidneys.

## Alkali Reserve

**Bicarbonate** represents the alkali reserve and it has to be sufficiently high to meet the acid load. If it was too low to give a ratio of 1, all the  $\text{HCO}_3^-$  would have been exhausted within a very short time; and buffering will not be effective. So, under physiological circumstances, the ratio of 20 (a high alkali reserve) ensures high buffering efficiency against acids.

## Phosphate Buffer System

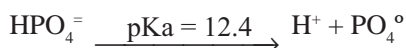
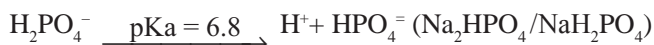
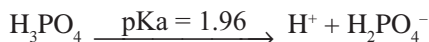
It is mainly an **intracellular** buffer. Its concentration in plasma is very low. The  $\text{pKa}$  value is 6.8. So applying the equation,

$$\text{pH} (7.4) = \text{pKa} (6.8) + \log \frac{[\text{salt}]}{[\text{acid}]}$$

$$\text{or } 0.6 = \log \frac{[\text{salt}]}{[\text{acid}]}$$

Antilog of 0.6 = 4; hence the ratio is 4. This is found to be true under physiological condition.

The phosphate buffer system is found to be effective at a wide pH range, because it has more than one ionizable group and the  $\text{pKa}$  values are different for both.



In the body,  $\text{Na}_2\text{HPO}_4/\text{NaH}_2\text{PO}_4$  is an effective buffer system, because its  $\text{pKa}$  value is nearest to physiological pH.

## Protein Buffer System

Buffering capacity of protein depends on the  $\text{pKa}$  value of ionizable side chains. The most effective group is histidine imidazole group with a  $\text{pKa}$  value of 6.1. The role of the hemoglobin buffer is considered along with the respiratory regulation of pH.

## Relative Capacity of Buffer Systems

In the body, 52% buffer activity is in tissue cells and 6% in RBCs. Rest 43% is by extracellular buffers. In plasma and extracellular space, about 40% buffering action is by bicarbonate system; 1% by proteins and 1% by phosphate buffer system (Fig. 29.1).

## Buffers Act Quickly, But Not Permanently

Buffers can respond immediately to addition of acid or base, but they do not serve to eliminate the acid from the body. They are also unable to replenish the alkali reserve of the body. For the final elimination of acids, the respiratory and renal regulations are very essential.

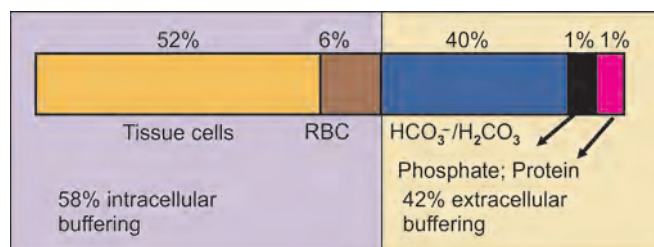


Fig. 29.1: Intracellular buffers play a significant role to combat acid load of the body

## RESPIRATORY REGULATION OF pH

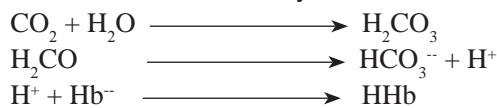
### The Second Line of Defense

- This is achieved by changing the  $p\text{CO}_2$  (or carbonic acid, the denominator in the equation). The  $\text{CO}_2$  diffuses from the cells into the extracellular fluid and reaches the lungs through the blood.
- The rate of respiration (rate of elimination of  $\text{CO}_2$ ) is controlled by the chemoreceptors in the respiratory center which are sensitive to changes in the pH of blood.
- When there is a fall in pH of plasma (**acidosis**), the respiratory rate is stimulated resulting in **hyperventilation**. This would eliminate more  $\text{CO}_2$ , thus lowering the  $\text{H}_2\text{CO}_3$  level (Box 29.3).
- However, this can not continue for long. The respiratory system responds to any change in pH immediately, but it cannot proceed to completion.

### Action of Hemoglobin

- The hemoglobin serves to transport the  $\text{CO}_2$  formed in the tissues, with minimum change in pH (see isohydric transport, Chapter 22).
- Side by side, it serves to generate bicarbonate or alkali reserve by the activity of the **carbonic anhydrase** system (see Chapter 22).

Carbonic anhydrase



- The reverse occurs in the lungs during oxygenation and elimination of  $\text{CO}_2$ . When the blood reaches the lungs, the bicarbonate re-enters the erythrocytes by reversal of chloride shift. It combines with  $\text{H}^+$  liberated on oxygenation of hemoglobin to form carbonic acid which dissociates into  $\text{CO}_2$  and  $\text{H}_2\text{O}$ .  $\text{CO}_2$  is thus eliminated by the lungs.
 
$$\begin{array}{l} \text{HHb} + \text{O}_2 \longrightarrow \text{HbO}_2 + \text{H}^+ \\ \text{HCO}_3^- + \text{H}^+ \longrightarrow \text{H}_2\text{CO}_3 \\ \text{H}_2\text{CO}_3 \longrightarrow \text{H}_2\text{O} + \text{CO}_2 \end{array}$$
- The activity of the carbonic anhydrase (also called carbonate dehydratase) increases in acidosis and decreases with decrease in  $\text{H}^+$  concentration.

## RENAL REGULATION OF pH

An important function of the kidney is to regulate the pH of the extracellular fluid. Normal urine has a pH around 6; this

pH is lower than that of extracellular fluid (pH = 7.4). This is called **acidification of urine**. The pH of the urine may vary from as low as 4.5 to as high as 9.8, depending on the amount of acid excreted. The major renal mechanisms for regulation of pH are:

- Excretion of  $\text{H}^+$  (Fig. 29.2)
- Reabsorption of bicarbonate (recovery of bicarbonate) (Fig. 29.3)
- Excretion of titratable acid (net acid excretion) (Fig. 29.4)
- Excretion of  $\text{NH}_4^+$  (ammonium ions) (Fig. 29.5).

### Excretion of $\text{H}^+$ ; Generation of Bicarbonate

- This process occurs in the **proximal convoluted tubules** (Fig. 29.2).
- The  $\text{CO}_2$  combines with water to form carbonic acid, with the help of carbonic anhydrase. The  $\text{H}_2\text{CO}_3$  then ionizes to  $\text{H}^+$  and bicarbonate.
- The hydrogen ions are secreted into the tubular lumen; in exchange for  $\text{Na}^+$  reabsorbed. These  $\text{Na}^+$  ions along with  $\text{HCO}_3^-$  will be reabsorbed into the blood.
- There is **net excretion of hydrogen ions, and net generation of bicarbonate**. So this mechanism serves to increase the alkali reserve.

### Reabsorption of Bicarbonate

- This is mainly a mechanism to conserve base. There is no net excretion of  $\text{H}^+$  (Fig. 29.3).
- The cells of the PCT have a sodium hydrogen exchanger. When  $\text{Na}^+$  enters the cell, hydrogen ions from the cell are secreted into the luminal fluid. The hydrogen ions are generated within the cell by the action of **carbonic anhydrase**.

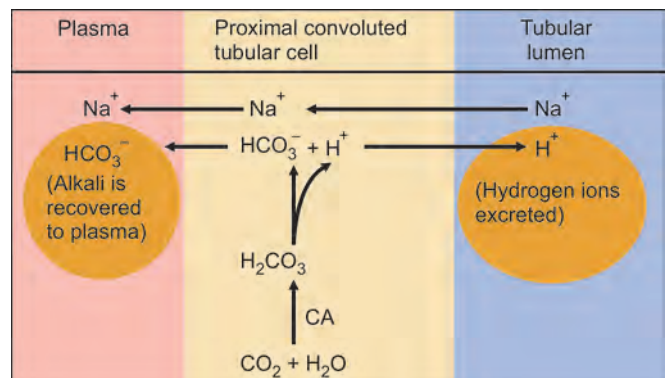


Fig. 29.2: Excretion of hydrogen ions in the proximal tubules; CA = Carbonic anhydrase



- iii. The hydrogen ions secreted into the luminal fluid is required for the reabsorption of filtered bicarbonate.
- iv. Bicarbonate is filtered by the glomerulus. This is completely reabsorbed by the proximal convoluted tubule, so that the urine is normally bicarbonate free.
- v. The bicarbonate combines with  $H^+$  in tubular fluid to form carbonic acid. It dissociates into water and  $CO_2$ . The  $CO_2$  diffuses into the cell, which again combines with water to form carbonic acid.
- vi. In the cell, it again ionizes to  $H^+$  that is secreted into lumen in exchange for  $Na^+$ . The  $HCO_3^-$  is reabsorbed into plasma along with  $Na^+$ .
- vii. Here, there is **no net excretion of  $H^+$**  or generation of new bicarbonate. The net effect of these processes is the reabsorption of filtered bicarbonate which is

Box 29.3: Summary of buffering against acid load

Stages	Features	Buffer components
Normal	Normal ratio = 20:1 Normal pH = 7.4	$HCO_3^-$ (N) $H_2CO_3$ (N)
First line of defense Plasma buffer system	Acidosis; $H^+$ enters blood, bicarbonate is used up	$HCO_3^-$ ( $\downarrow\downarrow$ )
Second line defense Respiratory compensation	Hyperventilation $H_2CO_3 \rightarrow H_2O + CO_2 \uparrow$	$H_2CO_3$ ( $\downarrow$ )
Partially compensated acidosis	Bicarbonate $\downarrow$ ; pH $\downarrow^-$	$HCO_3^-$ ( $\downarrow\downarrow$ ) $H_2CO_3$ ( $\downarrow\downarrow$ )
Third line of defense kidney mechanism	Excretion of $H^+$ ; Reabsorption of bicarbonate; Ratio and pH tend to restore	$HCO_3^-$ ( $\downarrow\downarrow$ ) $H_2CO_3$ ( $\downarrow\downarrow$ )

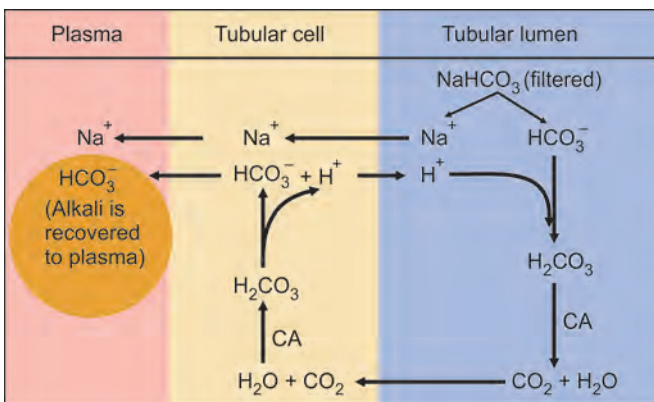


Fig. 29.3: Reabsorption of bicarbonate from the tubular fluid; CA = Carbonic anhydrase

mediated by the Sodium-Hydrogen exchanger. But this mechanism prevents the loss of bicarbonate through urine.

## Excretion of $H^+$ as Titratable Acid

- i. In the **distal convoluted tubules** net acid excretion occurs. Hydrogen ions are secreted by the distal tubules and collecting ducts by **hydrogen ion-ATPase** located in the apical cell membrane. The hydrogen ions are generated in the tubular cell by a reaction catalyzed by **carbonic anhydrase**. The bicarbonate generated within the cell passes into plasma.
- ii. The term titratable acidity of urine refers to the number of milliliters of N/10 NaOH required to titrate 1 liter of urine to pH 7.4. This is a **measure of net acid excretion** by the kidney.
- iii. The major titratable acid present in the urine is sodium acid phosphate. As the tubular fluid passes down the renal tubules more and more  $H^+$  are secreted into the luminal fluid so that its pH steadily falls. The process starts in the proximal tubules, but continues up to the distal tubules.
- iv. Due to the  $Na^+$  to  $H^+$  exchange occurring at the renal tubular cell boarder, the  $Na_2HPO_4$  (basic phosphate) is converted to  $NaH_2PO_4$  (acid phosphate) (Fig. 29.4). As a result, the pH of tubular fluid falls.
- v. The acid and basic phosphate pair is considered as the **urinary buffer**. The maximum limit of acidification is pH 4.5. This process is inhibited by carbonic anhydrase inhibitors like acetazolamide.

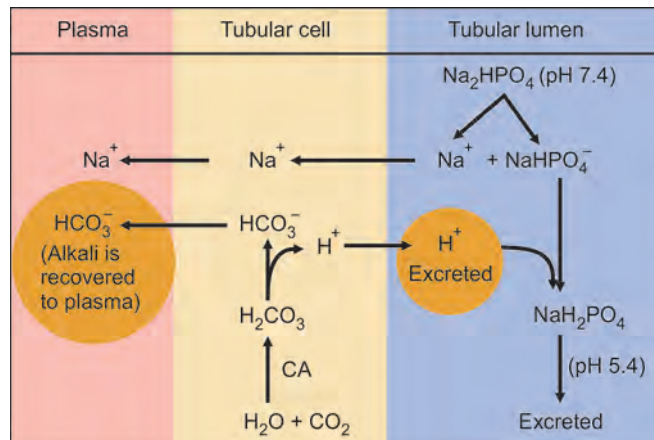


Fig. 29.4: Phosphate mechanism in tubules

## Excretion of Ammonium Ions

- This predominantly occurs at the **distal convoluted tubules**. This would help to excrete  $H^+$  and reabsorb  $HCO_3^-$  (Fig. 29.5).
- This mechanism also helps to trap hydrogen ions in the urine, so that large quantity of acid could be excreted with minor changes in pH. The excretion of ammonia helps in the elimination of hydrogen ions without appreciable change in the pH of the urine.
- The **Glutaminase** present in the tubular cells can hydrolyze glutamine to ammonia and glutamic acid. The  $NH_3$  (ammonia) diffuses into the luminal fluid and combines with  $H^+$  to form  $NH_4^+$  (ammonium ion). The glutaminase activity is increased in acidosis. So large quantity of  $H^+$  ions are excreted as  $NH_4^+$  in acidosis.
- Since it is a positively charged ion, it can accompany negatively charged acid anions; so  $Na^+$  and  $K^+$  are conserved (Fig. 29.5).
- Normally, about 70 mEq/L of acid is excreted daily; but in condition of acidosis, this can rise to 400 mEq/day.
- The enhanced activity of glutaminase and increased excretion of  $NH_4^+$  take about 3–4 days to set in under conditions of acidosis. But once established, it has high capacity to eliminate acid.
- Ammonia is estimated in urine, after addition of formaldehyde. The titratable acidity plus the ammonia content will be a measure of acid excreted from

the body. Maximum urine acidity reached is 4.4. A summary of buffering of acid load in the body is shown in Table 29.3.

## CELLULAR BUFFERS

Cytoplasmic pH varies from 6.8 to 7.3. Intracellular pH modulates a variety of cell functions:

- The activity of several enzymes is sensitive to changes in pH.
- Reduction in pH reduces the contractility of actin and myosin in muscles.
- The electrical properties of excitable cells are also affected by changes in pH.

Intracellular buffers are depicted in Figure 29.1. The major tissues involved in cellular buffering are **bone and skeletal muscle**. The buffering of acid is achieved by the exchange of  $H^+$  that enters into the cells for  $Na^+$  or  $K^+$  ions.

## Relationship of pH with K+ Ion Balance

- When there is increase in  $H^+$  in extracellular fluid (ECF), there may be exchange of  $H^+$  with  $K^+$  from within the cells. Net effect is an apparent increase in ECF potassium level (hyperkalemia).
- In general, acute **acidosis is associated with hyperkalemia** and acute alkalosis with hypokalemia.
- However, in renal tubular acidosis, due to failure to excrete hydrogen ions, potassium is lost in urine; then hypokalemia results.
- Sudden hypokalemia may develop during the correction of acidosis.  $K^+$  may go back into the cells, suddenly lowering the plasma  $K^+$ . Hence it is important to maintain the  $K^+$  balance during correction of alkalosis.

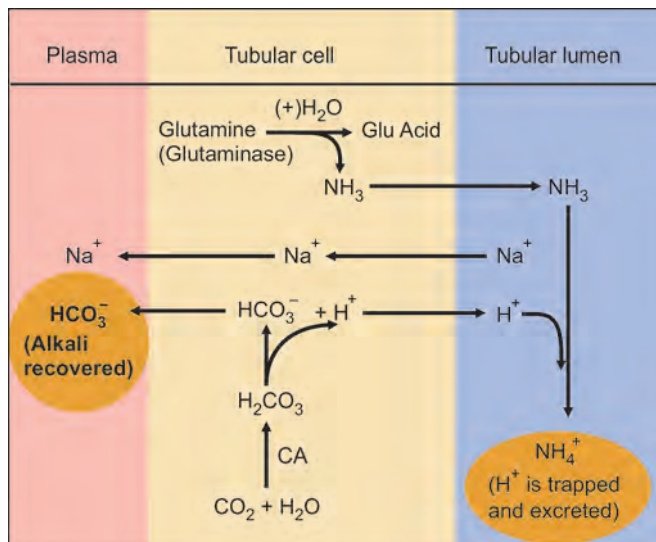


Fig. 29.5: Ammonia mechanism

## Factors affecting Renal Acid Excretion

- Increased filtered load of bicarbonate
- Decrease in ECF volume
- Decrease in plasma pH
- Increase in  $pCO_2$  of blood
- Hypokalemia
- Aldosterone secretion.

## DISTURBANCES IN ACID-BASE BALANCE

**Acidosis** is the clinical state, where acids accumulate or bases are lost. A loss of acid or accumulation of base leads to **alkalosis**. The body cells can tolerate only a narrow range of pH. The extreme ranges of pH are between 7.0 and

7.6, beyond which life is not possible. Box 29.4 shows the conditions in which acid-base parameters are to be checked. Box 29.5 shows the steps to the clinical assessment of acid base status. Box 29.6 summarizes the abnormal findings.

## Classification of Acid-Base Disturbances

### Acidosis (fall in pH)

- Respiratory acidosis: Primary excess of carbonic acid.
- Metabolic acidosis: Primary deficit of bicarbonate (Box 29.6).

### Alkalosis (rise in pH)

- Respiratory alkalosis: Primary deficit of carbonic acid.
- Metabolic alkalosis: Primary excess of bicarbonate (Box 29.6).

## Compensatory Responses

Each of the above disturbance will be followed by a secondary compensatory change in the counteracting variable, e.g. a primary change in bicarbonate involves an alteration in  $p\text{CO}_2$ . Depending on the extent of the compensatory change there are different stages (Table 29.3). In actual clinical states, patients will have different states of compensation (Box 29.7). The compensatory (adaptive) responses are:

- A primary change in bicarbonate involves an alteration in  $p\text{CO}_2$ . The direction of the change is the same as the primary change and there is an attempt at restoring the ratio to 20 and pH to 7.4.
- Adaptive response is always in the same direction as the primary disturbance. **Primary decrease** in arterial bicarbonate involves a reduction in arterial blood  $p\text{CO}_2$  by alveolar hyperventilation.

#### Box 29.4: Acid-base parameters are to be checked in patents with

- Any serious illness
- Multi organ failure
- Respiratory failure
- Cardiac failure
- Uncontrolled diabetes mellitus
- Poisoning by barbiturates and ethylene glycol

#### Box 29.6: Acid-base disturbances

$p\text{CO}_2$	> 45 mm Hg	=	Respiratory acidosis
$p\text{CO}_2$	< 35 mm Hg	=	Respiratory alkalosis
$\text{HCO}_3^-$	> 33 mmol/L	=	Metabolic alkalosis
$\text{HCO}_3^-$	< 22 mmol/L	=	Metabolic acidosis
$\text{H}^+$	> 45 nmol/L	=	Acidosis
$\text{H}^+$	< 35 nmol/L	=	Alkalosis

#### Box 29.5: Steps to the clinical assessment of acid-base disturbances

- Assess pH (normal 7.4); pH <7.35 is acidemia and >7.45 is alkalemia
- Serum bicarbonate level: See Box 29.6.
- Assess arterial  $p\text{CO}_2$ : See Box 29.6.
- Check compensatory response: Compensation never overcompensates the pH. If pH is <7.4, acidosis is the primary disorder. If pH is >7.4, alkalosis is primary.
- Assess anion gap.
- Assess the change in serum anion gap/change in bicarbonate.
- Assess if there is any underlying cause.

#### Box 29.7: Acid base disturbances. Expected renal and respiratory compensations

Metabolic acidosis: Expect  $p\text{CO}_2$  to be reduced by 1 mm Hg for every 1 mmol/L drop in bicarbonate.  
 Metabolic alkalosis: Expect  $p\text{CO}_2$  to be increased by 0.6 mm Hg for every 1 mmol/L rise in bicarbonate.  
 Acute respiratory acidosis: Expect 1 mmol/L increase in bicarbonate per 10 mm Hg rise in  $p\text{CO}_2$ .  
 Chronic respiratory acidosis: Expect 3.5 mmol/L increase in bicarbonate per 10 mm Hg rise in  $p\text{CO}_2$ .  
 Acute respiratory alkalosis: Expect 2 mmol/L decrease in bicarbonate per 10 mm Hg fall in  $p\text{CO}_2$ .  
 Chronic respiratory alkalosis: Expect 4 mmol/L decrease in bicarbonate per 10 mm Hg fall in  $p\text{CO}_2$ .

**TABLE 29.3:** Types of acid-base disturbances

Disturbance	pH	Primary change	Ratio	Secondary change
Metabolic acidosis	Decreased	Deficit of bicarbonate	<20	Decrease in $\text{PaCO}_2$
Metabolic alkalosis	Increased	Excess of bicarbonate	>20	Increase in $\text{PaCO}_2$
Respiratory acidosis	Decreased	Excess of carbonic acid	<20	Increase in bicarbonate
Respiratory alkalosis	Increased	Deficit of carbonic acid	>20	Decrease in bicarbonate

- c. Similarly, a **primary increase** in arterial  $p\text{CO}_2$  involves an increase in arterial bicarbonate by an increase in bicarbonate reabsorption by the kidney.
- d. The compensatory change will try to restore the pH to normal. However, the compensatory change cannot fully correct a disturbance.
- e. **Clinically**, acid-base disturbance states may be divided into:
  - i. Uncompensated
  - ii. Partially compensated
  - iii. Fully compensated (Table 29.4).

### Mixed Responses

- i. If the disturbance is pure, it is not difficult to accurately assess the nature of the disturbance (Box 29.7). In mixed disturbances, both  $\text{HCO}_3^-$  and  $\text{H}_2\text{CO}_3$  levels are altered (Fig. 29.6).
- ii. The adaptive response always involves a change in the counteracting variable; e.g. a primary change in bicarbonate involves an alteration in  $p\text{CO}_2$ .
- iii. Adaptive response is always in the same direction as the primary disturbance.
- iv. Depending on the extent of the compensatory change there are different stages. Looking at the parameters, the stage of the compensation can be identified (Table 29.4).

**TABLE 29.4: Stages of compensation**

Stage	pH	$\text{HCO}_3^-$	$\text{PaCO}_2$	Ratio
Metabolic acidosis	Low	Low	N	<20
Uncompensated	Low	Low	N	<20
Partially compensated	Low	Low	Low	<20
Fully compensated	N	Low	Low	20
Metabolic alkalosis	High	High	N	>20
Uncompensated	High	High	N	>20
Partially compensated	High	High	High	>20
Fully compensated	N	High	High	20
Respiratory acidosis	Low	N	High	<20
Uncompensated	Low	N	High	<20
Partially compensated	Low	High	High	<20
Fully compensated	N	High	High	20
Respiratory alkalosis	High	N	Low	>20
Uncompensated	High	N	Low	>20
Partially compensated	High	Low	Low	>20
Fully compensated	N	Low	Low	20

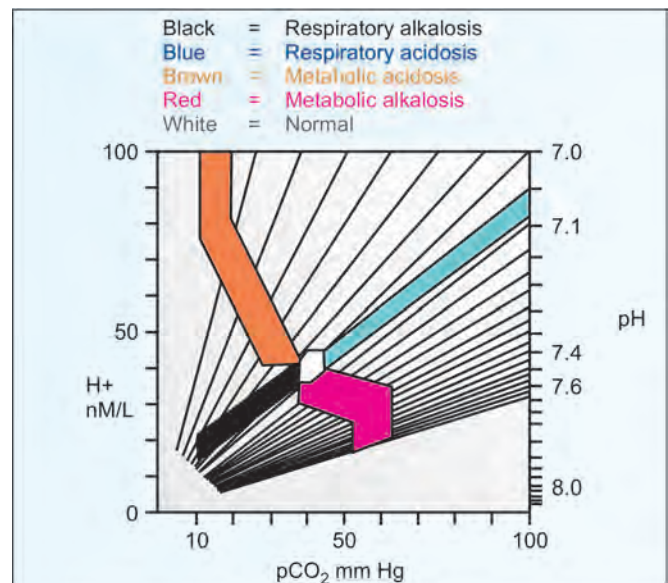
## Chemical Pathology of Acid-Base Disturbances

### Metabolic Acidosis

- i. It is due to a **primary deficit in the bicarbonate**. This may result from an accumulation of acid or depletion of bicarbonate.
- ii. When there is excess acid production, the bicarbonate is used up for buffering. Depending on the cause, the anion gap is altered.

### Anion Gap

- i. The sum of cations and anions in ECF is always equal, so as to maintain the electrical neutrality. Sodium and potassium together account for 95% of the cations whereas chloride and bicarbonate account for only 86% of the anions (Fig. 29.7). Only these electrolytes are commonly measured.
- ii. Hence, there is always a difference between the measured cations and the anions. The **unmeasured anions constitute the anion gap**. This is due to the presence of protein anions, sulphate, phosphate and organic acids.
- iii. The anion gap is calculated as the difference between  $(\text{Na}^+ + \text{K}^+)$  and  $(\text{HCO}_3^- + \text{Cl}^-)$ . Normally this is about **12 mmol/L**.



**Fig. 29.6:** Bicarbonate diagram

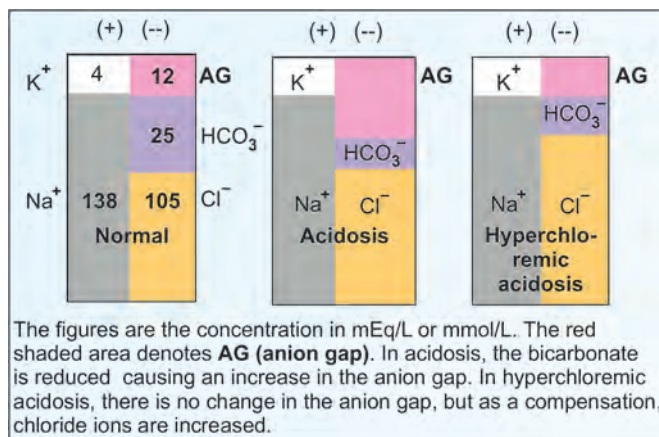


### High Anion Gap Metabolic Acidosis (HAGMA)

- A value between 15 and 20 is accepted as reliable index of accumulation of acid anions in metabolic acidosis (HAGMA) (Table 29.5).
- Renal failure:** The excretion of  $H^+$  as well as generation of bicarbonate are both deficient. The anion gap increases due to accumulation of other buffer anions.
- Diabetic ketoacidosis** (see Chapter 12).
- Lactic acidosis:** Normal lactic acid content in plasma is less than 2 mmol/L. It is increased in tissue hypoxia, circulatory failure, and intake of biguanides (Box 29.8). Lactic acidosis causes a raised anion gap (Box 29.8), whereas diarrhea causes a normal anion gap acidosis (Table 29.6).

Suppose 5 mmol/L lactic acid has entered in blood; this is buffered by bicarbonate, resulting in 5 mmol/L of sodium lactate and 5 mmol/L of carbonic acid. The carbonic acid is dissociated into water and carbon dioxide, which is removed by lung ventilation. The result is lowering of bicarbonate by 5 mmol and presence of 5 mmol of unmeasured anion (lactate), with no changes in sodium or chloride. So, anion gap is increased. In contrast, diarrhea results in the loss of bicarbonate. NaCl is reabsorbed more from kidney tubules to maintain the extracellular volume, resulting in the increase in serum chloride. This chloride compensates for the fall in bicarbonate. So, diarrhea results in hyperchloremic, normal anion gap, metabolic acidosis.

- The gap may be apparently narrowed when cations are decreased (K, Mg and Ca) or when there is hypoalbuminemia. Similarly a spurious elevation is seen in hypergamma globulinemia when positively charged proteins are elevated or when cations are increased (K, Ca and Mg) or in alkalosis when negative charges on albumin are increased.



**Fig. 29.7:** Gamblegram showing cations on the left and anions on the right side. Such bar diagrams were first depicted by Gamble, hence these are called Gamble grams

### Normal Anion Gap Metabolic Acidosis (NAGMA)

When there is a loss of both anions and cations, the anion gap is normal, but acidosis may prevail. Causes are described in Table 29.6.

- Diarrhea:** Loss of intestinal secretions lead to acidosis. Bicarbonate, sodium and potassium are lost.
- Hyperchloremic acidosis** may occur in renal tubular acidosis, acetazolamide (carbonic anhydrase inhibitor) therapy, and ureteric transplantation into large gut (done for bladder carcinoma).

#### Box 29.8. Types of lactic acidosis

Type A :	Impaired lactic acid production with hypoxia. It is seen in - Tissue hypoxia (anaerobic metabolism); Shock (anaphylactic, septic, cardiac); Lung hypoxia, Carbon monoxide poisoning, seizures
Type B:	Impaired lactic acid metabolism without hypoxia. It is seen in - Liver dysfunctions (toxins, alcohol, inborn errors); Mitochondrial disorders (less oxidative phosphorylation and more anaerobic glycolysis) Thiamine deficiency (defective pyruvate dehydrogenase)

**TABLE 29.5:** High anion gap metabolic acidosis (HAGMA) (organic acidosis)

Cause	Remarks
Renal failure	Sulfuric, phosphoric, organic anions. Decreased ammonium ion formation. $Na^+/H^+$ exchange results in decreased acid excretion
Ketosis	Acetoacetate; beta hydroxy butyrate anions. Seen in diabetes mellitus or starvation
Lactic acidosis	Lactate anion. It accumulates when the rate of production exceeds the rate of consumption
Salicylate	Aspirin poisoning
Amino acidurias	Acidic metabolic intermediates Accumulation due to block in the normal metabolic pathway
Organic acidurias	Organic acids (methyl malonic acid, propionic acid, etc.) excreted
Methanol	Formate, Glycolate, Oxalate ions. Acids formed lead to increase in AG. Increase in plasma osmolality. Osmolal gap is also seen
Drugs	Corticosteroids, Dimercaprol, Ethacrynic acid, Furosemide, Methanol, Nitrates, Salicylates, Thiazides

- a. **Renal tubular acidosis** may be due to failure to excrete acid or reabsorb bicarbonate.
  - b. Chloride is elevated since electrical neutrality has to be maintained.
  - c. In ureteric transplantation, the chloride ions are reabsorbed in exchange for bicarbonate ions lost, leading to hyperchloremic acidosis.
  - d. **Acetazolamide** therapy results in metabolic acidosis because  $\text{HCO}_3^-$  generation and  $\text{H}^+$  secretion are affected.
- iii. **Urine anion gap (UAG)** is useful to estimate the ammonium excretion. It is calculated as  $\text{UAG} = \text{UNa} + \text{UK} - \text{UCI}$

The normal value is  $-20$  to  $-50$  mmol/L. In metabolic acidosis, the  $\text{NH}_4\text{Cl}$  excretion increases, and UAG becomes  $-75$  or more. But in RTA, ammonium excretion is defective, and UAG has positive value. Causes for RTA are enumerated in Box 29.9.

#### Decreased Anion Gap is seen in

- Hypoalbuminemia
- Multiple myeloma (paraproteinemia)
- Bromide intoxication
- Hypercalcemia

#### Serum Albumin Levels and Anion Gap

Normal anion gap is affected by the patient's serum albumin level: As a general rule of thumb, the normal anion gap is roughly three times the albumin value, e.g for a patient with an albumin of 4.0, the normal anion gap would be 12. For a patient with chronic liver disease and an albumin of 2.0, the upper limit of normal for the anion gap would be 6. The ceiling

value for a normal anion gap is reduced by 2.5 for every 1g/dL reduction in the plasma albumin concentration.

*Does the anion gap explain the change in bicarbonate?*  $\Delta$  anion gap (Anion gap  $-12$ )  $\simeq$   $\Delta$   $[\text{HCO}_3^-]$ . If  $\Delta$  anion gap is greater; consider additional metabolic alkalosis. If  $\Delta$  anion gap is less; consider a non-anion gap metabolic acidosis.

Corrected Anion gap is given by the formula  $\text{Calculated AG} + 2.5$  (Normal albumin g/dL–Observed albumin in g/dL)

### Osmolal Gap

This is the difference between the measured plasma osmolality and the calculated osmolality, which may be calculated as

$$2 \times [\text{Na}] + [\text{glucose}] + [\text{urea}]$$

#### Box 29.9: Causes of renal tubular acidosis

- Type I (Proximal RTA)
- Multiple myeloma, amyloidosis
  - Heavy metals; lead, mercury
  - Wilson's disease
  - Galactosemia
  - Hyperparathyroidism
  - Paroxysmal nocturnal hemoglobinuria
  - Acetazolamide
- Type II (Distal RTA)
- Autoimmune disorders; SLE, rheumatoid
  - Hypercalciuria
  - Amphotericin B, Lithium
  - Obstructive uropathy
  - Marfan's syndrome
- Type IV
- Impaired aldosterone function

**TABLE 29.6:** Normal anion gap metabolic acidosis (NAGMA) (inorganic acidosis)

Cause	Remarks
Diarrhea, intestinal fistula	Loss of bicarbonate and cations. Sodium or Potassium or both
RTA Type I	Defective acidification of urine I or distal RTA, urine pH is $>5.5$ with hypokalemia Due to inability to reabsorb bicarbonate Compensatory increase in chloride (hyperchloremic acidosis)
Type II	II or proximal RTA, urine pH is $<5.5$ , K normal Due to inability to excrete hydrogen ions
Type IV	Resistance to aldosterone, urine pH $<5.5$ , hyperkalemia
Carbonic anhydrase inhibitors	Loss of bicarbonate, Na and K Similar to proximal RTA
Ureterosigmoidostomy	Loss of bicarbonate and reabsorption of chloride. Hyperchloremic acidosis
Drugs	Antacids containing magnesium, chlorpropamide, iodide (absorbed from dressings), lithium, polymixin B

The normal osmolal gap is <10 mOsm. A high osmolal gap (> 25) implies the presence of unmeasured osmoles such as alcohol, methanol, ethylene glycol, etc. **Acute poisoning** should be considered in patients with a raised anion gap metabolic acidosis and an increased plasma osmolal gap. Poisoning with methanol and ethylene glycol should be considered. They are metabolized to formic acid and oxalic acids correspondingly. Methanol will produce blindness. Ethylene glycol will lead to oxalate crystalluria and renal failure.

### Compensated Metabolic Acidosis

- i. Decrease in pH in metabolic acidosis stimulates the **respiratory** compensatory mechanism and produces hyperventilation-Kussmaul respiration to eliminate carbon dioxide leading to hypocapnia (hypocarbica). The  $p\text{CO}_2$  falls and this would attempt to restore the ratio towards 20 (partial compensation).
- ii. **Renal compensation:** Increased excretion of acid and conservation of base occurs. Na-H exchange,  $\text{NH}_4^+$  excretion and bicarbonate reabsorption are increased. As much as 500 mmol acid is excreted per day. The reabsorption of more bicarbonate also helps to restore the ratio to 20.
- iii. Renal compensation sets in within 2 to 4 days. If the ratio is restored to 20, the condition is said to be fully compensated. But unless the cause is also corrected, restoration of normalcy cannot occur.
- iv. Associated **hyperkalemia** is commonly seen due to a redistribution of  $\text{K}^+$  and  $\text{H}^+$ . The intracellular  $\text{K}^+$  comes out in exchange for  $\text{H}^+$  moving into the cells. Hence, care should be taken while correcting acidosis which may lead to sudden **hypokalemia**. This is more likely to happen in treating diabetic ketoacidosis by giving glucose and insulin together.
- v. However changes in albumin level or changes in the negative charge on the protein molecules can give altered Anion Gap (AG) values. Therefore when pH increases the AG may show an increase and in hypoalbuminemia AG will show a decrease. In order to overcome these difficulties, a new term "Strong ion gap" (SIG) has been introduced, which is the corrected AG.

### Clinical Features of Metabolic Acidosis

The respiratory response to metabolic acidosis is to hyperventilate. So there is marked increase in respiratory

rate and in depth of respiration; this is called as **Kussmaul respiration**. The acidosis is said to be dangerous when pH is < 7.2 and serum bicarbonate is <10 mmol/L. In such conditions, there is depressed myocardial contractility.

### Treatment of Metabolic Acidosis

Treatment is to stop the production of acid by giving IV fluids and insulin. Oxygen is given to patients with lactic acidosis. In all cases, potassium status to be monitored closely and promptly corrected.

**Bicarbonate requirement:** The amount of bicarbonate required to treat acidosis is calculated from the base deficit. In cases of acidosis, mEq of base needed = body wt in Kg  $\times$  0.2 – base excess in mEq/L.

### Metabolic Alkalosis

- i. **Primary excess of bicarbonate** is the characteristic feature. Alkalosis occurs when a) excess base is added, b) base excretion is defective or c) acid is lost. All these will lead to an excess of bicarbonate, so that the ratio becomes more than 20. Important causes and findings are given in Table 29.7. This results either from the loss of acid or from the gain in base.
- ii. Loss of acid may result from severe vomiting or gastric aspiration leading to loss of chloride and acid. Therefore, **hypochloremic alkalosis** results.
- iii. **Hyperaldosteronism** causes retention of sodium and loss of potassium.
- iv. **Hypokalemia** is closely related to metabolic alkalosis. In alkalosis, there is an attempt to conserve hydrogen ions by kidney in exchange for  $\text{K}^+$ . This potassium loss can lead to hypokalemia.
- v. Potassium from ECF will enter the cells in exchange for  $\text{H}^+$ . So, in alkalosis, pH of urine remains acidic; hence this is called **paradoxic acidosis**.

### Subclassification of Metabolic Alkalosis

- i. In **Chloride responsive** conditions, urinary chloride is less than 10 mmol/L. It is seen in prolonged vomiting, nasogastric aspiration or administration of diuretics.
- ii. In **Chloride resistant** condition, urine chloride is greater than 10 mmol/L; it is seen in hypertension, hyperaldosteronism, severe potassium depletion and *Cushing's syndrome*.
- iii. Due to the exogenous base which is often iatrogenic.

## Clinical Features of Metabolic Alkalosis

The respiratory center is depressed by the high pH leading to **hypoventilation**. This would result in accumulation of  $\text{CO}_2$  in an attempt to lower the  $\text{HCO}_3^-/\text{H}_2\text{CO}_3$  ratio. However, the compensation is limited by the hypoxic stimulation of respiratory center, so that the increase in  $\text{PaCO}_2$  is not above 55 mm Hg (Box 29.10).

The renal mechanism is more effective which conserves  $\text{H}^+$  and excretes more  $\text{HCO}_3^-$ . However, complete correction of alkalosis will be effective only if potassium is administered and the cause is removed (Table 29.8).

Increased neuromuscular activity is seen when pH is above 7.55. Alkalotic tetany results even in the presence of normal serum calcium.

## Respiratory Acidosis

- i. A **primary excess of carbonic acid** is the cardinal feature. It is due to  $\text{CO}_2$  retention as a result of hypoventilation. The ratio of bicarbonate to carbonic acid will be less than 20. Depending on whether the condition is of acute or chronic onset, the extent of compensation varies.
- ii. **Acute** respiratory acidosis may result from **bronchopneumonia** or status asthmaticus.

- iii. Depression of respiratory center due to overdose of sedatives or **narcotics** may also lead to hypercapnia.
- iv. **Chronic** obstructive lung disease will lead to chronic respiratory acidosis, where the fall in pH will be minimal. The findings in chronic and acute respiratory acidosis are summarized in Table 29.8.

Excess carbonic acid is buffered by hemoglobin and protein buffer systems. This could cause a slight rise in bicarbonate. Kidneys respond by conserving base ( $\text{HCO}_3^-$ ) and excreting  $\text{H}^+$  as  $\text{NH}_4^+$ . Chronic cases will be well compensated unlike acute cases. In respiratory acidosis, bicarbonate level is increased (not decreased).

Clinically, there is decreased respiratory rate, hypotension and coma. Hypercapnia may lead to peripheral vasodilation, tachycardia and tremors. The findings in chronic and acute respiratory acidosis are summarized in Table 29.8. The renal compensation occurs, generating more bicarbonate and excreting more  $\text{H}^+$ .

## Respiratory Alkalosis

- i. A **primary deficit of carbonic acid** is described as respiratory alkalosis. Hyperventilation will result in washing out of  $\text{CO}_2$ . So, bicarbonate: carbonic acid ratio is more than 20.

**TABLE 29.7:** Metabolic alkalosis

Type	Causes	Changes
Chloride responsive alkalosis Contraction alkalosis	Prolonged vomiting, Nasogastric suction, Upper GI obstruction	Urine chloride <10 mmol/L Hypovolemia, increased loss of Cl, K, H ions Increased reabsorption of Na with bicarbonate Loss of $\text{H}^+$ and $\text{K}^+$ Hypokalemia leads to alkalosis due to $\text{H}^+$ - $\text{K}^+$ exchange. Cl is reabsorbed along with Na Hence urine chloride is low Alkalosis responds to administration of NaCl
Loop diuretics	Blocks reabsorption of Na, K and Cl	Aldosterone secretion occurs causing Na retention and wastage of $\text{K}^+$ and $\text{H}^+$
Chloride resistant metabolic alkalosis	Mineralocorticoid excess, Primary and secondary hyperaldosteronism, Glucocorticoid excess, Bartter's syndrome, Cushing's, Adrenal tumor.	Urine chloride > 20 mmol/L Defective renal $\text{Cl}^-$ reabsorption Associated with an underlying cause where excess mineralocorticoid activity results in increased sodium retention with wastage of H and K ions at the renal tubules
Exogenous base	Intravenous bicarbonate, Massive blood transfusion, Anatacids, Milk alkali syndrome Sodium citrate overload	Excess base enters the body or potential generation of bicarbonate from metabolism of organic acids like lactate, ketoacids, citrate and salicylate



- ii. Causes are hysterical **hyperventilation**, raised intracranial pressure and brain stem injury.
- iii. Early stage of salicylate poisoning causes respiratory alkalosis due to stimulation of respiratory center. But later, it ends up in metabolic acidosis due to accumulation of organic acids, lactic and keto acids.
- iv. Other causes include lung diseases (pneumonia, pulmonary embolism),
- v.  $p\text{CO}_2$  is low, pH is high and bicarbonate level normal. But bicarbonate level falls, when compensation occurs. Compensation occurs immediately in acute stages. In prolonged chronic cases renal compensation sets in. Bicarbonate level is reduced by decreasing the reclamation of filtered bicarbonate.
- vi. Clinically, hyperventilation, muscle cramps, tingling and paresthesia are seen. Alkaline pH will favor increased binding of calcium to proteins, resulting in a decreased ionized calcium, leading to paresthesia. Causes of acidosis and alkalosis are enumerated in Box 29.11.

### Assessment of Acid-Base Parameters

- i. The assessment of acid-base status is usually done by the **arterial blood gas (ABG) analyzer**, which measures pH,  $p\text{CO}_2$  and  $p\text{O}_2$  directly, by means of electrodes. Arterial blood is used to measure the acid-base parameters.
- ii. In the absence of a blood gas analyzer, venous blood may be collected under paraffin (to eliminate contact with air). Bicarbonate is estimated by titration to pH 7.4. From the values of  $\text{Na}^+$ ,  $\text{K}^+$ ,  $\text{Cl}^-$  and  $\text{HCO}_3^-$ , the anion gap is calculated. Most of the critical care analyzers estimate the blood gas, electrolytes and calculate the anion gap. For clinical assessment, instead of Henderson-Hasselbalch equation a modified version, **Henderson equation** is used.

#### Box 29.10: Maximum limits of compensation

Metabolic acidosis, $p\text{CO}_2$	= 15 mm of Hg
Metabolic alkalosis, $p\text{CO}_2$	= 50 mm of Hg
Respiratory acidosis, bicarbonate	= 32 mmol/L
Respiratory alkalosis, bicarbonate	= 15 mmol/L

**TABLE 29.8:** Lab findings in respiratory acidosis

	pH	$p\text{CO}_2$	$\text{HCO}_3^-$
Acute respiratory acidosis	↓↓	↑↑	N or ↑
Chronic respiratory acidosis (partially compensated)	↓	↑	↑↑
N = normal; ↓ = decreased; ↑ = increased			

$$\text{H}^+ (\text{nmol/L}) = \frac{24 \times \text{PCO}_2 \text{ in mm of Hg}}{\text{HCO}_3^-}$$

24 in the equation is a constant and takes into account pK and gas solubility. From the  $\text{H}^+$  concentration thus obtained, the pH may be calculated. A change in pH unit by 0.01 represents a change in  $\text{H}^+$  by 1 nmol/L, from the normal value of 40 nmol/L. For example,  
 $\text{H}^+ = 50 \text{ nmol/L} = 7.4 - (10 \times .01) = 7.3$   
 $\text{H}^+ = 30 \text{ nmol/L} = 7.4 + (10 \times .01) = 7.5$

### Arterial Oxygen Saturation ( $\text{SaO}_2$ )

It is measured by pulse oximeter.  $\text{SaO}_2$  assesses oxygenation, but will give no information about the respiratory ventilation. A small drop in  $\text{SaO}_2$  represents a large drop in  $\text{PO}_2$ . Increased ventilation will lower the  $\text{PCO}_2$ , leading to respiratory alkalosis. Decreased ventilation will raise the  $\text{PCO}_2$  and lead to a respiratory acidosis.

### Normal Serum Electrolyte Values

Please see box 29.12. Students should always remember these values. Upper and lower limits are shown in Box 29.10. The causes of acid-base disturbances are shown in Box 29.11. Some examples of abnormalities are given in Tables 29.9 and 29.10.

### Related Topics

Renal mechanisms and renal function tests are described in Chapter 27. Metabolisms of sodium, potassium and chloride are described in Chapter 30.

#### Box 29.11: Causes of acid-base disturbances

Acidosis	Alkalosis
<b>A. Respiratory Acidosis</b>	<b>A. Respiratory Alkalosis</b>
Pneumonia	High altitude
Bronchitis, asthma	Hyperventilation
COPD, pneumothorax	Hysteria
Narcotics, sedatives	Febrile conditions
Paralysis of respiratory muscles	Septicemia
CNS trauma, tumor	Meningitis
Ascites, peritonitis	Congestive cardiac failure
Sleep apnea	
<b>B. Metabolic Acidosis</b>	<b>B. Metabolic Alkalosis</b>
<b>i. High anion gap</b>	Severe vomiting
Diabetic ketosis	Cushing syndrome
Lactic acidosis	Milk alkali syndrome
Renal failure	Diuretic therapy
<b>ii. Normal anion gap</b>	(potassium loss)
Renal tubular acidosis (hyperchloremic)	
CA inhibitors	
Diarrhea	
Addison's disease	

## Clinical Case Study 29.1

Interpret the data and give the type of acid base disturbance. Blood pH – 7.12,  $p\text{CO}_2$  – 80 mm Hg, Plasma Bicarbonate – 26 mEq/L,  $\text{H}_2\text{CO}_3$  – 20.7 mEq/L. What are the causes for the condition?

**Box 29.12: Normal serum electrolyte and arterial blood gas values**

pH	=	7.4
Bicarbonate	=	22–26 mmol/L
Chloride	=	96–106 mmol/L
Potassium	=	3.5–5 mmol/L
Sodium	=	136–145 mmol/L
$\text{PO}_2$	=	95 (85–100) mm Hg
$\text{PCO}_2$	=	40 (35–45) mm Hg

**TABLE 29.9: Acid-base abnormalities**

No.	pH	$p\text{CO}_2$ mmHg	$\text{HCO}_3^-$ mmol/L	Interpretation
1.	7.14	15	5	Overcompensated metabolic acidosis
2.	7.21	70	27	Uncompensated respiratory acidosis
3.	7.4	60	36	Fully compensated metabolic alkalosis
4.	7.32	30	15	Partially compensated metabolic acidosis
5.	7.50	46	35	Partially compensated metabolic alkalosis
6.	7.57	25	22	Uncompensated respiratory alkalosis
7.	7.59	45	42	Partially compensated metabolic alkalosis

**TABLE 29.10: Limits of compensation**

Disturbance	Limits of compensation
Metabolic acidosis	$\text{PCO}_2$ falls by 1 to 1.3 mm of Hg If $\text{PCO}_2$ is higher, it is a combined metabolic and respiratory acidosis
Metabolic alkalosis	$\text{PCO}_2$ increases 6 mms of Hg for each 10 mmol increase in bicarbonate $\text{HCO}_3^- + 15 =$ Last two digits of pH If $\text{PCO}_2$ is higher, a coexisting respiratory acidosis is present
Respiratory acidosis	Acute: $\text{HCO}_3^-$ increase by 1 mmol for every 10 mms rise in $\text{PCO}_2$ Chronic: $\text{HCO}_3^-$ increases by 3.5 mmol/L
Respiratory alkalosis	Acute: $\text{HCO}_3^-$ falls by 2 mmol/L for every 10 mm fall in $\text{PCO}_2$ . Chronic: $\text{HCO}_3^-$ falls by 5 mmol/L for every 10 mms fall in $\text{PCO}_2$

## Clinical Case Study 29.2

A patient was operated for intestinal obstruction and had continuous gastric aspiration for 3 days. Blood pH – 7.55,  $p\text{CO}_2$  – 50 mm Hg, plasma bicarbonate – 30 mEq/L, serum sodium – 130 mmol/L, serum potassium – 2.9 mmol/L, serum chloride – 95 mmol/L. Comment on the obtained values. What is the significance of potassium in acid base status assessment? Why is chloride measured in this patient? Calculate and comment on the anion gap.

## Clinical Case Study 29.3

Interpret the data and give the type of acid-base disturbance. Blood pH – 7.54,  $p\text{CO}_2$  – 20 mm Hg, plasma bicarbonate – 26 mEq/L,  $\text{H}_2\text{CO}_3$  – 0.7 mEq/L. What are the causes for the condition?

## Clinical Case Study 29.1 Answer

Respiratory acidosis.

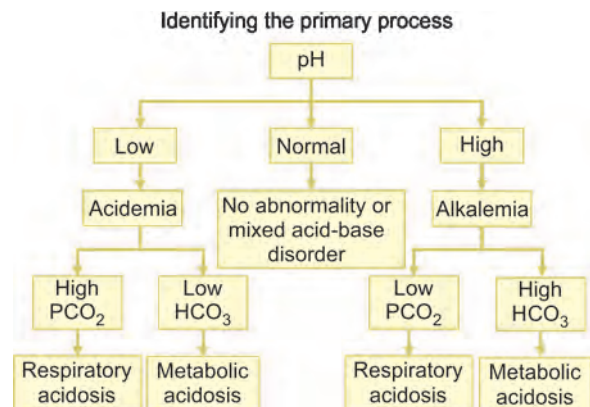
## Clinical Case Study 29.2 Answer

Metabolic alkalosis.

## Clinical Case Study 29.3 Answer

Respiratory alkalosis.

## QUICK LOOK OF CHAPTER 29



1. The pH of plasma is 7.4. The regulation is by buffers, lungs and kidney.
2. Buffer systems of the body are bicarbonate, phosphate, Hb, proteins.
3. Bicarbonate buffer system is quantitatively the most significant among body buffers.

4. Anion gap is the unmeasured anions. Normal value is about  $12 \pm 5$  mM /L.
5. Metabolic acidosis is due to primary deficit in bicarbonate while respiratory acidosis is due to a primary excess of carbonic acid.
6. Metabolic alkalosis is due to primary excess of bicarbonate, while respiratory alkalosis is due to primary deficit of carbonic acid.
7. Metabolic acidosis is seen during renal tubular acidosis, diabetic ketosis and organic acidemias.
8. Metabolic alkalosis occurs in hyperaldosteronism, hypokalemia and Cushing's syndrome.
9. Respiratory acidosis may result from bronchopneumonia and chronic obstructive lung disease.
10. Respiratory alkalosis results from hysteria, raised intra cranial pressure and salicylate poisoning.

# CHAPTER 30

## Electrolyte and Water Balance

### Chapter at a Glance

The reader will be able to answer questions on the following topics:

- Intake and output of water
- Osmolality of extracellular fluid
- Electrolyte composition of body fluids
- Regulation of sodium and water balance
- Renin-angiotensin system
- Isotonic/hypotonic/hypertonic contraction, ECF
- Isotonic/hypotonic/hypertonic expansion, ECF
- Sodium metabolism
- Potassium metabolism
- Chloride metabolism

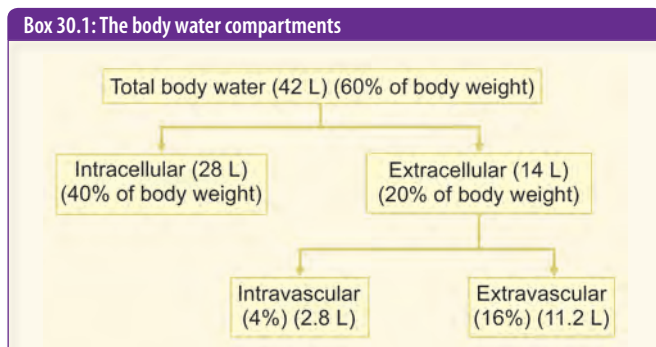
The maintenance of extracellular fluid volume and pH are closely interrelated. The body water compartments are shown in Box 30.1. Body is composed of about 60–70% water. Distribution of water in different body water compartments depends on the solute content of each compartment. Osmolality of the intra- and extracellular fluid is the same, but there is marked difference in the solute content.

### INTAKE AND OUTPUT OF WATER

During oxidation of foodstuffs, 1 g carbohydrate produces 0.6 mL of water, 1 g protein releases 0.4 mL water and 1 g fat generates 1.1 mL of water. Intake of 1000 kcal produces 125 mL water (Table 30.1). The major factors controlling the intake are thirst and the rate of metabolism.

The thirst center is stimulated by an increase in the osmolality of blood, leading to increased intake.

The renal function is the major factor controlling the rate of output. The rate of loss through skin is influenced by



**TABLE 30.1: Water balance in the body**

Intake per day		Output per day	
Water in food	1250 mL	Urine	1500 mL
Oxidation of food	300 mL	Skin	500 mL
Drinking water	1200 mL	Lungs	700 mL
		Feces	50 mL
	2750 mL		2750 mL



the weather, the loss being more in hot climate (perspiration) and less in cold climate. Loss of water through skin is increased to 13% for each degree centigrade rise in body temperature during fever.

## OSMOLALITY OF EXTRACELLULAR FLUID

- Osmolarity** means osmotic pressure exerted by the number of moles per liter of solution.
- Osmolality** is the osmotic pressure exerted by the number of moles per kg of solvent.
- Crystalloids and water can easily diffuse across membranes, but an osmotic gradient is provided by the non-diffusible colloidal (protein) particles. The **colloid osmotic pressure** exerted by **proteins** is the major factor which maintains the intracellular and intravascular fluid compartments. If this gradient is reduced, the fluid will extravasate and accumulate in the interstitial space leading to edema.
- Albumin** is mainly responsible in maintaining this osmotic balance (see Chapter 28). The composition of each body fluid compartment is shown in Figure 30.1 and Table 30.2.
- Since osmolality is dependent on the number of solute particles, the major determinant factor is the **sodium**. Therefore, sodium and water balance are dependent on each other and cannot be considered separately.
- The **osmolality of plasma** varies from 285 to 295 mosm/kg (Table 30.3). It is maintained by the kidney, which excretes either water or solute as the case may be.
- Plasma osmolality can be measured directly using the osmometer or indirectly as the concentration of effective osmoles. It may be roughly estimated for clinical purpose by the formula:

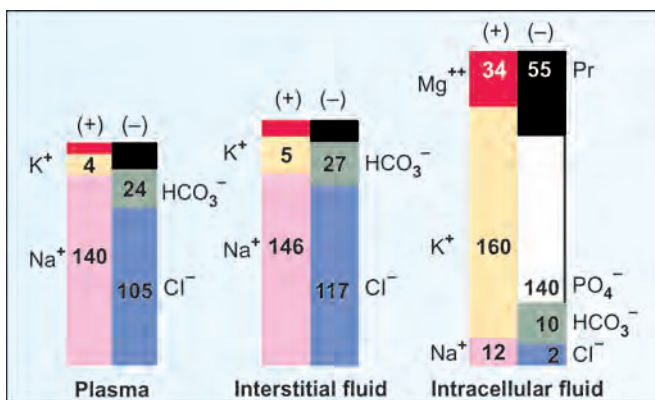


Fig. 30.1: Gamblegrams showing composition of fluid compartments (See also Table 30.2)

Osmolality =  $[Na \times 2 (280)] + [glucose (5)] + [urea (5)] - 10$ ; all values being calculated in mmol/L. Urea in mg /6 gives the concentration in mmol/L. Molecular weight of urea is 60 and median value of normal range is taken as 30 which gives the value as 5 mmol/L. The factor 2 in the above equation is to account for ionization of sodium.

- The difference in measured osmolality and calculated osmolality may increase causing an **Osmolar Gap**, when abnormal compounds like ethanol, mannitol, neutral and cationic amino acids, etc. are present.

## Effective Osmolality

- It is the term used for those extracellular solutes that determine water movement across the cell membrane. Permeable solutes, such as urea and alcohol enter into the cell and achieve osmotic equilibrium. Although there is increase in osmolality, there is no shift in water.

TABLE 30.2: Electrolyte concentration of body fluid compartments (Compare with Fig. 30.1)

Solutes	Plasma mEq / L	Interstitial fluid (mEq/L)	Intracellular fluid (mEq/L)
<b>Cations:</b>			
Sodium	140	146	12
Potassium	4	5	160
Calcium	5	3	–
Magnesium	1.5	1	34
<b>Anions:</b>			
Chloride	105	117	2
Bicarbonate	24	27	10
Sulfate	1	1	–
Phosphate	2	2	140
Protein	15	7	54
Other anions	13	1	–

Note - mEq/L = mmol/L  $\times$  valency

TABLE 30.3: Osmolality of plasma

Solute	Osmolality in mmol/kg			
Sodium with anions	–	–	270	92%
Potassium with anions	–	–	7	} 8%
Calcium with anions	–	–	3	
Magnesium with anions	–	–	1	
Urea	–	–	5	
Glucose	–	–	5	
Proteins	–	–	1	
			292	

- ii. On the other hand, if **impermeable solutes** like glucose, mannitol, etc. are present in ECF, water shifts from ICF to ECF and extracellular osmolality is increased.
- iii. So, for every 100 mg/dL increase in glucose, 1.5 mmol/L of sodium is reduced (**dilutional hyponatremia**). Hence, the plasma sodium is a reliable index of total and effective osmolality in the normal and clinical situations. See summary in Box 30.2.

## Regulation of Sodium and Water Balance

The major regulatory factors are the hormones (aldosterone, ADH) and the renin-angiotensin system.

**Aldosterone** secreted by the zona glomerulosa of the adrenal cortex regulates the  $\text{Na}^+ \rightarrow \text{K}^+$  exchange and  $\text{Na}^+ \rightarrow \text{H}^+$  exchange at the renal tubules. The net effect is sodium retention.

## Anti-diuretic Hormone (ADH)

When osmolality of the plasma rises, the osmoreceptors of hypothalamus are stimulated, resulting in ADH secretion. ADH will increase the water reabsorption by the renal tubules. Therefore, proportionate amounts of sodium and water are retained to maintain the osmolality.

When osmolality decreases, ADH secretion is inhibited. When ECF volume expands, the aldosterone secretion is cut off.

## Renin-Angiotensin System

When there is a fall in ECF volume, renal plasma flow decreases and this would result in the release of renin by the juxtaglomerular cells (Box 30.3). The factors which stimulate renin release are:

- a. Decreased blood pressure
- b. Salt depletion
- c. Prostaglandins.

### Box 30.2: Summary of ECF and ICF

1. At equilibrium, the osmolality of extracellular fluid (ECF) and intracellular fluid (ICF) are identical
2. Solute content of ICF is constant
3. Sodium is retained only in the ECF
4. Total body solute divided by total body water gives the body fluid osmolality
5. Total intracellular solute divided by plasma osmolality will be equal to the intracellular volume.

The inhibitors of renin release are:

- a. Increased blood pressure
- b. Salt intake
- c. Prostaglandin inhibitors
- d. Angiotensin-II. Renin is the enzyme acting on the angiotensinogen (an alpha-2 globulin, made in liver) (Boxes 30.3 and 30.4).

## Clinical Significance

Angiotensin-converting enzyme (ACE) is a glycoprotein present in the lung. ACE-inhibitors are useful in treating edema and chronic congestive cardiac failure. Various peptide analogs of Angiotensin-II (Saralasin) and antagonists of the converting enzyme (Captopril) are useful to treat renin-dependent hypertension. Angiotensin-I is inactive; II and III are active.

## Autoregulation

Angiotensin-II increases blood pressure by causing vasoconstriction of the arterioles. It stimulates aldosterone production by enhancing conversion of corticosterone to aldosterone. It also inhibits renin release from the juxtaglomerular cells. The events thus leading to maintenance of sodium and water balance as well as ECF volume are summarized in Figure 30.2.

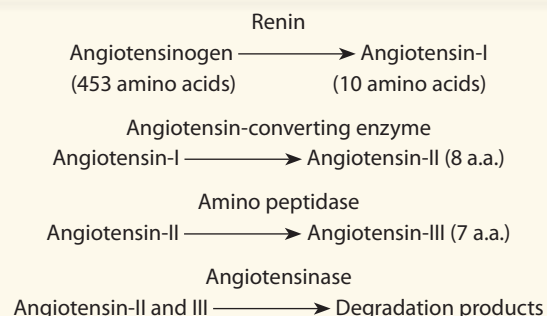
**Atrial natriuretic peptides** are secreted in response to the stimulation of atrial stretch receptors. They inhibit renin and aldosterone secretion and eliminate sodium. Table 30.4 gives the physiological stimuli involved in the control of sodium and water balance.

### Box 30.3: Renin and Rennin are different

Kidney secretes **Renin**; it is involved in fluid balance and hypertension.

**Rennin** is a proteolytic enzyme seen in gastric juice, especially in children.

### Box 30.4: Pathway of angiotensin production



## Disturbances in Fluid and Electrolyte Balance

Assessment of fluid and electrolyte balance is summarized in Box 30.5. Abnormalities in fluid and electrolyte balance can be expressed in terms of tonicity. When the effective osmolality is increased, the body fluid is called **hypertonic** and when osmolality is decreased the body fluid is called **hypotonic**. A classification is given in Table 30.5.

Clinical effects of **increased** effective osmolality are due to dehydration of cells. A patient may be comatose when serum sodium reaches 160 mmol/L rapidly; but remains conscious if it occurs gradually, even if serum sodium increases up to 190 mmol/L. A sudden **reduction** of effective osmolality may cause brain cells to swell leading to headache, vomiting and medullary herniation.

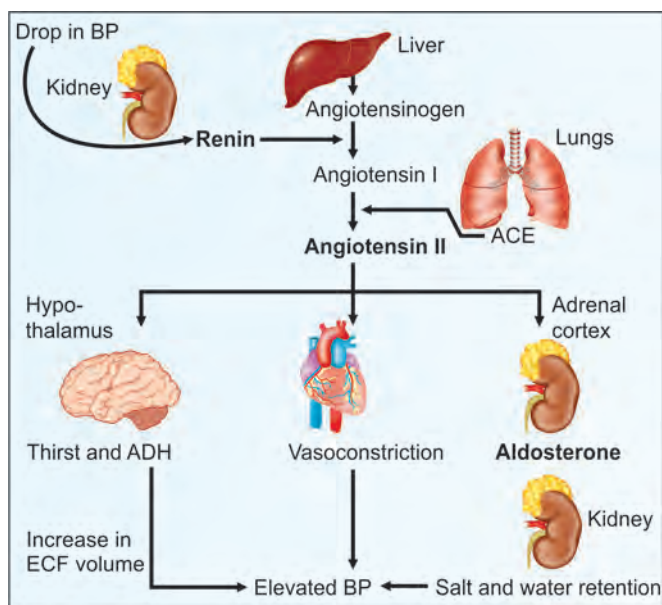


Fig. 30.2: Renin-angiotensin-aldosterone

TABLE 30.4: Control of sodium and water

Factor	Acting through	Effect
Extracellular osmolality	Thirst and ADH	• Water intake; • Reabsorption of water from kidney
Hypovolemia	Stimulation of thirst and ADH	• Retention of water
-do-	Stimulates aldosterone	• Retention of sodium
Expansion of ECF	Inhibits aldosterone	• Reabsorption of sodium
Hypo-osmolality	Inhibits ADH secretion	• Reabsorption of water

Some important clinical features of electrolyte imbalance are shown in Box 30.6. Different types of abnormalities due to disturbances in fluid and electrolyte balance are given below:

### Isotonic Contraction

This results from the loss of fluid that is isotonic with plasma. The most common cause is loss of gastrointestinal fluid, due to

- Small intestinal fistulae
- Small intestinal obstruction and paralytic ileus where fluid accumulates in the lumen
- Recovery phase of renal failure.

Since equivalent amounts of sodium and water are lost, the plasma sodium is often normal. For this reason, patient may not feel thirsty.

Box 30.5: Assessment of sodium and water balance

- Maintenance of intake-output chart, in cases of patients on IV fluids. The insensible loss of water is high in febrile patients
- Measurement of serum electrolytes (sodium, potassium, chloride and bicarbonate). This will give an idea of the excess, depletion or redistribution
- Measurement of hematocrit value to see if there is hemoconcentration or dilution
- Measurement of urinary excretion of electrolytes, especially sodium and chloride.

TABLE 30.5: Disturbances of fluid volume

Abnormality	Biochemical features	Osmolality
<b>Expansion of ECF</b>		
Isotonic	Retention of Na <sup>+</sup> , water	Normal
Hypotonic	Relative water excess	Decreased
Hypertonic	Relative sodium excess	Increased
<b>Contraction of ECF</b>		
Isotonic	Loss of Na <sup>+</sup> and water	Normal
Hypotonic	Relative loss of Na <sup>+</sup>	Decreased
Hypertonic	Relative loss of water	Increased

Box 30.6: Clinical features of electrolyte imbalance

- Hypo-osmolality and hyponatremia go hand in hand
- Hypo-osmolality causes swelling of cells and hyper-osmolality causes dehydration of cells
- Hyponatremia of ECF causes symptoms only when associated with hyperkalemia
- Dilutional hyponatremia due to glucose or mannitol increases the effects of hyperosmolality
- Fatigue and muscle cramps are the common symptoms of electrolyte depletion
- Hypo-osmolality of gastrointestinal cells causes nausea, vomiting and paralytic ileus.

Hemoconcentration is seen. In severe cases, hypotension may occur. Hypovolemia will reduce renal blood flow and may cause renal circulatory insufficiency, oliguria and uremia.

Compensatory mechanisms will try to restore the volume. Renin-aldosterone system is activated, and selective sodium reabsorption occurs. ADH secretion leads to reabsorption of equivalent amounts of water.

### Hypotonic Contraction

There is predominant sodium depletion. The causes are:

- Infusion of fluids** with low sodium content like dextrose. When low sodium containing fluids are infused, the hypo-osmolality will inhibit ADH secretion resulting in water loss. Since only the excess fluid is lost, the plasma sodium tends to return to normal. Thus, osmolality is restored, but at the expense of the volume. Therefore in **postoperative cases**, care should be taken to adequately replace sodium by giving sufficient quantity of normal saline.
- Deficiency of aldosterone in Addison's disease. The decreased sodium retention lowers the osmolality and inhibits ADH secretion, resulting in contraction of ECF volume. The hypovolemia stimulates ADH secretion, causing further hemodilution and hyponatremia.

### Hypertonic Contraction

It is predominantly water depletion.

- The commonest cause is **diarrhea**, where the fluid lost has only half of the sodium concentration of the plasma.
- Vomiting and excessive sweating can also cause a similar situation.
- Diabetes insipidus is a very rare cause.
- Hypernatremia is present with a high plasma osmolality. But the volume depletion will reduce renal blood flow and stimulates aldosterone secretion leading to further sodium retention and aggravating hypertension.
- The increase in osmolality will stimulate thirst and increase in the water intake. ADH secretion occurs and urine volume decreases.

### Isotonic Expansion

Water and sodium retention is often manifested as **edema** and occurs secondary to **hypertension or cardiac failure**. Hemodilution is the characteristic finding. Secondary **hyper-aldosteronism** may result from any cause leading to a reduced plasma volume in spite of a high ECF volume. This often results from hypoalbuminemia (edema in nephrotic syndrome, protein malnutrition, etc.). In these cases, the water retention causes ADH secretion. The intravascular volume cannot be restored since the low colloid osmotic pressure tends to drive the fluid out into the extravascular space, aggravating the edema. The ECF volume can be restored only by correcting the cause.

### Hypotonic Expansion

Predominant water excess results only when the normal homeostatic mechanisms fail. There is water retention either due to glomerular dysfunction or ADH excess. The water excess will lower the osmolality.

Hyponatremia persists due to the inhibition of aldosterone secretion by the expanded ECF volume. Inhibition of ADH secretion and excretion of large volumes of dilute urine can improve the situation. Cellular overhydration can result in unconsciousness or death.

### Hypertonic Expansion

It can occur in cases of Conn's syndrome and Cushing's syndrome. The excess mineralocorticoid would produce sodium retention. Resultant increase in the plasma osmolality is expected to increase the ADH secretion, and thereby to restore the osmolality. However, continued effect of aldosterone will cause sodium retention. There is associated hypokalemia which often leads to metabolic alkalosis. Extracellular hypertonicity may lead to brain cell dehydration, leading to coma and death.

## SODIUM (Na<sup>+</sup>)

Sodium level is intimately associated with water balance in the body. Sodium regulates the extracellular fluid volume. Total body sodium is about 4000 mEq. About 50% of it is in bones, 40% in extracellular fluid and 10% in soft tissues. Sodium is the major cation of **extracellular** fluid.

**Sodium pump** is operating in all the cells, so as to keep sodium extracellular. This mechanism is ATP dependent (see Chapter 2). Sodium (as sodium bicarbonate) is also important in the regulation of acid-base balance (see Chapter 29).

Normal level of Na<sup>+</sup> in plasma **136–145 mEq/L** and in cells 12 mEq/L.

Normal diet contains about 5–10 g of sodium, mainly as sodium chloride. The same amount of sodium is daily excreted through urine. However, body can conserve sodium to such an extent that on a sodium-free diet urine does not contain sodium. Ideally dietary sodium intake should be lower than potassium, but processed foods have increased sodium intake.

Normally kidneys are primed to conserve sodium and excrete potassium. When urine is formed, original glomerular filtrate (175 liters per day) contains sodium 800 g/day, out of which 99% is reabsorbed. Major quantity (80%) of this is reabsorbed in proximal convoluted tubules. This is an active process. Along with sodium, water is also facultatively reabsorbed. Sodium reabsorption is primary and water is absorbed secondarily.

Sodium excretion is regulated at the distal tubules. Aldosterone increases sodium reabsorption in distal tubules. Antidiuretic hormone (ADH) increases reabsorption of water from tubules.



Different mechanisms are: a) Sodium hydrogen exchanger located in the proximal convoluted tubules and ascending limb; b) Sodium chloride cotransporter in the distal tubules (ascending limb); c) Sodium channels in the collecting duct; and d) Sodium potassium exchanger in the distal tubule. These are explained in Chapter 29, under renal regulation of pH.

The rate of sodium excretion is directly affected by the rate of filtration of sodium which is decided by the renal plasma flow and blood pressure (acting through atrial natriuretic peptide). The amount reabsorbed is under the control of aldosterone.

## Edema

In edema, along with water, sodium content of the body is also increased. When diuretic drugs are administered, they increase sodium excretion. Along with sodium, water is also eliminated. **Sodium restriction** in diet is therefore advised in congestive cardiac failure and in hypertension.

In the early phases of congestive cardiac failure, hydrostatic pressure on venous side is increased; so water is primarily retained in the body. This causes dilution of sodium concentration, which triggers aldosterone secretion. This is known as **secondary** aldosteronism. Thus sodium is retained, along with further retention of water. This vicious cycle is broken when aldosterone antagonists are administered as drugs.

### Box 30.7: Causes of hypernatremia

1. Cushing's disease
2. Prolonged cortisone therapy
3. In pregnancy, steroid hormones cause sodium retention in the body
4. In dehydration, when water is predominantly lost, blood volume is decreased with apparent increased concentration of sodium
5. Exchange transfusion with stored blood
6. Primary hyperaldosteronism
7. Elderly patients with poor water intake, and inability to express thirst
8. Excessive intake of salt
9. Drugs:
  - Ampicillin
  - Tetracycline
  - Anabolic steroids
  - Oral contraceptives
  - Loop diuretics
  - Osmotic diuretics

## Hypernatremia

Increased sodium in blood is known as hypernatremia. Symptoms of hypernatremia include dry mucous membrane, fever, thirst and restlessness. Causes of hypernatremia are Cushing's disease, prolonged cortisone therapy and pregnancy, where steroid hormones cause sodium retention in the body. Other causes are enumerated in Box 30.7.

## Hyponatremia

Decreased sodium level in blood is called hyponatremia. Clinical signs and symptoms of hyponatremia include dehydration, drop in blood pressure, drowsiness, lethargy, confusion, abdominal cramps, oliguria, tremors and coma. However, hyponatremia is often asymptomatic. Causes of hyponatremia are shown in Box 30.8, most important causes being vomiting, diarrhea, and adrenal insufficiency.

**Hyponatremia due to water retention** is the commonest biochemical abnormality observed in clinical practice. Hyponatremic patients without edema have water overload and they can be treated by water restriction. Hyponatremia with edema is due to both water and sodium overload and will have to be treated by diuretics and fluid restriction.

**SIADH** (Syndrome of inappropriate secretion of anti-diuretic hormone) is a condition with hyponatremia; normal glomerular filtration rate, and normal serum urea and creatinine concentration. Urine flow rate is less than 1.5 L/day. Symptoms are proportional to the rate of fall of sodium and not to the absolute value. Diagnostic criteria for SIADH are shown in Box 30.9. Causes of SIADH are enumerated in Box 30.10.

### Box 30.8: Causes of hyponatremia

1. Vomiting
2. Diarrhea
3. Burns
4. Addison's disease (adrenal insufficiency)
5. Renal tubular acidosis (tubular reabsorption of sodium is defective)
6. Chronic renal failure, nephrotic syndrome
7. Congestive cardiac failure
8. Hyperglycemia and ketoacidosis
9. Excess non-electrolyte (glucose) IV infusion
10. SIADH and defective ADH secretion
11. Pseudo- or dilutional hyponatremia
  - Hyperproteinemia (e.g. myeloma)
  - Mannitol
12. Drugs:
  - ACE inhibitors
  - Lithium
  - NSAIDs
  - Vasopressin and oxytocin
  - Chlorpropamide

**Hypertonic hyponatremia:** Normal body sodium and additional drop in measured sodium due to presence of osmotically active molecules in serum which cause a shift of water from intracellular to extracellular compartment. For example, Hyperglycemia can cause a drop in serum sodium level of 1.6 mmol/L for every 100 mg increase in glucose above 100 mg/dL. When glucose level exceeds 400 mg/dL this drop will also increase to 2.4 mmol/L for every 100 mg increment of glucose above 400 mg/dL. The high level of glucose increases the osmolality leading to hypertonic hyponatremia. A similar effect is seen during mannitol infusion also.

**Normotonic hyponatremia:** Severe hyperlipidemia and paraproteinemia can lead to low measured serum sodium levels with normal osmolality since plasma water fraction falls. This pseudohyponatremia is seen when sodium is measured by flame photometry, but not with ion selective electrode.

**Hypotonic hyponatremia:** It always reflects the inability of kidneys to handle the excretion of water to match oral intake. Assessment of hypernatremia and hyponatremia are shown as flow diagrams in Boxes 30.11 and 30.12 respectively.

**Isotonic fluids** have the same concentration of solutes as cells, and thus no fluid is drawn out or moves into the cell.

**Hypertonic fluids** have a higher concentration of solutes (hyperosmolality) than is found inside the cells, which causes fluid to flow out of the cells and into the extracellular spaces. This causes cells to shrink.

**Hypotonic fluids** have a lower concentration of solutes (hypo-osmolality) than is found inside the cells, which causes fluid to flow into cells and out of the extracellular spaces. This causes cells to swell and possibly burst.

**Treatment** of hyponatremia depends on cause, duration and severity. In acute hyponatremia, rapid correction is possible; but in chronic cases too rapid correction may increase mortality by neurological complications. Effects of administered sodium should be closely monitored, but only after allowing sufficient time for distribution of sodium, a minimum of 4 to 6 hours. Water restriction, increased salt intake, furosemide and anti-ADH drugs are the basis of treatment for hyponatremia.

The correction of hypernatremia and hypertonicity is to be done with care to prevent sudden overhydration and water intoxication. In cases of acute hypernatremia, correction can be quicker. But chronic cases should be treated slowly to prevent cerebral edema. Rapid correction can also cause herniation and permanent neurologic deficit.

#### Box 30.9: Diagnostic criteria for SIADH

- Hyponatremia (<135 mmol/L)
- Decreased osmolality (<270 mOsm/kg)
- Urine sodium >20 mmol/L
- Urine osmolality >100 mOsm/kg.

Appropriate quantity of water should be replaced at a rate so that serum sodium reduction is less than 10 mmol/L in 24 hours.

Serum concentration of sodium is generally measured directly by a **flame photometer or by ion selective electrodes**. When assayed in serum containing hyperlipidemia or hyperglobulinemia, there may be an apparent decrease in sodium concentration.

#### Pseudohyponatremia (PHN)

Clinicians use the term PHN in situations where blood hyperosmolality, usually due to severe hyperglycemia, results in movement of water from the intracellular fluid (ICF) to the extracellular fluid (ECF), diluting all of the solutes in ECF to restore osmotic balance. When that happens, the plasma sodium concentration decreases, along with the concentration of any other plasma constituents that do not freely equilibrate across cell membranes (this is sometimes called “hypertonic hyponatremia”). The reason this is considered “pseudo” (or “false”) hyponatremia is that it does not reflect a deficiency in total body sodium stores, such as occurs in renal sodium loss.

## POTASSIUM (K<sup>+</sup>)

Total body potassium is about 3500 mEq, out of which 75% is in skeletal muscle. Potassium is the major **intracellular** cation, and maintains intracellular osmotic pressure.

The depolarization and contraction of heart require potassium. During transmission of nerve impulses, there is sodium influx and potassium efflux; with depolarization. After the nerve transmission, these changes are reversed.

The intracellular concentration gradient is maintained by the Na<sup>+</sup>-K<sup>+</sup> ATPase pump. The relative concentration of intracellular to extracellular potassium determines the cellular membrane potential. Therefore, minor changes in the extracellular potassium level will have profound effects on cardiovascular and neuromuscular functions. The variations in extracellular potassium levels by redistribution (exchange with cellular potassium) are decided by the sodium-potassium pump.

At rest, membranes are more permeable to potassium than other ions. Potassium channel proteins form specific pores in the membrane, through which potassium ions can pass through by facilitated diffusion. Since the protein anions cannot accompany the potassium, further efflux is prevented by the negative potential developing on the intracellular face of the plasma membrane.

#### Box 30.10: Causes of SIADH

- Infections (Pneumonia, sub-phrenic abscess, TB, aspergillosis)
- Malignancy (Cancer of the colon, pancreas, prostate, small cell cancer of the lungs)
- Trauma (Abdominal surgery, head trauma)
- CNS disorders (Meningitis, encephalitis, brain abscess, cerebral hemorrhage)
- Drug induced (Thiazide diuretics, chlorpropamide, carbamazepine, opiates).

## Requirement

Potassium requirement is 3–4 g per day.

## Sources

Sources rich in potassium, but low in sodium are banana, orange, apple, pineapple, almond, dates, beans, yam and potato. Tender coconut water is a very good source of potassium.

## Normal Level

Plasma potassium level is **3.5–5.2 mmol/L**. The cells contain 160 mEq/L; so precautions should be taken to prevent hemolysis when taking blood for potassium estimation. The  $K^+$  in serum is estimated directly by flame photometry or by using an ion selective electrode. Excretion of potassium is mainly through urine. Aldosterone and corticosteroids increase the excretion of  $K^+$ . On the other hand,  $K^+$  depletion will inhibit aldosterone secretion.

## Potassium Excretion

About 90% of excess potassium is excreted through kidneys and the rest 10% through GIT. Kidney can lower renal excretion to 5–10 mmol per day or increase excretion to 450 mmol per day depending on the potassium intake. The majority of the filtered  $K^+$  (500 mmol) is reabsorbed in the proximal tubule. The control of secretion occurs in the cortical collecting duct. The exchange of potassium for sodium at the renal tubules is a mechanism to conserve sodium and excrete potassium. This is controlled by aldosterone. Aldosterone and corticosteroids increase the excretion of  $K^+$ . On the other hand,  $K^+$  depletion will inhibit aldosterone secretion.

Yet another factor which influences the potassium level is the hydrogen ion concentration. When there is an increase in hydrogen ion concentration of extracellular fluid, there is a redistribution of potassium and hydrogen between cells and plasma. Hydrogen ions are conserved

at the expense of potassium ions and vice versa depending on hydrogen ion concentration. This may lead to a depletion or retention of potassium. (See Chapter 29).

Urinary potassium excretion varies from 30–100 mmol/day, depending on the intake as well as on the amount of hydrogen ions excreted and acid base status. Renal adaptation maintains potassium balance till the GFR drops to 20 mL/min. In chronic renal failure, hyperkalemia is seen since the failing kidney is unable to handle the potassium load.

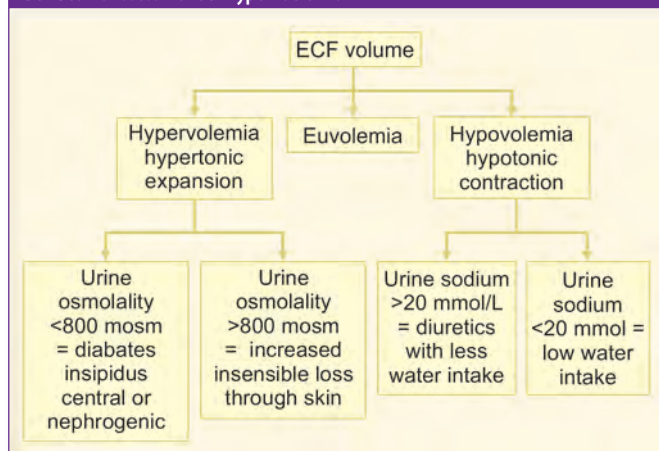
## Hypokalemia

This term denotes that plasma potassium level is below 3 mmol/L. A value less than 3.5 mmol/L is to be viewed with caution. Mortality and morbidity are high. Box 30.13 shows the causes of hypokalemia.

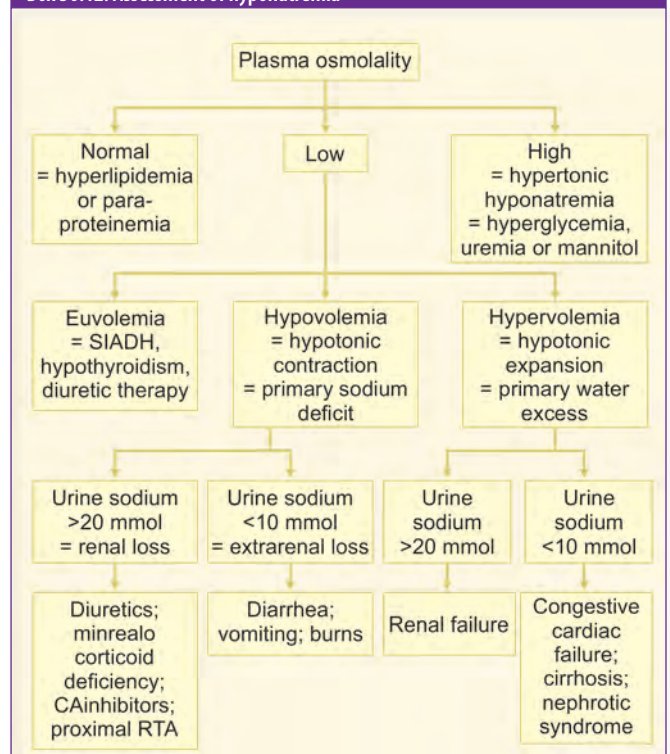
**Signs and symptoms:** Hypokalemia is manifested as muscular weakness, fatigue, muscle cramps, hypotension, decreased reflexes, palpitation, cardiac arrhythmias and cardiac arrest. ECG waves are flattened, **T wave is inverted**, ST segment is lowered with AV block. This may be corrected by oral feeding of orange juice. Potassium administration has a beneficial effect in hypertension.

**Redistribution** of potassium can occur following insulin therapy. For diabetic coma, the standard treatment is to give **glucose and insulin**. This causes entry of glucose

Box 30.11: Assessment of hypernatremia



Box 30.12: Assessment of hyponatremia



and potassium into the cell and hypokalemia may be induced.  $K^+$  should be supplemented in such cases.

Redistribution is also seen in **alkalosis**, where the potassium moves into the cell in exchange for  $H^+$ .

Renal loss of potassium is seen in acute tubular necrosis, renal tubular acidosis and metabolic alkalosis. In metabolic alkalosis, potassium is exchanged with  $H^+$ , in an attempt to conserve  $H^+$ .

In turn, hypokalemia can lead to metabolic alkalosis; this is observed in diuretic therapy, and prolonged vomiting, where  $K^+$  is lost in exchange for  $H^+$ . Non-renal losses are seen in diarrhea.

**Diuretics** used for congestive cardiac failure may cause  $K^+$  excretion; hence potassium supplementation is the standard treatment along with diuretics. Assessment of hypokalemia is shown in Box 30.15.

### Treatment of Hypokalemia

Aim is to stop the loss and evaluation at frequent intervals. Supplement adequate potassium (200 to 400 mmol for every 1 mmol fall in serum potassium). Relatively large doses can be given orally; but may produce gastrointestinal upset. About 100 mmol KCl per day in 3–4 divided doses. In acute cases, intravenous supplementation may be given; but only in small doses (not more than 10 mmol/hour). Never give ampoules of KCl directly without diluting. Potassium solutions are irritant to peripheral veins; it is preferable to give through a central line. Serum potassium should be checked every hour throughout the therapy. If Magnesium is low, supplement it. Correct alkalosis. Even after normal level is reached, daily potassium assay for several days is to be continued.

## Hyperkalemia

Plasma potassium level above 5.5 mmol/L is known as hyperkalemia. Since the normal level of  $K^+$  is kept at a very narrow margin, even minor increase is life-threatening.

In hyperkalemia, there is increased membrane excitability, which leads to ventricular arrhythmia and ventricular fibrillation. Hyperkalemia is characterized by flaccid paralysis, bradycardia and **cardiac arrest**. ECG shows **elevated T wave**, widening of QRS complex and lengthening of PR interval.

Causes of hyperkalemia are shown in Box 30.14. True potassium excess results from decreased urinary output, increased hemolysis and tissue necrosis. Decreased **potassium excretion** can occur in mineralocorticoid deficiency, Addison's disease and potassium sparing diuretics (spironolactone). Potassium channel mutations lead to **long-QT syndrome**, and cardiac arrhythmias.

**Redistribution** occurs in metabolic acidosis, insulin deficiency and tissue hypoxia (Table 30.6).

**Pseudohyperkalemia** is seen in hemolysis, thrombocytosis, leukocytosis or polycythemia; in these conditions, potassium from within the cells will leak out into plasma when the sample is collected.

Assessment of hyperkalemia is shown in Box 30.16. Laboratory evaluation of potassium is given in Box 30.17. Box 30.18 shows the conditions in which potassium estimations are required.

### Box 30.13: Causes of hypokalemia

#### 1. Increased renal excretion

- Cushing's syndrome
- Hyperaldosteronism
- Hyper-reninism, renal artery stenosis
- Hypomagnesemia
- Renal tubular acidosis
- Adrenogenital syndrome
- 17 alpha hydroxylase deficiency
- 11 beta hydroxylase deficiency

#### 2. Shift or redistribution of potassium

- Alkalosis
- Insulin therapy
- Thyrotoxic periodic paralysis  
(abnormal Na-K-ATPase)
- Hypokalemic periodic paralysis  
(abnormal calcium channels)

#### 3. Gastrointestinal loss

- Diarrhea, vomiting, aspiration
- Deficient intake or low potassium diet
- Malabsorption
- Pyloric obstruction

#### 4. Intravenous saline infusion in excess

#### 5. Drugs

- Insulin
- Salbutamide
- Osmotic diuretics
- Thiazides, acetazolamide
- Corticosteroids



### Treatment of Hyperkalemia

If serum potassium is  $> 6.5$  mmol/L, emergency treatment as intravenous glucose and insulin, should be given. Dose is 6 units of plain insulin with 50 mL 50% dextrose over 10 minutes. This stimulates glycogen synthesis. When 1 g of glycogen is stored, 0.3 mM of  $K^+$  is simultaneously trapped intracellularly. So the serum  $K^+$  is rapidly decreased. Continuous ECG monitoring should be done,

#### Box 30.14: Causes of hyperkalemia

- Decreased renal excretion of potassium**
  - Obstruction of urinary tract
  - Renal failure
  - Deficient aldosterone (Addison's)
  - Severe volume depletion (heart failure)
- Entry of potassium to extracellular space**
  - Increased hemolysis
  - Tissue necrosis, burns
  - Tumor lysis after chemotherapy
  - Rhabdomyolysis, crush injury
  - Excess potassium supplementation
  - Malignant hypertension
- Redistribution of potassium to extracellular space**
  - Metabolic acidosis
  - Insulin deficiency (diabetes mellitus)
  - Tissue hypoxia
- Transmembrane shift**
- Pseudohyperkalemia**
  - Factitious ( $K^+$  leaches out when blood is kept for a long time before separation)
  - Improper blood collection (hemolysis)
  - Thrombocytosis ( $> 400$  million/mL)
  - Leukocytosis ( $> 11$  million/mL)
- Hyperkalemic periodic paralysis**
- Drugs**
  - Spironolactone
  - ACE inhibitors
  - Beta blockers
  - Cyclosporine
  - Digoxin

**TABLE 30.6:** Redistribution of serum potassium

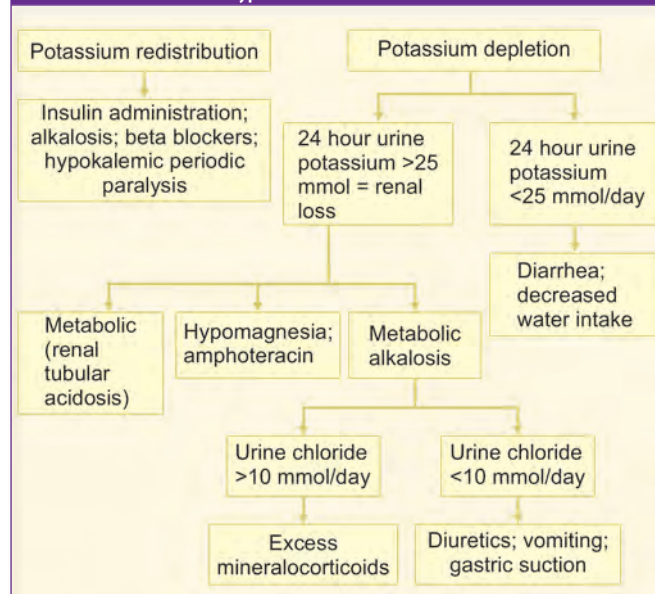
Increases $K^+$ entry into cells leading to hypokalemia	Impairs $K^+$ entry into cells or exit of $K^+$ from cells; hyperkalemia
Insulin Beta adrenergic stimuli Alkalosis	Glucagon Alpha adrenergic stimuli Acidosis Increased osmolality Increased catabolism

as sudden hypokalemia can occur. Give intravenous calcium gluconate (10%, 10 mL over 5 min) to stabilize myocardium. Correction of hyperglycemia and acidosis should also be done side by side. If patient is acidotic, give sodium bicarbonate (1.4%  $NaHCO_3$ , 500 mL, 2 hr). This will correct acidosis and help in shifting  $K^+$  into the cells; but volume overload is to be monitored. Dialysis may be required in patients with renal failure.

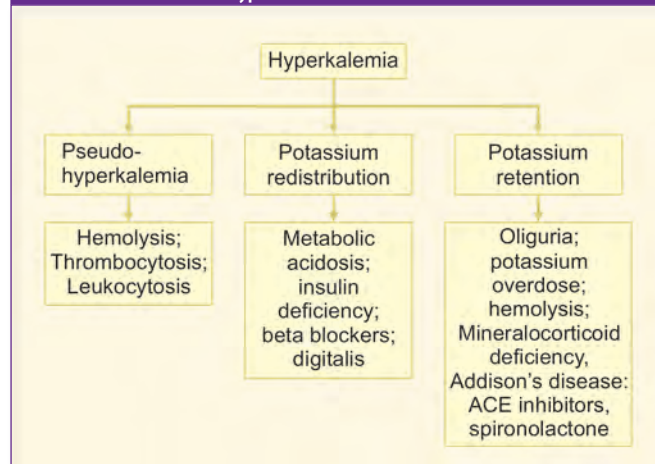
### CHLORIDE ( $Cl^-$ )

Intake, output and metabolism of sodium and chloride run in parallel. The homeostasis of  $Na^+$ ,  $K^+$  and  $Cl^-$  are

#### Box 30.15: Assessment of hypokalemia



#### Box 30.16: Assessment of hyperkalemia



interrelated. Chloride is important in the formation of hydrochloric acid in gastric juice (see Chapter 26). Chloride ions are also involved in chloride shift (see Chapter 22).

Chloride concentration in plasma is **96–106 mEq/L** and in CSF, it is about 125 mEq/L. Chloride concentration in CSF is higher than any other body fluids. Since CSF protein content is low,  $\text{Cl}^-$  is increased to maintain Donnan membrane equilibrium.

Excretion of  $\text{Cl}^-$  is through urine, and is parallel to  $\text{Na}^+$ . Renal threshold for  $\text{Cl}^-$  is about 110 mEq/L. Daily excretion of  $\text{Cl}^-$  is about 5–8 g/day.

### Hyperchloremia is seen in

1. Dehydration
2. Cushing's syndrome. Mineralocorticoids cause increased reabsorption from kidney tubules
3. Severe diarrhea leads to loss of bicarbonate and compensatory retention of chloride
4. Renal tubular acidosis.

### Causes for Hypochloremia

1. Excessive vomiting.  $\text{HCl}$  is lost, so plasma  $\text{Cl}^-$  is lowered. There will be compensatory increase in plasma bicarbonate. This is called hypochloremic alkalosis.

#### Box 30.17: Laboratory evaluations for potassium abnormalities

1. Serum potassium estimation
2. Urine potassium: Low value ( $< 20$  mmol/L) is seen in poor intake, GIT loss or transmembrane shift. High ( $> 40$  mmol/L) is seen in renal diseases
3. Sodium and Osmolality of spot urine: Low sodium ( $< 20$  mmol/L) and high potassium indicate secondary hyperaldosteronism. If urine osmolality is low (300–600) and a value of urinary potassium of 60 mmol/L indicate renal loss. On the other hand if urine osmolality is high (1200), the same value of potassium excreted in urine indicates low renal excretion around 15 mmol/L. This potentially confounding effect of urine concentration on interpretation of potassium excretion is corrected by calculating Transtubular potassium gradient or TTKG
4.  $\text{TTKG} = \frac{\text{Urine K} \times \text{Serum Osmolality}}{\text{Serum Potassium} \times \text{Urine osmolality}}$ . A value less than 3 indicates that kidneys are not wasting potassium. But a value more than 7 suggests significant renal loss. A middle value indicates a mixed cause. But if urine osmolality is less than that of plasma, this relationship does not hold good
5. ECG in all cases
6. Special tests: Aldosterone, plasma renin, cortisol and 17 hydroxyprogesterone.

2. Excessive sweating.
3. In Addison's disease, aldosterone is diminished, renal tubular reabsorption of  $\text{Cl}^-$  is decreased, and more  $\text{Cl}^-$  is excreted.

### Chloride Channels

The CFTR (Cystic Fibrosis Transmembrane Conductance Receptor) chloride conducting channel is involved in Cystic fibrosis. In **Cystic Fibrosis**, a point mutation in the **CFTR gene** results in defective chloride transport. So water moves out from lungs and pancreas. This is responsible for the production of abnormally thick mucous. This will lead to infection and progressive damage and death at a young age.

Different mechanisms for electrolyte regulation are summarized in Table 30.7.

**TABLE 30.7:** Regulation mechanisms of electrolytes

Sodium ( $\text{Na}^+$ )		Aldosterone, Antidiuretic hormone (ADH)—water regulation Atrial natriuretic peptide (ANP) Renal reabsorption Renal excretion
Potassium ( $\text{K}^+$ )	Intestinal absorption	Aldosterone Glucocorticoids (lesser degree) Renal reabsorption Renal excretion
Calcium ( $\text{Ca}^{++}$ )		Parathyroid hormone Calcitonin Magnesium (helps in calcium metabolism and intestinal absorption) Intestinal absorption Renal reabsorption Renal excretion
Magnesium ( $\text{Mg}^{++}$ )		Intestinal absorption Renal reabsorption Renal excretion
Chloride ( $\text{Cl}^-$ )		Intestinal absorption Renal reabsorption Renal excretion

#### Box 30.18: When potassium level should be checked?

1. Cardiac diseases
2. Administration of drugs, such as diuretics, ACE inhibitors, NSAIDs
3. Diabetic ketoacidosis
4. Receiving large volume of IV fluids
5. Fluid loss (burns, total parenteral nutrition, diarrhea)
6. Renal impairment
7. Weakness of unknown etiology.

### Clinical Case Study 30.1

A 3-year-old boy was brought to the clinic for chronic productive cough not responding to antibiotics. There was no history of fever, but there was abdominal distension, difficulty to pass stool, and emesis in infancy. History revealed that the child frequently passed bulky, foul-smelling stools. No diarrhea was present. He had many relatives with chronic lung and “stomach” problems and some had died at a young age.

On examination, child was ill-appearing, slender and in moderate distress. Lung examination and chest X-ray revealed poor air movement in base of lungs, bilateral and coarse rhonchi throughout lungs and bronchopneumonia. A quantitative pilocarpine iontophoresis sweat test was done and serum chloride was 70 mEq/L. Repeat testing after a few days yielded same results. What is the diagnosis? What is the mechanism involved?

### Clinical Case Study 30.2

A 70-year-old woman was admitted with anorexia, weight loss and anemia and diagnosed to have carcinoma of the colon. Biochemical results were Serum sodium 123 mmol/L, Potassium 3.8 mmol/L, Chloride 88 mmol/L, Bicarbonate 21 mmol/L. Serum osmolality was 247 mOsm/kg and urine osmolality was 176 mOsm/kg. Urea and creatinine were normal. What is the probable diagnosis?

### Clinical Case Study 30.3

A 70-year-old man with depression and weakness was admitted to the Emergency Department. He was clinically dehydrated, skin was lax and lips and tongue were dry and shriveled looking. Pulse 104/min, BP 95/65 mm Hg. Serum sodium 162 mmol/L, Potassium 3.7 mmol/L, Chloride 132 mmol/L, Bicarbonate 17 mmol/L, blood urea 90 mg/dL, and serum creatinine 1.8 mg/dL. Interpret the findings.

### Clinical Case Study 30.4

A 55-year-old man was brought to the emergency with severe multiple injuries in a road traffic accident and crush injuries, fractures of the legs and scalp lacerations. He was conscious and breathing spontaneously. Pulse 130/min, BP 60/40 mm Hg, serum sodium 142 mmol/L, potassium 7.9 mmol/L, chloride 110 mmol/L, Blood urea 40 mg/dL, and serum creatinine 1.2 mg/dL. Interpret the laboratory data? What is the basis of the changes?

### Clinical Case Study 30.5

A 65-year-old female complaining of severe diarrhea over the past few days presented to the clinic. Her physical examination revealed dry mucous membranes, postural hypotension was present. Pulse 140/min, serum sodium 132 mmol/L, potassium 2.7 mmol/L, chloride 90 mmol/L,  $p\text{CO}_2$  – 31 mm Hg, Blood urea and serum creatinine were normal. Interpret the findings.

### Clinical Case Study 30.1 Answer

The most probable diagnosis is cystic fibrosis, a disease with defective chloride ion channels of exocrine glands in acinar cells of pancreas, sweat glands and mucous glands of respiratory, digestive and reproductive tracts. There is mutation in the CFTR gene; more than 1400 mutations have been identified and 230 mutations are associated with clinical features. CFTR  $\Delta 508$  mutation accounts for 70% of cases. Cystic fibrosis is comparatively rare in India, but more common in western countries.

Clinical findings are (1) Lungs—Thickening of mucus and depletion of periciliary liquid leading to adhesion of mucus to airway surface; infections of airways, (2) GI tract—Damage to exocrine pancreas and destruction of pancreas, desiccated intestinal intraluminal contents, obstruction of small and large intestines, thickened biliary secretions, focal biliary cirrhosis, bile duct proliferation, chronic cholecystitis, cholelithiasis, (3) Sweat gland – normal volumes of sweat with defective chloride content is hallmark of CF.

Laboratory findings are; (1) Hypoxemia and in advanced cases, chronic compensated respiratory acidosis. Pulmonary function shows mixed obstructive and restrictive pattern. (2) Elevated chloride in sweat on two tests on different days is diagnostic. Normal sweat chloride level does not rule out diagnosis of CF. (3) DNA analysis (PCR test).

### Clinical Case Study 30.2 Answer

The patient has dilutional hyponatremia. Normal urea and creatinine exclude significant sodium depletion and absence of edema exclude increase in total body sodium. The results are classical of “syndrome of inappropriate ADH secretion” (SIADH), due to secretion of AVP in response to nonosmotic stimuli. Hyponatremia is the most common electrolyte disturbance, and there is marked

presence of hyponatremia in hospitalized patients (30% of patients in ICUs may have hyponatremia).

Common causes of hyponatremia are diuretic use, diarrhea, heart failure and renal diseases. Clinical features are headache, confusion, stupor, seizures and coma may be seen in severe cases. Hypovolemic hyponatremia can be due to renal causes (acute or chronic renal failure, salt-losing nephropathy, diuretics, etc.) or extrarenal causes (excessive fluid losses, cerebral salt-losing syndrome, prolonged exercise, etc.). Other types of hyponatremia are euvolemic hyponatremia (seen in patients who are taking excess fluids), hypervolemic hyponatremia (renal causes like acute and chronic renal failure, hepatic cirrhosis, congestive heart failure, and nephrotic syndrome), redistributive hyponatremia (seen in hyperglycemia or mannitol therapy) and pseudohyponatremia (hypertriglyceridemia, multiple myeloma).

### Clinical Case Study 30.3 Answer

The patient possibly has prerenal uremia and severe hyponatremia. Patient might be suffering from water deprivation. Serum potassium is normal. It is important to exclude nonketotic diabetic coma and blood glucose and ketones should be estimated for this purpose.

Hyponatremia also may be hypovolemic, euvolemic and hypervolemic. Causes are; (1) Hypovolemic—GI losses, skin losses, renal losses, (2) Euvolemic—Extrarenal losses from respiratory tract, skin, renal losses, etc. and (3) Hypervolemic—Hypertonic fluid administration, mineralocorticoid excess. Hyponatremia may be seen in elderly, postoperative patients and those on tube feeds or parenteral nutrition.

### Clinical Case Study 30.4 Answer

Patient has severe hyperkalemia due to release of potassium from the damaged tissues. Clinical features are neuromuscular; muscle weakness, cardiac toxicity, and may produce ventricular fibrillation and asystole.

Causes are; (1) Pseudohyperkalemia—Hemolysis, thrombocytosis, leukocytosis, excessive tourniquet application during blood draw, (2) Redistribution—Acidosis, insulin deficiency, beta blockers, acute digoxin intoxication,

succinylcholine, arginine HCl, hyperkalemic periodic paralysis, (3) Excessive endogenous potassium load—Hemolysis, rhabdomyolysis, internal hemorrhage, (4) Excessive exogenous potassium load—Parenteral therapy, excess in diet, potassium supplements, salt substitutes, (5) Diminished potassium excretion—Decreased GFR, decreased mineralocorticoids, defect in tubular secretion, drugs, etc. Usually there are many simultaneous factors causing hyperkalemia.

### Clinical Case Study 30.5 Answer

There is hypokalemia due to severe diarrhea. Diarrhea has also produced loss of fluid and sodium chloride. Main cause of hypokalemia in this patient is extracellular volume depletion (ECVD) which has also induced metabolic alkalosis (contraction alkalosis).

Hypokalemia is caused by deficit of potassium stores or abnormal movement into cells. Common causes are excess losses from kidneys and GI tract. Clinical features of hypokalemia are muscle weakness, polyuria and cardiac hyperexcitability. Hypokalemia is also common among hospitalized patients.

Causes are; (1) Renal losses—Renal tubular acidosis, adrenal steroid excess, Bartter syndrome, Gitelman's syndrome, Liddle syndrome, renal potassium wasting, hypomagnesemia, leukemia, (2) GI losses—Vomiting, diarrhea, enemas and laxatives, protracted gastric suction, (3) Drugs like diuretics, theophylline, aminoglycosides, etc. (4) Transcellular shift—Insulin,  $\alpha$  adrenergic antagonists, thyrotoxicosis, (5) Malnutrition and decreased dietary intake, and (6) Pseudohypokalemia.

## QUICK LOOK OF CHAPTER 30

1. Osmolarity means osmotic pressure exerted by the number of moles per liter of solution.
2. Osmolality is the osmotic pressure exerted by the number of moles per kg of solvent.
3. Major determinant factor of osmolality is sodium.
4. Normal plasma osmolality varies from 285–295 milliOsmole/kg.
5. Major regulatory factors of sodium and water balance are aldosterone, ADH and rennin-angiotensin system.



# CHAPTER 31

## Body Fluids (Milk, CSF, Amniotic Fluid, Ascitic Fluid)

### Chapter at a Glance

The reader will be able to answer questions on the following topics:

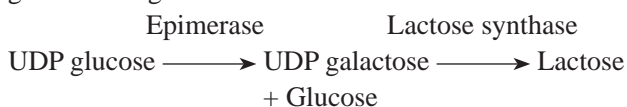
- Milk
- Colostrum
- Cerebrospinal fluid
- Amniotic fluid
- Ascitic fluid

### MILK

Milk is the only food for the growth of young ones of all mammals. The milk is secreted by the mammary glands. Milk holds a unique place as an almost complete natural food from the point of view of nutrition. **The major nutrients lacking in milk are iron, copper and vitamin C.** The composition of milk is given in Table 31.1.

### Lactose Synthesis

Synthesis of lactose in mammary gland is catalyzed by lactose synthase. A galactose unit is transferred from UDP-galactose to glucose.



The lactose synthase has 2 subunits, a catalytic subunit which is a galactosyl transferase and a modifier subunit that is alpha **lactalbumin**.

The activity of galactosyl transferase in mammary gland is modified by alpha lactalbumin, so that the galactose residue is transferred to glucose. (Galactosyl transferase in other tissues has the function of catalyzing the attachment of galactose to N-acetyl glucosamine units on glycoproteins).

The level of the modifier subunit is under the control of **prolactin**. Following parturition, the prolactin level rises, and modifier subunit also increased. This would result in the formation of the full enzyme, lactose synthase; then synthesis of lactose occurs. Lactase deficiency is described in Chapter 9; see also Box 31.1.

**TABLE 31.1:** Composition of milk

Constituent	Human	Cow	Buffalo	Goat
Water (%)	87.5	87.2	83.6	87.5
Total solids (%)	12.5	12.8	16.4	12.5
Proteins (g/dL)	1.1	3.3	4.3	3.7
Lipids (g/dL)	3.8	3.8	6.0	3.5
Carbohydrate (g/dL)	7.5	4.4	5.3	4.7
Calcium (mg/dL)	34	150	160	170

Net energy content (kcal /100 mL) of milk of different species is as follows: Human 71, Cow's 69, Buffalo's 117, and Goat's 84.

Human milk has higher carbohydrate content than cow's milk while protein content is less. To **humanize cow's milk**, protein is to be diluted and carbohydrate is to be added. Thus, to one cup of cow's milk, add half a cup of water and two teaspoons of sugar. This will make it comparable to human milk.

## Lipids in Milk

The white color of milk is due to the emulsified fat and the calcium caseinate. The lipids of milk are dispersed as small globules. The fatty acids are mainly saturated, but 50% of them are medium chain fatty acids. Medium chain fatty acids are easily digested, absorbed and metabolized (see Chapter 14). The fatty acid make up of milk is butyric acid (4 carbon) 10%; lauric acid (C12) 20%; myristic acid (C14) 20%; palmitic acid (C16) 20%; stearic acid (C18) 15% and oleic acid (C18, 1 double bond) 15%. The yellow color of butter is due to the beta carotenes.

## Proteins in Milk

A comparison of protein content in milk of different species is shown in Table 31.1. The protein content is generally proportional to the requirement for growth. For example, the time for doubling the body weight of a newborn human being is 180 days, but in the rabbit, it is only 6 days. As the growth rate is more in the young rabbit, the rabbit milk also has higher percentage of protein content.

About 80% protein of cow's milk is **casein**. It is a phosphoprotein. The phosphate groups are added to the hydroxyl groups of serine or threonine residues. If milk is acidified and pH lowered to 4.6, the casein is precipitated (isoelectric precipitation).

The supernatant whey contains the rest of proteins. The proteins in the whey are lactalbumin, lactoglobulin and lysozyme. In human milk, the casein forms only about 40% of milk proteins, and the rest 60% is present in the whey.

### Box 31.1: Lactase deficiency leads to lactose intolerance

Many infants develop diarrhea and skin manifestations due to lactose intolerance. (It may also be due to allergy to milk proteins). These children are to be fed with lactose free formulae or soybean proteins.

IgA (140 mg/dL) has the highest concentration among the immunoglobulins. IgM and IgG are also present in small amounts.

## Minerals in Milk

Milk has a high content of calcium, phosphorus, sodium and potassium; but is poor in iron and copper. Hence, young infants fed exclusively on milk may develop iron deficiency anemia. Semisolid diet should be started in children after 3 months of age, so that anemia may be prevented. A comparison of the mineral content of human and bovine milk is shown in Table 31.2.

## Colostrum (Colostrum Milk)

It is secreted during the first few days after parturition. Colostrum coagulates on heating, whereas fresh milk does not. This coagulum forms a surface film containing casein and calcium salts. Colostrum is mildly laxative, which helps to remove meconium from the intestinal tract of the infant. The change from colostrum to milk occurs within a few days after the initiation of lactation.

The proteins present in colostrum are predominantly immunoglobulins. In the case of cow, these immunoglobulins are readily absorbed by the calf, and give protection to the young animal. However, in human beings there is no definite evidence for absorption of antibodies by the suckling infant.

## ■ CEREBROSPINAL FLUID (CSF)

The CSF is found within the subarachnoid space and ventricles of the brain, as well as around the spinal cord. The fluid originates in the choroid plexus and returns to the blood in the vessels of the lumbar region.

The total volume of fluid is about 125 milliliter. It is a transudate or ultrafiltrate of plasma. The composition of the fluid is given in Table 31.3. CSF has the chloride

**TABLE 31.2:** Mineral content of milk

Mineral	Human milk (mg/100 mL)	Cow's milk (mg/100 mL)	Buffalo's milk (mg/100mL)
Calcium	34	150	160
Magnesium	2.2	13	10
Phosphorus	16	100	100
Sodium	15	58	58
Potassium	55	138	130
Chloride	43	100	60
Iron	Negligible	Negligible	Negligible

**TABLE 31.3:** Composition of the cerebrospinal fluid in health and diseases

Disease	Color and appearance	Cell count	Protein	Sugar	Coagulation
Normal	Clear and colorless	0–4 × 10 <sup>6</sup> /L	10–30 mg/dL	50–70 mg/dL	Not seen
Bacterial meningitis (purulent meningitis)	Opalescent or turbid due to high cell content	Markedly increased polymorphs	Marked increase	Marked decrease	May clot on standing
Tuberculous meningitis	May be opalescent	Lymphocytes and mononuclear cells	Increased	Low but not very much decreased	Cobweb type coagulation
Viral infection	Clear and colorless	Increased	Increased	Normal	Nil
Brain tumor	Clear and colorless	Within normal range	Increased	Low	Solidifies
Subarachnoid hemorrhage	Blood stained in fresh hemorrhage	RBCs and WBCs	Increased	Not significant	Nil

concentration higher than the plasma. This is in accordance with the Gibbs-Donnan equilibrium (see Chapter 1). Because the concentrations of non-diffusible anions like proteins are lower in CSF than in the plasma, as a compensation, the chloride ions are increased.

### Biochemical Analysis of CSF

The protein concentration is usually 10–30 mg/dL, out of which about 20 mg/dL is albumin, and globulin is about 5–10 mg/dL.

In **bacterial infections** of the meninges, the protein concentration is increased. But in such cases, the neutrophil cell count is also increased.

In **viral infections**, the protein concentration is not significantly increased, but mononuclear cells are abundant.

In **brain tumors**, albumin level is raised, but cell count is normal; this is called albuminocytological dissociation.

### Electrophoresis of CSF

Normal CSF shows 60% albumin, 8% gamma globulins and 32% other globulins. The electrophoretic pattern is abnormal when IgG synthesis in brain is increased. Oligoclonal bands are found in such conditions.

In **multiple sclerosis**, the characteristic finding is an increase in globulin levels, especially IgG fraction. Serum protein concentration is also measured and the IgG index is calculated as:

$$\text{IgG index} = \frac{\text{CSF IgG} \times \text{Serum albumin}}{\text{Serum IgG} \times \text{CSF albumin}}$$

In multiple sclerosis, the index is increased, showing an absolute increase in IgG level. The cause is believed to be the increased synthesis of IgG in CNS.

### Glucose Level in CSF

Normal level of glucose in CSF is 50–70 mg/dL, which is lower than the plasma level. Hence, estimation of plasma glucose along with CSF glucose is always done to avoid misinterpretation due to a change in the plasma glucose. Elevated levels are seen in diabetes mellitus. In bacterial meningitis, however, the glucose level is far lower when compared to the plasma, because it is metabolized by bacteria. The diagnostic findings in different diseases are given in Table 31.3.

### AMNIOTIC FLUID

Amniocentesis is the process by which amniotic fluid is collected for analysis. Examination of amniotic fluid is of importance in prenatal diagnosis. The normal composition of amniotic fluid is given in Table 31.4.

**TABLE 31.4:** Normal composition of amniotic fluid

	Early gestation	Pre-term
Volume	450–1200 mL	500–1400 mL
Bilirubin	<0.075 mg/dL	<0.025 mg/dL
Creatinine	0.8–1.1 mg/dL	1.8–4.0 mg/dL
Estriol	10 µg/dL	>60 µg/dL
Lecithin-sphingomyelin (L/S) ratio	<1:1	>2:1
Protein	0.6–0.24 g/dL	0.26–0.19g/dL
Urea	18 ± 6 mg/dL	30 ± 11 mg/dL
Uric acid	3.7 ± 1 mg/dL	9.9 ± 2.2 mg/dL

## Lung Maturity

The lung maturity is assessed by measuring the lecithin-sphingomyelin (L/S) ratio, which is an index of the **surfactant** (surface tension lowering complex) concentration in amniotic fluid. In late pregnancy, the cells lining the fetal alveoli start synthesizing dipalmitoyl-lecithin so that the concentration of lecithin increases, whereas that of sphingomyelin remains constant. As a result, as the fetal lung matures, the lecithin-sphingomyelin (L/S) ratio rises. An L/S ratio of 2 is taken usually as a critical value.

**Hemolytic diseases:** The measurement of bilirubin in amniotic fluid by direct spectrophotometry is useful in early detection of hemolytic disease of the newborn.

**Measurement of alpha fetoprotein (AFP):** Alpha fetoprotein (AFP) level estimation in the amniotic fluid is important in prenatal detection of neural tube defects. AFP is described in Chapter 57. Elevated levels in both the amniotic fluid and the maternal serum are strongly suggestive of neural tube defects of fetus.

**Other metabolites:** Estimation of cholinesterase iso-enzyme (fast moving band) in amniotic fluid is also confirmatory to neural tube defects when tested before 22–24 weeks of gestation. Other abnormal metabolites estimated in amniotic fluid include phenylalanine (to detect phenyl ketonuria) and methyl malonic acid in suspected cases of inborn errors of metabolism.

## ASCITIC FLUID

The word ascites is of Greek origin (*askos*) and means bag or sac. Ascites describes the condition of pathologic fluid collection within the abdominal cavity. Important findings of ascitic fluid analysis are shown in Box 31.2.

### Box 31.2: Ascites fluid analysis

WBC count: Uncomplicated ascites <500/mm<sup>3</sup>, Diuresis >1000/mm<sup>3</sup>

Polymorphonuclear cell (PMN) count: Uncomplicated ascites <250/mm<sup>3</sup>, Inflammation: Increased, Hemorrhagic: False elevation (Subtract 1 PMN for every 250 RBCs, Malignant Ascites : Increased (dying tumor cells attract PMNs)

Serum Ascites Albumin Gradient (SAAG)

SAAG = Serum Albumin – Ascitic Fluid Albumin

HIGH GRADIENT >1.1 g/dL

Cirrhosis, Fulminant liver failure, Cardiac ascites, Budd-Chiari syndrome, Portal Vein thrombosis, Sinusoidal Obstruction syndrome, Myxedema, Fatty liver of pregnancy

LOW GRADIENT <1.1 g/dL

Peritoneal carcinomatosis, Tubercular peritonitis, Bowel obstruction or infarction, Biliary ascites, Nephrotic syndrome

Glucose—Uncomplicated—Same as serum, Reduced in infection

LDH—Uncomplicated—Less than 50% of serum, Subacute Bacterial Peritonitis (SBP)—Increased

Amylase—Uncomplicated—50% serum, 50 U/l, Pancreatic Ascites—Increased

Triglycerides—Chylous Ascites >200 mg/dL

Bilirubin—Biliary or Upper Gut Perforation >6 mg/dL

ADA (Adenosine deaminase)—Tubercular Ascites



# CHAPTER 32

## Metabolic Diseases

### Chapter at a Glance

The reader will be able to answer questions on the following topics:

- Prenatal diagnosis
- AFP, hCG, uE3, DIA, PAPP-A
- Newborn screening
- Investigations for metabolic disorders

### PRENATAL DIAGNOSIS

About 2% of live births are associated with a genetic defect. In addition, genetic disorders are also a major cause of pregnancy loss as well as perinatal mortality and morbidity. Taking a detailed family history is very important in prenatal genetic evaluation, permitting the counselor or physician to identify problems for which a couple may be at risk. One of the most important of these is a three-generation family history analysis (pedigree analysis). Details to be obtained include miscarriage, neonatal or early life death, consanguinity as well as specific information of mental retardation, anemia and congenital anomalies.

### Genetic Counseling

This process involves an attempt by trained persons to help the individual or family to:

1. comprehend the medical facts including the diagnosis, probable course of the disorder, and the available management,
2. appreciate the way heredity contributes to the disorder and the risk of recurrence in specified relatives,
3. understand the alternative for dealing with the risk of recurrence,
4. choose a course of action which seems to them appropriate in view of their risk, their family goals, and their ethical and religious standards and act in accordance with that decision, and

5. to make the best possible adjustment to the disorder in an affected family member and/or to the risk of recurrence of that disorder. Indications for referring a patient to a genetic counselor are shown in Box 32.1.

**Ultrasound** is the main diagnostic tool for prenatal diagnosis of congenital disorders. Ultrasound screening is offered routinely to all pregnant women. It is usually performed at 18–23 weeks of pregnancy.

### Amniocentesis

Prenatal diagnosis of inborn errors of metabolism can be made by enzymatic assays of cultured amniocytes. Diagnosis of these disorders is offered only when couples are at substantial risk, e.g. if the couple already had a child affected by an inherited disorder, if one of the parents is affected by an autosomal or X-linked dominant disorder or when carrier testing reveals that both parents carry a recessive trait.

#### Box 32.1: Common medical indications for a referral to a genetic counselor

1. Advanced maternal age (greater than 35 years)
2. Positive maternal serum screening
3. Patient or family member with a known Mendelian disorder
4. Prior pregnancy with a chromosomal disorder
5. Family history of mental retardation or birth defect
6. Fetal anomalies or markers by sonogram
7. Recurrent pregnancy loss/stillbirth
8. Infertility
9. Ethnic-based carrier screening
10. Consanguinity

### Chorionic Villi Sampling (CVS)

The most common indications for CVS are advanced maternal age, or a biochemical or genetic disorder indicated by molecular markers. CVS has the advantage of early diagnosis, allowing earlier intervention. The genetic makeup of the placenta is identical to that of the fetus. For this reason, chorionic villi may be utilized to determine the chromosomal, enzymatic, or molecular genetic status of the fetus.

### Cordocentesis

Fetal blood sampling (cordocentesis) can be performed at 20 weeks gestation. The preferred location for cord puncture is the placental origin where it is relatively fixed. The first few centimeters of the fetal origin of the umbilical cord is innervated. Its puncture causes pain and should be avoided.

### Cytogenetics and Molecular Cytogenetics

Samples include amniocentesis, transabdominal and transcervical chorionic villus sampling (CVS), fetal blood sampling and fetal skin biopsy. Cytogenetic analysis may be done with fluorescence in situ hybridization (FISH) for common chromosomal aneuploidies involving chromosomes 13, 18, 21, X, and Y. Other molecular cytogenetic tests permit evaluation and further characterization of more subtle abnormalities, including microdeletions, marker chromosomes, translocations, deletions, inversions, and subtelomeric deletions. Microarrays (DNA chips) with genomic clones are being developed and hold promise for providing a replacement for FISH for microdeletion syndromes and subtelomere analysis.

### Biochemical Screening

They are cheap, easy, quick and reliable. But they do not give definitive answer. On the other hand **diagnostic tests** are performed only on “risk” population, they are generally expensive; but will give definitive answer.

### Maternal Serum Screening

Prenatal screening has become standard obstetric practice in all pregnancies at risk. Four analytes—alpha-feto

protein (AFP), human chorionic gonadotropin (hCG), unconjugated estriol (uE3), and inhibin—are estimated. The triple screen (AFP, hCG, uE3) is done during the second trimester between 14 and 18 weeks. Neural tube defects, trisomy 21 and trisomy 18 are detected. Each laboratory has to use its own data to establish Median values for each marker (analyte) for each week of gestation. Ideally the median is to be calculated with results from 200 samples.

**Alpha fetoprotein (AFP)** is the major serum protein of the fetus synthesized by the fetal liver and yolk sac. There is a steady increase in AFP level in maternal serum from 10th week of gestation and reaches a peak by 25 weeks of gestation in unaffected pregnancy. Then the maternal serum alpha feto protein (MSAFP) steadily declines until term. In fetal serum and amniotic fluid, the AFP level reaches a peak by 9th week of gestation and then slowly falls till term. In NTD, the AFP is increased but in chromosomal aneuploidy it is decreased.

**Human chorionic gonadotrophin (hCG)** is a glycoprotein hormone produced during normal pregnancy by the trophoblast and placenta. hCG appears in maternal serum by 6 to 8 weeks and reaches a peak by 10 weeks. By the second trimester it falls to a constant level by 18 to 20 weeks. hCG is a heterodimer having alpha and beta subunits of which the beta subunit is specific for hCG. A marked increase of about twice the normal value was found in pregnancies with trisomy 21 during the second trimester. Free beta hCG was increased during the 1st trimester in Down’s syndrome, even though total hCG (alpha and beta subunits combined) remained normal. Both were increased during the second trimester in Trisomy 21. A hyperglycosylated variant (produced by cytotrophoblast) is also found in Down’s syndrome. This is referred to as **Invasive Trophoblast Antigen (ITA)**. The higher level of ITA is

#### Box 32.2: Suggested protocol for screening

1. Measurements of NT and PAPP-A are made in the first trimester, but not interpreted or acted upon until the second trimester.
2. In the second trimester a second serum sample is drawn and quadruple test performed.
3. Results for all the six tests, NT, PAPP-A, AFP, uE3, hCG and DIA are combined into a single risk estimate for interpretation in the second trimester.
4. 85% detection rate for DS with only 1% false positive is achieved.  
(NT = Nuchal translucency; PAPP-A = Pregnancy associated plasma protein-A; AFP = Alpha fetoprotein; uE3 = unconjugated estriol; hCG = human chorionic gonadotropin; DIA = Dimeric inhibin A)

#### Box 32.3: Follow-up of patients with screen positive results

1. Genetic counseling if patient is screen positive
2. For moderately elevated results (MoM 2–3), a second test should be done
3. If second test is negative; Screen is taken as negative
4. If second test also gives elevated results, further diagnostic testing is to be done
5. USG, Amniocentesis and analysis of amniotic fluid for Acetylcholine esterase to confirm neural tube defects
6. Amniotic fluid AFP results may give false positive due to contamination by fetal blood, hence confirmed by Acetylcholine esterase. AchE is not normally present in amniotic fluid, but appears in open neural tube defects
7. In cases of suspected chromosomal aneuploidy, fetal karyotyping is to be done.

due to the defect in the conversion of cytotrophoblast to syncytio trophoblast. In trisomy 18, the hCG levels remain lower than normal.

**Unconjugated estriol (uE3):** It is an estrogen with 3 hydroxyl groups and 3 organs (fetal adrenal, fetal liver and maternal liver) are involved in the synthesis. Maternal serum uE3 levels rise by 8 weeks of gestation and continue to increase through out pregnancy. A 25% reduction in uE3 levels was found when the fetus had chromosomal aneuploidy.

The triple screen has a high detection rate, 80% for neural tube defects and 55–60% for chromosomal aneuploidy and a false positive less than 5%.

### The Quadruple Test (Quad Screen)

This includes AFP, uE3, hCG and an additional marker Inhibin-A. **Dimeric Inhibin A (DIA)** is a glycoprotein produced by the placenta. It is a dimer, but with dissimilar subunits alpha and beta. Inhibin A is measurable in maternal serum and has a feed back effect on FSH secretion. The level increases in the first trimester until 10 weeks and then remains stable up to 25 weeks of gestation. Thereafter, it increases to reach a peak by term. The DIA levels are increased in DS and remains elevated through out the second trimester unlike AFP and uE3 that increase and hCG that decreases during the testing period. Reference value is 0.7–2.5 µg/L in unaffected pregnancy at second trimester. DIA is an independent variable having no correlation with maternal age, race or diabetes mellitus. There was no correlation with AFP and uE3, but significant correlation was found with hCG.

Factors affecting the level of the Quad screen markers are:

- Maternal weight was found to have an inverse relation with the levels of all four markers.
- In diabetes mellitus, AFP was found to be 40% lower than non diabetics.
- In twin pregnancy, AFP was higher than those having single fetus.

### Screening During the First Trimester

AFP, hCG and **Pregnancy associated plasma protein-A (PAPP-A)** are measured. PAPP-A is a high molecular weight zinc containing metallo-glycoprotein. It is produced by the trophoblast. In addition to being a marker of chromosomal aneuploidy, it is an indicator of early pregnancy failure and complications, Cornelia de Lange syndrome and acute coronary syndrome. The level of PAPP-A was found to be significantly lower in pregnancy with Trisomy 21 compared to unaffected pregnancy.

Persistently lower levels of PAPP-A in second trimester is indicative of Trisomy 18.

Total hCG was found to be a poor marker in the first trimester, but an adequate marker during the second trimester. Free beta hCG on the other hand is higher from 10 to 18 weeks.

Hence the present suggestion is to combine the markers of first and second trimester in maternal serum. The suggested protocol for screening is given in Box 32.2. Follow-up of patients with screen positive is shown in Box 32.3.

### X-linked Disorders

Ornithine carbamoyl transferase deficiency, Hunter disease, hypophosphatemic rickets and Fabry's disease are X-linked. Biochemical methods are seldom completely accurate in identifying X-linked carriers (females) because of the randomness of the X inactivation that sometimes may lead to a normal biochemical result. Hence, activity levels may not correlate with clinical expression. Males, on the other hand, have only one X chromosome and they are either hemizygote affected with deficient enzyme activity or hemizygote normal with activity within the normal range. Some X-linked disorders are lethal in utero in males and severely or completely impair reproduction in females. Microphthalmia with linear skin defects syndrome and Rett syndrome are such disorders.

### Biochemical Genetics

Biochemical tests for diagnosis of inherited metabolic disorders consist of identification of abnormal metabolites or abnormal levels of metabolites or the defective or deficient gene product. Fetal tissues (chorionic villi and fetal liver biopsy) or cells (trophoblasts, amniotic fluid cells, fetal erythrocytes, and leukocytes) are used for analysis of the enzyme or other protein primarily involved.

Testing of leukocytes or cultured skin fibroblasts from the parents, the index case and unaffected siblings can provide valuable information on the respective values of different genotypes within a particular family. It may prove to be a reliable means for identification of carriers among members of the extended family.

### Enzyme Assays

Direct demonstration of abnormality or deficiency of the gene (molecular techniques) or gene product (biochemical techniques) is the preferred diagnostic approach. Prenatal detection of citrullinemia and argininosuccinic aciduria and characterization of the mutant enzyme (argininosuccinate synthase and argininosuccinate lyase, respectively) are carried out in trophoblast or amniotic fluid cell cultures by measuring the incorporation of  $^{14}\text{C}$  from citrulline into arginine residues of newly synthesized protein.

Cystinosis, an autosomal recessive lysosomal storage disease, can be diagnosed prenatally by pulse labeling of cultured cells with [ $^{35}\text{S}$ ]cysteine from chorionic villi. Many families prefer diagnosis at birth and immediate

initiation of therapy if the child is affected. This is done by measuring the cysteine content of the placenta or the cord blood leukocytes.

Molecular genetics techniques like Q-RT-PCR, Southern blotting, linkage analysis as well as mutation analysis and a variety of PCR-based techniques have been used.

## NEWBORN SCREENING

Newborn screening aims at the earliest possible recognition of disorders to prevent the most serious consequences by timely intervention. Screening is not a confirmatory diagnosis and requires further investigations. Newborn screening may be done within the first week after birth, because metabolic errors, if recognized later, contribute to significant morbidity. Criteria that decide what disorders to include in the screening at a national platform are: (a) biochemically well identified disorder; (b) known incidence in the population; (c) disorder associated with significant morbidity and mortality; (d) effective treatment available; (e) period before which intervention improves outcome; and (f) availability of an ethical, safe and simple screening test. The developed countries have prioritized the diseases according to the incidence. Developed countries are using tandem mass spectrometry to screen for a wide range of disorders. This technique is available only few centers in India. In Indian studies, organic acidurias, homocystinemia, hyperglycinemia, MSUD, PKU, congenital hypothyroidism (CH), congenital adrenal hyperplasia (CAH), GPD deficiency, biotinidase deficiency and galactosemia were found to be the common errors. Even though individually rare, collectively a very high prevalence of inborn errors of metabolism to the extent of 1 in every thousand newborns was observed in Indian studies. The incidence of CH is 1 in 2500 births. In India, the carrier frequency of beta thalassemia is about 3.3%. The frequency of individuals with S gene was found to be 15.1%. The incidence of GPD deficiency was reported as 28% in males and 1% in females.

Screening newborn infants for phenylketonuria (PKU) was the first, large-scale genetic screening initiative to be widely adopted. High-risk individuals should be detected by a simple, inexpensive test with high sensitivity (the proportion of affected infants with a positive screening test), specificity (the proportion of unaffected infants with a negative test), and predictive efficiency (ratio of true-

positive to false-positive tests). For screening tests for PKU, see Chapter 17, under phenylketonuria.

Tetrahydrobiopterin stimulates phenylalanine hydroxylase activity in about 20% of patients with PKU, and in those patients it is a useful adjunct to the phenylalanine-restricted diet because it increases phenylalanine tolerance and allows some dietary freedom.

## Screening Technology

Screening tests are: 1. Radio-immunoassay for TSH (congenital hypothyroidism); 2. 17 alpha hydroxy progesterone (congenital adrenal hyperplasia). 3. Tandem mass spectrometry is useful for most other disorders.

### Tandem Mass Spectrometry (MS-MS)

The introduction of MS-MS for newborn screening represents a technological breakthrough. Blood obtained by heel-stick is applied to a filter-paper, four to six circles approximately 1 cm in diameter, allowed to dry in air, and sent to a screening laboratory for analysis. Small circles of blood-soaked filter paper are punched out and metabolites extracted with organic solvents. The samples are derivatized, usually by formation of the butyl esters, prior to injection into the tandem MS-MS for analysis. Tandem mass spectrometry is described in Chapter 35.

The sensitivity of tandem MS-MS testing in screening for PKU is greater than the sensitivity of any bacterial inhibition or biochemical method for measuring blood phenylalanine levels.

The power of newborn screening by tandem MS-MS is enormously enhanced by the ability to analyze several metabolites simultaneously in the same blood specimen. Newborn screening programs tend to focus on three groups of metabolites: amino acids, fatty acid oxidation intermediates, and short-chain organic acids.

## LABORATORY INVESTIGATIONS TO DIAGNOSE METABOLIC DISORDERS

They include routine biochemical tests like measurements of arterial blood gases, plasma electrolytes, glucose, urea, creatinine, liver function tests, routine hematologic tests, and various endocrinological tests, such as thyroxine, tri-iodothyronine, thyroid stimulating hormone. Studies also include measurements of lactate, pyruvate, amino acids, 3-hydroxybutyrate, acetoacetate, and free fatty acids in plasma; analyzes of urinary organic and amino acids; tests for mucopolysaccharides and oligosaccharides in urine; and measurements of certain trace elements, such as copper. The ultimate specific diagnosis of inherited metabolic disease generally requires the demonstration of a primary biochemical abnormality, such as a specific enzyme deficiency, or mutations that have been shown to cause disease.

A useful first step in helping to focus the laboratory investigation of possible inherited metabolic diseases is to try to determine whether the disease is due to a **defect in the metabolism of water-soluble intermediates**, such as amino acids, organic acids, or is likely due to an



inherited defect in lysosomal, mitochondrial, or peroxisomal metabolism (**defect in organelles**).

The **onset of signs** of disease will give an important clue to the nature of the underlying disorder. Diseases presenting with a sudden onset are generally more likely to be inherited defects of small molecule metabolism. Catastrophic deterioration on a background of chronic disease is also more likely to be due to small molecule disorders.

Studies directed at the classification of the disease processes are shown in Box 32.4. Definitive diagnosis generally requires further in vitro metabolic studies, usually specific enzyme assay.

## Lactic Acidemia

Box 32.5 gives the different conditions in which lactate/pyruvate ratio is abnormal. Deficiency of pyruvate dehydrogenase complex is the most common cause of lactic acidemia. In severe cases, death occurs at neonatal period. In moderate cases, profound mental retardation is observed. In mild cases, developmental delay is noticed.

Pyruvate carboxylase (PC) deficiency may be (A) Moderate lactic acidosis and delayed development. (B) Complex form with lactic acidosis, hyperammonemia, citrullinemia, hyperlysinemia, where death occurs in 3

### Box 32.4: Studies directed at the classification of disease processes

1. Plasma ammonium (organic acidurias and urea cycle disorders)
2. Plasma lactate, pyruvate (lactic acidosis)
3. 3-hydroxybutyrate
4. Free fatty acids
5. Quantitative or semi-quantitative analysis of plasma and urine amino acids
6. Urinary or plasma organic acid analysis
7. Urinary mucopolysaccharides (MPS)
8. Oligosaccharides screening tests
9. Galactosemia screening tests.

### Box 32.5: Plasma lactate and pyruvate

Estimation of lactate, pyruvate and lactate/pyruvate ratio (L/P ratio) are useful in the differential diagnosis of lactic acidosis.

**Increased lactate:** Dicarboxylic aciduria, fatty acid oxidation defects (hypoglycemia), biotinidase deficiency, multiple carboxylase deficiency, HMGCoA deficiency, propionic acidemia, methyl malonic acidemia, other organic acidemias.

**Increased lactate and pyruvate**, with normal L/P ratio and hypoglycemia are seen in GPD deficiency, F1, 6 Dpase deficiency, PEPCCK deficiency.

**Increased lactate and pyruvate**, with normal L/P ratio and normoglycemia are seen in PC deficiency, PDH complex deficiency, PDH phosphatase deficiency (Leigh disease).

**Increased lactate, decreased/normal pyruvate**, increased L/P ratio and decreased 3-hydroxy butyrate/acetoacetate ratio are seen in citrullinemia, hyperammonemia.

**Normal lactate** may be a finding in LHON, Complex I (mild), multiple respiratory chain (Tissue specific) disorders.

months. (C) Mild presentation, where episodic lactic acidemia, with mild mental retardation is seen.

## Plasma and Urinary Amino acids

They are useful in the diagnosis of specific and generalized aminoacidurias. Disorders of amino acid metabolism are classified in Box 32.6. See also Table 32.3. Further, Box 32.7 shows the secondary abnormalities seen in plasma or urine amino acid levels.

## Organic Acidurias

Box 32.8 shows the organic acidurias. A combination of screening with GC-MS is employed for the diagnosis.

## Lysosomal Storage Disorders (LSDs)

There are more than 40 known LSDs, out of which the most common are: Gaucher disease, Pompe disease, Fabry disease, Niemann-Pick disease, mucopolysaccharidosis I, and Krabbe disease. Almost all LSDs are inherited as autosomal recessive traits, except for the X-linked Fabry and Hunter (mucopolysaccharidosis type II [MPS II]) diseases. Individually, the incidence of these inherited

### Box 32.6: Classification of disorders of amino acid metabolism

1. Hyperphenylalaninemia
2. Hypertyrosinemia
3. Disorders of histidine metabolism
4. Disorders of proline and hydroxyproline
5. Hyperornithinemia
6. Urea cycle disorders
7. Errors of lysine metabolism
8. Disorders of branched chain amino acids and keto acids
9. Disorders of trans-sulfuration
10. Nonketotic hyperglycinemia
11. Other disorders

### Box 32.7: Secondary abnormalities in plasma or urine amino acids

Increased plasma alanine: Lactic acidosis  
 Beta amino isobutyric aciduria : Marked tissue destruction (burns, leukemia, surgery, etc.)  
 Generalized amino aciduria: Proximal renal tubular dysfunction  
 Increased plasma methionine, tyrosine : Commonly associated with hepatocellular disease  
 Methioninuria: Resulting from ingestion of d-methionine in synthetic infant formulae  
 Glycylprolinuria or prolylhydroxyprolinuria : Active bone disease  
 Increased plasma threonine : Ingestion of infant formulas with high whey to casein ratio  
 Increased plasma cystathionine: Vitamin B<sub>6</sub> deficiency.

diseases is rare, ranging between 1 in 50 000 and 1 in  $1:4 \times 10^6$ . However, collectively, LSDs are far more common, approximately 1 in 7000 to 8000 birth. The LSDs result from a mutation in a gene encoding an intralysosomal enzyme, enzyme coactivators, membrane protein, or transporter proteins. All LSDs share the common pathogenesis of accumulated metabolic substrate in the lysosome. The progressive accumulation of these products leads to cellular dysfunction. The LSDs are primarily classified according to the nature of the stored material, but some are grouped by the protein deficiency. Broad categories include MPS, GM<sub>2</sub> gangliosidosis, neutral glycosphingolipidoses, glycoproteinosis, mucopolipidoses, leukodystrophies, glycogen storage diseases, disorders of neutral lipids, and disorders of protein transport or trafficking. Many LSDs have central nervous system (CNS) involvement, with or without somatic features. Tissues that normally have a high flux of the accumulating substrate are most affected. Clinical features suggestive of LSD include developmental delay, progressive regression after a period of normal development, ataxia, seizures, weakness, and dementia. An LSD diagnosis should also be considered in the presence of coarse facial features, bone abnormalities, unexplained bone pain or psychiatric problems. Enzyme-replacement therapy is available for Gaucher disease, Fabry disease, MPS I, MPS II, MPS VI, and Pompe disease. Chaperone therapy using a small molecule to stabilize a misfolded enzyme, allowing for normal targeting to the lysosome, is in clinical trial for Fabry, Gaucher, and Pompe diseases.

## Mucopolysaccharide Screening

It is performed for the diagnosis of different types of mucopolysaccharidoses (Table 32.1). Other important inborn errors are listed in Table 32.2.

### Box 32.8: Disorders of organic acid metabolism

1. Alkaptonuria
2. Branched chain organic acidurias (e.g. MSUD)
3. Propionic aciduria, methylmalonic aciduria
4. Defect in lysine oxidation: 2-keto adipic acidemia and glutaric acidemia
5. Gamma glutamyl cycle disorders
6. Lactic acidemias
7. Mitochondrial fatty acid oxidation disorders
8. Oxidative phosphorylation disorders
9. Glutaric acidemia type II (respiratory chain).

## Urine Screening Tests

**Test for ketone bodies (Rothera's Test):** Saturate 5 mL urine with ammonium sulfate crystals and add 3 drops of freshly prepared sodium nitroprusside. Add 1 mL of ammonia through the sides of the test tube. Violet ring formed at the junction between the two liquids indicates presence of acetone or acetoacetic acid. It is not answered by beta hydroxy butyrate.

**Cyanide nitroprusside test:** 5 mL urine saturated with sodium chloride, 4 drops of ammoniacal silver nitrate. After 1 minute, KCN added until solution is clear (few drops). 4 drops of freshly prepared sodium nitroprusside is added. A purple color appearing within 2–3 minutes and **persisting** for at least 2–3 minutes is indicative of the presence of homocystine/homocysteine in urine.

**Ferric chloride test:** Phosphate precipitating agent (PPA) is prepared by 2.2 g MgCl<sub>2</sub>, 1.4 g NH<sub>4</sub>Cl, 2 mL conc. NH<sub>4</sub>OH in 100 mL distilled water. To 1 mL PPA, add 4 mL filtered urine. Solution filtered again. Urine is then acidified with 2–3 drops conc. HCl. Then add 2–3 drops of 10% ferric chloride, drop by drop. Blue/green color is indicative of amino acidurias.

**Benedict's test:** To 5 mL Benedict's reagent, add 0.5 mL urine. Boil for 2 minutes. Blue, green, yellow, orange or red precipitate indicate reducing sugars. Black color (muddy brown) is seen if homogentisic acid is present. Disaccharides may be identified by alkali destruction test. Diabetes mellitus should be born in mind.

**Dinitrophenylhydrazine (DNPH) test:** About 0.4 g% of DNPH is prepared in HCl. Equal quantities of filtered urine and DNPH reagents are mixed. A yellow white precipitate within 5 minutes is positive. Yellow color is imparted by reagent, the presence of precipitate only is positive. All keto acids can give positive test. This is generally used for diagnosing branched chain ketoaciduria, Maple syrup urine disease and isovaleric aciduria.

**Cetavlon test:** This is a simple urine screening test. 5% cetyl trimethyl ammonium bromide (Cetavlon) is prepared in 1M citrate buffer (pH 6.0). 5 mL urine and 1.0 mL cetavlon are mixed and allow to stand for 30 minutes at room temperature. A thick white precipitate is indicative of Hurler's syndrome. Cetyl pyridinium chloride (CPC)-citrate turbidity test is another screening test for Hurler's and Hunter's disease; but is less sensitive. Other mucopolysaccharidoses can be identified by **Alcian blue** staining and 2D gel chromatography.

**TABLE 32.1:** Urinary mucopolysaccharides in different mucopolysaccharidoses (MPS)

Disease	Dermatan sulfate	Heparan sulfate	Keratan sulfate	Chondroitin sulfate
MPS I	++++	+	–	+
MPS II	+++	+	–	+
MPS III	–	+++	–	+
MPS IV	–	–	++	+
MPS VI	+++	±	–	+
MPS VII	++	±	–	++
MPS IX	–	–	–	–
Normal	±	±	±	+

**Ninhydrin test :** All amino acids will answer this test. Urine is boiled with ninhydrin reagent. Light blue to dark blue (purple) color may be obtained in the presence of amino acids. Negative test rules out aminoaciduria. Amino acid **color reactions** and **thin layer chromatography** may be undertaken to identify specific amino acids. Once aminoaciduria has been detected, it has to be quantified by HPLC, preferably on both blood and urine samples.

#### Box 32.9: General principles of genetic disease management

1. Enhancing anabolism, depressing catabolism
2. Correcting primary imbalance in metabolic relationships
3. Enhancing excretion of accumulated products
4. Providing alternate metabolic pathways
5. Using metabolic inhibitors
6. Supplying products of blocked secondary pathways
7. Stabilizing altered enzyme proteins
8. Replacing deficient coenzymes
9. Artificially inducing enzyme production
10. Replacing enzymes
11. Transplanting organs.
12. Correcting underlying DNA defect.

**Test for Porphobilinogens:** Mix equal volumes of fresh urine and Ehrlich's reagent. Allow to stand for 3 minutes. Add saturated aqueous sodium acetate solution (two volumes) and stand for 3 minutes. Add a few mL of chloroform and shake thoroughly. Porphobilinogens form a red aldehyde compound insoluble in chloroform. Any red color remaining after chloroform extraction (in aqueous phase) is indicative of porphobilinogens. It is positive in acute intermittent porphyria. Porphyrins also give a red fluorescence in ultraviolet light.

Treatment policy of genetic disease is shown in Box 32.9.

### Clinical Case Study 32.1

A 1-year-old girl is brought to the hospital OP and mother reports that the baby was not achieving the normal milestones for a baby of her age. She also reports an unusual odor to her urine and some areas of hypopigmentation on her skin and hair. On examination, the girl is noted to have some muscle hypotonia and microcephaly. The urine collected is found to have a "mousy" odor. What is the

**TABLE 32.2:** Inborn errors of metabolism (selected list)

Disease	Deficient enzyme	Nutritional treatment	Chapter
Acute intermittent porphyria	Uroporphyrinogen-I synthetase		21
Albinism	Tyrosinase		18
Alkaptonuria	Homogentisic acid oxidase	Restrict Phe, Tyr. Supplement vitamin C	18
APRTase deficiency	APRTase	Purine restriction, avoid alkali, allopurinol	43
Cystic fibrosis	CFTR gene mutations	Enteric enzymes	30
Fructose intolerance	Fructose-1-P-aldolase	Restrict fructose	11
Galactosemia	Galactose-1-phosphate uridyl transferase	Restrict galactose	11
Gaucher's disease	Beta glucosidase		14
GPD deficiency	G6PD	Avoid fava beans	10
Gout	Increased uric acid pool	Restrict purine, Give allopurinol	43
Isovaleric aciduria	Isovaleryl CoA dehydrogenase	Restrict leucine; supplement carnitine, glycine	17
Lactic acidosis, PD deficiency	Pyruvate dehydrogenase	Supplement thiamin, high fat, low CHO diet, alkali	9
Lactose intolerance	Lactase	Lactose restriction	9
Lesch-Nyhan syndrome	HGPRTase		43
Niemann-Pick disease	Sphingomyelinase	Restrict cholesterol; mevinolin	14
Orotic aciduria	Orotidine-5-P decarboxylase	Supplement uridine	43
Peroxisomal defects		Supplement docosadexaenoic acid DHA, bile acid, steroids, Vitamin K	2
Tay-Sachs disease	Hexosaminidase A		14
von Gierke's disease	Glucose-6-phosphatase	Small quantity of food at frequent intervals	10
Wilson's disease	Copper transport protein	Restrict copper; D penicillamine	39

Amino acidurias are described in Table 32.3. Deficient enzymes of important inborn errors of metabolisms are given for ready reference. For more details, see the chapters in the Textbook. See also Tables 10.2, 11.1, 11.2, 14.4, 18.1 and 15.3

**TABLE 32.3:** Amino acidurias (MR = mental retardation)

Disorder	Abnormality or absence of	Clinical manifestation	Substance in blood	Substance in urine	Treatment
Phenyl ketonuria (type I)	Phenylalanine MR, hydroxylase	Phenyl hypertonia, seizure	Phenylalanine	Dietary pyruvate	Restriction of Phe
Hypertyrosinemia (type I)	Fumaryl acetoacetate hydrolase	MR; hepatorenal damage	Tyrosine; Methionine	Tyrosine, PHPPA	Restrict Phe and Tyr
Alkaptonuria	Homogentisic acid oxidase	Arthritis, cartilage	Homogentisic acid	Homogentisic acid	Nil
Homocystinuria (type 1)	Cystathionine beta synthase	MR, Ectopia lentis;	Homocysteine; Methionine	Homocystine	Cysteine Methionine <sup>-</sup>
Homocystinuria (type 2)	Methyl transferase	MR	Homocysteine	Homocystine	Folate
Homocystinuria (type 3)	Methylene THFA reductase	MR	Homocysteine	Homocystine	Folate
Histidinemia	Histidase	Mild MR; speech defect	Histidine; alanine	Imidazole pyruvic acid	Restrict Histidine
Maple syrup urine disease	Branched chain keto acid decarboxylase	MR; Maple syrup odor; acidosis	Val; Leu; Ile; keto acids	Val; Leu; Ile; keto acids	Restrict Val; Leu; Ile
Methylmalonic aciduria	Methyl malonyl CoA mutase	MR; ketosis; hypotonia	Methyl malonic acid	Methyl malonic acid; ketonebodies	Vitamin B <sub>12</sub>
Cystathioninuria	Cystathionase	Benign	Cystathionine	Cystathionine	None required
Hyperprolinemia	Proline dehydrogenase	Benign	Proline	Proline; OH-proline	
Citrullinemia	Arginino succinate synthetase	MR; vomiting seizure;	Ammonia; citrulline	Citrulline	Low protein; high Arg
Argininemia	Arginase	Spastic diplegia	Arginine; ammonia	Arginine, ornithine	Low protein diet
Hyperornithinemia	Ornithine decarboxylase	Vomiting; lethargy	Ornithine; ammonia	Ornithine	do
OTC deficiency	Ornithine transcarbamoylase	Lethargy; convulsion	Ammonia	Orotic acid; uracil; Gln	do
CPS I deficiency	Carbamoyl phosphate synthetase I	Vomiting; lethargy	Ammonia; glutamine	Glutamine	do
Argininosuccinic aciduria	Argininosuccinate lyase	Vomiting; trichorrhexis nodosa	Argininosuccinate; citrulline	Argininosuccinate; citrulline	Arginineprotein <sup>-</sup>
Cystinuria	Transporter	Urine stones	Cystine	Cystine	Alkalinization of urine
Hartnup disease	Transporter	Pellagra		Aromatic amino acids	High protein, niacin

most likely diagnosis? What is the biochemical basis of the hypopigmented skin and hair?

### Clinical Case Study 32.2

A 2-month-old baby was brought by her parents to the pediatrician. She had pale skin and blonde hair. The baby was otherwise healthy, was feeding well but was unable to fix the gaze. Ophthalmic examination showed absence of pigment in the retina. Two siblings had complete albinism,

but parents were normal. What is the defect in this patient? What is the molecular basis of the condition?

### Clinical Case Study 32.1 Answer

Likely diagnosis: Phenylketonuria (PKU).  
Biochemical basis of hypopigmentation: Phenylalanine is competitive inhibitor of tyrosinase (key enzyme in melanin synthesis).



Clinical correlation: The most common deficiency is in phenylalanine hydroxylase (autosomal recessive) resulting in the classic picture of PKU. Deficiency of dihydropteridine reductase and 6-pyruvoyl-tetrahydropterin synthase, enzymes necessary for the biosynthesis of tetrahydrobiopterin will also cause PKU. If unrecognized, the child will develop profound mental retardation and impairment of cerebral function.

Treatment consists of dietary modifications with limitation of phenylalanine intake and supplementation of tyrosine. The diagnosis of PKU and initiation of diet modification needs to be implemented prior to 3 weeks of age to prevent mental retardation.

### **Clinical Case Study 32.2 Answer**

Oculocutaneous albinism has autosomal recessive inheritance. There is defect in synthesis of melanin, and

results in pale skin, blonde hair and pink iris as seen in this patient. Visual impairment is also typical of this condition. Other symptoms include photophobia, nystagmus and functional blindness. The disease does not affect lifespan.

Albinism can be tyrosinase positive or negative. In tyrosinase positive type, enzyme is present but the melanocytes are unable to produce melanin due to a variety of reasons. In tyrosinase negative type, enzyme is absent or non-functional. In oculocutaneous type, skin, eyes and hair lack melanin, whereas in ocular albinism, only eyes lack melanin. Ocular albinism may have X-linked inheritance and hence may be more common in male offspring. The other type has equal chances in both male and female.

Genetic testing confirms diagnosis. Treatment involves protecting skin and eyes from direct sunlight.

# CHAPTER 33

## Free Radicals and Antioxidants

### Chapter at a Glance

The reader will be able to answer questions on the following topics:

- Reactive oxygen species
- Generation of free radicals
- Damage produced by free radicals
- Free radical scavenger enzyme systems
- Clinical significance
- Lipid peroxidation
- Antioxidants

The outermost orbital in an atom or molecule contains two electrons, each spinning in opposite directions. The chemical covalent bond consists of a pair of electrons, each component of the bond donating one electron each.

### Definition

A free radical is a molecule or molecular fragment that contains one or more unpaired electrons in its outer orbital (Fig. 33.1). Free radical is generally represented by a superscript dot, ( $R^\cdot$ ).

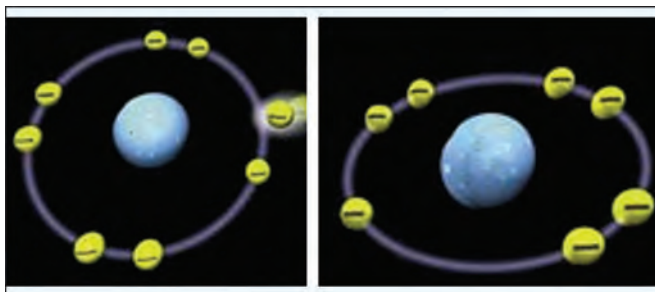


Fig. 33.1: Left side = normal oxygen atom with all paired electrons; one electron is in the process of jumping out. Right side = free radical, with an unpaired electron

Oxidation reactions ensure that molecular oxygen is completely reduced to water. The products of partial reduction of oxygen are highly reactive and create havoc in the living systems. Hence, they are also called **Reactive oxygen species** or ROS. The following are members of this group:

- Superoxide anion radical ( $O_2^{\cdot-}$ ) (Fig. 33.2)
- Hydroperoxyl radical ( $HOO^\cdot$ ) (Fig. 33.2)

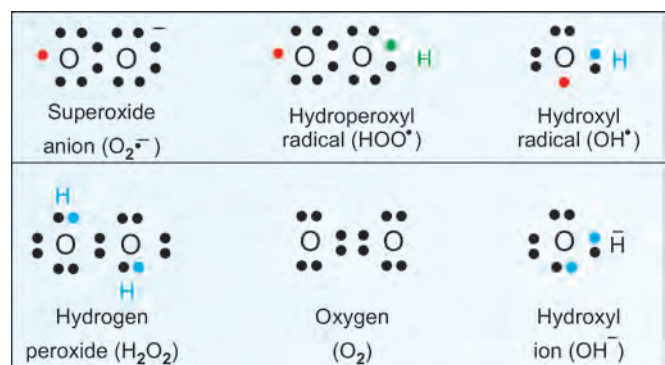
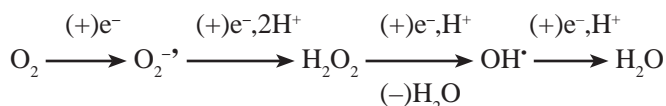


Fig. 33.2: Some free radicals. Please compare hydroxyl radical (free radical) with hydroxyl ion, which is not a free radical. Also compare oxygen with superoxide anion

- iii. Hydrogen peroxide ( $\text{H}_2\text{O}_2$ ) (Fig. 33.2)
- iv. Hydroxyl radical ( $\text{OH}^\cdot$ ) (Fig. 33.2)
- v. Lipid peroxide radical ( $\text{ROO}^\cdot$ )
- vi. Singlet oxygen ( $^1\text{O}_2$ )
- vii. Nitric oxide ( $\text{NO}^\cdot$ )
- viii. Peroxy nitrite ( $\text{ONOO}^-$ ).

Out of this, hydrogen peroxide and singlet oxygen are not free radicals (they do not have superscript dot). However, because of their extreme reactivity, they are included in the group of reactive oxygen species.

The sequential univalent reduction steps of oxygen may be represented as:



Important characteristics of the ROS are:

- a. Extreme reactivity
- b. Short lifespan
- c. Generation of new ROS by chain reaction
- d. Damage to various tissues.

## Generation of Free Radicals

- i. They are constantly produced during the normal oxidation of foodstuffs, due to leaks in the electron transport chain in mitochondria. About 1–4% of oxygen taken up in the body is converted to free radicals. Mitochondria are major sites for production of superoxide ions from the interaction between COQ and oxygen in the electron transport chain. Hence a high content of SOD is needed. Mitochondria also have a high content of glutathione and glutathione peroxidase for preventing lipid peroxidation.
- ii. Some enzymes such as **xanthine oxidase** (see Fig. 43.15) and aldehyde oxidase form superoxide anion radical or hydrogen peroxide.
- iii. **NADPH oxidase** in the inflammatory cells (neutrophils, eosinophils, monocytes and macrophages) produces superoxide anion by a process of respiratory burst during phagocytosis (Fig. 33.3). The superoxide is converted to hydrogen peroxide and then to hypochlorous acid (HClO) with the help of **superoxide dismutase** (SOD) and **myeloperoxidase** (MPO). The superoxide and hypochlorous ions are the final effectors of bactericidal action. This is a deliberate production of free radicals by the body. Along with the activation of macrophages,

the consumption of oxygen by the cell is increased drastically; this is called **respiratory burst**.

In **chronic granulomatous disease** (CGD), the NADPH oxidase is absent in macrophages and neutrophils. In this condition, macrophages ingest bacteria normally, but cannot destroy them. However, streptococci and pneumococci themselves produce  $\text{H}_2\text{O}_2$ . Therefore, they are destroyed by the myeloperoxidase system of the macrophages. But staphylococci being catalase positive can detoxify  $\text{H}_2\text{O}_2$  in the macrophages and therefore, are not destroyed in such persons. Hence, recurrent pyogenic infection by staphylococci are common in chronic granulomatous disease.

- iv. Macrophages also produce  $\text{NO}^\cdot$  from arginine by the enzyme **nitric oxide synthase** (see Fig.16.6). This is also an important antibacterial mechanism.
- v. Peroxidation is also catalyzed by **lipo-oxygenase** in platelets and leukocytes.
- vi. Ionizing radiation damages tissues by producing hydroxyl radicals, hydrogen peroxide and superoxide anion.  
 $\text{H}_2\text{O} \xrightarrow{\text{gamma, UV radiation}} \text{H}^\cdot + \text{OH}^\cdot$
- vii. Light of appropriate wavelengths can cause photolysis of oxygen to produce singlet oxygen.
- viii. The capacity to produce tissue damage by  $\text{H}_2\text{O}_2$  is minimal when compared to other free radicals (by definition,  $\text{H}_2\text{O}_2$  is not a free radical). But in presence of free iron,  $\text{H}_2\text{O}_2$  can generate  $\text{OH}^\cdot$  (hydroxy radical) which is highly reactive (Fig.33.5).
- ix. Cigarette smoke contains high concentrations of various free radicals.
- x. Inhalation of air pollutants will increase the production of free radicals. These facts are summarized in Figure 33.4.

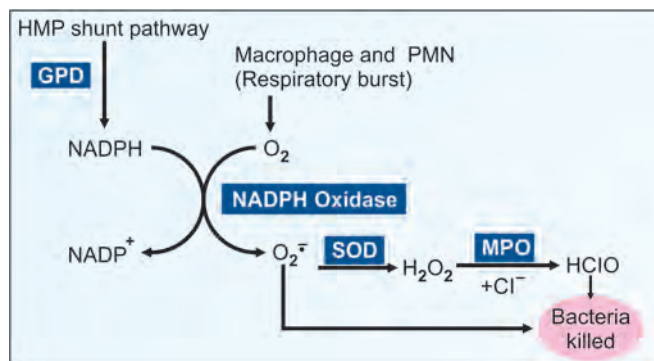


Fig. 33.3: Generation of ROS in macrophages

## Free Radical Scavenger Systems

### Superoxide Dismutase (SOD)

The reaction is depicted in Figure 33.6. The mitochondrial SOD is **manganese** dependent; cytoplasmic enzyme is **copper-zinc** dependent. SOD is a non-heme protein. A defect in SOD gene is seen in patients with amyotrophic lateral sclerosis (Lou Gehrig's disease; named after the American baseball captain who succumbed to the illness).

### Glutathione Peroxidase

In the next step, the  $\text{H}_2\text{O}_2$  is removed by glutathione peroxidase (POD) (Fig. 33.6). It is a selenium dependent enzyme.

### Glutathione Reductase

The oxidized glutathione, in turn, is reduced by the glutathione reductase (GR), in presence of NADPH (Fig. 33.6). This NADPH is generated with the help of glucose-6-phosphate dehydrogenase (GPD) in HMP shunt pathway (see Fig. 10.1). Therefore, in GPD deficiency, the RBCs are liable to lysis, especially when oxidizing agents are administered (drug induced hemolytic anemia).

### Catalase

When  $\text{H}_2\text{O}_2$  is generated in large quantities, the enzyme catalase is also used for its removal.

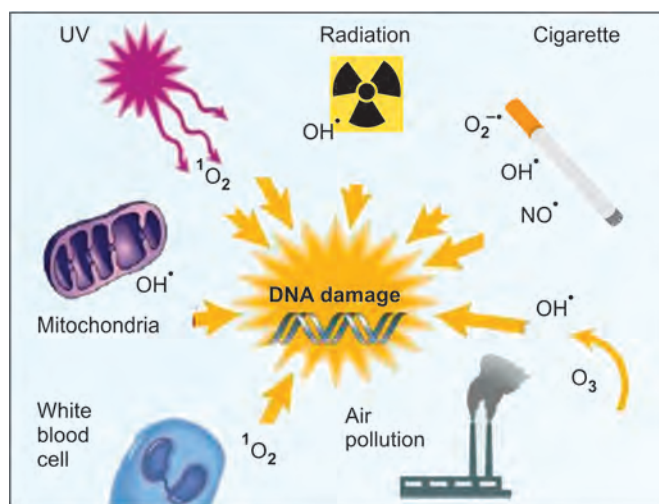
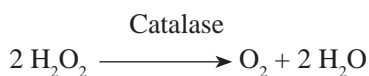


Fig. 33.4: Formation of free radicals

### Polyphenols

Consumption of polyphenol-rich fruits, vegetables, and beverages is beneficial to human health. Dietary polyphenols represent a wide variety of compounds that occur in fruits, vegetables, wine, tea and chocolate. They contain flavones, isoflavones, flavonols, catechins and phenolic acids. They act as agents having antioxidant, antiapoptotic, antiaging, anticarcinogenic, antiinflammatory and anti-atherosclerotic effects. They are protective against cardiovascular diseases. Work from author's laboratory suggests that grape polyphenols can prevent brain damage due to alcohol. Oral administration of grape polyphenol extract ameliorates cerebral ischemia induced neuronal damage. Grape-seed procyanidins prevent low-grade inflammation by modulating cytokine expression in rats.

## Damage Produced by Reactive Oxygen Species

Free radicals are extremely reactive. Their mean effective radius of action is only 30 Å. Their half-life is only a few **milliseconds**.

When a free radical reacts with a normal compound, other free radicals are generated. This chain reaction leads to thousands of events (see propagation phase below).

**Peroxidation of PUFA** (poly unsaturated fatty acids) in plasma membrane leads to loss of membrane functions. Lipid peroxidation and consequent degradation products such as **malon dialdehyde** (-CHO-CH<sub>2</sub>-CHO-) are seen in biological fluids.

Almost all biological macromolecules are damaged by the free radicals (Fig. 33.7). Thus, oxidation of sulfhydryl group

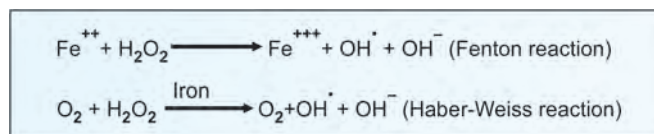


Fig. 33.5: Iron produces free radicals

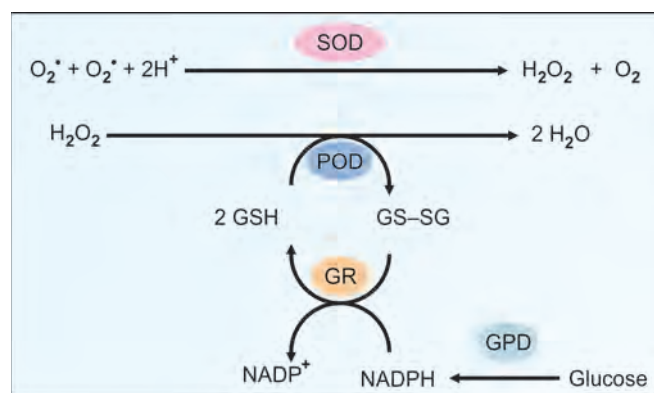


Fig. 33.6: Free radical scavenging enzymes. SOD = superoxide dismutase; POD = peroxidase; GSH = glutathione; GR = glutathione reductase; GPD = glucose-6-phosphate dehydrogenase



containing enzymes, loss of function and fragmentation of proteins are noticed. Polysaccharides undergo degradation.

DNA is damaged by strand breaks. The DNA damage may directly cause inhibition of protein and enzyme synthesis and indirectly cause cell death or mutation and carcinogenesis (Fig. 33.7).

## CLINICAL SIGNIFICANCE

### Chronic Inflammation

Chronic inflammatory diseases such as **rheumatoid arthritis** are self-perpetuated by the free radicals released by neutrophils. ROS induced tissue damage appears to be involved in pathogenesis of chronic ulcerative colitis, **chronic glomerulonephritis**, etc.

### Acute Inflammation

At the inflammatory site, activated macrophages produce free radicals. Respiratory burst and increased activity of NADPH oxidase are seen in macrophages and neutrophils.

### Respiratory Diseases

Breathing of 100% oxygen for more than 24 hours produces destruction of endothelium and lung edema. This is due to the release of free radicals by activated neutrophils.

In premature newborn infants, prolonged exposure to high oxygen concentration is responsible for **broncho-pulmonary dysplasia**.

Adult **respiratory distress syndrome** (ARDS) is characterized by pulmonary edema. It is produced when neutrophils are recruited to lungs which subsequently release free radicals.

**Cigarette smoke** contains free radicals. Soot attracts neutrophils to the site which releases more free radicals, leading to lung damage.

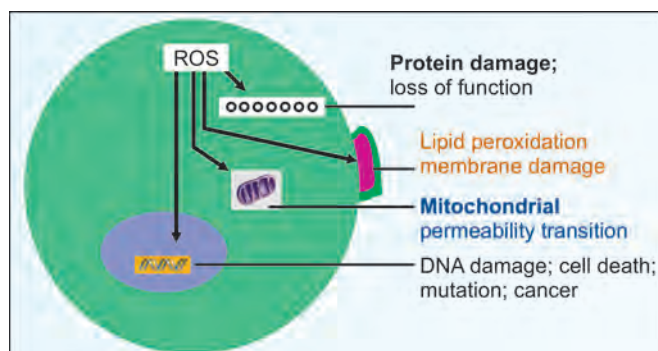


Fig. 33.7: Damages by reactive oxygen species

### Diseases of the Eye

**Retrolental fibroplasia** (retinopathy of prematurity) is a condition seen in premature infants treated with pure oxygen for a long time. It is caused by free radicals, causing thromboxane release, sustained vascular contracture and cellular injury.

**Cataract** formation is related with aging process. Cataract is partly due to photochemical generation of free radicals. Tissues of the eye, including the lens, have high concentration of free radical scavenging enzymes.

### Reperfusion Injury

Reperfusion injury after myocardial ischemia is caused by free radicals. During ischemia, the activity of **xanthine oxidase** is increased. When reperfused, this causes conversion of hypoxanthine to xanthine and superoxide anion. At the same time, the availability of scavenging enzymes is decreased, leading to aggravation of myocardial injury (Fig. 33.8A).

**Allopurinol**, a xanthine oxidase inhibitor, reduces the severity of reperfusion injury.

### Atherosclerosis and Myocardial Infarction

**Low density lipoproteins** (LDL) are deposited under the endothelial cells, which undergo oxidation by free radicals. This attracts macrophages. Macrophages are then converted into **foam cells** initiating atherosclerotic plaque formation (see Chapter 25). Antioxidants offer some protective effect.

### Shock Related Injury

Release of free radicals from phagocytes damage membranes by lipid peroxidation. They release leukotrienes from platelets and proteases from macrophages. All these factors cause increased vascular permeability, resulting in tissue edema. Antioxidants have a protective effect.

### Skin Diseases

Certain plant products, called **psoralens** are administered in the treatment of psoriasis and leukoderma. When the drug is applied over the affected skin and then irradiated by UV light, singlet oxygen is produced with clinical benefit.

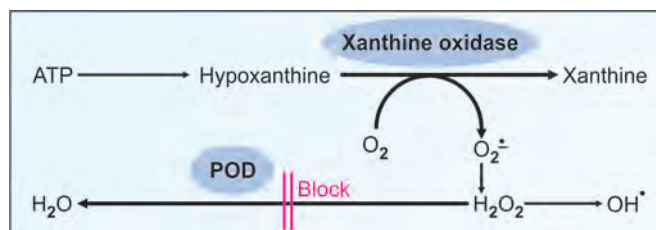


Fig. 33.8A: Explanation for reperfusion injury

## Carcinogenesis and Treatment

Free radicals produce DNA damage, and accumulated damages lead to somatic mutations and malignancy. Cancer is treated by radiotherapy (see Chapter 59). Irradiation produces reactive oxygen species in the cells which trigger the cell death.

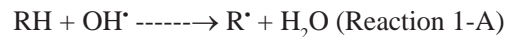
## Aging Process

**Reactive oxygen metabolites (ROM)** play a pivotal role in degenerative brain disorders such as Parkinsonism, Alzheimer's dementia and multiple sclerosis. Cumulative effects of free radical injury cause gradual deterioration in aging process. A summary of free radical toxicity is shown in Figure 33.8B.

## Lipid Peroxidation

### Initiation Phase

Polyunsaturated fatty acids (PUFA) present in cell membranes are easily destroyed by peroxidation. During the initiation phase, the primary event is the production of  $R^{\bullet}$  (carbon centered radical) (PUFA radical) or  $ROO^{\bullet}$  (lipid peroxide radical) by the interaction of a PUFA molecule with free radicals generated by other means (Fig.33.9).



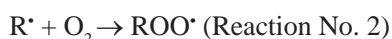
Metal ion



The  $R^{\bullet}$  and  $ROO^{\bullet}$ , in turn, are degraded to malon dialdehyde (3 carbon). It is estimated as an indicator of fatty acid breakdown by free radicals.

### Propagation Phase

The carbon centered radical ( $R^{\bullet}$ ) rapidly reacts with molecular oxygen forming a peroxy radical ( $ROO^{\bullet}$ ) which can attack another polyunsaturated lipid molecule.



The net result of reactions 2 and 3 is the conversion of  $R^{\bullet}$  to  $ROOH$  (a hydroperoxide). But there is simultaneous conversion of a carbon centered radical to a peroxy radical,  $ROO^{\bullet}$ . This would lead to continuous production of hydroperoxide with consumption of equimolecular quantities of PUFA. One free radical generates another free radical in the neighbouring molecule; a “**chain reaction**” or “propagation” is initiated. This is sometimes called

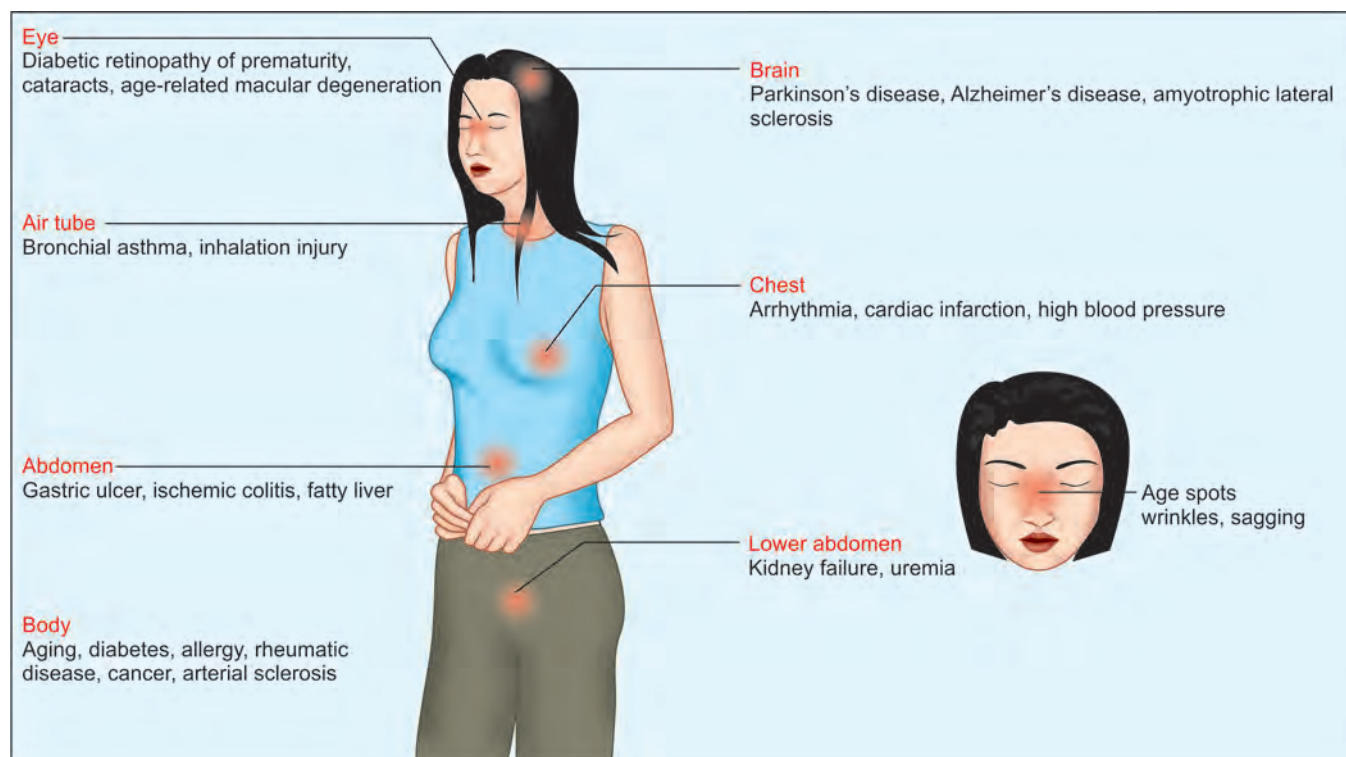


Fig. 33.8B: Free radical toxicity

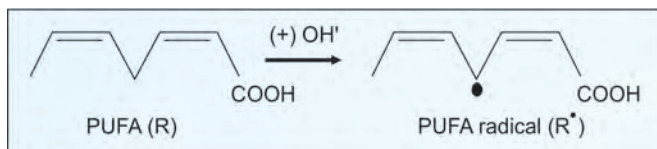
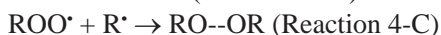
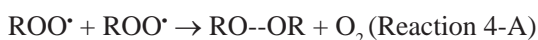


Fig. 33.9: Peroxidation of polyunsaturated fatty acids

“death kiss” by free radicals. Accumulation of such lipid damages lead to the destruction of fine architecture, and integrity of the membranes.

### Termination Phase

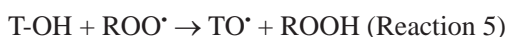
The reaction would proceed unchecked till a peroxy radical reacts with another peroxy radical to form inactive products.



## Role of Antioxidants

Apart from the scavenging enzymes described earlier, there are two types of antioxidants:

- Preventive antioxidants:** They will inhibit the initial production of free radicals. They are catalase, glutathione peroxidase and ethylenediaminetetraacetate (EDTA).
- Chain breaking antioxidants:** They can inhibit propagative phase. They include superoxide dismutase, uric acid and vitamin E. **Alpha tocopherol** (T-OH) (vitamin E) would intercept the peroxy free radical and inactivate it before a PUFA can be attacked.



The phenolic hydrogen of the alpha tocopherol reacts with the peroxy radical, converting it to a hydroperoxide product. The tocoperoxy radical thus formed is stable and will not propagate the cycle any further.

The tocoperoxy radical can react with another peroxy radical getting converted to inactive products.



**Vitamin E** (Alpha tocopherol) acts as the **most effective** naturally occurring chain breaking **antioxidant** in tissues. Vitamin E is described in Chapter 36. Only traces of tocopherol are required to protect considerable amounts of polyunsaturated fat (1 tocopherol molecule per 1000 lipid

molecules). But it is seen from reaction 5 and 6 that while acting as antioxidant, alpha tocopherol is consumed. Hence, it has to be replenished by daily dietary supply.

## Antioxidants

- Vitamin E** is the lipid phase antioxidant.
- Vitamin C** is the aqueous phase antioxidant.
- Ceruloplasmin** can act as an antioxidant in extracellular fluid (see Chapter 28).
- Caffeine** is another effective antioxidant.
- Cysteine, glutathione, carotenoids, flavonoids and vitamin A are minor antioxidants. **Beta carotene** can act as a chain-breaking antioxidant, but is less effective than alpha tocopherol. The incidence of heart attack is only 50% in vegetarians compared to non-vegetarians.
- Food items containing good quantity of antioxidants are: a) Spices used in ordinary Indian cooking contain highest quantity of antioxidants. b) Curcumin. c) Fruits and vegetables such as berries, broccoli, spinach, asparagus and green tea, which contain flavonoids, flavones, isoflavones and anthocyanins. d) Resveratrol present in grapes.

## Antioxidants used as Therapeutic Agents

- Vitamin E**
  - Vitamin C**
  - Dimethyl thio urea
  - Dimethyl sulfoxide
  - Allopurinol
- Caution should be kept in using vitamin E. Excess quantity of vitamin E may act as pro-oxidant and may be deleterious.

## Commercial Use of Antioxidants

Antioxidants are regularly used in food industry to increase the shelf-life of products. Commercially used **food preservatives** are Vitamin E, propyl gallate, butylated hydroxy anisole (BHA) and butylated hydroxy toluene (BHT). They prevent oxidative damage of oils, particularly those containing PUFA and prevent rancidity.

## Protection Against Ozone

When ozone content in air is low, protection is by uric acid present in the lining of the nasal cavity. Glutathione and ascorbic acid in the proximal and distal respiratory tract additionally reacts with ozone. Ozone which escapes this antioxidant screen can react with proteins, carbohydrates and lipids to generate lipid peroxides, to generate a chain reaction. A second line of defense is by alpha tocopherol and glutathione. Most individuals are able to protect against small amounts of ozone in the atmosphere, but about 10 – 20% healthy individuals can have respiratory symptoms.

## Related Topics

Details of nitric oxide are described in Chapter 17.



# CHAPTER 34

## Clinical Laboratory; Quality Control

### Chapter at a Glance

The reader will be able to answer questions on the following topics:

- Preanalytical variables
- Anticoagulants and preservatives
- Quality control in the laboratory
- Accuracy, precision, specificity, sensitivity
- Total quality management
- Quality control charts
- External quality assurance

### REFERENCE VALUES

A patient's results have to be compared with the reference values to either confirm a clinical diagnosis or exclude a particular disease. **Reference values** and **normal values** should not be considered as synonymous. The term "normal" was used arbitrarily in the past, but was found to be ambiguous when used in a statistical sense. As per **IFCC** (International Federation of Clinical Chemistry and Laboratory medicine) recommendations, reference values are based on that of a reference individual.

The value obtained by analysis of a particular sample is referred to as the **observed value**, which is compared with the **reference value** to arrive at a decision. There are different types of reference values which are population based or subject based. Subject based reference value indicates previously observed values in the same subject. The reference values may be univariate or multivariate. For instance, we can interpret the values of TAG and cholesterol in serum either separately or together. The conclusions drawn may be different.

The reference values are established in healthy individuals. Reference values are based on application of **statistical methods** to

values generated in the laboratories. The normal values are derived based on the distribution of these values. Direct sampling methods where individuals are selected based on inclusion criteria or where existing data satisfying inclusion criteria provide reliable reference values. Screening large populations to get reference groups is also a possibility. Ideally, the group of reference individuals should be a random sample (equal chance of being selected).

There are **three types of reference intervals**; tolerance interval, prediction interval and interpercentile interval. When the sample size is large, the numerical difference between these intervals is negligible.

**Interpercentile interval** is the easiest to estimate and recommended by IFCC. It is the interval bounded by two percentiles of the reference distribution. A **percentile** denotes a value that divides the reference distribution such that a specified percentile of values have magnitudes less than or equal to the limiting value. If a value of 4 mmol/L is the 97.5 percentile of serum potassium, 97.5 % of the values are equal to or below that value. 2.5 % of the values are cut off in both tails of the reference distribution when the reference interval is conveniently defined as 95% interval.

The **precision of the percentile** depends on the number of values. Fewer the values, lesser is the precision. Confidence interval of the percentile is the limits within which the true percentile is located with



a specified degree of confidence. The theoretical lower limit of the sample size required for the estimation of a precise reference value is usually 120.

A **diagnostic criterion** is a cut off value for making a diagnosis, e.g. hypoglycemia. **Prognostic limit** is a value, which indicates a definite improvement or deterioration of the condition, e.g. plasma glucose after insulin. Therapeutic value and toxicity threshold are applicable in cases of analytes like lithium where therapeutic effectiveness and onset of toxicity are within very narrow limits.

### Reference Values and Observed Values

In actual clinical practice, often we have to compare several observed values with their reference intervals. For analytes which are under hormonal or metabolic control, there may be subject based **variation**; intra-individual or inter-individual (e.g. progesterone levels in pregnant women).

Each laboratory should have their own established reference values and the observed value and reference value may be reported on the same report sheet for purposes of comparison and clinical decision making.

The observed value may also be expressed by a statistical distance measure. **Standard deviation (SD)** unit is calculated as the difference between the observed value and the mean of the reference values divided by their standard deviation.

The variations observed in the level of alpha fetoprotein, beta hCG and estradiol in maternal serum depend on the period of gestation. So, the reference values for these parameters must be available in laboratories on a weekly basis. The reference values are compared with the observed values and expressed as **Multiple of Median (MoM) values**. The decision making, whether to continue the pregnancy or terminate, is based on the MoM values for a particular subject. This is obtained by dividing each test result by the median for the relevant gestational week.

## PREANALYTICAL VARIABLES

Preanalytical variability is defined as errors which occur when non-analytical factors change the concentrations of analytes, so that the results do not reflect the condition of the patient. Preanalytical variability may be due to a) pre-collection causes, or b) blood collection causes. Important types of preanalytical variables are shown in Box 34.1. Clinicians should know about these variables; then only a correct interpretation is possible. Preanalytical variables may be controllable so that their effect can be minimized. The terminologies, preanalytical as well as analytical variables are recently re-designated as pre-examination or examination variables.

### Time of Collection

Fasting samples are used for insulin, C-peptide, gastrin and triglycerides (TAG). Fasting sample is a must for TAG. Time of collection is important for androstenedione and 17 hydroxy progesterone that are collected in the afternoon.

#### Box 34.1. Types of preanalytical variables

**Test conducted.** The appropriate test should be requested and performed.

**Patient identification.** The labeling of specimen may be improper. Corrected by bar coding.

**Turnaround time (TAT).** The time required from the specimen reaching the laboratory and the result being dispatched should be kept minimum. Time of arrival, completion of test and dispatch should be noted.

**Laboratory logs.** Entry of patient and test details in laboratory registers and computers.

**Transcription errors.** Substantial number at different levels especially if sample number is high. Electronic identification and tracking of specimens. Check digits, units and test correlation.

**Patient preparation.** Improper standardization of the collection time and manner of collection.

**Specimen collection.** Container, anticoagulant time taken to send specimen to laboratory, corrected by using vacutainer tubes and collection of samples by laboratory personnel.

**Separation, aliquoting.** Monitoring of the performance of the centrifuge, container used for storage. Emergency specimens to be processed as fast track and given priority in stat analyzers.

**Personnel.** Variation from person to person. Safety precautions for all specimens. Throughput time (time taken from arrival of specimen to completion of assay) to be monitored on a weekly or monthly basis.

### Posture

Upright posture decreases blood volume to about 10%. A change in posture from lying to upright increases secretion of catecholamines, aldosterone, renin, ADH. Catecholamine secretion doubles within 10 minutes and aldosterone and renin doubles in 1 hour. Release of intracellular potassium from muscle causes an increase in potassium after 30 minutes of standing.

### Prolonged Bed Rest

Extracellular fluid volume decreases after a few days of bed rest. Hematocrit value increases about 10% within 4 days. When bed rest is prolonged, the level of proteins and protein bound constituents are decreased. Urinary excretion of catecholamines, cortisol, VMA and blood urea decreases by 2-3 weeks of bed rest. Calcium, sodium, potassium, phosphate and sulfate excretion increases and takes about 3 weeks to return to normal.

### Exercise

After moderate exercise there is a stress response that increases blood glucose. Plasma pyruvate and lactate are increased two fold. Arterial pH and  $p\text{CO}_2$  decrease. Slight increase is seen in creatinine, uric acid, CK, LDH, AST and aldolase. Those who are in the habit of walking about 4 hours per week have 5% lower cholesterol and 3.5% higher HDL cholesterol.



Strenuous exercise causes more pronounced effects on the same parameters. Plasma cortisol is elevated without any pronounced diurnal variation. Aldosterone, growth hormone and prolactin are increased while pH, bicarbonate and  $p\text{aO}_2$  are decreased.

Those who undergo systematic training like athletes have higher CK, urea and uric acid and creatinine due to increased muscle metabolism and turnover. Serum cholesterol may be lowered as much as 25% while HDL may increase. The decrease in total cholesterol is due to lowering of LDL cholesterol. TAG is also lowered. Plasma free fatty acids increase, but lactate response is less since muscle metabolism is mainly aerobic.

### Circadian Variations

Several analytes in body fluids exhibit **diurnal variation** (Circadian rhythm) in their secretion. Variations in level are therefore to be expected depending on the time of collection. This mainly applies to hormones that are secreted in a pulsatile manner (Table 34.1).

### Diet

It has a significant effect on several analytes. A high protein diet causes a doubling of urea concentration within 4 days. A high fat diet depletes the nitrogen pool, but serum TAG increases. The serum cholesterol does not reflect short-term changes in the diet. The ingestion of a meal elevates the plasma levels of glucose and lipids. Phosphate level falls during the postprandial state since phosphate enters the cells for metabolizing glucose. Since most of the parameters are assayed in the same sample, a **fasting sample is preferred**. A minimum of 10 to 12 hours fasting prior to collection of samples is required. The alkaline tide of plasma following a meal is reflected in the serum bicarbonate level.

**Nature of the diet** may also have some effects like high fiber diet (glucose, cholesterol, calcium, TAG), presence of caffeine (catecholamine and metabolites), banana (serotonin and 5HIAA). Vegetarians in general have low LDL-C, but HDL-C is more. Urinary pH is higher in vegetarians compared to meat eaters. Urea and uric acid levels are also lower in vegetarians. Lifestyle has a notable effect on blood parameters.

**TABLE 34.1: Circadian variations in analytes**

Analyte	Pattern of secretion
Cortisol	Peak, 6–8 am; minimum 10 pm. Secretion increases 3–5 fold from late evening to a maximum at waking time. Earliest indication of abnormality is a loss of diurnal rhythm of secretion
ACTH	Same as above
Growth hormone	Peak 10 pm; low 8 am. Maximum during sleep and minimum at waking time. Increases during exercise.
Renin and Aldosterone	Peak 8 am, low at late evening. Changes with posture also. To be collected in the recumbent position
Catecholamines	24-hour samples collected. Secretion is in urine less during night. Night workers have a reversal of pattern

Smoking and alcohol increase the level of TAG. Chronic alcoholism increases GGT levels.

### Pharmacological Agents

Several drugs can alter blood parameters. Any intramuscular injection of drugs can elevate CK and aldolase levels. Oral contraceptives elevate ALT and alter estrogen and progesterone levels. Diuretic use is known to decrease sodium and potassium levels and increase calcium. Phenytoin decreases calcium, and phosphate, but elevates ALP. Statins and aspirin are likely to affect hepatic enzyme levels and coagulation parameters respectively.

### Non-controllable Variables

Factors like age, sex, race, affect several parameters and reference values are established taking these variables under consideration. Physiological states like pregnancy, lactation, menstrual cycle, environmental factors like altitude, temperature, psychological factors like stress and shock, underlying causes like obesity, fever, trauma and transfusion can all cause significant variation in several specific parameters. Separate reference standards are maintained for children, adult and aged. If the relevant information is provided in the laboratory request form also, the reporting and interpretation will be more accurate.

## SPECIMEN COLLECTION

Use of vacutainer tubes is the standard procedure in specimen collection. The ease of barcoding the tubes and using them as specimen tubes in autoanalyzers have decreased the chances of variation at this stage.

**Plasma values** are higher than serum values in the case of calcium and chloride. Plasma values are less than serum values for albumin, ALP, AST, bicarbonate, creatine kinase, urea, uric acid, sodium, glucose (5%), phosphate (7%) and potassium (8.4 %).

**Arterial blood** is used for ABG (arterial blood gas) analysis. Most of the other investigations use venous blood. However **capillary blood** gives higher values than venous for glucose and potassium, lower values for bilirubin, calcium, chloride and sodium, but no difference for urea and phosphate.

### Hemolysis

Vigorous suction by the syringe during blood collection, or forceful transfer from the syringe to the container may cause hemolysis of blood. Even minimal hemolysis will alter the values of potassium. The presence of visually appreciable **hemolysis** is seen when the hemoglobin level is more than 200 mg/L. Enzymes like aldolase, LDH, ACP, ICD and electrolytes potassium, magnesium and phosphate are elevated by the presence of hemolysis. Hemolyzed samples give falsely low values for bilirubin and special care is to be taken when blood is collected for neonatal bilirubin estimation.

### Anticoagulants

Serum from coagulated blood is the specimen of choice for many assay systems. Commonly used anticoagulants are heparin, EDTA, oxalates,



citrate and fluoride. Of these, lithium heparin is best suited for most of the biochemical estimations. All other anticoagulants chelate calcium and hence unsuitable for calcium estimation. The possibility of enzyme inhibition especially creatine kinase, ALP, ACP, amylase and LDH are observed with several of these anticoagulants. Oxalates are unsuitable for estimation of sodium and potassium also.

**Heparin** is the most widely used anticoagulant for clinical chemical analysis. It interferes the least with test procedures.

Ethylenediaminetetraacetic acid (**EDTA**) is a chelating agent, and is particularly useful for hematological examination because it preserves cellular components of the blood. It may affect some of the clinical chemistry tests.

**Sodium fluoride** is usually used as a preservative for blood glucose by inhibiting the enzyme systems involved in glycolysis. Without an antiglycolytic agent, the blood glucose concentration decreases about 10 mg/dL per hour at 25°C and false results may be obtained. However, such serum should not be used for enzymatic assays.

**Oxalate** is widely used for coagulation studies. **oxalate** inhibits blood coagulation by forming insoluble complexes with calcium ions. Potassium oxalate may be used at a concentration of 1–2 mg/mL; at higher concentrations, oxalate may cause hemolysis.

### Storage and Preservation of Specimens

Plasma or serum should be separated from the cells as soon as possible, and certainly within 2 hours. If the specimen cannot be analyzed at once, the separated serum should be stored in capped tubes at 4°C. When a sample is to be stored beyond a week, it should be kept at –20°C in a freezer.

For assays that are done in batches, the specimens should be properly preserved to avoid erroneous results. Some examples are given in Table 34.2. Table 34.3 gives some examples of preservatives to be used.

### Transport of Specimens

Transport from a referring laboratory to a reference laboratory should be presumed to take 72 hours. It is the responsibility of the referring laboratory to see that specimens are sent with proper identification and

preservation. Referring laboratory should retain an aliquot of the sample for retesting if anything should happen to the sample during shipment.

The primary container that holds the specimen should be polypropylene or polyethylene with Teflon lined screw cap. Glass should not be used, as it is liable to be broken during transport. The container should be properly sealed. Specimens transported by air should be protected from changes of pressure and temperature and the possibility of vibration. Styrofoam containers are suitable since frozen and refrigerated samples can also be sent in these. The container should be at least 1" thick with proper insulation vents to prevent explosion due to CO<sub>2</sub> build up. Dry ice (solid CO<sub>2</sub>) can be used, but airlines have restrictions for its use.

### Care of Infected Specimens

Samples from patients, who are positive for H<sub>1</sub>N<sub>1</sub>Ag (hepatitis B surface antigen) or HIV, should be kept separately, in protected bags. The specimen is disposed off properly. Any serum specimen may be from patients of these diseases. **Therefore, all serum or blood samples should be handled as if they are infected** and adequate precautions should be taken.

### Urine Collection

An early morning fasting specimen is generally the most concentrated specimen. Therefore, it is preferred for microscopic examination and for the detection of proteins and beta chorionic gonadotropin.

### Timed Urine Specimen

Usually, urine sample is collected for a 24-hour period. This will minimize the influence of short-term biological variations and diurnal rhythms. Generally, collection of urine samples are done from 6 AM to next 6 AM. The bladder should be emptied when the collection is started (6 AM), and this urine is discarded. Thereafter, all the urine should be collected. The next day urine is voided at 6 AM, and this sample is also collected.

### Urine Preservatives

The preservatives are used (1) to reduce bacterial action, (2) to minimize chemical decomposition, and (3) to decrease atmospheric oxidation of unstable compounds. The most satisfactory form of preservation of urine specimen is to refrigerate it during the collection. Formalin, thymol, chloroform, toluene, concentrated HCl and glacial acetic acid are the commonly used urine preservatives.

**TABLE 34.2:** Processing and preservation of specimens

Assay	Processing and preservation
ACTH	Immediate freezing
Barbiturate, fibrinogen	Heparin should not be used as the anticoagulant
Renin	Samples should be chilled during collection and centrifugation
Vitamin A	Protected from light
Cortisol, magnesium	Plasma to be separated immediately after collection
Cryoglobulin	Samples should not be refrigerated, kept above 20°C
Zinc	Acid washed glass to be used

**TABLE 34.3:** Examples of preservatives

Analyte	Preservation
Acid phosphatase	Citrate (10 g/L)
Alcohol	Sodium fluoride (10 g/L)
Aldosterone	Boric acid (20 g/L)
Galactose	Heparin and NaF
Lactate or pyruvate	Diluted with equal volume of 5% perchloric acid



## QUALITY CONTROL (QC)

Quality control should become an integral part of the operation of a clinical chemistry laboratory. The purpose of quality control is to ensure the reliability of each measurement performed on a sample. Quality is defined as conformance to satisfying the needs and expectations of the customers.

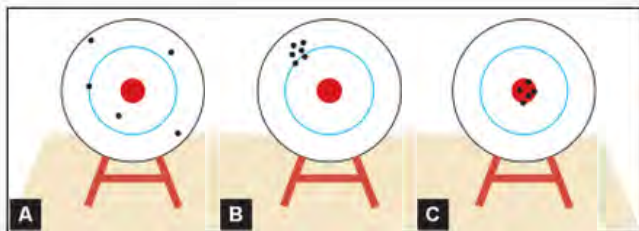
The term **error** should be discriminated from mistake in laboratory practice. A **mistake** is an avoidable error. Therefore, quality management programs aim at totally avoiding mistakes. However, in spite of all efforts we can only minimize errors. Errors can occur at different levels: physicians' request, patient related, specimen related, test related and result related. If the errors are promptly detected, corrective action can be taken. In most cases, the errors creep in due to pre and postanalytical variables.

A central reference laboratory sends a serum sample containing known quantity of a substance; this is analyzed in a peripheral (small) laboratory. If the result obtained in the peripheral laboratory is the same as that of the reference laboratory, then the arrangements available in the peripheral laboratory is said to be reliable. This is called **external quality control**. This type of checking is usually done once or twice in a month. Moreover, the peripheral laboratory itself makes a reference standard serum sample, and checks the results on a daily basis; this is called **internal quality control**.

### Within Batch Variation

This is used to evaluate how good the technique is at giving the same result for identical samples in one attempt. This method often identifies whether a machine has bias towards a certain location on the rotor. We can calculate the mean and standard deviation (SD) of the same sample taken in different tubes. Then calculate the percentage coefficient of variance (CV)

$$CV = (SD / \text{Mean}) \times 100$$



**Figs 34.1A to C:** A = Imprecise; B = Precise but inaccurate; C = Precise and accurate

### Between Batch Variation

This is used to evaluate how good the technique is at giving the same result on separate attempts. It is used to evaluate, if the machine or a different technician will give a different result at a different time.

### Accuracy

It is the closeness of a result to the true value. For example, if one technician performs a test on a serum which is known to contain 100 mg/dL glucose and obtains a result of 99 mg/dL. A second technician does the same test on the same sample, and gets the result of 95 mg/dL. Then the value of the first technician is considered as accurate. Values farther away from the true value are less accurate than those closer.

### Precision

This refers to the reproducibility of the result. If one technician performs glucose analysis on the same sample on three different occasions and obtains 100 mg/dL, 99 mg/dL and 101 mg/dL respectively, then the results have been reproduced very well, and the precision is very good. Precision depends on the technique, the reagents, as well as on the technical ability of the technician (Fig. 34.1).

**Precision** is how close repeated measures of the same sample lie; **accuracy** is how close the value reported is to the true value and **bias** describes variables which may affect precision and accuracy and lead to over or under reporting.

### Specificity

Specificity of a reaction denotes that only one substance will answer that particular test. For example, in the case of glucose oxidase method, only glucose molecules are assayed. So it is a very specific method. But if the reducing property of the glucose is utilized for the assay purpose (e.g., Nelson Somogyi method), then other reducing agents in the blood will interfere in the reaction, and hence specificity is lowered. Specificity is determined by the method of the analysis.

### Sensitivity

It indicates that whether the method could be utilized to test a very dilute solution. For example, biuret method is used for solutions having a few gram of protein/dL. Spectrophotometric method is useful to detect a few milligram of protein/dL, while ELISA method is employed



if the solution has only microgram of protein/dL. Thus ELISA method is most sensitive.

### Sensitivity and Specificity

The sensitivity of an assay is the fraction of those with a disease that the assay correctly predicts. Specificity is the fraction of those without the disease that the assay correctly predicts. A test should be both sensitive and specific. Generally speaking, as the sensitivity is increased, specificity is decreased.

Decision **cut off limits** for estimates of specificity and sensitivity are fixed by **receiver operating characteristic (ROC) curves** where sensitivity is plotted on the y-axis and specificity on the x-axis. False positives are plotted on the x-axis and true positive on the y-axis. The whole curve is the graphical display of the test performance. The ROC curves of two different tests can be compared more scientifically and the area under the curve is a measure of the relative performance. A test with high sensitivity and specificity is chosen.

The **odds ratio** is defined as the probability of the presence of a specific disease divided by the probability of its absence. The odds ratio reflects the prevalence of the disease in a population. Likelihood ratio is the probability of occurrence of a specific result divided by the probability of the same result if the disease were absent, i.e. (sensitivity / (1-specificity)). Odds ratio of the occurrence of a disease is calculated before the test result and after the test result is known. This is then combined with likelihood ratio. The final result can be converted into probability.

Odds ratio after = odds ratio before × likelihood ratio

### Total Quality Management (TQM)

Practices of TQM were introduced in the healthcare sector just as in industry. Similarly, the **six sigma principles** and metrics (six standard deviation of process variation) of TQM were introduced in laboratory testing process. **The 5 Qs in Quality management** are: Quality planning, Quality laboratory process; Quality control; Quality assurance and Quality improvement. In order to implement a Quality assurance program in the laboratory, there should be **commitment, resources and technical competence**. The term Quality control refers to the technical procedures employed in quality assurance program. These include control of preanalytical variables, analytical variables and monitoring the quality of analysis.

### Reference Materials and Calibration

**Reference material (RM)** is a substance having homogenous and well established property values used for the calibration of an apparatus, an assay method, or assigning values to materials.

**Certified reference material (CRM):** The reference material is accompanied by a certificate, one or more of the property values having been certified by an established procedure.

**Calibration material or calibrator:** A material (device) of known or assigned qualitative and or quantitative characteristics (like concentration, activity, intensity, reactivity) used to calibrate, graduate or adjust a measurement procedure or to compare the response obtained with the response of a test specimen

**Control material** is a device, solution, lyophilized material or pooled specimen or artificially derived material to be used in quality control process. The use of reference materials, calibrators and controls will help a routine method to be correlated to a reference method when evaluated. The reference method itself is validated against a definitive method using primary reference material (PRM). True value is thus obtained. Both internal and external quality control is required to validate a method.

### Quality Control Charts

These are used to compare the observed control values with the control limits and provide a visual display which can be quickly reviewed. A daily QC chart should be available in the laboratory. The control chart helps to detect accuracy problems (shift in mean) and precision problem (shift in SD). The values will indicate if the analytical run is in control (acceptable) or out of control (unacceptable). If any of these changes are noticed, prompt action is warranted.

Inherent random errors can occur. It is very difficult to totally eradicate this error. But the control procedure should be able to detect an additional error signal in the presence of inherent **random error** (noise). Probability for false rejection and probability for error detection are denoted by power function graphs plotted using error on the y-axis and probability on the x-axis.

**Levy Jening's (LJ) chart:** Control specimens are analyzed during each run and the value plotted on the chart. When control values are within the control limits ( $\pm$  or  $-3$  SD), patient's values can be reported. Even if a single control value is out of limit, reporting should be stopped. Resolve the problem, repeat the entire run of specimen and controls.

**Westergard multirule chart:** This uses the same procedure using two different controls, but the control limits show 1s, 2s and 3s values. When both control values are within 2s, the values are acceptable. If a single value exceeds plus or minus 2s, it is to be taken as a warning. If one value exceeds plus or minus 3s, random error is detected as per rejection rule. two observations beyond plus or minus 2s also is a rejection rule sensitive to systematic error. If 4 values exceed plus or minus 1s, indicates systematic error. This chart therefore helps to detect the type of error also. If the values are out of control reporting should be stopped. In each case, carefully examine, which control rule is violated and act accordingly.

Single control charts display the difference between observed value and the expected mean. **Cumulative sum (Cusum) chart** is more quantitative. Calculate the difference between the value and the expected mean. Obtain the CUSUM by adding this difference to the cumulative sum of the previous difference. The CUSUM control chart is plotted and observe the slope. A steep slope indicates a systematic error and the run is out of control. An alternative way of interpreting the CUSUM chart is to use the numerical limit of the CUSUM chart value itself.

### External Quality Assurances (EQAS)

This is used to evaluate if we get a different result if the test is done at a different site. Typically, a national organization will send the same sample to different laboratories; the laboratories will send the results to the organization, which will measure how similar the results are. Internal QC maintains the accuracy and precision of the analytical method, whereas EQAs is necessary for maintaining long-term accuracy of



analytical methods. The basic program involves the analysis of the same QC material by different laboratories and the results are dispatched to the central control laboratory, for data analysis. Summary of reports are then sent to the participating laboratories by the controlling laboratory. For each analyte the SDI ( **standard deviation index**) is calculated using the student "t" test. When the difference is significant from a particular laboratory, that laboratory is alerted.

$SDI = \frac{\text{Laboratory result} - \text{Group mean}}{\text{Groups SD}}$

By analyzing two different control materials by each laboratory, the systematic error can be obtained by **outlier plots** (observed mean for material A on the y axis versus observed mean for material B on the x axis). The point for the laboratory is expected to fall at the center of the plot. If points fall away from the center, but on the same spot, it shows that the error is constant. By using appropriate software, laboratories can integrate internal and external quality assurance programmes.

## Other Clinical Biochemistry Topics

The basic principles of methods for analyzing different constituents in clinical laboratory are given under appropriate headings, e.g. serum proteins (Chapter 4), serum enzymes (Chapter 23), blood sugar estimation (Chapter 24), serum cholesterol (Chapter 25), serum creatinine (Chapter 27), urinary VMA (Chapter 18), blood urea (Chapter 27), urine analysis (Chapter 27), renal clearance tests (Chapter 27). Normal reference values are given in the Appendix No. II.

### Clinical Case Study 34.1

A 29-year-old pregnant woman, while waiting in the clinic for results of glucose tolerance test, complained of severe abdominal pain. A doctor was called to the laboratory, to see the patient. Doctor suspected acute pancreatitis, and requested the laboratory to assay serum amylase and

lipase. The technician performed the tests, using the plasma remaining from her glucose tolerance test. The serum amylase value was 180 U/L (normal 50 – 120); but her lipase value was normal. In the meanwhile, patient felt comfortable. But, the discrepancy in the laboratory results caused confusion in diagnosis. So doctor requested a repeat analysis. A fresh blood sample was taken for the tests. This time, her serum amylase and lipase were found to be normal.

- Explain the discrepancy in the amylase results.
- Do you think serum amylase value will come down to normal levels within a few hours?
- What are conditions in which serum amylase is increased?
- What are the advantages of lipase estimation?

### Clinical Case Study 34.1 Answer

In the first analysis, serum amylase was tested on serum samples taken for blood sugar estimation. For blood sugar estimation, fluoride is added. Fluoride will activate amylase. Preanalytical errors are the most common cause of wrong laboratory results.

## QUICK LOOK OF CHAPTER 34

- Preanalytical variability may be due to a) pre-collection causes, or b) blood collection causes.
- Accuracy is the closeness of a result to the true value.
- Precision refers to the reproducibility of the result.
- Specificity of a reaction denotes that only one substance will answer that particular test.
- Sensitivity indicates that whether the method could be utilized to test a very dilute solution.

# CHAPTER 35

## General Techniques for Separation, Purification and Quantitation

### Chapter at a Glance

The reader will be able to answer questions on the following topics:

- Electrophoresis
- Adsorption chromatography
- Partition chromatography
- Ion exchange chromatography
- Gel filtration chromatography
- Radioimmuno assay (RIA)
- Enzyme-linked immunosorbent assay (ELISA)
- The pH meter
- Colorimeter
- Spectrophotometer
- Mass spectrometry
- Fluorescent activated cell sorter

### ELECTROPHORESIS

The term refers to the **movement of charged particles through an electrolyte when subjected to an electric field**. The positively charged particles (cations) move to cathode and negatively charged ones (anions) to anode. Since proteins exist as charged particles, this method is widely used for the separation of proteins in biological fluids. The technique was invented by Tiselius (Nobel Prize 1948).

### Factors Affecting Electrophoresis

The rate of migration (separation of particles) during electrophoresis will depend on the following factors:

1. Net charge on the particles (pI of proteins)
2. Mass and shape of the particles
3. The pH of the medium
4. Strength of electrical field
5. Properties of the supporting medium
6. Temperature.

### Electrophoresis Apparatus

The electrophoresis system basically consists of the electrophoresis tank to hold the buffer and fitted with the electrodes, as well as a power pack to supply electricity at constant current and voltage (Fig. 35.1).

When the electrophoresis is carried out, the buffer is chosen in such a way so as to ensure effective separation of the mixture of proteins, e.g. serum proteins are separated at a pH of 8.6 using barbitone buffer. At this pH all serum proteins will have a net negative charge and will migrate towards the anode.

## Support Medium for Electrophoresis

### Filter Paper

If the support medium is a filter paper, the electrophoresis is carried out for 16–18 hours at a low voltage. This long time interval and diffusion of particles leading to blurring of margins are the disadvantages of paper.

### Cellulose Acetate Membrane

Nowadays the preferred solid support media for horizontal electrophoresis is cellulose acetate membrane strips. They are expensive, but the process takes less than one hour and excellent separation without diffusion is achieved. Cellulose acetate strips are widely used for separation and identification of lipoproteins, iso-enzymes and hemoglobins.

### Agar or Agarose

These are less expensive than cellulose acetate. Both are heterogeneous polysaccharides. They are viscous liquids when hot but solidify to a gel on cooling. The gel is prepared in the buffer and spread over microscopic slides and allowed to cool. A small sample (few microliters) of serum or biological fluid is applied by cutting into the gel with a sharp edge. The electrophoretic run takes about 90 minutes. This technique is modified for immunoelectrophoresis which is described later. Agarose gel is used as support to separate different types of protein mixtures as well as nucleic acids.

### Polyacrylamide Gel Electrophoresis (PAGE)

It has a molecular sieving effect that makes separation very efficient. In agar gel electrophoresis, serum components are separated into 5



Arne Wilhelm  
Tiselius  
NP 1948  
1902–1971

Mikhail  
Semenovich  
Tswett  
1872–1919

Archer  
John Martin  
NP 1952  
1910–2002

Richard  
L Synge  
NP 1952  
1914–1994

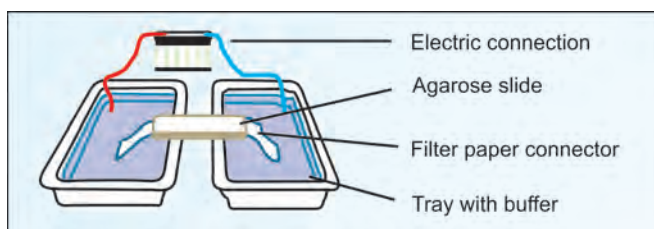


Fig. 35.1: Electrophoresis apparatus

fractions; while in PAGE serum will show more than 20 different bands. The amount of cross linking and thereby the pore size can be controlled.

Another common variant is the **SDS-PAGE** electrophoresis. Here proteins are boiled for 1–2 minutes with a denaturing agent, sodium dodecyl sulfate (SDS) (Fig. 35.2). The negative charges of SDS will cover the protein molecules, making them strongly negative. Then the separation of molecules will depend mainly on their molecular size. SDS-PAGE is therefore commonly used for molecular weight determination as well as for assessing the purity of proteins.

### Visualization of Protein Bands

After the electrophoretic run is completed, the proteins are fixed to the solid support using a fixative such as acetone or methanol. Then it is stained by using dyes (Amido Schwartz, naphthalene black, Ponceau S or Coomassie Blue) and then destained by using dilute acetic acid. The electrophoretogram can be scanned using a **densitometer** and each band quantitated. In the densitometer, light is passed through the agar gel plate; the absorption of light will be proportional to the quantity of protein present on a band. Another method is that the stain may be eluted from the support and each fraction quantitated colorimetrically. The electrophoretic pattern of serum proteins on agar gel are shown in Figure 35.3. Abnormal patterns are shown in Figures 28.1 and 28.2.

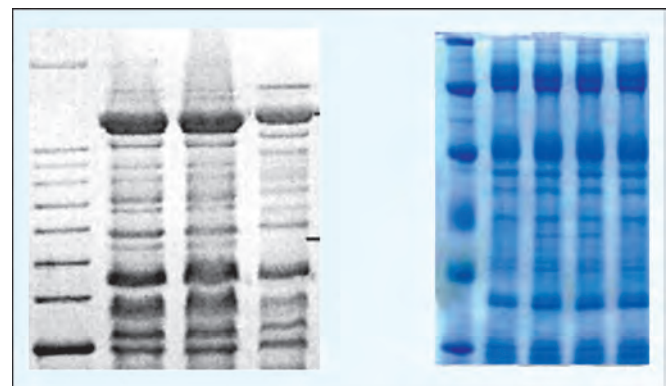


Fig. 35.2: Polyacrylamide gel electrophoresis

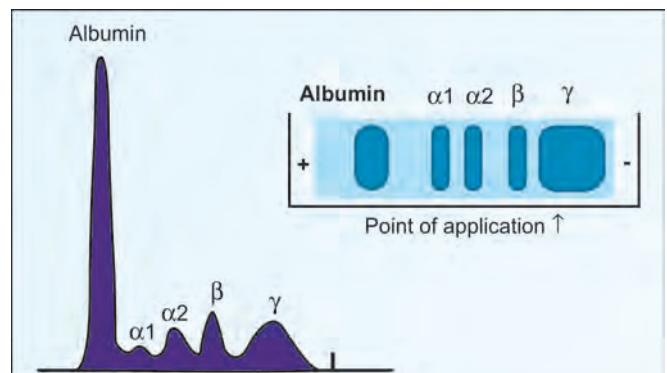


Fig. 35.3: Electrophoresis of normal serum sample



### Immuno-electrophoresis

Here electrophoretic separation is followed by an antigen-antibody reaction. The electrophoresis is carried out first by applying the patient's serum into the wells cut out in the agar or agarose gel. The proteins are now separated. To visualize them, a specific antibody is placed in a trough cut into the gel and incubated. The precipitation arcs are formed where the antigen and antibody molecules are at 1:1 ratio (Fig. 35.4). Serum is fractionated into more than 40 bands. So it is much more sensitive and specific than ordinary electrophoresis.

### High Voltage Electrophoresis (HVE)

Usually electrophoresis is carried out with an electric voltage of less than 250 volts and 1.5 – 2.5 mA current per slide. Since the separation of molecules depends on the strength of the current, recent trend is to utilize higher voltages (400 to 2000 volts). This is called high voltage electrophoresis (HVE). The advantage is that the result could be obtained within half an hour. It is now being widely used for separation of proteins, as well as nucleic acids from biological fluids.

### Capillary Electrophoresis (CE)

Here gel is taken in a capillary tube of small bore (50 to 100 microns) and having 100 to 200 cm in length. Nanoliter range of sample is injected into the tube. This is connected to buffer and a high voltage power supply of 25,000 volt is applied. Within a few minutes, components are separated. Amino acids, proteins, drugs, vitamins, carbohydrates and nucleotides could be separated by this method. Microchip electrophoresis applies the basic principle of capillary electrophoresis.

### Iso-electric Focusing (IEF)

In a column, polyacrylamide matrix is filled with ampholytes (substances carrying both positive and negative charges). Biological fluid containing proteins or nucleotides are applied. Electricity is passed. The particles migrate, and settle in the matrix where pH matches the iso-electric pH (net charge is zero) of the particle.

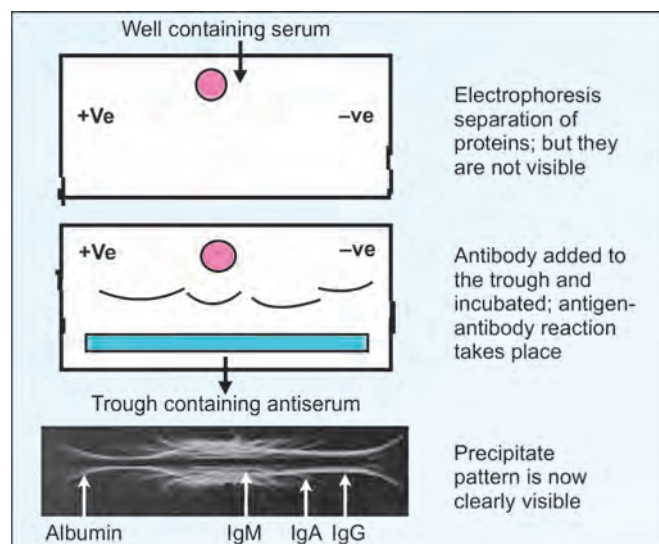


Fig. 35.4: Immuno-electrophoresis pattern

### Pulsed Field Gel Electrophoresis (PFGE)

In conventional gels, the current is applied in a single direction (from top to bottom). But in PFGE, the direction of the current is altered at regular intervals. Power is alternately applied to two different pairs of electrodes or electrode arrays. The electrical field is cycled between two directions. The frequency of field alterations separates large molecules like DNA with more than 50 kBp size to 400 kBp using appropriate pore size gels.

### Two-dimensional Electrophoresis

Used to study differences in protein content of cells in genetic disorders. The technique can also be used to study mutant DNA. Electrophoresis is done in the first direction based on the charge. Second dimension electrophoresis is based on molecular weight. The detection of the separated proteins may be done either by autoradiography or Coomassie Blue stain.

### Ultracentrifugation

This technique was developed by Svedberg (Nobel prize, 1926). Large molecules can be sedimented at high centrifugal forces whereas small molecules cannot. The force in ultracentrifuges can go up to  $10^5 \times g$ . The centrifugation at such high speed is carried out in a vacuum to eliminate air friction. The rate of sedimentation is a function of the size and shape of the molecule and is a constant for a particular molecule. It also depends on the difference in the density of solute particles and the solvent. When solute particles are lighter than the solvent, they would float and vice versa. In **density gradient centrifugation**, the sample is layered over a linear sucrose gradient (5–20%) and centrifuged at a high speed. Sedimentation constant is expressed in **Svedberg (S) units**. Substances with different S units will separate from one another as separate bands. The sedimentation constants can be determined by using suitable standards. Ultracentrifugation is also used for preparative separation of biological molecules. See Chapter 13 for ultracentrifugation of lipoproteins.

## CHROMATOGRAPHY

The term is derived from the Greek word "chroma", meaning color. The method was first employed by Tswett, a botanist in 1903, for the separation of plant pigments using a column of alumina. Nowadays HPLC is used to separate almost all biological substances, including proteins, carbohydrates, lipids and nucleic acids.

### Adsorption Chromatography

In this technique the separation is based on differences in adsorption at the surface of a solid stationary medium. The common adsorbing substances used are alumina, silicates or silica gel. These are packed into columns and the mixture of proteins to be separated is applied in a solvent on the top of the column. The components get adsorbed on the column of adsorbent with different affinity. The fractions slowly move down; the most weakly held fraction moves fastest; followed by others, according to the order of tightness in adsorption. The eluent from the

column is collected as small equal fractions and the concentration of each is measured, in each fraction (Fig. 35.5A).

## Partition Chromatography

This technique was developed by Martin and Synge in 1941 (Nobel prize, 1952). This includes different types depending on the phases between which the components are partitioned, e.g. solid-liquid, liquid-liquid, gas-liquid, etc. This is commonly used for the separation of mixtures of amino acids and peptides. There is a **stationary phase** which may be either solid or liquid over which a liquid or gaseous mobile phase moves. By this process, the components of the mixture to be separated are partitioned between the two phases depending on the **partition co-efficient** (solubility) of the particular substances. The redistribution of the substances between the two phases results in separation of the components of the mixture.

### Paper Chromatography

The **stationary phase** is water held on a solid support of filter paper (cellulose) (Fig. 35.5B). The **mobile phase** is a mixture of immiscible solvents which are mixtures of water, a nonpolar solvent and an acid or base, e.g. Butanol-acetic acid-water, Phenol-water-ammonia. Either ascending or descending type of chromatography can be done with the mobile phase being applied from the bottom (**ascending**) or at the top (**descending**). A few microliters of the mixture of compounds to be separated is applied as a small compact spot at one corner of the paper about 1 inch from the edges. In ascending chromatography, the paper is placed in a glass trough containing the solvent which ascends up the solid support medium. The components of the mixture to be separated are carried up with the solvent. The distance to which each compound moves depends on its partition co-efficient.

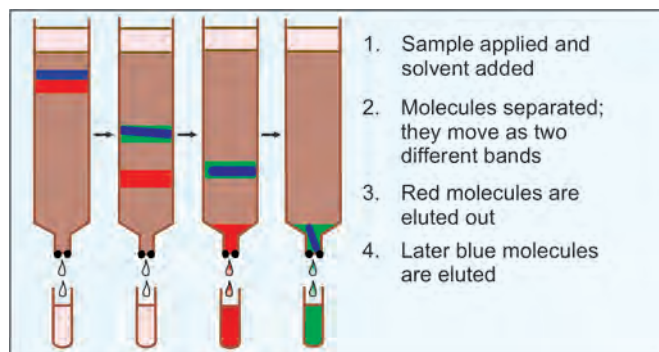


Fig. 35.5A: Adsorption chromatography

### Thin Layer Chromatography (TLC)

This is another version of liquid-liquid chromatography. A thin layer of silica gel (Kieselguhr) is spread on a glass plate; biological sample is applied as a small spot; the plate is placed in a trough containing the solvent. The stationary water phase is held on the silica gel and mobile phase of non-polar solvent moves up. In the case of paper chromatography, it takes 14–16 hours for separation of components to be separated. But in the case of TLC it takes only 2–4 hours. That is a distinct advantage for TLC. TLC can be performed as two-dimensional (Fig. 35.6A).

### Visualization of Chromatography

After the chromatographic run is over, the paper or plate has dried, it is sprayed with a location reagent. The components of the mixture would appear as discrete spots. Some common **location reagents** used are: Ninhydrin for amino acids and proteins, sulfuric acid for phospholipids; diphenylamine for sugars.

### Importance of R<sub>f</sub> Value

The spots may be identified by the R<sub>f</sub> value of the unknown substance and comparing with those of pure standards. (R<sub>f</sub> = ratio of fronts). The R<sub>f</sub> value is the **ratio of the distance travelled by the substance (solute) to the distance travelled by the solvent**. The R<sub>f</sub> value is a constant for a particular solvent system at a given temperature. Chromatogram of all the 20 amino acids is shown in Figure 35.6B.

### Gas-Liquid Chromatography (GLC)

This is another type of partition chromatography where the stationary phase is a liquid and the mobile phase is gas. The stationary liquid phase is supported by a column of inert material such as silica in a long narrow column. The mixture of substances to be separated is made volatile at one end of the column and the vapors are swept over the column by an



Fig. 35.5B: Paper chromatography

Theodor Svedberg  
NP 1926, 1884–1971

inert carrier gas like argon or nitrogen. The fractions emerging from the column are detected and quantitated by a detecting device. This is more

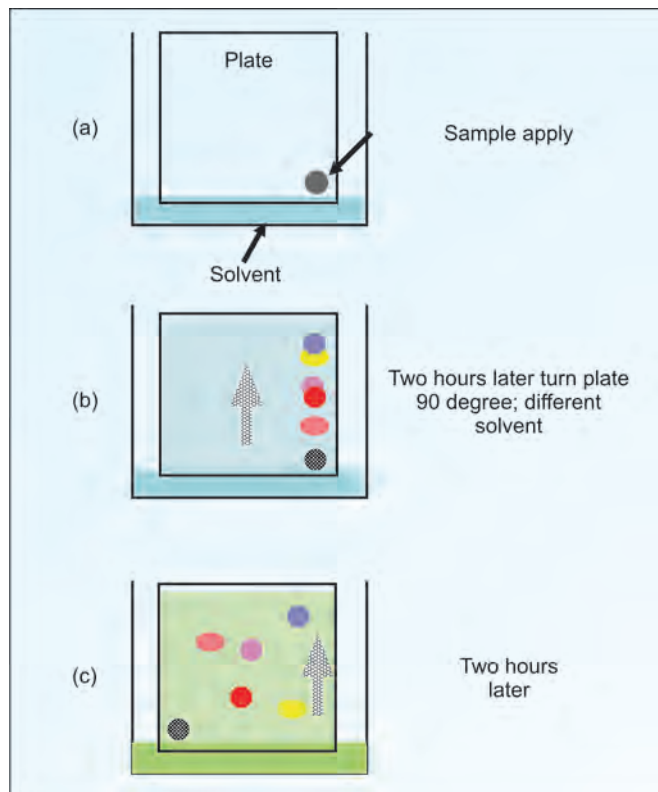


Fig. 35.6A: Thin layer chromatography (two-dimensional)

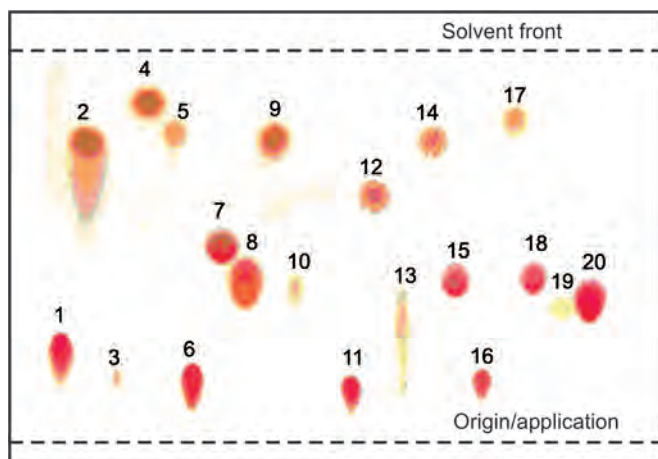


Fig. 35.6B: TLC separation of amino acids on Silica gel

1. Arginine; 2. Methionine; 3. Cystine; 4. Leucine; 5. Tyrosine; 6. Lysine; 7. Alanine; 8. Glycine; 9. Phenylalanine; 10. Aspartic acid; 11. Ornithine; 12. Valine; 13. Cysteine; 14. Isoleucine; 15. Threonine; 16. Histidine; 17. Tryptophan; 18. Glutamic acid; 19. Proline; 20. Serine

suitable for compounds (e.g. lipids) which resist degradation at high temperature (Fig. 37.7).

### Gel Filtration (Size Exclusion) Chromatography

It is also called molecular sieving. Hydrophilic cross linked gels like acrylamide (Sephacryl), agarose (Sephacryl) and dextran (Sephadex) are used for separation of molecules based on their size. Sephadex is widely used and the range of separation is based on pore size designated by the symbols G-10 to G-200. The gel is packed in a column. The gel particles are porous in nature. These pores will allow small molecules (e.g. insulin, molecular weight, 5700 D) enter into the gel. But larger molecules (e.g. immunoglobulin, molecular weight, 150,000 D) could not enter into pores of the gel and so are excluded. Suppose a mixture of insulin plus immunoglobulin is passed through the column. The small molecules can enter the gel particles, then come out, re-enter into another particle. Thus, insulin has to travel a long distance inside the gels. Small molecules are held back. But the large immunoglobulin molecules cannot enter the pores and sidetrack the gel particles; so they move in the column rapidly (Fig. 35.8). In short, **larger molecules will come out first, while smaller molecules are retained in the column**. The gel filtration technique is used for (a) separation of protein molecules; (b) purification of proteins; and (c) molecular weight determination.

### High Pressure Liquid Chromatography (HPLC)

It is now widely used for the separation of all types of compounds. Incompressible silica or alumina microbeads are used as the stationary phase. This allows high flow rates. The liquid phase passes through this column under high pressure (1000 times atmospheric pressure). The column may be packed with materials for adsorption, partition or ion exchange. The method is therefore based on the same principle as for those types already described, but separation is achieved with better resolution and high speed (within minutes) (Fig. 35.9). HPLC can resolve mixtures of lipids whose solubility differ only slightly. In **reversed phase HPLC**, hydrophobic polymers are used as stationary phase; this is generally used to separate peptides.

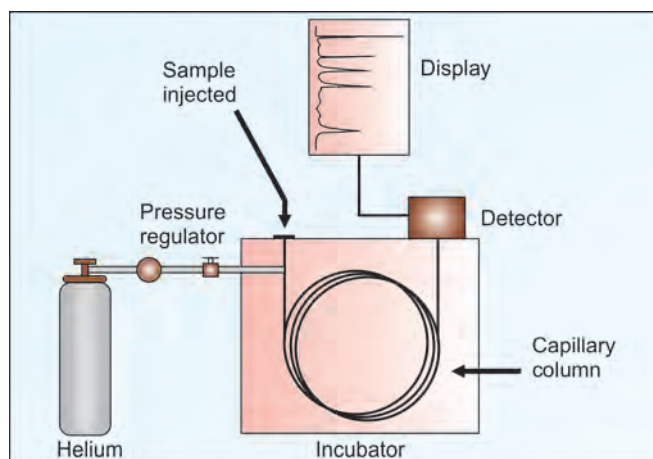
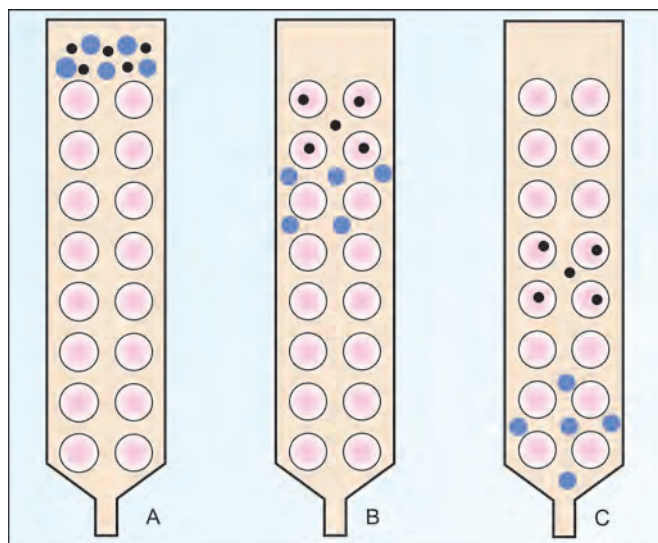


Fig. 35.7: Gas liquid chromatography



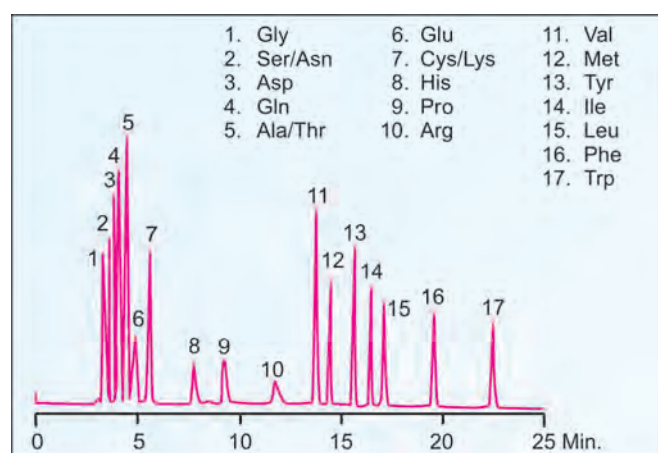
## Ion Exchange Chromatography

In this method, the separation is based on **electrostatic attraction** between charged biological molecules to oppositely charged groups on the ion exchange resins (Fig. 35.10). These resins are cross linked polymers containing ionic groups as part of their structure. The polymer must be sufficiently cross linked to have negligible solubility, but porous enough for the ions to diffuse freely through it.



**Fig. 35.8:** Sephadex (gel filtration) chromatography

A = protein solution is added on the top of the column; B = small proteins get inside the beads, and so takes a longer time to reach the bottom; C = larger molecules cannot enter into the beads, so travels quickly, and reaches the bottom faster



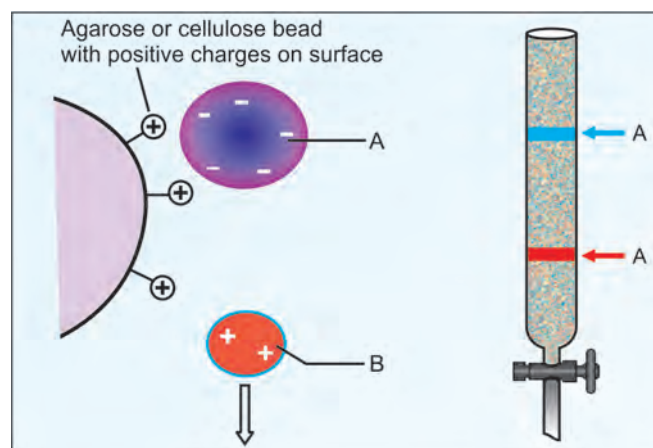
**Fig. 35.9:** Amino acid profile in HPLC

1. Gly = glycine; 2. Ser/Asn = serine/asparagine; 3. Asp = aspartic acid; 4. Gln = glutamine; 5. Ala/Thr = alanine/threonine; 6. Glu = glutamic acid; 7. Cys/Lys = cysteine/lysine; 8. His = histidine; 9. Pro = proline; 10. Arg = arginine; 11. Val = Valine; 12. Met = methionine; 13. Tyr = tyrosine; 14. Ile = isoleucine; 15. Leu = leucine; 16. Phe = phenylalanine; 17. Trp = tryptophan

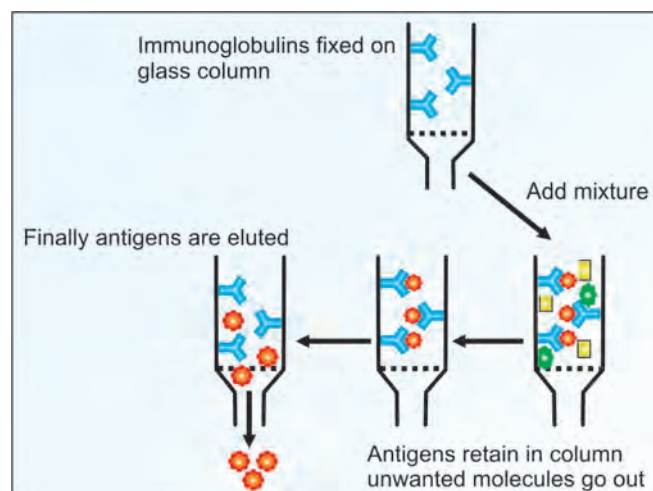
The resins are either cation exchange resins or anion exchange resins. The ionic groups in cation exchange resins are sulfonic and carboxylic groups, whereas anion exchange resins have a quaternary nitrogen ( $N^+$ ), e.g. Amberlite IRC-50 (weak cation); Dowex-3 (weak anion); and DEAE-Cellulose (strong anion). The separation is based on the ionic character of proteins and amino acids (iso-electric point). The **cation exchange** particles carry acid groups, e.g.  $COO^-Na^+$ . When cations ( $C^+$ ) are passed through the column,  $Na^+$  in the resin is replaced by  $C^+$ ; thus  $C^+$  particles are adhered in the column, while negatively charged particles are eluted out easily (Fig. 35.10).

## Affinity Chromatography

The technique is based on the high affinity of specific proteins for specific chemical groups. Thus co-enzymes can be used to purify enzymes. For example, NAD is used to purify dehydrogenases. By using antibodies, antigens could be easily separated (Fig. 35.11). Conversely, antibodies can be purified by passing through a column containing the antigen.



**Fig. 35.10:** Ion-exchange chromatography; A = negatively charged molecules attach with the beads and so move slowly; B = positively charged molecules repel with the beads, so move faster in the column



**Fig. 35.11:** Affinity chromatography



## RADIOIMMUNOASSAY (RIA)

The technique of RIA was developed by Rosalyn Yalow (Nobel prize, 1977). Insulin was the first substance thus quantitated by RIA. Nowadays, Hormones, growth factors, tumor markers, cytokines, bacterial antigens, and any other biological substances could be quantitated accurately by the RIA method. The specificity of antibody and the sensitivity of radioactivity are combined in this technique.

Suppose, blood level of thyroxin (T4) is to be assayed. The T4 hormone is the antigen (Ag) in this case. It is made to react with a specific antibody (Ab). A constant amount of isotope-labeled hormone, constant amount of antibody and variable quantities of unlabeled hormone are taken in different tubes (Table 35.1 and Fig. 35.12).

In tube A, the labeled hormone molecules are combined with the antibody molecule; so there is no radioactivity in the supernatant. In B, equal quantity of unlabeled hormone is added, when labeled and unlabeled antigen molecules compete for the antibody. Thus half of radioactivity is in the supernatant and half in the precipitate. The **displacement of labeled antigen is proportional to the unlabeled antigen** in the system (Table 35.1).

A series of test tubes are taken, in which constant quantity of antibody, constant quantity of labeled antigen

and different but known quantities of unlabeled antigen are added. After a few hours of incubation, a precipitating agent is added, when antigen-antibody complex, being high molecular weight substance, is precipitated. The **radioactivity in the precipitate is inversely related to the unlabeled antigen added**. The values of the radioactivity in the precipitate (last column) are shown as a graph in Figure 35.13. In the same series of test tubes, patient's serum may be added as the source for unlabeled hormone. The radioactivity in the precipitate is plotted in this graph at the Y-axis, when the corresponding value in the X-axis will give the actual quantity of hormone present in that sample. There is a competition between the unlabeled hormone (antigen) present in the biological specimens and the added labeled antigen to combine with the antibody (Fig. 35.12). The more the unlabeled antigen, less of the labeled antigen will combine with the antibody (Fig. 35.12 and Table 35.1). The antigen-antibody reaction is allowed to take place for a definite period of time. At the end of the incubation period, the tube will contain free and bound antigen (labeled or unlabeled), as shown in Box. 35.1.

The bound and free forms are separated by protein precipitating agents such as polyethylene glycol or a second antibody. The radioactivity of the bound form in the precipitate is measured.

Tube No.	No. of molecules of antibody	No. of molecules of labeled hormone	No. of molecules of unlabeled hormone added (X-axis in Fig. 35.13)	Labeled molecules in supernatant activity	Radio-activity in precipitate (Y-axis in Fig. 35.13)
1	2	3	4	5	6
1	100	100	0	0	100
2	100	100	100	50	50
3	100	100	300	75	25
4	100	100	900	90	10
5	100	100	Patient's serum	A	Z

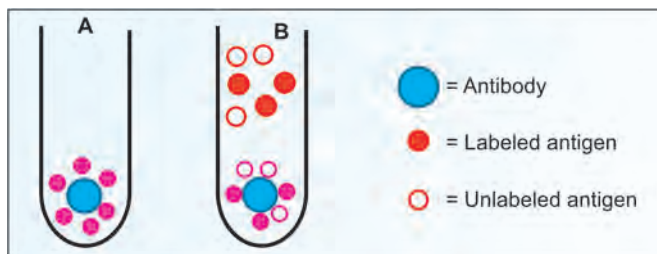


Fig. 35.12: Principle of radioimmunoassay (RIA)

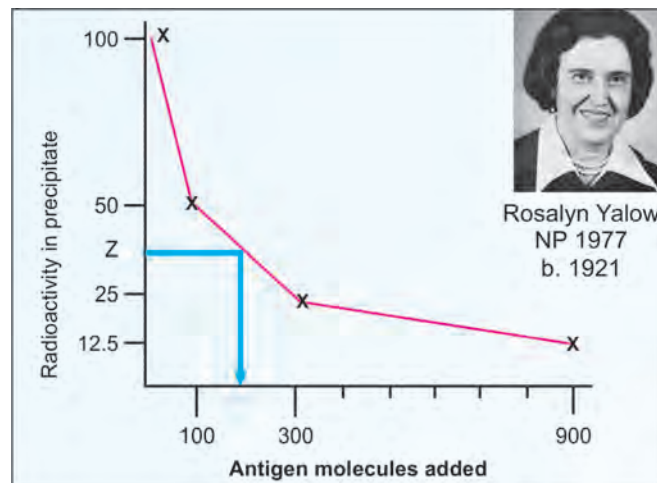
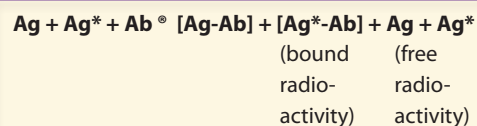


Fig. 35.13: The figures in the 4th column of Table 35.1 is shown in X-axis and figures in the 6th column in the Y-axis. From this calibration curve, the value of Z is extrapolated to X-axis, when the hormone in the patient's serum is quantitated

### Box 35.1: Principle of radioimmunoassay



A series of standard tubes containing known but varying concentration of the pure antigen are taken along with the unknown biological specimen. The level of the hormone in the specimen can be obtained from a calibration curve prepared from the measured radioactivity of the known standards (Fig. 35.13).

### Solid Phase RIA

The antibody is fixed on the walls of the test tube, so that separation of bound and free radioactivity becomes practically easier.

### Radiometric Assay

The antibody (instead of the antigen) is tagged with radioactivity.

### Advantage of RIA

By this method, microgram and picogram quantities of substances could be analyzed. The radioisotope commonly used for labeling the antigen is  $^{125}\text{I}$  (radioactive iodine).

### Disadvantages of RIA

Since radioisotopes are used, there are stringent laws; and only approved laboratories could take up the assay. Half-life of  $^{125}\text{I}$  isotope is about 60 days; iodinated antigen should be used within few months. The shelf-life of the reagent is short.

### Nonisotopic Immunoassays

They have the **advantage** that there is no radiation hazard. So the test could be done in any clinical laboratory. The shelf-life is also more. The ELISA technique is more simple and less time consuming than RIA. Instead of the radio label, an enzyme is tagged. The antibody is usually conjugated with the enzyme. The enzyme labels commonly used are alkaline phosphatase (ALP) and **horse radish peroxidase** (HRP).

## ELISA TEST

ELISA is the abbreviation for **enzyme-linked immunosorbent assay**. The ELISA techniques are widely used not only for hormone measurements but also for detecting any other growth factors, tumor markers, bacterial or viral antigens, antibodies against microbes and any other antigens or antibodies in biological fluids. This test is commonly employed to detect antigens or antibodies present in very small quantities in tissues or blood.

### Antibody Detection by ELISA

This is useful to detect small quantities of antibodies in the blood. A good example is the test for **detection of HIV**

**antibody**. In patients with AIDS, the human immunodeficiency virus (HIV) produces specific antibody. To detect the HIV antibody, the following method is used.

Antigen from HIV is coated in the wells of a multiwell (microtitre) plate. Patient's serum is added, and incubated. If it contains the antibody, it is fixed. The wells are washed. This is to remove excess antibodies in serum.

Next a second antibody (antibody against human immunoglobulin) conjugated with HRP is added. Then a color reagent, containing hydrogen peroxide and diaminobenzidine (as described below, under antigen detection) is poured over. If a brown color develops, it means that the antibody was originally present in the patient's serum (Fig. 35.14). Here the **color developed is proportional to the antibody concentration**. Therefore, from the color intensity, the concentration of the antibody can be calculated. HIV antibody is an example, any antibody could be detected by using the specific antigen.

### Antigen Detection by ELISA Method

At first, specific antibody is fixed to the well of a microtiter plate. A good example is the assay of thyroid hormone, T4. The patient's serum is added in the well, and incubated for 30 minutes at  $37^\circ\text{C}$ . By this time, antigen (T4 in this example) present in the serum is fixed on the antibody. Excess antigen and other unwanted proteins are washed out.

Then, specific antibody (antibody against T4, tagged with enzyme (horse radish peroxidase) (HRP) is added. If the antigen is already fixed, the antibody-HRP-conjugate will be fixed in the well. Then a color reagent, containing hydrogen peroxide ( $\text{H}_2\text{O}_2$ ) and diaminobenzidine (DAB) are added. The reaction is as follows:

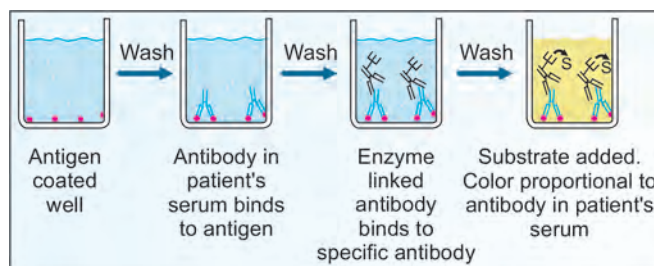
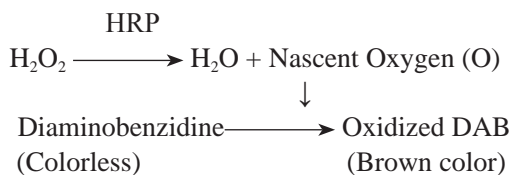


Fig. 35.14: Indirect ELISA to detect antibody

This is known as "sandwich" ELISA. Development of a brown color indicates that the antigen is originally present in the patient's serum. This is diagrammatically represented in Figures 35.15 A and B. **Color developed is proportional to the antigen in the serum.** Therefore, intensity of the color may be measured, from which the concentration of the antigen is calculated.

Other chromogens used may be NBT (nitroblue tetrazolium) which produces a blue color (Fig. 35.16A). When Alkaline phosphatase is the enzyme label used, PNPP (paranitrophenyl phosphate) is used

as chromogen (yellow color). Instead of enzyme labels, Fluorescent immunoassay (FIA) or Chemiluminiscent Immunoassay (CLIA) labels may also be used (See luminescence in the next page).

### Immunofluorescence

Antibody tagged with fluorescein isothiocyanate is incubated with cells. Antibody fixes with cell surface antigens. Subpopulations of blood cells (e.g. helper T cells) are usually enumerated by this technique (Fig. 35.16B).

### Immunocytochemistry

Histopathology sections may be layered with antibody tagged with Horse radish peroxidase, and then hydrogen peroxide and chromogen are added; color is thus produced. For example, a slide from colon cancer is reacted with specific antibody against an oncogene. Color is developed wherever the oncogene is present (Fig. 35.17).

### Biotin-Avidin Complex

Biotin will tightly bind with avidin (see Chapter 37). Instead of enzyme directly fixed over the antibody; biotin is labeled on the first antibody. Then avidin-conjugated enzyme is added, and color reaction is done as before. The advantage here is that for each biotin fixed, 4 avidin molecules, and so 4 enzyme molecules are fixed. Thus intensity of color will be 4 times more intense. The sensitivity of the assay is thus increased many times.

### Enzyme Multiplied Immunoassay Technique (EMIT)

In ELISA, antibody is tagged with enzyme; but in EMIT, antigen is labeled with enzyme. Serum containing the antigen and antibody are reacted.

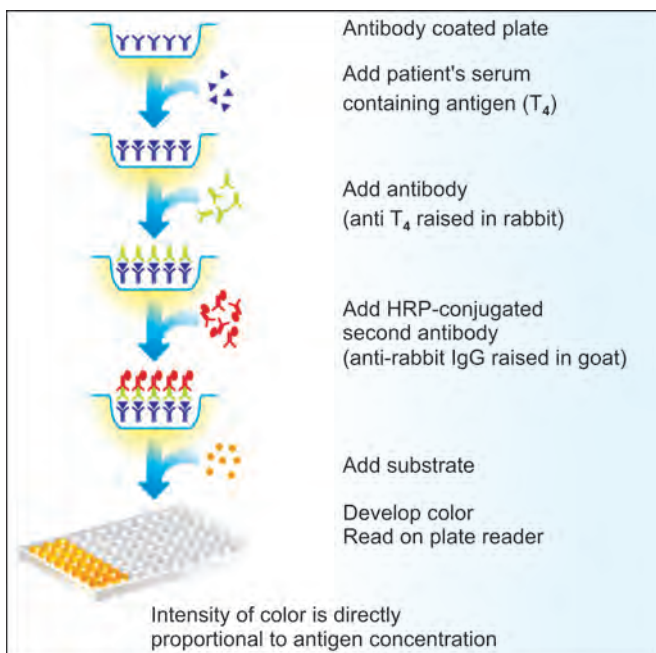


Fig. 35.15A: Sandwich ELISA to detect antigen

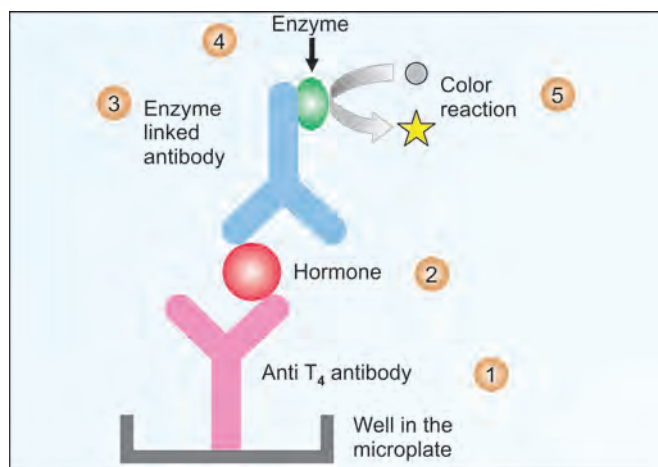
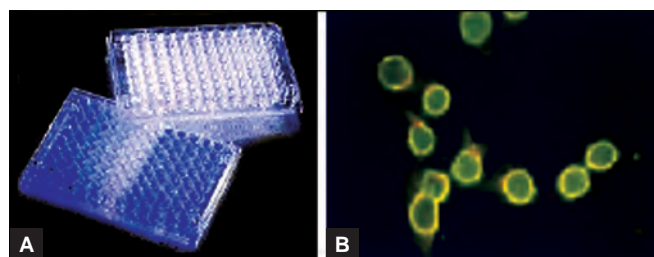


Fig. 35.15B: Antigen detection by ELISA; 5 sequential steps explained



Figs 35.16A and B: (A) Elisa microplates; (B) Immunofluorescence

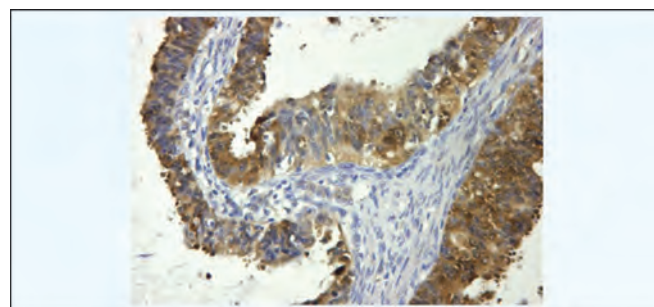


Fig. 35.17: Immunohistochemistry



When antigen-antibody complex is formed, the active site of enzyme is not available for substrate binding. Such a system will eliminate the separation of antigen-antibody complex, or the washing procedure. This is a definite advantage of EMIT over RIA and ELISA techniques. So EMIT is more suitable for automated machines.

## Luminiscence

Chemiluminescence, bioluminescence and electroluminescence are the types of luminiscences where the excitation caused by chemical, biological or electrical reaction respectively. In luminiscence, the light emission occurs from an excited singlet state and the light emitted when the electron returns to the ground state (higher energy to lower energy level). The excitation event is caused by a chemical reaction like oxidation of luminal, acridine esters or luciferin by an oxidant. Light is emitted from the excited product formed in the oxidation reaction. These reactions occur in presence of catalysts, commonly used ones are ALP, HRP, metal ions and complexes (copper and iron phthalocyanine complex).

**Bioluminescence** is a biological reaction, luciferase being a common biocatalyst used for increasing the efficiency of the reaction. CLIA (**chemiluminescent immunoassay**) is a very sensitive method and has a sensitivity of femtograms detection. Labels used may be acridium ester, ALP labels (1,2 dioxane) and HRP labels (luminol). **Electroluminescence** is generated from stable precursors at the surface of an electrode; ruthenium tris chelate can be used to label haptens or large molecules like proteins.

## COLORIMETER

Colored solutions have the property of absorbing light of definite wavelengths. The amount of light absorbed or transmitted by a colored solution is in accordance with the Beer-Lambert law. As per the **Beer's law**, the intensity of the color is directly proportional to the concentration of the colored particles in the solution. The **Lambert's law** states that the amount of light absorbed by a colored solution depends on the length of the column or the depth of the liquid through which light passes. The **Beer-Lambert law** combines these two laws.



Johann Lambert  
1770  
1728–1777



August Beer  
1852  
1825–1863

In the colorimeter, the length of the column through which the light passed is kept constant, by using test tubes or cuvettes of the same diameter for both test and standard, so that the only variable is the concentration.

The ratio of intensity of emergent light to intensity of incident light ( $E/i$ ) is termed as **transmittance** ( $T$ ). The absorbance is expressed as  $-\log T$ . The **Optical Density** is calculated as  $-\log T$ . The plot of the concentration versus transmittance is not linear, but a graph of the concentration against absorbance (OD) is linear. Since it is in logarithmic scale, values too low or too high are not acceptable for accurate results (sensitive range is between 0.1 to 0.6). The method of estimation is arranged to give readings within this sensitive range.

Most of the clinical chemistry estimations are done by colorimetric methods. A colored derivative of the compound to be measured is prepared and its absorbance or OD is measured using a photoelectric colorimeter. This value is compared with that of a **standard** of known concentration. The basic components of a **photoelectric colorimeter** are :

1. Light source, usually a filament lamp
2. Filter, used for selecting the monochromatic light (*mono* = single; *chrome* = color). Filters will absorb light of unwanted wavelength and allow only monochromatic light to pass through. This light will have maximum absorbance when passed through a particular colored solution. The color of filter should be complementary to the color of the solution. Table 35.2 gives the color of filters to be used for the colors of solutions

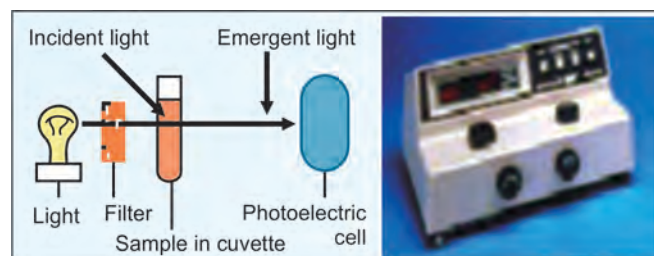


Fig. 35.18: Photoelectric colorimeter

**TABLE 35.2:** Color of filter and color of solution are complementary

Color of filter	Wavelength	Color of solution
Violet	420	Brown
Blue	470	Yellowish brown
Green	520	Pink
Yellow	580	Purple
Red	680	Green/blue



3. Sample holder, called "cuvette", made up of glass tubes
4. Detector (photocell)
5. Display as a digital meter (Fig. 35.18).

The monochromatic light is allowed to fall on the colored solution. The solution is taken in the cuvettes of fixed diameter to keep the path length common to the test as well as to the standard. The solution absorbs part of the light and the remaining transmitted light is allowed to fall on the photocells. The electrical impulse thus generated is measured and is suitably displayed.

In clinical laboratory, serum sample and reagents are mixed and incubated at 37°C for a fixed time, say 10 minutes, to develop the color optimally. After the incubation period, the OD is ascertained and the concentration of the substances is calculated. This is called **end point analysis**.

On the other hand, the serum and reagents are incubated, and readings are taken at 2 and 3 minutes exactly; and from the difference in OD between the two values, the concentration is calculated. This is the **kinetic analysis**. Here the optimum color is not developed; but is quicker and hence is often used in autoanalyzers.

### Spectrophotometer

A spectrophotometer has all the basic components of photoelectric colorimeter with more sophistication (Fig. 35.19). Wavelengths in the ultraviolet region are also utilized in the spectrophotometer. Light is separated into a continuous spectrum of wavelengths and passed through the solution. [In colorimeter, wavelengths of one color are grouped together.] **Wavelength selection** is achieved by diffraction gratings. The UV light is partially absorbed by the glass, and hence quartz cuvettes are used for the UV range.

The **advantage** of the spectrophotometer over the colorimeter, is that the former is 1000 times more **sensitive**. Therefore, even minute quantities of the substance (very dilute solution) can be assessed in the spectrophotometer. To take an example, protein solutions with high concentration (mg/mL) may be measured by colorimeter. If the protein concentration is only  $\mu\text{g/dL}$ , then colorimeter is ineffective, where spectrophotometer can be used.



Fig. 35.19: Spectrophotometer

However, spectrophotometer is 100 times more costly than an ordinary colorimeter. Further, the electrical power source operating the light must be carefully stabilized. Light emitted is proportional to the 8th power of the voltage. Therefore, even minor fluctuation in the voltage will have an exaggerated effect.

The characteristic absorption maximum (in wavelength) of some important substances are; protein, peptide linkage (220 nm); protein, tryptophan units (280 nm); nucleic acids (260 nm); deoxyhemoglobin (565 nm); bilirubin (450 nm); NADH (340 nm); FAD (450 nm); FADH<sub>2</sub> (570 nm); porphyrin (400 nm).

### Optical Chemical Sensors

An optical sensor is referred to as an optode. It is used in instruments measuring blood gases and electrolyte. Compared to conventional electrodes, optodes have certain advantages like miniaturization, long-term stability and does not need a reference electrode. In the optical sensors, the light from the sensing side can be brought to light sources, filters and detectors that can monitor absorbance by reflectance, fluorescence or phosphorescence.

The optical sensors used for pO<sub>2</sub> measurements work on the principle of quenching of fluorescence or phosphorescence emitted at a particular wavelength by oxygen.

### Biosensors

These are chemical sensors having an optical device or transducer and a biological recognition element. The concentration of the analyte is recognized by an enzyme based biosensor (catalytic reaction) or an affinity based sensor (binding specificity). When the recognition element interacts with the analyte, there is product formation or reactant consumption on the surface of the sensor. This change in property is converted by a transducer to an electrical signal and quantified.

Enzyme based biosensors are used in different analyzers for quantification of glucose (pO<sub>2</sub> electrode), urea, creatinine, etc. where the enzyme is immobilized on the sensor. Affinity sensors have immobilized molecules with specific high affinity binding properties like binding proteins, antibodies, aptamers (DNA sensors), etc. In vivo miniaturized sensors are being developed for measurement of SaO<sub>2</sub>, pH, etc. Implantable subcutaneous glucose sensors are also being used to adjust the dose of insulin. Intravascular sensors that release nitric oxide have been developed to decrease the possibility of thrombosis.

### Flame Photometer

This is an analytical instrument used for quantitative analysis of **sodium, potassium, calcium and lithium** in biological fluids like blood, serum and urine.

In a colorimeter the optical absorption property is employed, while in a flame photometer the property of **emission spectroscopy** is utilized. Sodium, potassium, calcium and lithium have the property of emitting a light of the characteristic wavelength of that particular element, when sprayed into a flame (incandescence).

The equipment consists of an atomizer, which draws sample solution; and a compressor which pumps air at high pressure. It is fed into a flame. The flame will be blue, if the sample contains only distilled water. When the serum sample is introduced, the flame acquires the color. The emitted light is focussed on to the photosensor. The electric charge given out by

the photosensor is detected, amplified and displayed. It has to be compared with a standard solution containing sodium/potassium (Fig. 35.20).

### Ion-selective Electrodes

Nowadays, more sensitive but costly equipments, using ion-selective electrodes are available to detect sodium, potassium, calcium and lithium. Glass electrode, made up of very thin glass membrane, allows ions to permeate through. The potential difference across the glass membrane of the electrode is quantitated by the instrument.

### The pH Meter

The hydrogen ion concentration and pH are described in Chapter 29.  $\text{pH} = -\log [\text{H}^+]$ . pH is measured accurately by potentiometric methods. An electrode potential is generated across a selectively permeable membrane separating two different concentrations of an ion. A second electrode is required to act as the reference. The active electrode will be sensitive to the ion being measured; while the reference electrode will be insensitive to that ion.

The **Glass electrode** is made of a very thin glass membrane, which allows passage of hydrogen ions. Inside the bulb of the glass electrode, a solution of known hydrogen ion concentration is kept and a silver-silver chloride electrode connects the solution to the input part of the instrument. The reference electrode or **calomel electrode** (mercury with mercurous chloride) is filled with KCl solution. In the equipment, the test and the reference electrodes are made physically together for easy handling (Fig. 35.21). Glass electrodes require very delicate handling. When not in use, the electrodes must be kept immersed in distilled water.

The potential difference across the glass membrane (inside and outside) is calculated by Nernst (Nobel prize, 1920), the equation being  $\frac{RT}{nF} \times 2.3 \log \left\{ \frac{[\text{H}^+]_i}{[\text{H}^+]_o} \right\}$  where R= gas constant; T= absolute temperature, n=valency, F= Faraday,  $[\text{H}^+]_i$  = concentration of hydrogen ions inside the cell and  $[\text{H}^+]_o$  = concentration outside, that of the unknown solution.

### AUTOANALYZER

By means of this modern equipment, hundreds of blood samples could be analyzed within a short time.

### Continuous Flow Analysis

In these instruments, samples, reagents and diluents are pumped through different tubings. Samples are introduced in a sequential manner,

through the network with air bubbles at regular intervals which mix the reagents with the sample. The continuous flow systems, despite being the forerunner, have now fallen out of favor due to the high cost for maintenance.

### Automated Photometric Analyzers

These are semi-automated analyzers. Some of the steps involving pipetting of the sample, reagent mixing and incubation are manually done, while aspiration of the colored solution into the photometer as well as measurement, calculation and display or printing of the results are automatically done. The instrument is meant for parameter oriented analysis. It can analyze only one parameter at a time (e.g. urea), but as many samples can be measured at a rapid rate.

### Discrete Analyzers

These may be either batch analyzers or selective multichannel analyzers.

### Batch Analyzers

Here all samples are analyzed for one constituent only and analysis is parameter oriented. Once samples are loaded, all processes are performed automatically with little manual intervention.

### Discrete Selective Analyzers

They are the most sophisticated systems, that have the capability of analyzing simultaneously 40 or even more parameters in a single sample. It is therefore called sample oriented. But at the same time, it offers the freedom to the operator to select any number of analyzes on a sample.

### Dry Chemistry Systems

Here all the reagents necessary for the reaction are embedded on a plastic matrix in their dry state, thus obviating the need to prepare reagent solutions. The reaction is initiated by the addition of the sample over the matrix and the color that is produced by the reaction is measured by **reflectance spectrophotometry**. Introduction of such system is bound to have a significant impact on the emergency practice of critical care medicine or point of care tests.

**Glucometers** are working on this dry chemistry principle (Fig. 35.22). Glucometers are usually used by the diabetic patients for blood glucose analysis at their home. Introduction of such systems have made an impact on emergency analysis in critical care units. Several assays have



Fig. 35.20: Flame photometer



Fig. 35.21: pH meter



Walther Nernst, NP 1920  
1864–1941

now been adapted for Point of Care tests (POCT). These tests can be done by the attending physicians at the bedside for quick results. For example, Glucometer used for self-monitoring of blood glucose (SMBG) and Troponin cards used for troponin tests.

## MASS SPECTROMETRY

Mass spectrometry (MS) is a very sensitive quantitative analytical technique used to measure a wide range of clinically relevant analytes. MS identifies molecules based on their mass or molecular size. MS measures the mass of a molecule or its fragments after ionization according to mass to charge ratios. Relative abundance of each ion is a function of its mass to charge ratio. When interfaced to HPLC or GLC, the MS functions as a powerful detector.

A sample is vaporized such that positive charge is produced on the molecule. Electrical field is applied, so that particles move. At the same time, a magnetic field is applied, so the cations are deflected at right angle to their original direction, and hit on the detector. For molecules of identical charge, the time required for the molecule to reach the detector is inversely proportional to the mass of the molecule. Conventional MS identifies molecules of 4000 D or less. For higher molecular size materials, **time-of-flight mass spectrometers** are useful (Fig. 35.23A).

For analysis in MS, the sample has to be vaporized first. Small biological molecules could be vaporized by heating in a vacuum. But complex molecules, such as proteins, nucleotides, etc. are destroyed by this procedure. So such molecules are vaporized by **electrospray ionization (ESI)**. Here the molecules are dissolved in a volatile solvent, sprayed as a small jet stream into a capillary chamber, so that molecules are suspended in the gaseous phase, and are ionized.

Recently introduced method of dispersion of molecules in gas phase is the **Matrix assisted laser desorption ionization (MALDI)**. In MALDI method, the sample is mixed with a light absorbing dye and a source of protons. This mixer is excited with a laser beam, causing the matter dispersed into the gas phase, so suddenly that it is not denatured.

## Collision Induced Disintegration

Inside the MS, peptides can be broken into smaller units by collision with helium or argon atoms. The molecular size of these fragments could be analyzed. As the molecular weight of each amino acid is known, the amino acids in the fragments could be identified.



Fig. 35.22: Glucometer

## Tandem Mass Spectrometry (MS-MS)

Two mass spectrometers are arranged sequentially. The first MS separates big peptides, based on their mass. From this observation, a single peptide can be directed into the second MS (called parent ion or precursor ion). The parent ion enters the collision cell of the second MS. Here the ions collide with argon gas molecules and are broken into smaller ions. These daughter ions (product ions) are detected and quantified by their mass spectrum in the second instrument. The high selectivity of MS-MS is that the parent ion mass and daughter ion mass are used for characterization. If combined with chromatographic separation, the retention time also becomes a factor (Fig. 35.23B). The applications of MS-MS include identification and quantification of proteins, drug screening, pesticides and pollutants and **screening of inborn errors** of metabolism, especially organic acidurias.

## Fluorescence Activated Cell Sorter (FACS)

The instrument is very widely used to separate lymphocyte subpopulations and stem cells. The cells are passed through a capillary nozzle one

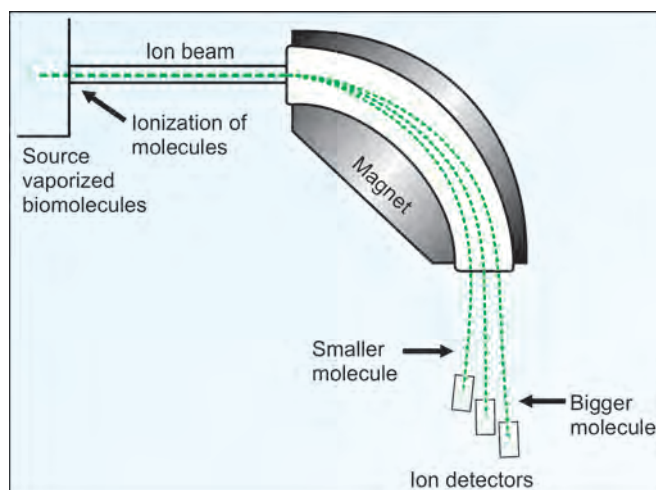


Fig. 35.23A: Mass spectrometry

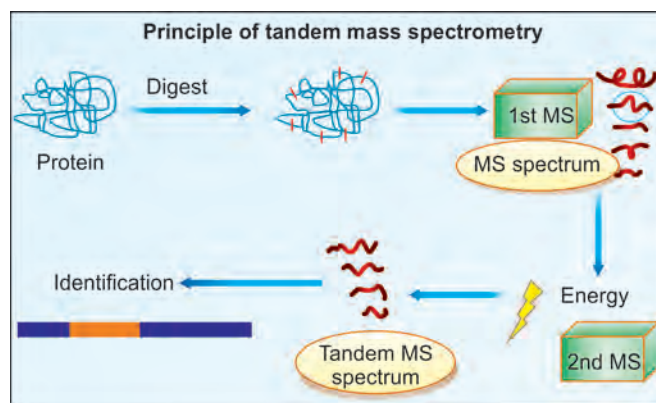


Fig. 35.23B: Tandem mass spectrometry

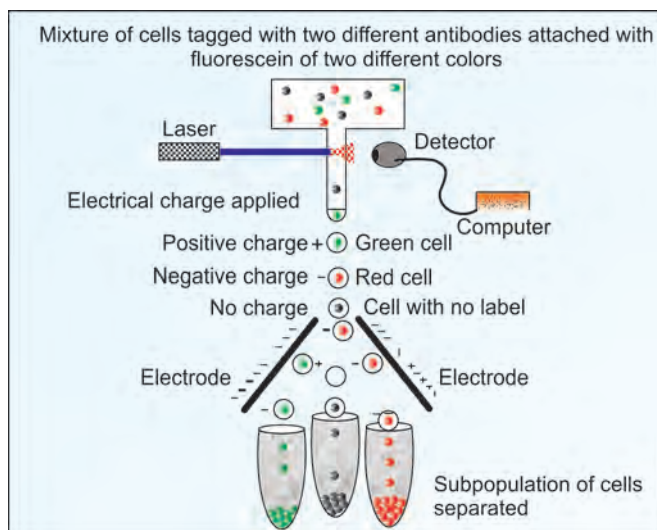


Fig. 35.24: Fluorescent activated cell sorter

at a time (Fig. 35.24). As the cells flow down the stream of liquid, they are scanned by a laser. Some of the laser light is scattered by the cells and this is used to count the cells. This scattered light can also be used to measure the size of the cells. Subpopulation of cells can also be separated by the same procedure. Here, the cells are tagged with a specific antibody linked to a fluorescent dye. The antibody is bound to a protein that is uniquely expressed on that particular group of cells. (If two different antibodies are used, with two different colored fluorescence, two different groups of cells could be tagged in the same sample). The laser light excites the dye, which emits a color of light that is detected by the light detector. An electrical charge is applied to the stream and the cells will get a charge. These charged cells are then deflected left or right by charged electrodes and into waiting sample tubes. Drops that contain cells with no fluorescence are sent into the waste tube. So, pure subpopulations of cells are collected in three different tubes.

### Related Topics

Related topics described in this book are protein estimation (see Chapter 4) and molecular biology techniques (see Chapter 49).

## QUICK LOOK OF CHAPTER 35

1. The term 'Electrophoresis' refers to the movement of charged particles, through an electrolyte when subjected to an electric field.
2. SDS-PAGE is useful in determining relative molecular weights of proteins.
3. Chromatography is the technique used to separate all classes of biomolecules.
4. HPLC and GC form two powerful chromatographic techniques that can resolve mixtures with high sensitivity and specificity.
5. Affinity chromatography relies upon the biological property of the molecule to be separated. For example, affinity of an enzyme to its substrate, ligand to its receptor.
6. Radioimmunoassay (RIA) involves use of radioactive isotopes as labels. It is a useful technique in clinical diagnostics and research. The quantitation of a biomolecule by RIA involves competition between radio labeled and unlabeled molecules for a given binding site.
7. Enzyme-linked immunosorbent assay (ELISA) is used in clinical diagnostics. It has the advantage of not being radiohazardous and having a longer shelf-life.
8. Colorimeters work in accordance with the Beer-Lambert law. As per the Beer's law, the intensity of the color is directly proportional to the concentration of the colored particles in the solution.
9. Wavelength selection in a spectrophotometer is achieved by diffraction gratings, while filters in colorimeters achieve it.
10. In flame photometer the property of emission spectroscopy is utilized. Na, K, Ca, and Li have characteristic emission spectra.





# SECTION D

---

## Nutrition

- Chapter 36 Fat Soluble Vitamins (A, D, E, K)
- Chapter 37 Water Soluble Vitamins - 1
- Chapter 38 Water Soluble Vitamins - 2
- Chapter 39 Mineral Metabolism and Abnormalities
- Chapter 40 Energy Metabolism and Nutrition
- Chapter 41 Detoxification and Biotransformation of Xenobiotics
- Chapter 42 Environmental Pollution and Heavy Metal Poisons



# CHAPTER 36

## Fat Soluble Vitamins (A, D, E, K)

### Chapter at a Glance

The reader will be able to answer questions on the following topics:

- Vitamin A
- Wald's visual cycle
- Deficiency of vitamin A
- Vitamin D
- Deficiency of vitamin D
- Vitamin E
- Vitamin K

Vitamins may be defined as organic compounds occurring in small quantities in different natural foods and necessary for growth and maintenance of good health in human beings and in experimental animals. Vitamins are essential food factors, which are required for the proper utilization of the proximate principles of food like carbohydrates, lipids and proteins. "A vitamin is a substance that makes you ill if you don't eat it" (Albert Zsent-Gyorgyi, Nobel Prize winner, 1937)

Discovery of vitamins started from observation of deficiency manifestations, e.g. scurvy, rickets, beriberi, etc. The vitamin theory was suggested by Hopkins in 1912 (Nobel Prize, 1929). The term "vitamine" was coined from the words vital + amine, since the earlier identified ones had amino groups. Later work showed that most of them did not contain amino groups, so the last letter 'e' was dropped in the modern term of vitamin at the insistence of McCollum.

The vitamins are mainly classified into two:

1. The fat soluble vitamins are A, D, E and K
2. Water soluble vitamins are named as B complex and C. The major differences between these two groups of vitamins are given in Table 36.1. In general, deficiency of vitamins may occur due to:

**TABLE 36.1:** Comparison of two types of vitamins

	<i>Fat soluble vitamins</i>	<i>Water soluble vitamins</i>
Solubility in fat	Soluble	Not soluble
Water solubility	Not soluble	Soluble
Absorption	Along with lipids Requires bile salts	*Absorption simple
Carrier proteins	Present	*No carrier proteins
Storage	Stored in liver	*No storage
Excretion	Not excreted	Excreted
Deficiency	Manifests only when stores are depleted	*Manifests rapidly as there is no storage
Toxicity	Hypervitaminosis may result	Unlikely, since excess is excreted
Treatment of deficiency	Single large doses may prevent deficiency	Regular dietary supply is required
Major vitamins	A, D, E and K	B and C

\*Vitamin B<sub>12</sub> is an exception.



- Reduced intake
- Impaired absorption
- Impaired metabolism
- Additional requirements
- Increased losses.

## VITAMIN A

McCullum, Simmonds and Kennedy isolated vitamin A in 1913. Richard Kuhn (Nobel prize, 1938) identified carotenes. Paul Karrer in 1931 elucidated the structure of vitamin A1 (Nobel prize, 1937).

## Chemistry

- Vitamin A is fat soluble. The active form is present only in animal tissues.
  - The **pro-vitamin**, beta-carotene is present in plant tissues. **Beta carotene** has two beta ionone rings connected by a polyprenoid chain (Fig. 36.1). One molecule of beta carotene can theoretically give rise to two molecules of vitamin A; but it may produce only one in biological systems.
  - All the compounds with vitamin A activity are referred to as **retinoids**. They are poly-isoprenoid compounds having a **beta-ionone** (cyclohexenyl) ring system.
  - Three different compounds with vitamin A activity are **retinol** (vitamin A alcohol), **retinal** (vitamin A aldehyde) and **retinoic acid** (vitamin A acid) (Fig. 36.1).
- Beta carotene is cleaved by a di-oxygenase, to form retinal. The retinal is reduced to retinol by an NADH or NADPH dependent retinal reductase present in the intestinal mucosa. Intestine is the major site of absorption (Fig. 36.3).
  - The absorption is along with other fats and requires bile salts. In biliary tract obstruction and steatorrhea, vitamin A absorption is reduced.
  - Within the mucosal cell, the retinol is re-esterified with fatty acids, incorporated into chylomicrons and transported to liver. In the liver stellate cells, vitamin is stored as **retinol palmitate**.

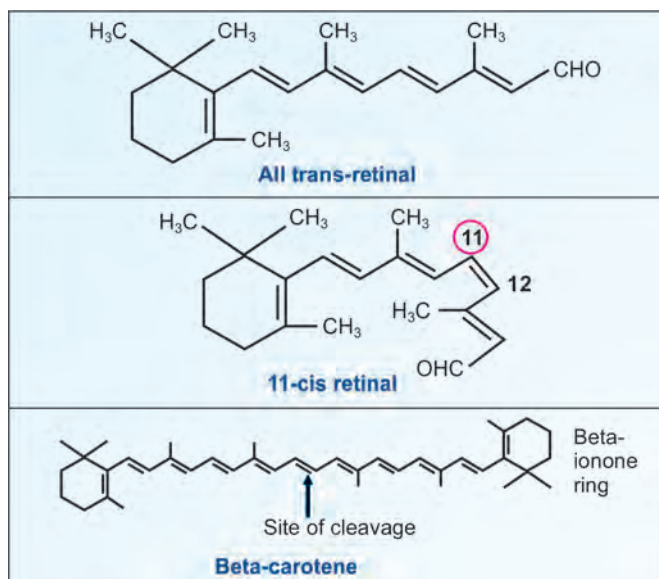


Fig. 36.1: Structure of vitamin A

## Absorption of Vitamin A

- The retinal may be reduced to retinol by retinal reductase. This reaction is readily reversible. Retinal is oxidized to retinoic acid, which cannot be converted back to the other forms (Fig. 36.2).
- The side chain contains alternate double bonds, and hence many isomers are possible. The **all-trans** variety of retinal, also called **vitamin A<sub>1</sub>** is most common (Fig. 36.1). Vitamin A<sub>2</sub> is found in *fish oils* and has an extra double bond in the ring. Biologically important compound is **11-cis-retinal**.

## Transport from Liver to Tissues

The vitamin A from liver is transported to peripheral tissues as trans-retinol by the **retinol binding protein** or RBP (Table 28.1 and Fig. 36.3). One molecule of RBP binds one

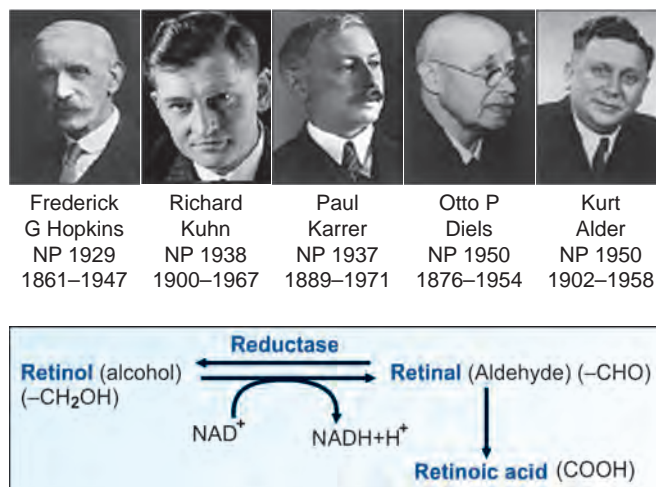


Fig. 36.2: Interconversion of vitamin A molecules



Frederick G Hopkins	Richard Kuhn	Paul Karrer	Otto P Diels	Kurt Alder
NP 1929	NP 1938	NP 1937	NP 1950	NP 1950
1861–1947	1900–1967	1889–1971	1876–1954	1902–1958

molecule of retinol. In the case of vitamin A deficiency, the RBP level in blood falls.

## Uptake by Tissues

The retinol-RBP complex binds to specific receptors on the retina, skin, gonads and other tissues. The RBP does not enter the cell. Inside the cytoplasm of cells, vitamin binds to cellular retinoic acid binding protein (CRBP) and finally to hormone responsive elements (HRE) of DNA. Thus genes are activated (Fig. 36.3).

## Biochemical Role of Vitamin A

### Wald's Visual Cycle

#### Generation of Nerve Impulse

- i. Wald was awarded Nobel Prize in 1967, for identifying the role of vitamin A in vision. **Rhodopsin** (mol wt 35,000 Daltons) plays the pivotal role in vision. It is a membrane protein found in the photoreceptor cells of the retina. Rhodopsin is made up of the protein **opsin** and **11-cis-retinal**.
- ii. When light falls on the retina, the 11-cis-retinal isomerizes to **all-trans-retinal** (Fig. 36.4). A single photon can excite the rod cell. The photon produces immediate conformational change. The unstable intermediates produced are: Rhodopsin → Bathorhodopsin → Lumirhodopsin → Metarhodopsin-I → Metarhodopsin-II → and finally Opsin + all-trans-retinal. Each of these intermediaries has a lifespan of only few picosecond to microseconds. The all-trans-retinal is then released from the protein.

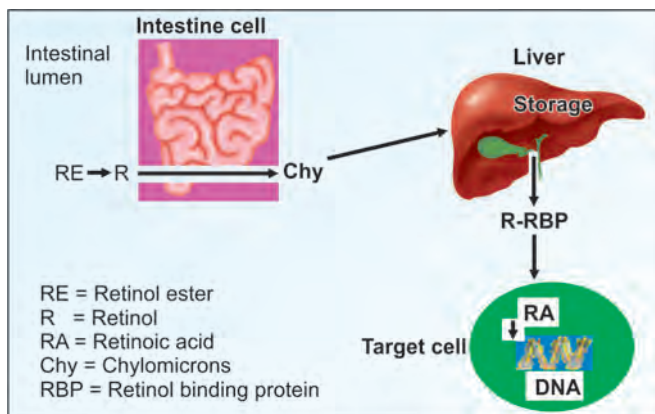


Fig. 36.3: Vitamin A metabolism

- iii. Visual pigments are G-protein-coupled receptors and 11-cis retinal locks the receptor protein (opsin) in its inactive form (Fig. 36.5A). The isomerization and photo-excitation leads to activation of G-protein and generation of cyclic-GMP (Fig. 36.5B). Cyclic GMP acts as the gate for cation specific channels. **Transducin** is the G-protein in retina. The nerve impulse thus generated in the retina is transmitted to visual centres in the brain. The signal is terminated by phosphorylation of a serine residue of activated rhodopsin, by an enzyme rhodopsin kinase, so that the inhibitory protein **beta-arrestin** can bind and inactivate rhodopsin.

#### Regeneration of 11-cis-retinal

- i. After dissociation, opsin remains in retina; but trans- retinal enters the blood circulation (Fig. 36.4). Later cis- retinal is generated, reaches retina. The re-attachment of 11-cis retinal to opsin is critical for shutting off the pigment's catalytic activity.

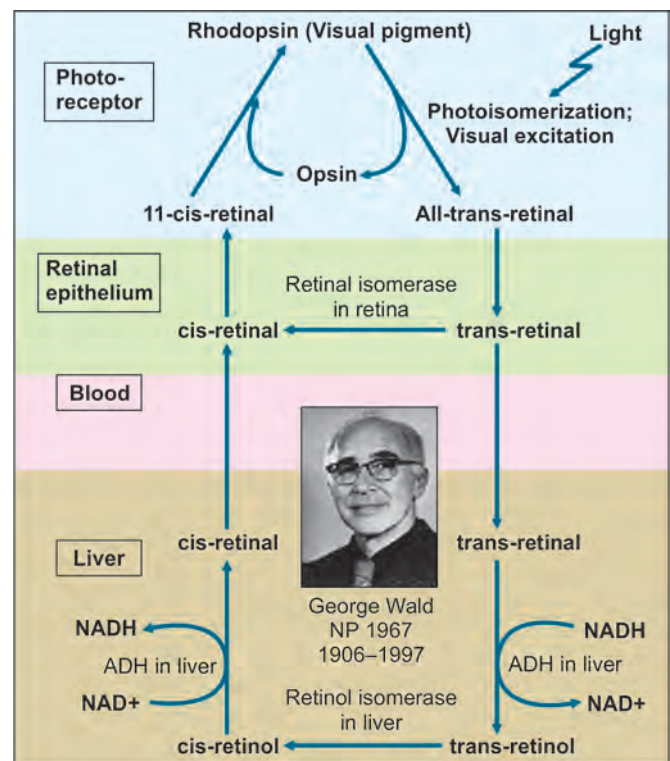
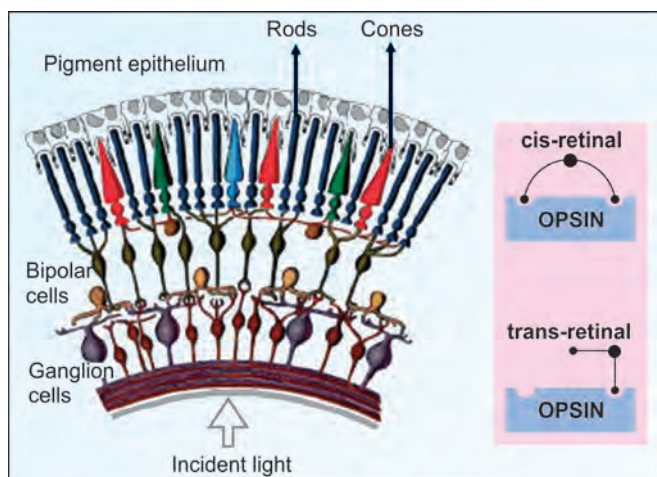
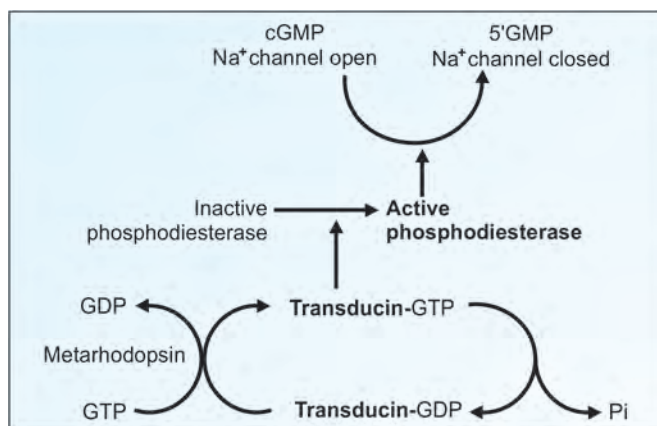


Fig. 36.4: Wald's visual cycle. Blue color represents reactions in photoreceptor matrix. Green background represents reactions in retinal pigment epithelium. Red depicts blood. Yellow shows reactions in liver

- ii. The all-trans-retinal is isomerized to 11-cis-retinal in the retina itself in the dark by the enzyme **retinal isomerase**. This reaction is taking place in retinal pigment epithelium. The 11-cis retinal can recombine with opsin to regenerate rhodopsin.
- iii. Alternatively, all-trans-retinal is transported to liver and then reduced to all-trans-retinol by **alcohol dehydrogenase (ADH)**, an NADH dependent enzyme. ADH contains zinc, and therefore, **zinc** is important in retinol metabolism. The all-trans-retinol is isomerized to 11-cis-retinol and then oxidized to 11-cis-retinal in liver. This is then transported to retina. This completes the Wald's visual cycle (Fig. 36.4).



**Fig. 36.5A:** Structure of retina showing rods and cones. The inset on right side shows the structural alteration during photoisomerization



**Fig. 36.5B:** Photoexcitation leads to activation of G protein

### Dark Adaptation Mechanism

For their work on information processing in visual pathways, Torsten Wiesel and David Hubel were awarded Nobel Prize in 1981. Rods and Cones are diagrammatically represented in Figure 36.5B.

- i. Bright light depletes stores of rhodopsin in rods. Therefore, when a person shifts suddenly from bright light to a dimly lit area, there is difficulty in seeing, for example, entering a cinema theater. After a few minutes, rhodopsin is resynthesized and vision is improved. This period is called **dark adaptation time**.
- ii. It is increased in vitamin A deficiency. Red light bleaches rhodopsin to a lesser extent; so doctors use tinted glasses, during fluoroscopic X-ray examination of the patients.

### Rods are for Vision in Dim Light

In the retina, there are two types of photosensitive cells, the rods and the cones. Rods are responsible for perception in dim light. Rhodopsin present in rods is made up of 11-cis-retinal + opsin. Deficiency of cis-retinal will lead to increase in dark adaptation time and night blindness. In humans, one eye contains about 120 million rods, each of which carries 120 million molecules of rhodopsin. The number of rods is more in cats, mice and owls.

### Cones are for Color Vision

- i. Cones are responsible for vision in bright light as well as color vision. They contain the photosensitive protein, **conopsin**.
- ii. There are 3 types of cones, each is characterized by a different conopsin, that is maximally sensitive to either blue (**cyanopsin**), green (**iodopsin**) or red (**porphyropsin**).
- iii. In cone proteins also, 11-cis-retinal is the chromophore. Reduction in number of cones or the cone proteins, will lead to **color blindness**. One eye contains about 6 million cones.

### Colors have Profound Influence in Life

About one-third of gray matter of the brain is involved in the processing of visual information. About 70% of information inputs to the brain are visual. The optimists view the world through “rose-colored” eyes. When sad, a person is in a “blue” mood. Saffron color has tranquilizing effect, especially in agitated persons. Even a brief display of saffron color produces measurable relaxation in muscles. Blue color, although makes one peaceful and content, increases the muscle tone. Mice living in red light are most active, while in green light, they are least active. Other than the actual color,



the subtle shift in hue is more responsible to unlock automatic impulses. The effects of colors on human moods have applications in criminology, psychiatry, interior decoration, chromotherapy and Yoga.

### Other Biochemical Functions of Vitamin A

- i. Retinoic acid has a role in the regulation of gene expression and **differentiation** of tissues. All-trans-retinoic acid and 9-cis-retinoic acid act like steroid hormones. They bind to nuclear receptors; retinoic acid along with the receptor binds to the response elements of DNA. Retinoic acid receptors (RAR) bind all-trans-retinoic acid, while retinoid X receptors (RXR) bind to 9-cis-retinoic acid. RXRs form dimers with vitamin D receptor also. The impairment of the biochemical effects of vitamin D in vitamin A deficiency may be attributed to this relationship. Several genes, whose expressions are altered by retinoic acid, are involved in the earliest processes of embryogenesis including the differentiation of the three germ layers and organogenesis. There are more than 100 genes that are directly regulated by retinoic acid through interaction with RAR.
- ii. Retinol is necessary for the reproductive system. Retinol acts like a steroid hormone in controlling the expression of certain genes. This may account for the requirement of vitamin A for normal **reproduction**. In vitamin A deficiency, miscarriages are noticed in female rats while atrophy of germinal epithelium and sterility are seen in male rats.

- iii. **Antioxidant property:** There is a correlation between the occurrence of epithelial cancers and vitamin A deficiency. The anticancer activity has been attributed to the natural antioxidant property of **carotenoids**. Fresh vegetables containing carotenoids were shown to reduce the incidence of cancer.
- iv. Beta carotenes may be useful in preventing **heart attacks**. Those who were given beta carotene supplements suffered half as many heart attacks as in the group taking placebo.
- v. Vitamin A is necessary for the maintenance of normal-**epithelium** and skin (Fig. 36.5C).

## Deficiency Manifestations of Vitamin A

### Night Blindness or Nyctalopia

Visual acuity is diminished in dim light. The patient cannot read or drive a car in poor light. The dark adaptation time is increased.

### Xerophthalmia

The conjunctiva becomes dry, thick and wrinkled. The conjunctiva gets keratinized and loses its normal transparency. Dryness spreads to cornea. It becomes glazy and lusterless due to keratinization of corneal epithelium. Infections may supersede.

### Bitot's Spots

These are seen as grayish-white triangular plaques firmly adherent to the conjunctiva. This is due to increased thickness of conjunctiva in certain areas. All the ocular changes mentioned so far are completely reversible when vitamin is supplemented.

### Keratomalacia

When the xerophthalmia persists for a long time, it progresses to keratomalacia (softening of the cornea).

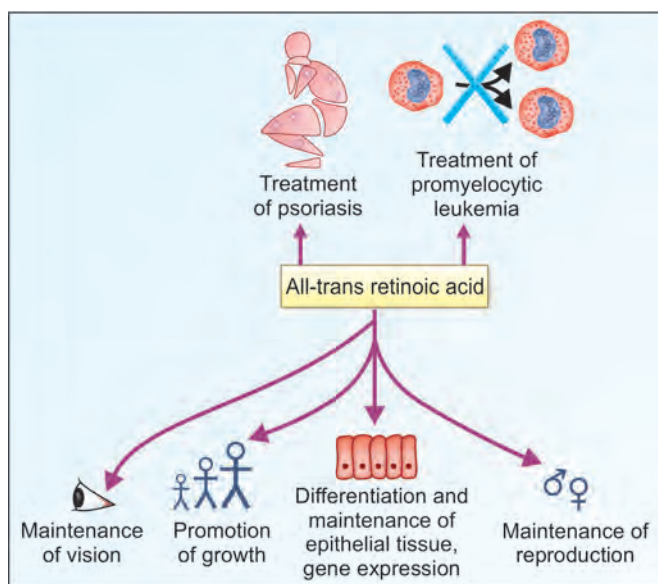


Fig. 36.5C: Summary of actions of vitamin A



Torsten Wiesel  
NP 1981  
b. 1924



David Hubel  
NP 1981  
b. 1926



There is degeneration of corneal epithelium which may get vascularized. Later, corneal opacities develop (Fig. 36.6). Bacterial infection leads to corneal ulceration, perforation of cornea and total blindness.

### Preventable Blindness

The deficiency of vitamin A is the most common cause of blindness in Indian children below the age of 5. One third of the world's blind population is residing in India. About 40% of blindness is preventable. Vitamin A deficiency is a major public health problem. A single dose of vitamin A is given, as a prophylactic measure, to children below 1 year age.

### Skin and Mucous Membrane Lesions

- i. Follicular **hyperkeratosis** or phrynoderma results from hyperkeratinization of the epithelium lining the follicles. The skin becomes rough. Keratinizing metaplasia of the epithelium of the respiratory, gastrointestinal and genitourinary tracts have been observed. Epithelium is **atrophied**. Keratinization of urinary tract epithelium may lead to **urinary calculi**.
- ii. The alterations in skin may cause increased occurrence of **generalized infections**. Therefore in old literature, vitamin A is referred to as anti-inflammatory vitamin.
- iii. Isoretinone, a synthetic variant of vitamin A is known to reduce the sebaceous secretions, hence it is used to prevent **acne** formation during adolescence.

Acne is the most common disease of the skin. It affects 85% of teenagers, and 50% persons between the ages of 20 and 30 years. The role of hormones, particularly as a trigger of sebum production and sebaceous growth and differentiation, is well known. Excess production of androgens, GH, IGF-1, CRH, and glucocorticoids, is associated with increased rates of acne. Acne may be a feature in many endocrine disorders, including polycystic ovary disease, Cushing's syndrome, CAH, androgen-secreting tumors, and acromegaly. Acne medicamentosa is the development of acne with the use of certain drugs, such as, testosterone, progesterone, lithium, phenytoin, isoniazid, and epidermal growth factor inhibitors.



Fig. 36.6: Keratomalacia

### Other General Manifestations

In vitamin A deficiency, growth retardation, especially failure of skeletal growth is noticed. This may be due to defective synthesis of chondroitin sulfate. Vitamin A deficiency is also manifested as decreased protein synthesis, lowered glycoprotein content of cell and reduced immunity against infections.

### Causes for Vitamin A Deficiency

- i. Decreased intake.
- ii. Obstructive jaundice causing defective absorption.
- iii. Cirrhosis of liver leading to reduced synthesis of RBP
- iv. Severe malnutrition, where amino acids are not available for RBP synthesis.
- v. Chronic nephrosis, where RBP is excreted through urine.

### Assessment of Deficiency

- a. Dark adaptation test— It is the time required to adapt the eye to see objects in dim light. It is increased in vitamin A deficiency.
- b. RBP (retinol binding protein) level in serum is decreased. (See Table 28.1).
- c. Vitamin A in serum is decreased. The colorimetric measurement is based on Carr and Price reaction, where retinoids are made to react with antimony trichloride to give a blue color. Vitamin A may be directly measured by spectrophotometry; it has maximum absorption at 325 nm.
- d. **Normal blood level** of vitamin A is 25 to 50 µg/dL.

### Daily Requirement of Vitamin A

The recommended daily allowance (RDA) for

- i. Children = 400–600 µg/day
- ii. Men = 750–1000 µg/day
- iii. Women = 750 µg/day
- iv. Pregnancy = 1000 µg/day

One international unit = 0.3 mg of retinol. One retinol equivalent = 1 microgram of retinol or 6 microgram of beta carotene.



Fig. 36.7: A parody of the old proverb is "One carrot a day will keep the Ophthalmologist away"

## Dietary Sources of Vitamin A

Animal sources include milk, butter, cream, cheese, egg yolk and liver. Fish liver oils (cod liver oil and shark liver oil) are very rich sources of the vitamin. Vegetable sources contain the yellow pigment beta carotene. **Carrot** contains significant quantity of beta carotene (Fig. 36.7). **Papaya, mango, pumpkins, green leafy vegetables (spinach, amaranth)** are other good sources for vitamin A activity. During cooking the activity is not destroyed.

## Therapeutic use of Vitamin A

When deficiency of vitamin A is identified, supplementation is given as capsules or injection. Therapeutic dose is generally 20–50 times higher than the RDA. All-trans-retinoic acid is used as adjuvant in the treatment of promyelocytic **leukemia**. It causes remission due to its effect on differentiation of cells (Fig. 36.5C).

## Hypervitaminosis A or Toxicity

Excessive intake can lead to toxicity since the vitamin is stored. It has been reported in children where parents have been overzealous in supplementing the vitamins. Eskimos refrain from eating the liver of polar bear due to its high vitamin A content. Symptoms of toxicity include anorexia, irritability, headache, peeling of skin, drowsiness and vomiting. Some of these signs are due to increased intracranial tension. Sometimes swelling over long bones (bony exostosis) may occur with painful bones. Enlargement of liver is also seen in children. Higher concentration of retinol increases lysosomal enzymes, leading to cellular death.

Hypercarotenemia can result from persistent excessive consumption of foods rich in carotenoids. The skin becomes yellow, but no staining of sclera as in jaundice is observed.

## VITAMIN D (CHOLECALCIFEROL)

There are reports of symptoms of rickets from historians as early as 2nd century AD. Francis Glisson wrote a classical account of infantile rickets in 1650. Experimental rickets induced by dietary deficiency was produced in rats by McCollum in 1919. Angus and coworkers isolated vitamin D in 1931 and named it as calciferol, which was later identified as Vitamin D<sub>3</sub>. The structural elucidation was done independently by Otto Diels and Kurt Alder. Both were awarded Nobel prize in 1950.

## Formation of Vitamin D

Vitamin D is derived either from 7-dehydrocholesterol or ergosterol by the action of ultraviolet radiations. **7-dehydrocholesterol**, an intermediate of a minor pathway of cholesterol synthesis, is available in the Malpighian layer of epidermis. In the skin, ultraviolet light (290–315 nm) breaks the bond between position 9 and 10 of the steroid ring. So, the ring B is opened, to form the provitamin, **secosterol** (Fig. 36.8). The cis double bond between 5th and 6th carbon atoms, is then isomerized to a trans double bond (rotation on the 6th carbon atom) to give rise to vitamin D<sub>3</sub> or **cholecalciferol** (Fig. 36.8). So, vitamin D is called the “**sun-shine vitamin**”.

Skin is the largest organ in the body. It makes about 16% of body weight. It is kept nourished by a quarter of the body's blood supply. It is the temperature regulator of the body. The production of vitamin D in the skin is directly proportional to the exposure to sunlight and inversely proportional to the pigmentation of skin. An increase in solar zenith angle during November to March shifts the wavelength of UV rays to longer wavelengths which will not produce the vitamin; hence vitamin deficiency is seen in winter.

Commercially the vitamin is derived from the fungus, ergot. The ergosterol when treated with ultraviolet light, **ergocalciferol** or vitamin D<sub>2</sub> is produced. Ergocalciferol differs in having an unsaturation in the side chain and an extra methyl group (C28).

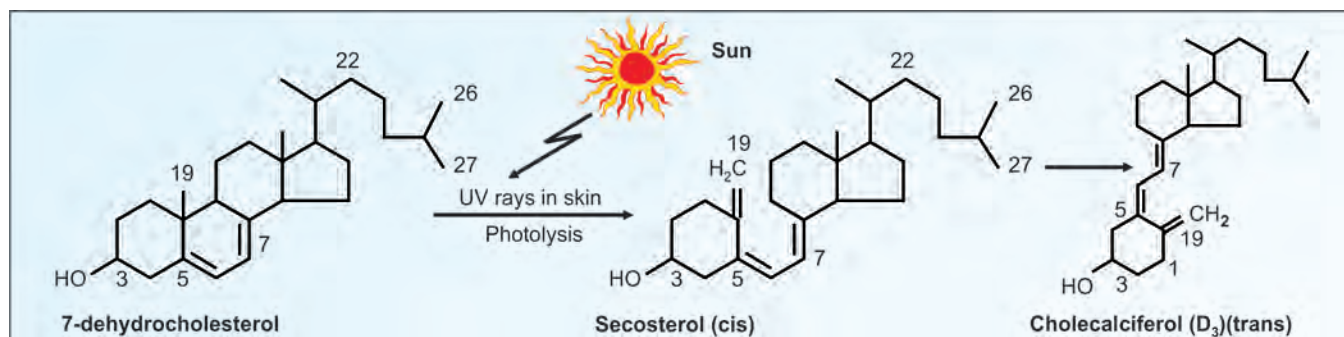


Fig. 36.8: Synthesis of cholecalciferol or vitamin D<sub>3</sub>

## Activation of Vitamin D

- Vitamin D is a **prohormone**. The cholecalciferol is first transported to **liver**, where hydroxylation at **25th position** occurs, to form 25-hydroxy cholecalciferol (25-HCC). The hepatic 25-hydroxylase is a microsomal mono-oxygenase and product of gene CYP27A1. It requires cytochrome P-450 and NADPH (Fig. 36.9). 25-HCC is the major storage form.
  - In plasma, 25-HCC is bound to “vitamin D binding protein” (VDBP), an alpha-2 globulin.
  - In the **kidney**, it is further hydroxylated at the **1st position**. The 1-alpha hydroxylase is located in mitochondria of proximal convoluted tubules and a product of the gene CYP27B1. It requires cytochrome P-450, NADPH and ferredoxin (an iron-sulfur protein). Thus 1, 25-dihydroxy cholecalciferol (**DHCC**) is generated. Since it contains three hydroxyl groups at 1, 3 and 25 positions, it is also called **Calcitriol** (Fig. 36.9). The calcitriol thus formed is the **active form** of vitamin; it is a **hormone** (Box 36.1). 24, 25-dihydroxy cholecalciferol may be formed by hydroxylation of 25HCC at the 24th position, a relatively inactive product.
- PTH is released in response to low serum calcium and induces the production of calcitriol. In contrast, reduced levels of PTH stimulate synthesis of the inactive 24, 25-dihydroxy D3. The calcitriol binds to its highly specific nuclear receptor VDR, forms a heterodimeric complex

### Box 36.1: Calcitriol and calcitonin are different

**Calcitriol** is the physiological active form of vitamin D. It increases the blood calcium level.

**Calcitonin** is the peptide hormone released from thyroid gland. It decreases the blood calcium.

with RXR (retinoid X receptor) which binds to VDRE (Vitamin D response elements) on DNA and modulates the transcriptional activity of vitamin D responsive genes. Most organs and tissues in the body express the VDR; which modulates the expression of more than 500 genes. This activation takes place within minutes. Apart from this nuclear receptor, another membrane specific receptor for calcitriol has also been described. Vitamin D is also necessary for signal transduction mechanisms in all organs especially in brain and immune cells.

## Biochemical Effects of Vitamin D

May be divided into calcemic and extracalcemic effects.

Calcemic effects are exerted at—

- Intestinal villous cells
- Bone osteoblasts
- Kidney distal tubular cells.

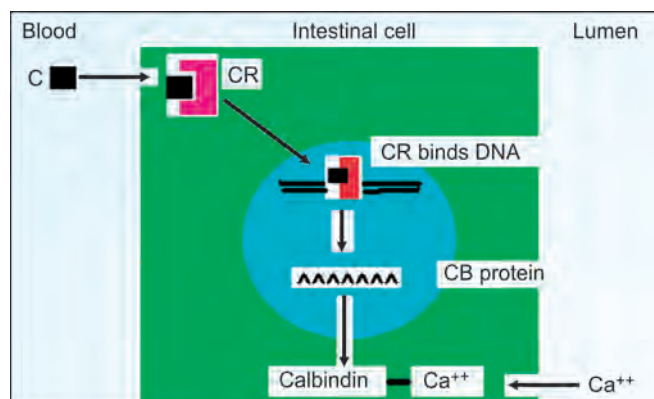


Fig. 36.10: Calcitriol increases calcium absorption

C = calcitriol; R = receptor; CR = calcitriol receptor complex; CB = calbindin.

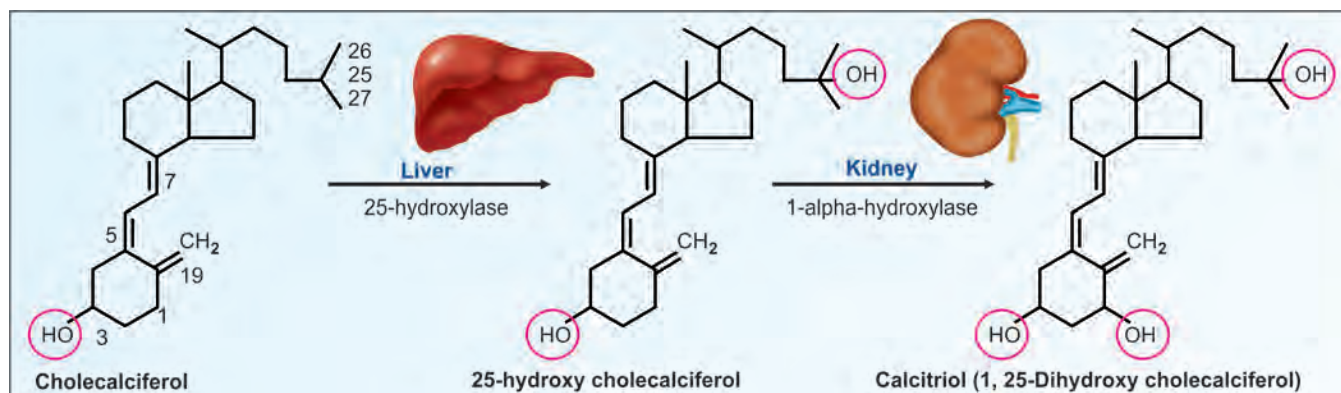


Fig. 36.9: Generation of calcitriol



## Vitamin D and Absorption of Calcium

Calcitriol promotes the absorption of calcium and phosphorus from the intestine. On the brush-border surface, calcium is absorbed passively. From the intestinal cell to blood, absorption of calcium needs energy. It is either by the sodium-calcium exchange mechanism or by pumping out the calcium-calbindin complex. **Calcitriol** acts like a steroid hormone. On entering the cell it binds to a specific nuclear receptor—VDR which binds to VDRE on elements upon forming a dimer with RXR. Transcriptional activation of specific genes that code for calbindin occurs (Fig. 36.10). Due to the increased availability of calcium binding protein, the absorption of calcium is increased.

## Effect of Vitamin D on Bone

**Mineralization** of the bone is increased by increasing the activity of osteoblasts (see Chapter 39). Calcitriol coordinates the remodeling of bone and increases bone mineral density. Active vitamin D has action on all three types of bone cells—osteoblasts, osteoclasts and osteocytes.

Intracellular conversion of 25hydroxyD<sub>3</sub> to calcitriol by osteoblasts promotes their differentiation and mineralization. Osteoclastogenesis from multinucleated precursors is induced by osteoblast secretion of **R**eceptor activation of **n**uclear factor **k**appa B ligand (RANKL), a cytokine. Osteoclastic bone resorption and alkaline phosphatase activity of osteoblasts provide adequate calcium and phosphorus to promote mineralization. The hypercalcemia induces secretion of fibroblast growth factor 23 (FGF23) from osteocytes which upregulates 24-hydroxylase. This completes the negative feedback loop on PTH secretion.

The hormone is responsible for increased production of bone matrix proteins such as collagen, osteocalcein and osteopontin.

## Effect of Vitamin D on Renal Tubules

Calcitriol increases the reabsorption of calcium and phosphorus by renal tubules, therefore both minerals are conserved. (PTH conserves only calcium) (see Chapter 39).

## Regulation of Calcitriol Formation by Feedback Control

The hormonal level of calcitriol is maintained by the feedback control. The rate of production is modulated by serum levels of calcium, phosphorus, PTH and calcitriol itself. The major site of control is on the 1-alpha-hydroxylase of kidney. Hypercalcemia decreases calcitriol. Low dietary calcium and hypocalcemia increase the rate of production of 1, 25-DHCC. The stimulatory effect of hypocalcemia on 1-alpha-hydroxylase is through PTH. Hypercalcemia decreases calcitriol. The half-life of 1, 25-DHCC is 6–8 hours and is mainly excreted through the bile. The inactivation is by oxidation of the side

chain. Hydroxylation at the 24th position by the kidney also lowers the activity. In vitamin D deficient state (low calcium and phosphate) will enhance the action of 1-alpha hydroxylase. When vitamin D status is adequate, or calcium level is high, 24-hydroxylation is favored, forming 24, 25-DHCC, which is less active. 1, 25-DHCC level directly regulates PTH secretion.

## Deficiency of Vitamin D

The deficiency diseases are **rickets** in children and **osteomalacia** in adults. Hence vitamin D is known as antirachitic vitamin.

The optimal concentration of 25-hydroxy D<sub>3</sub> is > 30 ng/mL, where as 20–29 ng/mL is considered insufficient and 10–19 ng/mL is deficient. A level below 10 ng/mL indicates severe deficiency. (Concentrations more than 150 ng/mL is toxic). Current methods to measure vitamin D in blood are RIA, CLIA, HPLC and LC-tandem mass spectrometry.

It is well known that advance in age and presence of melanin will decrease the formation of vitamin D<sub>3</sub> on skin. Various studies have shown that 50–80% of elderly and 20–50% of children have hypovitaminosis D. Even in affluent countries, vitamin D deficiency is very common. Deficiency is more common in obese people, because vitamin D is stored in adipose tissue, and not released for utilization. Vitamin D deficiency was associated with poor bone health, low calcium concentration, higher systolic blood pressure and lower HDL cholesterol values; all of which are risk factors for heart disease. The role of vitamin D on prevention of cancer risk provides a very important therapeutic use for the vitamin. Children and adolescents with vitamin D deficiency are at higher risk for allergies and asthma.

## Causes for Vitamin D Deficiency

- i. Deficiency of vitamin D can occur in people who are not exposed to sunlight properly, e.g. inhabitants of northern latitudes, in winter months, in people who are bedridden for long periods, or those who cover the whole body (*purdah*).
- ii. Nutritional deficiency of calcium or phosphate may also produce similar clinical picture.
- iii. Malabsorption of vitamin (obstructive jaundice and steatorrhea). High phytate content in diet may also reduce the absorption of vitamin.
- iv. Abnormality of vitamin D activation. Liver and renal diseases may retard the hydroxylation reactions.
- v. Deficient renal absorption of phosphates.



Hypovitaminosis D has emerged as a lifestyle disease by the beginning of the new century and about 1 billion people all over the world are found to have deficiency of the vitamin which was being considered as a thing of the past. The lifestyle changes that now keep people indoors both adults and children and the widespread use of sunscreen are responsible for this change.

### Clinical Features of Rickets

- i. Rickets is seen in children. There is insufficient mineralization of bone. Bones become soft and pliable. The bone growth is markedly affected.
- ii. The classical features of rickets are **bone deformities**. Weight bearing bones are bent (Fig. 36.11). Continued action of muscles also cause bone malformations.
- iii. The clinical manifestations include bow legs, knock-knee, rickety rosary, bossing of frontal bones, and pigeon chest.
- iv. An enlargement of the epiphysis at the lower end of ribs and costochondral junction leads to beading of ribs or **rickety rosary**.
- v. **Harrison's sulcus** is a transverse depression passing outwards from the costal cartilage to axilla. This is due to the indentation of lower ribs at the site of the attachment of diaphragm.

### Clinical Features of Osteomalacia

- i. The term is derived from Greek "osteon" = bone; and "malakia" = softness. The bones are softened due to insufficient mineralization and increased osteoporosis. Patients are more prone to get fractures.
- ii. The abnormalities in **biochemical parameters** are a slightly lower serum calcium, and a low serum phosphate.



Fig. 36.11: Bone deformity in rickets

- iii. It may be noted that vitamin D deficiency never produces severe hypocalcemia. Tetany will not be manifested.
- iv. Serum **alkaline phosphatase**, bone iso-enzyme, is markedly increased.

### Different Types of Rickets

1. The classical vitamin D **deficiency** rickets can be cured by giving vitamin D in the diet.
2. The **hypophosphatemic** rickets mainly result from defective renal tubular reabsorption of phosphate. Supplementation of vitamin D along with phosphate is found to be useful.
3. **Vitamin D resistant** rickets is found to be associated with *Fanconi syndrome*, where the renal tubular reabsorption of bicarbonate, phosphate, glucose, and amino acids are also deficient.
4. **Renal rickets**: In kidney diseases, even if vitamin D is available, calcitriol is not synthesized. These cases will respond to administration of calcitriol.
5. **End organ refractoriness** to 1, 25-DHCC will also lead to rickets. Either a decrease in the number of cytosolic receptor or a structurally abnormal receptor is noticed. The bone disease has been found to respond to megadoses of calcitriol (35 mg/day).

### Other Actions of Vitamin D

Recent research has proved that most tissues possess vitamin D receptor and several tissues have the enzymes to generate calcitriol. 1, 25-DHCC has been found to have a modulatory effect on immune-hematopoietic system. Therapeutic doses given to children with rickets have been found to correct the anemia, hypocellularity of the bone marrow and increased susceptibility to infection. It has also been found to reduce the risk of cancer and coronary vascular disease. Beneficial effects have been observed in patients with AIDS. Calcitriol exerts its pleiotropic actions via the specific receptor VDR, an important transcription factor.

### Vitamin D and Innate Immunity

Vitamin D has been found to be a modulator of immune response. The binding of pathogens (*Mycobacterium tuberculosis*) to Toll like receptors on macrophages induces the synthesis of VDR and 1-alpha hydroxylase. The resultant activation of 25OH D3 and upregulation of specific genes leads to production of antimicrobial proteins in the cell. In hypovitaminosis this capacity is blunted and may be the reason behind the advice given to tuberculosis patients to be in a sunny weather. A negative correlation between IgE and vitamin D concentration; and a positive relation between vitamin D and lung function were shown in children with asthma. Vitamin D supplementation in patients with steroid resistant asthma was found to be beneficial.

## Vitamin D and Metabolic Syndrome

Vitamin D insufficiency is associated with higher risk for metabolic syndrome (MS). MS is described in Chapter 24. Low serum vitamin D<sub>3</sub> is known to perturb cellular function in the endocrine pancreas, which is involved in the pathogenesis of obesity and type 2 diabetes. Insufficiency of vitamin 25(OH)D<sub>3</sub> is more common in patients with excessive body weight and MS. Vitamin D deficiency is associated with increased risks for hypertension, glucose intolerance, impaired synthesis and secretion of insulin, insulin resistance, type 2 diabetes mellitus, MS, obesity, myocardial infarction, stroke, peripheral vascular disease, and asthma. Vitamin D concentration positively correlates with HDL Cholesterol and negatively with serum triglyceride levels and LDL-cholesterol. Vitamin supplementation was found to be beneficial in all these clinical conditions.

## Requirement of Vitamin D

- i. Children = 10 µg (400 IU)/day
- ii. Adults = 5 to 10 µg (200 IU)/day
- iii. Pregnancy, lactation = 10 µg/day
- iv. Above the age of 60 = 600 IU per day.

In overweight or obese children, supplementation with higher doses of vitamin D up to 800 IU/day should be considered because vitamin D is stored in fat tissue. Supplementation with vitamin D<sub>3</sub> is better than with vitamin D<sub>2</sub>, because of the longer half-life of the former. The requirements to have the extracalcemic effects may be even more, up to 1000 IU/day for adults and 1500 IU in elderly.

## Sources of Vitamin D

Exposure to **sunlight** produces cholecalciferol. Moreover, fish liver oil, fish and egg yolk are good sources of the vitamin. Milk contains moderate quantity of the vitamin. The current recommendation is to fortify dairy products with vitamin D and adequate exposure to sunlight without sunscreen before 10 am and after 3 pm at least 15 minutes a day (safe sun).

## Hypervitaminosis D

Concepts of hypervitaminosis D have changed now. Therapeutic doses varying from 2000–4000 IU/day or weekly doses are being given now. Doses above 10,000 units per day for long periods may cause toxicity. Symptoms include weakness, polyuria, intense thirst, difficulty in speaking, hypertension and weight loss. Hypercalcemia leads to calcification of soft tissues, (metastatic **calcification**, otherwise called **calcinosis**), especially in vascular and renal tissues. Although vitamin D is toxic in higher doses, excessive exposure to sunlight does not result in vitamin D toxicity, because excess D<sub>3</sub> is destroyed by sunlight itself.

## VITAMIN E

The active vitamin was isolated from wheat germ oil and named tocopherol (*tokos* = child birth; *pheros* = to bear; *ol* = alcohol). Initial studies of induced vitamin E deficiency in laboratory animals resulted in infertility and therefore the vitamin came to be known as anti-infertility vitamin. Now vitamin E is known as the most potent biological antioxidant.

## Chemical Nature

A chromane ring (tocol) system, with an isoprenoid side chain is present in all the eight naturally occurring tocopherols. Of these, **alpha tocopherol** (5, 7, 8-trimethyl tocol) has greatest biological activity (Fig. 36.12). The structure of vitamin E was elucidated by Paul Karrer, who was awarded Nobel prize in 1937.

## Metabolism of Vitamin E

Normal blood level of tocopherol is 0.5–1 mg/dL. It is absorbed along with other fats and needs the help of bile salts. Tocopherol is absorbed and transported as chylomicrons. It is stored in adipose tissue. During catabolism, the chromane ring and side chain may be oxidized and excreted in bile after conjugation with glucuronic acid.

## Biochemical Role of Vitamin E

- i. Vitamin E is the **most powerful natural antioxidant** (see Chapter 33). Free radicals are continuously being generated in living systems. Their prompt inactivation is of great importance. Vitamin E is a known biological antioxidant able to quench the lipid peroxidation chain and to protect the plasma membranes from the attack of free radicals.
- ii. The free radicals would attack bio-membranes. Vitamin E protects RBC from **hemolysis**. By preventing the peroxidation, it keeps the structural and functional integrity of all cells.
- iii. Gradual deterioration of **aging** process is due to the cumulative effects of free radicals. Vitamin E also boosts immune response.
- iv. It reduces the risk of atherosclerosis by reducing oxidation of LDL (Fig. 36.13; see Chapter 25 for atherosclerosis).

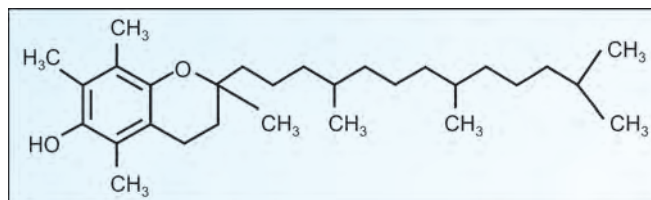
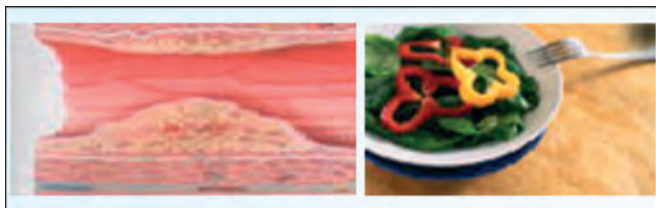


Fig. 36.12: Alpha tocopherol



**Fig. 36.13:** Atherosclerotic plaque in a blood vessel is shown in left side. It may be prevented by vegetables containing vitamin E

- v. Vitamin E can depress leukocyte oxidative bactericidal activity.

### Inter-relationship with Selenium

Selenium is present in **glutathione peroxidase**; an important enzyme that oxidizes and destroys the free radicals (see Chapter 33). Selenium has been found to decrease the requirement of vitamin E and vice versa. They act synergistically to minimize lipid peroxidation. Selenium is described in Chapter 39.

### Deficiency Manifestations of Vitamin E

In rats, inability to produce healthy ovum and loss of motility of spermatozoa, hemolysis of red cells, acute hepatic necrosis and muscular dystrophy are observed. In a normal adult, the body vitamin E stores can meet the requirement for several months.

No major disease states have been found to be associated with vitamin E deficiency due to adequate levels in the average diet. Vitamin E deficiency is seen in persons (a) who cannot absorb dietary fat, (b) in premature infants (birthweight less than 1500 grams), (c) in abetalipoproteinemia and (d) in mutations in the gene for the tocopherol transfer protein. Vitamin E deficiency causes neurological problems due to poor nerve conduction. These include neuromuscular problems such as spinocerebellar ataxia, retinopathy, peripheral neuropathy and myopathies. Deficiency can also cause anemia, due to oxidative damage to red blood cells. Absence of deep tendon reflexes and positive Babinski sign are also manifested. Age-related macular degeneration (AMD) is an important cause of visual impairment and blindness among people 65 years and older. It has been shown that vitamin E combined with other antioxidants, like zinc and vitamin C, have a protective effect against the onset and progression of AMD. Vitamin E supplementation may be beneficial in Alzheimer's disease. However, there is no conclusive evidence to show that megadoses of vitamin E is beneficial in preventing aging, cataract, or coronary heart diseases. Vitamin E is recommended in persons consuming a diet high in polyunsaturated fatty acids, because they tend to form free radicals. Excessive intake of vitamin E may increase risk of bleeding.

### Recommended Daily Allowance

Males: 10 mg per day  
Females: 8 mg/day  
Pregnancy: 10 mg/day  
Lactation: 12 mg/day.

15 mg of vitamin E is equivalent to 33 international units. The requirement increases with higher intake of PUFA. Pharmacological dose is 200–400 IU per day.

### Sources of Vitamin E

**Vegetable oils** are rich sources of vitamin E; e.g. wheat germ oil, sunflower oil, safflower oil, cotton seed oil, etc. Fish liver oils are devoid of vitamin E.

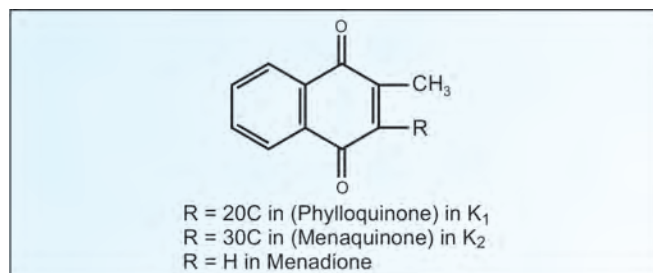
### Hypervitaminosis E

At doses above 1000 IU per day, it may cause tendency to hemorrhage, as it is a mild anti-coagulant.

## VITAMIN K

### Chemistry of Vitamin K

The letter “K” is the abbreviation of the German word “koagulation vitamin”. They are **naphthoquinone** derivatives, with a long isoprenoid side chain. The length of side chain will differ. Vitamin K<sub>1</sub> has 20C side chain (phylloquinone) (Fig. 36.14). Vitamin K<sub>2</sub> has a 30C side chain. Yet another structurally similar synthetic compound having vitamin K activity is **Menadione**. It is water soluble synthetic vitamin, widely used in clinical practice. Henrik Dam isolated vitamin K<sub>1</sub> in 1929, while Edward Doisy isolated vitamin K<sub>2</sub> in 1939. Both of them were awarded Nobel prize in 1943.



**Fig. 36.14:** Vitamin K



Henrik Dam  
NP 1943  
1895–1976



Edward Doisy  
NP 1943  
1893–1986

## Absorption and Storage

Absorption of vitamin K occurs in the intestine along with chylomicrons. Bile salts are required for the normal absorption. The vitamin K may be derived from the diet or intestinal bacterial synthesis. It is stored in the liver and transported in plasma along with beta lipoproteins.

## Biochemical Role of Vitamin K

- Vitamin K is necessary for coagulation. Factors dependent on vitamin K are Factor II (**prothrombin**); Factor VII (SPCA); Factor IX (Christmas factor); Factor X (Stuart Prower factor).
- All these factors are synthesized by the liver as inactive zymogens. They undergo **post-translational** modification; gamma carboxylation of glutamic acid residues. These are the binding sites for calcium ions. The **gamma carboxy glutamic acid (GCG)** synthesis requires vitamin K as a co-factor (Fig. 36.15).
- Vitamin K dependent gamma carboxylation is also necessary for the functional activity of osteocalcin as well as structural proteins of kidney, lung and spleen. **Osteocalcin** is synthesized by osteoblasts and seen only in bone. It is a small protein (40–50 amino acids length) that binds tightly to hydroxy apatite crystals of bone. This binding is dependent on the degree of gamma carboxylation. Osteocalcin also contains hydroxyproline, so it is dependent on both vitamins K and C. Moreover, vitamin D induces its synthesis.

## Vitamin K Dependent Carboxylase

It is microsomal enzyme. It requires oxygen, CO<sub>2</sub>, NADPH and reduced vitamin K. In this process, the vitamin passes through a cycle (Fig. 36.16). This process is competitively inhibited by **warfarin** and **dicoumarol**.

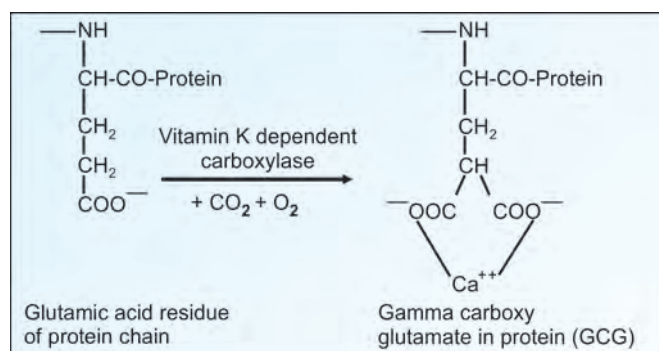


Fig. 36.15: Vitamin K as co-factor in GCG synthesis

## Causes for Deficiency of Vitamin K

In normal adults dietary deficiency seldom occurs since the intestinal bacterial synthesis is sufficient to meet the needs of the body. However, deficiency can occur in conditions of **malabsorption** of lipids. This can result from obstructive jaundice, chronic pancreatitis, sprue, etc. Prolonged **antibiotic** therapy and gastrointestinal infections with diarrhea will destroy the bacterial flora and can also lead to vitamin K deficiency.

## Clinical Manifestations of Deficiency

- Hemorrhagic disease of the newborn is attributed to vitamin K deficiency. The newborns, especially the **premature infants** have relative vitamin K deficiency. This is due to lack of hepatic stores, limited oral intake (breast milk has very low levels, 15 mg/liter) and absence of intestinal bacterial flora.
- It is often advised that preterm infants be given prophylactic doses of vitamin K (1 mg Menadione).
- In children and adults, Vitamin K deficiency may be manifested as bruising tendency, echymotic patches, mucous membrane hemorrhage, post-traumatic **bleeding** and internal bleeding.

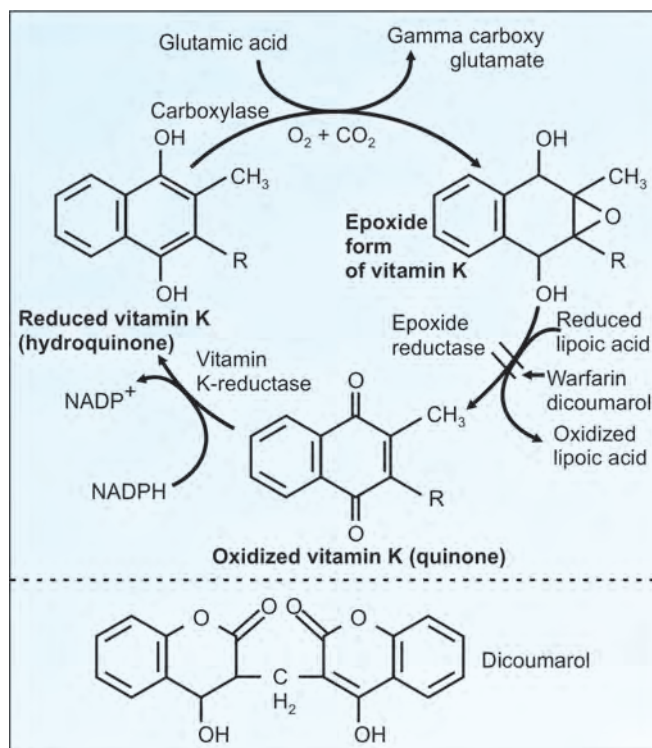


Fig. 36.16: Vitamin K cycle. Dicoumarol, a structural analog inhibits vitamin K reductase



- iv. Prolongation of prothrombin time and delayed clotting time are characteristic of vitamin K deficiency.
- v. Measurement of **prothrombin time** (PT) is taken as an index of liver function. When liver function is considerably lowered, prolongation of PT occurs due to deficient synthesis of the coagulation factors. In such cases, administration of vitamin fails to restore PT to normal levels. Hence before undertaking any surgery on jaundiced patients, PT before and after administration of vitamin K should be done.
- vi. **Warfarin** and **dicoumarol** will competitively inhibit the gamma carboxylation system due to structural similarity with vitamin K. Hence they are widely used as anticoagulants for therapeutic purposes.
- vii. Treatment of pregnant women with warfarin can lead to fetal bone abnormalities (**fetal warfarin syndrome**).

### Daily Requirement of Vitamin K

Recommended daily allowance is 50–100 mg/day. This is usually available in a normal diet.

### Sources of Vitamin K

**Green leafy vegetables** are good dietary sources. Even if the diet does not contain the vitamin, intestinal bacterial synthesis will meet the daily requirements, as long as absorption is normal.

### Hypervitaminosis K

Hemolysis, hyperbilirubinemia, kernicterus and brain damage are the manifestations of toxicity. Administration of large quantities of menadione may result in toxicity. This should be kept in mind in treating premature babies.

### Clinical Case Study 36.1

A 6-year-old child was brought to the hospital with complaints of slow growth and pain in bones. On examination, he was anemic, had frontal bossing, bowing of legs and swelling of costochondral junction. Laboratory results were: Serum calcium—8.2 mg/dL, serum phosphorus—2.8 mg/dL and serum ALP—720 U/L. What is the likely diagnosis?

### Clinical Case Study 36.1 Answer

Interpretation: Rickets.

Tests: Vitamin D, Calcium.

Vitamin D functions as both as vitamin and prohormone. Low levels of vitamin D are associated with increased

mortality; excess as well as deficiency of vitamin D causes premature aging. Low vitamin D levels are associated with osteomalacia, rickets, falls and low bone mineral density. Lower vitamin D levels also seem to be correlated with some cancers, bronchial asthma, heart palpitations, multiple sclerosis, infections and neurodegenerative diseases. Serum 25hydroxy vitamin D levels also have to be maintained for bone and overall health.

### QUICK LOOK OF CHAPTER 36

1. Vitamin A is a fat-soluble vitamin whose active form is present only in animal tissues, but provitamin A (beta carotene) is present in plant tissues.
2. Retinols are poly isoprenoid compounds with Vitamin A activity, having the  $\beta$  ionone ring system.
3. Active forms of the vitamin A include; Retinol, Retinal, Retinoic acid. The two important isomers are all trans-retinal and 11-cis retinal.
4. Vitamin A is transported with the help of Retinal Binding Protein and this retinal–RBP complex has specific receptors in various tissues.
5. Rhodopsin is a membrane protein made up of opsin plus 11-cis-retinal and it is important in the visual cycle.
6. Rods are for dim light vision and cones for color vision.
7. Decrease in number of cones/cone proteins lead to color blindness.
8. Vitamin D is derived from 7 dehydrocholesterol by the action of UV rays.
9. Vitamin D deficiency results in rickets and osteomalacia. Different types of rickets are; hypophosphatemic, vitamin D resistant, renal rickets, and end organ refractoriness to 1,25 DHCC.
10. Vitamin E is tocopherol. It is absorbed along with fats with the help of bile salts. It is transported as chylomicrons and stored in adipose tissue.
11. Vitamin E is the most important antioxidant in tissues.
12. Vitamin K compounds are naphthoquinone derivatives. They are absorbed in intestine along with chylomicrons. They are also synthesized by intestinal flora. Storage is in the liver and transported in plasma is along with beta lipoproteins.
13. Vitamin K is involved in blood coagulation. Vitamin K is required for post-translational modification of coagulation factors.

# CHAPTER 37

## Water Soluble Vitamins - 1 (Thiamine, Riboflavin, Niacin, Pyridoxine, Pantothenic acid, Biotin)

### Chapter at a Glance

The reader will be able to answer questions on the following topics:

- Thiamine (Vitamin B<sub>1</sub>)
- Riboflavin (Vitamin B<sub>2</sub>) and FAD
- Niacin, NAD<sup>+</sup> and NADP<sup>+</sup>
- Pyridoxine (Vitamin B<sub>6</sub>)
- Pantothenic acid and co-enzyme A
- Biotin

### Complex Group of Vitamins

These vitamins are chemically not related to one another. They are grouped together because all of them function in the cells as co-enzymes. The important members of vitamin B complex group are thiamine, riboflavin, niacin, pyridoxine, pantothenic acid, biotin, folic acid and vitamin B<sub>12</sub>. In old literature, a few more members such as Choline, Inositol, Lipoic acid and para amino benzoic acid (PABA) were also included in this group. Although they have important functions inside the body, they cannot be considered as vitamins, because they are available in plenty. PABA is not a vitamin for higher species, but it is required by bacteria for synthesis of folic acid.

### THIAMINE (VITAMIN B<sub>1</sub>)

Thiamine is also called as vitamin B<sub>1</sub> (Box 37.1). In old literature, it is designated as Aneurine (it can relieve neuritis) or antiberberi factor. In 1900, Christian Eijkman produced beriberi in chicken by feeding polished rice (Nobel Prize, 1929). Adolf Windaus (Nobel Prize, 1928) elucidated the structure of the vitamin.

#### Box 37.1: Thiamine and thymine are different

**THYMINE** is the base present in DNA.  
**THIAMINE** is vitamin B<sub>1</sub>.

### Sources

Aleurone layer of cereals (food grains) is a rich source of thiamine. Therefore, whole wheat flour and unpolished handpound rice have better nutritive value than completely polished refined foods. When the grains are polished, aleurone layer is usually removed. Yeast is also a very good source. Thiamine is partially destroyed by heat.

### Structure of Thiamine

Thiamine contains a substituted **pyrimidine** ring connected to a substituted thiazole ring by means of methylene bridge. The vitamin is then converted to its active co-enzyme form by addition of two phosphate groups, with the help of ATP (Fig. 37.1). It is catalyzed by thiamine pyrophospho transferase.

### Physiological Role of Thiamine

- i. **Pyruvate dehydrogenase:** The co-enzyme form is **thiamine pyrophosphate** (TPP). It is used in oxidative decarboxylation of alpha keto acids, e.g.

pyruvate dehydrogenase catalyzes the breakdown of pyruvate, to acetyl CoA, and carbon dioxide (see Fig. 9.22).

- ii. **Alpha ketoglutarate dehydrogenase:** An analogous biochemical reaction that requires TPP is the oxidative decarboxylation of **alpha ketoglutarate** to succinyl CoA and CO<sub>2</sub> (See citric acid cycle, Fig.19.2).
- iii. **Transketolase:** The second group of enzymes that use TPP as co-enzyme are the transketolases, in the hexose monophosphate shunt pathway of glucose (see Fig. 10.3).
- iv. The main role of thiamine (TPP) is in **carbohydrate** metabolism. So, the requirement of thiamine is increased along with higher intake of carbohydrates.

## Deficiency Manifestations of Thiamine

- A. **Beriberi:** Deficiency of thiamine leads to beriberi. It is a Sinhalese word, meaning “weakness”. The early symptoms are anorexia, dyspepsia, heaviness and weakness. Subjects feel weak and get easily exhausted.
- B. **Wet beriberi:** Here cardiovascular manifestations are prominent. Edema of legs, face, trunk and serous cavities are the main features. Palpitation, breathlessness and distended neck veins are observed. Death occurs due to heart failure.

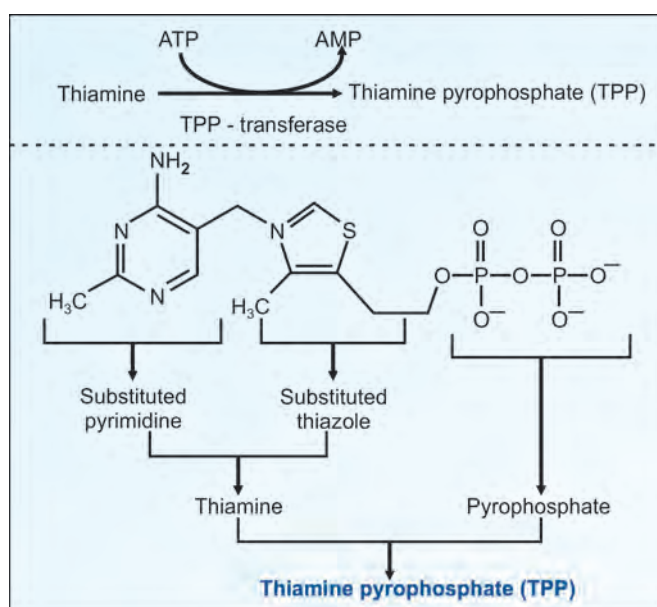


Fig. 37.1: Structure of thiamine pyrophosphate

- C. **Dry beriberi:** In this condition, CNS manifestations are the major features. Walking becomes difficult. Peripheral neuritis with sensory disturbance leads to complete paralysis.
- D. **Infantile beriberi:** It occurs in infants born to mothers suffering from thiamine deficiency. Restlessness and sleeplessness are observed.
- E. **Wernicke-Korsakoff syndrome:** It is also called as **cerebral beriberi**. Carl Wernicke in 1894 and Sergiei Sergievich Korsakoff in 1887 described the condition. Clinical features are those of encephalopathy (ophthalmoplegia, nystagmus, cerebellar ataxia) plus psychosis. It is seen only when the nutritional status is severely affected.
- F. **Polyneuritis:** It is common in chronic alcoholics. Alcohol utilization needs large doses of thiamine. Alcohol inhibits intestinal absorption of thiamine, leading to thiamine deficiency. Polyneuritis may also be associated with pregnancy and old age. Thiamine deficiency in alcoholism may cause impairment of conversion of pyruvate to acetyl CoA. The result is increased plasma concentration of pyruvate and lactate, leading to **lactic acidosis**.

## Biochemical Parameters

In thiamine deficiency, blood thiamine is reduced, but pyruvate, alpha ketoglutarate and lactate are increased. Erythrocyte **transketolase** activity is reduced; this is the earliest manifestation seen even before clinical disturbances.

Erythrocyte transketolase levels may be reduced in comatose patients, alcoholics, chronic renal failure, malnutrition as well as in elderly patients. Many in intensive care units may suffer from low thiamine levels; in which case thiamine supplementation should benefit those patients. A lipid soluble acylated derivative (benfotiamine) is now being recommended for diabetic patients to decrease glycation of proteins (AGE) and to improve diabetic neuropathy.



Christiaan  
Eijkman  
NP 1929  
1858–1930

Adolf Otto  
Windaus  
NP 1928  
1876–1959

Axel Hugo  
Theorell  
NP 1955  
1903–1982

Otto  
Warburg  
NP 1931  
1883–1970

## Recommended Daily Allowance of Thiamine

It depends on calorie intake (0.5 mg/1000 calories). Requirement is 1–1.5 mg/day. Thiamine is useful in the treatment of beriberi, alcoholic polyneuritis, neuritis of pregnancy and neuritis of old age.

## RIBOFLAVIN (VITAMIN B<sub>2</sub>)

Lactoflavin (milk), hepatoflavin (liver) and oboflavin (eggs) are chemically identical to riboflavin. Riboflavin was the first B complex component to be isolated in a pure state. This vitamin is synthesized by green plants and microorganisms. Warburg, (Nobel prize 1931), isolated the “yellow enzyme” of cellular respiration. Later Axel Theorell (Nobel prize, 1955) isolated riboflavin. In 1935, Paul Karrer (Nobel prize, 1937) determined the structure.

### Structure of Riboflavin

Riboflavin has a dimethyl isoalloxazine ring to which a ribitol is attached (Fig. 37.2). Ribitol is the alcohol of ribose sugar. Riboflavin is converted to its active co-enzyme forms (FMN and FAD) with the help of ATP (Fig. 37.4). Riboflavin is heat stable.

### Co-enzyme Activity of Riboflavin

Riboflavin exists in tissues tightly bound (but not covalently) with enzymes. Enzymes containing riboflavin are called **flavoproteins**. The two co-enzymes are **FMN** (flavin mono nucleotide) and **FAD** (flavin adenine dinucleotide) (Fig. 37.4).

### FAD Accepts Hydrogen

During the oxidation process, FAD accepts two hydrogen atoms from substrate. In turn, FAD is reduced to FADH<sub>2</sub>. The two nitrogen atoms of isoalloxazine nucleus accept the hydrogen atoms (Fig. 37.3).

### FMN-dependent Enzymes

- During the **amino acid oxidation**, FMN is reduced. It is reoxidized by molecular oxygen to produce hydrogen peroxide (see Fig.15.10).

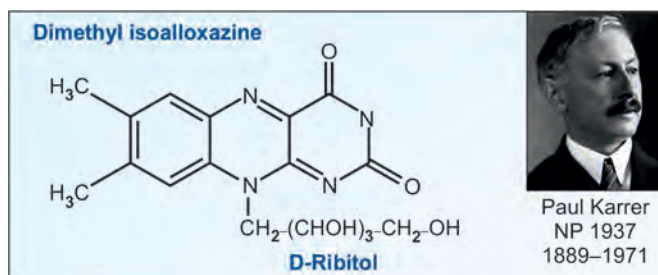


Fig. 37.2: Riboflavin structure

- In the **respiratory chain**, the NADH dehydrogenase contains FMN. The electrons are transported in the following manner (see Chapter 20):



### FAD-dependent Enzymes

These are enumerated in Box 37.2. FADH<sub>2</sub> when oxidized in the electron transport chain will generate 1.5 ATP molecules (see Chapter 20).

### Riboflavin Deficiency

- Causes:** Natural deficiency of riboflavin in man is uncommon, because riboflavin is synthesized by the

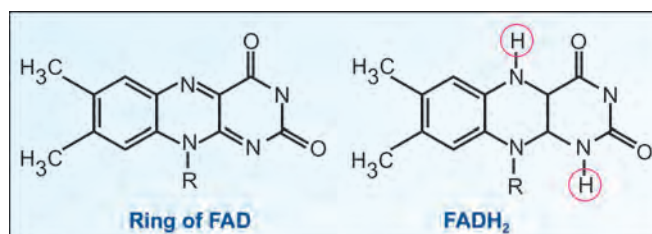


Fig. 37.3: Acceptance of hydrogen by FAD

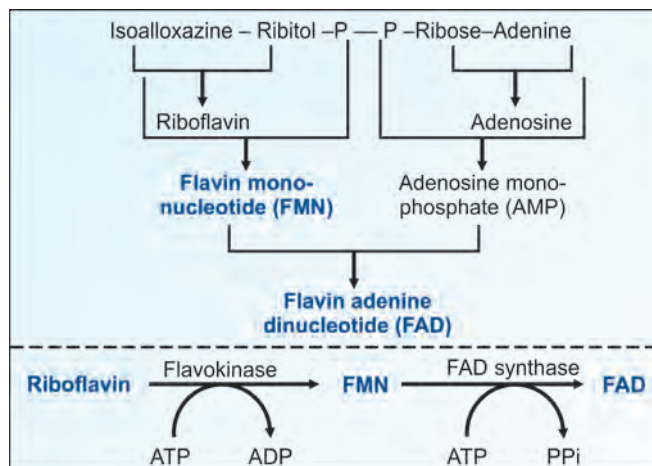


Fig. 37.4: Co-enzymes FMN and FAD

### Box 37.2: FAD-dependent enzymes

- Succinate to fumarate by succinate dehydrogenase (see Fig. 19.2, step 6).
- Acyl CoA to alpha-beta unsaturated acyl CoA by acyl CoA dehydrogenase (see Fig. 12.9, step 1).
- Xanthine to uric acid by xanthine oxidase (see Chapter 43).
- Pyruvate to acetyl coa by pyruvate dehydrogenase (see Fig. 9.22).
- Alpha ketoglutarate to succinyl CoA by alpha ketoglutarate dehydrogenase (see Fig.19.2, step 4).



intestinal flora. Riboflavin deficiency usually accompanies other deficiency diseases such as beriberi, pellagra and Kwashiorkor.

- b. **Manifestations:** Symptoms are confined to skin and mucous membranes.
- Glossitis** (Greek, glossa = tongue)
  - Magenta colored tongue
  - Cheilosis** (Greek, cheilos = lip)
  - Angular stomatitis** (inflammation at the corners of mouth)
  - Circumcorneal vascularization
  - Proliferation of the bulbar conjunctival capillaries is the earliest sign of riboflavin deficiency.

### Dietary Sources of Riboflavin

Rich sources are liver, dried yeast, egg and whole milk. Good sources are fish, whole cereals, legumes and green leafy vegetables.

### Daily Requirement

Riboflavin is concerned mainly with the metabolism of **carbohydrates** and requirement is related to calorie intake. Adults on sedentary work require about 1.5 mg per day. During pregnancy, lactation and old age, additional 0.2 to 0.4 mg/day are required.

## NIACIN

Niacin and Nicotinic acid are synonyms. It is also called as Pellagra preventing factor of Goldberger. The term nicotinic acid should not be confused with nicotine. Nicotinic acid is a vitamin; but, nicotine is the potent poison from tobacco. Niacinamide is the active form of the vitamin, present in tissues. Warburg (Nobel Prize, 1931) elucidated the structure of NAD<sup>+</sup> and Alexander Todd (Nobel prize 1957) demonstrated its function. It was originally named as co-enzyme-I, which was later designated as DPN (diphospho pyridine nucleotide), and finally in 1965 as NAD<sup>+</sup>.

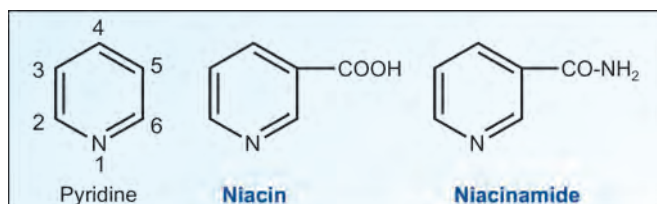


Fig. 37.5: Structure of niacin

### Chemistry of Niacin

Niacin is pyridine-3-carboxylic acid. Niacinamide is the acid amide (Fig. 37.5). In NAD<sup>+</sup> or NADP<sup>+</sup>, the reactive site is the carbon atom 4 and the nitrogen atom of the nicotinamide ring. (See numbering in Figure 37.5). The co-enzyme is bound to the apo-enzyme.

### Co-enzyme Forms of Niacin

Niacin is converted to its co-enzyme forms, viz, Nicotinamide adenine dinucleotide (NAD<sup>+</sup>) and Nicotinamide adenine dinucleotide phosphate (NADP<sup>+</sup>). The niacin is attached to a ribose phosphate to form a mononucleotide. It is then attached to AMP, to form the dinucleotide (Fig. 37.6).

The nitrogen atom of niacinamide contains **one positive charge**. The structure is abbreviated as NAD<sup>+</sup>. (The +ve sign is always shown). In the case of NADP<sup>+</sup>, one more phosphoric acid is attached to the ribose of the AMP (see the asterisk in Figure 37.6).

### One Hydrogen Atom and One Electron

- In the oxidized form, nitrogen of the nicotinamide residue has a positive charge. Hence the oxidized form of co-enzyme is usually written as NAD<sup>+</sup>.
- In the process of reduction, NAD<sup>+</sup> accepts one hydrogen atom fully. The other hydrogen is ionized. Only the electron is accepted (Fig. 37.7). See the positive sign in the molecule is removed.



Thus NAD<sup>+</sup> accepts one H atom and one e<sup>-</sup> (electron), to form NADH. The hydrogen ion (H<sup>+</sup>) is released

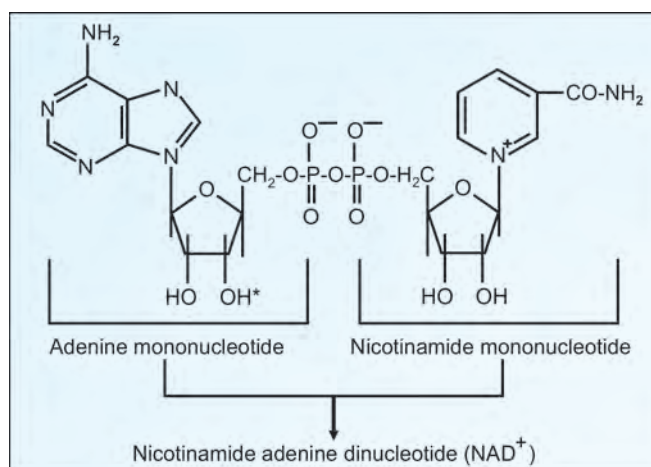


Fig. 37.6: Structure of NAD<sup>+</sup> (In the case of NADP<sup>+</sup> phosphoric acid residue is attached to the hydroxyl group marked with asterisk)

into the surrounding medium. During the oxidation of NADH, the reaction is reversed (Fig. 37.7).

## NAD<sup>+</sup> Dependent Enzymes

They are so many, that an exhaustive listing is not attempted. A few examples are given in Box 37.3.

One NADH molecule is oxidized in the respiratory chain to generate 2 ½ ATPs. (See Chapter 20 for details). But NADPH is used almost exclusively for reductive biosynthetic reactions.

## NADPH Dependent Reactions

The NADPH generating reactions are shown in Box 37.4. A few examples of NADPH utilizing enzymes are shown in Box 37.5. Some enzymes can use either NAD<sup>+</sup> or NADP<sup>+</sup> as co-enzyme, e.g. glutamate dehydrogenase.

In addition to this co-enzyme role, NAD<sup>+</sup> is the source of ADP-ribose for the **ADP-ribosylation** of proteins and poly-ADP-ribosylation of nucleoproteins.

## Niacin Deficiency

### Pellagra

Deficiency of niacin leads to the clinical condition called pellagra. Pellagra is an Italian word, meaning “rough skin”. Pellagra is caused by the deficiency of Tryptophan as well

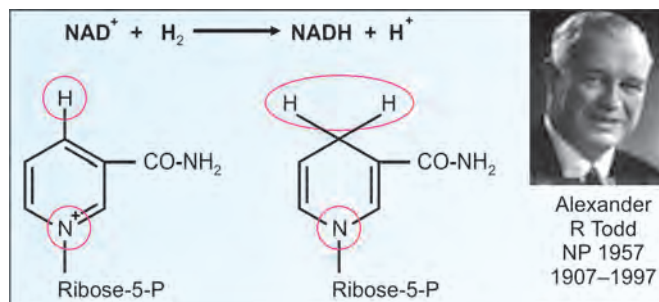


Fig. 37.7: Acceptance of hydrogen

### Box 37.3: NAD<sup>+</sup> dependent enzymes

1. Lactate dehydrogenase (lactate → pyruvate) (see Fig. 9.14)
2. Glyceraldehyde-3-phosphate dehydrogenase (glyceraldehyde-3-phosphate → 1,3-bisphosphoglycerate) (see Fig.9.10)
3. Pyruvate dehydrogenase (pyruvate → acetyl CoA) (see Fig.9.22)
4. Alpha ketoglutarate dehydrogenase (alpha ketoglutarate → succinyl CoA) (see Fig.19.2)
5. Beta hydroxyacyl CoA dehydrogenase (beta hydroxyacyl CoA → beta ketoacyl CoA) (see Step 3, Fig.12.9)
6. Glutamate dehydrogenase (Glutamate → alpha ketoglutarate) (see Fig.15.9)

as Niacin. Pellagra is seen more in women; this may be because tryptophan metabolism is inhibited by estrogen metabolites. The symptoms of pellagra are:

- Dermatitis:** In early stages, bright red erythema occurs, especially in the feet, ankles and face (Fig. 37.8A). Increased pigmentation around the neck is known as **Casal's necklace**. The dermatitis is precipitated by exposure to sunlight (Fig. 37.8B).
- Diarrhea:** The diarrhea may be mild or severe with blood and mucus. This may lead to weight loss. Nausea and vomiting may also be present.
- Dementia:** It is frequently seen in chronic cases. Delirium is common in acute pellagra. Irritability, inability to concentrate and poor memory are more common in mild cases. Ataxia, and spasticity are also seen.

### Niacin is Synthesized from Tryptophan

For details see under tryptophan metabolism in Chapter 18. Quinolate phosphoribosyl transferase is the rate limiting

### Box 37.4: NADPH generating reactions

1. Glucose-6-phosphate dehydrogenase in the hexose monophosphate shunt pathway (Glucose-6-phosphate → 6-phospho-glucono lactone) (see Fig. 10.1)
2. 6-phospho gluconate dehydrogenase in the shunt pathway (6-phospho gluconate → 3-keto-6-phospho gluconate) (see Fig.10.1).
3. Cytoplasmic isocitrate dehydrogenase
4. Malic enzyme (malate to pyruvate).

### Box 37.5: NADPH utilizing reactions

1. Ketoacyl-ACP dehydrogenase (Beta-ketoacyl-ACP → beta hydroxy acyl ACP) (see Step 4, Fig.12.15)
2. Alpha, beta unsaturated acyl ACP → acyl ACP (see Step 6, Fig.12.15)
3. HMG CoA reductase (HMG CoA → mevalonate) (see Fig.13.2)
4. Met-hemoglobin → hemoglobin
5. Folate reductase (Folate → dihydrofolate → tetrahydrofolate) (see Fig.38.2)
6. Phenyl alanine hydroxylase (Phenylalanine → tyrosine) (see Fig.18.1).



Fig. 37.8: Niacin deficiency; (A) shows early signs; (B) depicts advanced skin lesions

enzyme in the conversion of niacin to  $\text{NAD}^+$ . About 60 mg of tryptophan is equivalent to 1 mg of niacin.

### Causes for Niacin Deficiency

- i. **Dietary deficiency of tryptophan:** Pellagra is seen among people whose staple diet is maize (South and Central America). In **maize**, niacin is present; but it is in a bound form, and is unavailable. Pellagra is also seen when staple diet is **sorghum** (jowar or guinea corn) as in Central and Western India. Sorghum, contains leucine in high quantities. Leucine inhibits the QPRT enzyme, and so niacin cannot be converted to  $\text{NAD}^+$  (Leucine pellagra).
- ii. **Deficient synthesis:** Kynureninase, an important enzyme in the pathway of tryptophan, is pyridoxal phosphate dependent. So conversion of tryptophan to niacin is not possible in pyridoxal deficiency.
- iii. **Isoniazid (INH):** It is an antituberculous drug, which inhibits pyridoxal phosphate formation. Hence, there is block in conversion of tryptophan to  $\text{NAD}^+$ .
- iv. **Hartnup disease:** Tryptophan absorption from intestine is defective in this congenital disease. Moreover, tryptophan is excreted in urine in large quantities. This leads to lack of tryptophan and consequently deficiency of nicotinamide.
- v. **Carcinoid syndrome:** The tumor utilizes major portion of available tryptophan for synthesis of serotonin; so tryptophan is unavailable.

### Dietary Sources of Niacin

The richest natural sources of niacin are dried yeast, rice polishing, liver, peanut, whole cereals, legumes, meat and fish. About half of the requirement is met by the conversion of tryptophan to niacin. About 60 mg of tryptophan will yield 1 mg of niacin.

### Recommended Daily Allowance (RDA)

Normal requirement is 20 mg/day. During lactation, additional 5 mg is required.

### Therapeutic Use of Niacin

Nicotinic acid inhibits the flux of free fatty acids from adipose tissue; so acetyl CoA pool is reduced; and hence serum **cholesterol** is lowered. In high doses niacin is useful to reduce Lp(a) levels.

### Toxicity of Niacin

Nicotinic acid when given orally or parenterally produces a transient vasodilatation of the cutaneous vessels and **histamine release**. The reaction is accompanied by itching, burning and tingling. Intake of nicotinic acid in excess of 50 mg/day may lead to liver damage.

## VITAMIN B<sub>6</sub>

### Co-enzyme Form

Vitamin B<sub>6</sub> is the term applied to a family of 3 related pyridine derivatives; **pyridoxine** (alcohol), **pyridoxal** (aldehyde) and **pyridoxamine** (Fig. 37.9). Active form of pyridoxine is **pyridoxal phosphate (PLP)** (Fig. 37.9). It is synthesized by pyridoxal kinase, utilizing ATP.

Main supply of B<sub>6</sub> compounds in food is in the form of pyridoxine which can be readily converted to pyridoxal and pyridoxamine in the body. Richard Kuhn (Nobel prize 1938) did the isolation and structural analysis.

### Functions of Pyridoxal Phosphate

The pyridoxal phosphate (PLP) acts as co-enzyme for many reactions in **amino acid** metabolism (Box 37.6).

#### Box 37.6: Functions of thiamine and pyridoxine

**Thiamine** pyrophosphate is involved in carbohydrate metabolism.  
**Pyridoxal** phosphate is involved in protein metabolism.

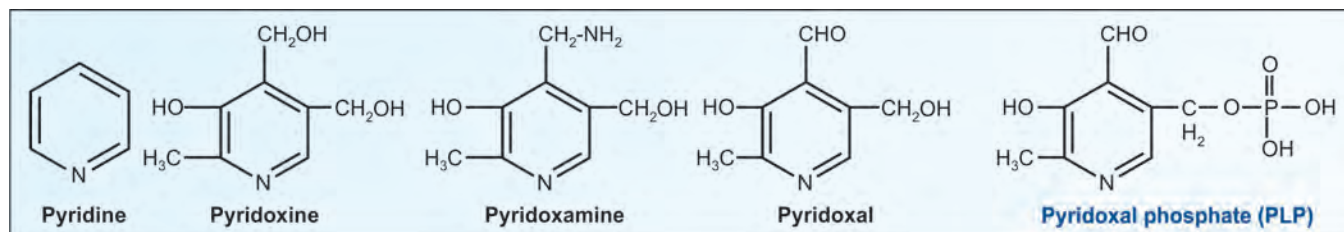


Fig. 37.9: Structure of B<sub>6</sub> related compounds

### Transamination

These reactions are catalyzed by amino transferases (transaminases) which employ PLP as the co-enzyme (see Fig. 15.8). For example:

Alanine + Alpha ketoglutarate → Pyruvate + Glutamic acid (Enzyme Alanine transaminase)

The clinical significance of blood levels of transaminases is given in Chapter 23.

### Decarboxylation

All decarboxylation reactions of amino acids require PLP as co-enzyme. A few examples are given below:

- i. Glutamate → GABA (gamma amino butyric acid) (see Fig.17.2). GABA is an inhibitory neurotransmitter, and hence in B<sub>6</sub> deficiency, especially in children, **convulsions** may occur.
- ii. Histidine → Histamine, which is the mediator of **allergy** and anaphylaxis (see Fig.18.14).
- iii. 5-hydroxy tryptophan → Serotonin (see Fig.18.10).
- iv. Cysteine → Taurine (see Fig.16.22).
- v. Serine → Ethanol amine (see Fig.16.12).

### Sulfur Containing Amino Acids

The PLP plays an important role in methionine and cysteine metabolism. For details see Chapter 16.

- a. Homocysteine + Serine → Cystathionine. (Enzyme Cystathionine synthase) (see Fig.16.15)
- b. Cystathionine → Homoserine + Cysteine (Enzyme Cystathionase).

Both these reactions require PLP. Hence in vitamin B<sub>6</sub> deficiency **homocysteine** in blood is increased. Homocysteine level is correlated with **myocardial infarction**. Therefore, pyridoxine is used in clinical practice to prevent coronary artery disease in hyper-homocysteinemia.

### Heme Synthesis

The ALA synthase is a PLP dependent enzyme. This is the rate limiting step in heme biosynthesis (see Fig.21.4). So, in B<sub>6</sub> deficiency, **anemia** may be seen.

### Production of Niacin

Thus pyridoxal phosphate is required for the synthesis of niacin from tryptophan (**one vitamin is necessary for synthesis of another vitamin**) (see Fig.18.8).

3-hydroxy kynurenine → 3-hydroxy anthranilic acid (Enzyme Kynureninase)

Kynureninase is a PLP dependent enzyme. Hence in vitamin B<sub>6</sub> deficiency niacin production is less. Moreover, kynurenine cannot be converted further, which is metabolized to xanthurenic acid and excreted through urine.

### Glycogenolysis

**Phosphorylase** enzyme (glycogen to glucose-1-phosphate) requires PLP. In fact, more than 70% of total PLP content of the body is in muscles, where it is a part of the phosphorylase enzyme.

## Deficiency Manifestations of Pyridoxine

### Neurological Manifestations

In vitamin B<sub>6</sub> deficiency, PLP dependent enzymes function poorly. So, serotonin, epinephrine, noradrenalin and gamma amino butyric acid (GABA) are not produced properly. **Neurological** symptoms are therefore quite common in B<sub>6</sub> deficiency. In children, B<sub>6</sub> deficiency leads to convulsions due to decreased formation of **GABA**. PLP is involved in the synthesis of sphingolipids; so B<sub>6</sub> deficiency leads to demyelination of nerves and consequent **peripheral neuritis**. This is reversible with high doses of B<sub>6</sub>.

### Dermatological Manifestations

Deficiency of B<sub>6</sub> will also affect tryptophan metabolism. Since niacin is produced from tryptophan, B<sub>6</sub> deficiency in turn leads to niacin deficiency, which is manifested as **pellagra**.

### Hematological Manifestations

In adults, hypochromic microcytic **anemia** may occur due to the inhibition of heme biosynthesis. Impaired antibody formation is also reported.

The metabolic disorders which respond to vitamin B<sub>6</sub> therapy are **xanthurenic aciduria** and **homocystinuria**.

### Assay of Vitamin B<sub>6</sub>

Vitamin B<sub>6</sub> status is assayed by the activation of erythrocyte transaminases by addition of pyridoxal phosphate in the reaction mixture.

### Effect of Drugs on Vitamin B<sub>6</sub>

- i. **INH**: Isonicotinic acid hydrazide (isoniazid) is an antituberculosis drug. It inhibits pyridoxal kinase; reduces the formation of PLP and causes vitamin B<sub>6</sub> deficiency.



- ii. **Cycloserine:** It acts as B<sub>6</sub> antagonist.
- iii. **Oral contraceptives:** Mild vitamin B<sub>6</sub> deficiency may be seen in women taking oral contraceptive pills.
- iv. **Ethanol:** B<sub>6</sub> deficiency neuritis is quite common in alcoholics.

### Dietary Sources of Vitamin B<sub>6</sub>

Rich sources are yeast, rice polishing, wheat germs, cereals, legumes (pulses), oil seeds, egg, milk, meat, fish and green leafy vegetables.

### Requirement of B<sub>6</sub>

Vitamin B<sub>6</sub> requirements are related to **protein intake** and not to calorie intake (Box 37.6). It is recommended that adults need 1 to 2 mg/day. During pregnancy and lactation, the requirement is increased to 2.5 mg/day.

### Toxicity of Vitamin B<sub>6</sub>

Doses over 100 mg may lead to **sensory neuropathy**. Further excess is manifested by imbalance, numbness, muscle weakness and nerve damage.

### ■ PANTOTHENIC ACID

The Greek word “pantos” means everywhere. As the name suggests, it is widely distributed in nature. Pantothenic acid contains beta alanine and D-pantoic acid in amide linkage (Fig. 37.10). Lipmann discovered CoA in 1946, (Nobel prize in 1953).

#### Structure

Synthesis of CoA is shown in Figure 37.11; it needs the expenditure of 4 high energy bonds. Pantothenic acid and beta mercaptoethanol amine are parts of co-enzyme A (CoA) (Fig. 37.12). The CoA is a nucleotide.

### Co-enzyme Activity of Pantothenic Acid

- i. The beta mercaptoethanol amine (NH<sub>2</sub>-CH<sub>2</sub>-CH<sub>2</sub>-SH) contains one thiol or **sulfhydryl** (-SH) group. It is the

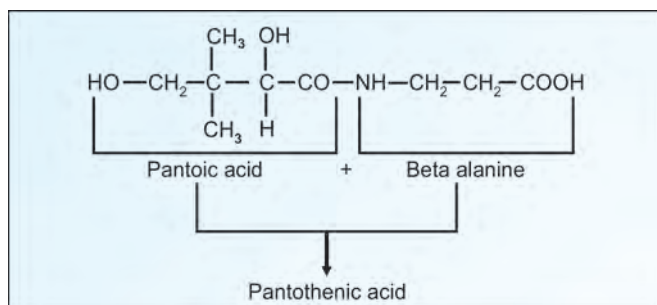


Fig. 37.10: Structure of pantothenic acid

active site where acyl groups are carried. Therefore, co-enzyme A is sometimes abbreviated as CoA-SH to denote this active site.

- ii. The thio ester bond in acyl-CoA is a high energy bond. These acyl groups are transferred to other acceptors, for example:  
Acetyl CoA + Choline → Acetylcholine + CoA  
(enzyme is acetylcholine synthase)
- iii. Acyl groups are also accepted by CoA molecule during the metabolism of other substrates, for example:  
Pyruvate + CoA + NAD<sup>+</sup> → AcetylCoA + CO<sub>2</sub> + NADH  
(Enzyme is pyruvate dehydrogenase)
- iv. The important CoA derivatives are:
  - a. Acetyl CoA
  - b. Succinyl CoA
  - c. HMG CoA
  - d. Acyl CoA.

The reactions of acetyl CoA and succinyl CoA are summarized in Figure 37.13

- v. Co-enzyme A is an important component of fatty acid synthase complex. The ACP (acyl carrier protein) also contains pantothenic acid.

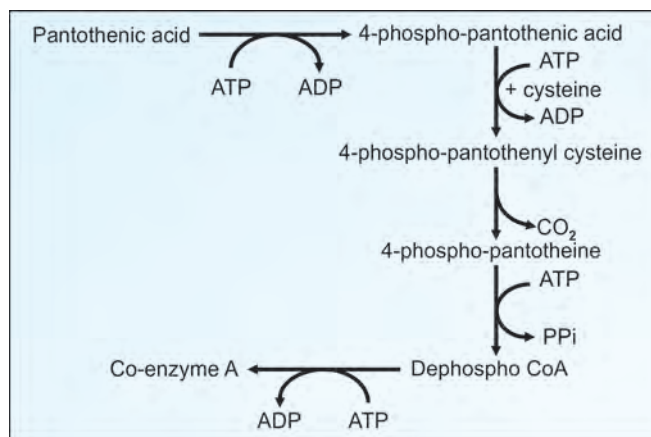


Fig. 37.11: Synthesis of CoA

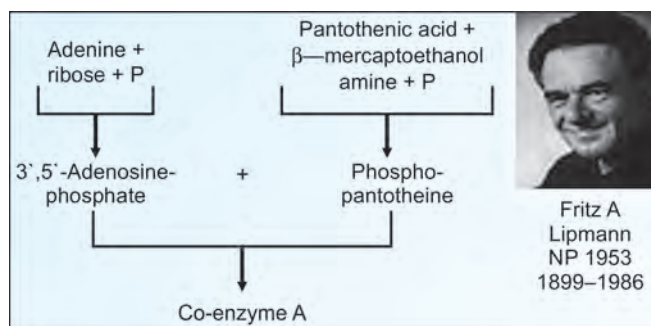


Fig. 37.12: Structure of Co-enzyme A (CoA)

### Deficiency of Pantothenic Acid

Gopalan's **Burning Foot Syndrome** is manifested as paresthesia (burning, lightning pain) in lower extremities, staggering gait due to impaired coordination and sleep disturbances.

These deficiency manifestations are rare in human beings. The syndrome is seen during famine, in prison camps, in chronic alcoholics and in some renal dialysis patients.

In experimental animals, deficiency has resulted in anemia (due to reduced heme synthesis from succinyl CoA), reduced steroidogenesis (due to lack of acetyl CoA), dermatitis, fatty liver and adrenal necrosis.

### Sources of Pantothenic Acid

It is widely distributed in plants and animals. Moreover, it is synthesized by the normal bacterial flora in intestines. Therefore, deficiency is very rare. Yeast, liver and eggs are good sources.



Dr C Gopalan, Founder Director of the National Institute of Nutrition, Hyderabad, and former Director General of Indian Council of Medical Research, New Delhi, reported the Burning Foot Syndrome, among the war refugees, in 1946.

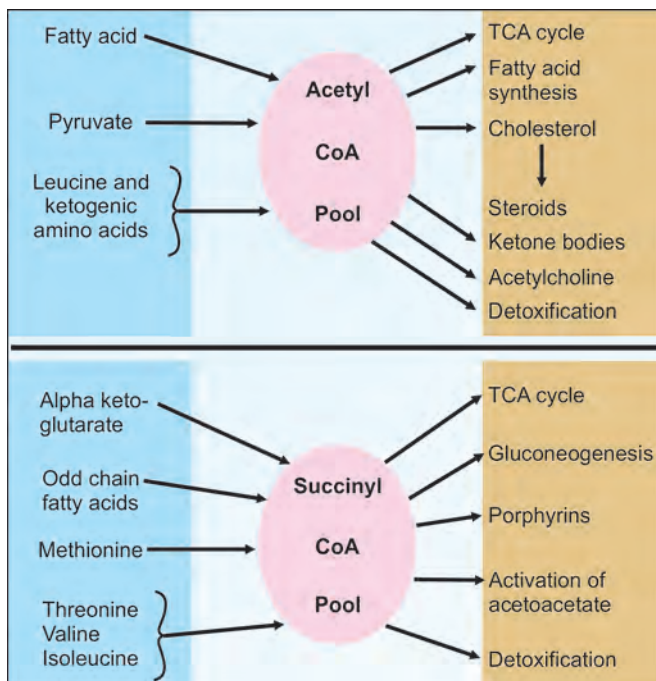


Fig. 37.13: Important reactions of CoA derivatives

### Requirement of Pantothenic Acid

RDA is assumed to be about 10 mg/day.

### BIOTIN

In old literature Biotin was known as anti-egg white injury factor. Biotin was isolated in 1942 by Vincent du Vigneaud, who was awarded Nobel prize in 1955.

### Structure of Biotin

It consists of an imidazole ring fused with a thiophene ring with a valeric acid side chain (Fig. 37.14). The carboxyl group forms an amide linkage with the epsilon nitrogen of a lysine residue in the apo-enzyme.

### Co-enzyme Activity of Biotin

Biotin acts as co-enzyme for **carboxylation reactions**. Biotin captures a molecule of CO<sub>2</sub> which is attached to nitrogen of the biotin molecule (Fig. 37.14). The energy required for this reaction is provided by ATP. Details of the reaction are given in Figure 37.15. Then the activated carboxyl group is transferred to the substrate.

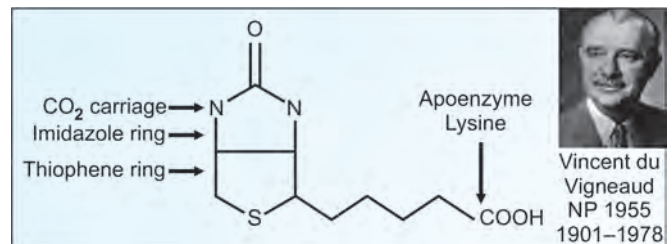


Fig. 37.14: Structure of biotin

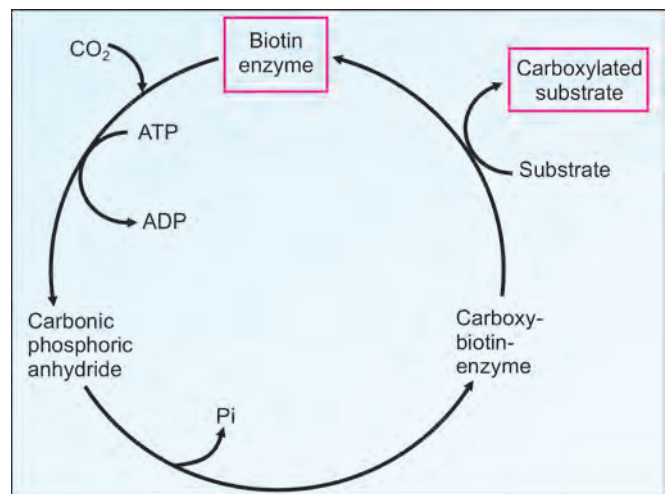
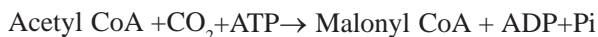


Fig. 37.15: Biotin helps in carboxylation reactions

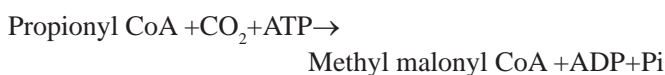
## Biotin Requiring CO<sub>2</sub> Fixation Reactions

### Acetyl CoA carboxylase

This enzyme adds CO<sub>2</sub> to acetyl CoA to form malonyl CoA. This is the rate limiting reaction in biosynthesis of fatty acids (see Step 1, Fig. 12.15).



### Propionyl CoA Carboxylase



(see Step 1, Fig. 12.11)

### Pyruvate Carboxylase

Pyruvate + CO<sub>2</sub> + ATP → Oxaloacetate + ADP + Pi (see Fig. 9.24). This is important in two aspects. One, it provides the oxaloacetate, which is the catalyst for TCA cycle. Second, it is an important enzyme in the gluconeogenic pathway.

## Biotin-Independent Carboxylation Reactions

- Carbamoyl phosphate synthetase, which is the stepping stone for urea and pyrimidine synthesis (see Step 1, Fig. 15.13).
- Addition of CO<sub>2</sub> to form C6 in purine ring
- Malic enzyme, converting pyruvate to malate.

## Biotin Antagonists

- Avidin**, a protein present in **egg white** has great affinity to biotin. Hence intake of raw (unboiled) egg may cause biotin deficiency. Biotin was originally named as anti-egg-white-injury-factor.

- Avidin is heat labile, and boiling of egg will neutralize the inhibitory activity. One molecule of avidin can combine with four molecules of biotin. Egg white contains avidin and egg yolk contains biotin.
- The affinity of avidin to biotin is greater than most of the usual antigen-antibody reactions. Therefore, avidin-biotin system is commonly utilized for detection of pathogens by **ELISA**.
- DNA is generally labeled by radioactive nucleotides. Recently, biotin labeling of DNA is becoming more popular. Biotin is added to nucleotides, which will be incorporated into the newly synthesizing DNA. The fixed biotin can be identified by reaction with avidin.
- Streptavidin** purified from *Streptomyces avidinii*, can bind 4 molecules of biotin.

## Deficiency of Biotin

- Prolonged use of antibacterial drugs
- Biotin deficiency symptoms include dermatitis, atrophic glossitis, hyperesthesia, muscle pain, anorexia and hallucinations. Injection of biotin 100–300 mg will bring about rapid cure of these symptoms.

## Requirement of Biotin

About 200–300 mg will meet the daily requirements.

## Sources of Biotin

Normal bacterial flora of the gut will provide adequate quantities of biotin. Moreover, it is distributed ubiquitously in plant and animal tissues. Liver, yeast, peanut, soybean, milk, egg yolk are rich sources.

A summary of water soluble vitamins is given in Table 37.1. Other water soluble vitamins, folic acid, vitamin B<sub>12</sub> and vitamin C, are described in Chapter 38.

**TABLE 37.1:** Summary of water soluble vitamins discussed in this chapter

Name	Co-enzyme form	RDA	Main reaction using the co-enzyme	Deficiency disease
Thiamine	Thiamine pyrophosphate (TPP)	1–1.5 mg	Oxidative decarboxylation of alpha keto acids	Beriberi
Riboflavin	Flavin adenine dinucleotide (FAD)	1.5 mg	Dehydrogenation, oxidized in ETC (1.5 ATP)	Glossitis, angular stomatitis
Niacin	Nicotinamide adenine dinucleotide (NAD and NADP)	20 mg	Dehydrogenation, oxidized in ETC (2.5 ATP), reductive biosynthetic reactions and hydroxylation	Pellagra
Pyridoxine	Pyridoxal phosphate (PLP)	1–2 mg	Transamination, decarboxylation of amino acids	Seizures, anemia, homocystinuria
Pantothenic acid	Co-enzyme A, ACP	10 mg	CoA derivatives, acyl carrier proteins	Burning foot syndrome
Biotin	Biotin	200–300 mg	Carboxylation	No specific disease

Note: The requirements are significantly higher in pregnancy and lactation. See also Table 38.1 for other water soluble vitamins.

### Clinical Case Study 37.1

A 59-year-old male is brought to the emergency department after a family member found him extremely confused and disoriented, with an unsteady gait. The patient has been known in the past to be a heavy drinker. He has no known medical problems. On examination, he is afebrile with a normal blood pressure. He is extremely disoriented and agitated. Horizontal rapid eye movement on lateral gaze is noted bilaterally. His gait is very unsteady. The urine drug screen was negative and he had a positive blood alcohol level. The emergency room physician administers thiamine. What is the most likely diagnosis?

### Clinical Case Study 37.2

A 65-year-old chronic smoker and alcoholic suffered from nonspecific symptoms like painful swallowing, insomnia, epigastric discomfort and recurrent diarrhea. On examination, he had disorientation, stomatitis, glossitis, esophagitis and exfoliative dermatitis. Laboratory measurements revealed leukocytosis, elevated ALT, AST and GGT and there was ultrasound evidence of fatty liver. Treatment with 500 mg daily nicotinamide was started when rashes improved and other symptoms were reduced. He restricted alcohol and smoking and increased consumption of other B complex vitamins and food sources of B complex vitamins. What is the likely condition? What is the pathophysiology of the findings?

### Clinical Case Study 37.1 Answer

Wernicke-Korsakoff syndrome (thiamine deficiency) often associated with chronic alcoholics.

Importance of thiamine: It is used as a co-factor in enzymatic reactions involving the transfer of an aldehyde group. Without thiamine, individuals can develop dementia, macrocytic anemia (folate deficiency), liver disease, depression, cardiomyopathy, and pancreatitis.

Thiamine deficiency is uncommon except in alcoholics as a result of nutritional deficiencies and malabsorption. The classic clinical triad of dementia, ataxia (difficulty with walking), and eye findings may be seen, but more commonly, only forgetfulness is noted. Sometimes, thiamine deficiency can lead to vague symptoms such as leg numbness or tingling. Other manifestations include beriberi, leading to a high cardiac output, heart failure

and vasodilation. Affected patients often feel warm and flushed.

### Clinical Case Study 37.2 Answer

Diarrhea, dementia and dermatitis (3Ds) are typical features of niacin deficiency, pellagra. Chronic alcoholics are prone to multiple vitamin deficiencies, which are seen in this patient. Fatty liver is also due to chronic alcoholism. Treatment with multivitamins resulted in amelioration of the symptoms. A balanced diet including all B complex vitamins is needed.

Niacin in large doses can also lower LDL cholesterol and triglycerides, and increase HDL cholesterol level.

### QUICK LOOK OF CHAPTER 37

1. The co-enzyme form of Thiamine is thiamine pyrophosphate (TPP).
2. TPP is essential for PDH, transketolase, alpha ketoglutarate dehydrogenase.
3. Deficiency of thiamine leads to beriberi.
4. Co-enzyme forms of riboflavin are FMN and FAD.
5. Examples of FAD dependent enzymes are succinate dehydrogenase and acyl CoA dehydrogenase.
6. Examples of NAD<sup>+</sup> dependent enzymes are lactate dehydrogenase, glyceraldehyde-3-phosphate dehydrogenase and pyruvate dehydrogenase.
7. Niacin is synthesized from tryptophan.
8. In Hartnup disease, tryptophan absorption from intestine is limited. This leads to deficiency of tryptophan and consequently of nicotinamide.
9. Active form of pyridoxine is pyridoxal phosphate (PLP).
10. PLP is essential for transamination and decarboxylation reactions of amino acids.
11. ALA synthase in heme biosynthesis is also a PLP dependent enzyme. Hence anemia is common in B<sub>6</sub> deficiency.
12. Isonicotinic acid hydrazide (INH) (isoniazid) used as an antituberculosis drug can produce pyridoxine deficiency.
13. Co-enzyme A contains pantothenic acid.
14. Important CoA derivatives are, acetyl CoA, succinyl CoA, HMG CoA and acyl CoA.
15. Biotin acts as co-enzyme for carboxylation reactions. For example, acetyl CoA carboxylase, propionyl CoA carboxylase, pyruvate carboxylase.
16. Avidin, a protein present in egg white has great affinity to biotin. Hence intake of raw (unboiled) egg may cause biotin deficiency.



# CHAPTER 38

## Water Soluble Vitamins - 2 (Folic acid, Vitamin B<sub>12</sub> and Ascorbic acid)

### Chapter at a Glance

The reader will be able to answer questions on the following topics:

- Folic acid
- Vitamin B<sub>12</sub>
- Choline
- Ascorbic acid (Vitamin C)

### FOLIC ACID

The name is derived from the Latin word folium, which means leaf of vegetable. Folic acid is abundant in vegetables. Angier in 1941 established the chemical structure of folic acid. The name folic acid was assigned by Mitchell, Snell and Williams.

### Chemistry of Folic Acid

The Latin word folium means leaf of vegetable. Folic acid is abundant in vegetables. It is composed of three constituents. The **pteridine** group linked with para amino benzoic acid (**PABA**) is called **pteroic acid**. It is then attached to **glutamic acid** to form pteroyl glutamic acid or folic acid (Fig. 38.1). In nature, polyglutamates are seen where up to seven glutamate residues are linked to the pteroyl group. Folacin is the generic name for such folic acid related compounds. Folic acid is soluble in water. When exposed to light, it is rapidly destroyed.

### Absorption of Folic Acid

Folic acid is readily absorbed by the **upper part of jejunum**. In the blood, it is transported by beta globulins. It is taken up by the liver where the co-enzymes are produced. Folic acid is not stored in tissues.

There are different tissue specific **transporters** for folic acid. These high affinity binding proteins are anchored on plasma membrane. Folate-transporter complex is internalized by a non-clathrin mediated endocytosis. The term "**potocytosis**" is used to denote the recycling of transport proteins by vesicular structures, named **caveolae**.

### Co-enzyme Functions of Folic Acid

- A. The folic acid is first reduced to 7,8-dihydrofolic acid and further reduced to 5,6,7,8-**tetrahydro folic acid** (THFA) (Fig. 38.2). Both reactions are catalyzed by **NADPH** dependent folate reductase.

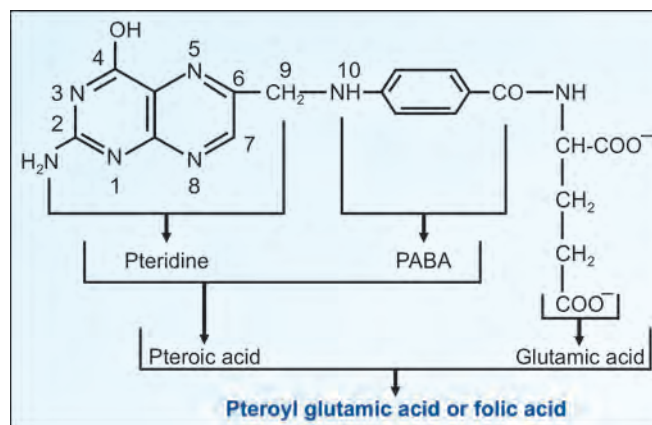


Fig. 38.1: Structure of folic acid

- B. The THFA is the **carrier of one-carbon** groups. One carbon compound is an organic molecule that contains only a single carbon atom. The following groups are one carbon compounds:
- Formyl (-CHO)
  - Formimino (-CH=NH)
  - Methenyl (-CH=)
  - Methylene (-CH<sub>2</sub>-)
  - Hydroxymethyl (-CH<sub>2</sub>OH)
  - Methyl (-CH<sub>3</sub>).
- C. These one carbon compounds are attached either to the 5th or to the 10th or to both 5th and 10th nitrogen atoms of THFA (Fig. 38.3). The one carbon metabolism and their interconversions are given in detail in Figure 15.18.
- D. Methyl group in N<sup>5</sup>-methyl THFA is used for synthesis of active methionine, which takes part in transmethylation reactions (Fig. 38.4). Such **transmethylation** reactions, where the methyl group donor is SAM, are required for synthesis of choline, epinephrine, creatine, etc. (Table 16.1).

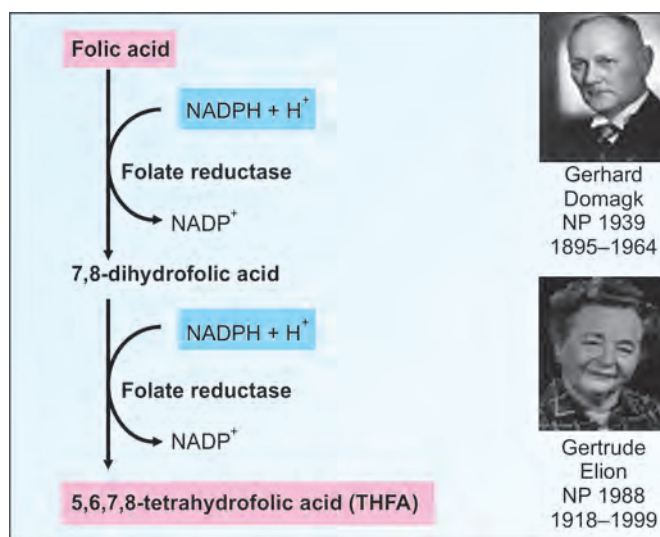
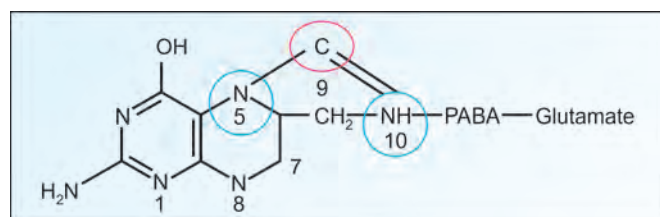


Fig. 38.2: Folate reductase

Fig. 38.3: N<sup>5</sup>, N<sup>10</sup>-methenyl THFA. One carbon unit (red ring) is attached to N<sup>5</sup> and N<sup>10</sup> groups (blue rings) of tetrahydrofolic acid

## Causes for Folate Deficiency

Folic acid deficiency is very common in India, and is perhaps the most commonly seen vitamin deficiency.

- Pregnancy:** Folate deficiency is commonly seen in pregnancy, where requirement is increased.
- Defective absorption:** In sprue, celiac disease, gluten induced enteropathy, resection of jejunum and short-circuiting of jejunum in gastroileostomy, absorption is defective.
- Drugs:** In the diet, folacins are mainly in polyglutamate form. Gastrointestinal enzymes in the gut remove the glutamate residues and only the mono-glutamate form of folic acid is absorbed. Anticonvulsant drugs (hydantoin, dilantin, phenytoin, phenobarbitone) will inhibit the intestinal enzyme, so that folate absorption is reduced.
- Hemolytic anemias:** As requirement of folic acid becomes more, deficiency is manifested.
- Dietary deficiency:** Absence of vegetables in food for prolonged periods may lead to deficiency.
- Folate trap:** The only way for generation of free THFA is step No.1 in Figure 38.4. When B<sub>12</sub> is deficient, this reaction cannot take place, leading to folate deficiency (see under vitamin B<sub>12</sub>).

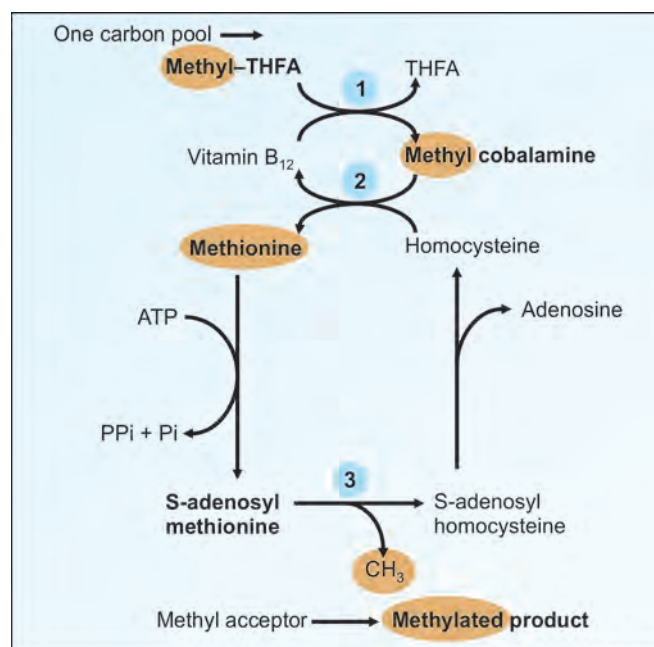


Fig. 38.4: Transmethylation reactions. (2) = Homocysteine methyl transferase; (3) = methyl transferase

## Deficiency Manifestations

### Reduced DNA synthesis

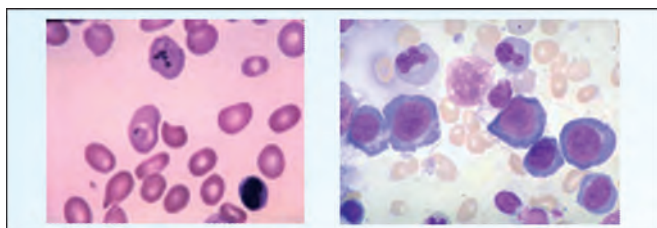
In folate deficiency, THFA is reduced and thymidylate synthase enzyme is inhibited. Hence dUMP is not converted to dTMP. So dTTP is not available for DNA synthesis. Thus cell division is arrested. Very rapidly dividing cells in bone marrow and intestinal mucosa are therefore most seriously affected.

### Macrocytic Anemia

- i. It is the most characteristic feature of folate deficiency (Fig. 38.5). During RBC generation, DNA synthesis is delayed, but protein synthesis is continued. Thus hemoglobin accumulates in RBC precursors. This asynchrony or dissociation between the maturity of nucleus and cytoplasm is manifested as **immature looking nucleus** and mature eosinophilic cytoplasm in the bone marrow cells.
- ii. **Reticulocytosis** is often seen. These abnormal RBCs are rapidly destroyed in spleen. **Hemolysis** leads to the reduction of lifespan of RBC. Reduced generation and increased destruction of RBCs result in anemia.
- iii. **Leukopenia** and thrombocytopenia are also manifested.
- iv. The peripheral blood picture in folate deficiency is described as **macrocytic**, and in cobalamin deficiency as **megaloblastic**. In B<sub>12</sub> deficiency, there are additional neurological symptoms.

### Hyperhomocysteinemia

Folate acid deficiency may cause increased homocysteine levels in blood since remethylation of homocysteine is



**Fig. 38.5:** (Left) Common manifestation of folate acid deficiency is Macrocytic anemia. (Right) Megaloblastic anemia with nucleated RBCs in vitamin B<sub>12</sub> deficiency

affected. Plasma homocysteine levels above 15  $\mu\text{mol/L}$  is known to increase the risk of **coronary artery diseases**. Providing adequate doses of pyridoxine, B<sub>12</sub> and folic acid may lower the homocysteine levels.

### Birth Defects

Folic acid deficiency during pregnancy may lead to neural tube defects in the fetus. Folic acid prevents hyperhomocysteinemia and therefore neural tube defects like spina bifida. So, intake of folic acid is a must from early pregnancy.

### Cancer

Folic acid is beneficial in prevention of **cancer**. Folate deficiency contributes to the etiology of bronchial carcinoma and cervical carcinoma.

## Assessment of Folate Deficiency

- i. **Blood level:** Normal folic acid level in serum is about 20 ng/mL and about 200  $\mu\text{g/mL}$  of packed cells. The level is measured by radioimmunoassay.
- ii. **Histidine load test or FIGLU excretion test:** Histidine is normally metabolized to formimino glutamic acid (FIGLU) from which formimino group is removed by THFA. Therefore in folate deficiency, FIGLU is excreted in urine.
- iii. **AICAR excretion:** In the purine ring synthesis, the last step is the addition of C2 with the help of N<sup>10</sup>-formyl THFA (step No. 9 in purine synthesis, Chapter 43). When this is blocked, the precursor, **amino imidazole carboxamide ribonucleotide (AICAR)** accumulates and is excreted in urine.
- iv. **Peripheral blood picture.**

## Sources of Folic Acid

Rich sources of folate are yeast, green leafy vegetables. Moderate sources are cereals, pulses, oil seeds and egg. Milk is a poor source for folic acid.

## Recommended Daily Allowance (RDA)

The requirement of free folate is 200  $\mu\text{g/day}$ . In pregnancy the requirement is increased to 400  $\mu\text{g/day}$  and during lactation to 300  $\mu\text{g/day}$ .

## Folic Acid Therapy

Therapeutic dose is 1 mg of folic acid per day orally. Folic acid alone should not be given in macrocytic anemia, because it may aggravate the neurological manifestation of B<sub>12</sub> deficiency. So, folic acid and vitamin B<sub>12</sub> are given in combination to patients. Regular supplementation of folic acid may reduce the incidence of birth defects, cardiovascular diseases and cancers.

### Toxicity of Folic Acid

Doses over 1 mg may cause aggravation of vitamin B<sub>12</sub> deficiency and may precipitate nerve damage. Since solubility of folic acid is low, large doses should not be given parenterally, as there is danger of crystallization in kidney tubules leading to renal damage.

## Folate Antagonists

### Sulfonamides

They have structural similarity with PABA (Fig. 38.6). Therefore, they competitively inhibit the enzyme responsible for the incorporation of PABA into dihydropteroic acid, the immediate precursor of folic acid (see competitive inhibition, Chapter 5). Bacteria can synthesize folic acid from the components, pteridine, PABA and glutamate. When sulfonamides are given, such microorganisms cannot synthesize folic acid and hence their growth is inhibited. As man cannot synthesize folic acid, the entire molecule has to be supplied in the diet. The preformed folic acid cannot enter into bacteria, but only into mammalian cells. Thus sulphonamides are very good **antibacterial** agents, which do not affect the human cells. Gerhard Domagk discovered the antibacterial effect of Prontosil (a sulfonamide) in 1932 for which he was awarded Nobel prize in 1939.

### Pyrimethamine

This antifolate agent is used against plasmodial infections (**antimalarial** drug) (Fig. 38.6). Gertrude Elion synthesized pyrimethamine, who got Nobel prize in 1988.

### Aminopterin and Amethopterin

Aminopterin (4-amino folic acid) and amethopterin (methotrexate) (4-amino, 10-methyl folic acid) are powerful competitive inhibitors of folate reductase and THFA generation. Thus these drugs decrease the DNA formation and cell division. They are widely used as **anti-cancer** drugs (antimetabolites), especially for leukemias

and choriocarcinomas. Folinic acid (citraovorum factor) is given to rescue the patient from toxicity of methotrexate. Methotrexate is also used in treatment of rheumatoid arthritis as an immunosuppressant.

## VITAMIN B<sub>12</sub>

Synonyms are cobalamin, extrinsic factor (EF) of Castle and antipernicious anemia factor. In 1849, Thomas Addison described pernicious anemia. William Murphy and George Minot showed that liver therapy is very effective to treat pernicious anemia. For this work, they were awarded Nobel prize in 1934. Dorothy Hodgkin suggested the structure by X-ray diffraction studies (Nobel Prize, 1964). Later Robert Woodward synthesized B<sub>12</sub> and proved the structure (Nobel prize, 1965).

## Chemistry

Vitamin B<sub>12</sub> is water soluble, heat stable and red in color. It contains 4.35% cobalt by weight. It contains one cobalt atom. Four pyrrole rings coordinated with a cobalt atom is called a **Corrin ring**. Note the similarity between the Corrin ring and the porphyrin ring system (see Chapter 21). The 5th valency of the cobalt is covalently linked to a substituted benzimidazole ring. This is then called **cobalamin**. The 6th valency of the cobalt is satisfied by any of the following groups: cyanide, hydroxyl, adenosyl or methyl (Fig. 38.7A).

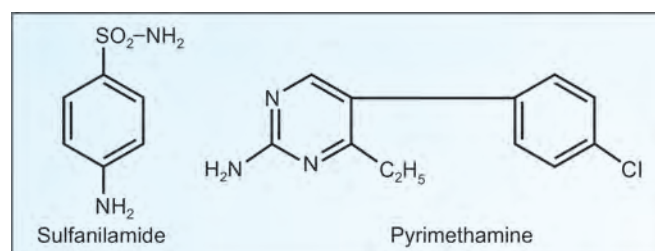


Fig. 38.6: Folate antagonists

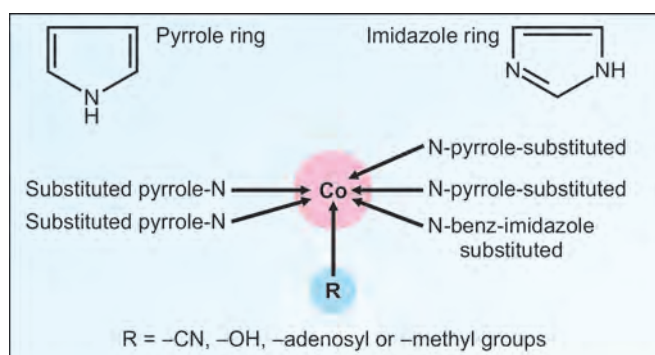


Fig. 38.7A: Simplified structure of vitamin B<sub>12</sub>



### Cyanocobalamin

When cyanide is added at the R position, the molecule is called cyanocobalamin. During the isolation procedure, cyanide is added to get stable crystals. The CN group has no physiological function, it is only a laboratory artefact. Oral preparations are in this form.

### Hydroxy Cobalamin

When hydroxyl group is attached at the R position, it is called hydroxy cobalamin or vitamin B<sub>12a</sub>. **Injectable preparations** are in this form.

### Adenosyl Cobalamin (Ado-B<sub>12</sub>)

When taken up by the cells, these groups are removed and deoxy adenosyl cobalamin or Ado-B<sub>12</sub> is formed (Fig. 38.7B). This is the major **storage form**, seen in liver.

### Methyl Cobalamin

When the methyl group replaces adenosyl group, it is known as methyl cobalamin. This is the major form **seen in blood** circulation as well as in cytoplasm of cells. The Ado-B<sub>12</sub> and methyl B<sub>12</sub> are the **functional co-enzymes** in the body.

## Absorption of Vitamin B<sub>12</sub>

- Absorption of vitamin B<sub>12</sub> requires two binding proteins. First is the **intrinsic factor (IF)** of Castle (Fig. 38.8). William B Castle described it in 1929. The B<sub>12</sub> is otherwise known as extrinsic factor (EF), that is, the factor derived from external sources. Intrinsic factor is secreted by the gastric parietal cells. It is a glycoprotein with a molecular weight of 50,000.
- The second factor is **cobalophilin**, secreted in the saliva. Gastric **pepsin** release the vitamin from proteins of the food, and then B<sub>12</sub> binds with cobalophilin. In duodenum, cobalophilin is hydrolyzed by **trypsin** of pancreatic juice; vitamin is released, and then vitamin binds to intrinsic factor. In pancreatic insufficiency

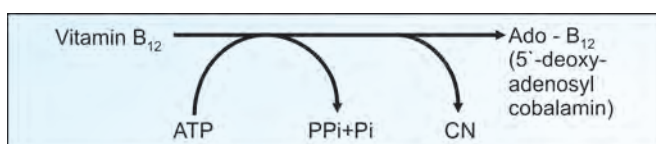


Fig. 38.7B: Storage form of vitamin B<sub>12</sub>

(absence of trypsin), the vitamin may not be released. Then vitamin-cobalophilin complex is excreted, resulting in vitamin deficiency.

- One molecule of IF can combine with 2 molecules of B<sub>12</sub>. This IF-B<sub>12</sub> complex is attached with specific receptors on mucosal cells. The whole IF-B<sub>12</sub> complex is internalized. (Fig. 38.9A). It may be noted that B<sub>12</sub> is absorbed from **ileum**, while folic acid is from jejunum.

## Transport and Storage

In the blood, **methyl B<sub>12</sub>** form is predominant. **Transcobalamin**, a glycoprotein, is the specific carrier (Fig. 38.8). It is stored in the liver cells, as **ado-B<sub>12</sub>** form, in combination with **transcortin**. Generally, B complex vitamins are not stored in the body, B<sub>12</sub> is an exception. Whole liver contains about 2 mg of B<sub>12</sub>, which is sufficient for the requirement for 2–3 years. So, B<sub>12</sub> deficiency is seen only years after gastrectomy.

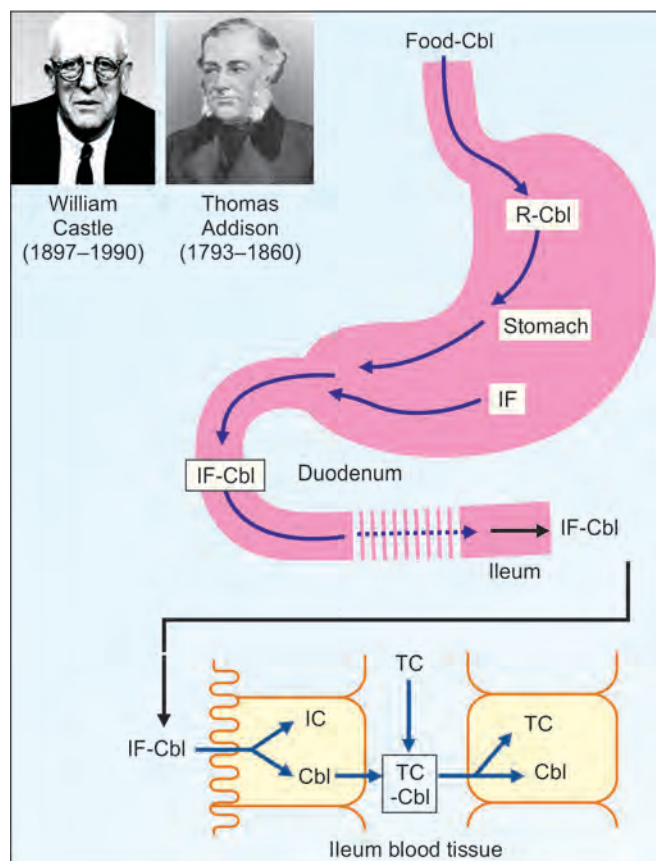


Fig. 38.8: Absorption and storage of vitamin B<sub>12</sub>. R = cobalophilin; Cbl = cobalamin; IF = intrinsic factor; TC = transcobalamin

## Functional Role of B<sub>12</sub>

### Methyl Malonyl CoA Isomerase

D-Methyl malonyl CoA is formed in the body from propionyl CoA. It is then converted to L form by a racemase and then isomerized by methylmalonyl CoA mutase (containing Ado-B<sub>12</sub>) to succinyl CoA, which enters into citric acid cycle (Fig. 12.11). In B<sub>12</sub> deficiency, methylmalonyl CoA accumulates and **methyl malonic aciduria** occurs.

The metabolism of odd chain fatty acids, valine, isoleucine, methionine and threonine leads to the production of methylmalonyl CoA.

### Homocysteine Methyl Transferase

Step 2 in Figure 38.4 is catalyzed by the enzyme methionine synthase or homocysteine methyl transferase. The steps marked as 1 and 2 in Figure 38.4 need the activity of vitamin B<sub>12</sub> (methyl cobalamin).

### Methyl Folate Trap and Folate Deficiency

The production of methyl THFA is an irreversible step (see Fig. 15.16). Therefore, the only way for regeneration of free THFA is step No. 1 in Figure 38.4. When B<sub>12</sub> is deficient, this reaction cannot take place. This is called the **methyl folate trap**. This leads to the associated **follic acid scarcity in B<sub>12</sub> deficiency**. Genetic polymorphism has been reported in the gene coding for the methyl transferase enzyme which can alter the requirement for folic acid and cause hyperhomocysteinemia.

## Causes of B<sub>12</sub> Deficiency

### Nutritional

Nutritional vitamin B<sub>12</sub> deficiency is very common in India, especially among vegetarians of low socioeconomic group. The only source for B<sub>12</sub> in vegetarian diet is curd/milk, and lower income group may not be able to afford it.

### Decrease in Absorption

Absorptive surface is reduced by gastrectomy, resection of ileum and malabsorption syndromes.

### Addisonian Pernicious Anemia

It is very rare in India, but common in European countries. When it was described in 1849 by Thomas Addison, it

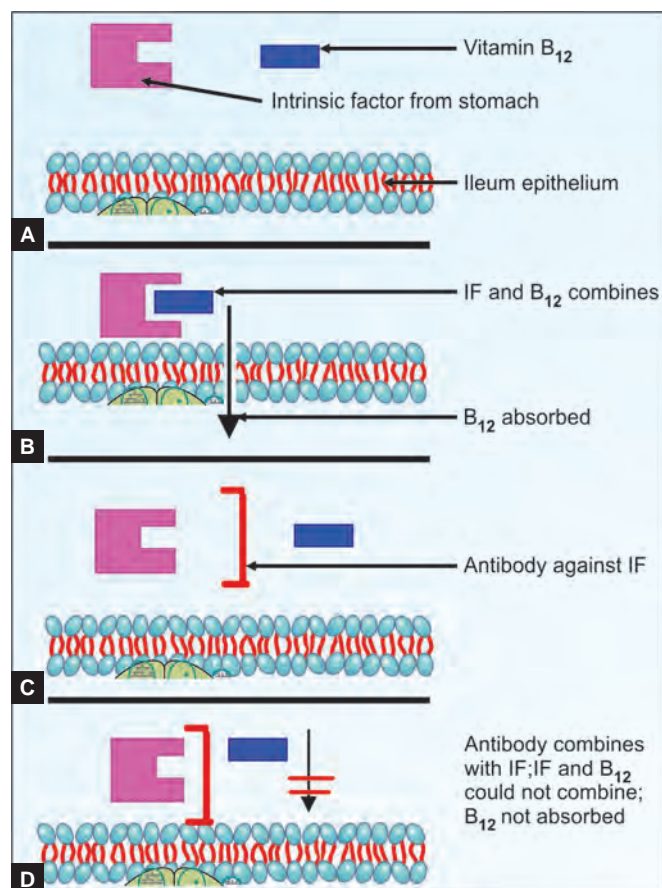
was pernicious (fatal), without any known remedy. It is manifested usually in persons over 40 years. It is an autoimmune disease with a strong familial background. Antibodies are generated against IF. So, IF becomes deficient, leading to defective absorption of B<sub>12</sub> (Fig. 38.9).

### Gastric Atrophy

Although true Addisonian pernicious anemia is rare, similar atrophy of gastric epithelium leading to deficiency of IF and decreased B<sub>12</sub> absorption is common in India. In chronic **iron deficiency** anemia, there is generalized mucosal atrophy. In about 40% cases of iron deficiency anemia, superadded gastric atrophy is seen.

### Pregnancy

Increased requirement of vitamin in pregnancy is another common cause for vitamin B<sub>12</sub> deficiency in India.



**Figs 38.9A to D:** (A) Intrinsic factor secreted from stomach reaches intestine; (B) = Vitamin B<sub>12</sub> absorbed with the help of intrinsic factor; (C) = In pernicious anemia, antibody against IF is produced; (D) = In presence of antibody, absorption is not taking place

### Fish Tapeworm

Although not seen in India, the fish tapeworm, *diphyllobothrium latum* infection is common in Scandinavian countries where eating live fish is a delicacy. This tapeworm has a special affinity to B<sub>12</sub> causing reduction in available vitamin.

### Deficiency Manifestations

- i. **Folate trap:** Vitamin B<sub>12</sub> deficiency causes simultaneous folate deficiency due to the folate trap. Therefore all the manifestations of folate deficiency are also seen (for details see under folic acid).
- ii. **Megaloblastic anemia:** In the peripheral blood, megaloblasts and immature RBCs are observed (Fig. 38.5).
- iii. **Abnormal homocysteine level:** In vitamin B<sub>12</sub> deficiency, step No. 2 (Fig. 38.4) is blocked, so that homocysteine is accumulated, leading to **homocystinuria**. Homocysteine level in blood is related with myocardial infarction. So, B<sub>12</sub> and folic acid are protective against ischemic heart disease.
- iv. **Demyelination:** In vitamin B<sub>12</sub> deficiency, step 3 (Fig. 38.4) is also suppressed due to the non-availability of active methionine. Therefore methylation of phosphatidyl ethanolamine to phosphatidyl choline is not adequate. This leads to deficient formation of myelin sheaths of nerves, demyelination and neurological lesions.
- v. **Subacute combined degeneration:** Damage to nervous system is seen in B<sub>12</sub> deficiency (but not in folate deficiency). There is **demyelination** affecting cerebral cortex as well as dorsal column and pyramidal tract of spinal cord. Since sensory and motor tracts are affected, it is named as combined degeneration. Symmetrical paraesthesia of extremities, alterations of tendon and deep senses and reflexes, loss of position

sense, unsteadiness in gait, positive **Romberg's** sign (falling when eyes are closed) and positive **Babinski's** sign (extensor plantar reflex) are seen.

- vi. **Achlorhydria:** absence of acid in gastric juice is associated with vitamin B<sub>12</sub> deficiency.

### Assessment of B<sub>12</sub> Deficiency

- i. **Serum B<sub>12</sub>:** It is quantitated by radioimmunoassay or by ELISA.
- ii. **Schilling test:** Radioactive labelled (Cobalt-60) vitamin B<sub>12</sub>, one microgram is given orally. In gastric atrophy cases, there is no absorption, hence the entire radioactivity is excreted in feces and radioactivity is not observed in liver region. If the cause is nutritional deficiency, there will be enhanced absorption. Then radioactivity is noted in the liver region, with very little excretion in feces.
- iii. **Methyl malonic acid:** It is seen in urine.
- iv. **FIGLU excretion test:** (see folic acid).
- v. **Peripheral smear:** Peripheral blood and bone marrow morphology shows megaloblastic anemia (Fig. 38.5).
- vi. **Homocystinuria:** (see Chapter 16, under Methionine).

### Treatment

If megaloblastic anemia is treated with folic acid alone, the anemia may improve, but associated neurological symptoms are aggravated. Hence all macrocytic anemias are generally treated with folate and vitamin B<sub>12</sub>. Therapeutic dose of B<sub>12</sub> is 100 to 1000 microgram by intramuscular injections.

### Requirement of Vitamin B<sub>12</sub>

Normal daily requirement is 1–2 µg/day. During pregnancy and lactation, this is increased to 2 mg/day. Those who take folic acid, should also take vitamin B<sub>12</sub>. Elderly people are advised to take B<sub>12</sub> supplementation.

### Dietary Sources

Vitamin B<sub>12</sub> is not present in vegetables. Liver is the richest source. Curd is a good source, because lactobacillus can synthesize B<sub>12</sub>.

### CHOLINE

Best and Huntsman (1934) discovered that choline deficiency in the rat produces fatty liver. It plays an active role in transmethylation (see under



William P. Murphy  
NP 1934  
1892–1987



George R. Minot  
NP 1934  
1885–1950



Dorothy C. Hodgkin  
NP 1964  
1910–1994



Robert Woodward  
NP 1965  
1917–1979

serine, Chapter 16). Choline is synthesized in the body (see Fig. 16.12) and therefore it is not a vitamin. But in view of its importance in nutrition, conventionally, it is included as a member of vitamin B complex. Rice polishings, vegetables, milk, egg and liver are good sources. It is synthesized from serine (see Chapter 16).

### Chemistry

It is hydroxyethyl trimethyl amine, or trimethylethanol amine (Fig. 38.10A). It is water soluble.

### Biochemical Functions

- i. **Phospholipid synthesis:** Choline is a part of **phospholipids** which are essential constituents of the membranes of all cells.
- ii. **Myelin sheath:** It is made by phospholipids. **Demyelination** causes severe diseases of nervous system.
- iii. **Fatty liver:** Phospholipids are involved in the transport of fat and cholesterol from the liver. In choline deficiency, neutral fat and cholesterol esters accumulate in liver, leading to fatty liver. Choline is able to prevent fatty liver and cirrhosis (see Chapter 12).
- iv. **Transmethylation reactions:** Choline can donate three methyl groups to the one-carbon pool (see one carbon metabolism in Chapter 15). Finally, these methyl groups are transferred to homocysteine to produce methionine, which is used for transmethylation reactions (see Chapter 16).
- v. **Acetylcholine (ACh) synthesis:**  
 Choline acetylase  
 $\text{Choline} + \text{Acetyl CoA} \longrightarrow \text{Acetylcholine} + \text{CoA}$   
 Acetylcholine esterase  
 $\text{Acetylcholine} \longrightarrow \text{Choline} + \text{Acetate}$

### Acetylcholine

It is synthesized in the neurons, which reaches the presynaptic region of synaptosomes, where ACh is stored in packets. When a nerve impulse reaches, the ACh is liberated into the synaptosome. At the postsynaptic region, the ACh is picked up by the specific receptors, which produces

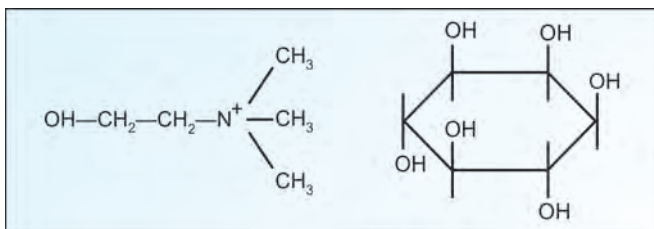


Fig. 38.10: (A) Choline, left side and (B) Myo-inositol, right side

a nerve impulse. Thus the nerve impulse is transmitted through the synapses by the chemical messenger, the ACh. As soon as the nerve impulse is generated in the post-synaptic fiber, the ACh is hydrolyzed by the ACh-esterase.

In 1914, Henry Dale isolated Ach. In 1920, Otto Loewi studied the effect of ACh on nerve transmission. Both of them were awarded Nobel prize in 1936. Later work of Bernard Katz on the effect of ACh on neuromuscular end plates earned him the Nobel prize in 1970.

### Clinical Applications

- i. The post-synaptic receptors for ACh may be competitively blocked by **succinylcholine**, a structural analog of ACh. Then ACh cannot act, producing muscle relaxation. It is widely used as a **muscle relaxant** during surgery.
- ii. Cholinesterase inhibitors (e.g. **neostigmine**) will allow prolonged action of ACh and therefore nerve impulse is sustained. These drugs are used in **myasthenia gravis**. Myasthenia is an autoimmune condition, where antibodies are produced against neuromuscular end plate proteins destroying the end plates.
- iii. Pseudo cholinesterase is seen in RBCs, more in immature cells (see Chapter 23).

### INOSITOL

Inositol is hexahydroxycyclohexane. Out of the many isomers, **myo-inositol** is seen in tissues (Fig. 38.10B). It is seen in yeast, cereals and milk. Inositol deficiency is unknown to man. Therefore it could not be considered as a vitamin.

### Biochemical Functions of Inositol

- 1 Studies in tissue culture have revealed that inositol is required for growth of fibroblasts.
2. Inositol is a constituent of certain phospholipids.
3. It occurs in large quantities in mammalian heart muscle.
4. Hexaphosphate of inositol is called **phytin**. It is found in vegetables, which prevent the absorption of calcium and iron from intestine.
5. **Phosphatidyl inositol** is an important constituent of cell membranes. In response to extracellular signals, **inositol triphosphate** ( $\text{IP}_3$ ) is released from phosphatidyl inositol.  $\text{IP}_3$  is a second messenger (see Chapter 50). It may allow calcium inflow into the cells, leading to cellular metabolic activation.
6. **Peripheral neuropathy**, very commonly seen in diabetes mellitus, is associated with inositol metabolism. Decreased inositol in nerve fibers may be the cause for neuropathy.
7. It is a **lipotropic factor** and prevents fatty liver.

### ASCORBIC ACID (VITAMIN C)

A description of scurvy was found in the Ebers papyrus written in 1500 BC in Egypt. During the voyage of Vasco da Gama, around the cape of Good Hope to India in 1498, he lost two-third of the crew due to scurvy. The French explorer, Jacques Cartier, in 1536, during the voyages to



discover eastern parts of Canada, was laid up with scurvy. A friendly native gave an extract from the leaves of spruce tree, which produced remarkable cure to scurvy (Fig. 38.11). James Lind published 'Treatise on Scurvy', in 1753. These observations led to compulsory rationing of lime or lemon juice to all the crew of the British Royal Navy from 1795 onwards. So the British sailors were nicknamed as "Limeys". However, it helped to eliminate scurvy from the British Navy, while opponents continued to suffer. No wonder, in course of time, Britain had the colonies in which the sun never set. In 1907, Holst and Trochlich produced scurvy in guineapigs. Zilva and associates, in 1928, showed that the antiscorbutic factor present in lemon juice is a reducing substance. The factor was isolated in 1930 and named as "Hexuronic acid" by Albert Szent-Gyorgi (Nobel prize, 1937). In 1933, Haworth established the molecular structure. He renamed it as ascorbic acid (Nobel prize, 1937).

## Chemistry of Vitamin C

It is water soluble and is easily destroyed by heat, alkali and storage. In the process of cooking, 70% of vitamin C is lost.

The structural formula of ascorbic acid closely resembles that of carbohydrates (Fig. 38.13). The strong reducing property of vitamin C depends on the double-bonded (enediol) carbons.

Only L-ascorbic acid and dehydroascorbic acid have antiscorbutic activity. D-ascorbic acid has no activity.

## Biosynthesis of Ascorbic Acid in Animals

Most animals and plants can synthesize ascorbic acid from glucose. The pathway is described in Figure 10.14. **Man, higher primates, guineapigs and bats** are the only species which cannot synthesize ascorbic acid (block in gulono lactone oxidase step). They lack the genes responsible for the synthesis of this enzyme. The vitamin, therefore, should



Fig. 38.11: Red Indian gives the leaves to Cartier

be supplied in the diet of these species. The staple diet of primates contains fruits and vegetables rich in ascorbic acid, and so the gene deletion will have no deleterious effect in primates. Human beings, of course, carried over this gene deletion.

## Metabolism of Ascorbic Acid

- i. Ascorbic acid is readily absorbed from gastrointestinal tract. The vitamin is excreted in urine. Since vitamin C is a strong reducing agent, the *Benedict's test* will be positive in the urine sample after the vitamin administration.
- ii. Oxidation of ascorbic acid yields dehydro ascorbic acid, which is oxidized further to oxalic acid through diketo-L-gulonic acid (Fig. 38.13). Ascorbic acid is partly excreted unchanged and partly as oxalic acid. Most of the oxalates in urine are derived from ascorbic acid, and the rest from glycine metabolism.
- iii. The ascorbic acid level varies between 0.7 to 1.2 mg/100 mL of plasma and 25 mg/100 cc of WBC. A low level in blood is noted in women taking contraceptive pills and also in chronic alcoholics.
- iv. A very high concentration of vitamin C is observed locally in healing wounds. Vitamin C is essential for wound healing.

## Biochemical Functions of Vitamin C

### Reversible Oxidation-reduction

It can change between ascorbic acid and dehydroascorbic acid. Most of the physiological properties of the vitamin could be explained by this redox system.



Fig. 38.12: (A) Gingivitis and bleeding gum in vitamin C deficiency; (B) Lime and (C) Gooseberry are good sources of vitamin C

### Hydroxylation of Proline and Lysine

Ascorbic acid is necessary for the post-translational hydroxylation of proline and lysine residues (Fig. 38.14). Hydroxyproline and hydroxylysine are essential for the formation of cross links in the **collagen**, which gives the tensile strength to the fibers. This process is absolutely necessary for the normal production of supporting tissues such as osteoid, collagen and intercellular cement substance of capillaries.

### Tryptophan Metabolism

Ascorbic acid is necessary for the hydroxylation of tryptophan to 5-hydroxy tryptophan. This is required for the formation of serotonin (see Fig.18.10).

### Tyrosine Metabolism

Vitamin C helps in the oxidation of parahydroxyphenyl pyruvate to homogentisic acid (see Fig. 18.2).

### Iron Metabolism

Ascorbic acid enhances the iron absorption from the intestine (see Chapter 39). Ascorbic acid reduces ferric iron to ferrous state, which is preferentially absorbed.

### Hemoglobin Metabolism

It is useful for re-conversion of met-hemoglobin to hemoglobin.

### Folic Acid Metabolism

Ascorbic acid is helping the enzyme folate reductase to reduce folic acid to tetrahydrofolic acid (Fig. 38.2). Thus it helps in the maturation of RBC.

### Steroid Synthesis

Large quantities of vitamin C are present in adrenal cortex. The ascorbic acid is depleted by ACTH stimulation. So the vitamin has some role in adrenal steroidogenesis. Vitamin C helps in the synthesis of bile acids from cholesterol. The initial 7- $\alpha$ -hydroxylase step is stimulated by the vitamin.

### Phagocytosis

Ascorbic acid stimulates phagocytic action of leukocytes and helps in the formation of antibodies.

### Anti-oxidant Property

As an antioxidant (see Chapter 33), it may prevent cancer formation. Aniline dyes are known to induce bladder cancer in factory workers. Daily intake of vitamin C reduces this risk for cancer.

### Cataract

Vitamin C is concentrated in the lens of eye. Regular intake of ascorbic acid reduces the risk of cataract formation.

## Deficiency Manifestations of Vitamin C

### Scurvy

Gross deficiency of vitamin C results in scurvy.

### Infantile Scurvy (Barlow's Disease)

In infants between 6 to 12 months of age, (period in which weaning from breast milk), the diet should be supplemented with vitamin C sources. Otherwise, deficiency of vitamin C is seen.

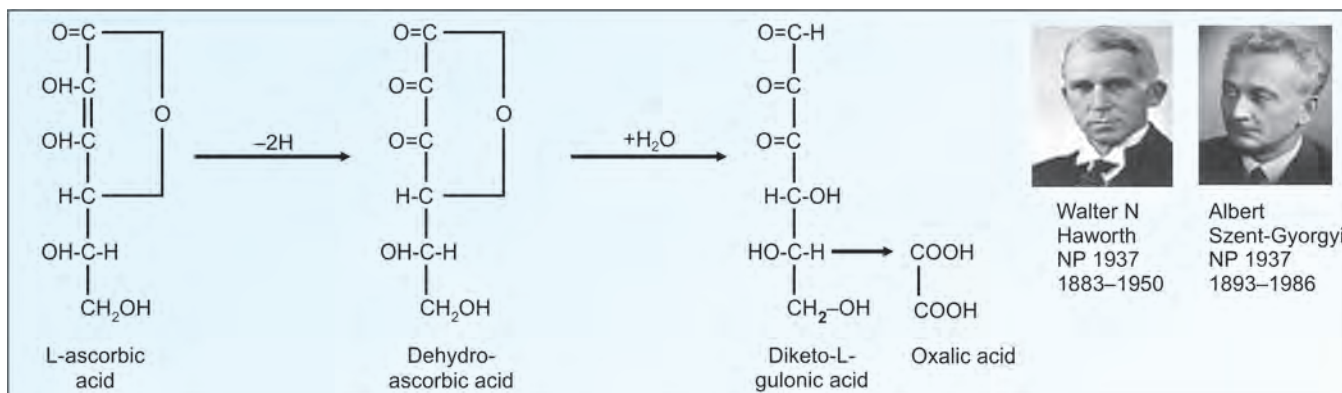


Fig. 38.13: Vitamin C; structure and catabolism

### Hemorrhagic Tendency

In ascorbic acid deficiency, **collagen is abnormal** and the intercellular cement substance is brittle (Fig. 38.14). So capillaries are fragile, leading to the tendency to bleed even under minor pressure. Subcutaneous hemorrhage may be manifested as **petechiae** in mild deficiency and as **ecchymoses** or even hematoma in severe conditions. If a sphygmomanometer cuff is placed in the forearm, and the pressure is kept for 5 minutes, petechiae may be seen under the skin. This is a useful clinical test.

### Internal Hemorrhage

In severe cases, hemorrhage may occur in the conjunctiva and retina. Internal bleeding may be seen as epistaxis, hematuria or melena.

### Oral Cavity

In severe cases of scurvy, the gum becomes painful, swollen, and spongy (Fig. 38.12A). The pulp is separated from the dentine and finally teeth are lost. Wound healing may be delayed.

### Bones

In the bones, the deficiency results in the failure of the osteoblasts to form the intercellular substance, **osteoid**. Without the normal ground substance, the deposition of

bone is arrested. The resulting scorbutic **bone is weak** and fractures easily. There may be hemorrhage into joint cavities. Painful swelling of joints may prevent locomotion of the patient.

Vitamin C and vitamin B<sub>12</sub> are essential nutrients to maintain bone density and bone quality. Recent literature clearly shows that vitamin C and B<sub>12</sub> affect bone quality determinant “collagen cross-link formation”. Mildly elevated plasma homocysteine levels induced by vitamin B insufficiency and methylenetetrahydrofolate reductase (MTHFR) deteriorate normal collagen cross-link formation.

### Anemia

In vitamin C deficiency, microcytic, hypochromic **anemia** is seen. Poikilocytosis and anisocytosis are also common in anemia due to deficiency of vitamin C. The reasons for anemia may be:

- Loss of blood by hemorrhage
- Decreased iron absorption
- Decreased tetrahydrofolic acid
- Accumulation of met-hemoglobin.

### Dietary Sources of Vitamin C

Rich sources are amla (Indian gooseberry) (700 mg/100 g), guava (300 mg/100 g), lime, lemon and green leafy vegetables (Figs 38.12B and C).

### Requirement of Vitamin C

Recommended daily allowance is 75 mg/day (equal to 50 mL orange juice). During pregnancy, lactation, and in aged people requirement may be 100 mg/day. Smokers and those on oral contraceptives have lower vitamin C levels. Aspirin has been found to block the uptake of vitamin by white blood cells. Hence these people require around 100 mg/day.

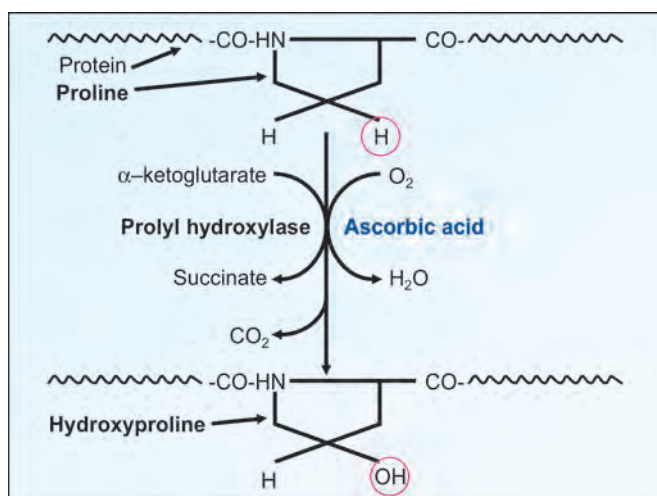


Fig. 38.14: Hydroxylation of proline to hydroxyproline needs ascorbic acid



Henry Dale  
NP 1936  
1875–1968



Otto Loewi  
NP 1936  
1873–1961



Bernard Katz  
NP 1970  
1911–2003

## Therapeutic Use of Vitamin C

- i. Vitamin C is used as an adjuvant in infections. Beneficial effect of ascorbic acid is reported in the treatment of tuberculosis, when plasma level is kept near to saturation point. Clinical dose is 500 mg per day.
- ii. Because of its power to **heal wounds**, vitamin C has been recommended for treatment of ulcer, trauma, and burns. Except in scurvy and sub-scorbutic conditions the therapeutic use of vitamin is not specific.

### Megadose of Vitamin C

Linus Pauling (Nobel laureate) advocated megadoses (2000–5000 mg) of vitamin to prevent infections. But there is no clear evidence for this theory. Classical picture of scurvy did not include common cold or respiratory infections as major features. There is experimental evidence in animals that aging process is prevented by megadoses of vitamin C.

### Toxicity of Vitamin C

Since it is a water soluble substance, excess vitamin C is excreted, and not accumulated in the body. However, more than 2000 mg of vitamin C daily for a long time can cause iron overload, because vitamin C helps in absorption of iron.

### ■ RUTIN

**Rutin**, also called **vitamin P**, is found in many plants, fruits vegetables, black tea and apple peel. The richest source is buckwheat, next being citrus fruits (orange, grapefruit, lemon, lime). Its name comes from *Ruta graveolens*, a plant that also contains rutin. Rutin is the glycoside between the flavonol quercetin and the disaccharide rutinose. It is a strong antioxidant. Rutin has the property to chelate metal ions, such as iron, thereby reducing the Fenton reaction (production damaging oxygen radicals). Rutin also stabilizes vitamin C. If rutin is taken together with vitamin C, the activity of ascorbic acid will be intensified.

Furthermore, it has been shown to inhibit in vitro the vascular endothelial growth factor, and so inhibits angiogenesis seen in various

cancers. Rutin inhibits platelet aggregation and strengthens the capillaries and therefore clinically used in all types of bleedings. Rutin is used extensively in the treatment of athletic injuries. However, there are no clinical studies demonstrating significant, positive effects of rutin.

### ■ FLAVONOIDS

Over 5000 naturally occurring flavonoids have been characterized from various plants. Flavonoids (such as the catechins) are polyphenolic compounds in the human diet and are found ubiquitously in plants. Flavonoids, include *catechins* (found in strawberries and green teas), kaempferol (brussel sprouts and apples) and quercetin (beans.). Flavonoids may modify allergens, viruses, and carcinogens. They have anti-allergic, anti-inflammatory, anti-microbial and anti-cancer activities. Flavonoids are most commonly known for their antioxidant activity. The oxidation of low-density lipoprotein (LDL) has been recognized to play an important role in atherosclerosis. Flavonoids can protect LDL from being oxidized. The contribution of flavonoids to the antioxidant defense system may be substantial considering that the total daily intake of flavonoids can range from 50 to 800 mg. The citrus bioflavonoids include hesperidin (a glycoside of the flavanone hesperetin), quercitrin, rutin (two glycosides of the flavonol quercetin), and the flavone tangeritin.

Summary of folic acid, Vitamins B<sub>12</sub> and C are shown in Table 38.1. Other water soluble vitamins thiamine, riboflavin, niacin, pyridine, pantothenic acid and biotin are described in Chapter 37.

## Clinical Case Study 38.1

A 32-year-old female is being treated with methotrexate for a recently diagnosed choriocarcinoma of the ovary, and presents with complaints of oral mucosal ulcers. About 5 weeks ago the affected ovary was surgically removed. The patient has been taking methotrexate for 2 weeks. On examination, patient was afebrile but appeared ill. Several mucosal ulcers were seen in her mouth. The patient also had some upper abdominal tenderness. Her platelet count was decreased at 60,000/mm<sup>3</sup> (normal 150,000 to 450,000/mm<sup>3</sup>). What is the most likely etiology of her symptoms?

**TABLE 38.1:** Summary of water soluble vitamins discussed in this chapter

Name	Co-enzyme form	RDA	Main reaction using the co-enzyme	Deficiency disease
Folic acid	Tetrahydrofolic acid (THFA)	200 µg	One carbon group carrier	Macrocytic anemia Hyperhomocysteinemia
Cyanocobalamin (B <sub>12</sub> )	Adenosyl B <sub>12</sub> , methyl cobalamin	1–2 µg	Isomerization of methyl malonyl, CoA, remethylation of homocysteine to methionine	Megaloblastic anemia, subacute combined degeneration, methylmalonic aciduria, hyperhomocysteinemia
Ascorbic acid	No specific form	75 mg	Antioxidant property due to its reducing action, hydroxylation of collagen	Scurvy

Note: The requirements are significantly higher in pregnancy and lactation. See also Table 37.1 for other water soluble vitamins.



What is the biochemical explanation of her symptoms?  
What part of the cell cycle does methotrexate act on?

### Clinical Case Study 38.2

A 47-year-old female is brought to the emergency department with complaints of malaise, vomiting and fatigue. The patient reveals alcohol abuse for the last 10 years. She has been to rehab on several occasions for alcoholism but has not been able to stop drinking. She denies cough, fever, chills, upper respiratory symptoms. She reports feeling hungry. On physical examination, she appears malnourished but in no distress. Her physical examination is normal. Her blood count revealed a normal white blood cell count but also showed anemia with large red blood cells. Other tests were normal. What is the most likely cause of her anemia? What is the molecular basis for the large erythrocytes?

### Clinical Case Study 38.3

A 38-year-old vegetarian female presented to her doctor with fatigue and tingling/numbness in her extremities (bilateral). The symptoms were gradually getting worse over the last year. She reported frequent episodes of diarrhea and weight loss. On examination, she was pale with tachycardia. Her tongue was beefy red. Neurological examination revealed numbness in all extremities with decreased vibration senses. The CBC demonstrated megaloblastic anemia. What is the most likely diagnosis? What is the most likely underlying problem for this patient? What are the two most common causes of megaloblastic anemia and how would this patient's history and examination differentiate the two?

### Clinical Case Study 38.4

A 45-year-old man presented with loss of appetite, fatigue, muscle weakness and emotional disturbances. Physical examination showed enlarged liver that was firm and nodular, mild jaundice and smell of alcohol in breath. Hematological examination showed macrocytic anemia, and bone marrow showed presence of megaloblasts. Serum folate was reduced and Vitamin B<sub>12</sub> and iron were normal. What is the cause of megaloblastic anemia in this patient?

### Clinical Case Study 38.1 Answer

Likely cause of symptoms: Side effects of methotrexate (antimetabolite chemotherapy) affecting rapidly dividing cells such as oral mucosa. Folate antagonists inhibit dihydrofolate reductase (tetrahydrofolate needed for purine synthesis).

### Clinical Case Study 38.2 Answer

Cause of anemia: Folic acid deficiency.

Molecular basis of macrocytosis: Abnormal proliferation of erythroid precursors in the bone marrow, since folate deficiency encumbers the maturation of these cells by inhibition of deoxyribonucleic acid (DNA) synthesis.

### Clinical Case Study 38.3 Answer

Diagnosis: Cobalamin (vitamin B<sub>12</sub>) deficiency.

Underlying problem: Lack of cobalamin intake. Patients with folate deficiency have similar hematologic and GI findings but do not have the neurologic symptoms as with cobalamin deficiency. Treatment consists of identifying/treating the underlying cause of deficiency and replacement of cobalamin and folate.

### Clinical Case Study 38.4 Answer

Megaloblastic anemia can be due to different causes, like vitamin B<sub>12</sub> deficiency, folate deficiency, genetic defects in utilization of these vitamins or defects in DNA synthesis. Alcoholics are at particular risk for folate deficiency because of poor nutrition and defective absorption.

Folate is needed for one carbon metabolism, purine and pyrimidine synthesis, DNA and RNA replication, methionine synthesis, conversion of serine to glycine, and in various other transmethylation reactions.

Vegetarian diet without milk and lack of supplementation of cobalamin are the common causes for Vitamin B<sub>12</sub> deficiency. Absence of intrinsic factor, pernicious anemia, gastrectomy, pancreatic insufficiency, *Helicobacter pylori*, fish tapeworm infestation, decreased ileal absorption, Crohn's disease and surgical resection can also produce B<sub>12</sub> deficiency.

Symptoms are megaloblastic anemia, fatigue, weakness, palpitations, vertigo, tachycardia, sore, beefy-red

tongue, weight loss and diarrhea which are common for both folate and B<sub>12</sub> deficiencies. In addition, neurological symptoms are common for B<sub>12</sub> deficiency, these include numbness, paresthesia, weakness, ataxia, abnormal reflexes and diminished vibratory sensation. Treatment includes supplementation of folate and vitamin B<sub>12</sub>.

### ■ QUICK LOOK OF CHAPTER 38

1. THFA (tetrahydrofolic acid) is the carrier of one-carbon groups.
2. Macrocytic anemia is the most characteristic feature of folate deficiency.
3. FIGLU excretion test is used for assessment of folate status in man.
4. Folate antagonists are Sulfonamides, Trimethoprim, Pyrimethamine, Aminopterin and Amethopterin.
5. Absorption of vitamin B<sub>12</sub> requires the intrinsic factor (IF) of Castle. Transcobalamin-II, a glycoprotein, is the specific carrier of Vitamin B<sub>12</sub>.
6. B<sub>12</sub> containing enzymes in the human body are methyl malonyl CoA isomerase and homocysteine methyl transferase.
7. B<sub>12</sub> deficiency leads to pernicious anemia.
8. Man, higher primates, guinea pigs and bats are the only species which cannot synthesize ascorbic acid (vitamin C).
9. Scurvy is characterized by abnormal collagen, ecchymoses, hemorrhage and anemia.

# CHAPTER 39

## Mineral Metabolism and Abnormalities

### Chapter at a Glance

The reader will be able to answer questions on the following topics:

- Calcium, availability and functions
- Factors regulating blood calcium level
- Calcium, clinical applications
- Phosphorus
- Magnesium
- Sulfur
- Iron absorption, transport, deficiency
- Copper
- Zinc
- Fluoride
- Selenium
- Manganese, Molybdenum, Cobalt, Nickel
- Chromium, Lithium

Minerals are essential for the normal growth and maintenance of the body. If the daily requirement is more than 100 mg, they are called **major elements** or macrominerals. They are listed in Box 39.1.

If the requirement of certain minerals is less than 100 mg/day, they are known as minor elements or microminerals or **trace elements**. They are shown in Box 39.1, in order of their essentiality:

The following minerals are **necessary** for the body; but their exact functions are not known. They are chromium, nickel, bromine, lithium and barium. The following minerals are seen in tissues, but are **non-essential** and are contaminants in foodstuffs. These are rubidium, silver, gold, and bismuth. The following minerals are **toxic** and should be avoided: aluminium, lead, cadmium and mercury.

### ■ CALCIUM (Ca<sup>++</sup>)

Total calcium in the human body is about 1 to 1.5 kg, 99% of which is seen in bone and 1% in extracellular fluid.

### Sources of Calcium

**Milk** is a good source for calcium. Calcium content of cow's milk is about 100 mg/100 mL. Egg, fish and vegetables are medium sources for calcium. Cereals (wheat, rice) contain only small amount of calcium. But cereals are the staple diet in India. Therefore, cereals form the major source of calcium in Indian diet.

#### Box 39.1: Important minerals

##### Major elements

1. Calcium
2. Magnesium
3. Phosphorus
4. Sodium
5. Potassium
6. Chloride
7. Sulfur.

##### Trace elements

1. Iron
2. Iodine
3. Copper
4. Manganese
5. Zinc
6. Molybdenum
7. Selenium
8. Fluoride.

## Daily Requirement of Calcium

An adult needs **500 mg** per day and a child about 1200 mg/day. Requirement may be increased to 1500 mg/day during pregnancy and lactation. After the age of 50, there is a general tendency for osteoporosis, which may be prevented by increased calcium (1500 mg/day) plus vitamin D (20 µg/day).

## Absorption

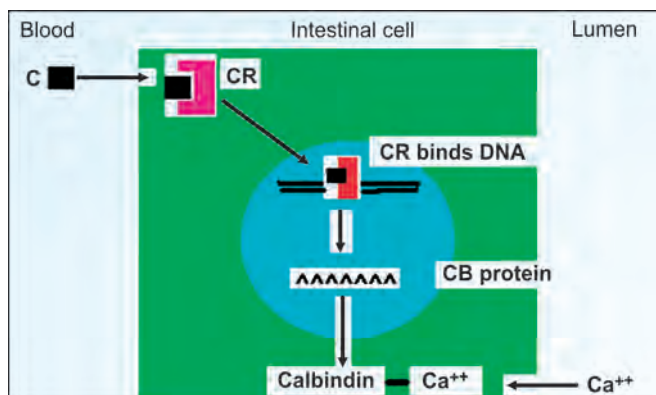
### Mechanism of Absorption of Calcium

Absorption is taking place from the first and second part of **duodenum**. Calcium is absorbed against a concentration gradient and requires energy. Absorption requires a carrier protein, helped by calcium-dependent ATPase.

Out of the 500 mg of calcium taken orally per day, 400 mg is excreted in stool and 100 mg is excreted through urine.

### Factors Causing Increased Absorption

- Vitamin D: Calcitriol** induces the synthesis of the carrier protein (**Calbindin**) in the intestinal epithelial cells, and so facilitates the absorption of calcium (Fig. 39.1).
- Parathyroid hormone:** It increases calcium transport from the intestinal cells by enhancing 1 $\alpha$  hydroxylase activity.
- Acidity** favors calcium absorption.
- Amino acids:** Lysine and arginine increase calcium absorption.



**Fig. 39.1:** Calcitriol increases calcium absorption  
C = calcitriol; CR = calcitriol receptor complex; CB = calbindin.

### Factors Causing Decreased Absorption

- Phytic acid:** Hexaphosphate of inositol is present in cereals. Fermentation and cooking reduce phytate content.
- Oxalates:** They are present in some leafy vegetables, which cause formation of insoluble calcium oxalates.
- Malabsorption syndromes:** Fatty acid is not absorbed, causing formation of insoluble calcium salt of fatty acid.
- Phosphate:** High phosphate content will cause precipitation as calcium phosphate. The optimum ratio of calcium to phosphorus which allows maximum absorption is 1:2 to 2:1 as present in milk.

## Calcium in Cells

Calcium is present both in the extracellular and intracellular compartments. However, it is mainly extracellular.

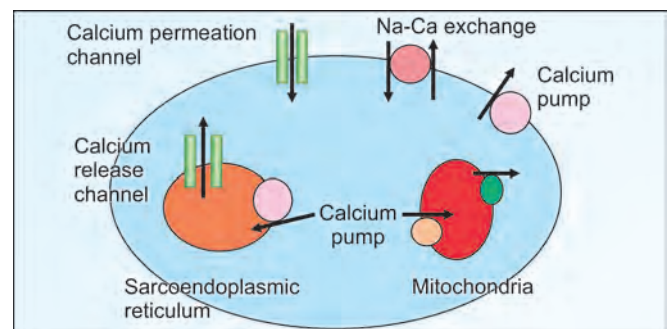
The cell membrane is generally impermeable to calcium ions. Calcium influx into the cell is by Na<sup>+</sup>/Ca<sup>++</sup> exchange mechanism. This mechanism is rapid, but has low affinity for calcium (Fig. 39.2).

Entry of Ca<sup>++</sup> into mitochondria is by a calcium uniport system. But calcium ions exit by a Na<sup>+</sup>-Ca<sup>++</sup> antiport system, which in turn is dependent on the Na<sup>+</sup>-H<sup>+</sup>-ATPase pump. For calcium channels, see Chapter 2.

## Functions of Calcium

### Activation of Enzymes

Calmodulin is a calcium binding regulatory protein, with a molecular weight of 17,000 Daltons. **Calmodulin** can bind



**Fig. 39.2:** Calcium channels are different types



with 4 calcium ions. Calcium binding leads to activation of enzymes. Calmodulin is part of various regulatory **kinases**. The mechanism of action is summarized in Figure 39.3. Calmodulin dependent enzymes are listed in Box 39.2.

Some other enzymes are activated directly by  $\text{Ca}^{++}$  without the intervention of calmodulin; examples are pancreatic lipase; enzymes of coagulation pathway; and rennin (milk clotting enzyme in stomach).

### Muscles

Calcium mediates **excitation and contraction** of muscle fibers. Different types of calcium channels are shown in Figure 39.2. Upon getting the neural signal, calcium is released from sarcoplasmic reticulum. Calcium activates ATPase; increases action of actin and myosin and facilitates excitation-contraction coupling. The trigger of muscle contraction is the interaction of calcium with Troponin C (see Chapter 58). The active transport system utilizing calcium binding protein is called **calsequestrin**. Calcium decreases neuromuscular irritability. Calcium deficiency causes tetany.

### Nerve Conduction

Calcium is necessary for transmission of **nerve** impulses from pre-synaptic to post-synaptic region.

### Secretion of Hormones

Calcium mediates secretion of Insulin, parathyroid hormone, calcitonin, vasopressin, etc. from the cells.

### Second Messenger

Calcium and cyclic AMP are second messengers of different hormones (see Table 50.1). One example is glucagon. Calcium is used as second messenger in systems involving G proteins and inositol triphosphate.

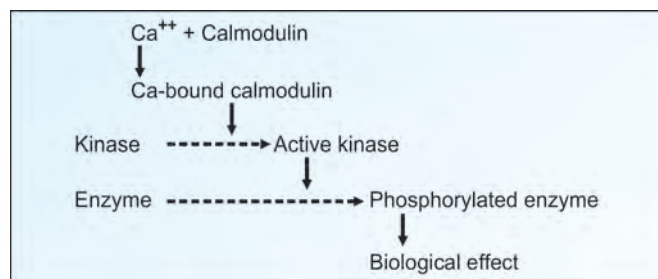


Fig. 39.3: Mechanism of action of calmodulin

### Vascular Permeability

Calcium decreases the passage of serum through capillaries. Thus, calcium is clinically used to reduce allergic exudates.

### Coagulation

Calcium is known as factor IV in blood coagulation cascade. Prothrombin contains gamma-carboxyglutamate residues which are chelated by  $\text{Ca}^{++}$  during the thrombin formation (see Chapter 36, under vitamin K).

### Myocardium

$\text{Ca}^{++}$  **prolongs systole**. In hypercalcemia, cardiac arrest is seen in systole. This fact should be kept in mind when calcium is administered intravenously. It should be given very slowly.

### Bone and Teeth

The bulk quantity of calcium is used for bone and teeth formation. Bones also act as reservoir for calcium in the body. Osteoblasts induce bone deposition and osteoclasts produce demineralization.

### Calpains

Calpains are a family of calcium-dependent, cysteine proteases (proteolytic enzymes) seen ubiquitously in mammals. The activity was found to be attributable to two main isoforms, calpain I and II, that differ in their calcium requirements in vitro. These two heterodimeric isoforms share an identical small (30 k) subunit, but have distinct large (80 k) subunits.

Calpains are involved in cell mobility, cell cycle progression, potentiation in neurons and cell fusion in myoblasts. When defective, the mammalian calpain 3 (p94) is the gene product responsible for limb-girdle muscular dystrophy. Calpain 10 has been identified as a susceptibility gene for type 2 diabetes mellitus, and calpain 9 has

#### Box 39.2: Selected list of enzymes regulated by $\text{Ca}^{++}$ and mediated by calmodulin

- Adenyl cyclase
- $\text{Ca}^{++}$  dependent protein kinases (PKC)
- $\text{Ca}^{++}$  - $\text{Mg}^{++}$  -ATPase
- Glycerol-3-phosphate dehydrogenase
- Glycogen synthase
- Myosin kinase
- Phospholipase C
- Phosphorylase kinase
- Pyruvate carboxylase
- Pyruvate dehydrogenase
- Pyruvate kinase

been identified as a tumor suppressor for gastric cancer. Hyperactivity of calpain is implicated in Alzheimer's disease, cataract formation, myocardial ischemia, and in cerebral ischemia.

Increase in concentration of calcium in the cell results in calpain activation, which leads to unregulated proteolysis and consequent irreversible tissue damage. This can lead to degradation of the cytoskeleton and plasma membrane. Upon reperfusion of the ischemic myocardium, there is development of calcium overload or excess in the heart cell (cardiomyocytes). This increase in calcium leads to activation of calpain.

The endogenous calpain-specific inhibitor is called **Calpastatin**. It is also involved in the proteolysis of amyloid precursor protein. The calpain/calpastatin system is involved in membrane fusion events, such as neural vesicle exocytosis and platelet aggregation.

### Calcium in Blood

- i. **Normal blood level:** Normal calcium level is **9–11 mg/dL**. (10 mg/dL of  $\text{Ca}^{++}$  = 5 mEq/L).
- ii. **Ionized calcium:** About 5 mg/dL of calcium is in ionized form and is metabolically active (Fig. 39.4). Another 1 mg/dL is complexed with phosphate, bicarbonate and citrate. These two forms are diffusible from blood to tissues.
- iii. **Protein bound calcium:** About 4 mg/dL of calcium is bound to proteins in blood and is nondiffusible.

### Factors Regulating Blood Calcium Level

There are effective controls to maintain this narrow range of blood calcium (**9–11 mg/dL**).

#### Vitamin D

- i. Structure of Vitamin D, causes for vitamin D deficiency and clinical features of rickets are described in detail in Chapter 36. Cholecalciferol is synthesized from 7-dehydrocholesterol in skin, under the influence of sunlight. It is then hydroxylated at 25th position in liver and further hydroxylated at the 1st position in kidney. The active derivative is called dihydroxy-cholecalciferol or **calcitriol**. Calcitriol and calcitonin are different (Box 39.3).

Ionized form	5 mg/dL
Complexed with anions	1 mg/dL
Bound with proteins	4 mg/dL

Fig. 39.4: Different forms of calcium in serum

- ii. **Vitamin D and absorption of calcium:** Calcitriol promotes the absorption of calcium and phosphorus from the intestine. **Calcitriol** enters the intestinal cell and binds to vitamin D receptor (VDR). The hormone-receptor complex interacts with DNA and causes **derepression** and consequent transcription of specific genes that code for Calbindin (Fig. 39.1). Due to the increased availability of calcium binding protein, the absorption of calcium is increased. Hence, blood calcium level tends to be elevated.
- iii. **Vitamin D and bone:** Vitamin D is acting independently on bone. Vitamin D increases the number and activity of **osteoblasts**, the bone forming cells. It also has a role in osteoclastogenesis. Calcitriol stimulates osteoblasts to secrete **alkaline phosphatase**. Due to this enzyme, the local concentration of phosphate is increased. The ionic product of calcium and phosphorus increases, leading to mineralization and remodeling of bone (Fig. 39.5).
- iv. **Vitamin D and renal tubules:** Calcitriol increases the reabsorption of calcium and phosphorus by renal tubules, therefore both minerals are conserved. (PTH conserves only calcium). Deficiency manifestations of vitamin D are described in Chapter 36.

Calcitriol increases secretion of **Klotho protein** from kidney (Fig. 39.5). This will increase the expression of the epithelial calcium channel **TRPV5** (transient receptor potential channel), which stimulates calcium reabsorption in the distal convoluted tubule. (Klotho could also favor intestinal calcium absorption by facilitating the expression and function of TRPV6). Klotho protein has beta-glucosidase activity. It is produced predominantly in the kidney. Klotho-deficient mice show increased production of vitamin D, and altered calcium homeostasis. Variants of Klotho gene have been associated with human aging. Klotho protein may protect the cardiovascular system through endothelium-derived nitric oxide production.

#### Parathyroid Hormone (PTH)

- i. This hormone is secreted by the four parathyroid glands embedded in the thyroid tissue. The chief cells of the gland secrete the PTH.
- ii. It is synthesized as prepro-PTH with 115 amino acids. In the endoplasmic reticulum and in the Golgi apparatus, the prepro-PTH is broken to form the

#### Box 39.3: Calcitonin and calcitriol are different

**Calcitonin** is the peptide hormone released from thyroid gland. It decreases blood calcium level.

**Calcitriol** is the active form of vitamin D. It increases the blood calcium.

mature PTH with 84 amino acids. Storage of PTH is only for about 1 hour. This may be compared with the storage of insulin for several days and thyroxine for several weeks.

- iii. The first 35 amino acids of PTH are biologically active. Control of release of the hormone is by negative feedback by the ionized calcium in serum. The release of hormone is mediated by cyclic AMP.
- iv. The normal PTH level in serum is 10–60 ng/L. In primary hyperparathyroidism, this is increased to 100 ng/L.

#### Mechanism of Action of PTH

- i. PTH binds with a receptor protein (molecular weight 70,000 Daltons) on the surface of target cells. This activates **adenyl cyclase** with consequent increase in intracellular calcium concentration. A kinase is activated and enzyme systems are activated. The PTH has three major independent sites of action; bone, kidney and intestines. All the three actions of PTH increase serum calcium level.
- ii. **PTH and bones:** In the bone, PTH causes demineralization or decalcification (Fig. 39.5). It induces pyrophosphatase in the **osteoclasts**. The number of

osteoclasts are also increased. Osteoclasts release lactate into surrounding medium which solubilizes calcium. PTH also causes secretion of collagenase from osteoclasts. This causes loss of matrix and bone resorption. As a consequence, mucopolysaccharides and hydroxyproline are excreted in urine.

- iii. **PTH and kidney:** In kidney, PTH causes decreased renal excretion of calcium and increased excretion of phosphates. The action is mainly through increase in **reabsorption of calcium** from kidney tubules.
- iv. **PTH and intestines:** PTH stimulates 1-hydroxylation of 25-hydroxycalciferol in kidney to produce calcitriol. This indirectly increases calcium absorption from intestine.

#### Calcitonin

- i. It is secreted by the thyroid parafollicular or clear cells. Calcitonin and Calcitriol are different (Box 39.3). Calcitonin is a polypeptide with 32 to 34 amino acids, depending on the species difference.
- ii. Calcitonin secretion is stimulated by serum calcium, gastrin, glucagon and biological amines.
- iii. Calcitonin level is increased in medullary carcinoma of thyroid and therefore is a **tumor marker**. The level is also increased in multiple endocrine neoplasia (MEN). Hyper-calcitoninemia may also result from ectopic calcitonin production from malignant tumors of the lung and bronchus.
- iv. Calcitonin decreases serum calcium level. It **inhibits resorption of bone**. It decreases the activity of osteoclasts and increases that of osteoblasts.
- v. Calcitonin and PTH are directly antagonistic. The PTH and calcitonin together promote the bone growth and remodeling. In kidney, calcitonin increases phosphorus excretion through urine; this action is similar to PTH (Table 39.1).

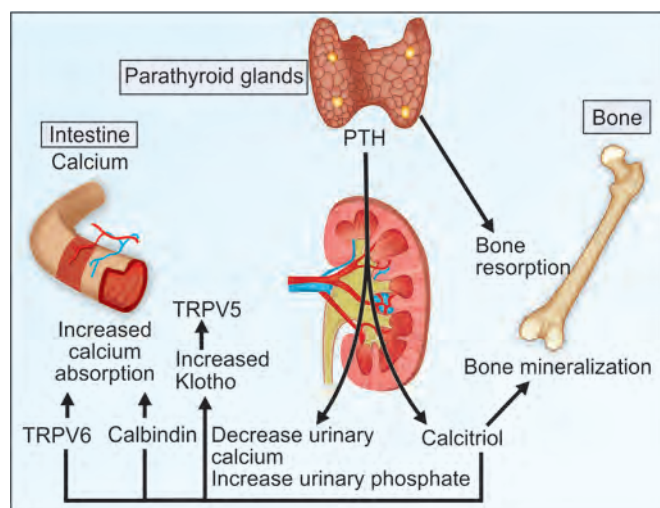


Fig. 39.5: Calcium homeostasis

When serum calcium is low, PTH is stimulated, resulting in increased calcium release from bone and decreased renal calcium excretion. PTH also stimulates increased production of calcitriol, which acts to increase absorption of calcium from intestine

#### Calcitonin, Calcitriol and PTH Act Together

When blood calcium tends to lower, PTH secretion is stimulated and calcitonin is inhibited; bone demineralization leads to entry of more calcium into blood. When blood calcium is increased, PTH is inhibited and calcitonin is secreted, causing more entry of calcium into bone. These effects are summarized in Figure 39.5 and Table 39.1. Bone acts as the major reservoir of calcium.

### Procalcitonin (PCT)

It is a relatively new marker that has been associated with inflammation and sepsis. It is a 116-amino-acid protein that is the precursor to calcitonin. The PCT plasma level in healthy individuals is low; usually below 0.1 ng/mL. The levels have been shown to rise with severity of sepsis. Over the last decade, PCT has become increasingly popular as a novel marker of infection in the intensive care unit. PCT is markedly elevated in acute bacterial infections; but not in viral infections.

### Phosphorus

There is a **reciprocal** relationship of calcium with phosphorus. The ionic product of calcium and phosphorus in serum is kept as a constant. (In normal adults, calcium = 10 mg/dL  $\times$  phosphorus 4 mg/dL; so ionic product is 40). In renal insufficiency, phosphorus excretion is diminished; phosphorus level in blood is increased and calcium level is lowered. This may lead to tetany.

### Children

In **children**, the calcium level tends to be near the upper limit. In children, ionic product of calcium and phosphorus in blood is about 50 (instead of 40 in normal adults).

### Serum Proteins

In hypoalbuminemia (e.g. nephrosis, malnutrition), the total calcium is decreased. About 0.8 mg/dL of calcium is reduced with lowering of each g/dL of albumin. In such cases, the metabolically active ionized form is normal, and so there will be no deficiency manifestations.

**TABLE 39.1:** Comparison of action of the three major factors affecting serum calcium

	Vitamin D	PTH	Calcitonin
Blood calcium	Increased	Drastically increased	Decreased
Main action	Absorption from gut	Demineralization	Opposes demineralization
Calcium absorption from gut	Increased	Increased (indirect)	
Bone resorption	Decreased	Increased	Decreased
Deficiency manifestation	Rickets	Tetany	
Use in Rickets	Drug of choice	Contraindicated	Theoretically beneficial
Effect of excess	Hypercalcemia <sup>+</sup>	Hypercalcemia <sup>++</sup>	Hypocalcemia

### Alkalosis and Acidosis

Alkalosis favors binding of more calcium with proteins, with consequent lowering of ionized calcium. Here total calcium level is normal, but calcium deficiency may be manifested. Acidosis favors ionization of calcium.

### Kidney Threshold

The renal threshold for calcium in blood is 10 mg/dL. Calcium starts getting excreted in urine when this level is reached. When injected intravenously, most of the calcium is rapidly excreted.

### Hypercalcemia

- The term denotes that the blood calcium level is more than 11 mg/dL. The calcium level should be tested in suspected clinical conditions (Box 39.4). The major cause is **hyperparathyroidism**. This may be due to a parathyroid adenoma or an ectopic PTH secreting tumor. Important causes of hypercalcemia are enumerated in Box 39.5.
- There is osteoporosis and X-ray shows punched out areas of bone resorption. Pathological fracture of bone may result. Box 39.6 gives major symptoms of hypercalcemia.
- In the blood, calcium and alkaline phosphatase levels are increased, while phosphate level is lowered.
- In urine, calcium is excreted, which may cause inhibition of elimination of chloride. This may lead to **hyperchloremic acidosis**. Calcium may be precipitated in urine, leading to recurrent bilateral urinary **calculi**. Ectopic calcification may be seen in renal tissue, pancreas (pancreatitis), arterial walls, and muscle tissues (myositis ossificans).
- In multiple myeloma, Paget's disease and metastatic carcinoma of bone, there will be bone resorption and hypercalcemia.

Box 39.7 narrates the treatment policy in hypercalcemia.

#### Box 39.4: When to check calcium level?

- Neurological symptoms, irritability, seizures
- Renal calculi
- Ectopic calcification
- Suspected malignancies
- Polyuria and polydypsia
- Chronic renal failure
- Prolonged drug treatment, which may cause hypercalcemia (Vitamin D, thiazide diuretics).



## Parathyroid Function Tests

1. Estimation of serum calcium, phosphate and alkaline phosphatase.
2. Urinary calcium and phosphate levels.
3. **Calcium load test:** Intravenous calcium will lower PTH levels in normal persons. In urine, calcium is excreted, no phosphates are seen.
4. **TRP (tubular reabsorption of phosphate) test:** Normally 90% of phosphates in glomerular filtrate are reabsorbed from renal tubules back into serum. PTH inhibits this reabsorption.
5. **PTH level in serum;** by radioimmunoassay.

### Box 39.5: Causes of hypercalcemia

1. Hyperparathyroidism
2. Multiple myeloma
3. Paget's disease
4. Metastatic carcinoma of bone
5. Thyrotoxicosis, Addison's disease
6. Benign familial hypercalcemia
7. Dehydration
8. Prolonged immobilization
9. Tuberculosis, leprosy, sarcoidosis
10. Milk-alkali syndrome
11. Drugs
  - Thiazide diuretics
  - Excess vitamin D or vitamin A
  - Excess calcium given IV
  - Lithium therapy
  - Theophylline.

### Box 39.6: Symptoms of hypercalcemia

1. Anorexia, nausea, vomiting
2. Polyuria and polydypsia (ADH antagonism)
3. Confusion, depression, psychosis
4. Renal stones
5. Ectopic calcification and pancreatitis
6. Blood alkaline phosphatase is increased.

### Box 39.7: Management of hypercalcemia

Adequate hydration, IV normal saline  
 Furosemide IV to promote calcium excretion  
 Steroids, if there is calcitriol excess  
 Beta blockers in thyrotoxicosis  
 Definitive treatment for the underlying disorder.

## Hypocalcemia

### Tetany

1. Causes of hypocalcemia are enumerated in Box 39.8. When serum calcium level is less than 8.8 mg/dL, it is hypocalcemia. If serum calcium level is less than 8.5 mg/dL, there will be mild tremors. If it is lower than 7.5 mg/dL, tetany, a life-threatening condition will result. Symptoms of hypocalcemia are enumerated in Box 39.9.
- ii. **Tetany** may be due to accidental surgical removal of parathyroid glands or by autoimmune diseases. In tetany, neuromuscular irritability is increased.

### Box 39.8: Causes of hypocalcemia

1. **Deficiency of Vitamin D**
  - Decreased exposure to sunlight
  - Malabsorption, dietary deficiency
  - Hepatic diseases
  - Decreased renal synthesis of calcitriol
  - Nephrotic syndrome (binding protein lost)
  - Anticonvulsant therapy
2. **Deficiency of Parathyroid**
  - Hypoparathyroidism (primary, secondary)
  - Pseudohypoparathyroidism
3. **Increased Calcitonin**
  - Medullary carcinoma of thyroid
  - Ectopic secretion of tumors
4. **Deficiency of Calcium**
  - Intestinal malabsorption
  - Acute pancreatitis
  - Infusion of agents complexing calcium
  - Alkalosis decreasing ionized calcium
5. **Deficiency of Magnesium**
6. **Increase in Phosphorus level**
  - Renal failure
  - Phosphate infusion
  - Renal tubular acidosis
7. **Hypoalbuminemia.**

### Box 39.9: Symptoms of hypocalcemia

1. Muscle cramps
2. Paresthesia, especially in fingers
3. Neuromuscular irritability, muscle twitchings
4. Tetany (Chvostek's sign, Trousseau's sign)
5. Seizures
6. Bradycardia
7. Prolonged QT interval

- iii. Main manifestation is carpopedal spasm (Fig. 39.6). Laryngismus and stridor are associated findings. Laryngeal spasm may lead to death. **Chvostek's sign** (tapping over facial nerve causes facial contraction) will be positive (described by Frantisek Chvostek, Czech physician in 1876). **Trousseau's sign** (inflation of BP cuff for 3 minutes causes carpopedal spasm) could be elicited (French physician Armand Trousseau described it in 1861).
- iv. Increased Q-T interval in ECG is seen. Serum calcium is lowered with corresponding increase in phosphate level. Urinary excretion of both calcium and phosphate are decreased. Treatment is to give intravenous injection of calcium salts.
- v. It should be emphasized that **vitamin D deficiency will not cause tetany**. The vitamin D deficiency causes rickets, where serum calcium level is lowered marginally. Treatment policy of hypocalcemia is shown in Figure 39.10.

### Pseudo-hypoparathyroidism

It is an X-linked dominant condition. Although PTH level is normal, there is lack of end organ response to PTH. This leads to hypocalcemia and hyperphosphatemia.

### Mild Decrease in Serum Calcium

Vitamin D insufficiency, renal diseases (defective formation of calcitriol), dietary deficiency of calcium, and magnesium deficiency will result in mild decrease in serum calcium. Chronic calcium deficiency will lead to deformities of bones, especially in weight-bearing bones (Fig. 39.7A).

### Bone Mineralization and Demineralization

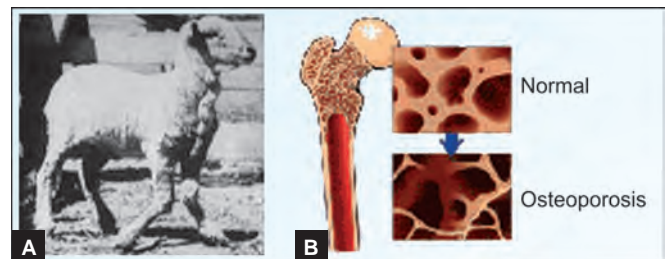
Bone is a specialized connective tissue made up of a matrix with embedded fibers, cells and apatite crystals (Fig. 39.7B). See Box 39.11 for the requirement for bone production.



Fig. 39.6: Carpopedal spasm in tetany

**Mineralization of bone:** It is the process by which inorganic calcium and phosphate are deposited on the organic matrix. The specialized matrix in bone is termed **Osteoid**. In cementum, the matrix is called Cementoid. In dentine, the equivalent layer is known as predentine. In enamel, there is no equivalent, since the matrix is rapidly calcified. **Osteocalcin** is a unique protein seen in bone. The osteoblasts synthesize and secrete organic matrix, which is then mineralized. Osteoclasts are involved in bone resorption. Combined activities of osteoblasts and osteoclasts are important in bone remodeling. The osteoblasts are under the effect of hormones PTH and calcitriol. Secretion of **alkaline phosphatase** by osteoblasts is increased by vitamin D. The enzyme liberates phosphate from substrates. So the ionic concentration of [calcium × phosphate] is increased to supersaturation level. Calcium phosphate is deposited as **hydroxyapatite** crystals over the matrix of triple stranded quarter staggered collagen molecules (see Chapter 52). Calcium in the bone is in dynamic equilibrium with serum calcium; hydroxyapatite in trabecular bone acts as a reservoir.

Compact bone ←	Trabecular bone ↔	Serum calcium
$\text{Ca}_3(\text{PO}_4)_2$	$\text{Ca}_{10}(\text{PO}_4)_6(\text{OH})_2$	$\text{Ca}^{++}$
(Total 1kg)	(Total about 5 g)	(Total 500 mg)



Figs 39.7A and B: (A) Knock-knee defect in deficiency of calcium and phosphorus; (B) Comparison of normal and osteoporotic bone tissue

#### Box 39.10: Treatment of hypocalcemia

1. Oral calcium, with vitamin D supplementation
2. Underlying cause should be treated
3. Tetany needs IV calcium (usually 10 mL 10% calcium gluconate over 10 minutes, followed by slow IV infusion. IV calcium should be given only very slowly.

#### Box 39.11: Requirements for growth of bone

1. Calcium
2. Phosphorus
3. Vitamin D and Calcitriol
4. Parathyroid hormone
5. Calcitonin
6. Vitamin A (for ground substance)
7. Vitamin C
8. Sex steroids
9. Amino acids.

## Osteoporosis

After the age of 40–45, calcium absorption is reduced and calcium excretion is increased; so, there is a net negative balance for calcium. This is reflected in demineralization. After the age of 60, osteoporosis is seen (Fig. 39.7B). Then there is reduced bone strength and an increased risk of fractures. Decreased absorption of vitamin D and reduced levels of androgens/estrogens in old age are the causative factors. Interleukin-1 and 6 also play important roles in the genesis of the condition. Osteoporosis is more severe and starts early in Indians, compared to Westerners.

Treatment in the advanced phase of osteoporosis (OP) is not sufficient to prevent bone fracture. So, early diagnosis of OP is done by bone mineral density (BMD). Currently, dual energy X-ray absorptiometry (DXA) is the gold standard diagnostic tool for BMD measurement. Biochemical bone turnover markers are described below. Please see Table 39.2 as well.

## Osteopetrosis

It is otherwise called marble bone disease. There is increased bone density. It is due to mutation in gene encoding carbonic anhydrase type II. The deficiency of the enzyme in osteoclasts leads to inability of bone resorption.

## Paget's Disease

Localized disease of bone characterized by osteoclastic bone resorption followed by disordered replacement of bone. It is common in people above 40 and may affect one or several bones. Familial incidence is also reported. Bone markers are useful in monitoring response to treatment using bisphosphonates.

## Renal Osteodystrophy

Secondary hyperparathyroidism as a consequence of persistent hypocalcemia causes high turnover bone disease, osteitis fibrosa. Osteomalacia may result (low bone turnover) due to defective synthesis of 1,25 DHCC.

## Markers of Bone Diseases

Metabolic bone diseases result from an imbalance between bone resorption and bone formation. Osteopenia is more common than excess bone formation.

### General Markers

Serum calcium, serum inorganic phosphorus, serum magnesium and urinary excretion of calcium and phosphorus, total alkaline phosphatase and total acid phosphatase levels. These are the routine tests of bone metabolism. Vitamin D nutrition should be determined by measuring serum 25-hydroxy vitamin D. PTH measurement would be required if serum calcium is abnormal.

### Markers of Bone Resorption

1. Teloptides:
  - a. Serum carboxy-terminal telopeptide of type I collagen (s-CTx)
  - b. N-telopeptide of type I collagen (NTX)
2. Pyridinium cross links derived from collagen
3. Tartrate resistant acid phosphatase (TRAP)
4. Urinary hydroxyproline excretion.

Type I collagen forms 90% of the organic matrix of the bone. These markers originate as breakdown products of mature matrix collagen. Teloptides and pyridinium cross links are released into circulation. Effective treatment decreases their level. Major source of hydroxyproline in urine is collagen breakdown.

**TABLE 39.2:** Metabolic bone diseases and markers of MBD

Disease	Causes	Features	Markers
Osteoporosis	Senile osteoporosis often postmenopausal more common. Secondary to diseases and during treatment. Poor nutrition, inadequate exercise, endocrine causes, both deficiency and excess	Decreased bone mass	BAP and s-OC increased. Monitoring therapy
Osteomalacia	Hypovitaminosis D	Bone pain	25 OH D <sub>3</sub> –low BAP –High Ca and P –N or low
Rickets	Deficiency of vitamin D—acquired inherited —Vitamin D resistant Increased osteoid and unmineralized matrix	Mineralization defect during bone formation	BAP high Calcium low Phosphate low
Renal osteodystrophy	Associated with chronic renal failure High turnover bone disease—osteitis fibrosa or secondary hyperparathyroidism more common. Low turnover bone disease—Osteomalacia	Bone pain	Low calcium and phosphate, high BAP, PTH low 25 OH D3
Paget's disease	Osteoclastic bone resorption and replacement of bone not balanced	Multiple bones affected > 40 years	BAP, N and C telopeptides high
Others	Hyperparathyroidism, multiple myeloma and thyrotoxicosis and Cushing's disease	Features of specific conditions	Ca, phosphate, BAP, proteins, Ig, serum hormones

Serum TRAP exists in the two isoforms 5a and 5b with only 5b being specific for osteoclasts. TRAP 5b might be an indicator of bone resorption in a very early stage of renal osteodystrophy.

The International Federation of Clinical Chemistry and Laboratory Medicine (IFCC) recommend that serum C-terminal telopeptide of type I collagen (s-CTX) is the marker for bone resorption in clinical studies.

### Markers of Bone Formation

1. Serum bone specific isoenzyme of alkaline phosphatase (sBAP)
2. Serum osteocalcin (s-OC)
3. Serum midportion of osteocalcin (sm-OC)
4. Procollagen type 1 peptidase
5. Serum intact osteocalcin (s-OC)
6. Serum amino-terminal propeptide of type I collagen (PINP).

BAP is increased in metabolic bone diseases. Advantages over osteocalcin is that clinically it is more specific and sensitive in monitoring diseases, especially Paget's disease.

**Osteocalcin** is the major noncollagen protein in human bone. It has 49 amino acids and forming about 1% of total protein in bones. During bone formation, 10–30% of osteocalcin synthesized is released into circulation. In metabolic bone diseases with increased osteoid formation it is increased. Procollagen peptidase that cleaves peptides from collagen during maturation can also be used as a marker, though less specific and sensitive.

The International Federation of Clinical Chemistry and Laboratory Medicine (IFCC) recommend that serum procollagen type I N propeptide (s-PINP) is the marker of bone formation in clinical studies.

## PHOSPHORUS

Total body phosphate is about 1 kg; 80% of which is seen in bone and teeth and 10% in muscles. Phosphate is mainly an intracellular ion and is seen in all cells. Functions of phosphate ions are enumerated in Box 39.12.

### Box 39.12: Functions of phosphate ions

1. Formation of bone and teeth
2. Production of high energy phosphate compounds, such as ATP, CTP, GTP, creatine phosphate, etc.
3. Synthesis of nucleoside co-enzymes, such as NAD and NADP
4. DNA and RNA synthesis, where phosphodiester linkages form the backbone of the structure
5. Formation of phosphate esters, such as glucose-6-phosphate, phospholipids
6. Formation of phosphoproteins, e.g. casein
7. Activation of enzymes by phosphorylation
8. Phosphate buffer system in blood. The ratio of  $\text{Na}_2\text{HPO}_4$ :  $\text{NaH}_2\text{PO}_4$  in blood is 4:1. This maintains the pH of blood at 7.4.

### Requirement and Source

Requirement is about 500 mg/day. Milk is a good source, which contains about 100 mg/dL phosphate. Cereals, nuts and meat are moderate sources. Calcitriol increases phosphate absorption.

### Serum Level of Phosphorus

Serum level of phosphate is **3–4 mg/dL** in normal adults and is 5–6 mg/dL in children. Fasting levels are higher. The postprandial decrease of phosphorus is due to the utilization of phosphate for metabolism. Monovalent and divalent phosphate ions are present in plasma at a ratio of 1:9 in alkalosis, at a ratio of 1:4 at pH 7.4, and at a ratio of 100:1 at pH of 4.5 in urine.

The whole blood phosphate is 40 mg/dL. This is because RBCs and WBCs contain a lot of phosphates. Hemolysis should be prevented when blood is taken for phosphate estimation.

Serum phosphate level is decreased in hyperparathyroidism and rickets. Box 39.13 shows the conditions in which phosphate level is to be assessed. Causes of hyperphosphatemia are given in Box 39.14, and those of hypophosphatemia in Box 39.15. Box 39.16 enumerates the conditions in which alterations of calcium and phosphate levels are seen.

Phosphorus holds an inverse relationship with calcium. An excess of serum calcium or phosphate results in the excretion of the other by the kidney. The phosphate level is regulated by excretion through urine. Renal threshold is 2 mg/dL. Usually 500 mg of phosphate is excreted through urine per day. Urinary phosphate excretion is influenced by many factors including muscle mass, renal function and age. A diurnal variation in urine phosphate excretion has been noted, with the highest output occurring in the afternoon.

### Box 39.13: Phosphate level is to be checked when there is suspicion of

1. Renal tubular disease
2. Hyperparathyroidism
3. Hypoparathyroidism
4. Bone diseases, such as rickets
5. Muscle weakness
6. Renal failure.



Like calcium, phosphate level in blood is controlled by the parathyroid hormone. PTH increases calcium and phosphate release from the bone and decreases loss of calcium and increases loss of phosphate in the urine.

### Fibroblast Growth Factor 23 (FGF-23)

It acts on the kidney to inhibit the reabsorption of phosphate and the synthesis of 1,25(OH)<sub>2</sub>D (1,25 dihydroxy vitamin D). FGF23 downregulates the gene for 1 alpha hydroxylase and decreases synthesis of 1,25 DHCC. It upregulates the 24 hydroxylase gene thus forming the inactive 24,25 DHCC. Disorders of increased FGF-23 function are associated with hypophosphatemia, inappropriately low 1,25(OH)<sub>2</sub>D levels, and either rickets or osteomalacia. Conversely, decreased FGF-23 activity results in hyperphosphatemia, increased 1,25(OH)<sub>2</sub>D levels,

and abnormal soft-tissue calcification. Increase in FGF-23 is being investigated as a marker of disease progression in chronic kidney disease.

## MAGNESIUM (Mg<sup>++</sup>)

Magnesium is the fourth most abundant cation in the body and second most prevalent intracellular cation. Magnesium is mainly seen in intracellular fluid. Total body magnesium is about 25 g, 60% of which is complexed with calcium in bone. One-third of skeletal magnesium is exchangeable with serum. Magnesium orally produces diarrhea; but intravenously it produces CNS depression.

### Requirement

The requirement is about 400 mg/day for men and 300 mg/day for women. Doses above 600 mg may cause diarrhea. More is required during lactation. Major sources are cereals, beans, leafy vegetables and fish.

### Normal Serum Level of Magnesium

Normal serum level Mg<sup>++</sup> is 1.8–2.2 mg/dL. Inside the RBC, the magnesium content is 5 mEq/L. In muscle tissue, Mg<sup>++</sup> is 20 mEq/L. About 70% of magnesium exists in free state and remaining 30% is protein-bound (25% to albumin and 5% to globulin). Serum must be separated from the clot as soon as possible or the level of magnesium will increase because of its elution from the red blood cells. Hemolyzed samples as well as blood collected with citrate, oxalate or EDTA are unacceptable for analysis. Homeostasis is maintained by intestinal absorption as well as by excretion by kidney. Magnesium is reabsorbed from loop of Henle and not from proximal tubules.

### Functions of Magnesium

1. Mg<sup>++</sup> is the activator of many enzymes requiring ATP. Alkaline phosphatase, hexokinase, fructokinase, phosphofructokinase, adenylyl cyclase, cAMP dependent kinases, etc. need magnesium.
2. Neuromuscular irritability is lowered by magnesium.
3. Insulin-dependent uptake of glucose is reduced in magnesium deficiency. Magnesium supplementation improves glucose tolerance.

#### Box 39.14: Causes of hyperphosphatemia

1. Increased absorption of phosphate
  - Excess vitamin D
  - Phosphate infusion
2. Increased cell lysis
  - Chemotherapy for cancer
  - Bone secondaries
  - Rhabdomyolysis
3. Decreased excretion of phosphorus
  - Renal impairment
  - Hypoparathyroidism
4. Hypocalcemia
5. Massive blood transfusions
6. Thyrotoxicosis
7. Drugs
  - Chlorothiazide, Nifedipine, Furosemide.

#### Box 39.15: Causes of hypophosphatemia

1. Decreased absorption of phosphate
  - Malnutrition
  - Malabsorption
  - Chronic diarrhea
  - Vitamin D deficiency
2. Intracellular shift
  - Insulin therapy, glucose phosphorylation
  - Respiratory alkalosis
3. Increased urinary excretion of phosphate
  - Hyperparathyroidism
  - Fanconi's syndrome
  - Hypophosphatemic rickets
4. Hereditary hypophosphatemia
5. Hypercalcemia
6. Chronic alcoholism
7. Drugs
  - Antacids, Diuretics, Salicylate intoxication.

#### Box 39.16: Important combinations of serum calcium and phosphate levels in blood

1. Increased P with decreased Ca
  - Hypoparathyroidism
  - Renal disease
2. Increased P with normal or increased Ca
  - Milk alkali syndrome
  - Hypervitaminosis D
3. Decreased P with increased Ca
  - Hyperparathyroidism
  - Sarcoidosis
4. Decreased P and Ca
  - Malabsorption
  - Vitamin D deficiency
  - Renal tubular acidosis

## Hypomagnesemia

It is commonly seen in hospital patients. Conditions which require magnesium estimation are enumerated in Box 39.17. When serum magnesium level falls below 1.7 mg/dl, it is called hypomagnesemia. Vomiting, nasogastric suction, diarrhea, liver cirrhosis, protein-calorie malnutrition and diuretic therapy are the common causes (see Box 35.18). Urinary loss can occur in alcoholism, osmotic diuretics, loop diuretics and amino-glycosides. Serum magnesium levels need not always reflect body content. Measurement of urinary magnesium excretion will distinguish between renal and gastrointestinal losses.

Deficiency of magnesium leads to neuromuscular hyper-irritability and cardiac arrhythmias. The magnesium deficiency symptoms are similar to those of calcium deficiency; but symptoms will be relieved only when magnesium is given. Acute symptomatic deficiency is treated by giving parenteral magnesium. Oral therapy may lead to diarrhea, hence intravenous magnesium sulfate is given.

## Hypermagnesemia

It is uncommon and always due to excessive intake either orally (antacids) rectally (enema) or parenterally. Causes of hypermagnesemia are listed in Box 39.19. Magnesium intoxication causes depression of neuromuscular system, causing lethargy, hypotension, respiratory depression, bradycardia and weak tendon reflexes. In severe conditions, acute rhabdomyolysis results. Hypermagnesemia induces decrease in

### Box 39.17: When to test for magnesium?

1. Cardiac arrhythmia
2. Resistant hypokalemia
3. Pregnancy with pre-eclampsia
4. Tetany not responding to calcium therapy.

### Box 39.18: Causes of hypomagnesemia

1. Increased urinary loss (Tubular necrosis)
2. Hyperaldosteronism, volume expansion
3. Familial hypomagnesemia
4. Increased intestinal loss
  - Diarrhea, laxatives, ulcerative colitis
  - Nasogastric suction, vomiting
5. Liver cirrhosis
6. Malabsorption
7. Protein calorie malnutrition
8. Hypoparathyroidism
9. Toxemia of pregnancy
10. Drugs:
  - Thiazide diuretics
  - Aminoglycosides
  - Cisplatin
  - Amphoterecin
  - Cyclosporine
  - Haloperidol
  - Alcohol.

serum calcium by inhibiting PTH secretion, which in turn will have deleterious effects.

## SULFUR

Source of sulfates is mainly amino acids cysteine and methionine. Proteins contain about 1% sulfur by weight. Inorganic sulfates of  $\text{Na}^+$ ,  $\text{K}^+$  and  $\text{Mg}^{++}$ , though available in food, are not utilized.

### Functions of Sulfur

1. Sulfur containing amino acids are important constituents of body proteins. The disulfide bridges keep polypeptide units together, e.g. insulin, immunoglobulins.
2. Chondroitin sulfates are seen in cartilage and bone.
3. Keratin is rich in sulfur, and is present in hair and nail.
4. Many enzymes and peptides contain -SH groups at the active site, e.g. glutathione. Thiamine, biotin, lipoic acid, CoA are also -SH containing molecules.
5. Co-enzymes derived from thiamine, biotin, pantothenic acid and lipoic acid also contain sulfur.
6. If sulfate is to be introduced in glycosaminoglycans or in phenols for detoxification, it can be done only by phosphoadenosine phosphosulfate (PAPS).
7. Sulfates are also important in detoxification mechanisms, e.g. production of indoxyl sulfate.

### Excretion

All the sulfur groups are ultimately oxidized in liver to sulfate ( $\text{SO}_4$ ) group and excreted in urine. The total quantity of sulfur in urine is about 1g/day. This contains 3 categories.

- i. **Inorganic sulfates:** It is about 80% of the total excretion. This is proportional to the protein intake. This category can be isolated by treating the urine with barium chloride, when white barium sulfate is precipitated.
- ii. **Organic sulfate or ethereal sulfate:** It is also called as conjugated sulfate. It constitutes 10% of urinary sulfates. Tryptophan is converted to phenol and indoxyl by intestinal bacteria. These are absorbed and conjugated with sulfates and excreted through urine.

### Box 39.19: Causes of hypermagnesemia

1. Excess intake orally or parenterally
2. Renal failure
3. Hyperparathyroidism
4. Oxalate poisoning
5. Rickets
6. Multiple myeloma
7. Dehydration
8. Drugs:
  - Aminoglycosides
  - Antacids
  - Calcitriol
  - Tacrolimus.

Therefore, this represents the putrefactive activity in intestine, and this fraction is increased in intestinal stasis. This part is also proportional to protein intake. This fraction will not give a direct precipitate with barium chloride. Urine is boiled with HCl and BaCl<sub>2</sub> is added to produce white precipitate of barium sulfate.

- iii. **Neutral sulfur or unoxidized sulfur:** This fraction constitutes 10% of total sulfates. Sulfur containing organic compounds, such as amino acids, thiocyanates and urochrome constitute this fraction. This will not vary with diet. In obstructive jaundice, taurocholic acid is excreted in urine, and hence this fraction is increased. It is also increased in amino acidurias.

## IRON (Fe)

### Distribution of Iron

Total body iron content is 3 to 5 g; 75% of which is in blood, the rest is in liver, bone marrow and muscles. Iron is present in almost all cells. Heme containing proteins are shown in Table 39.3.

Blood contains **14.5 g of Hb per 100 mL**. About 75% of total iron is in hemoglobin, and 5% is in myoglobin and 15% in ferritin. Normal iron kinetics is shown in Figure 39.8.

### Requirement of Iron (ICMR)

- i. Daily allowance of iron for an adult Indian is **20 mg** of iron, out of which about 1–2 mg is absorbed. In Western countries, requirement is less (15 mg/day) because the diet does not contain inhibitory substances.
- ii. Children between 13–15 years need 20–30 mg/day.
- iii. Pregnant women need 40 mg/day. Transfer of iron and calcium from mother to fetus occurs mainly in the last trimester of pregnancy. Therefore, during this period, mother's food should contain surplus quantities of iron and calcium.
- iv. In the first 3 months of life, iron intake is negligible because milk is a poor source of iron. During this time, child is dependent on the iron reserve received from mother during pregnancy. In premature babies, the transplacental transfer of iron might not have taken place. Hence such babies are at a risk of iron deficiency. After 3 months of life, diet supplementation with cereals is essential for supplying the iron requirement.

### Sources of Iron

- i. **Leafy vegetables** (20 mg/100 g) are good sources. Pulses (10 mg/100 g) and cereals (5 mg/100 g)

contain lesser quantity of iron. In a typical Indian diet, the major quantity of iron is received from cereals because of the bulk quantity taken, although they contain iron only in moderate amounts.

- ii. Liver (5 mg/100 g) and meat (2 mg/100 g)
- iii. **Jaggery** is a good source for iron.
- iv. Cooking in iron utensils will improve the iron content of the diet.
- v. Milk is a **very poor source** of iron, containing less than 0.1 mg/100 mL.

### Factors Influencing Absorption of Iron

Iron is absorbed by upper part of duodenum. The following factors affect absorption of iron:

**TABLE 39.3: Iron containing proteins**

Name	Molecular weight	No. of iron atom	Site
<b>Heme containing proteins</b>			
Hemoglobin	65,000	4	RBC
Myoglobin	17,000	1	Muscle
Cytochrome oxidase	180,000	2	Mito
Cytochrome b	30,000	1	do
Cytochrome c1	37,000	1	do
Cytochrome c	12,000	1	do
Cytochrome b5	15,000	1	ER
Cytochrome P450	55,000	1	ER, Mito
Catalase	240,000	4	RBC
Lactoperoxidase	93,000	1	Milk
Tryptophan pyrrolase		4	Cytosol
Nitric oxide synthase		1	Endothelium
<b>Iron-sulfur complexes</b>			
Complex III Fe-S	30,000	2	Mito
Succinate DH	27,000	4	Mito
Xanthine oxidase	275,000	8	Liver
<b>Non-heme iron containing proteins</b>			
Aconitase	66,000	2	TCA cycle
Phe-hydroxylase	110,000	2	Liver
Transferrin	77,000	2	Plasma
Ferritin	450,000	4,000	Tissues
Hemosiderin		Many	Liver

Mito = mitochondria; ER = endoplasmic reticulum; DH = dehydrogenase; Phe= phenyl alanine

### Reduced Form of Iron

Only  $\text{Fe}^{2+}$  (**ferrous**) form (reduced form) is absorbed.  $\text{Fe}^{3+}$  (ferric) form is not absorbed.

### Ascorbic Acid

Ferric ions are reduced with the help of gastric HCl, ascorbic acid, cysteine and -SH groups of proteins. Therefore, these will favor iron absorption. About 50–75 mg of ascorbic acid per day will be sufficient for normal iron absorption.

### Interfering Substances

Iron absorption is decreased by **phytic acid** (in cereals) and **oxalic acid** (in leafy vegetables) by forming insoluble iron salts. An average Indian diet contains more than 20 mg of iron. But the phytates and oxalates in the diet reduce the absorption, and only about 1 mg of iron is absorbed. In Western diet, even though iron content is about 10 mg, about 2 mg is absorbed.

### Other Minerals

Calcium, copper, lead and phosphates will inhibit iron absorption. One atom of lead will inhibit absorption of 1000 atoms of iron. A glass of milk, which contains calcium will appreciably reduce iron absorption.

### Mucosal Block Theory

- i. Duodenum and jejunum are the sites of absorption. Iron metabolism is unique because homeostasis is maintained by regulation at the **level of absorption**

and not by excretion (Fig. 39.9). No other nutrient is regulated in this manner. In other words, iron is a one-way element.

- ii. When iron stores in the body are depleted, absorption is enhanced. When adequate quantity of iron is stored, absorption is decreased. This is referred to as “**mucosal block**” of regulation of absorption of iron.
- iii. Only ferrous (and not ferric) form of iron is absorbed. Ferric iron is reduced to ferrous iron by **ferric reductase**, an enzyme present on the surface of enterocytes. **Ferrous iron** in the intestinal lumen binds to mucosal cell protein, called divalent metal transporter-1 (**DMT-1**). This bound iron is then transported into the mucosal cell. The rest of the unabsorbed iron is excreted (Fig. 39.9).
- iv. Inside the mucosal cell, iron is oxidized to ferric state, and is complexed with apoferritin to form **ferritin**. It is kept temporarily in the mucosal cell. If there is anemia, the iron is further absorbed into the bloodstream. If transferrin is saturated with iron, any iron accumulated in the mucosal cell is lost when the cell is desquamated. The fraction of iron absorbed and retained is decided by the iron status. When iron is in excess, absorption is reduced; this is the basis of “mucosal block” (Fig. 39.9).
- v. This mechanism of iron absorption from intestinal lumen to the mucosal cell is different from the iron release from intestinal cell to the bloodstream (Fig. 39.9). Iron in the ferritin is released, then crosses the mucosal cell with the help of a transport protein called, **ferroportin**. But this can happen only when

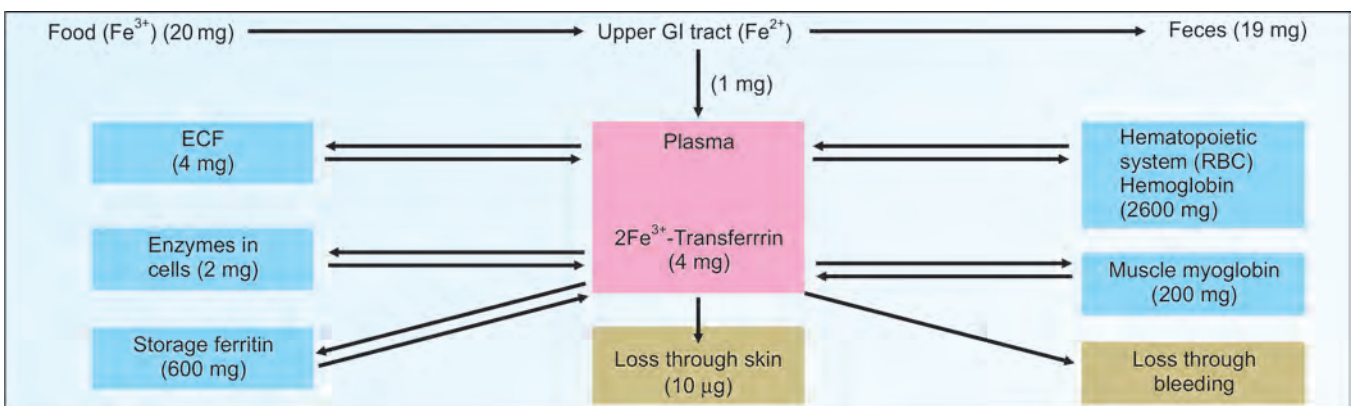


Fig. 39.8: Normal iron kinetics



there is free transferrin in plasma to bind the iron. Iron crosses cell membrane in ferrous form. In blood it is re-oxidized to ferric state, and transported by **transferrin**.

- vi. Intestinal uptake of heme iron occurs with the help of heme carrier protein (HCP1). The iron is released from heme in enterocytes by the action of microsomal heme oxygenase.

### Regulation of Absorption by Four Mechanisms

- i. **Mucosal regulation:** Regulation by mucosal block, as explained above. Absorption of iron needs divalent metal ion transporter and ferroportin. Synthesis of both these proteins is downregulated by **hepcidin**, a peptide secreted by the liver when body iron reserves are adequate. If there is hypoxia or anemia, the synthesis of hepcidin is reduced; so ferroportin synthesis will increase.

**Hepcidin** was identified only recently in 2001. It is produced by liver cells and is involved in killing bacteria; hence the name. It is coded in *HAMP* gene on chromosome 19. Its main action is on iron metabolism. Hepcidin decreases surface expression of

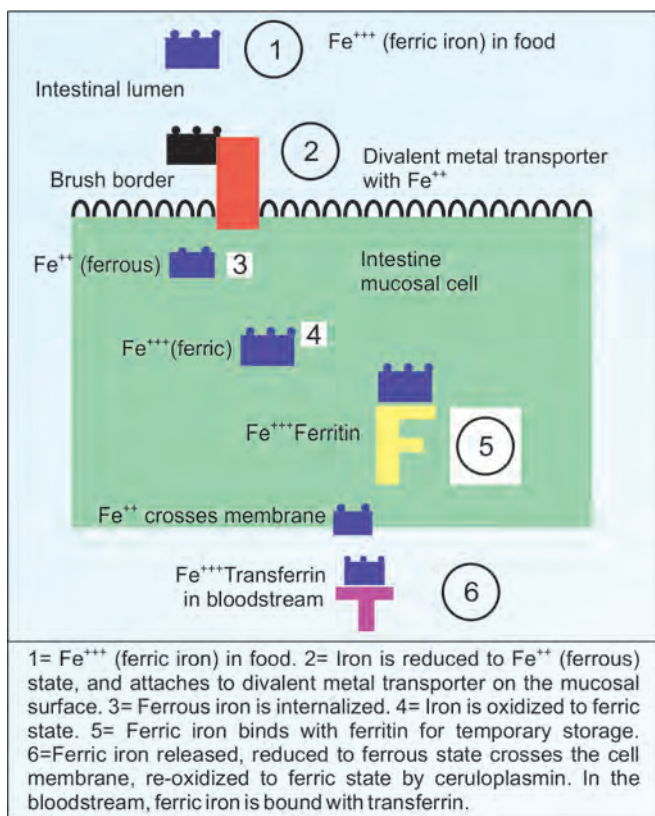


Fig. 39.9: Absorption of iron from intestine

the ferroportin, which is responsible for moving iron across cell membranes. Hepcidin production is increased by high iron stores and also by inflammation.

- ii. **Stores regulation:** As body iron stores fall, the mucosa is signalled to increase absorption.
- iii. **Erythropoietic regulation:** In response to anemia, the erythroid cells will signal the mucosa to increase iron absorption. This signal may be erythropoietin from kidney.
- iv. There is reciprocal relationship between **synthesis of ferritin and transferrin receptor (TfR)**. In case of high concentration of iron, the iron bound to the IRE-BP (Iron-Responsive Element Binding Protein) prevents it to bind Iron-Responsive Element (IRE) of both mRNA molecules. So, mRNA for ferritin is translated and ferritin is synthesized. But mRNA for TfR is degraded, resulting in reduced TfR protein synthesis. Thus, when iron levels are high, ferritin is synthesized to store iron. At the same time, there is no requirement for further uptake of iron, so the TfR is not synthesized. This is a good example of control of protein synthesis at the **translational level**. The reverse occurs when iron status is low- ferritin mRNA is not translated, but TfR mRNA is translated.

### Iron Transport in Blood and Uptake by Cells

- i. Transport form of iron is **transferrin**. It is a glycoprotein, beta-1 globulin, with molecular weight of 76,500 Daltons. It is synthesized in liver.
- ii. Normal plasma level of transferrin is 250 mg/100 mL. In iron deficiency, this level is increased. One molecule of transferrin can transport 2 ferric atoms. About 20 polymorphic forms of transferrin are seen in population.
- iii. **Total iron binding capacity (TIBC)** in plasma is 400 mg/100 mL; this is provided by the transferrin. One-third of this capacity is saturated with iron. This protein bound iron (serum iron) is about 120 mg/dL.
- iv. Abnormalities in these parameters are shown in Table 39.4. In iron deficiency anemia, TIBC is increased (transferrin level is increased); but serum iron level is reduced. Transferrin has a half life of 7–10 days, and is a useful index of nutritional status. One molecule of transferrin can bind two ferric ions.
- v. In blood, **ceruloplasmin** is the ferroxidase, which oxidizes ferrous to ferric state (Fig. 39.12).

Ferroxidase



- vi. **Transferrin receptors (TfR)** are present on most of the body cells, especially on cells, which synthesize heme.

The iron-transferrin complex is taken up by the body cells by the receptor mechanism. The transferrin receptor has a molecular weight of 200 kD. It binds two molecules of transferrin. The iron-transferrin-receptor is internalized. Iron is taken in by the cells, and receptor molecules are externalized. Active reticulocyte can internalize about 1 million atoms of iron per minute.

- vii. Transferrin is a glycoprotein. Abnormal glycosylation is seen in congenital disorders and in chronic alcohol abuse.
- viii. Ceruloplasmin oxidizes iron in macrophages and hepatocytes.

## Storage of Iron

- i. The storage form is **ferritin**. It is seen in intestinal mucosal cells, liver, spleen and bone marrow.
- ii. The **apoferritin** has a molecular weight of about 440 kilo Daltons. It has 24 subunits. It can take up to 4,000 iron atoms per molecule. Ferritin contains about 23% iron.
- iii. Normal plasma contains very little ferritin. Ferritin in plasma is elevated in iron overload. Thus ferritin level in blood is an index of body iron stores.
- iv. Ferritin is an acute phase reactant protein that is elevated in inflammatory diseases. Estimation of ferritin is also indicated in chronic kidney disease to assess the extent of anemia.
- v. Synthesis of TfR and ferritin and that of ferritin are reciprocally controlled.
- vi. In iron deficiency anemia, ferritin content is reduced. When iron is given in anemia, the apoferritin production is induced within a few hours.
- vii. Estimation of ferritin in chronic kidney disease (CKD) is of prognostic significance since ferritin level less than 100  $\mu\text{g}/\text{dL}$  indicates iron deficiency. Transferrin saturation less than 20% and ferritin between 100 and 200  $\mu\text{g}/\text{dL}$  is suggestive of functional deficiency. In order to treat the anemia in CKD, the iron stores should be adequate and this is denoted by serial ferritin estimations in a patient on treatment to check the efficacy of treatment with recombinant erythropoietin (epoetin).
- viii. Aging cells will release iron with the help of a copper containing protein called **hephaestin**, which has ferroxidase activity (similar to ceruloplasmin).
- ix. **Hemosiderin** is also a storage form of iron, but it is formed by partial deproteinization of ferritin by lysosomes and are found as aggregates in tissues like liver, spleen and bone marrow. It is more insoluble than ferritin, and iron is more slowly released.

## Summary of Iron Absorption

Free iron in the intestines is reduced from the ferric ( $\text{Fe}^{3+}$ ) to the ferrous ( $\text{Fe}^{2+}$ ) state on the luminal surface of intestinal enterocytes and transported into the cells through the action of the **divalent metal transporter** (DMT1). Intestinal uptake of heme iron occurs through the help of **heme carrier protein** (HCP1). The iron is then released within the enterocytes by the enzyme **heme oxygenase**. The iron can be temporarily stored within intestinal enterocytes bound to **ferritin**. Iron is transported across the basolateral membrane of intestinal enterocytes into the circulation, through the action of the transport protein **ferroportin** (also called IREG1=iron-regulated gene 1). The synthesis of both DMT and ferroportin are regulated by **hepcidin**. The enzyme **hephaestin** (a copper-containing ferroxidase with homology to ceruloplasmin), which oxidizes the ferrous form back to the ferric form. Once in the circulation, ferric form is maintained by **ceruloplasmin**; and is bound to **transferrin** and passes to liver. **Ferritin** is the storage form of iron.

## Iron is Conserved

- i. When RBC is lysed, hemoglobin enters into circulation. Being a small molecular weight substance, Hb will be lost through urine. To prevent this loss, Hb is immediately taken up by **haptoglobin** (Hp) (Fig. 39.10).
- ii. It is an alpha-2 globulin. It has 2 light and 2 heavy chains. Normal level of Hp is 40–175 mg/dL. Normal half life of Hp is 5 days; but Hb-Hp complex has only 90 minutes. So, when there is hemolysis, there is rapid turnover of Hp and hence Hp level in blood is decreased. Hp is an acute phase protein, and the level is increased in inflammations.
- iii. Haptoglobin exists in 3 polymorphic forms; Hp1-1, Hp2-1 and Hp2-2. Two genes will separately synthesize the two different polypeptides and they will combine to form these 3 forms. Hp1-1 has a molecular weight of 90 kD.
- iv. **Haptoglobin-related protein** (HRP) bears a high degree of amino acid homology to haptoglobin. HRP also binds hemoglobin.
- v. When the globin part is removed from Hb, the heme is produced, and is released into circulation. In order to prevent its excretion through urine, heme is bound with **hemopexin** (Fig. 39.10).
- vi. Hemopexin is a beta-globulin with a molecular weight of 57,000 Daltons. Normal blood level is 50–100 mg/dL, which is increased during hemolysis.

- vii. Iron is a very rare element in the universe. The temperature and pressure inside the sun are not enough to create iron atoms, which require supernova explosions. Iron generated by such rare cosmological events should then be condensed to planetary systems. Even in earth, 99% of iron is trapped inside the deep core. The surface of earth contains comparatively little iron. Moreover, the solubility of iron in the universal solvent, water, is negligible. For all these reasons, iron is very precious for biological systems. Hence, these elaborate mechanisms are necessary for conservation inside the body (Fig. 39.10).

## Excretion of Iron

- Iron is a one-way element. That is, very little of it is excreted. *The regulation of homeostasis is done at the absorption level.*
- Any type of bleeding will cause loss of iron from the body. Menstrual flow is the major cause for loss of iron in women. Women up to menopause will lose iron at a rate of about 1 mg/day. The loss in male is less than 0.5 mg/day.
- Almost no iron is excreted through urine. Feces contain unabsorbed iron as well as iron trapped in the intestinal cells, which are then desquamated. About 30% of cells in the intestinal lining is replenished everyday, and so this loss is considerable.
- All the cells in skin contain iron. The upper layers of skin cells are constantly being lost, and this is another route for iron loss from the body.

## Iron Deficiency Anemia

This most common nutritional deficiency disorder leaves about 30% of world population anemic. About 70% of Indians have iron deficiency and 85% of pregnant women suffer from iron deficiency anemia. Maternal

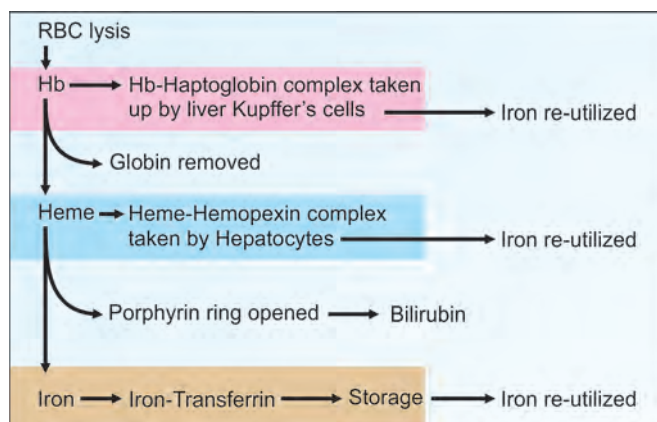


Fig. 39.10: Conservation of iron in the body

anemia contributes to increase in perinatal mortality. Anemia often leads to irreversible impairment of child's learning ability. In adults, anemia results in impaired work capacity. Causes of iron deficiency are given in Box 35.20. Anemia is classified in Box 39.21.

## Causes for Iron Deficiency

- Nutritional deficiency of iron:** The usual Indian diet contains inhibitors of absorption. Hence Indians are more prone to develop iron deficiency anemia.

### Box 39.20: Causes of iron deficiency

- Nutritional deficiency of iron**
- Lack of absorption:** Subtotal gastrectomy and hypochlorhydria
- Hookworm infection:** One hookworm will cause the loss of about 0.3 mL of blood per day. Calculation shows that about 300 worms can produce a loss of 1% of total body iron per day
- Repeated pregnancies:** About 1g of iron is lost from the mother during one delivery
- Chronic blood loss:** Hemorrhoids (piles), peptic ulcer, menorrhagia
- Nephrosis:** Haptoglobin, hemopexin and transferrin are lost in urine, along with loss of iron
- Lead poisoning:** Iron absorption and hemoglobin synthesis are reduced. In turn, iron deficiency causes more lead absorption. It is a vicious cycle.

### Box 39.21: Classification of anemias

- Impaired Production of RBCs**
  - Defect in heme synthesis:** Deficiency of iron, copper, pyridoxal phosphate, folic acid, vitamin B<sub>12</sub> or vitamin C. Lead will inhibit heme synthesis
  - Defect in regulators:** Lack of erythropoietin, due to chronic renal failure
  - Defect in stem cells:** Aplastic anemia due to drugs (e.g. Chloramphenicol), infections and malignant infiltrations may lead to anemia
- Intracorpouscular Defects**
  - Hemoglobinopathies:** HbS, HbC, HbM
  - Thalassemias:** Major and minor
  - Abnormal shape:** Spherocytosis
  - Deficiency of glucose-6-phosphate dehydrogenase (see Chapter 4)
- Extracorpouscular Causes**
  - Infections:** Malaria, *Streptococcus*
  - Autoimmune hemolysis**
  - Isoimmune hemolysis:** Rh incompatibility
  - Hemolysis due to drug sensitization:** Alpha-methyl dopa, quinine, etc.
- Hemorrhage**

Hematuria, hematemesis, hemoptysis, peptic ulcer, menorrhagia, hemorrhoids, hemophilia (absence of AHG), thrombocytopenia.

- ii. **Hookworm infection:** This may be the most important cause, especially in rural areas, where sanitation is poor. It is calculated that 1 hookworm will cause the loss of about 0.3 mL of blood per day. Calculation shows that about 300 worms can produce a loss of 1% of total body iron per day.
- iii. **Repeated pregnancies:** About 1g of iron is lost from the mother during one delivery.
- iv. **Chronic blood loss:** Hemorrhoids (piles), peptic ulcer, uterine hemorrhage.
- v. **Nephrosis:** When kidney glomerular mechanism is damaged, proteinuria results. Then haptoglobin, hemopexin and transferrin are lost in urine, with consequent loss of iron (Fig. 39.10).
- vi. **Lack of absorption:** Subtotal gastrectomy and achlorhydria.
- vii. **Lead poisoning:** Lead and iron oppose each other (see Chapter 42). In lead toxicity, iron absorption and Hb synthesis are reduced. In turn, iron deficiency causes more lead absorption. It is a vicious cycle.

### Microscopic Appearance

Iron deficiency is characterized by **microcytic hypochromic** anemia (Fig. 39.11A). Anemia results when hemoglobin level is less than 12 g/dL.

### Clinical Manifestations

- i. When the level is lower than 10 g, body cells lack oxygen and patient becomes uninterested in surroundings (**apathy**). Since iron is an important constituent of cytochromes, their deficiency leads to derangement in cellular respiration and all metabolic processes become sluggish.
- ii. Prolonged iron deficiency causes atrophy of gastric epithelium leading to **achlorhydria**, which in turn causes lesser absorption of iron, aggravating the



**Figs 39.11A and B:** (A) Peripheral blood smear. Iron deficiency manifests as microcytic hypochromic anemia; (B) Tired girl. Apathy and poor scholastic performance are very characteristic of iron deficiency anemia

anemia. Similar atrophy of epithelium in oral cavity and esophagus causes dysphagia termed **Plummer-Wilson syndrome**, which is a known precancerous condition.

- iii. Very chronic iron deficiency anemia will lead to impaired attention, irritability, lowered memory and poor scholastic performance. Anemia and apathy go hand in hand (Fig. 39.11B).

### Laboratory Findings

Laboratory investigations generally used to diagnose anemias are listed in Table 39.4.

- i. **Serum iron level:** It is depressed in iron deficiency, acute and chronic infections, carcinomas, hypothyroidism and Kwashiorkor.
- ii. **Total iron binding capacity (TIBC):** It is elevated in hypochromic anemias, acute hepatitis and pregnancy.
- iii. **Soluble transferrin receptor level (sTfR):** It has distinct advantages over the other parameters because inflammatory states will not alter sTfR levels. The level of sTfR is increased in iron-deficiency anemia, hemolytic anemia and polycythemia. Decreased values are seen in aplastic anemia and chronic renal failure.

### Treatment of Iron Deficiency

Oral iron supplementation is the treatment of choice. 100 mg of **iron** + 500 µg of **folic acid** are given to pregnant women, and 20 mg of iron + 100 µg folic acid to children. Iron tablets are usually given along with **vitamin C**, to convert it into ferrous form, for easy absorption. Unabsorbed iron may generate **free radicals** and so, it is advisable to give

**TABLE 39.4:** Parameters of iron status

	Normal	Pregnancy	Infection	Hemolytic anemia	Hemolysis
Transferrin (mg/dL)	250	300	150	200	1000
Serum iron (µg/dL)	120	50	50	200	250
TIBC (µg/dL)	400	500	200	300	300
RBC, lifespan, days	120	120	100	75	75
Ferritin (ng/mL)	20–250	Reduce	Increase	< 10	> 400



**vitamin E** (to prevent free radical generation) along with iron.

## Iron Toxicity

- i. More than 50 mg of iron taken orally may cause nausea, diarrhea and abdominal pain.
- ii. **Hemosiderosis:** Iron excess is called hemosiderosis. Hemosiderin pigments are golden brown granules, seen in spleen and liver. Prussian blue reaction is positive for these pigments. Hemosiderosis occurs in persons receiving repeated blood **transfusions**. Here the regulation at the level of intestine is circumvented leading to iron overload. Hemophilic children require blood transfusion every 3 months. If whole blood is given every time, by about 20 years of age, the patient will have hemosiderosis. This is the commonest cause for hemosiderosis in India. Nowadays, component separated plasma is available for transfusion, which eliminates the risk of hemosiderosis.
- iii. **Primary hemosiderosis:** It is also called hereditary hemochromatosis. It is an autosomal recessive condition. The abnormal gene (HFE1) is located on chromosome no. 6. The gene encodes an  $\alpha$  chain protein, which associates with  $\beta_2$ -microglobulin. Normal HFE1 forms a complex with the transferrin receptor and so regulates the rate of iron transfer into cells. Due to the mutation in HFE1 iron absorption is increased and transferrin level in serum is elevated. The low hepcidin level relative to ferritin in these patients leads to increased intestinal iron absorption and body iron overload (Box 39.22).
- iv. **Iron vessels:** Cooking in iron vessels increases the availability of iron.
- v. **Bantu siderosis:** Bantu tribe in Africa is prone to hemosiderosis because the staple diet, corn, is low in phosphate content.

### Box 39.22: Excess iron helps bacteria!

Bacteria are dependent on iron for growth which produces low molecular weight iron binding compounds. Ordinarily transferrin binds iron tightly and very little is available as free iron for bacteria to bind. But when there is excess iron or when the binding by transferrin is affected by a drop in pH, more free iron is available to the bacteria making them pathogenic. Pathogenicity induced by excess iron in certain bacteria found in oysters is said to be responsible for their lethal effect when consumed by individuals.

- vi. **Hemochromatosis:** When total body iron is higher than 25–30 g, hemosiderosis is manifested. In the liver, hemosiderin deposit leads to death of cells and cirrhosis. Pancreatic cell death leads to diabetes. Deposits under the skin cause yellow-brown discoloration, which is called **hemochromatosis**. The triad of cirrhosis, hemochromatosis and diabetes are referred to as **bronze diabetes**.
- vii. **Treatment of hemosiderosis:** Repeated phlebotomy every week, till serum iron, and ferritin reach near normal levels. This may require several years. Desferoxamine (Desferrioxamine), a chelating agent, forms an iron chelate with  $\text{Fe}^{+++}$  to form ferroxamine which is excreted in urine.

## COPPER (Cu)

Total body copper is about 100 mg. It is seen in muscles, liver, bone marrow, brain, kidney, heart and in hair.

Copper containing enzymes are ceruloplasmin, cytochrome oxidase, cytochrome c, tyrosinase, lysyl oxidase, ALA synthase, monoamine oxidase, superoxide dismutase and phenol oxidase.

Copper containing non-enzymatic proteins are hepatocuprein in liver (storage form), cuprothionine in liver, cerebrocuprein in brain, hemocuprein in RBC and erythrocuprein in bone marrow. Hemocyanin is the oxygen carrying blue pigment seen in crustacea.

Copper **requirement** for an adult is 1.5 – 3 mg per day. Major dietary sources are cereals, meat, liver, nuts and green leafy vegetables. Milk is very poor in copper content.

Only about 10% of dietary copper is absorbed. Excretion is mainly through bile. Urine does not contain copper in normal circumstances.

Whole blood contains about 100  $\mu\text{g}/\text{dL}$  of copper. Out of this, 95% is in RBC as colorless erythrocuprein. In plasma **ceruloplasmin** is an important copper containing protein (see Chapter 28). Normal serum level of ceruloplasmin is 25–50  $\text{mg}/\text{dL}$ . Ceruloplasmin is a blue-colored glycoprotein (Latin “caeruleus” = blue). It is also called **serum ferroxidase**. It promotes oxidation of ferrous ion to ferric form, which is incorporated into transferrin (Fig. 39.12). The copper atoms are tightly bound with ceruloplasmin. So copper from ceruloplasmin cannot be released easily. About 10% of copper in plasma is loosely bound with **albumin**, which constitutes the transport form of copper.

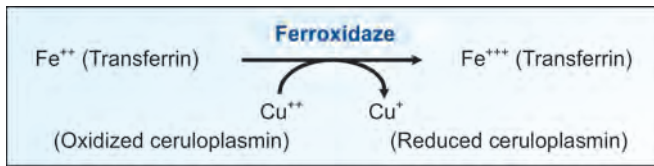


Fig. 39.12: Function of ceruloplasmin

## Functions of Copper

1. It is necessary for iron absorption and incorporation of iron into hemoglobin.
2. It is necessary for tyrosinase activity.
3. It is a co-factor for vitamin C requiring hydroxylations.
4. It increases HDL and so protects the heart.

## Abnormal Metabolism of Copper

- Wilson's disease:** Ceruloplasmin level in blood is drastically reduced in Wilson's hepatolenticular degeneration. The incidence of Wilson's disease is 1 in 50,000. The basic defect is in a gene encoding a **copper binding ATPase** in cells (ATP7B gene in liver cells). This is required for normal excretion of copper from liver cells; in its absence, copper is accumulated in cells, leading to copper deposits in liver and brain (see Chapter 28). Administration of penicillamine, which helps in chelation and excretion of copper, may help the affected persons. As zinc decreases copper absorption, zinc is sometimes used therapeutically in Wilson's disease, to reduce copper load in the body.
- Aceruloplasminemia:** Levels of ceruloplasmin (ferroxidase activity) are congenitally low. So, iron is not utilized properly. Iron accumulates in brain, liver and pancreatic islet cells. Neurological symptoms are seen.
- Copper deficiency anemia:** Since copper binding protein ceruloplasmin is essential for iron transport in ferric form across membranes, copper deficiency affects hemoglobin formation. Copper containing ceruloplasmin helps in iron transport. Copper is an integral part of ALA synthase, which is the key enzyme in heme synthesis. Copper helps the uptake of iron by normoblasts. Copper deficiency is manifested as anemia. RBC count is reduced; cell size is small; but hemoglobin concentration is more or less normal. Copper deficiency thus results in **microcytic normochromic anemia**. If there is added iron deficiency, hypochromic anemia results.

- Cardiovascular diseases:** Copper is a constituent of **lysyl oxidase**. It oxidizes four lysine residues together to form **desmosine** which makes cross linkages in elastin. In copper deficiency, elastin becomes abnormal, leading to **weakening of walls** of major blood vessels. This favors aneurysm and fatal rupture of the wall of aorta. Another finding is the fibrosis of myocardium leading to cardiac failure.
- Menke's kinky hair syndrome:** It is an x-linked defect (affects only male child). It is a condition in which dietary copper is absorbed from GI tract; but cannot be transported to blood due to absence of an intracellular **copper binding ATPase** (mutation in ATP7A gene). Please note that the proteins present in liver and in extrahepatic tissues are different. This explains the difference in clinical manifestations of Wilson's disease and Menke's disease. Copper is not mobilized from intestinal cells as well as in other tissue cells. The copper that has entered into the cell is not able to get out of the cells, and so it is accumulated. Hence, copper is not available for metabolism, resulting in defective cross-linking of connective tissue. Vascular and connective tissues are affected, and child dies usually in infancy.
- Melanin:** Copper is present in tyrosinase, which is necessary for melanin formation (see Chapter 18). Copper deficiency thus leads to hypopigmentation and in extreme cases, gray color of hair. The period of copper deficiency may be marked on hair as alternate white patches; sometimes called flag type of hair growth.
- Low levels can cause brain dysfunction especially of the cerebellum, leading to ataxia.

## Copper Toxicity

Excess copper intake may lead to toxic manifestations. Copper can oxidize proteins and lipids; it can enhance production of free radicals. Chronic toxicity is manifested as diarrhea and blue-green discoloration of saliva. Copper poisoning may result in hemolysis, hemoglobinuria, proteinuria and renal failure. Excess intake of copper will induce the synthesis of **metallothionein (MT)**, found in liver, kidney and intestine. MT has a high content of cysteine and binds copper, zinc, cadmium and mercury. MT binds these metals, so as to make them non-toxic.

## ■ IODINE

Three major micronutrient deficiencies seen in India are those of iodine, iron and vitamin A. In India, 235 districts are endemic for iodine

deficiency. Iodine level in blood is 5–10 µg/dL. Daily requirement is 150–200 µg and it is now provided by fortification of table salt with iodine. Iodine metabolism is described in Chapter 53, under thyroid hormones.

## ■ ZINC (Zn)

Total zinc content of body is about 2 g, out of which 60% is in skeletal muscles and 30% in bones. Highest concentration of zinc is seen in hippocampus area of brain and prostatic secretion.

Rich dietary sources are grains, beans, nuts, cheese, meat and shellfish. Copper, calcium, cadmium, iron and phytate will interfere with the absorption of zinc. Zinc and copper will competitively inhibit each other's absorption. So, zinc is therapeutically useful to reduce copper absorption in Wilson's disease.

In liver, zinc is stored in combination with a specific protein, **metallothionein**. Zinc is excreted through pancreatic juice and to a lesser extent through sweat.

More than **300 enzymes** are zinc dependent. Some important ones are carboxypeptidase, carbonic anhydrase, alkaline phosphatase, lactate dehydrogenase, ethanol dehydrogenase and glutamate dehydrogenase. RNA polymerase contains zinc and so it is required for **protein** biosynthesis. Extracellular superoxide dismutase is zinc dependent and so, zinc is an **anti-oxidant**.

**Insulin** when stored in the beta cells of pancreas contains zinc, which stabilizes the hormone molecule. But the insulin released into the blood does not contain zinc. The commercially available preparation, protamin-zinc-insulinate (PZI) also contains zinc. Zinc containing protein, **Gusten**, in saliva is important for taste sensation.

## Zinc Deficiency Manifestations

Poor wound healing, lesions of skin, impaired spermatogenesis, hyperkeratosis, dermatitis and alopecia are deficiency manifestations of zinc. There is reduction in number of T and B lymphocytes. Macrophage function is retarded. Zinc deficiency leads to depression, dementia and other psychiatric disorders. Zinc binds with amyloid to form a plaque in **Alzheimer's** disease.

## Acrodermatitis Enteropathica

It is a recessive condition where zinc absorption is defective and is characterized by acrodermatitis (inflammation around mouth, nose, fingers, etc.), diarrhea, alopecia (loss of hair in discrete areas), ophthalmoplegia and hypogonadism.

## Requirement of Zinc

For adults is 10 mg/day; children 10 mg/day; in pregnancy and lactation 15–20 mg/day. Since iron inhibits absorption of zinc, when iron is supplemented, zinc is also given to prevent any deficiency.

## Zinc Toxicity

Toxic manifestations are seen when intake is more than 1000 mg/day. Toxicity of zinc is usually seen in welders due to inhalation of zinc

oxide fumes. Many rat poisons contain zinc compounds, which lead to accidental poisoning.

Chronic toxicity may produce gastric ulcer, pancreatitis, anemia, nausea, vomiting and pulmonary fibrosis. Acute toxicity is manifested as fever, excessive salivation, headache and anemia.

## ■ FLUORIDE

Fluoride is known to prevent caries. Caries is a Latin term, meaning "decay". In the pits and fissures of premolar and molar teeth, bacterial fermentation of residual food leads to acid production. The acid removes enamel and dentine to expose the pulp, leading to inflammation and toothache. Topical application of fluoride will result in a fluoroapatite layer on the enamel, which protects enamel from the decay by acid.

The safe limit of fluorine is about 1 ppm in water. (ppm = parts per million; 1 ppm = 1 gram of fluoride in million grams of water; this is equal to 1 mg per 1000 mL).

Fluoride ions enter the hydration shell surrounding the apatite crystals and may become incorporated into the crystal surface. The fluoroapatite makes the tooth surface more resistant to plaque bacterial attack.

## Fluorosis is More Dangerous Than Caries

Fluoride level more than 2 ppm will cause chronic intestinal upset, gastroenteritis, loss of appetite and loss of weight. Level more than 5 ppm causes mottling of enamel, stratification and discoloration of teeth.

A level more than 20 ppm is toxic, leading to alternate areas of osteoporosis and osteosclerosis, with brittle bones. This is called fluorosis. Genu valgum is the characteristic feature. Ingested fluoride accumulates in bones. It is a cumulative toxin. In fluorosis, blood concentration of fluoride increases to 50 µg/100 mL; whereas normal value is 4 µg/100 mL. Due to increased breakdown of bone matrix, excretion of hydroxyproline in urine is enhanced.

Nellore, Nalgonda and Prakasam districts of Andhra Pradesh and Patiala district of Punjab are badly affected. 25 million people in India are suffering from fluorosis, spread in 15 states of India. In the vicinity of irrigation dams, the water level in wells will come up, along with salts including fluoride. This has resulted in widespread fluorosis in Punjab, Rajasthan, UP, Delhi, Andhra Pradesh, Karnataka and Tamilnadu. Certain salts used in *paan supari* also have large content of fluoride. Fluoride rich sources are sea fish, cheese, tea and jowar. Fluorosis is highly prevalent in areas where jowar is the staple diet. Fluorinated toothpaste contains 3,000 ppm of fluoride. Even ordinary toothpaste contains fluoride about 700 ppm.

Prevention of fluorosis is to provide fluoride free water, restriction of intake of jowar, supplementation of vitamin C and regulation of fluoride containing toothpaste.

## ■ SELENIUM (Se)

Selenium intake depends on the nature of the soil in which food crops are grown.

**Requirement** is 50–100 µg/day. Normal serum level is 50–100 µg/dL.

In mammals, **glutathione peroxidase (GP)** is the important selenium containing enzyme. RBC contains good quantity of glutathione peroxidase.

Thyroxin is converted to T3 by 5'-**de-iodinase**, which is a selenium containing enzyme. In Se deficiency, this enzyme becomes inactive, leading to hypothyroidism.

Selenium concentration in testis is the highest in adult tissue. It is necessary for normal development of spermatozoa. It is concentrated in the mid-piece of spermatozoa as a specific seleno-protein in mitochondria.

The UGA codon (see Chapter 46) is acting as the codon for direct insertion of seleno-cysteine. Seleno-cysteine is directly incorporated into the protein during biosynthesis. So, seleno-cysteine may be considered as the 21st amino acid (see Box 3.2).

Selenium acts as a nonspecific intracellular **antioxidant**. This action of Se is complementary to vitamin E. Availability of vitamin E reduces the selenium requirement. In Se deficiency, tissue vitamin E content is depleted.

In Keshan province in China, the soil is deficient in selenium. This leads to prevalence of **Keshan disease**. It is characterized by multifocal myocardial necrosis, cardiac arrhythmias and cardiac enlargement. Selenium is known to cure the disease. Isolated selenium deficiency in other parts of the world caused liver necrosis, cirrhosis, **cardiomyopathy** and muscular dystrophy.

Selenium toxicity is called **Selenosis**. Selenium is present in metal polishes and anti-rust compounds. The toxicity symptoms include hair loss, falling of nails, diarrhea, weight loss, and garlicky odor in breath. The last mentioned symptom is due to the presence of dimethyl selenide in expired air. **Kaschinbeck** disease is characterized by degenerative osteoarthritis.

## MANGANESE (Mn)

Total body manganese is 15 mg. Maximum concentration is in liver (1.5 ppm). In the cells, it is mainly seen inside the nuclei, as complexed with nucleic acids.

**Requirement** of manganese is 5 mg/day.

**Sources:** Nuts are good sources and tea leaves are exceptionally rich in manganese. Only about 3% of ingested manganese is absorbed.

**Metabolism:** The absorption is inhibited by iron. In blood, manganese is bound to the specific carrier protein, **transmanganin**, a beta globulin. Manganese is excreted through bile.

**Functions:** The following enzymes either contain or are activated by manganese: Hexokinase, phosphoglucomutase, pyruvate carboxylase, isocitrate dehydrogenase, succinate dehydrogenase, arginase, glutamine synthetase and Mn-dependent superoxide dismutase. Manganese is an integral part of glycosyl transferases, responsible for synthesis of glycoproteins and chondroitin sulfate. Mn is also required for RNA polymerase activity.

**Deficiency** leads to impaired growth and skeletal deformities. Chondroitin sulfate generation is impaired so that organic matrix of bone and cartilage becomes abnormal.

## MOLYBDENUM (Mo)

Mean dietary intake of molybdenum is 100 µg/day. Most of the absorbed molybdenum is excreted through urine. Higher protein and cysteine intake will cause higher excretion of molybdenum. It is present in cereals. Liver contains maximum content of Mo in the body.

**Functions:** Xanthine oxidase and aldehyde oxidase contain molybdoprotein, a substituted pterin to which molybdenum is bound by two sulfur atoms. Mo deficiency causes depression of xanthine oxidase activity, increased excretion of xanthine and decreased uric acid excretion.

Excess intake leads to molybdenosis. It is characterized by growth retardation, anemia and diarrhea. Copper and cysteine are effective in removing Mo from the body and in reducing toxicity. Higher levels of Mo in food will impair the absorption of copper.

Deficiency of Mo is associated with increased incidence of esophageal cancer.

## COBALT (Co)

Vitamin B<sub>12</sub> is the only important nutrient for human beings that contain cobalt (see Chapter 38). Cobalt content of vitamin B<sub>12</sub> is about 4% by weight. Cobalt stimulates the production of erythropoietin and continued use in animals has resulted in polycythemia.

## NICKEL (Ni)

Normal plasma level of nickel is 0.5 µg/dL. Nickel content of hair in female is 4 ppm, while in male it is 1 ppm. Nickel containing enzymes are urease and methylcoenzyme reductase. Nickel inhibits acid phosphatase. Nickel is necessary in the production of pigments in fish, birds and insects. Some chocolate preparations may contain nickel levels more than permitted. Nickel in higher concentrations may be carcinogenic. Deficiency may lead to decreased utilization of iron. Requirement is 500 µg/day.

## CHROMIUM (Cr)

Trivalent and hexavalent atoms of chromium are biologically active. Total body content of chromium is 6 mg, and this decreases with age. Cooking in stainless steel containers increases the Cr content of food. Daily requirement is 30 microgram. Blood level of chromium is 25 ng/dL. Affinity of chromium for transferrin is the same as that of iron, and the two ions compete for binding to the protein.

The chromium containing protein chromodulin facilitates binding of insulin to its receptor and receptor kinase signaling. In chromium deficiency, glucose tolerance is impaired. The efficiency of binding of insulin to its receptors on the peripheral cells is improved by chromium. Deficiency also leads to impaired growth, decrease in fertility and sperm count.

Radioactive (<sup>57</sup>Cr) is widely used to tag RBC. These tagged RBCs when injected back to the patient will be seen in circulation and the rate of hemolysis could be calculated. <sup>57</sup>Cr-labeled target cells are used to demonstrate the cytolytic effect of T lymphocytes and NK cells.



Chromium toxicity is an occupational hazard in workers of tanning industry. Liver and kidney damage are seen. Upper safe limit of chromium is 200 microgram per day. Chromium in higher concentrations may be carcinogenic. Tobacco is rich in chromium, and this is implied partly in the carcinogenic effect of tobacco.

## LITHIUM (Li)

It has the atomic number 3. It is the lightest alkali metal. Lithium is an essential growth factor in tissue culture. Normal human skeletal muscles contain 2–200 ng/g of weight. Higher concentrations are seen in brain. Mean intake is 50 µg/day.

Lithium is used in treating manic depressive psychosis (bipolar disorders), the dose being 25–500 mg/day. Lithium will counteract both mania and depression. Therapeutically optimum concentration of Li in plasma is 7–10 µg/mL, while 12 micrograms is toxic. Since margin of safety is narrow, the treatment requires constant monitoring of blood level. Li causes inhibition of inositol phosphatase, leading to increased concentration of inositol phosphate in brain. Li elevates serotonin levels and reduces catecholamines in brain tissue. Lithium toxicity leads to hypothyroidism, hyperparathyroidism and kidney damage.

### Related Topics

Sodium, Potassium and Chloride are very important electrolytes, having much clinical applications. These are described in Chapter 30. A summary of the mineral metabolism is shown in Table 39.5. Lead, Cadmium, Phosphorus and Mercury are toxic minerals; these are described in Chapter 42. Iodine metabolism is described in Chapter 53.

### Clinical Case Study 39.1

A 54-year-old grossly overweight woman presented with complaints of cramps and spasms of both hands. She was

**TABLE 39.5:** Summary of mineral metabolism

	Requirement for adult male/day	Blood level
Calcium	500 mg	9 – 11 mg/dL
Phosphorus	500 mg	3 – 4 mg /dL
Magnesium	400 mg	1.8 – 2.2 mg/dL
Sodium	5 – 10 g	136 – 145 mEq/L
Potassium	3 – 4 g	3.5 – 5 mEq/L
Chloride		96 – 106 mEq/L
Iron (plasma)	20 mg	120 µg/dL
Copper	1.5 – 3 mg	100 µg/dL
Iodine	200 µg	10 µg/dL
Zinc	10 mg	100 µg/dL
Chromium	50 µg	25 µg/dL
Selenium	100 µg	100 µg/dL

depressed and had positive Trousseau's and Chvostek's signs. Past medical history revealed history of thyroidectomy for Grave's disease. The laboratory results obtained were as follows:

Serum Creatinine – 1.0 mg%, Serum Calcium – 4.1 mg%, Serum phosphate – 5.9 mg%, ALP – 60 IU/L, Serum Albumin – 4.0 g%.

Comment on the laboratory results and give your likely diagnosis. What additional tests are to be done to come to a conclusive diagnosis?

### Clinical Case Study 39.2

A 10-year-old girl presented with excessive tiredness, poor appetite, inability to concentrate and tingling sensations. On examination, there was pallor. Laboratory examination revealed decrease in hemoglobin, ferritin and MCV. Total iron binding capacity (TIBC), transferrin and RDW were increased. What is the likely diagnosis?

### Clinical Case Study 39.3

A 42-year-old female presented to the clinic with complaints of vague abdominal discomfort, weakness and fatigue, and bone pain. She had frequent urinary tract infections and had several episodes of kidney stones. Her physical examination was within normal limits. The patient had a normal complete blood count (CBC), but electrolytes revealed a significantly elevated calcium level and low phosphorus level. What is the most likely diagnosis?

### Clinical Case Study 39.4

A 9-year-old girl presented with muscle pain and cramps, tingling of hands and feet, stiffness, recurrent carpopedal spasms, and titanic posturing of both hands and feet. She was a strict vegetarian consuming no milk or milk products. Other siblings are normal.

On examination, no symptoms of rickets or short stature, BP was normal and general examination was normal. Trousseau's sign was positive. Calcium level was 6.5 mg/dL. What is the diagnosis? What are the causes for the disease? What other investigations are needed to come to a confirmatory diagnosis?

### Clinical Case Study 39.5

A 36-year-old female was on treatment with <sup>131</sup>I (radioactive iodine) for hyperthyroidism. Two months

later, she developed severe carpopedal spasm and plasma calcium was 6.0 mg/dL. Laboratory results also revealed normal fT3, fT4 and TSH and low PTH. What is the possible diagnosis? What is the cause of hypocalcemia in this patient?

### Clinical Case Study 39.1 Answer

Hypocalcemia due to accidental removal of parathyroid glands. Please see details under Clinical Case Study 39.4 also.

### Clinical Case Study 39.2 Answer

The symptoms are suggestive of iron deficiency anemia, the commonest deficiency disease prevalent world-wide. Iron requirements are high during infancy, childhood, adolescence and last two trimesters of pregnancy. Iron is a critical element in the functioning of cells, but free iron is highly toxic. Ferritin and hemosiderin are storage forms of iron.

Laboratory indices of iron deficiency are lowered serum iron, low ferritin level, and high total iron binding capacity (TIBC). Other tests include complete blood count (CBC) where MCV and MCHC are reduced, peripheral smear, soluble transferrin receptor protein (TRP), stool for hemoglobin, hemoglobin electrophoresis and urine for hemoglobin and hemosiderin.

Treatment includes iron (oral or parenteral) and red cell transfusion, as necessary.

### Clinical Case Study 39.3 Answer

Diagnosis: Hyperparathyroidism, leading to hypercalcemia and hyperphosphatemia.

Biochemical mechanism: Elevated parathyroid hormone level acts by binding its receptor to activate the adenylate cyclase/protein kinase signaling system. Primary hyperparathyroidism, usually because of a solitary parathyroid adenoma, is the most likely cause when hypercalcemia is discovered in an otherwise asymptomatic patient. Hypercalcemia may be the presentation of intoxication with vitamin D, or calcium-containing antacids, genetic conditions like familial hypocalciuric hypercalcemia and hyperparathyroidism as part of a multiple endocrine neoplasia syndrome are uncommon. Most patients have no symptoms with mild hypercalcemia below 12.0 mg/dL, except polyuria. With levels above 13 mg/dL, patients begin developing

neurological symptoms (lethargy, stupor, coma, psychosis), gastrointestinal symptoms (anorexia, nausea, peptic ulcer disease), kidney problems (polyuria, nephrolithiasis), and musculoskeletal complaints (myalgias, weakness.) The symptoms of hyperparathyroidism can be summarized as: stones (kidney), moans (abdominal pain), groans (myalgias), bones (bone pain), and psychiatric overtones. Diagnosis can be established by finding hypercalcemia and hypophosphatemia, with elevated PTH levels. Symptomatic patients can be treated with parathyroidectomy.

### Clinical Case Study 39.4 Answer

Muscle pain and cramps, stiffness, tingling of hands and feet, carpopedal spasm and positive Trousseau's sign are indicative of hypocalcemia. Two common causes for hypocalcemic tetany are hypoparathyroidism or chronic renal failure. Abnormal renal function tests, arterial blood gases, hemogram and urine calcium/creatinine ratio would point towards a renal cause for hypocalcemia. High serum alkaline phosphatase and low parathyroid hormones would indicate hypoparathyroidism. Antimicrosomal antibody may be elevated in the latter state. Hypoparathyroidism may be due to parathyroid aplasia or hypoplasia, parathyroid hormone gene mutations, autoimmune parathyroiditis, hemosiderosis, Wilson's disease, or accidental removal during thyroid surgery.

Additional tests include electrolytes (magnesium, phosphate and other electrolytes), renal function tests (urea and creatinine), arterial blood gases, liver function tests (albumin, coagulation studies and other liver function tests), PTH and Vitamin D levels. Cardiac assessment may be necessary to rule out cardiac effects of hypocalcemia.

### Clinical Case Study 39.5 Answer

The patient is suffering from hypoparathyroidism, due to decreased activity of PTH. Treatment with  $^{131}\text{I}$  decreased thyroid cells, but also killed neighboring parathyroid cells leading to persistent hypoparathyroidism in this patient. Carpopedal spasm is due to hypocalcemia and can be treated by calcium and vitamin D supplementation.

Causes of hypoparathyroidism are: (1) Primary—which is permanent and irreversible, could be congenital or acquired, (2) Iatrogenic—Excision of all 4 parathyroid glands, as during surgery of thyroid or other neck surgeries, extensive irradiation of face, neck or mediastinum,

parathyroidectomy, (3) Autoimmune hypoparathyroidism, (4) Congenital, (5) Metal overload conditions like hemochromatosis and thalassemia, (6) Wilson's disease, (7) Hypomagnesemia, (8) Neonatal hypoparathyroidism, and (9) Pseudohypoparathyroidism—due to resistance to PTH.

Clinical features are paresthesias, irritability, fatigue, anxiety, mood swings, personality disturbances, seizures, hoarseness of voice, wheezing and dyspnea, muscle cramps, biliary colic, electrolyte disturbances (hypomagnesemia, hypokalemia and alkalosis) and tetany with positive Chvostek's sign and Trousseau sign. Hypocalcemia can produce a variety of associated features like extrapyramidal choreoathetotic syndromes, spastic paraplegia, ataxia, papilledema, emotional disturbances, cataracts, abnormal dentition, dry, puffy skin and effects on heart including congestive heart failure.

### QUICK LOOK OF CHAPTER 39

- Factors favorably influencing calcium absorption are—calcitriol, PTH, acid pH, and arginine.
- Factors decreasing calcium absorption are—Phytic acid, high phosphate content and malabsorption syndromes.
- Calcium activates enzymes, such as protein kinases, glycogen synthase, pyruvate carboxylase, pyruvate dehydrogenase.
- Calcium mediates contraction of muscle fibers.
- Calcium mediates secretion of insulin, PTH, calcitonin, ADH and can act as a second messenger for some hormones, e.g. Glucagon.
- Calcium is known as Factor IV in blood coagulation.
- Hypercalcemia may occur in hyperparathyroidism, multiple myeloma, bone cancer, and Paget's disease.
- Hypocalcemia leads to tetany as seen in renal tubular acidosis.
- Hypernatremia is seen in Cushing's syndrome and after prolonged cortisone therapy. Hyponatremia is seen in Addison's disease.
- Renal loss of potassium is seen in renal tubular acidosis, tubular necrosis, metabolic alkalosis.
- Hyperchloremia is seen in dehydration, Cushing's syndrome, respiratory acidosis, renal tubular acidosis.
- Hypochloremia is seen in excessive vomiting, Addison's disease, and respiratory alkalosis.
- Iron homeostasis is maintained by regulation of absorption and not by excretion.
- Transport form of iron transferrin. Storage form is ferritin. Iron deficiency may be caused by hookworm infection, nephrosis, lead toxicity, and leads to microcytic hypochromic anemia. Iron toxicity leads to hemosiderosis.
- Copper in plasma is bound to ceruloplasmin. It functions as co-factor for Vitamin C mediated hydroxylations.
- Copper is essential for formation of Hb, deficiency leading to microcytic normochromic anemia.
- Copper level in blood is lowered in Wilson's hepatocellular degeneration.
- Menkes Kinky hair syndrome, an X-linked disease is caused due to decreased copper transport in the blood.
- Zinc is stored in combination with metallothioneine. More than 300 enzymes are known to be Zinc dependent.

# CHAPTER 40

## Energy Metabolism and Nutrition

### Chapter at a Glance

The reader will be able to answer questions on the following topics:

- Calorific value, respiratory quotient
- Basal metabolic rate (BMR)
- Specific dynamic action (SDA)
- Proximate principles
- Nitrogen balance
- Nutritional values of proteins
- Limiting amino acids, supplementation
- Kwashiorkor and marasmus
- Prescription of the diet
- Glycemic index

A sound knowledge of the principles of nutrition is of paramount importance in developing countries, where more than 60% populations are below the poverty line. Dietetics is the science of food and nutrients, their action, interaction and balance in health and disease. The main purpose of the food is to provide energy for muscular activity and also to supply basic body building materials such as essential amino acids.

### Calorific Value

The energy content of food materials is measured in calories. **One calorie** is the heat required to raise the temperature of 1g of water through 1°C. Since it is a very small unit, in medical practice, the energy content is usually expressed in **kilocalorie** (kcal) which is equal to 1000 calories. [One kilo calorie is equal to 4.2 kilojoules (kJ)]. The maximum available energy contained in a food can be measured by burning it in an atmosphere of oxygen in a bomb calorimeter.



George H  
Whipple  
NP 1934  
1878–1976

The **calorific value** of nutrients otherwise known as “**energy density**” (energy yield per unit weight of food) is given in Table 40.1.

### Respiratory Quotient

- i. Respiratory quotient (RQ) is defined as the ratio of volume of CO<sub>2</sub> produced in L/g to the oxygen consumed in L/g.
- ii. RQ of carbohydrates is 1; RQ of fats is 0.7; that of proteins is 0.8 (Table 40.1).
- iii. For a mixed diet it is between 0.7 and 1, often around 0.82–0.85. When the rate of utilization of fat increases in relation to carbohydrates, RQ falls. This happens in diabetes mellitus, when utilization of carbohydrate is reduced. The RQ is lowest when ketolysis is very active.
- iv. The energy produced is approximately equal to 20 kJ/L of oxygen for all metabolic fuels (Table 40.1, last column).





Wilbur Atwater  
(1844–1907)



Francis  
Benedict  
(1870–1957)



BMR measurement

## Energy Requirements of a Normal Person

While calculating the energy requirements, we have to consider the energy required for:

- i. Maintenance of basal metabolic rate (BMR)
- ii. Specific dynamic action or thermogenic effect of food
- iii. Extra energy expenditure for physical activities.

## Basal Metabolic Rate

### Definition

- i. The basal metabolic rate (BMR) is the energy required by an awake individual during physical, emotional and digestive rest. It is the minimum amount of energy required to maintain life or sustain vital functions like the working of the heart, circulation, brain function, respiration, etc. The metabolic rate during sleep is less than BMR.
- ii. **Resting metabolic rate (RMR)** is the measure of energy required to maintain life or vital functions. The subject is awake and non-fasting. It is approximately about 3% higher than the BMR.
- iii. BMR is measured directly by the heat evolved, or indirectly by the volume of oxygen consumed and carbon dioxide evolved per unit time.

### Measurement of BMR

- i. **Procedure:** Atwater-Benedict-Roth basal metabolism apparatus (closed circuit method) is used. The person should be awake, but at physical and mental rest. The temperature of surroundings should

be comfortable (about 25°C). The subject breathes in oxygen from a metal cylinder. The CO<sub>2</sub> produced is absorbed in soda lime. The subject is asked to breathe through a mouthpiece for 6 minutes. The oxygen present in the cylinder is utilized during this time. The volume of oxygen consumed is recorded.

- ii. **Calculation:** The BMR is calculated from oxygen consumption, calorific value and surface area. Let oxygen consumed in 6 minutes be “Y” liters. It is shown that **calorific value of oxygen** is 4.8, that is, when 1 liter of oxygen is utilized, 4.8 kilocalories are generated. Therefore, heat produced in 6 minutes = 4.8 × Y or heat produced in 24 hours = 4.8Y × 10 × 24 kilocalories.
- iii. **Indirect calorimetry:** When deuterium (<sup>2</sup>H) and <sup>18</sup>O labeled water is given, these isotopes are eliminated at different rates. Deuterium is eliminated only as water, while oxygen is eliminated as CO<sub>2</sub> as well as water. The difference between the two elimination rates is therefore a measure of CO<sub>2</sub> production. The **double labeled water method** (Nathan Lifson) provides a measure of total CO<sub>2</sub> production over 2–3 weeks. The method is useful to measure alterations in energy requirements during growth, pregnancy, lactation, etc.

### Factors Affecting BMR

- i. **Age:** During the period of active growth, BMR is high. It reaches a maximum by 5 years of age. In old age BMR is lowered.
- ii. **Sex:** Males have a higher BMR than females.
- iii. **Temperature:** BMR increases in cold climate as a compensatory mechanism to maintain body temperature. Eskimos have a higher BMR.
- iv. **Exercise:** The increase in BMR during exercise is due to increased cardiac output. *Starvation* lowers BMR.
- v. **Fever:** About 12% increase in BMR is noticed per degree centigrade rise in temperature.
- vi. **Thyroid hormones:** Since thyroid hormones have a general stimulant effect on rate of metabolism and heat production, BMR is raised in hyperthyroidism and lowered in hypothyroidism. All other factors (No. 1 to 6) are taken into account in the definition of BMR.

**TABLE 40.1:** Calorific value of nutrients

Nutrient	Energy yield kcal / g	Energy yield kJ / g	O <sub>2</sub> consumed L / g	CO <sub>2</sub> produced L / g	RQ	Energy yield kJ / L of O <sub>2</sub>
Carbohydrates	4	16	0.829	0.829	1	20
Fats	9	37	2.016	1.427	0.71	20
Proteins	4.2	17	0.966	0.782	0.81	20
Alcohol	7	29	1.429	0.966	0.66	20

Thus, thyroid function determines the changes in BMR.

### Normal Value for BMR

- i. Since BMR is affected by body surface area, it is usually expressed in kilocalories per hour/square meter of body surface. Body surface area is calculated using the formula (Eugene DuBois and Delafield DuBois, 1915).  
 $A = W^{0.425} \times H^{0.725} \times 71.84$ , where A = area in sq cm, H = height in centimeters and W = weight in kilograms.  
 Nomograms showing body surface area from height and weight are also available. The BMR is then calculated from the values of oxygen consumption, calorific value and surface area. Nomograms showing body surface area from height and weight are also available.
- ii. For adult men normal value for BMR is 34–37 kcal/m<sup>2</sup>/hour, and for women, 30–35 kcal/m<sup>2</sup>/hour. For easier calculations, BMR for an adult is fixed as **24 kcal/kg** body weight/day. The values thus obtained are rounded to the nearest whole number.

### Specific Dynamic Action (SDA)

- i. This refers to the increased heat production or increased metabolic rate following the intake of food (**thermogenic effect** of food) (**diet-induced thermogenesis**).
- ii. Part of this is due to the expenditure of energy for digestion; absorption and active transport of products of the digestion. Another reason for this expenditure of energy is that reserve materials, such as glycogen, triacyl glycerol, protein, etc. are synthesized from small molecules available after digestion.
- iii. This energy is trapped from previously available energy, so that the actual energy from the food is lesser than that of theoretical calculation. SDA can be considered as the activation energy needed for a chemical reaction. This activation energy is to be supplied initially.
- iv. Suppose a person takes 250 g of carbohydrates; this should produce  $250 \times 4 = 1000$  kcal. But before this energy is trapped, about 10% energy (= 100 kcal) is drawn from the reserves of the body. Thus the net generation of energy is only 1000 minus 100 = 900 kcal.

- v. If the person wants to get 1000 kcal, he should take food worth 1100 kcal. Thus additional calories, equivalent to SDA has to be added in diet.
- vi. The values of SDA are: for proteins 30%, for lipids 15%, and for carbohydrates 5%. This means that out of every 100 grams of proteins consumed, the energy available for doing useful work is 30% less than the calculated value.
- vii. Hence for a mixed diet, an extra 10% calories should be provided to account for the loss of energy as SDA.
- viii. It is a common experience that during hot weather following the consumption of a protein rich meal, one feels hot and humid for a while. On the other hand, in cold weather, the same would provide a comfortable feeling.

### Physical Activity

- i. The energy requirements would depend on the occupation, physical activity and lifestyle of the individual.
- ii. The activity level may be divided into 3 groups—sedentary, moderate and heavy. Additional calories are to be added for each category.
- iii. For sedentary work, +30% of BMR; for moderate work, +40% of BMR; and for heavy work, +50% of BMR should be added. (Tables 40.2 and 40.3).
- iv. Requirement for energy during pregnancy is +300 kcal/day, and during lactation is + 500 kcal/day, in addition to the basic requirements.
- v. The energy requirement of a 55 kg male doing moderate work, may be calculated as shown in Table 40.4.

**TABLE 40.2:** Energy requirements in activity

Activity	Energy required in kcal/hour (over and above BMR)
1. Eating	28
2. Writing	30
3. Driving a car	63
4. Walking	140
5. Cycling (speed 2 km/h)	175
6. Running	490
7. Swimming (3.5 km/hour)	550

## Requirements of Dietary Nutrients

The recommended dietary allowance (RDA) provides extra provisions to prevent the development of deficiency. The RDA has been prescribed for all the essential nutrients as per the stipulations of the WHO and FAO. The Indian Council of Medical Research (ICMR) has suitably modified these for Indian conditions (see also Appendix V).

## Proximate Principles

In the diet proximate principles are carbohydrates, fat and proteins. Moreover, required amounts of minerals and vitamins are also to be provided. Further, additional requirements for growth, pregnancy, lactation and convalescence are to be provided in the food.

## IMPORTANCE OF CARBOHYDRATES

The dietary carbohydrates provide a major fraction of the body's energy needs. Ideally carbohydrates may provide about **60–65% of total calories**. In addition to calories, the carbohydrates also provide dietary fiber.

## Dietary Carbohydrates

- i. **Available carbohydrates:** These can be metabolized by the body to give energy, e.g. starch and sugars (Table 40.5).

**TABLE 40.3:** Energy requirement and occupation

Type of activity	Occupation
Light	Office workers, Lawyers, Accountants, Doctors, Teachers, Architects, Shopworkers
Moderate	Students, Industry workers, Farm workers, Housewives without mechanical appliances
Very active	Agricultural workers, Miners, Unskilled laborers, Athletes, Factory workers
Heavy work	Lumber jacks, Blacksmiths, and Construction workers

**TABLE 40.4:** Calculation for energy requirement for a 55 kg person, doing moderate work

For BMR	= 24 × 55kg	= 1320 kcal
+ For activity	= 40% of BMR	= 528 kcal
Subtotal	= 1320 + 528	= 1848 kcal
+ Need for SDA	= 1848 × 10%	= 184 kcal
Total	= 1848 + 184	= 2032 kcal
Rounded to nearest multiple of 50		= 2050 kcal

- ii. **Unavailable carbohydrates:** These cannot be assimilated and constitute only the dietary fiber (Table 40.7).
- iii. The major dietary polysaccharide is **starch**. It is digested by amylase to maltose and then hydrolyzed to glucose. This glucose is the major source of fuel for most organs and tissues. Excess is converted to fat and stored.
- iv. On cooking starch is made more soluble and accessible to digestive enzymes. Cereals, pulses and tubers are the major sources of starch in the diet. Germination of legumes leads to partial breaking down of the starch present in them. Table 40.6 gives a list of common food items with their starch content.

## Sucrose

- i. Cane sugar is mainly used as a sweetening agent. In young children high intake of sucrose and sucrose-rich food items predispose to the development of **dental caries**. Sucrose is easily fermented by the bacteria present in dental plaque, which would damage the enamel and lead to caries (tooth decay).
- ii. In adults, consumption of large quantities of refined sugars is not advisable since they tend to produce a sudden rise in blood glucose levels. This will also lead to excessive calorie intake.
- iii. Sucrose consumption also results in increased levels of plasma lipids.
- iv. While prescribing diets for diabetic patients and for weight reduction, sucrose should be strictly avoided. Jaggery, an alternative source of sucrose is beneficial, since it is a good source of iron.

**TABLE 40.5:** Sources of carbohydrates

Carbohydrate	Source	Average daily intake	Relative sweetness
Sucrose	Cane sugar	50–100 g	100
Lactose	Milk	10–15 g	30
Maltose	Malt	Traces	
Fructose	Fruits, honey	2.5 g	170
Glucose	Do	2–5 g	50
Starch	Cereals, pulses and tubers	200–300 g	0
Glycogen	Meat	Traces	0
Dextrins	Along with starch	Traces	0

## Dietary Fiber

- i. The unavailable or **indigestible** carbohydrate in the diet is called dietary fiber.
- ii. Dietary fiber is necessary to maintain the **normal motility** of gastrointestinal tract. The comparatively high incidence of colon cancers in developed countries, and the low incidence of the same in vegetarian population like Indians, pointed to the importance of dietary fiber. Table 40.7 gives a list of unavailable carbohydrates, their chemical nature and possible physiological effects.
- iii. Diet rich in fiber improves bowel motility, prevents constipation, decreases reabsorption of bile acids thus lowering cholesterol level and improves glucose tolerance. For **hypoglycemic** and **hypolipidemic** effect, see glycemic index at the end of this Chapter. The beneficial effect is more with soluble fiber present in vegetables and only a diet having plenty of vegetables and green leaves will have the desired effect.
- iv. Fiber requirement is about 30 g/day. The inclusion of fiber rich food in weight reducing diets is found to be helpful, since it provides a feeling of fullness without consumption of excess calories.

**TABLE 40.6:** Carbohydrates in common foods

1. Cane sugar	100%	2. Cassava (Tapioca)	85%
3. Rice	80%	4. Honey	80%
5. Wheat	70–80%	6. Cakes	55–65%
7. Bread	50–60%	8. Potatoes	25%

**TABLE 40.7:** Dietary fibers

Fiber	Chemical nature	Physiological effect
Cellulose	Polymer of glucose	Retains water in feces; promotes peristalsis, increases bowel action
Hemi-cellulose	Pentoses, hexoses and uronic acid	Retains water in feces, increases bile acid excretion
Lignin	Aromatic alcohols hypocholesterolemic	Antioxidant, increases bile acid excretion
Pectins	Partially esterified rhamnogalacturonan	Absorbs water, slows gastric emptying, binds bile acids, increases their excretion

## NUTRITIONAL IMPORTANCE OF LIPIDS

### Neutral Fats or Triacylglycerols

- i. Fats provide a concentrated source of energy. In developed countries, the percentage of calories derived from fats may be as high as 40%, but in the developing countries it is much less, around 10%.
- ii. A minimum intake of lipids is essential since the requirements of fat soluble vitamins and essential fatty acids are to be met.
- iii. Fats increase the taste and palatability of food. They are the favored cooking medium.
- iv. **Visible fat** or fat consumed as such, e.g. butter, ghee, oils. Recommended daily intake of visible fat is 10% of calories or 20 g/day; in pregnancy 30 g/day and during lactation 45 g/day.
- v. **Invisible fat** or fat present as part of other food items, e.g. egg, fish, meat, cereals, nuts and oil seeds. Even cereals contain 1g of fat per 100 g. More than half of essential fatty acid in Indian diet is in the form of invisible fat.

### Cholesterol and Heart Diseases

- i. The atherogenic effect of cholesterol and the risk of coronary artery disease in people with hypercholesterolemia are described in Chapter 25. Hence it is always advisable that dietary intake should be restricted.
- ii. Food items known to be rich in cholesterol (egg yolk, liver, brain, kidney) are to be consumed in limited amounts. Table 40.8 gives a list of food items with their cholesterol content.
- iii. Vegetables, cereals and pulses do not contain any cholesterol. On the other hand, vegetable sterols will inhibit cholesterol absorption.
- iv. Saturated fats raise serum cholesterol; while unsaturated fats lower it. Therefore unsaturated fat (vegetable oils and fish oils) are to be preferred.
- v. The poly unsaturated fatty acids (PUFA) are present in vegetable oils and fish oils (Table 40.9). They belong to **essential fatty acids**. They are precursors of prostaglandins and leukotrienes. PUFAs are required for esterification and excretion of cholesterol. They reduce the cholesterol level in blood and are **anti-atherogenic** (see Chapter 25).



- vi. The omega-3 fatty acids from fish oils decrease the plasma lipoproteins, (VLDL and LDL) and thereby decrease the risk of coronary artery disease. The contents of PUFA in oils are given in Table 40.10; a detailed list is given in Chapter 7.
- vii. High fiber content also reduces serum cholesterol, lowers LDL fraction and raises HDL fraction. Whole cereals, pulses, leafy vegetables and fruits contain good quantity of fiber.
- viii. **Trans fatty acids** (TFA) are atherogenic. They lower HDL level and elevate LDL level. TFA are present in dairy products and hydrogenated edible oils. It is widely used in food industry, since it increases the shelf life of fried food. Cooking media containing PUFA and fast food preparations have a high content of trans fatty acids. Trans fatty acids adversely affect endothelial function and aggravate insulin resistance and diabetes. It is high in processed foods and bakery products, where hydrogenated vegetable oils are used for cooking.
- ii. **Excess of PUFA:** Anything in excess is deleterious. Excess PUFA may lead to production of free radicals that may be injurious to the cell. PUFA should not be more than 30% of total fat.
- iii. Moreover, the fat content should be such that saturated fatty acid (SFA) : monounsaturated fatty acid (MUFA): polyunsaturated fatty acid (PUFA) may be in 1:1:1 ratio.
- iv. Further, cholesterol intake should be less than 250 mg/day.

## IMPORTANCE OF PROTEINS

### Essential Amino Acids

- i. Proteins form the building blocks for body tissues. Only 10–15% of the total energy is derived from proteins. When enough carbohydrates are present in the diet, the amino acids are not used for yielding energy. This is known as the **protein sparing effect** of carbohydrates. During starvation, amino acids may act as energy sources.
- ii. Proteins are the only source of **essential amino acids** (see Box 3.1). The requirement of protein is shown in Table 40.11. As per the WHO / FAO recommendation in 1985, the safe levels of protein intake for an adult is 0.75–0.8 g/kg/day.
- iii. For the synthesis of body proteins, all the essential amino acids should be supplied in adequate quantities at the same time.
- iv. Cysteine and tyrosine can be synthesized, when methionine and phenylalanine are available; thus requirement of the precursor amino acid is determined by the availability of the product. The remaining amino acids can be synthesized, provided there is enough supply of proteins in total. Only 3 amino acids (alanine, aspartate and glutamate) are truly dispensable, as they can be

### Recommended Daily Intake of Fat

- i. The ideal fat intake is about 15–20% of total calories, out of which about 25–30% may be PUFA. This will be a total of about 20–25 g of oils and about 3 g of PUFA for a normal person.

**TABLE 40.8:** Cholesterol content of food items

Food item	Cholesterol content mg/100 g
Hen's egg, whole	300
Egg yolk	1330
Liver	300–600
Brain	2000
Butter	280
Ghee	310
Meat and fish	40–200
Milk	10

**TABLE 40.9:** Sources of PUFA

Name	Carbon atoms	Family omega	No. of double bonds	Dietary source
Linoleic acid	18	$\omega$ 6	2	Vegetable oils
Linolenic acid	18	$\omega$ 3	3	Vegetable oils
Arachidonic	20	$\omega$ 6	4	Vegetable oils
Timnodonic	20	$\omega$ 3	5	Fish oils

**TABLE 40.10:** Fatty acids in oils

Fat or oil	Saturated (%)	Mono-unsaturated (%)	Poly-unsaturated (%)
Butter/ghee(*)	75	20	5
Safflower oil	9	12	79
Cotton seed oil	26	19	65
Coconut oil(*)	86	12	2
Ground nut oil	18	46	36

(\*) Butter / ghee contains short chain fatty acids and coconut oil contains medium chain fatty acids, which are absorbed and metabolized quickly

synthesized from pyruvate, oxaloacetate and alpha ketoglutarate respectively; and these precursors are generally available in plenty.

## Nitrogen Balance

- A normal healthy adult is said to be in nitrogen balance (Fig. 40.1), because the dietary intake (I) equals the daily loss through urine (U) feces (F) and skin (S).  
 $I = U + F + S$
- When the excretion exceeds intake, it is **negative** nitrogen balance.
- When the intake exceeds excretion, it is a state of **positive** nitrogen balance.
- Nitrogen balance can be actually measured by calculating the dietary intake of protein nitrogen (16% of the weight of protein) and measuring the daily excretion.

## Factors Affecting Nitrogen Balance

- Growth:** During the period of active growth, a state of positive nitrogen balance exists. On an average when a person gains 5 kg, about 1 kg proteins are added to the body. For this, about 160 g of nitrogen has to be retained, so he/she has to be in positive nitrogen balance.
- Hormones:** Growth hormone, insulin and androgens promote positive nitrogen balance, while corticosteroids cause a negative nitrogen balance.

- Pregnancy:** A pregnant woman will be in a state of positive nitrogen balance due to the growth of fetus.
- Convalescence:** A person convalescing after an illness or surgery will be in positive nitrogen balance, due to active regeneration of tissues.
- Acute illness:** Negative nitrogen balance is seen in subjects immediately after surgery, trauma and burns.
- Chronic illness:** Malignancy, uncontrolled diabetes mellitus and other debilitating diseases show negative nitrogen balance. For explanation, see Cachexia.
- Protein deficiency:** The deficiency of even a single essential amino acid can cause negative nitrogen balance. Prolonged starvation is another important cause.

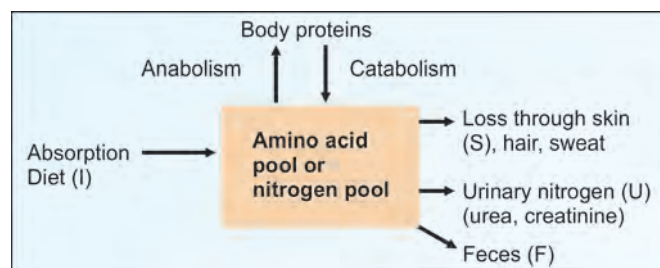
## Maintenance of Nitrogen Balance

To maintain the nitrogen balance, one has to satisfy the need for nitrogen intake, which are:

- Obligatory nitrogen loss is 3.5 g of N/day for a 65 kg person (urinary, fecal and cutaneous loss). This could be equivalent to 22 g of protein.
- Requirement for protein turnover. The minimum daily requirements to compensate for the above two categories are 0.75 – 0.8 g / kg wt of good quality protein.
- Protein requirements for growth. This is applicable in the case of infants, children, adolescents, pregnancy, lactation and convalescence. As growth stops, protein requirement also decreases.

**TABLE 40.11:** Recommended protein allowances

Infants	2.4 g/kg body wt/day
Children up to 10 years	1.75 g/kg body wt/day
Adolescent boys	1.6 g/kg body wt/day
girls	1.4 g/kg body wt/day
Adult (Men and women)	0.8 g/kg body wt/day
Pregnancy	2 g/kg body wt/day
Lactation	2.5 g/kg body wt/day



**Fig. 40.1:** Nitrogen balance

## Nutritional Values (Nutritional Indices)

### Assessment of Nutritional Values

Whipple (Nobel Prize, 1934) introduced plasmapheresis as a means to assess the nutritional value of proteins. Plasma from animal was taken, albumin was removed, the rest of plasma was introduced back into the animal. The time for regeneration of original level of albumin in plasma was taken as a parameter of the quality of the food given to the animal.

The modern, easier way, to assess the nutritional value of a protein, is to give that protein as the only source of nitrogen to an animal, and assess the weight gain (Fig. 40.2). The protein content of various food items are shown in Appendix VI. The nutritive value is shown in Table 40.12. The following indices are used to assess the nutritional value of proteins.

### Biological Value (BV) of Protein

It is the ratio between the amount of nitrogen retained and nitrogen absorbed during a specific interval.

$$BV = \frac{\text{Retained nitrogen}}{\text{Absorbed nitrogen}} \times 100$$

Suppose 127 mg of protein "A" was consumed by a rat in a day and 4 mg is recovered in feces and 24 mg is seen in urine. Then

Amount ingested = 127 mg  
 Amount absorbed = 127 - 4 = 123 mg  
 Amount retained = 123 - 24 = 99 mg  
 Therefore BV = 99 / 123 × 100 = 81%

### Net Protein Utilization (NPU)

$NPU = \text{Retained nitrogen} / \text{intake of nitrogen} \times 100$

In the above example,

NPU of protein "A" = 99 / 127 × 100 = 78%

and for protein "B", it is 4.5 / 100 × 100 = 4.5%.

Thus NPU is a better index than BV to denote nutritional quality and availability of a protein (Table 40.12).

### Net Dietary Protein Value (NDPV)

This will assess both quantity and quality of the proteins in the diet.

$NDPV = \text{Intake of N} \times 6.25 \times NPU$

### Protein Efficiency Ratio (PER)

It is the weight gain per gram of protein taken. The essential amino acid content can also be expressed in terms of *chemical score* (mg of amino acid per gram of protein). By comparing the chemical score of different proteins with egg protein which is taken as a reference protein, the essential amino acid content can be assessed.

## Limiting Amino Acids

Certain proteins are deficient in one or more essential amino acids. If this particular protein is fed to a young rat as the only source of protein, it fails to grow. This amino acid is said to be the **limiting amino acid**. Limiting amino acid is that which limits the weight gain when a protein is supplied to an animal (Fig. 40.2).

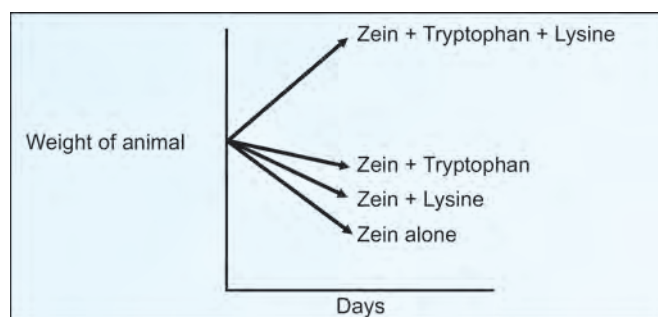


Fig. 40.2: Identifying the limiting amino acid

## Mutual Supplementation

This problem may be overcome by taking a mixture of proteins in the diet. **Mutual supplementation of proteins** is thus achieved (Table 40.13). For example, pulses are deficient in methionine, but rich in lysine.

On the other hand, cereals are deficient in lysine, but rich in methionine.

Therefore a combination of pulses plus cereal (e.g. *chappathi + dal*) will cancel each other's deficiency and become equivalent to first class protein. The supplementation effect of proteins may be seen in weight gain in animals (Fig. 40.3).

## PROTEIN-ENERGY MALNUTRITION

- i. It is the most widespread nutritional problem in developing countries; predominantly affecting children.

TABLE 40.12: Nutritive value of proteins

Source of protein	BV	NPU	PER	Chemical score
Egg	90	91	4.5	100
Milk	84	75	3.0	65
Meat	80	76	2.8	70
Fish	85	72	3.0	60
Rice	64	57	2.0	60
Wheat	58	47	1.7	42
Bengal gram	58	47	1.7	44
Ground nut	54	45	1.7	44
Soybean	64	54	2.0	57
Gelatin	-	-	0	0
Zein	-	-	0	0

(BV = biological value; NPU = net protein utilization; PER = protein efficiency ratio)

TABLE 40.13: Limiting amino acids in proteins

Protein	Limiting amino acid	Protein supplemented to rectify deficiency
Rice	Lys, Thr	Pulse proteins
Wheat	Lys, Thr	Pulse proteins
Gelatin	Tryptophan	Milk proteins
Zein	Trp, Lys	Meat proteins
Tapioca	Phe, Tyr	Fish proteins
Bengal gram	Cys, Met	Cereals

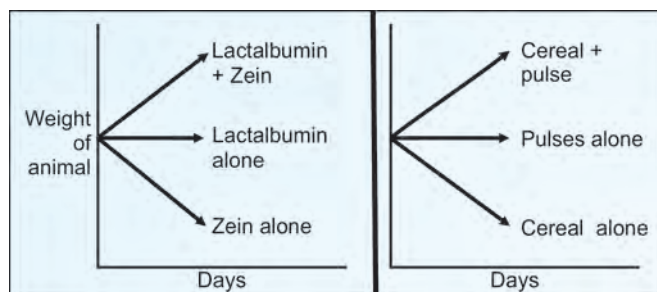
The prevalence rate varies from 20–50% in different areas depending on socioeconomic status and level of education and awareness.

- ii. At one end of the spectrum of malnutrition is **marasmus** (Greek word, “to waste”), which results from a continued severe deficiency of both dietary energy and proteins (primary calorie inadequacy and secondary protein deficiency).
- iii. At the other end of the spectrum is **Kwashiorkor**, where isolated deficiency of proteins along with adequate calorie intake is seen. Kwashiorkor means “sickness the older child gets, when the next child is born”, a term from the local language of Ga tribe of Ghana. A classification by WHO is based on body weight as a percentage of standard body weight (Table 40.14).

### Biochemical Alterations in PEM

Table 40.15 gives a comparison between Kwashiorkor and marasmus.

- i. The **hallmarks** of Kwashiorkor are hypoalbuminemia, poor wound healing and edema.
- ii. **Hypoalbuminemia:** Albumin values less than 2 g/dL is a biochemical marker in cases of Kwashiorkor. In marasmus, this may not be so low.
- iii. IgG increases due to associated infections.
- iv. **Fatty liver** is seen in some cases of Kwashiorkor, but not in marasmus. Fatty liver is due to decreased lipoprotein synthesis.
- vi. Glucose tolerance is often normal, but **hypoglycemia** may be seen in marasmic children.
- vii. **Hypokalemia** and dehydration may be seen when there is diarrhea.
- viii. **Hypomagnesemia** is a usual finding.



**Fig. 40.3:** Two second class proteins, when combined, are equivalent of the first class protein

### Treatment of Protein-Energy Malnutrition

Optimal response is observed with diets providing 150–200 kcal/ kg body weight and 3–4 g of protein/ kg body weight. A mixture of three parts of vegetable proteins (Bengal gram or peanuts) and one part of milk protein is found to be very effective. It is monitored by disappearance of edema, rise in serum albumin level and gain in weight.

**TABLE 40.14:** WHO classification of malnutrition

Type of PEM	% of body wt. compared to standard weight	Edema	Deficiency in weight for height
Kwashiorkor	80–60	+	+
Marasmic Kwashiorkor	<60	+	++
Marasmus	<60	Nil	++
Nutritional dwarfism	<60	Nil	Nil
Underweight child	80–60	Nil	Nil

**TABLE 40.15:** Comparison between the salient features of Kwashiorkor and marasmus

	Marasmus	Kwashiorkor
Age of onset	Below 1 year	One to 5 year
Deficiency of	Calorie	Protein
Cause	Early weaning and repeated infection	Starchy diet after weaning, precipitated by an acute infection
Growth retardation	Marked	Present
Attitude	Irritable and fretful	Lethargic and apathetic
Appearance	Shrunken with skin and bones only. Dehydrated	Looks plump due to edema on face and lower limbs
Appetite	Normal	Anorexia
Skin	Dry and atrophic	‘Crazy pavement dermatitis’ due to peeling, cracking and denudation
Hair	No characteristic change	Sparse, soft and thin hair; curls may be lost
Associated features	Other nutritional deficiencies; Watery diarrhea Muscles are weak and atrophic	Angular stomatitis and cheilosis are common; Watery diarrhea Muscles undergo wasting
Serum albumin	2 to 3 g/dL	< 2 g/dL
Serum cortisol	Increased	Decreased



## Sequelae of Protein Calorie Malnutrition

Severe malnutrition in early life can lead to permanent and irreversible physical and functional deficits. Severe persistent malnutrition may have deleterious effects on the intellectual capacity in later life. There may not be any sequelae where the moderate and mild forms are corrected in time. Since the children of today are the force of tomorrow, a nationwide effort is to be made to eradicate childhood malnutrition.

### Cachexia Due to Diseases

Patients with advanced cancer, AIDS (HIV infection), tuberculosis, etc. are seen as undernourished; this is called cachexia. This is similar to marasmus, but the loss of body protein is more than that seen in simple malnutrition. Cachexia is explained by the following facts:

1. Chronic infections and cancer will induce production of inflammatory **cytokines**; this leads to breakdown of protein by ubiquitin or proteasome pathway. This increases the energy expenditure. BMR is considerably increased.
2. Cytokines also stimulate **uncouplers**, such as thermogenin, leading to increased oxidation and thermogenesis without trapping energy.
3. **Futile cycling of lipids** occurs, as the hormone sensitive lipase is activated by proteoglycans secreted by tumors. So, free fatty acids are liberated from adipose tissue. These are utilized for triacylglycerol synthesis in liver; this is a process that needs high expenditure of energy. This fat is again reaching adipose tissue through VLDL, thus completing the futile cycle.
4. Most of the tumors preferentially use **anaerobic glycolysis**, the end result being lactic acid. This enters the gluconeogenesis pathway in liver, which is an energy consuming reaction (requiring 6 ATPs for each glucose unit).

## OBSESITY

Malnutrition may be of two types; undernutrition or overnutrition. The latter is otherwise called obesity. Obesity is the most prevalent nutritional disorder in prosperous developed countries. All over the world, obesity is prevalent in affluent people. This is because human race is accustomed to poverty and malnutrition from time immemorial, and the body is designed to store energy whenever available. This is the first generation in history, where foodstuffs are in plenty. So, by habit people eat more and get obese. Obesity is the condition in which excess fat has accumulated. This is due to the increased energy intake and decreased energy expenditure. The **obesity index**, is calculated as  $W/H^2$  (Where W = weight in kg and H = height in meters); it is used to assess the obesity. "Obesity index" is an old

terminology; the modern expression is **body mass index (BMI)**. The most widely used marker for body muscle mass index is 24 hours urinary creatinine excretion. A person is obese when BMI exceeds 27.8 kg/m<sup>2</sup> in men and 27.3 kg/m<sup>2</sup> in women (excess of 120% of desirable body weight).

Central obesity may be Android or apple type (abdominal in males) and Gynecoid (around breast, hips and thighs in women).

Obesity can occur only as a result of ingestion of food in excess of the body's needs. Daily energy expenditure (DEE) is the basal metabolic rate + physical activity + diet induced thermogenesis. The major causes are food habits (intake of calorie rich food in excess amounts) and lack of exercise. Upper body fat deposition is mainly by hypertrophy (increase in size of existing cells) whereas lower body type obesity is by hyperplasia (increase in the number of adipocytes). **Genetic** predisposition has been suggested. If one parent is obese, there are 50% chances for the children becoming obese. However, no gene alone is responsible for the production of obesity.

### Diseases Related to Obesity

Sensitivity of peripheral tissues to insulin is decreased. The number of **insulin receptors** are decreased in adipose tissue cells. Plasma insulin levels may be elevated. Obesity is associated with substantially increased **cardiovascular risk**. Increased waist to hip ratio (abdominal obesity) is a greater risk. In metabolic syndrome (**Syndrome-X**) insulin resistance, hyperglycemia, hyperlipidemia (increased LDL and decreased HDL) and obesity are seen (see Chapter 24).

The major ill effects of obesity are increased risk of **coronary artery disease, diabetes mellitus, hypertension, metabolic syndrome** and a reduced lifespan. Calorie-fat-restricted diet may retard aging process and extend the lifespan.

### Treatment of Obesity

Lifestyle modification is the best suitable remedy. The goal is to reduce the intake of calories and fat. Frequent small meals with lots of vegetables will make the food palatable and give a feeling of satiety. Controlled exercise is very useful. See Box 40.1 for the special diet for obesity. In patients with higher grades of obesity, drugs may be given to decrease appetite (endocannabinoid receptor antagonists will decrease the intake of food).

## Regulators of Appetite

**Hypothalamus** has the central control of appetite. Psychologic, genetic, neural and humoral factors are involved in the control. High level of cortisol (as in Cushing's syndrome) leads to obesity. MSH (melanocyte stimulating hormone) is a powerful appetite suppressant, and any genetic mutation in the gene will have its effect. Patients with Prader Willi syndrome, (deletion of a part of chromosome 15) and Laurence-Moon-Biedl syndrome (genetic defect) tend to overeat and are obese. Polypeptides that **increase appetite** are: Neuropeptide Y (NPY), Ghrelin, Melanin concentrating hormone (MCH), Orexin, Endocannabinoid, Cholecystokinin (CCK), Polypeptide YY (PYY), Insulin and Cortisol. **Appetite decreasing factors** are: Leptin, Melanocyte stimulating hormone (MSH), Glucagon related peptide 1 (GLP1), Cocaine-amphetamine related transcript (CART) and Serotonin.

## Adipose Tissue Talks to Brain Through Factors

1. **Leptin** (Greek *leptos* = thin) is a hormone secreted by adipocytes. It is a 16 kDa protein with 167 amino acids. It plays a key role in regulating energy intake and energy expenditure, including appetite and metabolism. It is the product of "ob" gene (in mice). The corresponding human gene is "Lep" which is present on human chromosome 7. Fasting or following a very low calorie diet (VLCD) lowers leptin levels. Leptin administration inhibits gastric ulcer formation in rats and stimulates growth of esophageal adenocarcinoma cells. It is mainly produced by white adipose tissue and to a certain extent by gastric mucosal cells. It functions as a satiety signal. It is an index of the energy reserve in the body. When the energy reserve is adequate, leptin levels are increased and this would suppress further food intake. When there is enough fat deposit, leptin secretion is stimulated. Leptin inhibits neuropeptide-Y secretion, and so when fat depots are full, appetite is decreased. Mutation of leptin or mutation of its receptor

in hypothalamus leads to removal of this feedback mechanism; so uncontrolled eating and obesity are the results. Obesity is associated with leptin resistance and high levels of leptin in plasma. Ob gene produces leptin and in its absence, obesity develops. The administration of recombinant leptin is found to be effective in the control of childhood obesity. Leptin improves insulin sensitivity in muscles as well as in liver. In both muscles and liver, leptin reduces intracellular triacylglycerol levels. There is an 'adipo-insular axis', with insulin promoting leptin secretion and leptin inhibiting insulin release. The effect of leptin on insulin levels is due to inhibition of proinsulin synthesis as well as reduction of insulin secretion.

2. **Neuropeptide-Y**, a hypothalamic polypeptide, stimulates desire for carbohydrates. Neuropeptide-Y is also secreted by the small intestinal (ileum) N cells. It is also present in the entire nervous system, adrenal gland and pancreas. The action is to inhibit insulin secretion.
3. **Ghrelin** is secreted mainly by adipocytes and also by P/D1 cells lining the fundus of the human stomach and epsilon cells of the pancreas. It is a polypeptide, in which fatty acids are incorporated. It stimulates hunger and appetite by acting on the hypothalamus. Plasma level of Ghrelin is increased in fasting state, which produces hunger signals. Ghrelin levels increase before meals and decrease after meals. Ghrelin also plays a significant role in the hippocampus, and is essential for cognitive adaptation to changing environments and in the process of learning. Recently, ghrelin has been shown to activate the endothelial isoform of nitric oxide synthase. Ghrelin increases growth hormone secretion. See also Chapter 54.
4. Another neuropeptide, **Galanin** increases the craving for fatty foods.
5. **Adiponectin**—The Leptin : Adiponectin ratio in subjects with metabolic syndrome (MS) was significantly higher than that in subjects without MS. Adiponectin is also described in Chapter 54.
6. **Visfatin**: It is also called as pre-B-cell colony enhancing factor (PBEF). It is mainly secreted by adipocytes. Visfatin does not promote insulin resistance; on the contrary, it has an effect on glucose uptake mediated by direct binding and activation of the insulin receptor.
7. **Omentin**: It is another peptide secreted predominantly by visceral fat. It has positive effects on glucose uptake, and works as an insulin sensitizer. Omentin is made by stromal-vascular cells within the adipose tissue, rather than by adipocytes.
8. **Tumor necrosis factor-alpha**: Its levels are elevated in obesity and in insulin-resistant states. It reduces insulin action. Interestingly, TNF is not derived from adipocytes; but macrophages have been implicated in TNF production from adipose tissue.
9. **Resistin** is another small inflammatory molecule with hyperglycemic action. Levels of resistin are elevated in obesity. Resistin increases hepatic glucose output. Human resistin is the product of macrophages or within the fat depot, and not by adipocytes. See Chapter 54.
10. **Retinol-binding protein 4**: Overexpression of RBP4 impairs hepatic and muscle insulin action. High serum RBP4 levels are

### Box 40.1: Diet for obesity (Dieting)

Different types of diets are prescribed during dieting, all of which aim at a negative calorie balance. Consuming less food or consuming a low fat diet will not have the desired effect, because the body will have a tendency to switch to the fasting metabolic profile soon after meals. Robert Atkins proposed a low carbohydrate ketogenic high protein diet (Atkin's diet) for losing weight. According to Atkins, only 20 g of carbohydrate per day is given (normal desirable intake is 100 – 120 g per day), but unlimited consumption of fat and proteins are permitted. When such a diet is consumed, the liver will be predominantly gluconeogenic and ketogenic. Peripheral tissues will utilize the excess ketone bodies for their energy needs. The substrate for gluconeogenesis is mainly gluconeogenic amino acids. ATP is provided by oxidation of fatty acids. Insulin secretion as well as the increment in glucose in the post prandial state is low. This low carbohydrate diet was found to give promising results in 6–12 weeks trials compared to low calorie, low fat diets. More long-term trials are necessary to prove the efficacy of the low carbohydrate ketogenic diet.

associated with insulin resistance in obese humans and those with type 2 diabetes.

11. **Non-esterified fatty acids** (NEFAs) are primarily released from adipose tissue during fasting. Circulating NEFAs reduce adipocyte and muscle glucose uptake, but promote hepatic glucose output. The net effect is to promote lipid burning as a fuel source in most tissues, while sparing carbohydrate for neurons. Because lipolysis in adipocytes is repressed by insulin, insulin resistance from any cause can lead to NEFA elevation, which, in turn, induces additional insulin resistance as part of a vicious cycle.
12. **Inflammation in obesity:** Obesity and type 2 diabetes are inflammatory states, consistent with the production of pro-inflammatory cytokines such as TNF and IL-6 by adipose tissue. In obese, bone-macrophages are recruited to adipose tissue, under the influence of proteins secreted by adipocytes, which includes macrophage chemoattractant protein-1 (MCP-1). Intra-adipose macrophages are dominant contributors to the insulin resistance that is associated with obesity. Thiazolidinediones, which are PPAR- $\alpha$  agonists used clinically as insulin sensitizers, reduce MCP-1 levels and macrophage infiltration into adipose tissue.
13. **Sleep and obesity:** Less sleep can cause increased hunger, appetite and body weight. For children and adults, hours of sleep per night is inversely related to BMI. Sleep deprivation produces decreased leptin secretion, increased ghrelin levels and decreased glucose tolerance. Average amount of sleep has steadily decreased among adults and children during the past several decades, all over the world, along with increase in incidence of obesity.

## PRESCRIPTION OF DIET

### General Principles

Recommended dietary allowances (RDA) of nutrients are given in detail in Appendix V. While prescribing the diet of a person; the following general rules are to be remembered.

- i. **The ideal body weight:** The underweight person should be given more nutrients and the overweight person should reduce calorie intake. The ideal body weight for an average adult male is taken as 48 kg for a height of 153 cm, plus or minus 1.25 kg for every cm. For an average *adult female*, the ideal body weight is 45 kg for a height of 153 cm, plus or minus 1 kg for every cm. For exact values, see Appendix VII.
- ii. **Protein requirement :** 1 g per kg body weight for adults and 2 g per kg for children. During pregnancy and lactation, protein requirement is about 2.5 g per kg.
- iii. **Calorie requirement:** This depends on age, sex, height, weight, health status and above all on the physical activity and occupation. As a rule of thumb, the calorie requirement for a person is taken as 30–35 kcal per kg of ideal body weight. For sedentary habits,

lower values (30 kcal) and for moderate muscular activities, higher values (35 kcal) are prescribed.

Considering the average weight of adult Indians between 55 to 65 kg, average calorie requirement will be between 1700 and 2300 kcal per day.

An extra allowance of 300 kcal is necessary during pregnancy and lactation periods. During convalescence, extra 300 kcal has to be supplied.

- iv. **Specific dynamic action:** Extra energy is to be supplied to account for SDA.
- v. **Ratio:** Balanced diet should contain calories from carbohydrate, proteins and fat in the **ratio of 60:20:20**. The important steps in prescribing the diet are enumerated in Box 40.2.

### First Step: Calorie Requirement

For a 60 kg sedentary man, the energy requirement is  $60 \times 30 = 1800$  kcal plus additional allowance for specific dynamic action ( $1800 \times 10\% = 180$ ). Therefore the total requirement is roughly 2000 kcal. The recommended dietary intake for a 60 kg sedentary man, based on the above principles is given in Table 40.16.

### Second Step: Proximate Principles

He requires 60 g proteins. This will give  $60 \times 4 = 240$  kcal of energy. His total requirement is 2000 kcal. Therefore carbohydrates plus fats should provide  $(2000 - 240) = 1760$  kcal. As a general rule, about 20% of total calories are supplied by fat. Therefore, fats should supply  $1760 \times 20\% = 350$  kcal which is provided by  $(350 / 9) =$  about 35 g of fats. (About 30% of the total fat may be supplied as poly unsaturated fatty acids).

The rest 1400 kcal are supplied by 350 g of carbohydrates. These calculations are based on the fact that 1 g carbohydrate

#### Box 40.2: Steps in prescribing a diet

This problem is approached by solving the following questions sequentially:

1. What is the requirement of the person with regard to calorie and other essential nutrients?
2. What is the quantity of proximate principles required?
3. Which composition of food will give the above requirement?
4. How can a palatable diet that contains these food items be prescribed?
5. The total quantity may be divided into 3 or 4 meals at convenient intervals of time.

provides 4 kcal, 1 g fat supplies 9 kcal and 1 g protein gives rise to 4 kcal. Thus the requirements calculated in Table 40.16 may be rewritten as in Table 40.17.

### Third Step: General Composition of Food

The third step is to calculate how these proximate principles are supplied as common foodstuffs. For this exercise we should familiarise with the nutritive value of foodstuffs. A simplified version is given in Table 40.18. Detailed values are shown in the Appendix VI of this book.

### Fourth Step: Determine the Items of Food

Knowing the requirement (Table 40.17) and the nutritive value of foodstuffs (Table 40.18), it is possible to write down the items of the food. A fundamental principle of dietetics is the “food exchange”. It is very useful for calculation of the proximate principles. Accordingly, foods with similar nutrient composition are grouped together. This is also useful to provide variety in the food.

**TABLE 40.16:** First step in the prescription of diet

Energy required + SDA	:	2000 kcal
Protein	:	60 g
Calcium	:	400 mg
Iron	:	25 mg

### Food Exchange Systems

Table 40.19 shows that one *chapati* or one *idli* or one large slice of bread will give equal quantities of energy and proteins. They are nutritionally equivalent. “Legume-pulse exchange system” is also described in Table 40.19.

### Mutual Supplementation of Cereals and Pulses

Although protein content of pulses is more than cereals, average Indian diet contains more cereals, and hence proteins are mainly supplied by cereals. But pulses give good quality proteins.

A judicious combination of cereals and pulses provide all the essential amino acids (pulses are deficient in methionine, while cereals lack in lysine). An accepted formula is that the food should contain pulses and cereals in the **ratio of 1:5** to provide good quality proteins.

Supplementing the cereals with animal proteins is certainly good to improve the quality, but at a higher cost. Fruits and vegetables will provide vitamins and minerals.

**TABLE 40.17:** Prescription of diet; 2nd step

Proteins	:	60 g
Fats	:	35 g
Carbohydrates	:	350 g
Calories	:	2000 kcal
Calcium	:	400 mg
Iron	:	25 mg

**TABLE 40.18:** Nutritive value of food items (Per 100 g of edible portion)

Food	Protein g	Fat g	Carbohydrate g	Energy kcal	Calcium mg	Iron mg
Cereals (Wheat, rice)	10	1	65	300	20	5
Pulses (Bengal gram)	20	5	55	300	50	10
Tubers (Potato)	1	0	25	100	0	0
Green leafy vegetables	2	0	4	20	20	3
Fruits (banana)	2	0	10	50	10	1
Nuts and oils seeds	20	50	20	600	50	5
Milk and curd	3	4	5	60	200	0
Egg	13	13	0	170	50	0
Meat	20	3	0	100	150	3
Fish	20	10	0	170	20	1
Oils and ghee	0	100	0	900	0	0
Sugar	0	0	100	400	0	0



Vitamin A is available in ripe mango, papaya, carrot, beet root, and other leafy vegetables. B complex vitamins may be supplied by cereals (parboiled rice, whole wheat powder) and green leafy vegetables. Major sources of calcium are milk, cereals, pulses and green leafy vegetables. Iron is mainly supplied by pulses, cereals, vegetables, meat and liver. Jaggery is a good source for iron. Jaggery is therefore superior to refined sugar, especially for children. Milk is a very poor source for iron.

### Prescribing a Normal Diet

Now we can assemble this knowledge to prepare a diet to suit the requirements given in Table 40.17. The result is given in Table 40.20. This will satisfy the requirements regarding protein (60 g) fats (45 g), calories (2000 kcal), calcium (400 mg) and iron (25 mg). See that cereals-pulses ratio is maintained at 5:1. When calories alone are to be increased, as in the case of a person having severe muscular exercise, tubers and roots will serve this purpose.

### Fifth Step: Three Meals Per Day

The total quantities of proximate principles, thus calculated are divided into breakfast, lunch and supper. The basic principles are summarized in Box 40.3.

**TABLE 40.19:** Food exchange system

Food exchange content			
Cereals exchange			
One <i>chapati</i> (20 g wheat) or One large slice of bread or Cooked rice 3 tablespoon (20 g raw) or One <i>idli</i>	Protein	2 g	
	Carbohydrate	15 g	
	Energy	70 kcal	
Legumes-pulses exchange			
Bengal gram ( <i>channa</i> ) 100 g or, Black gram ( <i>urad</i> ) 100 g or, Green gram ( <i>moong</i> ) 100 g or, Red gram ( <i>arhar</i> ) 100 g or, Horse gram ( <i>Kulthi</i> ) 100 g	Protein	24 g	
	Carbohydrate	60 g	
	Energy	340 kcal	

**TABLE 40.20:** A diet for a 60 kg sedentary man

Item	Quantity vegetarian	Quantity non-vegetarian
Cereals	350 g	350 g
Pulses	75 g	60 g
Vegetable oil	40 mL	25 mL
Milk	250 mL	150 mL
Leafy vegetable	200 g	200 g
Sugar	25 g	25 g
Fish/meat	-	60 g

### Diet for Patients with Diabetes

Management of diabetes gives great emphasis for dietary control and exercise. The main aim is to keep the blood glucose level as near the normal values, for as many hours, as possible in a day. The overall blood glucose level will be increased if there is a steep rise in blood sugar after every meal. Therefore, to maintain the average value near normal, we should reduce the post-prandial hyperglycemia. This aim is achieved by:

- Giving a diet having low glycemic index, so that elevation in blood glucose is minimal
- Giving the total calories in small divided doses, so that small quantity of food is taken at frequent intervals (2 hrs) between 6 AM and 8 AM.

### Glycemic Index

It is assessed by the glucose tolerance test (the glycemic response) after the particular diet and comparing it with a reference meal. The reference meal is always taken as 50 g of glucose (Fig. 40.4).

$$\text{Index} = \frac{\text{Incremental area under glucose tolerance curve after 50 g test meal}}{\text{Incremental area under curve after 50 g of reference meal (glucose)}} \times 100$$

Simple carbohydrates such as glucose or sugar will have a high glycemic index. But the same quantity of complex carbohydrates (such as starch) will not increase the blood glucose to the same extent, because digestion and absorption are slow. So the glycemic index of complex carbohydrate is lesser than cane sugar (refined sugar).

#### Box 40.3: Important points for prescribing a diet

- It should be a balanced, well planned diet containing all essential nutrients.
- The diet should be simple, locally available, palatable and digestible.
- Adequate protein content with essential amino acids should be supplied. This is achieved by a cereal-pulse mixture with additional animal proteins, if necessary.
- Calorie intake should be correct and should balance energy expenditure.
- Special care should be taken to see that adequate quantity of calcium and iron are obtained from the diet. The absorption of these minerals is reduced by other factors in Indian diet.
- Should have variety and should not differ very much from the habitual diet of the person.
- Should provide adequate roughage.

As a general rule, the glycemic index of carbohydrate is lowered if it is combined with protein, fat or fiber, preferably at least two of the three. The glycemic index of some of the foods are shown in Table 40.21.

Although ice cream contains sugar, it has a low glycemic index, because it contains lot of fat which prevents absorption. Thus ice cream may be occasionally consumed by diabetic patients.

The calorie requirement is distributed into proximate principles in the following manner for a diabetic patient: Carbohydrate 60–70%, fat 15–25% and protein 15–20%.

Other general principles for prescribing a diabetic diet are:

- Sugar, sweet and refined carbohydrates are avoided.
- Leafy vegetables are increased, and tubers are restricted.
- Frequent small meals are prescribed, with distribution of calories such that, breakfast 15%, mid-morning snack 5%, lunch 30%, evening tea 10%, dinner 35%, bedtime snack 5%.

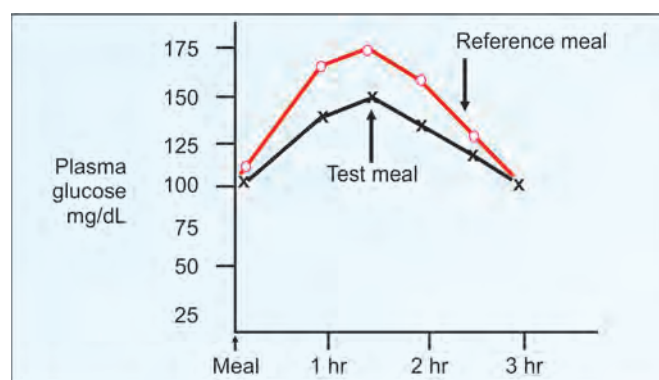


Fig. 40.4: Glycemic index curve

TABLE 40.21: Glycemic index of food items	
Item of food	Glycemic index
Potato chips	80 – 90
Bread	70 – 79
White rice (polished)	70 – 79
Parboiled (brown) rice	60 – 69
Bananas	60 – 69
Beans, peas	40 – 49
Legumes, peanuts	35 – 40
Milk	35 – 40
Ice cream	35 – 40

## Nutrition in the Elderly

Improvement of health care facilities has increased life expectancy over the decades so that there has been 3 to 4 fold increase in the number of old people (chronological age >65) all over the world. The increase in people living to their 80s and 90s have stretched the public health care system. The elderly with limited regenerative capacity are more prone to disease with very little output in developmental activities. Diseases of the old like cancer, dementia, osteoporosis, cardiovascular and cerebrovascular incidents are on the rise. Now 100 out of the 150 deaths occurring per day are due to age related causes. By 2013 the number will reach 10 million in India. The National Programme for Health Care of Elderly (NPHCE) was launched in 2012-11.

Defining specific nutritional needs for elderly is essential since they are vulnerable to malnutrition. BMR and Lean body mass decrease with age. Hence energy requirements are also lower. Requirements of some nutrients decrease where as some are required in higher levels. WHO is addressing the issue of diet affected health problems in the elderly. In 2002 WHO set the stage for “Keep fit for Life, Meeting the Nutritional Needs”. Nutritional requirements in the elderly are shown in Table 40.22.

## Total Parenteral Nutrition (TPN)

In patients who cannot (unconscious; removal of large part of gut) or should not (major trauma or surgery) use their gastrointestinal tract, total parenteral feeding has to be resorted. It contains glucose and amino acids. About 10–30% glucose, 1–1.5 g / kg body weight protein, a fat emulsion containing 1–4 g fat / kg body weight, along with multivitamins and trace element solution are commonly used. The solution should also contain adequate amounts of sodium, potassium, calcium and magnesium. The solution may be infused through one of the large vessels like subclavian vein or superior vena cava, where the blood flow is sufficient to dilute the hypertonic solution. This procedure is known as total parenteral nutrition (TPN) or intravenous hyperalimentation.

## Nutraceuticals

The term “nutraceutical” was coined from “nutrition” and “pharmaceutical”. A nutraceutical can be defined as “a food that provides medical or

TABLE 40.22: Nutritional requirements in the elderly per day

Item	Males	Females
Energy 60 – 69 yrs	2300 kcal	1900 kcal
Energy > 70 yrs	2100 kcal	1800 kcal
Calcium	700 mg	700 mg
Phosphate	550 mg	550 mg
Proteins	53 g	48 g
Iron	15 mg	15 mg
Vitamin A	600 µg	600 µg
Vitamin D	1500 IU	1500 IU
Folate	200 µg	200 µg
Vitamin B <sub>12</sub>	1.5 µg	1.5 µg

health benefits, including the prevention and/or treatment of a disease.” Another accepted definition is “a product isolated or purified from foods that is generally sold in medicinal forms not usually associated with food”. The nutraceuticals, attempt to accomplish desirable therapeutic outcomes with reduced side effects, as compared with other therapeutic agents. However, nutraceuticals need further extensive scientific study to prove that they have medicinal effects with reduced side effects. Some examples of the approved nutraceuticals and the reduced risk of specific disease given in parenthesis: Potassium (High blood pressure and stroke); Plant sterols (Coronary heart disease); Soy protein (Coronary heart disease); Calcium (Osteoporosis); Fruits and vegetables (Cancer); Grain products that contain soluble fiber (Coronary heart disease); Folic acid (Neural tube birth defects); Resveratrol from grape (antioxidant); flavonoids from citrus (antioxidant); Omega-3 fatty acids in fish oil (lowered risk of cardiovascular disease).

A **dietary supplement** is a product that contains nutrients derived from food products that are concentrated in liquid or capsule form. They may include: vitamins, minerals, herbs, amino acids or metabolites.

**Functional foods** are either enriched or fortified, a process called nutrification. This practice restores the nutrient content in a food back to similar levels from before the food was processed. Sometimes, additional complementary nutrients are added, such as vitamin D to milk. Athletes use a variety of **nutritional ergogenic foods** to enhance performance. Carbohydrates consumed immediately before or after exercise enhance performance by increasing glycogen stores and delaying fatigue. Protein and amino acid supplementation may serve an anabolic role. Dietary antioxidants, such as vitamins C, E and carotenes may prevent oxidative stress that occurs with intense exercise. Performance during high-intensity exercise, such as sprinting, may be improved with short-term creatine loading. Caffeine before exercise delays fatigue and may enhance performance.

### Clinical Case Study 40.1

A 2-year-old boy was brought to the hospital. He was eating poorly for the last one month, had intermittent diarrhea, and had become irritable and apathetic. On examination, he was underweight for height and small for age. He was pale, weak, skin was flaky, hair was brittle, abdomen was distended, liver was moderately enlarged and generalized edema was present. Laboratory tests were as follows—Hemoglobin—6.5 g/dL, Total protein—4.0 g/dL, Albumin—1.8 g/dL. What is the probable diagnosis?

### Clinical Case Study 40.2

An 8-month-old girl was brought to the clinic in an irritable state. Weight was much lower than expected, mid arm circumference and triceps thickness were very low for age. Creatinine-height index was low and serum albumin was normal. The mother tells that she had stopped breast-feeding at the age of 6 months and was now giving only

formula milk (which was diluted). What is the probable diagnosis?

### Clinical Case Study 40.3

A 35-year-old female presented with complaints of alternating diarrhea and constipation. She reported abdominal discomfort and bloating that were relieved by bowel movement. The episodes were worse in times of stress. She denies any blood in the stools, weight loss and anorexia. No history of fever or drug intake. Physical examination was within normal limits. She was prescribed a cellulose containing dietary supplementation to increase the bulk of stools. What is the likely diagnosis? What is the effect of the treatment modality prescribed?

### Clinical Case Study 40.1 Answer

The child is suffering from protein energy malnutrition (kwashiorkor). This is a severe form of childhood malnutrition characterized by edema, irritability, anorexia, ulcerating dermatitis, enlarged liver with fatty infiltrates and when well advanced, there may be inadequate growth, lack of stamina, loss of muscle tissue, increased susceptibility of infections, vomiting, diarrhea, anorexia and edema. Eventually there is stupor, coma and death.

The condition may develop when mother weans the child from breast milk and replaces the diet with food rich in carbohydrates, and deficient in proteins. Along with protein deficiency, micronutrient and antioxidant deficiencies, like iron, folate, iodine, selenium, vitamin C, glutathione, albumin, vitamin E and PUFA, may play an important role. Treatment includes treatment of dehydration, antibiotics, a diet providing adequate proteins, vitamins, minerals and electrolytes.

### Clinical Case Study 40.2 Answer

The child is suffering from nutritional marasmus, a type of protein energy malnutrition (PEM). There is inadequate intake of proteins and calories leading to emaciation. Low body weight, diminished skin fold thickness, and reduced arm muscle circumference reflect loss of fat and catabolism of proteins from the body. All available fat stores have been exhausted due to starvation.

PEM might be (1) primary (due to lack of food) or (2) secondary, due to disorders affecting GI function, wasting diseases like AIDS, cancer, renal failure, or

conditions that increase metabolic demands like infections, hyperthyroidism, burns, trauma, etc. Edematous PEM is Kwashiorkor and non-edematous PEM is marasmus. Another type is known as marasmic-Kwashiorkor PEM.

All organs are affected in malnutrition. Dietary proteins, energy and micronutrients become deficient. Weight loss, immunodeficiency, neurological changes, fatty degeneration and other effects are seen. Laboratory tests include CBC, measures of protein nutritional status assessment like serum albumin, retinol-binding protein, prealbumin, transferrin, creatinine and BUN levels, serum electrolytes, blood glucose, urinalysis and culture and arterial blood gases (often metabolic acidosis is present). If child has history of abnormal stools, stool specimens should be checked for ova and parasites.

Best treatment is oral balanced diet, if child can take oral feeds. Severe PEM or prolonged starvation requires treatment in a hospital with controlled diet.

### Clinical Case Study 40.3 Answer

The patient is likely suffering from irritable bowel syndrome, a gastrointestinal disorder of unknown etiology. Common symptoms include abdominal cramps or pain, bloating and flatulence. There might be alternating periods of diarrhea and constipation and passing mucus in the stools. Vomiting, blood in stools, pain that interrupts sleep, fever and weight loss are rare.

Diagnosis is made by excluding other causes. Stool bulking agents, antispasmodics, antidiarrheal agents, antidepressant drugs, serotonin receptor agonists and antagonists and chloride channel activators are used for therapy. Dietary fibers are the indigestible part of plant foods that make stool soft and enables smooth bowel movements, prevent constipation hemorrhoids and diverticulosis. Soluble fibers lower total and LDL cholesterol and help to prevent ischemic heart disease

and stroke. Soluble fibers in excess can cause abdominal bloating and flatulence, dehydration and pectins can reduce absorption of cholesterol-lowering drugs like lovastatin.

Insoluble fibers present in food include cellulose, hemicelluloses, and lignins. Excess of insoluble fibers can result in excessive gas, constipation and intestinal obstruction, diarrhea in sensitive patients, and can reduce absorption of calcium, iron, copper and zinc, especially in children. Insoluble fibers consumed on empty stomach can aggravate symptoms of irritable bowel syndrome.

### QUICK LOOK OF CHAPTER 40

1. One calorie is the heat required to raise the temperature of 1 g of water through 1°C. 1 kcal = 4.2 kJ.
2. Respiratory quotient is defined as the ratio of the volume of CO<sub>2</sub> produced to the O<sub>2</sub> consumed. Carbohydrates, fats, proteins have RQ's of 1, 0.7 and 0.8 respectively.
3. BMR is defined as energy required by an awake individual during physical, emotional and digestive rest. BMR can be measured using Benedict's Roth apparatus. Normal value for men is 34 – 37 kcal/m<sup>2</sup>/hour and for women is 30 – 35 kcal/m<sup>2</sup>/hour.
4. Increased heat production following intake of food is referred to as specific dynamic action. Values of SDA for proteins, lipids and carbohydrates are 30%, 15%, and 5% respectively.
5. Dietary fibers are essential to maintain normal motility of GI tract, prevent constipation, decrease cholesterol levels and to improve glucose tolerance.
6. Biological value of a protein is the ratio of the amount of nitrogen retained to that absorbed during a specific interval.
7. Marasmus and Kwashiorkor are two conditions of protein energy malnutrition.



# CHAPTER 41

## Detoxification and Biotransformation of Xenobiotics

### Chapter at a Glance

The reader will be able to answer questions on the following topics:

- Detoxification mechanisms
- Phase one reactions
- Oxidation, reduction, hydrolysis
- Phase two reactions
- Glucuronic acid, sulfate methylation
- Phase three reactions

**Biotransformation** is the process whereby a substance is changed from one chemical to another by a chemical reaction within the body. For some drugs, it is not the absorbed drug, but a metabolite that has therapeutic action. For example, phenoxybenzamine, a drug given to relieve hypertension, is biotransformed into a metabolite, which is the active agent.

Biotransformation also serves as an important defense mechanism in that toxic xenobiotics and metabolites are converted into less harmful substances that can be excreted from the body.

In general, biotransformation reactions generate more polar metabolites, that are readily excreted from the body. The liver plays the most important role in the biotransformation reactions.

The biochemical processes whereby the noxious substances are rendered less harmful and more water soluble, are known as **detoxification**. Lipophilic toxicants are hard for the body to eliminate and can accumulate to hazardous levels.

**Xenobiotics** are compounds which may be accidentally ingested or taken as drugs or compounds produced in the body by bacterial metabolism. (Greek, xenos = strange). Molecules to be eliminated/detoxified are called xenobiotics.

Biotransformation is not exactly synonymous with detoxification, since in many cases, the metabolites are more toxic than the parent substance. This is known as **bioactivation or toxication**. An example is the biotransformation of vinyl chloride to vinyl chloride epoxide, which covalently binds to DNA and RNA, a step leading to cancer of the liver. The compounds that are detoxified include:

- a. Compounds accidentally ingested like preservatives, food additives and adulterants.
- b. Drugs taken for therapeutic purposes.
- c. Compounds produced in the body which are to be eliminated, e.g. bilirubin and steroids. Bilirubin is toxic to the brain of newborns and may cause irreversible brain injury. Biotransformation of the lipophilic bilirubin molecule in the liver results in the

production of water-soluble (**hydrophilic**) metabolites excreted into bile.

- d. Compounds produced by bacterial metabolism, e.g. amines produced by decarboxylation of amino acids:

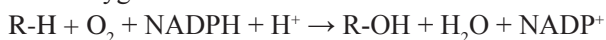
Histidine	→	Histamine
Lysine	→	Cadaverine
Ornithine	→	Putrescine
Tyrosine	→	Tyramine
Tryptophan	→	Tryptamine

The transformation of a specific xenobiotic can be either beneficial or harmful, and perhaps both depending on the dose. A good example is the biotransformation of acetaminophen, a commonly used drug to reduce pain and fever. It normally undergoes rapid biotransformation with the metabolites quickly eliminated in the urine and feces; hence no toxicity is observed.

But at high doses, the normal level of enzymes may be saturated. The excess acetaminophen undergoes additional biosynthetic pathway, which produces a metabolite that is toxic to the liver.

## Cytochrome P450 Enzyme Systems

The cytochrome P450 enzymes are involved in the biotransformation reactions. They are **heme-containing** enzymes, localized in the **endoplasmic reticulum of liver**. They are so named, because they absorb light at wave length of 450 nm, when exposed to carbon monoxide. They are mono-oxygenases:



NADPH (and not NADH) is the co-enzyme for all the P450 enzymes. Electrons are transferred from NADPH to cytochrome P450. This leads to the reductive activation of molecular oxygen. One atom of oxygen is inserted into the substrate.

Cytochrome P450 contains phosphatidylcholine. Almost all common drugs are metabolized by the P450 system. There are about 150 **isoforms** of the P450 enzymes. They are classified according to structural homology, into family, subfamily etc. CYP is the accepted abbreviation. For example, CYP1A1 denotes that it is a cytochrome P450, belonging to family 1 and subfamily A. It is the first member in that subfamily. The genes of the corresponding proteins are described with the same name, except that genes are written with italics.

They are **inducible** enzymes. **Phenobarbital** causes increased activity of P450. The anticoagulant Warfarin is metabolized by CYP2C9. If the same patient is taking phenobarbitone, the enzyme is induced, the level of the enzyme is increased, warfarin is broken down quickly, and the dose of warfarin becomes inadequate. Similarly **ethanol** induces

CYP2E1, which metabolises many carcinogens. Thus, the risk of carcinogenicity is increased after the use of ethanol.

CYP1A1 and some other members of the family are used in the metabolism of polycyclic aromatic hydrocarbons (PAHs). So this group is sometimes called **aromatic hydrocarbon hydroxylases (AHHs)**. Cigarette smoke contains various aromatic hydrocarbons, these are activated by AHHs.

Some of the isoforms of the enzyme exhibit low catalytic activity (polymorphism). This explains the **variation in drug responses** among different persons. For example, there are 3 alleles for CYP2A6, which catalyze nicotine of tobacco. The person with the inactive allele is protected against addiction to tobacco.

The P450 enzymes are seen in many tissues, including **adrenal glands**, where they are present both in mitochondria and in microsomes. The mitochondrial P450 enzymes utilise NADPH linked flavoprotein, **adrenodoxin reductase**, and a non-heme iron-sulfur protein, **adrenodoxin**. They are mainly involved in steroid biosynthesis.

## Phases of Detoxification Processes

Biotransformation reactions are usually classified as Phase one and Phase two reactions.

**Phase one** is the alteration of the foreign molecule, so as to add a functional group, which can be conjugated in phase 2. Phase 1 reactions result in the formation of compounds with decreased toxicity (**detoxification**). Sometimes this may result in increased toxicity (**entoxification**), e.g. methanol to formic acid.

The phase 1 reactions include hydroxylation, oxidation, reduction, hydrolysis, dealkylation, epoxidation, etc.

The products of metabolic transformations are either excreted directly or undergo further metabolism by **phase two** reactions. They involve conjugation with a conjugating agent, thus converting lipophilic compounds into water soluble, easily excretable forms. Phase 2 reactions are sulfation, acetylation, methylation and conjugation with glucuronic acid, glutathione or glycine.

In some instances, products of phase 2 reactions may further be metabolized by **phase three** reactions.

## PHASE ONE REACTIONS

### Oxidative Reactions

- It may be either aromatic or aliphatic hydroxylation. The reactions also include sulfoxidation, N-oxidation and epoxidation.
- For example, **toluene** is hydroxylated to benzyl alcohol by mixed function oxidase system (Fig. 41.1).

- iii. Sometimes both phase 1 and 2 reactions are necessary. The biotransformation of benzene requires both phase one and phase two reactions. Benzene is biotransformed initially to phenol by a phase one reaction (oxidation). Phenol has the functional hydroxyl group that is then conjugated by a phase two reaction (sulfation) to phenyl sulfate (Fig. 41.2).
- iv. The oxidation and detoxification of **alcohol** is also an important function of the liver. Two enzymes are involved in this process: alcohol dehydrogenase oxidizes alcohol to aldehyde; and aldehyde dehydrogenase oxidizes aldehyde to acid (Fig. 41.3). The **alcohol dehydrogenase** is an  $\text{NAD}^+$  linked enzyme, which is located in the cytosol. **Aldehyde dehydrogenase** is an  $\text{NAD}^+$  dependent mitochondrial enzyme.
- v. Oxidation of some compounds may result in production of substances which are more toxic, e.g.
- |                 |   |             |
|-----------------|---|-------------|
| Methanol        | → | Formic acid |
| Ethylene glycol | → | Oxalic acid |

## Reduction Reactions

Some of the reductases also contain cytochrome P-450 and are flavoproteins in nature. The major group of compounds which are reduced and detoxified by the liver are **nitro compounds**. These are reduced to their amines, while aldehydes or ketones are reduced to alcohols. An example

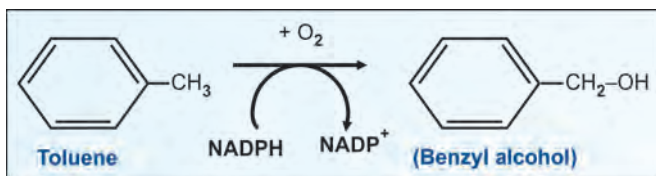


Fig.41.1: Phase one; oxidative reaction

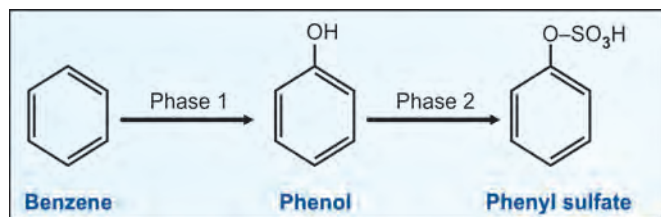
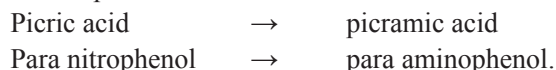


Fig. 41.2: Sometimes both phase one and two reactions are needed to detoxify a compound

is the reduction of nitrobenzene to aniline (Fig. 41.4). Other examples are:



## Hydrolysis

Hydrolysis is a chemical reaction in which the addition of water splits the toxicant into two fragments or smaller molecules. The hydroxyl group ( $\text{OH}^-$ ) is incorporated into one fragment and the hydrogen atom is incorporated into the other. Esters, amines, hydrazines, amides, glycosidic bonds and carbamates are generally biotransformed by hydrolysis. e.g. aspirin, acetanilide, procaine, xylocaine, aliphatic esters, di-isopropyl fluorophosphate (DFP), etc. (Fig. 41.5).

**Aspirin** is the drug most widely used in clinical practice. It has analgesic, antipyretic and anti-atherogenic activities. It was synthesized by Charles Gerhardt in 1853. Felix Hoffmann used it as a painkiller for the first time. Salicylic acid was known as sprinic acid, as it was produced from Spirea plants. So acetylsalicylic acid was first named as acetyl-sprin, and later, shortened to aspirin.

## PHASE TWO REACTIONS; CONJUGATIONS

- i. A xenobiotic that has undergone a phase one reaction is now a new metabolite that contains a reactive chemical group, e.g. hydroxyl ( $-\text{OH}$ ), amino ( $-\text{NH}_2$ ), and carboxyl ( $-\text{COOH}$ ). These metabolites must undergo additional biotransformation as a phase two reaction.
- ii. Phase two reactions are conjugation reactions, that is, a molecule normally present in the body is added to the reactive site of the phase one metabolite.

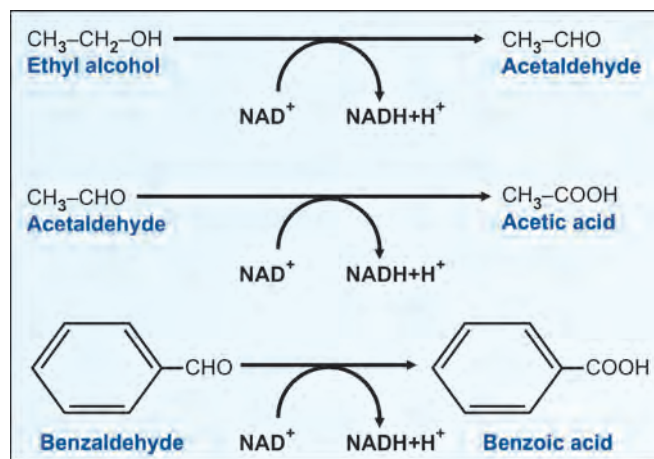


Fig. 41.3: Oxidation of alcohol groups

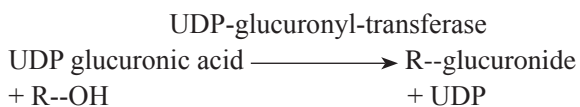
In most cases, the conjugation will make the compounds nontoxic and easily excretable.

- iii. Conjugating agents and their active forms are shown in Table 41.1. Glycine and glutamine can also act as conjugating agents.

## Glucuronic Acid

Glucuronide conjugation is the most common phase two reactions. **Bilirubin** is a good example for a compound conjugated and excreted as its glucuronide. Glucuronic acid can conjugate with hydroxyls (both phenolic and alcoholic), carbonyl, sulfhydryl and amino compounds.

The glucuronic acid is added to xenobiotics by **UDP-glucuronyl-transferases**, present in the endoplasmic reticulum.



The drug metabolizing systems are induced by the drug, e.g. barbiturates induce glucuronyl transferase and heme synthesis. A list of important types of conjugation with glucuronic acid is given in Table 41.2.

## Sulfate Conjugation

In general, sulfation decreases the toxicity of xenobiotics. The highly polar sulfate conjugates are readily excreted

**TABLE 41.1:** Phase two. Usual conjugating agents

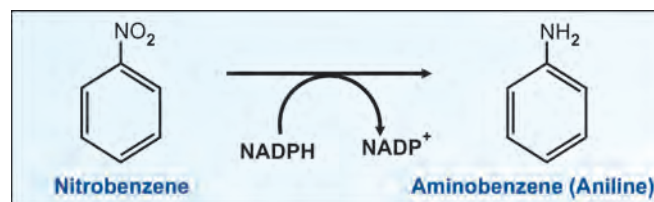
Conjugating agent	Active form
Glucuronic acid	UDP-glucuronic acid
Sulfate	PAPS (phosphoadenosine phosphosulfate)
Cysteine	Glutathione
Acetic acid	Acetyl CoA

**TABLE 41.2:** Conjugation with glucuronic acid

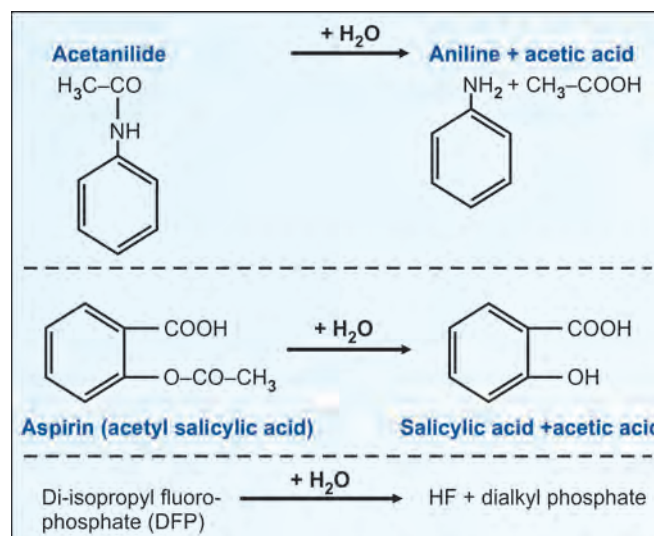
Compounds	Types of bond	Products
Phenol	Glucosidic (Ether)	Phenyl glucuronide (O-glucuronide)
Benzoic acid	Ester	Glucuronic acid monobenzoate
Bilirubin	Ester with propionic acid side chain	Glucuronic acid (see Chapter 21)
Steroids	Ester with OH group	Glucuronide of steroid
Amines	Amide	N-glucuronides

through urine. Often glucuronidation or sulfation can conjugate the same xenobiotics.

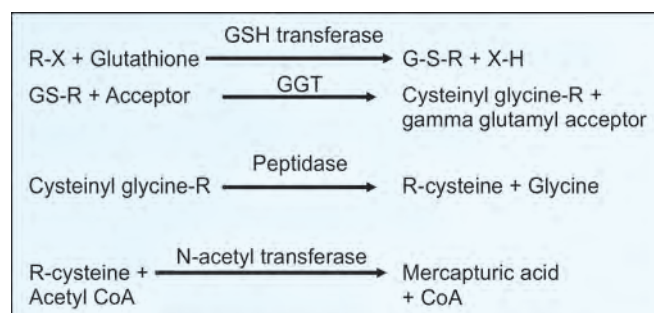
Phenolic and alcoholic compounds are conjugated with sulfate. The enzyme is sulfo-transferase and the sulfate group is transferred from PAPS (phosphoadenosine phosphosulfate, see Chapter 15).



**Fig. 41.4:** Phase one; reductive reaction



**Fig. 41.5:** Phase one. Examples of hydrolysis



**Fig. 41.6:** Phase two; glutathione as detoxifying agent  
GGT = gamma glutamyl transferase



Important compounds excreted as their sulfates include steroids and indole compounds.

## Cysteine and Glutathione

The cysteine is derived from glutathione, which is the active conjugating agent. The reaction is given in detail in Figure 41.6. Alkyl or aryl halides, epoxides and alkenes are detoxified in this manner.

## Acetylation

Conjugation with acetic acid is taking place with drugs like sulfanilamide, isoniazid and PAS (para amino salicylic acid) (Fig. 41.7).

## Conjugation with Glycine

Benzoic acid is conjugated with glycine to form **hippuric acid** (benzoyl glycine), which is excreted in urine (Fig. 41.8).

## Conjugation with Glutamine

Similarly, phenyl acetic acid is conjugated with glutamine to form phenyl acetyl glutamine (Fig. 41.8).

## Methylation Reactions

- Amino, hydroxy or thiol groups are methylated. **S-adenosyl methionine** (SAM) is the methyl donor and the enzyme is usually O-methyl transferase.

- For example, catechol-O-methyl transferase converts epinephrine to metanephrine. Pyridine is excreted as N-methyl pyridine.
- Mercaptoethanol is excreted as 5-methyl mercaptoethanol. Transmethylation reactions are given in detail in Table 16.1.
- However, methylation decreases the water solubility rather than increasing it. Metals like mercury may be methylated, making them more lipophilic, increasing permeability and causing neurotoxicity.

## PHASE THREE REACTIONS

- Phase 3 reactions are not very common. A typical example is further conjugation with glutathione.
- The xenobiotics that enter the body are mostly drugs and they are detoxified by the enzymes concerned with drug metabolism. Induction of cytochrome P-450 system may even produce unwanted effects in some persons. For example, induction of ALA synthase by barbiturates will precipitate attacks in acute intermittent porphyria (see Chapter 21).
- Beneficial effect of induction is utilized in newborns to induce glucuronyl transferase enzyme by barbiturates.
- In some cases, the xenobiotics may be converted to harmful compounds by the cytochrome P450-dependent oxygenases, e.g. Benzopyrene is converted to a carcinogen by epoxidation.
- Effect of a particular drug may vary from person to person. The drug metabolizing enzymes may show

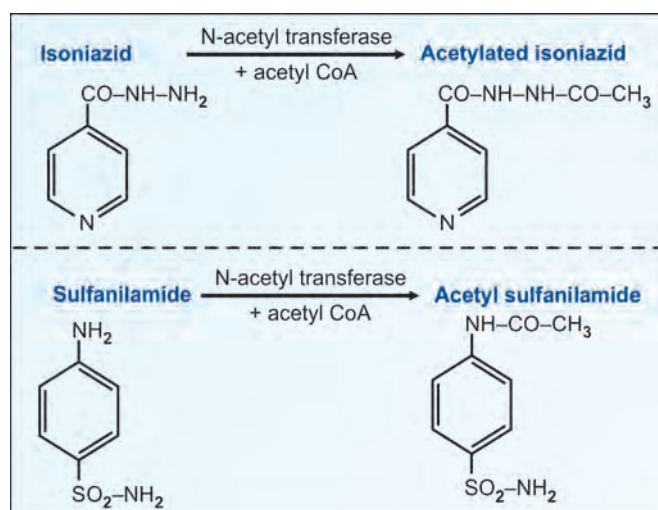


Fig. 41.7: Phase three reaction; acetylation

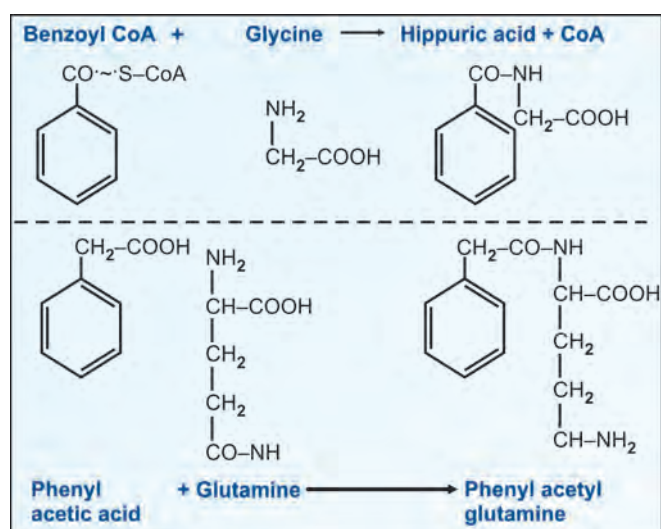


Fig. 41.8: Conjugation with amino acids

genetic variation. This may lead to decreased, increased or absent expression of enzyme activity. Some people who can metabolize the drugs, may show toxic manifestations with normal doses of the drug.

## Related Topics

Please see detoxification of free radicals (see Chapter 33) and liver functions tests (see Chapter 26).

### Clinical Case Study 41.1

A 20-year-old female was brought to the emergency department with nausea, vomiting, and complaining of abdominal pain. She had been under a lot of stress with final examinations. In her hostel room, her friends noticed an empty bottle of acetaminophen near the bed with numerous pills lying on the ground. On arrival to the emergency department, the patient was found distressed with vomiting. Laboratory tests revealed hypokalemia and elevated liver enzymes. Her white blood cell count was normal. Her acetaminophen blood level was above 200 femtogram/mL. The emergency department physician gave a gastric lavage and then prescribed oral N-acetylcysteine.

What is the pathophysiology of the liver toxicity? What is the biochemical mechanism whereby the N-acetylcysteine helps in this condition?

### Clinical Case Study 41.1 Answer

Overdose concentrations are the result of deliberate ingestion, as in this clinical case, or accidental ingestion, often involving either a child who finds a bottle of acetaminophen and consumes its contents or a disoriented elderly person who loses track of how many tablets have been consumed. Liver cell necrosis takes place, with clinical manifestations of nausea and vomiting, diarrhea, abdominal pain, and shock.

Acetaminophen is metabolized via the cytochrome P450 enzymes into a deleterious product N-acetylbenzoquinoneimine, which destroys proteins, lipids, RNA and DNA. Because the liver has high levels of cytochrome P450 enzymes, it is the major organ affected by acetaminophen overdose. Normally acetaminophen is cleared by conjugation with either glucuronic acid or sulfate followed by excretion. The antidote of toxicity is N-acetylcysteine which helps to facilitate glutathione synthesis. Glutathione is used to conjugate and thereby detoxify the toxic metabolite.

# CHAPTER 42

## Environmental Pollution and Heavy Metal Poisons

### Chapter at a Glance

The reader will be able to answer questions on the following topics:

- Corrosives
- Irritants
- Heavy metal poisons
- Lead, Mercury, Aluminum
- Pesticides and insecticides
- Occupational or industrial hazardous agents
- Air pollutants
- Toxic substances in foodstuffs

Man has tried to change the environment in different ways from the days when he was a cave dweller. Any substance present in the environment, which may produce abnormality in metabolism or alter the wellbeing of an organism, is called an environmental **pollutant**.

A **poison** is a substance which causes death or harm if introduced in the living body or brought into contact with parts of the body.

Lethal doses (per kg body weight) of some toxic substances are: Cyanide = 1 mg/kg body weight; morphine = 25 mg/kg; aspirin = 500 mg/kg; ethyl alcohol = 10 g / kg.

### ■ CORROSIVES

These are strong acids (sulfuric acid, hydrochloric acid); strong alkalis (sodium hydroxide, ammonia); and salts (zinc chloride, potassium chromate).

They remove water from the tissues, coagulate the cellular proteins and convert hemoglobin into acid hematin.

The cause of death is circulatory collapse and spasm of glottis. Sulfuric acid can be detected from the gastric fluid by reacting with barium chloride to produce a white precipitate of barium sulfate.

Ammonia, potassium hydroxide, sodium hydroxide, calcium hydroxide and ammonium carbonate are the common alkalis encountered. They remove water from the tissues and precipitate proteins.

These can be detected in the gastric juice by reacting with silver nitrate to form silver hydroxide, which forms a brown precipitate. Ammonia is highly neurotoxic (see Chapter 15).

### Cyanide Poisoning

Cyanide causes tissue anoxia by chelating the ferric ions of the intracellular respiratory enzyme, cytochrome oxidase. Poisoning may be due to suicidal attempts. Industrial exposure may occur in the persons working with hydrocyanic (prussic) acid or with potassium cyanide.

Ingestion of amygdalin, present in kernels of certain fruits (apricots, almonds, peaches) is also a common cause.

Dicobalt edetate (kelocyanor) is the antidote, which chelates the cyanide. Another method is to give sodium nitrite and sodium thiosulfate intravenously. The nitrite converts hemoglobin to methemoglobin. Ferric ion of MetHb takes up cyanide as cyanmethemoglobin so

that cytochrome oxidase is now free of cyanide. Later, thiosulfate detoxifies the cyanide by forming thiocyanate, which is excreted. But in practice, death is instantaneous and time may not be available for the treatment.

## IRRITANTS

Important chemical irritants are phosphorus, chlorine, bromine and iodine. Metallic irritants are arsenic, antimony, mercury, copper, lead, zinc and silver. Organic irritants from plants include castor, croton, and calotropis.

### Phosphorus

It is a poison affecting cellular oxidation. Accidental poisoning in children may occur due to chewing of fireworks or rat poisons. Symptoms resemble acute liver disease. The poison is oxidized in the body.

### Neurotoxins

These may act at cerebral level, e.g. opium, alcohol, ether, chloroform, datura, belladonna, cannabis, etc. Those acting at spinal level are aconite, quinine and oleander.

## HEAVY METAL POISONS

### Lead Poisoning

A 61-year old male was admitted in a medical college hospital in Bangalore with typical symptoms of lead poisoning (encephalopathy, nephropathy and anemia). The lead level in blood was over 100  $\mu\text{g}/\text{dL}$ . On detailed questioning, the patient told that he was very particular to take only "pure food" and he was preparing fresh "aatta" (wheat flour). He was powdering wheat on a small hand-mill at his house. The machine had a crusher which was fixed on the pivot by soldering with lead. So for the last 30 years, he was getting daily doses of lead along with his "pure aatta". The company had already supplied thousands of such instruments throughout the country. All those families might be getting harmful doses of lead.

#### Sources of Lead Poison

- i. Lead is the most common environmental poison in India. About 30% of population are already affected by lead poisoning. It is dispersed into air, food, soil and water. Lead poisoning is also included in the class of "summer disease", as increased temperature brings out the dust, and lead particles will also be in the air.
- ii. **Paint** is the major source for exposure, especially in children, as they bite painted toys. US law states that paints should not contain more than 0.06% of lead but Indian paints, especially cheaper ones may contain up to 30% lead salts. Paint is peeled off as small flakes from walls of living rooms.
- iii. Increased content of lead is seen in air, water and vegetables in cities and near highways. This is due to the tetraethyl lead derived from the **exhaust of vehicles**. Statutory use of lead-free petrol has reduced this type of contamination.
- iv. **Lead pipes** are important sources for contamination.
- v. **Newspapers** and xerox copies contain lead, which is adsorbed to fingertips, and later contaminate foodstuff taken by hands.
- vi. One pack of **cigarette** contains 15 micrograms of lead and chronic smokers have higher blood levels of lead.
- vii. Lead chromate is commonly used as adulterant in curcumin.
- viii. **Battery** repair, radiator repair, soldering, painting and printing are occupations prone to get lead poisoning.

#### Signs and Symptoms of Lead Poisoning

- i. Lead is a **cumulative poison** and is accumulated in tissues over the years. It is not biodegradable. 90% of lead is seen in bones, 9% in blood and 1% in brain and kidneys.
- ii. There is no "safe" level in blood; about 10 mg/dL can be tolerated. More than 10 mg/dL in children and more than 25 mg/dL in adults leads to toxic manifestations.
- iii. Lead can pass through placenta and milk. **Miscarriage**, stillbirth, and premature birth are reported in lead poisoning of mothers.
- iv. Developing brains are more susceptible to lead. Permanent **neurological** sequelae, cerebral palsy and optic atrophy may be seen.
- v. In children, **mental retardation**, learning disabilities, behavioral problems, hyperexcitability and seizures are seen. Even 10  $\mu\text{g}/\text{dL}$  of lead in blood for a long time will reduce IQ to 8 points.
- vi. **Anemia**, abdominal colic and loss of appetite are very common.
- vii. If the blood level is more than 70 mg/dL, **acute toxicity** is manifested, as encephalopathy, convulsions, mania, neuropathy, abdominal colic, severe anemia and kidney damage. Discoloration and blue line along the gums are characteristic features of acute lead poisoning.



viii. Lead inhibits **heme synthesis**. Basophilic stippling of red cells are seen in the peripheral blood and bone marrow smears. This is due to the agglutination of ribosomes. Globin synthesis is adversely affected. Lead particularly inhibits delta aminolevulinic acid (ALA) synthase and ALA-dehydratase (see Chapter 21). Lead also inhibits the enzyme ferrochelatase. Lifespan of RBC is shortened. Anemia enhances lead absorption, lead in turn produces more anemia; thus a vicious cycle is operating. Lead will inhibit absorption of iron and calcium. 1 molecule of lead will inhibit absorption of 1000 molecules of calcium.

### Treatment of Lead Poisoning

Calcium dodecyl edetate (Calcium disodium versenate), penicillamine and dimercaprol (BAL) are used as **antidotes**. Dimercaptosuccinic acid is a better but costly antidote.

### Mercury Poisoning

It is the most common industrial poison. The source for poisoning may be elemental, inorganic or organic mercury.

#### Elemental Mercury

Hazard may come from inhalation of mercury vapor from broken thermometers, sphygmomanometers or from dental amalgam. In acute poisoning, pulmonary edema and encephalopathy may result.

A classical triad of (a) oral lesions (gingivitis, salivation and stomatitis), (b) tremor and (c) psychological changes (insomnia, shyness, emotional instability, memory loss) are the hallmark of chronic elemental mercury poisoning. This is called **erethism**.

#### Inorganic Mercury

Poisoning may arise from calomel (cathartic), topical medicines and in plastic industry. Acute effects include gingivitis, gastritis, vomiting and pulmonary edema. In chronic cases, erethism, especially the neuropsychiatric manifestations predominate.

#### Organic Mercury

Poisoning may occur from paints, fungicides and cosmetics. From mercury salt wastes, the bacteria synthesize **methyl mercury** ( $\text{CH}_3\text{-Hg}^+$ ). This then enters into the fish. Eating

of such fish is the most common cause for organic mercury poisoning.

In 1953, in Minamata bay, Japan, industrial effluent caused methyl mercury poisoning, an epidemic lasting for several years. Organic mercury poisoning is thereafter called **Minamata disease**.

The classical triad of methyl mercury exposure is dysarthria, ataxia and visual field constriction. In severe cases, toxic encephalopathy, sensory neuropathy, intention tremor, hearing loss and spasticity may also be seen. Laboratory investigation findings are:

- i. Normal level of mercury in blood is less than 1 mg/dL. When it is increased to 2–5 mg/dL, symptoms of toxicity appear. A level of 15 mg/dL is fatal.
- ii. Urinary excretion of mercury is elevated, especially in chronic poisoning.
- iii. Hair analysis can detect organic mercury compounds. Dimercaprol derivatives, D-penicillamine, and N-acetylcysteine can increase the excretion of mercury and are useful in treatment.

### Aluminum Toxicity

- i. Aluminum is the third most abundant element after oxygen and silicon in the earth's crust. Exposure is from packing and building materials, paint pigments, insulating materials, cosmetics, antacids, and aluminum cooking vessels.
- ii. An average Indian consumes 1–10 mg of aluminium per day, but only part of it is absorbed. Tolerable upper limit of absorption is 1 mg/day. Only up to 100 µg/day can be eliminated through urine. If intake is more than 100 mg/day, toxicity results.
- iii. Aluminum stimulates production of free radicals. It prevents absorption of calcium, phosphorus and iron. It also interferes with heme synthesis.
- iv. Aluminum precipitates Alzheimer precursor proteins and may lead to **Alzheimer's disease**. Aluminum is implicated in degeneration of dendrites. It is also involved in **Parkinson's disease**.
- v. Osteomalacia and microcytic hypochromic anemia are other manifestations of toxicity.

### Arsenic Toxicity

The oxides of arsenic are commonly used as fruit sprays, pesticides, rat poisons, etc. It acts on sulfhydryl enzymes and interferes with cell metabolism. It may also cause

intravascular hemolysis, which leads to hemoglobinuria. The trivalent or pentavalent organic arsenic compounds are less toxic than inorganic compounds. The symptoms are anaphylactic reactions or later development of agranulocytosis, hepatitis, jaundice and encephalitis. The presence of arsenic in hair and nails can be detected even after long intervals after the poisoning has occurred.

## PESTICIDES AND INSECTICIDES

### Dichlorodiphenyltrichloroethane

It is fat soluble and deposited in the adipose tissue. It is not excreted. Thus concentration inside the body goes on increasing. The dichlorodiphenyltrichloroethane (DDT) used in North America as pesticide during 1970s has reached Antarctica and reduced the thickness of shell of eggs of penguins. Even though DDT is banned in many countries, it is still available in India. Many antifungal agents sprayed on fruits are having long-term effects on depressed spermatogenesis and fertility.

### Organophosphorus Compounds

Organophosphorus (ORP) and organocarbamates (ORC) are the common pesticides and organosulfur compounds (dithiocarbamates) are fungicides. Organophosphorus compounds, parathion and malathion are powerful neurotoxic agents. They inhibit **acetylcholinesterase** through phosphorylation of the active center of the enzyme. Hence, acetylcholine accumulates in the nerve endings. Thus, the transfer of nerve impulse across synapses and at the nerve-muscle junction is prevented. Diagnosis depends on the estimation of cholinesterase in serum and RBC. The antidote is atropine sulfate and cholinesterase reactivators (diacetyl monoxime or pralidoxime).

## OCCUPATIONAL AND INDUSTRIAL HAZARDS

### Polychlorobiphenyls

They are widely used in various industries, can mimic thyroid hormones. **Bisphenols** from plastic containers leach out into drinking water. **Vinyl phenols** are dissolved from PVC pipes. These chemicals will lead to decrease in fertility and alteration in behavior.

### Freon and Chlorofluoromethane

$\text{CF}_2\text{Cl}_2$  (CFC) and  $\text{CFCl}_3$  are used in refrigerators and spray-cans. They are photo-dissociated to chlorine atoms. When chlorine reaches upper atmosphere, it destroys the ozone layer that has been protecting the biosphere against excessive radiation, ever since life emerged.

### Methanol

It is the organic solvent widely used in paints and anti-freezes. It may be consumed in place of ethanol as a substitute. Alcohol dehydrogenase converts methanol to **formaldehyde** and then **formic acid**. It is more toxic than ethanol. **Optic neuritis** and blindness is the characteristic toxicity. The treatment is to give large doses of ethanol, which is preferentially oxidized in the body so that formaldehyde generation is reduced.

## AIR POLLUTANTS

The atmosphere contains mostly nitrogen (78.09%) and oxygen (20.94%), carbon dioxide (0.03%), and water vapor. The permissible level of total suspended particles (TSPs) is 230 mg/cu.m.

A chemical other than those conventionally accepted in the composition of clean air is called a **Contaminant**. A contaminant that occurs in the atmosphere in sufficiently high concentrations to cause an adverse effect, is called a **Pollutant**.

The main *natural sources* of pollution are due to volcanic eruption, forest fires, dust storms and air borne particles. In addition to dissolved gases, *suspended particulate matter* like dust and soot, also adds to the contamination of air. They range in size from 1 to 10 microns in diameter.

The major *artificial sources* of pollution arise due to emissions from automobiles, industry and power plants. These are carbon dioxide, **carbon monoxide**, hydrocarbons, oxides of nitrogen, oxides of sulfur and lead.

The poisonous mixture of smoke, fog, air and other chemicals is called smog. The *chemically reducing smog* is derived from the combustion of coal and oil, and contains **sulfur dioxide** ( $\text{SO}_2$ ), sulfur trioxide ( $\text{SO}_3$ ), mixed with soot.  $\text{SO}_2$  and  $\text{SO}_3$  in the presence of atmospheric water vapor, become sulfurous and sulfuric acids, respectively.

This is the precursor of acid rain that may be carried by wind to long distances.

**Chronic respiratory** symptoms are associated with sulfur oxide or particulates in air. Exacerbations of bronchitis were associated with high concentrations of smoke and sulfur oxide. Children living in polluted areas show diminished ventilatory function when compared with their counterparts living in less polluted areas.

**Heart diseases** are also related to pollutants such as ozone, sulfur dioxide, sulfates and cadmium in the air. High level of carbon monoxide decreases ability to concentrate and decreases visual threshold. Inhalation of air borne lead can cause neurological disturbances.

### Industrial Pollution

Dramatic and disastrous episodes of air pollution have been documented in many industrialized centers in the world. An example was the London Fog of 1952, in which approximately 4000 deaths occurred over a period of 2 weeks, following 5 days of severe cold and dense fog. Another such event was the **Bhopal gas tragedy** in December 1984 which claimed thousands of lives due to methyl isocyanate (MIC) poisoning.

### Passive Cigarette Smoking

The particulate load in a household is directly proportional to the number of cigarette smokers living at home. Increased prevalence of respiratory illnesses and reduced levels of pulmonary function measurements have been found in children of smoking parents. Studies have also

concluded that lung cancer risk is higher in nonsmokers, who live under the same roof with smokers.

### Other Obnoxious Indoor Agents

Common industrial pollutants and their effects are listed in Table 42.1.

### Toxic Substances in Foodstuffs

These may be considered under the following headings

1. Toxins normally present in plants
2. Contamination occurring during cultivation
3. Products of post-harvest period
4. Chemical contaminants during food processing
5. Food adulterants
6. Toxins entering during or after cooking.

#### Toxins Normally Present in Plants

- i. **Protease inhibitors:** Many legumes (soybean, field bean, peanut), cereals (corn) and tubers (potato, sweet potato) contain trypsin inhibitors. They are destroyed by cooking. But partially cooked food may have this activity, inhibiting digestion and absorption of amino acids.
- ii. **Goitrogens:** They prevent iodine uptake or utilization by thyroid gland. Thio-oxazolidone is present in cabbage, radish, turnip and brussel sprouts. Thiocyanates and isothiocyanates are seen in mustard

**TABLE 42.1:** Common industrial pollutants

Agents	Causative industry	Acute manifestation	Chronic manifestation
Acid fumes (H <sub>2</sub> SO <sub>4</sub> , HNO <sub>3</sub> )	Fertilizers, chlorinated organic compounds, dyes, explosives, plastics	Mucous membrane irritation followed by chemical pneumonitis	Chronic bronchitis
Cyanides	Electroplating, extraction of gold or silver, manufacture of fumigants	Increased respiratory rate; respiratory arrest; lactic acidosis	No data
Formaldehyde	Resins, rubber; laboratory works; urethane foam	Same as for acid fumes	Cancers in animals; no data in humans
Halides (Cl, Br, F)	Bleaching in pulp, paper textile industry; synthetic rubber, plastics	Mucous membrane irritation, pulmonary edema	Bronchitis, epistaxis, dental fluorosis
Isocyanates	Polyurethane foams, plastics, adhesives, surface coatings	Mucous membrane irritation, dyspnea, pulmonary edema	Upper respiratory tract irritation, cough, asthma
Nitrogen dioxide	Metal etching, explosives, welding, byproduct of burning fossil fuels	Cough, dyspnea, pulmonary edema, bronchiolitis obliterans	Emphysema, chronic bronchitis
Sulfur dioxide	Coating of nonferrous metals, food processing, burning of fossil fuels	Mucous membrane irritant, epistaxis	Asthma, chronic bronchitis

and other oilseeds. Polyphenolic glycosides are present in the red skins of groundnut and almonds. All these compounds have goitrogenic effect.

- iii. **Antivitamins:** Orange peel, used in making orange marmalade, contains citral, which inhibits vitamin A activity. Linseed oil, which contains linetin, interferes with pyridoxine utilization. Black berries and red cabbage contain thiaminase, which destroys vitamin B<sub>1</sub>. Raw eggs containing avidin can decrease available biotin.
- iv. **Cyanogenic glycosides:** Cereals (sorghum), legumes (lima beans) and tubers (tapioca or cassava) contain cyanogenic compounds, which on hydrolysis produce hydrocyanic acid. Hence, they are highly toxic when taken raw. Cattle and sheep eating tapioca leaves often get acute fatty degeneration of liver with fatal outcome. The toxins can be removed by cooking and decanting the supernatant water.
- v. **Favism:** Ingestion of uncooked broad bean (*vicia fava*) may cause **hemolytic anemia** in susceptible persons with glucose-6-phosphate dehydrogenase (GPD) deficiency (see Chapter 23). The toxic glycoside is known as vicin. Cooking and decanting will remove the toxins.
- vi. **Alkaloids:** Some mushrooms contain poisonous alkaloids. In small quantities, they produce nausea, vomiting, diarrhea, etc. In large quantities, it may produce acute necrosis of liver and death may result.
- vii. **Pressor amines:** They increase the blood pressure. Histamine, tyramine, tryptamine, serotonin and epinephrine are present in good quantities in plantains, banana and cheese. Tyramine is present in cheese, wine and beer. Usually, these are detoxified by monoamine oxidase (MAO) enzyme. But in persons taking MAO-inhibitors, their consumption may produce hypertension and headache.

### Contamination Occurring During Cultivation

This is due to pesticides and insecticides. These toxins could be removed by repeated washing and by peeling of outer layers of vegetables and fruits.

### Storage Contamination

- i. **Fungal infections:** During postharvest storage, contamination with fungus is very common. *Aspergillus*

*flavus* produces **aflatoxins**, which are hepatotoxic and carcinogenic (see Chapter 57). The fungus grows in moist conditions in groundnut, coconut, rice, maize, wheat, etc. Maximum permissible limit of aflatoxin contamination is 0.05 ppm.

- ii. **Ergot (*Claviceps purpurea*):** It is the fungus that usually grows in moist food grains (rye, millet, wheat, barley, bajra). Ergotamine, ergotoxin and ergometrin are present in this fungus (Ergometrin is clinically used to prevent postpartum hemorrhage). The toxins may produce peripheral vascular contraction, causing painful cramps, gangrene in extremities and convulsions. The disease is called **ergotism**.

## Contamination During Food Processing

**Mineral oils:** Petroleum products are used to extract oil from seeds. These solvent residues may remain in the extracted oil. Mineral oils have hepatotoxic and carcinogenic properties.

## Adulterants

- i. **Lathyrism:** It is characterized by paralysis of lower limbs. It is seen in persons consuming large quantities of *Lathyrus sativus* (**Khesari dal**). Khesari dal is widely used to adulterate ordinary dal, and hence the disease may be seen sporadically all over India.

**Neurotoxins** present in lathyrus cause damage of upper motor neurons. There is exaggerated knee jerk, ankle clonus, scissor gait and spastic paralysis. The toxic principle from *lathyrus sativus* is identified as **beta oxalyl amino alanine** (BOAA), having the structure



BOAA also inhibits lysyl oxidase, resulting in reduced cross-linking in collagen. Thorough cooking and decanting the supernatant two or three times will remove these toxins (leaching out the toxin by hot water). Ironically, the protein content in khesari dal is of very good quality.

- ii. **Argemone oil:** Mustard oil may be adulterated with argemone oil. This is from a wild plant, *Argemone mexicana*. Argemone seeds are similar to mustard seeds, and oil from both seeds are similar in consistency. Hence, adulteration is easy. Argemone



oil contains the alkaloid, Sanguinarine which causes vomiting, diarrhea, congestive cardiac failure and edema. It is then called **epidemic dropsy**.

## Toxins Entering During Food Preparation

**Mono sodium glutamate (Ajinomoto):** It is a common food additive. Packets of mono sodium glutamate carry the statutory warning that it is unsuitable for children below the age of 5. It produces transient symptoms like numbness and palpitation. It may deteriorate mental alertness in children.

## Related Topics

Ethanol metabolism (see Chapter 11); Carbon monoxide (see Chapter 22); Detoxification and xenobiotics (see Chapter 41); Free radicals (see Chapter 33); Environmental and chemical carcinogens (see Chapter 57).

## Clinical Case Study 42.1

A 3-year-old girl was brought to the emergency department. She was cold and clammy and was breathing rapidly. She was obviously confused and lethargic. Her mother had indicated that she had accidentally ingested automobile antifreeze while playing in the garage. Following GI lavage and activated charcoal administration, a nasogastric tube for ethanol was administered. What is the likely cause?

## Clinical Case Study 42.1 Answer

This is a case of ethylene glycol poisoning. Ethylene glycol is the major ingredient of radiator fluid products. It is used to increase boiling point and decrease freezing point of radiator fluid. Thus, overheating and freezing of the fluid is reduced, depending upon season.

Ethylene glycol is sequentially converted to glycoaldehyde, glycolate, glyoxylic acid and finally to oxalate. Glycolate can produce acidosis and hyperventilation. Calcium oxalate crystals can form and accumulate in blood and other tissues and hypocalcemia can occur. Thus, symptoms include severe anion gap metabolic acidosis, tachypnea, confusion, convulsions, and coma, oxalate crystalluria and renal failure.

Laboratory investigations are (1) Ethylene glycol levels in blood, (2) Serum osmolality, (3) Serum electrolytes, (4) Serum calcium, (5) Arterial blood gas analysis, and (6) Urinalysis for calcium oxalate crystals.

## QUICK LOOK OF CHAPTER 42

1. Cyanide poisoning causes tissue anoxia by chelating the ferric ions of the enzyme cytochrome oxidase. Death is instantaneous.
2. Lead is a cumulative poison. Acute toxicity can cause encephalopathy, convulsion, mania, anemia and renal damage. Blue line along the gums is a characteristic feature of acute lead poisoning.

# SECTION E

---

## Molecular Biology

- Chapter 43 Nucleotides: Chemistry and Metabolism
- Chapter 44 Deoxyribonucleic Acid: Structure and Replication
- Chapter 45 Transcription
- Chapter 46 Genetic Code and Translation
- Chapter 47 Control of Gene Expression
- Chapter 48 Recombinant DNA Technology and Gene Therapy
- Chapter 49 Molecular Diagnostics and Genetic Techniques



# CHAPTER 43

## Nucleotides: Chemistry and Metabolism

### Chapter at a Glance

The reader will be able to answer questions on the following topics:

- Purines and pyrimidines
- Nucleosides and nucleotides
- De novo synthesis of purine nucleotides
- Degradation of purine nucleotides
- Uric acid and gout
- De novo synthesis of pyrimidines
- Disorders of pyrimidine metabolism

In 1868, Friederich Miescher isolated nucleic acid (then called nuclein) from pus cells. Albrecht Kossel (Nobel prize, 1910) differentiated RNA and DNA in 1882. In 1906, Kossel described the 4 bases in nucleic acids.

Nucleotides are precursors of the nucleic acids, deoxy-ribonucleic acid (DNA) and ribonucleic acid (RNA). The nucleic acids are concerned with the storage and transfer of genetic information. The universal currency of energy, namely ATP, is a nucleotide derivative. Nucleotides are also components of important co-enzymes like NAD<sup>+</sup> and FAD, and metabolic regulators such as cAMP and cGMP.

### Composition of Nucleotides

A nucleotide is made up of 3 components:

- Nitrogenous base* (a purine or a pyrimidine)
- Pentose sugar*, either ribose or deoxyribose
- Phosphate groups* esterified to the sugar.

When a base combines with a pentose sugar, a **nucleo-**  
**side** is formed.

When the nucleoside is esterified to a phosphate group, it is called a **nucleotide** or nucleoside monophosphate. When a second phosphate gets esterified to the existing phosphate group, a nucleoside diphosphate is generated. The attachment of a 3rd phosphate group results in the formation of a nucleoside triphosphate. The nucleic acids (DNA and RNA) are polymers of nucleoside monophosphates.



Friederich  
Miescher  
1844–1895



Albrecht Kossel  
NP 1910  
1853–1927



Adolph  
Strecker  
1822–1871



Frederick Hopkins  
NP 1929  
1861–1947



## Bases Present in the Nucleic Acids

Two types of nitrogenous bases; the purines and pyrimidines are present in nucleic acids.

### Purine Bases

The purine bases present in RNA and DNA are the same; **adenine** and **guanine**. Adenine is 6-amino purine and guanine is 2-amino, 6-oxopurine. The numbering of the purine ring with the structure of adenine and guanine are shown in Figure 43.1.

### Minor Purine Bases

These bases may be found in small amounts in nucleic acids and hence called minor bases. These are **hypoxanthine** (6-oxopurine) and **xanthine** (2, 6-di-oxopurine) (Fig. 43.2). **Uric acid** (2,6,8-tri-oxopurine) is formed as the end product of the catabolism of other purine bases. It can exist in the "enol" as well as "keto" forms (tautomeric forms) (Fig. 43.2). Keto form is by far the predominant type under physiological conditions.

### Pyrimidine Bases

The pyrimidine bases present in nucleic acids are cytosine, thymine and uracil. **Cytosine** is present in both DNA and

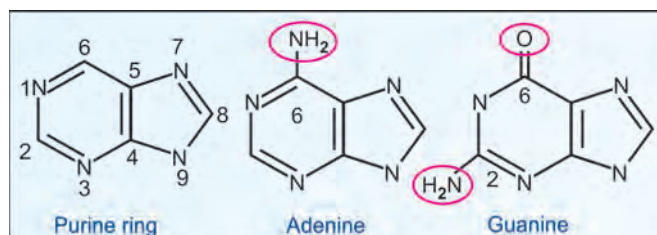


Fig. 43.1: Structure of purines

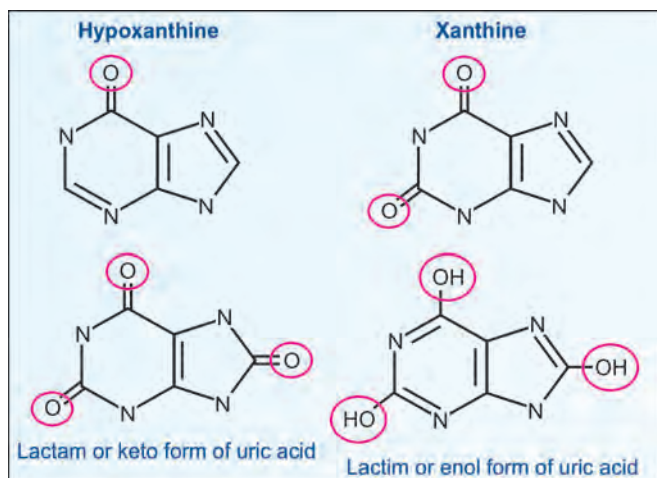


Fig. 43.2: Minor bases seen in nucleic acids

RNA. **Thymine** is present in DNA and **uracil** in RNA. Structures are shown in Figure 43.3. See also Box 43.1.

A few other modified pyrimidine bases like dihydro-uracil and 5-methyl cytosine are also found rarely in some types of RNA (Fig. 43.4).

## Nucleosides

- Nucleosides are formed when bases are attached to the pentose sugar, D-ribose or 2-deoxy-D-ribose (Fig. 43.5).
- All the bases are attached to the corresponding pentose sugar by a beta-N-glycosidic bond between the 1st carbon of the pentose sugar and N9 of a purine or N1 of a pyrimidine.
- The deoxy nucleosides are denoted by adding the prefix *d-* before the nucleoside.
- The carbon atoms of the pentose sugar are denoted by using a prime number to avoid confusion with the carbon atoms of the purine or pyrimidine ring (Fig. 43.6).

### Box 43.1: These two words are often confused

**THYMINE** is the base present in DNA.

**THIAMINE** is a member of vitamin B complex.

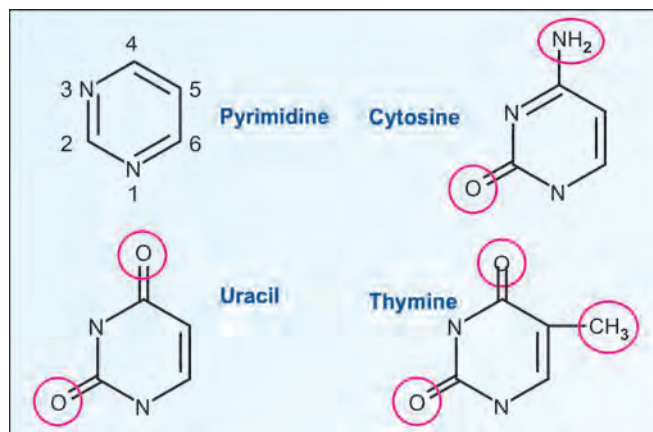


Fig. 43.3: Common pyrimidines

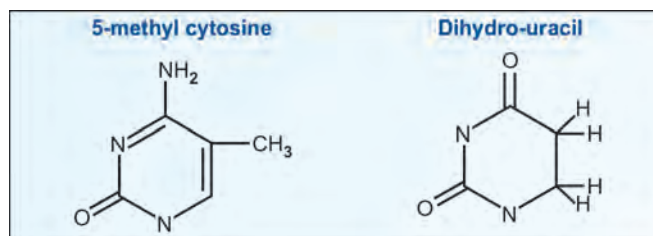


Fig. 43.4: Modified pyrimidine bases

The names of the different nucleosides are given in Table 43.1.

- v. Nucleosides with purine bases have the suffix **-sine**, while pyrimidine nucleosides end with **-dine**.
- vi. *Uracil combines with ribose only; and thymine with deoxy ribose only* (Table 43.1).

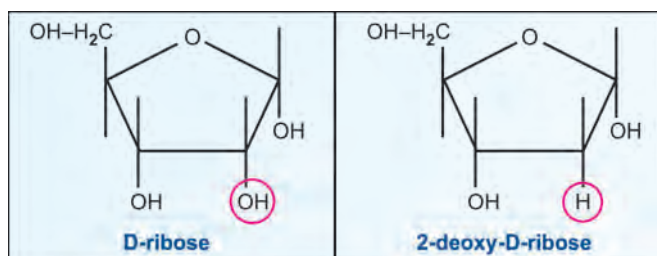


Fig. 43.5: Sugar groups in nucleic acids

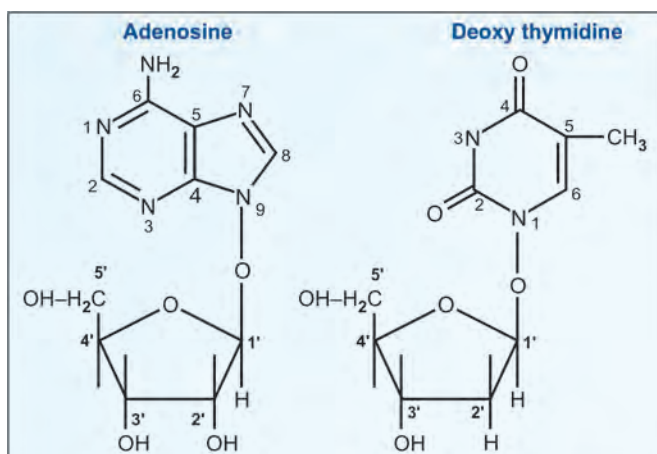


Fig. 43.6: Numbering in base and sugar groups. Atoms in sugar is denoted with primed numbers

TABLE 43.1: Base + sugar are nucleosides

Ribonucleosides		
Adenine + Ribose	→	Adenosine
Guanine + Ribose	→	Guanosine
Uracil + Ribose	→	Uridine
Cytosine + Ribose	→	Cytidine
Hypoxanthine + Ribose	→	Inosine
Xanthine + Ribose	→	Xanthosine
Deoxyribonucleosides		
Adenine + Deoxy ribose	→	Deoxy adenosine (d-adenosine)
Guanine + Deoxy ribose	→	d-guanosine
Cytosine + Deoxy ribose	→	d-cytidine
Thymine + Deoxy ribose	→	d-thymidine

## Nucleotides

- i. These are phosphate esters of nucleosides. Base plus pentose sugar plus phosphoric acid is a nucleotide.
- ii. The esterification occurs at the 5th or 3rd hydroxyl group of the pentose sugar. Most of the nucleoside phosphates involved in biological function are 5'-phosphates (Table 43.2).
- iii. Since 5'-nucleotides are more often seen, they are simply written without any prefix. For example, 5'-AMP is abbreviated as AMP; but 3' variety is always written as 3'-AMP.
- iv. Moreover, a base can combine with either ribose or deoxy ribose, which in turn can be phosphorylated at 3' or 5' positions. One purine and one pyrimidine derivative are given as examples in Table 43.3.

TABLE 43.2: Base + sugar + phosphate = nucleotide

Ribonucleotides		
Adenosine	+ Pi	→ Adenosine monophosphate (AMP) (Adenylic acid)
Guanosine	+ Pi	→ Guanosine monophosphate (GMP) (Guanylic acid)
Cytidine	+ Pi	→ Cytidine monophosphate (CMP) (Cytidylic acid)
Uridine	+ Pi	→ Uridine monophosphate (UMP) (Uridylic acid)
Inosine	+ Pi	→ Inosine monophosphate (IMP) (Inosinic acid)
Deoxyribonucleotides		
d-adenosine	+ Pi	→ d-AMP (d-adenylic acid)
d-guanosine	+ Pi	→ d-GMP (d-guanylic acid)
d-cytidine	+ Pi	→ d-CMP (d-cytidylic acid)
d-thymidine	+ Pi	→ d-TMP (d-thymidylic acid)

TABLE 43.3: Nucleosides and nucleotides

Base	Sugar	Nucleoside	Phosphoric acid at	Nucleotide
Adenine	ribose	adenosine	5' position	AMP
do	do	do	3' position	3'-AMP
do	deoxy-ribose	d-adenosine	5' position	d-AMP
do	do	do	3' position	d-3'-AMP
Cytosine	ribose	cytidine	5' position	CMP
do	do	do	3' position	3'-CMP
do	deoxy-ribose	d-cytidine	5' position	d-CMP
do	do	do	3' position	d-3'-CMP

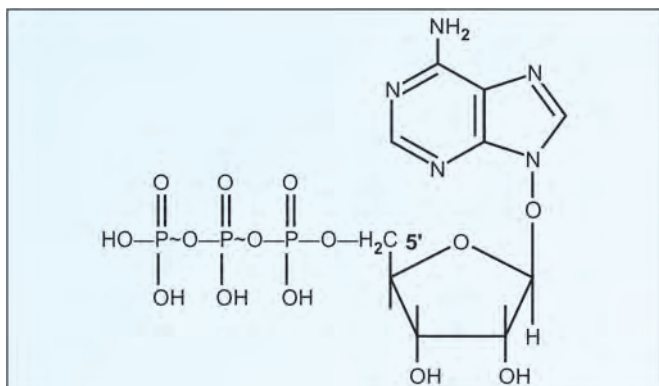
- v. Many co-enzymes are derivatives of adenosine monophosphate. Examples are  $\text{NAD}^+$ , NADP, FAD and Co-enzyme A.
- vi. Nucleotides and nucleic acids absorb light at a wavelength of 260 nm; this aspect is used to quantitate them. As nucleic acids absorb ultraviolet light, chemical modifications are produced leading to mutation and carcinogenesis.

## Nucleoside Triphosphates

- i. Corresponding nucleoside di- and tri- phosphates are formed by esterification of further phosphate groups to the existing ones. In general, any nucleoside triphosphate is abbreviated as NTP or d-NTP (Table 43.4).
- ii. Nucleoside diphosphate contains one high energy bond and triphosphates have 2 high energy bonds. ATP is the **universal energy currency** (Fig. 43.7).

**TABLE 43.4: Nucleoside triphosphates**

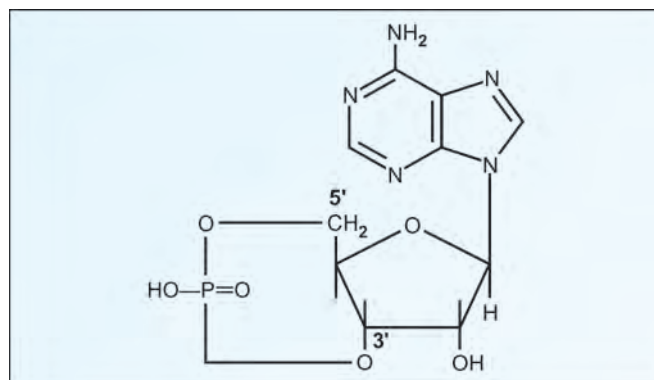
Nucleoside	Nucleoside monophosphate	Nucleoside diphosphate (NDP)	Nucleoside triphosphate (NTP)
<b>Ribonucleoside phosphates</b>			
Adenosine	Adenosine monophosphate (AMP)	Adenosine diphosphate (ADP)	Adenosine triphosphate (ATP)
Guanosine	GMP	GDP	GTP
Inosine	IMP	IDP	ITP
Cytidine	CMP	CDP	CTP
Uridine	UMP	UDP	UTP
<b>Deoxyribonucleoside phosphates</b>			
d-adenosine	d-AMP	d-ADP	d-ATP
d-guanosine	d-GMP	d-GDP	d-GTP
d-cytidine	d-CMP	d-CDP	d-CTP
d-thymidine	d-TMP	d-TDP	d-TTP



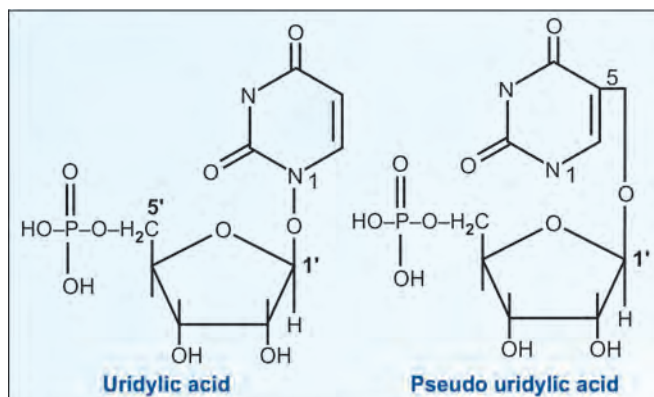
**Fig. 43.7:** Adenosine triphosphate (ATP)

It is formed during oxidative processes by trapping the released energy in the high energy phosphate bond. More details on high energy bonds are given in Chapter 20.

- iii. A phosphodiester linkage may be formed between the 3' and 5' positions of ribose group. Such compounds are called cyclic nucleotides (Fig. 43.8). 3', 5'-**cyclic AMP** or **cAMP** is a major metabolic regulator. Cyclic GMP also behaves similarly. These are second messengers in mediating the action of several hormones.
- iv. Deoxy ribonucleotides are used for synthesis of DNA and ribonucleotides for RNA. In pseudouridylic acid (found in tRNA) uridine is attached to ribose phosphate in a C-C bond instead of C-N bond in UMP (Fig. 43.9).
- v. High energy compounds are listed in Table 20.2. Please note that active methionine, amino acid adenylates, active sulfate, etc. are higher energy compounds containing adenosine monophosphate.



**Fig. 43.8:** 3',5'-cyclic AMP or cAMP



**Fig. 43.9:** Different attachment of uracil to sugars

## Digestion of Nucleic Acids

The nucleic acids in the diet are hydrolyzed to a mixture of nucleotides by ribonuclease and deoxyribonuclease present in pancreatic and intestinal secretions. Then nucleotidases liberate the phosphate from nucleotides. The resulting nucleosides are hydrolyzed by nucleotidases forming free bases and pentose sugars.

However, the dietary purines and pyrimidines are neither converted to nucleotides nor incorporated into nucleic acids. They are directly catabolized.

## BIOSYNTHESIS OF PURINE NUCLEOTIDES

- The purine nucleotides are synthesized by most of the tissues. However the major site is the liver. This pathway operates in the cytoplasm.
- The major pathway is denoted as **de novo synthesis**, because the purine ring is synthesized from different small components. Since the human being can synthesize the purine and pyrimidine bases de novo, they are said to be prototrophs.
- The contribution of different atoms from different sources for the formation of the purine ring is shown in the Figure 43.10.

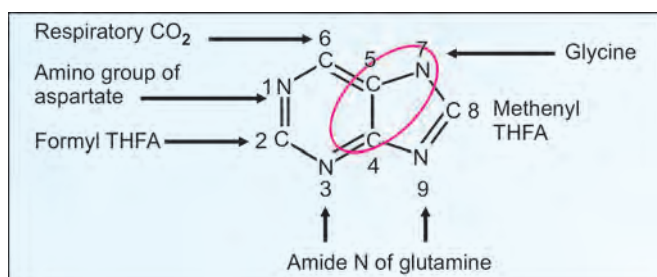


Fig. 43.10: The assembly of purine ring is from various sources. THFA (FH4) = tetrahydrofolic acid

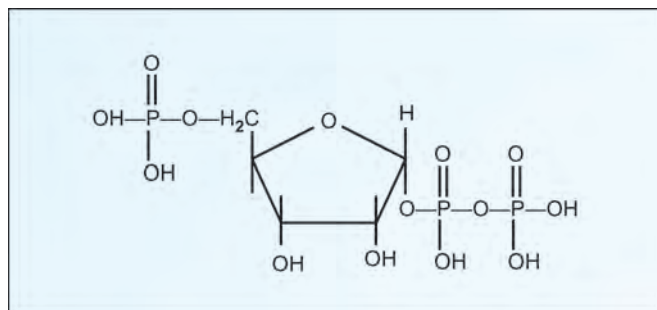


Fig. 43.11: Phosphoribosyl pyrophosphate

iv. During de novo synthesis, *purine ring is built up on a ribose-5-phosphate molecule*. Hence, nucleotides are the products of the de novo synthesis.

v. There are ten steps in the de novo synthesis pathway. The enzymes catalyzing these reactions are existing as a multienzyme complex in eukaryotic cells; this arrangement increases the efficiency of the pathway.

The names of the enzymes catalyzing the purine synthesis steps are as follows (Figs 43.12 and 43.13). Enzyme 1 = Phosphoribosyl amido transferase; Enzyme 2 = GAR synthetase; Enzyme 3 = GAR transformylase; Enzyme 4 = FGAR amido transferase; Enzyme 5 = Cyclase; Enzyme 6 = AIR-carboxylase; Enzyme 7 = SAICAR synthetase; Enzyme 8 = SAICAR lyase; Enzyme 9 = AICAR transformylase; Enzyme 10 = IMP synthase; Enzyme 11 = Adenylosuccinate synthetase and adenylosuccinase.

### Step 0 (Preparatory Step), PRPP synthesis

i. Phosphoribosyl pyrophosphate (PRPP) is the donor of ribose-5-phosphate for de novo synthesis. The reaction is:



The structure of PRPP is shown in Figure 43.11.

- The purine ring is later on assembled on the ribose-5-phosphate.
- PRPP is also used for the synthesis of pyrimidine nucleotides, nucleotide co-enzymes and also for the salvage pathway. Hence the synthesis of PRPP is not considered as a step in the de novo synthesis of purine nucleotides; it is called a preliminary or preparatory step.

### Formation of AMP

Steps 1 to 10 are summarized in Table 43.5. Flow diagrams of these steps are shown in Figures 43.12 and 43.13. The de novo synthesis of one molecule of purine nucleotide requires 6 ATP.

TABLE 43.5: Summary of steps of purine synthesis

Step	Donor	Added atom	Product
1	Glutamine	N9 (Rate limiting)	PRA
2	Glycine	C4,5,N7 (ATP required)	GAR
3	Methenyl-THFA	C 8	FGAR
4	Glutamine	N3 (ATP required)	FGAM
5	–	Ring closure (ATP)	AIR
6	Carbondioxide	C 6	ACAIR
7	Aspartic acid	N1 (ATP required)	SAICAR
8	–	Fumarate removed	AICAR
9	Formyl-THFA	C 2	FAICAR
10	–	Ring closure	IMP



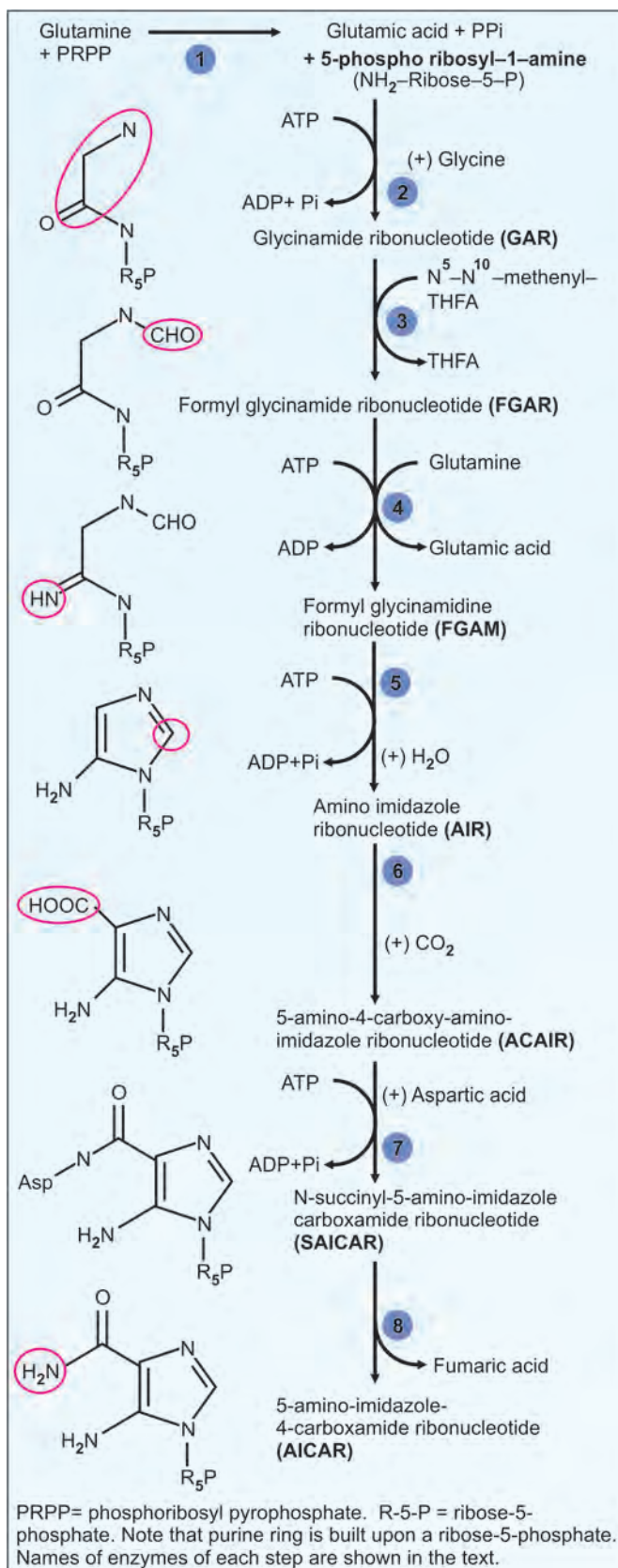


Fig. 43.12: First eight steps of purine synthesis

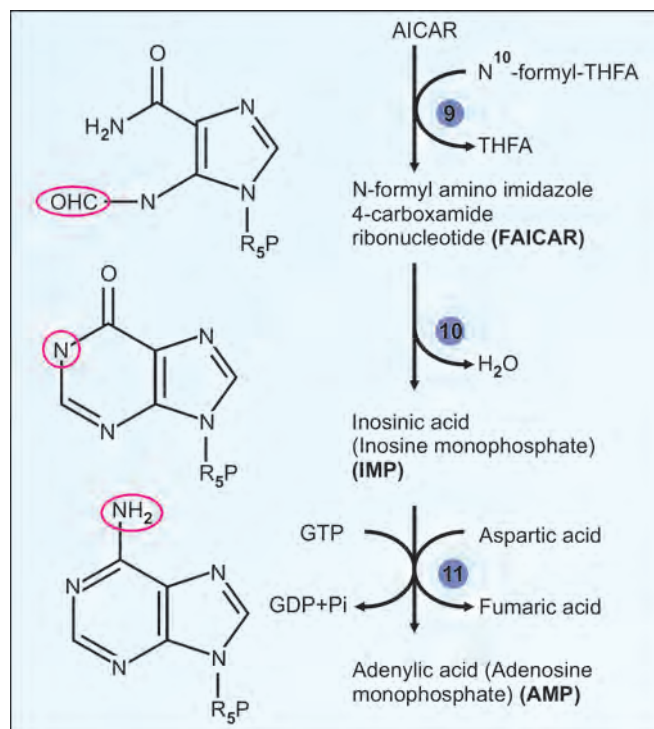


Fig. 43.13: Last steps in purine synthesis

First step is rate limiting. Step 4 is inhibited by **azaserine**, an anticancer drug. **6-mercaptopurine** inhibits amination of IMP to AMP, and therefore it is used as an **anticancer drug**.

### Conversion of IMP to GMP

The conversion of IMP to GMP involves two steps, first oxidation of IMP to xanthylic acid (xanthosine monophosphate) (XMP) by an  $\text{NAD}^+$  dependent dehydrogenase. Then an amido transferase transfers the  $\text{NH}_2$  group from glutamine to XMP to form GMP. ATP is hydrolyzed to AMP level in this reaction (Fig. 43.14). Both AMP and GMP can be converted to their di- and triphosphates. *Synthesis of one molecule of purine nucleotide requires 6 high energy phosphates.*

### Salvage Pathway

- This pathway ensures the recycling of purines formed by degradation of nucleotides. Nucleosides and deoxy-nucleosides can also be salvaged.
- PRPP is the starting material in this pathway; it is also a substrate for de novo synthesis. Hence these two pathways are closely inter-related.
- The free purines are salvaged by two different enzymes; adenine phosphoribosyl transferase (**APRTase**) and hypoxanthine guanine phosphoribosyl transferase (**HGPRTase**).
- The pathway is of special importance in tissues like RBCs and brain where the de novo pathway

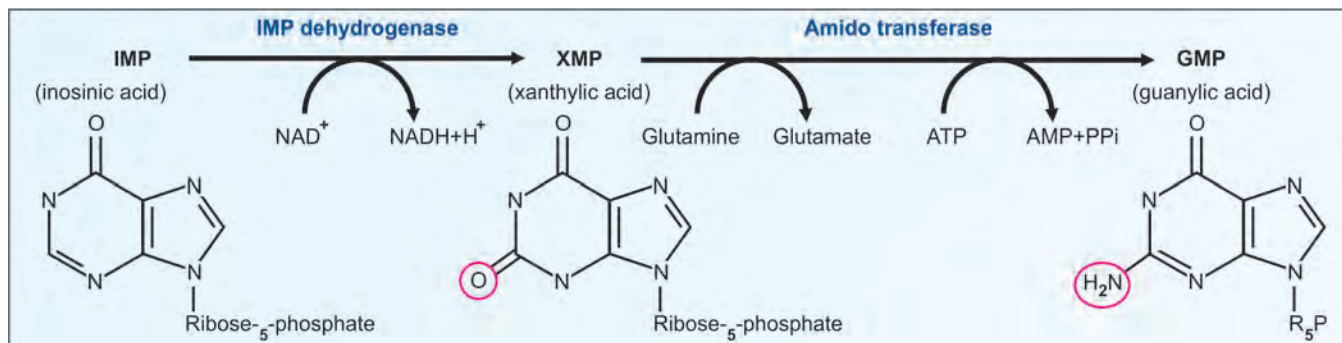
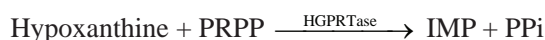
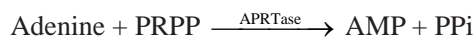


Fig. 43.14: Conversion of IMP to GMP. R-5-P = ribose-5-phosphate

is not operating. The salvage pathway economize intracellular energy expenditure.

- v. Absence of enzymes of salvage pathway produces specific clinical syndromes. Salvage pathway is summarized below:



## Regulation of Purine Synthesis

- i. The committed step in de novo synthesis is the reaction catalyzed by amido-transferase (step 1). It is inhibited by AMP and GMP.
- ii. They act as allosteric modifiers. Binding of AMP and GMP on the enzyme converts monomeric active form to a dimeric inactive form.
- iii. Since both AMP and GMP can bind to the same enzyme molecule at different sites, they act synergistically.
- iv. Both AMP and GMP inhibit their own formation by feedback inhibition of adenylosuccinate synthetase and IMP dehydrogenase.
- v. The formation of AMP from IMP requires GTP; similarly formation of GMP requires ATP. Hence both GTP and ATP are made available in sufficient quantities.
- vi. The availability of PRPP is another important regulatory factor. The activity of PRPP synthetase is regulated by negative modifiers; purine and pyrimidine nucleotides.

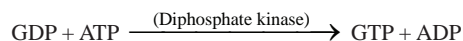
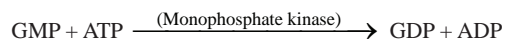
## Analogs as Purine Synthesis Inhibitors

They act as **competitive inhibitors** of the naturally occurring nucleotides. They are utilized to synthesise DNA; such DNA becomes functionally inactive. Thereby cell division is arrested. So they are useful as anticancer drugs. A few examples are:

- a. Mercaptopurine inhibits the conversion of IMP to GMP and AMP.
- b. Folate antagonists (Methotrexate) would affect the reactions involving one carbon group transfers.
- c. Azaserine (diazooacetyl-L-Serine) is a glutamine antagonist and therefore inhibits reactions involving glutamine (steps 1 and 4).
- d. Other synthetic nucleotide analogs used as anticancer agents are 6-thio guanine and 8-aza guanine.

## Purine Nucleoside Di- and Triphosphates

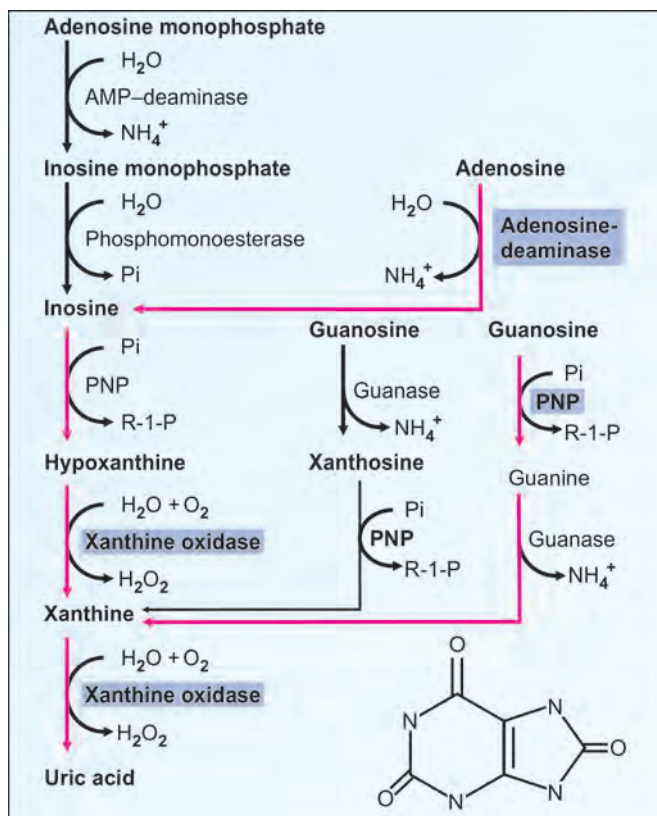
These reactions are catalyzed by specific kinases and phosphate group is donated by ATP. One example is given below.



## Degradation of Purine Nucleotides

The end product of purine nucleotide catabolism is **uric acid** (urate). The structure is shown in Figure 43.2. This degradation is taking place mainly in the liver. The steps are shown in Figure 43.15.

The xanthine oxidase is a metalloflavoprotein containing FAD, **molybdenum** and iron. As xanthine is



**Fig. 43.15:** Degradation of purine nucleotides. Main pathway is in red arrows. PNP = purine nucleoside phosphorylase; R-1-P = ribose-1-phosphate

oxidized to uric acid, the electrons are transferred first to molybdenum, then to FAD, and finally to molecular oxygen, when **hydrogen peroxide** (one of the reactive oxygen species) is produced.

### Species Difference

The end product of purine catabolism in human beings is uric acid. However, the total amount of nitrogen excreted as uric acid is very little, because human beings are **ureotelic**. The amino nitrogen is finally excreted as urea in mammals. The birds, amphibians and reptiles are **uricotelic** because they excrete uric acid as the major end product of purine as well as amino acid catabolism. The lower primates and some other mammals have the enzyme uricase which converts uric acid to allantoin and the final product excreted is allantoin which is more soluble.

### Caffeine

Caffeine is the trimethyl derivative of xanthine. Coffee and tea contains caffeine. It inhibits phosphodiesterase, causes prolonged action of cyclic AMP and increases the activity of hormone sensitive lipase (see Fig. 12.16). Caffeine enhances the effect of epinephrine on glycogenolysis.

## URIC ACID

Strecker in 1857 showed the presence of uric acid in urine. In 1892, Sir Frederick Hopkins (Nobel prize, 1929) estimated uric acid. In 1895, Emil Fischer (Nobel prize, 1902) showed that uric acid is derived from purine nucleus.

**Normal blood level of uric acid ranges from 2–5 mg/dL in females and 3–7 mg/dL in males.** The daily excretion varies from 500–700 mg. Nucleic acid content is more in non-vegetarian diet. Uric acid is sparingly soluble in water. Uric acid is an antioxidant (Box 43.2).

## Disorders of Purine Metabolism

The most common abnormality is an elevation of uric acid level in blood, referred to as **hyperuricemia**. It is defined as serum uric acid concentration exceeding 7 mg/dL in male and 6 mg/dL in female. It may or may not be associated with increased excretion of uric acid in urine, which is called **uricosuria**. The manifestations are due to the low solubility of uric acid in water.

## GOUT

- It is due to accumulation of urate crystals in the synovial fluid resulting in inflammation leading to acute arthritis.
- At 30°C, the solubility of uric acid is lowered to 4.5 mg/dL. Therefore uric acid is deposited in cooler areas of the body to cause **tophi**. Thus tophi are seen in distal joints of foot.
- Increased excretion of uric acid may cause deposition of uric acid crystals in the urinary tract leading to **calculi** or stone formation with renal damage. Gout may be either primary or secondary.
- The main metabolic abnormality in patients with gout is an increased cellular pool of PRPP, the substrate for the rate limiting step of de novo synthesis of purine nucleotides. The resultant increase in the activity

### Box 43.2: Uric acid is an antioxidant

Uric acid, the end product of purine catabolism is a strong reducing agent. It can act as a free radical scavenging molecule acting together with thiol groups of proteins. Its role as an antioxidant is particularly significant in the upper respiratory tract. Both hydroxyl and peroxy radicals can be removed. Uric acid has also been found to be mainly responsible for neutralizing oxone level of inspired air. The products of oxidation formed by the antioxidant action of uric acid are excreted. A strong correlation has also been observed with the incidence of coronary vascular disease and uric acid levels.



of amido transferase leads to excess production of nucleotides resulting in hyperuricemia.

## Primary Gout

About 10% of cases of primary gout are idiopathic. Primary gout may show a familial incidence. Incidence of primary gout is about 1:500 in total population. Causes of primary gout are:

### 5-phosphoribosyl Amido Transferase

The abnormal enzyme is active, but not sensitive to feedback regulation by the inhibitory nucleotides. This would lead to over production of purine nucleotides.

### Abnormal PRPP Synthetase

This enzyme is found to have a higher  $V_{max}$  which leads to increased production of PRPP.

### Deficiency of Enzymes of Salvage Pathway

Reactions which consume PRPP and produce more nucleotides will inhibit the enzyme, e.g. salvage pathway. Primary gout is now considered as a disease of the elderly, related to lifestyle.

### Glucose-6-phosphatase Deficiency

This condition is known as von Gierke's disease (glycogen storage disease, type I, see Chapter 10). When this enzyme is deficient, glucose-6-phosphate cannot be converted to glucose. So more glucose is channeled into the pentose-phosphate shunt pathway, resulting in increased availability of ribose-5-phosphate. This would lead to increased formation of PRPP.

## Secondary Hyperuricemia

### Increased Production of Uric Acid

It may be due to enhanced turnover rate of nucleic acids as seen in:

- Rapidly growing malignant tissues, e.g. leukemias, lymphomas, polycythemia.
- Hyperuricemia is also seen in cancer patients on radiotherapy or chemotherapy (tumor lysis syndrome) due to increased cellular turnover. Hence these patients are given allopurinol also, to decrease uric acid levels. Rasburicase (urate oxidase) is also found to be effective in these cases.

- Increased tissue damage due to trauma and raised rate of catabolism as in starvation.

### Reduced Excretion Rate

- Renal failure
- Treatment with thiazide diuretics which inhibit tubular secretion of uric acid
- Lactic acidosis and keto-acidosis due to interference with tubular secretion.

## Clinical Findings of Gout

Galen has described the classical image of the gouty subjects as the red faced, good living, hard drinking, country squire. Many geniuses, including Isaac Newton, Gibbon and Johnson were suffering from gout.

Gouty attacks may be precipitated by high purine diet and increased intake of **alcohol**. Often the patients have a few drinks, go to sleep symptomless, but are awakened during the early hours of morning by excruciating joint pains. Alcohol leads to accumulation of lactic acid.

The typical gouty **arthritis** affects the first metatarsophalangeal joint (big toe), but other joints may also be affected. The joints are extremely painful. Synovial fluid will show birefringent urate crystals (Fig. 43.16A).

In **chronic cases**, uric acid may get deposited around joints causing swelling (**tophi**) composed of sodium urate.

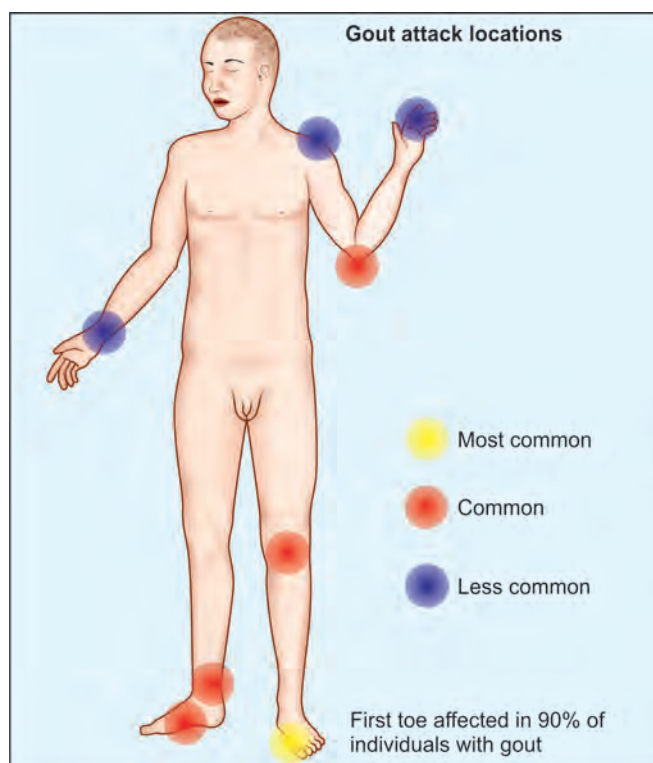


Fig. 43.16A: Location of gout attack



The total urate pool (normal 1200 mg) is increased to 3000 mg in gout patients without tophi. It may be as high as 30,000 mg in patients with tophi.

In chronic gout, the deposition of urate crystals in renal medulla occurs which progresses to urolithiasis and renal damage.

## Treatment Policies in Gout

- Reduce dietary purine intake and restrict alcohol.
- Increase renal excretion of urate by **uricosuric drugs**, which decrease the reabsorption of uric acid from kidney tubules, e.g. probenecid.
- Reduce urate production by **allopurinol**, an analog of hypoxanthine (Fig. 43.16B). Allopurinol is a **competitive** inhibitor of xanthine oxidase thereby decreasing the formation of uric acid. Xanthine and hypoxanthine are more soluble and so are excreted more easily. Xanthine oxidase converts allopurinol to alloxanthine. It is a more effective inhibitor of xanthine oxidase. This is a good example of '**suicide inhibition**' (see Chapter 5). Allopurinol was synthesized by Elion and Hitchings independently (Nobel prize, 1988).
- Colchicine**, an anti-inflammatory agent is very useful to arrest the arthritis in gout (Fig. 43.16C).
- Use of PEG (polyethylene glycol)-uricase and conversion of uric acid to allantoin (more water soluble and easily excreted) is also being tried as a therapeutic measure to reduce body uric acid pool.

## Lesch-Nyhan Syndrome

It is an **X-linked** inherited disorder of purine metabolism. Different types of mutations in HGPRTase gene have been identified in patients with Lesch Nyhan syndrome. Incidence is 1:10,000 males. There is deficiency of

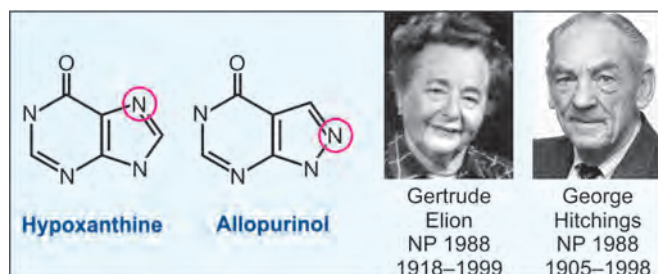


Fig. 43.16B: Allopurinol inhibits, xanthine oxidase; an example of competitive inhibition

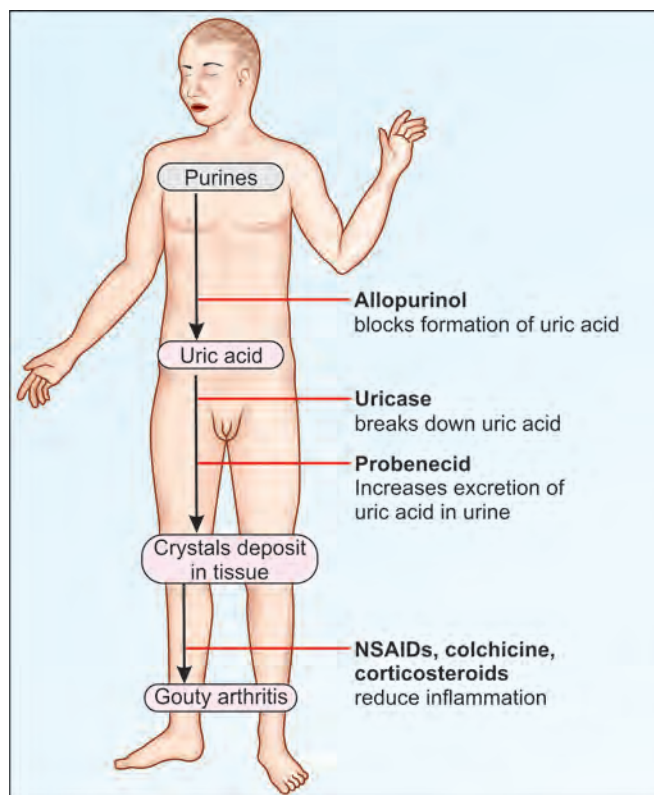


Fig. 43.16C: Action of medicines in gout

**HGPRTase**. So, the rate of salvage pathway is decreased resulting in accumulation of PRPP and decreased level of inhibitory purine nucleotides. The disease is characterized by **self mutilation**, mental retardation, excessive uric acid and nephrolithiasis. Gout develops in later life. The neurological manifestations suggest that the brain is dependent on the salvage pathway for the requirements of IMP and GMP. Allopurinol is used in treatment, but since salvage pathway is deficient, it is effective only to inhibit xanthine oxidase.

## Hypouricemia

### Adenosine Deaminase (ADA) Deficiency

It is associated with severe immunodeficiency where both T and B cells are deficient. It is an inherited autosomal recessive disease. ADA deficiency leads to accumulation of adenosine and dATP; this would inhibit further production of precursors for DNA synthesis especially dCTP. Lymphocytes usually contain high levels of ADA. Therefore, ADA deficiency is mainly manifested as reduced lymphocytes. This leads to impaired cellular and humoral immunity. Hypouricemia is due to defective breakdown of purine nucleotides. Antibiotics and periodic injections of immunoglobulin will be life-saving. Weekly intramuscular injections of bovine ADA were found to be beneficial. Bone marrow stem cells will increase both T and B cells in the patients. The first successful

gene replacement therapy has been tried in ADA deficiency (see Chapter 48). Purine nucleotide phosphorylase deficiency also produces immune deficiency, but only B cell function is affected.

ADA is sometimes used for the rapid diagnosis of tuberculosis. ADA estimation in CSF is used for the diagnosis of tuberculous meningitis. ADA levels can be estimated in various body fluids like blood, CSF, pleural fluid, pericardial fluid, ascitic fluid, etc. The usual cut-off value for CSF is 10.0 U/L and for other fluids is 60.0 U/L. It has very good sensitivity and specificity for the diagnosis of pulmonary as well as extra-pulmonary tuberculosis. Adenosine deaminase (ADA) level in pleural or ascites fluid may be used for diagnosis for extra-pulmonary tuberculosis. A negative test cannot rule out a diagnosis of TB.

### Xanthine Oxidase Deficiency

It is a genetic defect. Characteristic features are hypouricemia, increased excretion of hypoxanthine and xanthine and liver damage.

See Table 43.7 for summary of disorders of purine nucleotides.

## DE NOVO SYNTHESIS OF PYRIMIDINE

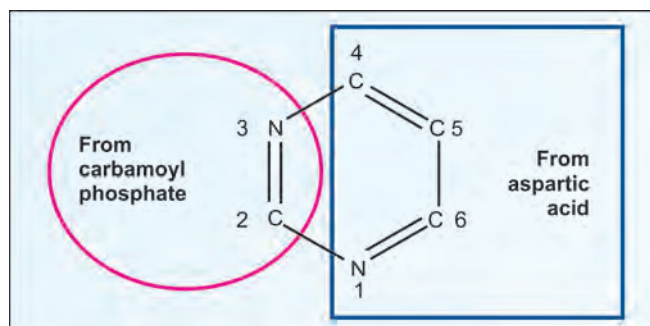
The pyrimidine ring (unlike the purine) is synthesized as free pyrimidine and then it is incorporated into the nucleotide. The origin of atoms of pyrimidine nucleus is indicated in Figure 43.17.

**TABLE 43.6:** Regulation of deoxyribonucleotide formation

Reaction	+ve regulator	Inhibitor
CDP → d-CDP	ATP	dATP, dGTP, dTTP
UDP → d-UDP	ATP	dATP, dGTP
ADP → d-ADP	dGTP	dATP, ATP
GDP → d-GDP	dTTP	dATP

**TABLE 43.7:** Disorders of purine metabolism

Disorder	Defect	Nature of defect
Gout	PRPP synthetase, HGPRT, glucose 6 phosphatase	Hyperuricemia
Lesch Nyhan syndrome	HGPRT	Lack of enzyme
SCID	ADA	Lack of enzyme
Immuno-deficiency	Purine nucleotide phosphorylase	Lack of enzyme
Renal lithiasis	APRT	Dihydroxyadenine, renal lithiasis
Xanthinuria	Xanthine oxidase	hypouricemia, xanthine renal lithiasis
von Gierke disease	Glucose-6-phosphatase	Lack of enzyme



**Fig. 43.17:** Sources of C and N atoms of pyrimidine

### Step 1: Carbamoyl Phosphate Synthesis

The reaction occurs in cytoplasm (in urea synthesis, the reaction is in mitochondria). The nitrogen of glutamine and bicarbonate react to form carbamoyl phosphate (step 1, Fig. 43.18). The enzyme is carbamoyl phosphate synthetase II (CPS II). (The differences between CPS-I and CPS-II are described in Table 15.2).

### Step 2: Rate Limiting Step

Carbamoyl phosphate and aspartate combine to form **carbamoyl aspartate** (step 2, Fig. 43.18). The enzyme is aspartyl trans carbamoylase (ATC), which is allosterically regulated. The atoms C2 and N3 are derived from carbamoyl phosphate and the rest are from aspartate.

### Step 3: Formation of Pyrimidine Ring

The 3rd nitrogen and 4th carbon are joined by a covalent bond and carbamoyl aspartate is cyclized. **Dihydro orotic acid** is produced. The enzyme is dihydro orotase (DHOase) (step 3, Fig. 43.18).

### Step 4: Oxidation

Hydrogen atoms are removed from C5 and C6 positions, so that **orotic acid** is produced (step 4, Fig. 43.18). Enzyme is dihydro orotate dehydrogenase (DHODH). It requires NAD as co-enzyme.

### Step 5: Formation of OMP

Ribose-5-phosphate is added to orotic acid, so as to produce orotidylic acid or orotidine monophosphate (**OMP**). PRPP is the donor of ribose-5-P. The enzyme is orotate phosphoribosyl transferase (OPRTase) (step 5, Fig. 43.18).

### Step 6: Decarboxylation

The C7 of OMP is removed as carbon dioxide, so that uridine monophosphate (**UMP**) is produced (step 6, Fig. 43.18). This is the **first pyrimidine that is synthesized**. The enzyme is OMP-decarboxylase (OMPDC). 6-aza-uridine inhibits this step, and so used as an anticancer drug.

### Step 7: Synthesis of Triphosphates

UMP is phosphorylated to form **UDP** (uridine diphosphate) with the help of ATP (step 7, Fig. 43.18). The enzyme is nucleoside monophosphate

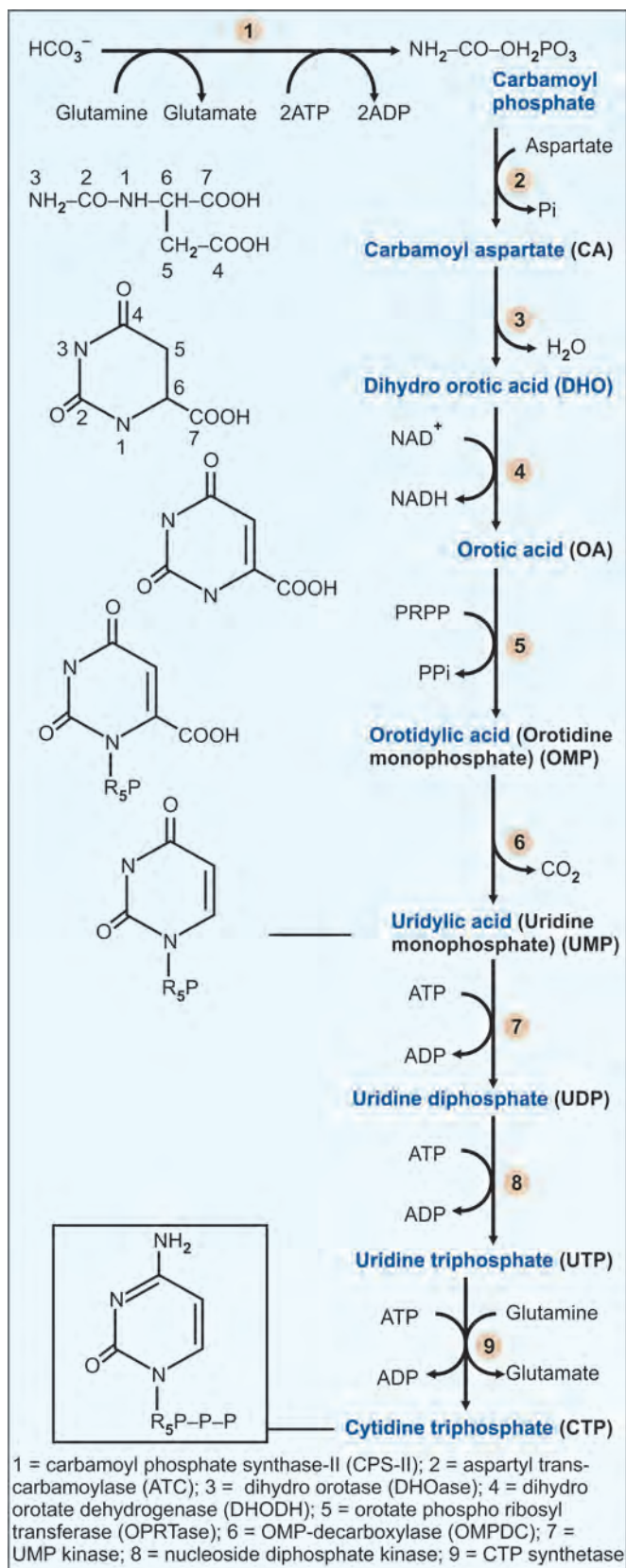


Fig. 43.18: Synthesis of pyrimidine nucleotides

kinase (UMP kinase). Next, the UDP is phosphorylated to **UTP** (uridine triphosphate) with the help of ATP (step 8, Fig. 43.18). The enzyme is nucleoside diphosphate kinase.

### Step 8: Formation of CTP

UTP is converted to **CTP** by adding an amino group from glutamine catalyzed by CTP synthetase. It needs ATP (step 9, Fig. 43.18).

## Regulation of Pyrimidine Synthesis

- In eukaryotes the first 3 enzymes, viz, CPS II, ATC and DHOase are present as a **multi-enzyme complex** and referred to as '**CAD**', taking the first letters of the 3 enzymes.
- The last 2 enzymes, OPRTase and OMP decarboxylase are also present as a single functional complex. Because of this clustering of enzymes, the synthesis is well coordinated. Both complexes are cytosolic.
- The remaining enzyme, dihydro orotate dehydrogenase (step 4) is mitochondrial.
- The major regulatory step in **prokaryotes** is the reaction catalyzed by aspartate transcarbamoylase (ATC) which is allosterically inhibited by CTP.
- In mammalian cells the regulation occurs at the level of **CPS II** (enzyme 1) which is inhibited by UTP are activated by PRPP. Aspartate transcarbamoylase (enzyme 2) is inhibited by UTP, and activated by PRPP.
- Further, OMP decarboxylase is inhibited by UMP. The requirement of ATP for CTP formation and the stimulatory effect of GTP on CTP synthetase ensure a balanced synthesis of purine and pyrimidine nucleotides.
- Pyrimidines can also be **salvaged** like the purines, using PRPP and phosphoribosyl transferase and nucleoside phosphorylase.
- Both gene expression and enzyme activity are regulated. The first 3 and last 2 enzymes are regulated by repression/depression.

## Disorders of Pyrimidine Metabolism Orotic Aciduria

- The condition results from absence of either or both of the enzymes, **OPRTase and OMP decarboxylase**. It is an autosomal recessive disease.
- There is retarded growth and megaloblastic **anemia**. The rapidly growing cells are more affected and hence the anemia. Crystals are excreted in urine which may



cause urinary tract obstruction. Due to lack of feedback inhibition orotic acid production is excessive.

- iii. The condition can be successfully treated by feeding cytidine or uridine. They may be converted to UTP which can act as feedback inhibitor.
- iv. Orotic aciduria may also occur in ornithine transcarbamoylase deficiency (**urea cycle** enzyme) as carbamoyl phosphate accumulates due to defective conversion to citrulline.

- v. **Allopurinol** competes with orotic acid for the enzyme orotate phosphoribosyl transferase (enzyme no. 5 in Fig. 43.18), leading to orotic aciduria and orotidinuria. In metabolic disorders related with nucleotides, it is observed that major clinical consequences result from overproduction and accumulation of nucleotide derivatives in cells. In many cases salvaging and incorporation of abnormal nucleotide derivatives in DNA during replication can lead to clinical sequelae often incompatible with life. Examples are SCID, MNGIE (mitochondrial neurogastrointestinal encephalopathy syndrome), Lesch Nyhan syndrome, etc.

See Table 43.8 for summary of disorders of pyrimidine nucleotides.

### Deoxyribonucleotide Formation

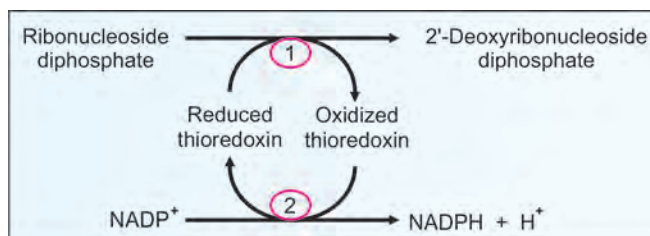
Deoxyribonucleotides (both purines and pyrimidine series) are formed by the reduction at the 2' carbon of the corresponding nucleoside diphosphates (**NDP to dNDP**). The enzyme is **ribonucleotide reductase complex**, which contains non-heme iron. It requires NADPH, **Thioredoxin** and thioredoxin reductase (Fig. 43.19). Thus, UDP is first converted to dUDP, and then to dUTP.

### Combined Regulation of Purine and Pyrimidine Synthesis

Purine and pyrimidines are synthesized in equimolecular quantities. This suggests coordinated control of their biosynthesis. PRPP is the precursor of both purines and pyrimidines; the PRPP synthase is inhibited by both purine and pyrimidine nucleotides. Both series of reactions are closely regulated by allosteric effectors. Binding of a specific NTP to the substrate-specificity site will have positive effect on the reduction of other NTPs (Table 43.6). Since ATP is required for the reduction of both CDP and UDP, the purine to pyrimidine balance is always maintained.

**TABLE 43.8: Disorders of pyrimidine metabolism**

Disorder	Defective Enzyme
Orotic aciduria Type I	OPRTase, OMP decarboxylase
Orotic aciduria Type II	OMP decarboxylase
Orotic aciduria	Ornithine Transcarbamoylase
Drug induced Orotic aciduria	OMP decarboxylase
$\beta$ amino isobutyric aciduria	Transaminase, affects urea cycle function, deamination of $\alpha$ amino acids to $\alpha$ keto acids



**Fig. 43.19:** Formation of 2'-deoxyribonucleoside diphosphates. 1 = Ribonucleotide reductase; 2 = Thioredoxin reductase

### Synthesis of Deoxythymine Nucleotides

The thymine nucleotide is formed by **thymidylate synthase** by methylation of dUMP. The methyl group is donated by  $N^5,N^{10}$ -methylene-THFA. Later, THFA is regenerated by dihydrofolate reductase, using NADPH as the reductant (Fig. 43.20). **Methotrexate** inhibits the enzyme DHF-reductase. So dTMP synthesis is inhibited, in turn DNA synthesis is inhibited.

### Anticancer Agents Acting on Pyrimidines

**Methotrexate** inhibits dihydrofolate reductase and thereby reduces the regeneration of THFA; it is a powerful anticancer agent (Fig. 43.20).

**5-fluoro-uracil**, 5-iodo uracil, 3-deoxy uridine, 6-aza uridine, 6-aza cytidine and 5-iodo-2-deoxyuridine are anticancer drugs, which competitively inhibit thymidylate synthase. Cytosine arabinoside where ribose is replaced by arabinose is another anticancer agent. Anticancer agents acting on purines are described above.

Two antimetabolites used in treatment of viral infections, acyclovir (acycloguanosine) and zidovudine (azido deoxythymidine) are activated by phosphorylation within cells infected with virus.

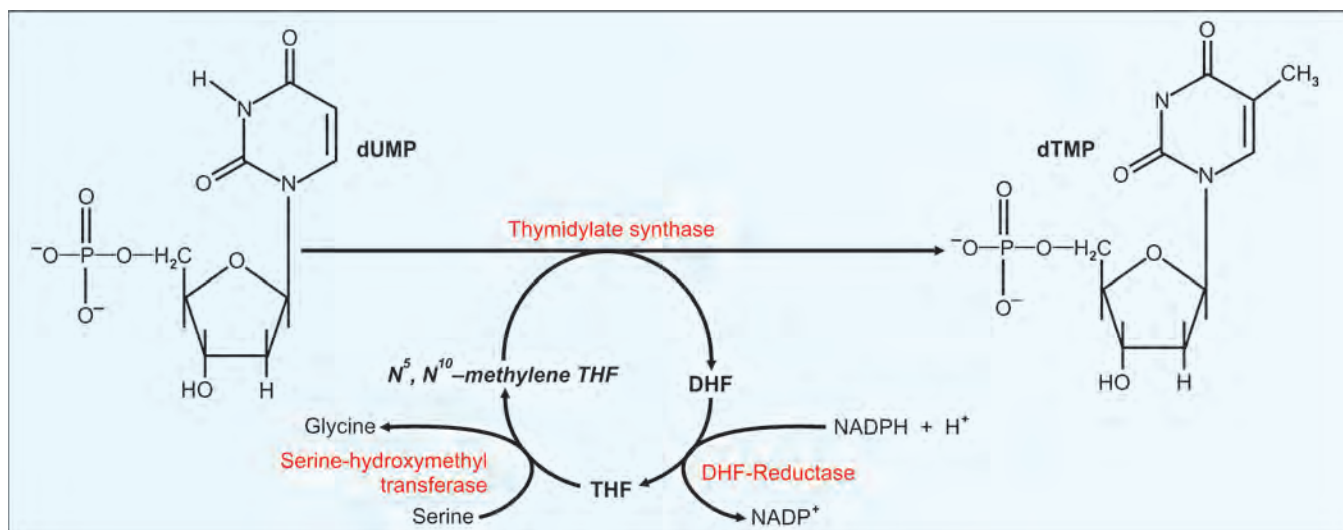
### Degradation of Pyrimidine Nucleotides

Uracil and Thymine are degraded by analogous reactions. The phosphate is removed from nucleotide to form corresponding nucleoside. In the next step, free base is released. The ring is opened. Finally, **beta-amino isobutyric acid** is excreted in urine. This is the end product of pyrimidines. Other products are carbon dioxide and ammonia (Fig. 43.21). Pseudouridine is not metabolized further, and is excreted as such in urine.

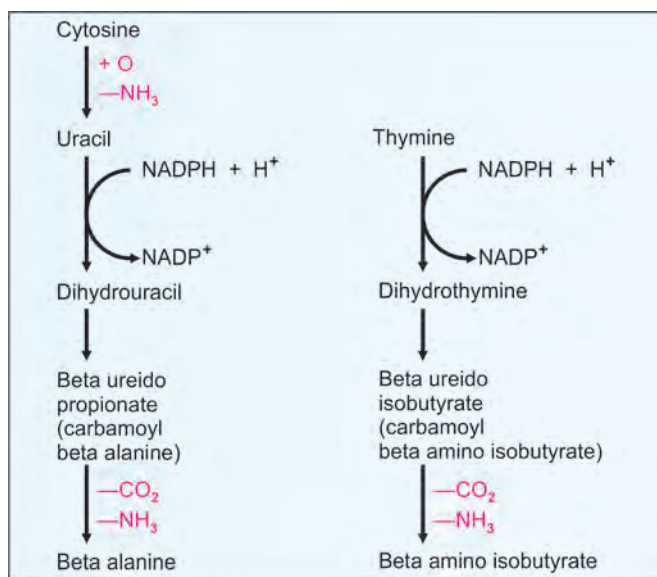
### Clinical Case Study 43.1

A 40-year-old male presented with severe pain, redness and swelling of the base of the first metatarsophalangeal joint in the night after a bout of alcohol consumption. The patient was in usual state of health until early in the morning when he woke up with severe pain in his right big toe.





**Fig. 43.20:** Production of dTMP from dUMP. The reaction needs 1 carbon units, and folic acid. DHF = dihydrofolic acid. THF = tetrahydrofolic acid. Methotrexate inhibits the enzyme DHF-reductase. So dTMP synthesis is inhibited, in turn DNA synthesis is inhibited



**Fig. 43.21:** Catabolism of pyrimidines

The patient denies any trauma to the toe and no previous history of such pain in other joints. On examination, he had mild fever  $38.2^\circ C$ . The right big toe was swollen, warm, red, and exquisitely tender. Serum uric acid was  $9.7 \text{ mg/dL}$ . What is the likely diagnosis? What is the pathogenesis of the condition? How would you make a definite diagnosis?

### Clinical Case Study 43.2

A 4-year-old boy presented with hypotonia, developmental delay, irritability and self mutilating behavior. On examination,

there was testicular atrophy and hematuria. The serum uric acid level was  $10.0 \text{ mg/dL}$ . What is the likely diagnosis? What is the biochemical basis of the condition?

### Clinical Case Study 43.3

A 3-year-old girl presented with megaloblastic anemia and failure to thrive. Obstetric history was uneventful. Anemia was present, which did not improve despite blood transfusions. There was no response to  $B_{12}$ , folate and pyridoxine therapy. Urinalysis revealed presence of a crystalline sediment, which was identified to be orotic acid. Very high levels of orotate (above  $1.0 \text{ g/day}$ , normal being  $< 1.4 \text{ mg/day}$ ) were excreted. Enzyme assays were done and showed deficiency of orotate phosphoribosyl transferase (OPRTase). What is the likely condition? What is the pathogenesis of the findings?

### Clinical Case Study 43.1 Answer

**Diagnosis:** Gouty arthritis.

**Pathophysiology:** Elevated levels of uric acid are detectable in the blood and urine, resulting in precipitation of urate crystals in the joints. Synovial fluid will reveal needle-shaped crystals of monosodium urate that are negatively birefringent under polarizing microscopy will confirm the diagnosis. Formation of urate crystals in the big toe, is thought to be associated with the decreased temperature of the extremities that aids in urate crystal formation when levels exceed solubility.

### Clinical Case Study 43.2 Answer

**Diagnosis:** Lesch Nyhan syndrome.  
See text for details about biochemical basis.

### Clinical Case Study 43.3 Answer

The likely condition is orotic aciduria. There is excessive excretion of orotic acid. The enzyme deficient may be OPRTase or orotidylate decarboxylase. It can also be secondary to OTC deficiency. Clinical findings appear in the first year of life and include growth failure, developmental retardation and megaloblastic anemia, refractory to vitamin B<sub>12</sub> and folic acid. Lack of CTP, UTP, and TMP as a result of enzyme inhibition decreases nucleic acid synthesis and decreases RBC production leading to megaloblastic anemia, physical and mental retardation.

Diagnosis is made by severe megaloblastic anemia with normal B<sub>12</sub> and folate levels and no evidence of transcobalamine II deficiency. Elevated orotic acid and RBC enzyme assay (transferase) confirms the diagnosis. Treatment is to administer uridine, which will synthesize UTP, CTP and TMP reducing the symptoms and also produces feedback inhibition of orotic acid production.

### QUICK LOOK OF CHAPTER 43

1. A nucleotide is composed of a nitrogenous base, a pentose sugar and phosphate groups esterified to the sugar.
2. Purine bases in both DNA and RNA are the same.
3. Purine salvage pathway is mediated by two enzymes: Adenine phosphoribosyl transferase (APRTase) and Hypoxanthine guanine phosphoribosyl transferase (HGPRTase).
4. Committed step of de novo purine synthesis is the reaction catalyzed by amidotransferase.
5. Xanthine oxidase is a metalloflavoprotein containing FAD, molybdenum and iron. Allopurinol inhibits it, which is a good example of 'suicide inhibition'.
6. End product of purine catabolism is uric acid. Its normal serum level is 3–7 mg/dL. Level is increased in gout.
7. Uric acid crystals deposited in the cooler areas of the body cause tophi.
8. Lesh-Nyhan syndrome is a X-linked inherited disorder of purine metabolism, due to deficiency of HGPRTase. The condition is characterized by self-mutilation tendency.
9. Adenosine deaminase deficiency has been treated by gene replacement therapy.
10. In mammalian cells, regulation of pyrimidine synthesis occurs at the level of Carbamoyl phosphate synthase II, which is inhibited by UTP.
11. Deficiency of OMP decarboxylase and OPRTase leads to Orotic aciduria.
12. Disorders of purine metabolism are summarized in Table 43.7.
13. Disorders of pyrimidine metabolism are summarized in Table 43.8.

# CHAPTER 44

## Deoxyribonucleic Acid: Structure and Replication

### Chapter at a Glance

The reader will be able to answer questions on the following topics:

- Watson-Crick model of DNA structure
- Chromosomes
- Replication of DNA
- DNA polymerase
- Okazaki pieces
- DNA repair mechanisms

Thomas Morgan (1866–1945), the founder of modern genetics, showed that chromosomes contain genes in a sequential manner in *Drosophila* (Nobel prize, 1933). In 1931, Barbara McClintock showed the rearrangement of genes or mobile genes in chromosomes in corn (Nobel prize, 1983). George Beadle, working with mutant strains of *Neurospora* suggested “one enzyme one gene” hypothesis in 1941 (Nobel prize, 1958). Avery in 1944 demonstrated that DNA is the genetic material. In 1952, Hershey (Nobel Prize 1946) showed that only DNA of virus and not the proteins will enter into the host before infection. Erwin Chargaff elicited the base pairing rule of DNA in 1950. X-ray crystallographic studies on DNA by Maurice Wilkins (Nobel prize, 1962) showed the details of structure of DNA. Rosalind Franklin worked out the helical structure of DNA. (She died of ovarian cancer at the age of 37, probably due to irradiation during her work on X-ray crystallography). Based on these data, James Watson and Francis Crick in 1953 deduced the double helical structure of DNA (Nobel prize, 1962).

### STRUCTURE OF DNA

Deoxyribonucleic acid (DNA) is composed of four deoxyribonucleotides, i.e. deoxyadenylate (A), deoxyguanylate (G), deoxycytidylate (C), and thymidylate (T).

These units are linked by 3' to 5' **phosphodiester bonds** to form a long polypeptide chain. The nucleotide is

formed by a combination of base + sugar + phosphoric acid. The 3'-hydroxyl of one sugar is linked to the 5'-hydroxyl of another sugar through a phosphate group (Fig. 44.1). In this particular example, the thymidine is attached to cytidine and then cytidine to adenosine through phosphodiester linkages (Fig. 44.1).

In the DNA, the base sequence is of paramount importance. The genetic information is encoded in the specific **sequence of bases**; if the base is altered, the information is also altered.

The deoxyribose and phosphodiester linkages are the same in all the repeating nucleotides. Therefore, the



Thomas Morgan  
NP 1933  
1866–1945



Oswald Avery  
1877–1955



Alfred Hershey  
NP 1969  
1908–1997

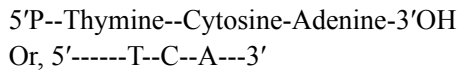


George Beadle  
NP 1958  
1903–1989



Barbara McClintock  
NP 1983  
1902–1992

message will be conveyed, even if the base sequences alone are mentioned as shown:



This would convey all the salient features of the polynucleotide shown in Figure 44.1.

## Polarity of DNA molecule

In the case of DNA, the base sequence is always written from the 5' end to the 3' end. This is called the polarity of the DNA chain.

## Watson-Crick Model of DNA Structure

The salient features of Watson-Crick model of DNA are given in Figures 44.2 and 44.3.

### Right Handed Double Helix

DNA consists of two polydeoxyribonucleotide chains twisted around one another in a right handed double helix similar to a spiral stair case. The sugar and phosphate groups comprise the handrail and the bases jutting inside represent the steps of the staircase. The bases are located perpendicular to the helix axis, whereas the sugars are nearly at right angles to the axis.

### The Base Pairing Rule

Always the two strands are **complementary** to each other. So, the adenine of one strand will pair with thymine of the opposite strand, while guanine will pair with cytosine. The base pairing (**A with T; G with C**) is called **Chargaff's rule**, which states that the number of purines is equal to the number of pyrimidines.

### Hydrogen Bonding

The DNA strands are held together mainly by hydrogen bonds between the purine and pyrimidine bases. There are two hydrogen bonds between A and T while there are three hydrogen bonds between C and G. The GC bond is therefore stronger than the AT bond.

The spatial alignment of the helix allows only purine to pyrimidine base pairing. A-T and C-G base pairs have almost the same shape. A mispairing will disturb the stable double helical structure.

## Antiparallel

The two strands in a DNA molecule run antiparallel, which means that one strand runs in the 5' to 3' direction, while the other is in the 3' to 5' direction. (Fig. 44.2). This is similar to a road divided into two, each half carrying traffic in the opposite direction.

## Other Features

In the DNA, each strand acts as a template for the synthesis of the opposite strand during replication process. The spiral has a pitch of 3.4 nanometers per turn. Within a single turn, 10 base pairs are seen. Thus, adjacent bases are separated by 0.34 nm. The diameter or width of the helix is 1.9 to 2.0 nm.

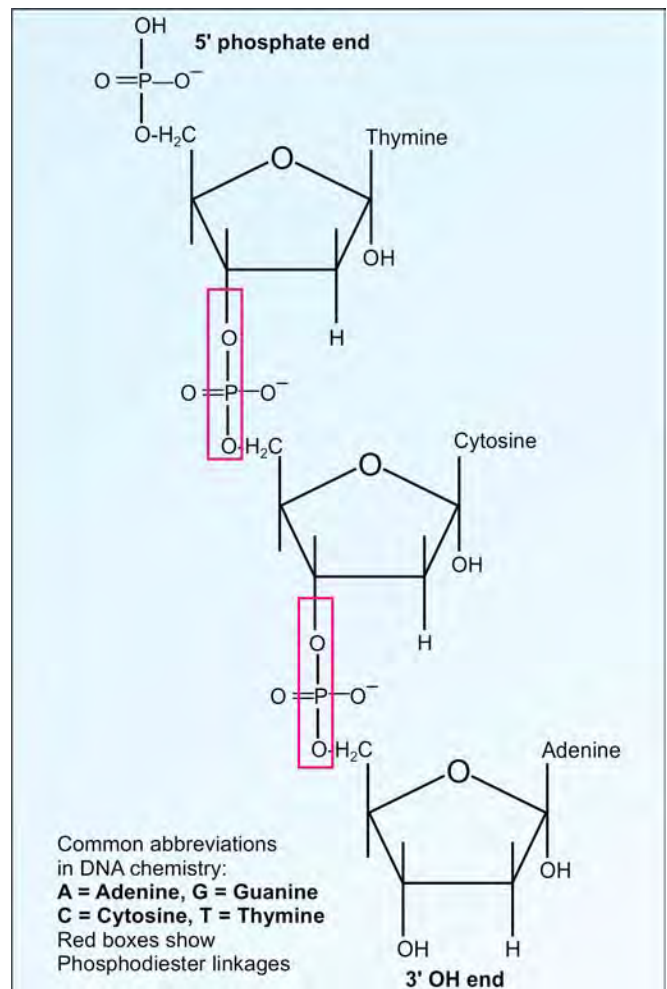


Fig. 44.1: Polynucleotide



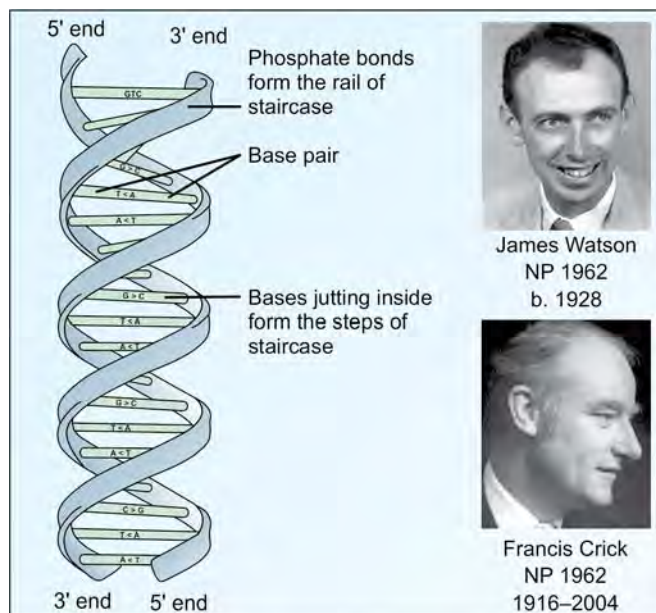
A major groove (1.2 nm) and a minor groove (0.6 nm) wind along the molecule, parallel to the phosphodiester backbone. In these grooves, proteins interact with the exposed bases. The stacking of base pairs stabilize the double helix by the hydrophobic effect and conformation of the ring systems. DNA is the storehouse of genetic information (Box 44.1).

### Denaturation of DNA Strands

The double stranded DNA may be denatured and separated by heat. This is called as **melting of DNA**.  $T_m$  or **melting temperature** is the temperature when half of the helical structure is denatured. At lower temperature, the melted strands are re-associated; this is called **annealing**. When DNA is denatured, unstacking of bases occur resulting in increased absorbance at 260 nm-hyperchromicity.

#### Box 44.1: DNA is the storehouse of genetic information

The major differences between DNA and RNA are the presence of 2 deoxyribose and absence of the base uracil in DNA. The presence of the oxygen atom in the 2nd carbon of RNA makes it more prone to spontaneous hydrolysis of the P-O-P bonds. On the other hand the polynucleotide DNA chain is much more stable and the half-life for spontaneous hydrolysis is about 200 million years. Hence, DNA becomes the more suitable storehouse of genetic information. Also the possibility of mutations occurring and remaining unidentified is more with uracil since cytosine can be easily deaminated to uracil.



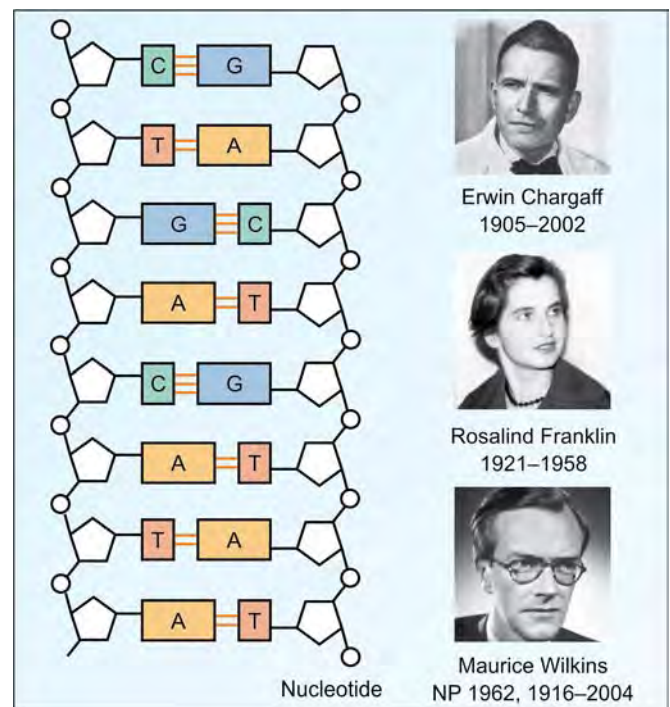
**Fig. 44.2:** Watson-Crick model of double helical structure of DNA. Adjacent bases are separated by 0.34 nm. The diameter or width of the helix is 2 nanometers

## Higher Organization of DNA

In higher organisms, DNA is organized inside the nucleus. Double stranded DNA is wound round histones to form nucleosomes (Fig. 44.4). **Chromatin** is a loose term employed for a long stretch of DNA in association with histones. Chromatin is then further and further condensed to form **chromosomes** (Fig. 44.5). Similarly, the DNA molecule is folded and compressed to 10,000 fold to generate chromosomes (Fig.44.5).

### Histones

These are proteins containing unusually higher concentration of basic amino acids. There are 5 classes; H1, H2A, H2B, H3 and H4. The H1 histone is loosely attached to the DNA (Fig.44.4). Others are called



**Fig. 44.3:** Base pairing rule. Base pairing of A with T and G with C. Hydrogen bonds between bases



**Fig. 44.4:** DNA wraps twice around histone octamer to form one nucleosome

core histones because they form the nucleosome (Fig. 44.4). Amino terminal one-third region of H2A and H2B are lysine rich. H3 and H4 are arginine rich histones. Histone synthesis stops when DNA synthesis ceases. Histones synthesized in the cytoplasm migrate to the nucleus. Histones are modified by acetylation, methylation, ADP-ribosylation and phosphorylation. Acetylation and methylation of lysine residues are the most common modifications. Acetylation of histones leads to activation of transcription, whereas de-acetylation causes depression of transcription. Phosphorylation is associated with condensation of chromosomes. ADP-ribosylation is associated with DNA repair. Methylation generally occurs when the gene is repressed. Sometimes histones are fixed to **small ubiquitin related modifier** (abbreviated as **Sumo**), and the process is called sumoylation. Sumoylation of histones is seen during repression of transcription.

Apart from histones, there are many other special proteins which will interact at specific regions of DNA. The protein–DNA **interactions are mainly mediated by 3 motifs** – Helix-turn-helix, zinc finger and leucine zipper motifs. Only small regions of the protein make direct contact with the DNA; the rest of the proteins are involved in other activities, like dimerization, ligand-binding, interaction with coactivators and corepressors, etc. DNA binding and transactivation domains of most regulatory proteins are separate and noninteractive.

### Nucleosomes

The double stranded DNA wraps twice around a histone octamer formed by H2A, H2B, H3 and H4 (Fig. 44.4). This super-twisted helix forms a spherical particle of 10 nm diameter; called nucleosome. The function of the nucleosome is to condense DNA; this arrangement also stabilizes DNA.

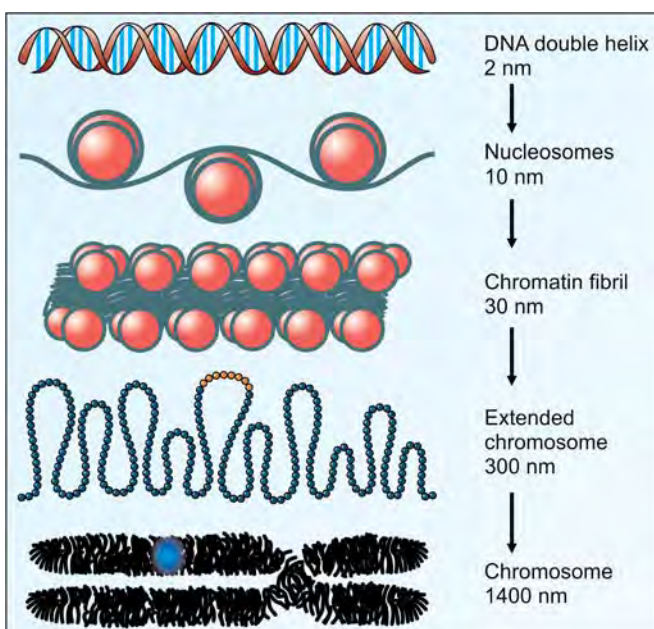


Fig. 44.5: DNA condenses repeatedly to form chromosome

### Further Condensation of DNA

The supercoiled DNA with histones (nucleosomes) will have a diameter of about 10 nm. A group of such nucleosomes form the “DNA fibrils”. About 6 such fibrils are further supercoiled to form 30 nm diameter **chromatin fibers** or chromatin threads. By this time, the DNA is folded to about 100 times. Histones stabilize these fibers. In interphase chromosomes, chromatin fibers condense to 100,000 bp loops, anchored in some supporting matrix (nuclear matrix) (Fig. 44.5).

### DNA is a Very Long Molecule

Human diploid genome consists of about  $7 \times 10^9$  base pairs and bases are at a distance of 0.34 nm. So when placed end to end it will be about two meters long. If one nucleotide is added per second, it will take 250 years to synthesize the whole DNA of a human cell. The length of a DNA molecule is compressed to 8,000 to 10,000 fold to generate the chromosomes (Fig. 44.5).

### Chromosomes

These fibers are further supercoiled and condensed to form **chromosomes** during the M phase of cell cycle. The packaging of nucleoproteins within chromosome is specific, as shown by characteristic patterns (banding) observed by Giemsa’s staining (Fig. 44.6). During metaphase, the DNA can be seen under a microscope, as superpacked chromosomes, where identical sister chromatids are connected at the centromere. Depending on the length of the chromosome and the position of the centromere, the chromosomes are numbered. In humans, there are **23 pairs of chromosomes** (Fig. 44.7). **The position of centromere is the characteristic mark for specific chromosome.** The centromere is at rich region, and has repeated DNA sequences of about one million base pairs in mammals. This region also shows a lot of **specific centromere binding proteins**. This region is called **kinetochore**, which provides the anchor for the mitotic spindle.

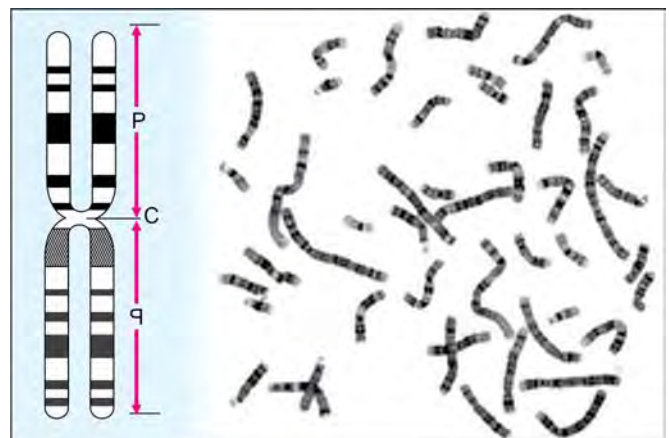


Fig. 44.6: Chromosome banding. On right side, chromosomes of whole cell is shown. One chromosome is enlarged on the left side. p= short arm; C= centromere; q = long arm

### Activity of Chromatin

Transcriptionally active regions of chromatin are sensitive to digestion by deoxyribonuclease-1 (DNase-1). These are 100,000 bp long. Certain regions of the active regions contain **hypersensitive sites** to DNase, these are 100–200 nucleotides long. These regions are supposed to be the site where transcription factor proteins are assembled, and where transcription is initiated. Active regions stain less densely and are called **euchromatin**. Euchromatin fills up the majority of the nucleus. Transcriptionally inactive chromatin is densely packed and is called **heterochromatin**.

### Inactivation of DNA During Differentiation

All human cells are derived from a single cell, the zygote. Therefore, all cells contain the same genetic information. But, a cell from the gastrointestinal epithelium is different from a cell of central nervous system, by structure and function. How such a differentiation is made possible? In a cell, about 90% DNA are permanently inactive. Histones and specific proteins help in this inactivation process and consequent **differentiation**.

### Introns, Exons, Cistron

With the progress of evolution, DNA content has also increased (Table 44.1).

The segments of the gene coding for proteins are called **exons** (expressed regions). They are interspaced in the DNA with stretches of silent areas, called **introns** (intervening areas). The primary mRNA transcripts contain intron sequences; which are later removed to produce mature mRNA. Introns are not translated. Actual function of introns is not clear. It may serve to separate exons so that genetic recombination can occur more easily and efficiently.

A **Cistron** is the unit of genetic expression. It is the biochemical counterpart of a “gene” of classical genetics. One cistron will code for one polypeptide chain. If a protein contains 4 subunits, these are produced under the direction of 4 cistrons (“one cistron–one polypeptide” concept).

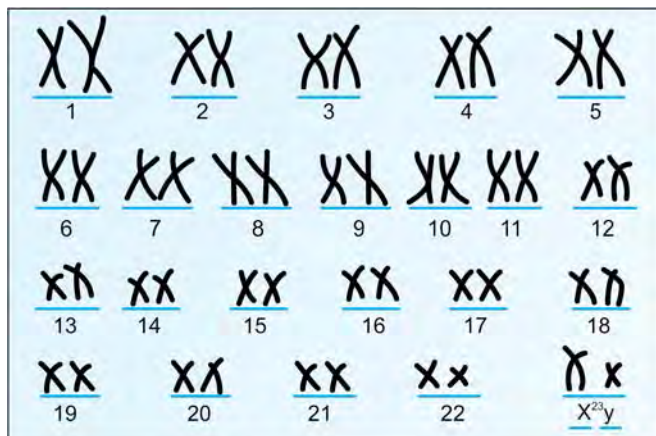


Fig. 44.7: Karyotyping; normal chromosome pattern

### “Junk DNA” is very relevant!!

When the Human genome draft was published in 2001, scientists thought that only a very small fraction of the human genome (1%) coded for synthesis of the gene products, the proteins. Hence, the rest of the DNA was referred to as “junk DNA”. But a decade later, the findings of the ENCODE (**ENCyclopedia Of DNA Elements**) project published in September 2012, have recognized the function of this non-coding DNA. Accordingly 80% of the DNA is functional, and is required for regulation of gene expression. The coding regions are distributed over 98% of the genome. Binding of regulatory proteins to specific sites on DNA is responsible for switching on and off genes.

### Repeat Sequences of DNA

About 50% of DNA has unique or non-repetitive sequences, whereas 30% has repetitive sequences. Only about 1–2% of the human DNA contain genes; the rest are silent areas. About 1% of DNA is present inside mitochondria. There are only about 25,000 to 30,000 protein-coding regions in the human DNA. About 90% of DNA is made of noncoding intervening sequences, called **introns**. About 50% of DNA is unique or nonrepetitive. About 30% of the genome consists of repetitive sequences, 5–500 base pairs repeated many times. These repetitive sequences are clustered mainly at centromeres and telomeres, but may be randomly distributed in other regions also. Repetitive sequences include highly repetitive sequences, moderately repetitive sequences; long interspersed repeat sequences (LINEs) or short interspersed repeat sequences (SINEs). **Long interspersed repeat sequences** (LINEs) are 6–7 kbp length and are repeated about 50,000 times. The **short interspersed repeat sequences** (SINEs) are 100–300 bp in length, but are repeated 100,000 times. One such sequence, the **Alu family** is repeated about 5,00,000 times, and accounts for about 5% of total human DNA. These interspersed repeat sequences are **mobile elements**, and they can jump from one region to another region of the genome. They appear to be **retrotransposons**, i.e. they can move from one location to another (**transposition**) through an RNA intermediate by the action of reverse transcriptase. **Microsatellite repeat sequences** are AC repeats on one strand and TG on the other strand; such repeats are 100,000 in the genome. **Trinucleotide sequence repeats** are associated with diseases. Thus, CGG repeat sequence is seen in fragile X syndrome. Similarly, CAG repeats are seen in Huntington’s chorea, CTG in myotonic dystrophy, CAG in spinobulbar muscular atrophy.

## REPLICATION OF DNA

During cell division, each daughter cell gets an exact copy of the genetic information of the mother cell. This process of copying the DNA is known as **DNA replication**.

In the daughter cell, one strand is derived from the mother cell; while the other strand is newly synthesized.

TABLE 44.1: DNA content in diploid (2n) cells

Species	bp/cell	Species	bp/cell
Bacteria	$1 \times 10^6$	Fishes	$2 \times 10^9$
Fungi	$1 \times 10^7$	Lower mammals	$5 \times 10^9$
Insects	$1 \times 10^8$	Humans	$6 \times 10^9$



This is called **semi-conservative** type of DNA replication. Each strand serves as a **template** or mold, over which a new **complementary** strand is synthesized (Fig. 44.9).

### Meselson-Stahl Experiment (1958)

Bacteria were grown in a medium containing the heavy isotope of nitrogen  $^{15}\text{N}$ , when all the DNA was labeled with heavy nitrogen. These cells were allowed to divide in a medium containing normal nitrogen,  $^{14}\text{N}$ . In the first generation, all DNA molecules were half labeled. In the second generation half labeled and completely unlabeled molecules were present in equal numbers. From this experiment (Fig. 44.8), it was proved that *DNA replication is semiconservative in vivo*.

The **base pairing** rule is always maintained. The new strand is joined to the old strand by hydrogen bonds

between base pairs (A with T and G with C) (Figs 44.3 and 44.10). The replication is summarized in Figure 44.11. The whole process may be studied under the following steps:

### Origin of Replication

The DNA replication starts with the recognition of the site of origin of replication (ORI). This is done by a **complex**. Many origins of replication, called **autonomous replicating sequences (ARS)** have been identified in mammals. The origin of replication on the DNA strand in bacteria is termed as ori. Corresponding areas in higher organisms are called **replicators**, which contain certain base sequences called the **origin replication element (ORE)**. This area is recognized by specific proteins collective called the **origin recognition complex (ORC)**.

### Unwinding of DNA

DNA helicase unwinds the DNA.

- Topoisomerases, Gyrases and Helicases**, all of them unwind the DNA. Relief of supercoil is done by topoisomerases. The **type I** acts by making a transient break in one strand of DNA, and it is immediately resealed after the coiling.
- Type II** acts by introducing double stranded breaks, rotation is made and the breaks are resealed.
- Gyrase** is a bacterial type II topoisomerase which acts on closed circular DNA (bacteria have circular DNA).
- Helicase** separates the strands of DNA, without a cut, but using energy from hydrolysis of ATP.

### Components of DNA Replisome

The complex of enzyme proteins and other factors required for DNA replication is called replisome. DNA replication needs the participation of more than 20 enzymes and proteins, collectively called *DNA replicase system* or replisomes. The important components are:

- The *protein A or DnaA* binds at specific sites of origin, and opens the duplex.
- The relief of supercoil needs *topoisomerases*.
- Then *helicase or DnaB* separates the strands, using energy from ATP. Helicase moves in both directions, separating the strands in advance for replication. This forms a **replication bubble** (Fig. 44.12) with two **replication forks**.
- Single stranded DNA binding proteins (SSB)** stabilize the complex.

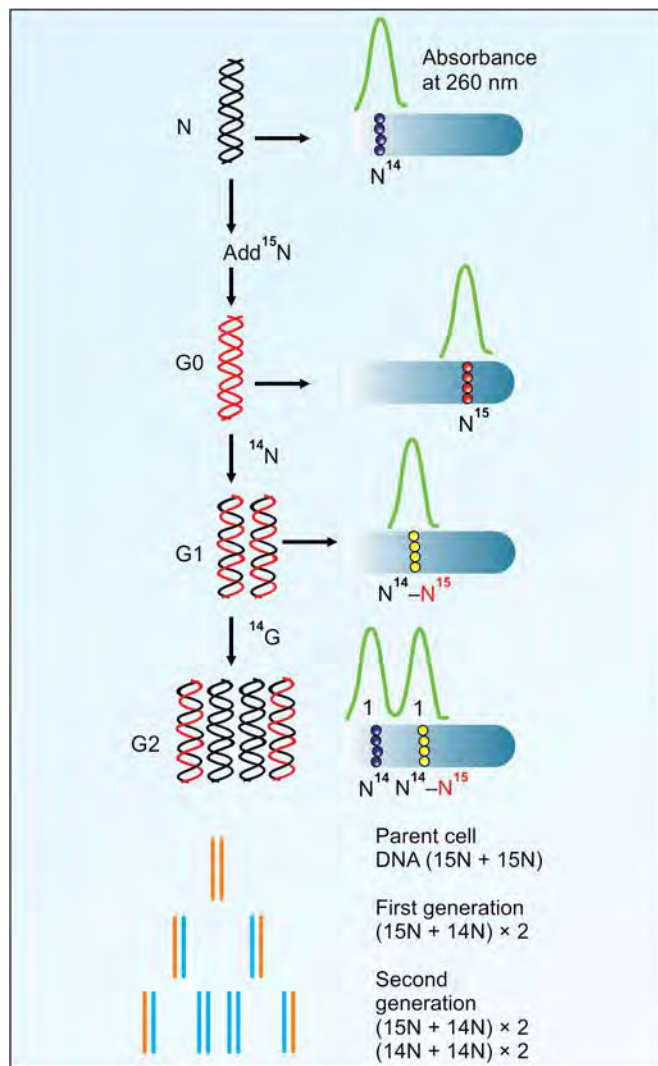


Fig. 44.8: Meselson-Stahl experiment; G0 = parent cell; G1 = first generation; G2 = second generation



### Replication Bubble

Each replication fork contains (Fig. 44.12):

- DNA helicase which unwinds a short region of DNA helix
- Primase that initiates synthesis of a short RNA segment (see below)
- DNA polymerase enzyme that synthesizes the new strand of DNA (see below)
- DNA is prevented from rewinding by SSBs.

### DNA Polymerase

This enzyme synthesizes a new complementary strand of DNA, by incorporating dNMP sequentially in 5' to 3' direction, making use of single stranded DNA as template.

#### Bacterial DNA Polymerases

In bacteria there are 5 polymerases. Arthur Kornberg (Nobel prize, 1959) isolated the DNA polymerase I (**Kornberg's enzyme**) from *Escherichia coli*. It is a repair enzyme. It has both 3' to 5' and 5' to 3' exonuclease activities. When 5' to 3' exonuclease domain is removed, the remaining fragment retains the polymerization and proofreading activities; it is then called **Klenow fragment**. It is widely used in recombinant DNA technology. Bacterial **DNA polymerase III** is the main replication enzyme in bacteria. It has beta, gamma, delta and delta' units. Bacterial polymerases Type IV and V are identified in 1999. DNAP II has editing and proofreading activity.

#### Mammalian DNA Polymerases

In mammalian cells (eukaryotic), there are 5 DNAPs, named as  $\alpha$ ,  $\beta$ ,  $\gamma$ ,  $\delta$  and  $\epsilon$ . Alpha polymerase polymerizes about 100 nucleotides per second. (Bacterial enzyme has 10 times more speed). It is the major enzyme which synthesizes Okazaki fragments. It has 4 subunits, of which one has primase activity. DNAP delta is mainly responsible for leading strand synthesis and also elongates the Okazaki fragments. DNAP beta is a proofreading and repair enzyme, where as DNAP gamma is concerned with mitochondrial DNA replication. Epsilon is involved in damage repair.

### RNA Primer is Required for DNA Synthesis

An RNA primer, about 100–200 nucleotides long, is synthesized by the **RNA primase**. Then the **RNA primer is removed by DNAP**, using exonuclease activity and is replaced with deoxyribonucleotides by DNAP (Fig. 44.13).

### Elongation of DNA Strand

Under the influence of DNA polymerase, the 3' hydroxyl group of the end nucleotide combines with the 5' phosphate group of the new deoxynucleotide. The pyrophosphate is

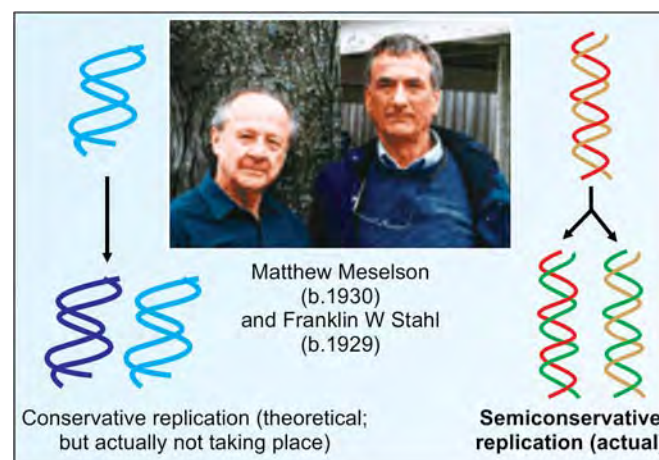
released from the deoxynucleoside triphosphate (Figs 44.10 and 44.11). This newly added nucleotide would now polymerise with another one, forming the next phosphodiester bond. If "A" is present on the template, "T" enters in that place in the newly synthesized DNA strand. The **base pairing rule** is always observed. The DNA polymerase carries out the sequential addition of each nucleotide **complementary** to the one in the template strand.

**Polymerization:** Polymerization of the new strand of DNA is taking place from 5' to 3' direction. This means that the template is read in the 3' to 5' direction (Figs 44.10 and 44.11). That is the 3rd hydroxyl of the last deoxynucleotide is joined with the 5th phosphate of the newly entering nucleotide. Thus, the 3' end of the last nucleotide is free. This would mean that the template is read by the enzyme in the 3' to 5' direction.

Of the two double stranded molecules of DNA produced, one goes to one daughter nucleus and the other to the second daughter nucleus. But each daughter cell gets only one strand of the parent DNA molecule. Old DNA strand is not degraded, but is conserved in the daughter cell, hence this is **semiconservative** synthesis (Fig. 44.9). Synthesis of new DNA requires all the four dNTPs and divalent metal ions, magnesium.

### Discontinuous Synthesis and Okazaki Pieces

- DNA synthesis is always in the 5' to 3' direction in both strands. The strand which is discontinuously synthesized is referred to as the **"lagging strand"** otherwise called "retrograde strand" and the one continuously polymerized as the **"leading strand"** (Fig. 44.14).



**Fig. 44.9:** Semiconservative replication (A new complementary strand is synthesized over the old template)

Replication of DNA is taking place on both strands simultaneously; but it is in pieces of about 100 to 250 nucleotides in length. This “discontinuous DNA synthesis” produces **replication forks** or replication **bubbles** (Fig. 44.12). Both strands are simultaneously replicated.

- ii. The small DNA molecules attached to its own primer RNA are called **Okazaki fragments**. Several Okazaki pieces are produced. The synthesis along the lagging strand is in 5' to 3' direction. As it moves, the primase synthesizes short RNA primer, to which deoxyribonucleotides are added by DNA polymerase. (DNAP-alpha synthesizes short pieces, which are extended by DNAP-delta. This delta enzyme has a role in the synthesis of both leading and lagging strands). **DNAP-alpha has primase activity.**
- iii. DNA synthesis continues until the primer and previously added Okazaki fragment is encountered. Then the *RNA primer is removed by DNAP*, using exonuclease activity and is replaced with deoxyribonucleotides by DNAP. The remaining nick is sealed by the **DNA ligase**.

### Condensation into Chromatin Structure

Newly synthesized DNA is rapidly arranged into nucleosomes. This is facilitated by histone chaperone proteins

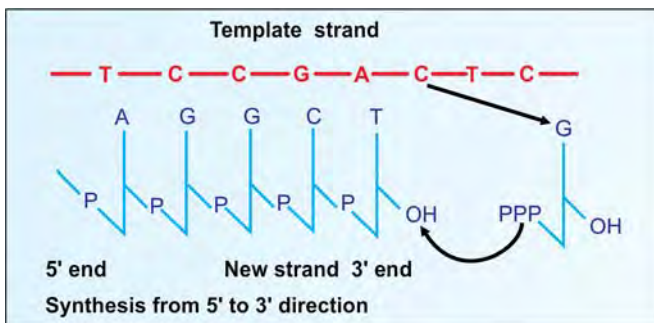


Fig. 44.10: New strand is synthesized from 5' to 3' direction. Base pairing rule is always maintained

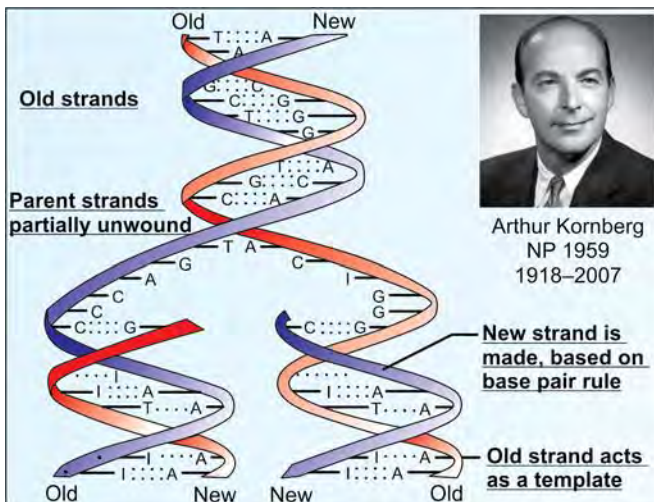


Fig. 44.11: Both strands are replicated

and chromatin remodeling complexes. A summary of DNA replication is given in Box 44.2.

### Modification After Replication

**DNA methylation** at C5 of cytosine catalyzed by DNA methyl transferase is commonly associated with gene silencing and contributes to the X-chromosomal inactivation and genomic imprinting (selective silencing of maternal or paternal alleles). Transcriptional regulation of tissue specific genes during cellular differentiation also results from DNA methylation. Methylation occurs in CG rich areas in the promoter region.

#### Box 44.2: Summary of DNA replication

1. Origin of replication is identified. Then unwinding of parental DNA to form a replication fork.
2. RNA primer complementary to the DNA template is synthesized by RNA primase.
3. DNA synthesis is continuous in the leading strand (towards replication fork) by DNA polymerase.
4. DNA synthesis is discontinuous in the lagging strand (away from the fork), as Okazaki fragments.
5. Elongation: In both strands, the synthesis is from 5' to 3' direction.
6. Then the RNA pieces are removed; the gaps filled by deoxynucleotides by DNAP and the pieces are ligated by DNA ligase.
7. Proofreading is done by the DNA polymerase.
8. Finally organized into chromatin.
9. Main enzymes involved in replication are: DNA polymerases; helicases; topoisomerases; DNA primase; single strand binding proteins; and DNA ligase.

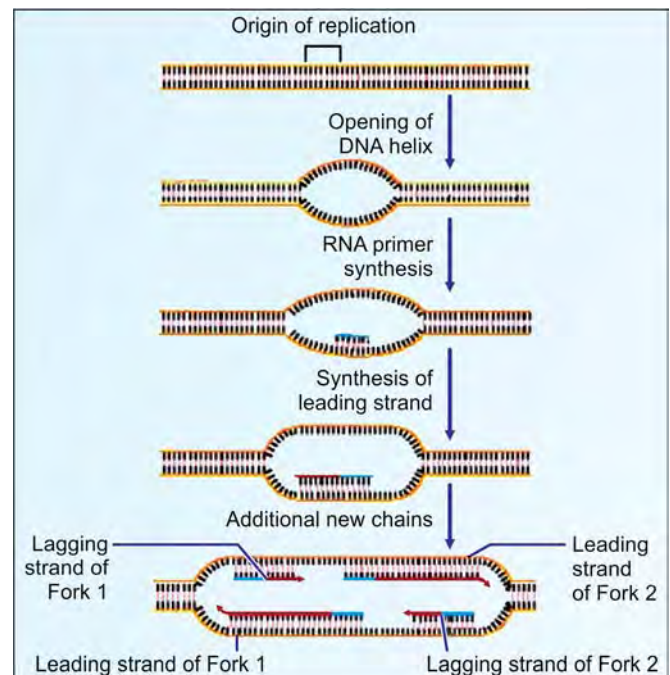


Fig. 44.12: Replication bubble (Replication fork)

The changes in gene expression are inherited, but during the passage from one generation to another, the imprints may be erased and **rewritten**. **Epigenetic imprints which modify genetic expression are said to be the writings with nature's pencil, that can be erased and rewritten.**

Greater than 90% of methyl-C is found in the dinucleotide, CpG. The promoter regions of genes contain 10–20 times as many CpGs when compared to the rest of the genome. Methylated regions are transcriptionally silent. When the region is under-methylated, the gene is transcriptionally active. The methylation of DNA is catalyzed by several different DNA methyltransferases (Dnmt). Loss of Dnmt 3 gene resulted in death shortly after birth. There are several proteins that bind to methylated CpGs but not to unmethylated CpGs. One such protein is MeCP2 (methyl Cp binding protein 2). When MeCP2 binds to methylated CpG dinucleotides, it leads to transcriptional repression. Deficiencies in MeCP2 result in the Rett syndrome, a neurodevelopmental disorder with mental retardation, seizures, microcephaly, arrested development, and loss of speech.

The word “genomic imprinting” refers to the fact that the expression of some genes depends on whether or not they are inherited maternally or paternally. Expression of insulin-like growth factor-2 (IGF2) occurs exclusively from the paternal copy of the gene. Imprinted genes are “marked” by their state of methylation. In the case of paternal copy of IGF2, an insulator element is methylated; then a distant enhancer element allows the expression of the IGF2 gene. In the maternal genome, the insulator is not methylated, thus protein binds to it blocking the action of the distant enhancer element. In addition to the IGF2 locus, at least 80 genes are known to be imprinted in the human genome. Several of these loci have been associated with various diseases.

The degree of methylation in normal cells and cancer cells are different. One of the effects of ROS (reactive oxygen species, free radicals) is through hypermethylation. Aberrant methylation is also observed in cellular senescence and may affect age-related diseases, such as type 2 diabetes mellitus.

## Cell Cycle

In G1 (gap 1) phase, the cell prepares for DNA synthesis. DNA synthesis occurs during the S (synthesis) phase of the cell cycle (Fig. 44.15). During the S phase, DNA is completely replicated, but only once. Cell prepares for mitosis in G2 (gap 2) phase, when proteins necessary for daughter cells are synthesized. Then the cell enters into the M (mitotic) phase, when chromosomes are visible under microscope. The whole cycle lasts about 24 hours; out of which M phase is only 1–2 hours. Those cells which are not in division are said to be in G0 phase or resting phase. Cell cycle, cyclins, CDKs, Rb protein, etc. are further described in Chapter 47.

## DNA REPAIR MECHANISMS

The replication process should be carried out with **high fidelity**, otherwise the information is altered. Hence, there should be a foolproof mechanism to correct the mistakes. While printing a page, the typesetter sets the types; an impression is taken, **proofreading** is done to correct mistakes if any, and then the final printing is done. A similar

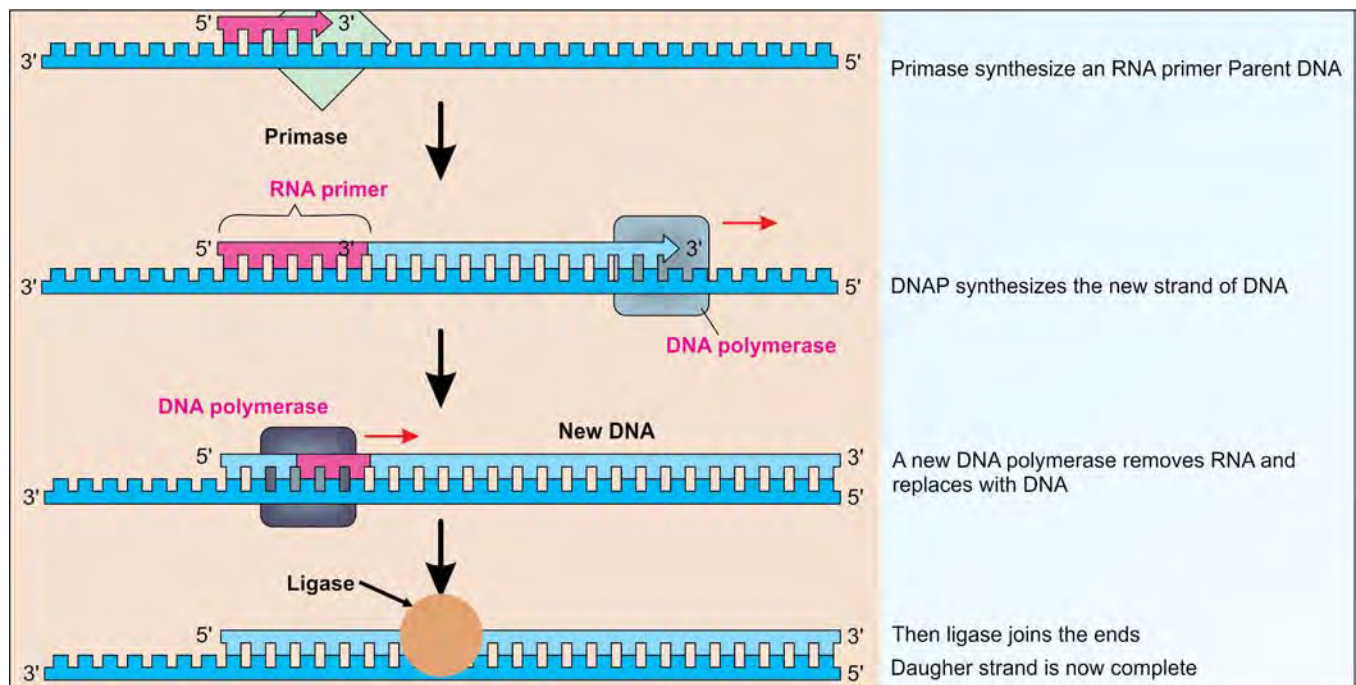


Fig. 44.13: RNA primer is needed for the DNA synthesis



follow-up mechanism operates after DNA synthesis. Various physical and chemical agents produce base alterations; these are to be appropriately corrected immediately. There are different types of DNA repair mechanisms; all of them follow the general mechanism outlined above, but details may vary. A summary of the DNA repair is given in Table 44.2.

### Exonucleolytic Proofreading

The DNA polymerase has 3' to 5' exonuclease activity. Hence any mispaired nucleotide added is immediately removed (Fig. 44.16).

### Nucleotide Excision Repair

This takes place along with the replication process (proof-reading). The original template DNA contains methylated residues (N6-methyl adenine and 5-methyl cytosine). The

newly synthesized strand will not have methylated bases. So enzymes can recognize the original (correct) DNA strand. The mismatched base is identified and removed along with a few bases around that area. The wrong base is removed by the **endonuclease** activity. It removes 24 – 32 nucleotides around the wrong base. As the endonuclease cleaves at two points, the enzyme is sometimes also called excinuclease. A small segment of DNA with correct base sequence is then synthesized by DNA polymerase beta. Then the gap or nick is sealed by DNA ligase. The ligase requires energy input for its activity (Fig. 44.17).

### Strand Directed Mismatch Repair

Specific proteins scan the newly synthesized DNA strand (new strand is identified by not being methylated) (Fig. 44.18.). The mismatched area is identified, a loop is made. In *E.coli*, this recognition and looping is done by three proteins, MutS, MutC and MutH. Then that segment is removed. Finally correct segment is synthesized by the help of DNA polymerase, SSBs, and ligase.

### Base Excision Repair

Depurination of DNA is a spontaneous process, which occurs at a rate of 10,000 per cell per day. Thus cytosine, adenine and guanine bases

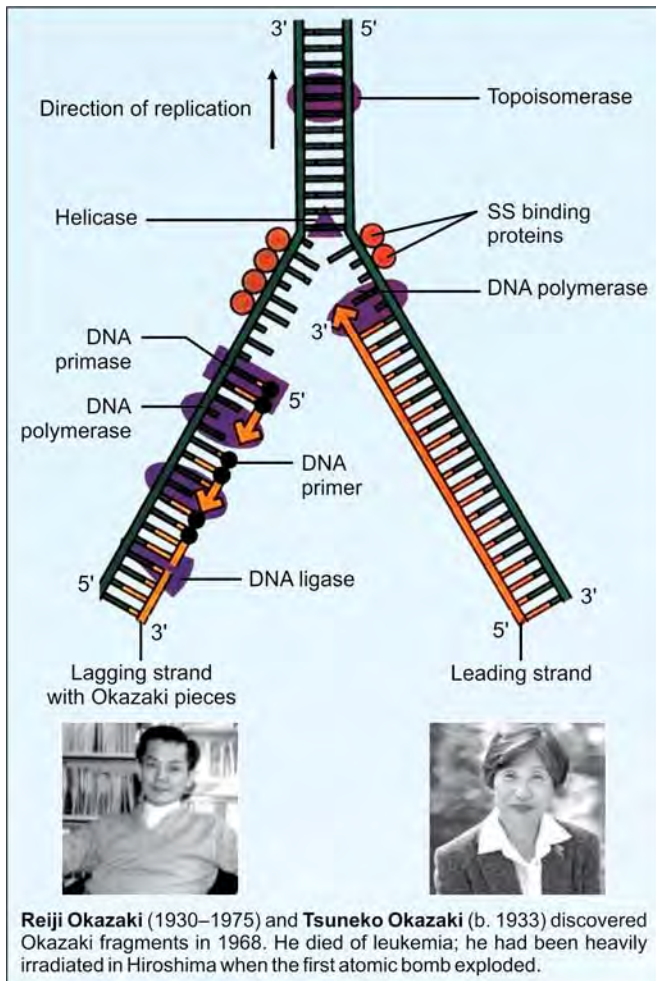


Fig. 44.14: Lagging strand and Okazaki pieces

TABLE 44.2: DNA repair mechanisms		
Mechanism	Defect	Repair
Mismatch repair	Copying error 1–5 bases unpaired	Strand cutting, exonuclease digestion
Nucleotide excision repair (NER)	Chemical damage to a segment	30 bases removed; then correct bases added
Base excision repair	Chemical damage to single base	Base removed by N-glycosylase; new base added
Double strand break	Free radicals and radiation	Unwinding, alignment, ligation

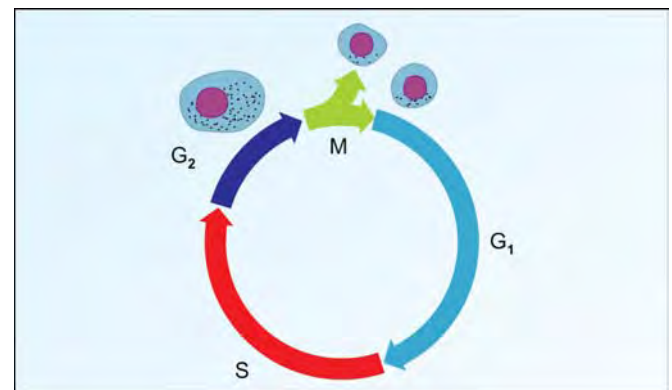


Fig. 44.15: Cell cycle



spontaneously form uracil, hypoxanthine and xanthine respectively. These are not normal bases of DNA. Specific N-glycosylases can remove these abnormal bases. The sugar has no base. Apurinic endonucleases excise this abasic sugar. Proper base is then added by a repair DNAP and ligase.

### Transcription Coupled Repair

The template strand of transcribed region responds immediately by stalling of RNAP at the site of damage. The enzyme backs away, repair proteins are recruited and the defect repaired by NER. Cockayne syndrome results from deficiency of proteins that help to recognize the halted RNAP.

### Mutations

Even after proofreading, some mistakes may be retained in the print. Similarly a few defects may remain in the DNA. These are called mutations. Mutations are due to a change in the base sequence of DNA. These may result from faulty replication or repair of DNA. Mutation rate is about 6 nucleotide changes per year in the **germ cell line** cells of an individual. Moreover, out of every  $10^6$  cell divisions, one **somatic mutation** is taking place. Mutations and mutagens are further explained in Chapter 47.

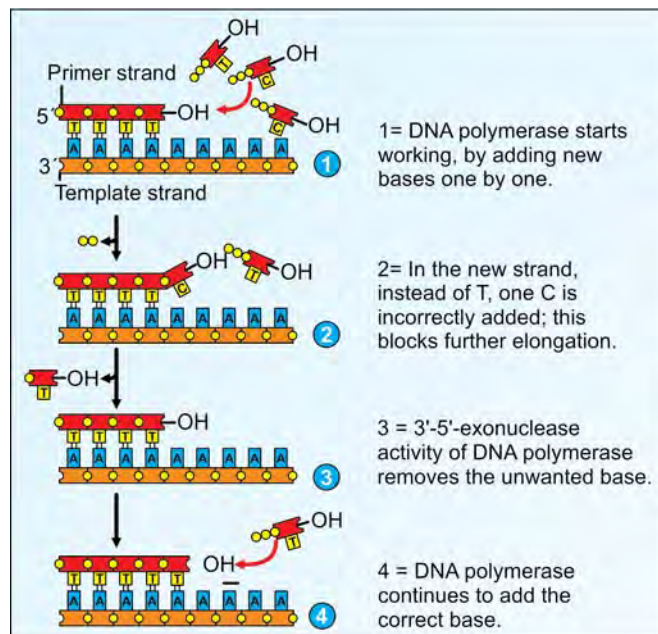


Fig. 44.16: Exonucleolytic proofreading of DNA polymerase

## Diseases Associated with DNA Repair

### Xeroderma Pigmentosum

It is derived from the Greek terms xeres = dry and derma = skin. It is an autosomal recessive condition. Defect lies in the NER (**nucleotide excision repair**) mechanism. There are seven xeroderma pigmentosum (XP) genes (A to G) necessary for NER mechanism in humans. Mutation in any one of them may lead to the condition XP. UV light (sunlight) causes formation of thymine dimers, where covalent bonds are formed between adjacent thymine residues. Since repair mechanism is not operating, these mutations are accumulated, leading to cancer. There is the sensitivity to ultraviolet rays; sunlight causes blisters on the skin. Avoiding sunlight and using sunscreen ointment will be beneficial. Patients with XP have a 1000-fold greater chance of developing skin cancer than do normal persons. Death usually occurs in the second decade of life due to squamous cell carcinoma of skin. Prenatal diagnosis of XP is possible.

### Ataxia Telangiectasia

It is a common autosomal recessive disease. Sensitivity to UV, cerebellar ataxia, telangiectasia in eyes and lymphoreticular neoplasms are common. Ataxia telangiectasia mutated (ATM) gene is located at chromosome 11q. The mutated gene is present in 1% of total population. The disease is manifested in 1:40,000 persons. Other such defects are summarized in Box 44.3.

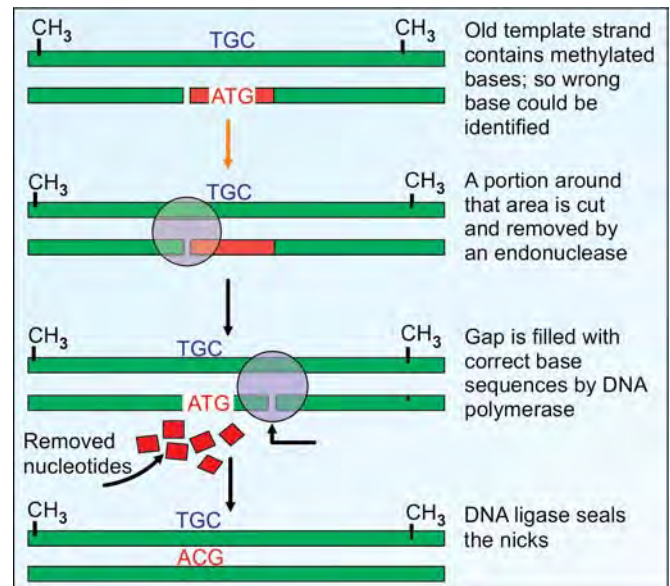


Fig. 44.17: Nucleotide excision repair (NER)

## Telomere and Telomerase

- i. The replication always takes place from 5' to 3' direction in the new strand. The DNA polymerase enzyme is not able to synthesize the new strand at the 5' end of the new strand. In other words, a small portion (about 300 nucleotides) in the 3' ends of the parent strands could not be replicated (Fig. 44.19).
- ii. This end piece of the chromosome is called **telomere**. Therefore another enzyme, *telomere terminal transferase* or **telomerase** takes up this job of replication of the end piece of chromosomes. The telomeres are noncoding repetitive sequences.
- iii. After the normal replication, there is only single strand in this region; so this portion is degraded by

### Box 44.3: Diseases associated with DNA repair mechanisms

**Xeroderma Pigmentosum (XP):** Defective NER mechanism; sensitivity to UV light; skin cancers

**Ataxia Telangiectasia (AT):** Defective ATM gene; sensitivity to UV light; lymphoreticular neoplasms

**Fanconi's Anemia (1927):** Defective genes are in chromosomes 20q and 9q. Defect in DNA cross link repair; increased occurrence of cancer

**Bloom's Syndrome (1954):** Gene is in 15q. Defect in DNA ligase or helicase; lymphoreticular malignancies

**Cockayne Syndrome (1946):** Defect in NER mechanism; transcription factor coupled repair, transcription factor II H is defective; stunted growth and mental retardation.

**Hereditary Polyposis Colon Cancer (Lynch syndrome):** Defective gene in chromosome 2. Defect in hMSH1 and 2 genes; mismatch repair is defective.

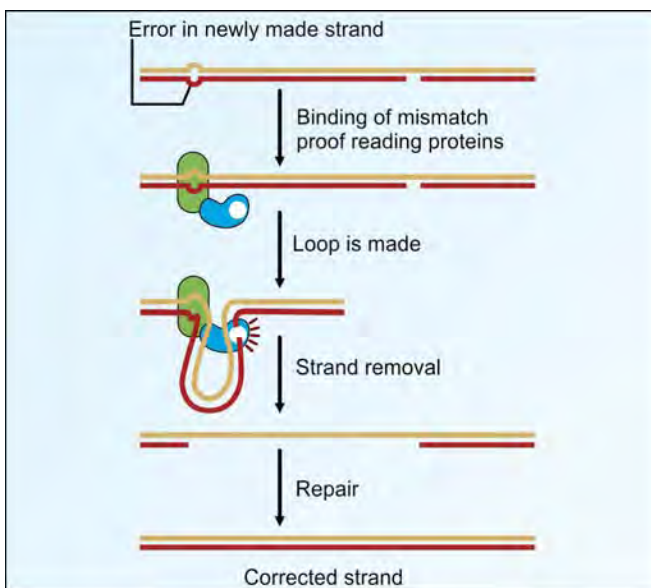


Fig. 44.18: Strand directed mismatch repair

exonucleases. This broken end leads to aberrant recombinations or end to end fusions. Unless there is some mechanism to replicate telomeres, the length of the chromosomes will go on reducing at each cell division. The stability of the chromosome is thus lost. Many genes might also be lost in the process.

- iv. The shortening of telomere end is prevented by an enzyme *telomere terminal transferase* or **telomerase**. It contains an RNA component, which provides the template for telomeric repeat synthesis.
- v. Telomerase acts like a reverse transcriptase. Telomerase recognizes 3' end of telomere, and then a small DNA strand is synthesized.
- vi. Terminal restriction fragments from 70-year old donors are shorter than those from 20-year-old ones. Thus, in **old age**, the telomerase activity is lost; leading to chromosome instability and cell death.

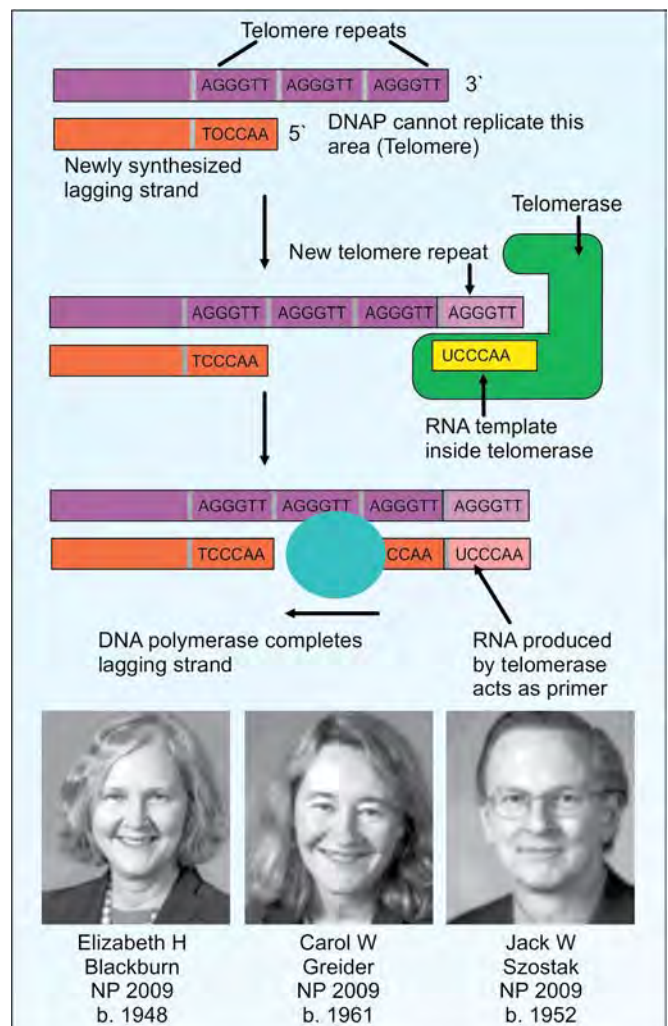


Fig. 44.19: During replication, there will be a gap at the 5' end of new strand. Telomerase is required to fill this gap

- vii. As a general rule, **cancer cells** have continued presence of telomerase, and the chromosome length equilibrium is maintained, leading to continued cell division. As cancer cells have increased and persistent activity of telomerase, the cancer cells become immortal. Telomerase is also implicated in other human diseases like diabetes, aplastic anemia, Bloom's syndrome, Fanconi's anemia and Ataxia telangiectasia. Elizabeth Blackburn, Carol Greider and Jack Szostak discovered the telomeres and telomerase, all the three were awarded Nobel prize in 2009.
- viii. Telomerase is a therapeutic target for cancer chemotherapy. Inhibition of telomerase can effectively control the multiplication of malignant cells. The use of antisense oligonucleotides against the RNA component of the telomerase arrests uncontrolled cell proliferation with minimum side effects.

## Hydrolysis of DNA

- Those enzymes which hydrolyze only from the end of the DNA molecule are called **exonucleases**.
- Those enzymes which hydrolyze the internal phosphodiester bonds are called **endonucleases**.
- Certain endonucleases cut at specific sequences of DNA; these "molecular scissors" are called **restriction endonucleases (RE)** (see Chapter 48).

## Inhibitors of DNA Replication

Certain compounds will inhibit bacterial enzymes, but will not affect human cells; such drugs are useful as anti-bacterial agents.

### Box 44.4: Inhibitors of DNA replication

Drug	Action (inhibition of)
<b>Antibacterial agents</b>	
Ciprofloxacin	Bacterial DNA gyrase
Nalidixic acid	do
Novobiocin	do
<b>Anticancer agents</b>	
Etoposide	Human topoisomerase
Adriamycin	do
Doxorubicin	do
6-mercaptopurine	Human DNA polymerase
5-fluoro uracil	Thymidylate synthase

Some other compounds will inhibit human enzymes, they will arrest new DNA synthesis, and arrest the cell division. Those drugs are therefore useful as anticancer agents. A list of such drugs is given in Box 44.4.

## QUICK LOOK OF CHAPTER 44

- DNA sequence is always written from the 5' end to 3' end. This is called polarity of the DNA chain.
- Chargaff's rule states that the number of purines is equal to the number of pyrimidines.
- The two strands run antiparallel to each other.
- Supercoiling of DNA is mediated by the enzymes topoisomerases and gyrases.
- DNA is assembled into nucleosomes.
- Histones are unusually rich in basic amino acids.
- Transcriptionally active chromatin is called 'euchromatin' and stains less densely as compared to 'heterochromatin' which is the inactive region of the chromatin.
- DNA replication *in vivo* is semiconservative.
- In mammals, the DNA polymerase is called alpha polymerase. There are five DNA polymerases. (alpha, beta, gamma, delta and epsilon)
- The DNA polymerase requires a RNA primer synthesized by RNA polymerase for initiation of its activity. This forms the first step in DNA synthesis.
- DNA synthesis is continuous on the leading strand and discontinuous on the lagging strand. This results in the formation of the replication fork.
- The small DNA molecules attached to their own RNA primers are called Okazaki fragments.
- Xeroderma pigmentosum is an autosomal recessive condition caused due to a defective nucleotide excision repair mechanism.
- In every replication the 3' end of the parent strands cannot be replicated. This end piece of the chromosome is called telomere. This shortening is prevented by telomerases.
- Telomerases have been implicated in aging process and cancers.

# CHAPTER 45

## Transcription

### Chapter at a Glance

The reader will be able to answer questions on the following topics:

- Ribonucleic acid
- Messenger RNA
- Transcription
- Post-transcriptional processing
- Reverse transcriptase

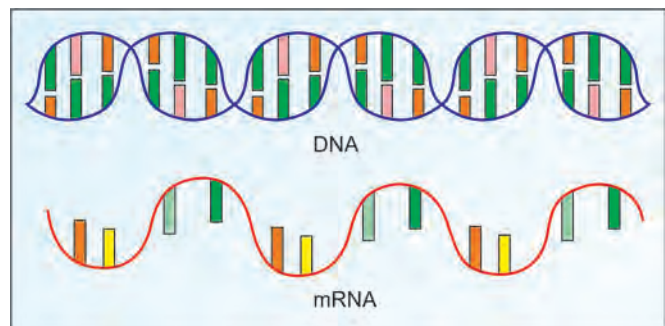
### RIBONUCLEIC ACID

Ribonucleic acid (RNA) is also a polymer of purine and pyrimidine nucleotides linked by phosphodiester bonds. However, RNA differs from DNA as shown in Table 45.1 and Figure 45.1. About 50% of cellular RNA is distributed in the ribosomes and endoplasmic reticulum; 25% in cytoplasm; 15% in mitochondria and the rest 10% in nucleus. Cellular RNAs are of five types:

- Messenger RNA (mRNA):** The gene present in DNA is transcribed into mRNA. This constitutes about 2–5% of total RNA in the cell. They are generally degraded quickly.
- Ribosomal RNA (rRNA):** This constitutes about 80% of all RNA in the cell. 28S, 18S and 5S are the major varieties. They are involved in protein biosynthesis and are very stable.

**TABLE 45.1:** Differences between RNA and DNA

RNA	DNA
1. Mainly seen in cytoplasm	Mostly inside nucleus
2. Usually 100–5000 bases	Millions of base pairs
3. Generally single stranded	Double stranded
4. Sugar is ribose	Sugar is deoxyribose
5. Purines: Adenine, guanine pyrimidines: cytosine, uracil	Adenine, guanine cytosine, thymine
6. Guanine content is not equal to cytosine and adenine is not equal to uracil	Guanine is equal to cytosine and adenine is equal to thymine
7. Easily destroyed by alkali	Alkali resistant



**Fig. 45.1:** DNA is double stranded, while RNA single stranded



- c. **Transfer RNA (tRNA):** There are about 60 different species present. They constitute about 15% of the total RNA in the cell. They are very stable.
- d. **Small RNA:** They constitute about 1–2% of total RNA in the cell. There are about 30 different varieties. They are very stable. **Small Nuclear RNAs (SnRNAs)** are a subgroup of small RNA. Some important species of SnRNAs are U1 (165 nucleotides), U2 (188 nucleotides), U3 (216), U4 (139), U5 (118), U6 (106). They are involved in mRNA splicing.
- e. **Micro RNA (miRNA):** They alter the function of mRNA. They are moderately stable. More details are given at the end of this chapter.

## Central Dogma of Molecular Biology

As shown in Figure 45.2, the information available in the DNA is passed to messenger RNA, which is then used for synthesis of a particular protein.

## Replication, Transcription and Translation

- i. DNA **replication** is like printing a copy of all the pages of a book. The replication process occurs only at the time of cell division.
- ii. Transcription can take place at any time but only certain selected regions of the DNA are copied. This is like taking xerox copy of particular page of the book. So, the genetic information in DNA is transcribed (copied) to the **messenger RNA (mRNA)**. During transcription, the message from the DNA is copied in the language of nucleotides (4 letter language).

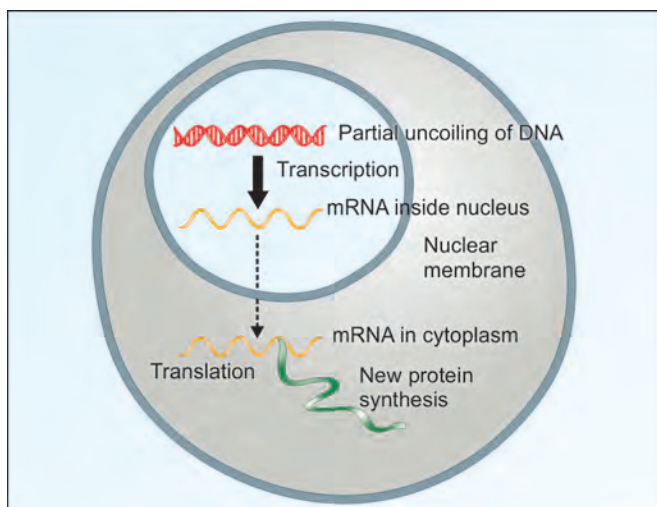


Fig. 45.2: Central dogma of molecular biology

- iii. The mRNA then reaches the cytoplasm where it is translated into functional proteins (Fig. 45.2). During **translation**, the nucleotide sequence is translated to the language of amino acid sequence (20 letter language) (Fig. 45.2).

## Template and Coding Strands

- i. The **template strand** is transcribed to give rise to mRNA. The template strand has the complementary sequence of mRNA.
- ii. The opposite strand has the same sequence as the mRNA. The DNA strand having the same sequence of mRNA is called **coding strand** (Fig. 45.3). As it is complementary to the template strand, it is also called **antitemplate strand** or **nontemplate strand**.

## Messenger RNA or mRNA

- i. The mRNA acts as a messenger transporting the information in the gene in DNA to the protein synthesizing machinery in cytoplasm. It carries the message to be translated to a protein.
- ii. The template strand of DNA is transcribed into a single stranded mRNA. This is accomplished by the DNA dependent **RNA polymerase**.
- iii. The mRNA is a **complementary** copy of the template strand of the DNA (Fig. 45.3).
- iv. However, thymine is not present in RNA; instead **uracil** will be incorporated.
- v. In the DNA, one strand will harbor certain genes, while others are borne by the other strand (Fig. 45.4).
- vi. A **transcription unit** is the region of DNA that includes not only the gene for mRNA synthesis, but also the initiator, promoter, and terminator regions as well as the introns. The mRNA that is initially produced is called **primary transcript**.

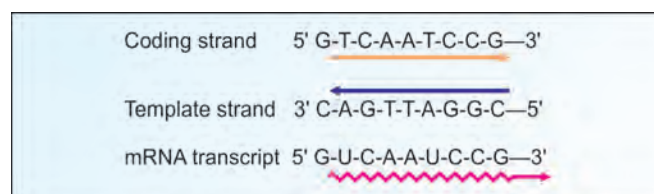


Fig. 45.3: Transcription. The mRNA base sequence is complementary to that of the template strand and identical to that of the coding strand. In mRNA, U replaces T

## TRANSCRIPTION PROCESS

Roger Kornberg got Nobel Prize in 2006 for his studies on molecular basis of transcription. He is the son of Arthur Kornberg (Nobel Prize 1959) who worked on DNA replication. Transcription includes initiation, elongation, and termination steps followed by post-transcriptional processing. A summary is shown in Figure 45.5.

### Mammalian RNA Polymerases

There are three different DNA dependent RNA polymerases (RNAP) in higher organisms. They have molecular weight 500-600 kDa.

- i. **RNAP type II or B** is the main enzyme synthesizing mRNAs. It is inhibited by alpha **amanitin** (a toxin from the mushroom *Amanita phalloides*). Amanitin blocks the translocation of RNAP during mRNA synthesis. SnRNA and miRNA are also synthesized by the same RNAP B. RNAP has two large and 12 smaller subunits. Phosphorylation activates RNAP II.
- ii. **RNAP type I or A** is responsible for synthesis of rRNA (ribosomal); it is not inhibited by amanitin.
- iii. **RNAP type III or C** is responsible for production of tRNA; it is moderately sensitive to amanitin.

### Bacterial RNA Polymerase

Bacterial RNAP enzyme contains two alpha, two beta subunits, one omega subunit and one sigma factor and two zinc molecules. Beta subunit fixes at the initiation site. The sigma factor recognizes the promoter site and increases the affinity of the holoenzyme to the promoter site.

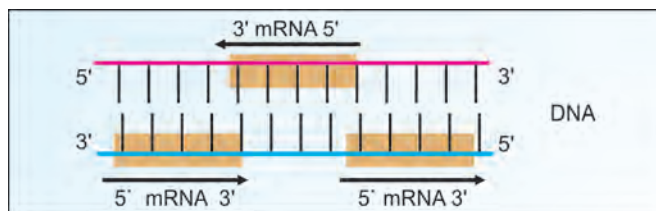
### Signals for Initiation of Transcription

#### Promoters

There are certain consensus sequences on DNA which act as start signals which may be located upstream or downstream from the start site. The RNAP attaches at the promoter site on the template DNA strand. In human beings, about  $10^5$  transcription initiation sites are present on the entire DNA.

#### TATA Box in Prokaryotes

In the case of bacteria, about 35 bp upstream of the transcription start site, there is a sequence of 5'-TGTTGACA-3'. About 10 bp upstream,



**Fig. 45.4:** Genes may be on any strand of DNA. Transcription is in 3' to 5' direction of the template

there is another sequence 5'-TATAAT-3'. The second one is referred to as *TATA box* or *Pribnow box*. The TATA box is not on template strand, but on coding strand.

#### Golberg-Hogness Box in Eukaryotes

In mammals, the exact sequence in TATA box is slightly different (TATAAA) and is known as *Goldberg-Hogness box*. This signal sequence located at -25 to -30 position indicates the start site. Further upstream, between -70 and -80, there is another sequence GGCCAATCT, known as CAAT box. These recognition signals are said to be **cis-acting**, as they are near to the gene.

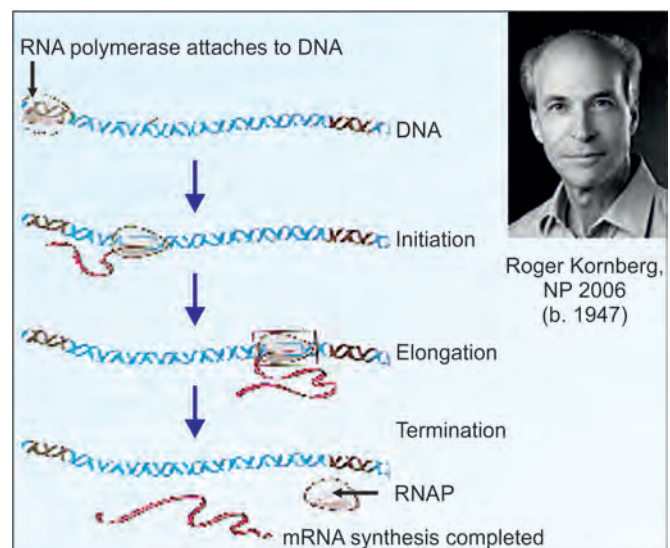
#### Enhancers and Silencers

Enhancers increase the rate of transcription and silencers decrease the rate. Other regulatory signals for transcription are hormone response elements (HRE) (see Chapter 50), repressors, inducers and derepressors (see Chapter 47). Insulators are sequences between silencers and enhancers that prevent interference between these sequences.

## Initiation of Transcription

### Bacterial System

- i. The starting point of transcription corresponds to the 5' nucleotide of the DNA, designated as +1. Then numbering is done 2, 3, 4 etc to the downstream region of the DNA. The nucleotide adjacent to downstream of the starting point is numbered as -1. Further upstream, these negative numbers are increased.
- ii. The DNA helix partially unwinds, and the RNAP binds with the promoter site on DNA with the help of sigma factor (Fig. 45.7). This is called **preinitiation**



**Fig. 45.5:** Transcription process

**complex (PIC)**. AT rich regions are separated more easily than GC rich regions on a DNA strand. Hence, these regions serve readily for transcription initiation, and serves as transcription recognition elements.

- iii. When it reaches the appropriate site on the gene, the first nucleotide of the mRNA attaches to the initiation site on the beta subunit of RNAP. This becomes the 5' end of the mRNA. It will be complementary to the base present in the DNA at that site. This is the **initiation of transcription**. Generally, a purine ribonucleotide is the first unit in the nascent mRNA.
- iv. The next nucleotide attaches to the RNAP. A phosphodiester bond is formed. Then the enzyme moves to the next base on the template DNA. (Fig. 45.6).
- v. After 10–20 nucleotides are polymerized, the RNAP undergoes conformational change, and moves away from the promoter region. This is called promoter clearance. Sigma factor is now released and the gene is fully transcribed.

### Mammalian System

In eukaryotes, the situation is more complex. There are at least 7 **transcription factors**, collectively called as Tf-II. First, the TATA box is recognized by TBP (**TATA binding protein**). Instead of the sigma factor, SL1 factor ensures that RNAP locates the start point. In humans about  $10^5$  transcription initiation sites are available.

The human TATA box binds **TATA-binding protein (TBP)**, which has many subunits. TBP-associated factors (TAF) bind with TBP to form TFIID. Binding of TFIID complex to the TATA box is the first step in the transcription process. Other proteins associated with the process are, TFIIA, B, E, F, H and polymerase II. The whole complex spans DNA from position -30 to +30. Moreover other proteins, known as **general transcription factors (GTFs)** facilitate promoter specific binding to form preinitiation complex in mammals. Three classes of transcription factors are involved in transcription of mammalian genes. These are:

- a. Basal components, such as TBP, TFIIA, B, E, F and H.
- b. Coregulators, such as TAFs, TFIID, Meds, Chromatin modifiers.
- c. Activators, such as SP1, ATF, AP1.

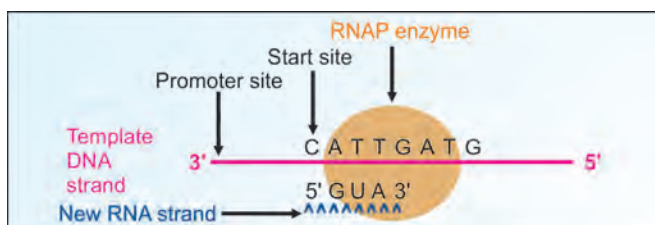


Fig. 45.6: Initiation of transcription

### Elongation Process of Transcription

- i. The RNAP moves along the DNA template. New nucleotides are incorporated in the nascent mRNA, one by one, according to the **base pairing rule** (Fig. 45.8). Thus, A in DNA is transcribed to U in mRNA; T to A; G to C and C to G.
- ii. The synthesis of mRNA is from 5' to 3' end. That means the reading of template DNA is from 3' to 5' (Fig. 45.3). This is analogous to the polarity in DNA synthesis.
- iii. As the RNAP moves along the DNA template, rewinding of the double helix occurs at the upstream areas. RNAP has DNA unwinding property. Topoisomerase will also help in this unwinding process. A **transcription bubble** containing RNAP, DNA and nascent RNA is formed (Fig. 45.7). This bubble is about 20 bp length.
- iv. RNAP has no nuclease activity; so there is no proof-reading. Hence, fidelity is less; mistake rate in mRNA transcription is  $10^4$  or  $10^5$  times more than DNA replication. But it is less serious, since these mistakes are not transmitted to the daughter cells or to the next generation.

### Termination of Transcription

The specific signals are recognized by a termination protein, the **Rho factor** (abbreviated with Greek letter, “ρ”).

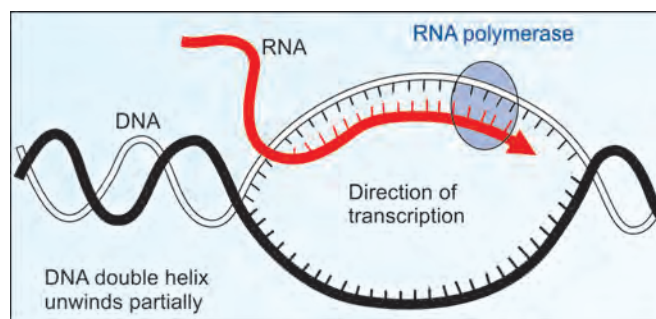


Fig. 45.7: DNA unwinds for transcription process

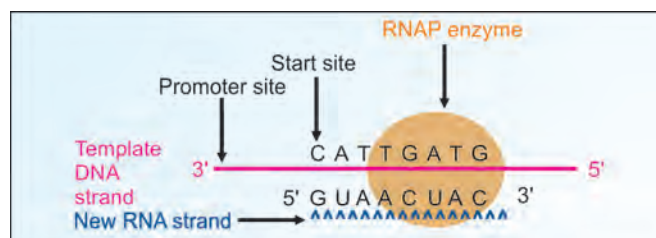


Fig. 45.8: Elongation process of transcription



A G-C rich palindrome sequence precedes the sequence of 6-7 U residues in the RNA chain. As a result, a stem and loop structure is formed upstream which is crucial for termination. Attachment of Rho factor is ATP dependent process. When it attaches to the DNA, the RNAP cannot move further. So, the enzyme dissociates from DNA and consequently newly formed mRNA is released (Fig. 45.9). Rho independent termination is also described.

In humans, the termination signals exist far downstream of the coding sequence, usually 1000 to 2000 bases away.

### Post-transcriptional Processing

- i. The mRNA formed and released from the DNA template is known as the **primary transcript**. It is also known as **heteronuclear mRNA** or hnRNA.
- ii. In mammalian system, it undergoes extensive processing to become the **mature mRNA**. These modifications are:
  - a. Poly-A tailing
  - b. 5' capping
  - c. Methylation
  - d. Removal of introns
  - e. Splicing of exons (connect together). These processings occur mainly in the nucleoplasm.
- iii. In bacteria, mRNA is not changed; and translation of mRNA starts even before completion of transcription.
- iv. Post-transcriptional processing is not only for mRNA but for tRNA and rRNA as well.

### Poly-A Tailing at 3' End

The 3' terminus is polyadenylated in the nucleoplasm (Fig. 45.8). This poly-A tail may be 20 to 250 nucleotides long. This tail protects mRNA from attack by 3' exonuclease.

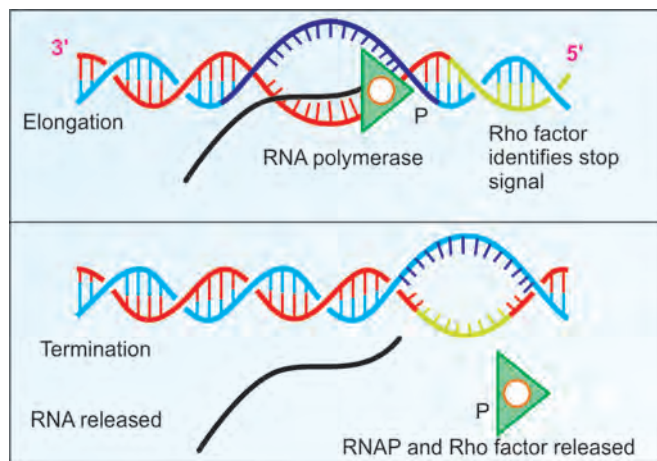


Fig. 45.9: Termination of transcription

### Capping at 5' End

Eukaryotic mRNAs are all 'capped' at the 5' terminus by **7-methyl guanosine triphosphate**. An unusual 5' to 5' triphosphate bridge is seen. This also happens inside the nucleus. The cap is useful in recognition of mRNA by the translating machinery.

### Methylations

Methylations of N6 of adenine residue and 2'-hydroxyl group of ribose are common. These are mainly done in the cytoplasm.

### Removal of Introns

- i. The primary transcripts are very long; they have molecular weights more than  $10^7$ . Molecular weight of mature mRNA is about  $1-2 \times 10^6$ . This means large portions of hnRNA are cleaved off.
- ii. The primary transcript contains coding regions (**exons**) interspersed with non-coding regions (**introns**).
- iii. These intron sequences are cleaved and the exons are **spliced** (combined together) to form the mature mRNA molecule. This processing is done in nucleus (Fig. 45.10). Splicing is an energy requiring process.



Sidney Altman  
NP 1989  
b. 1939

Thomas R Cech  
NP 1989  
b. 1947

Richard J Roberts  
NP 1993  
b. 1943

Phillip A Sharp  
NP 1993  
b. 1944

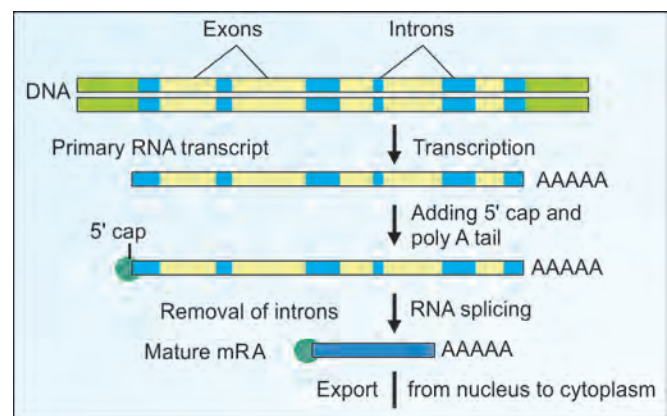


Fig. 45.10: Splicing process; removal of introns



### Small Nuclear RNAs (snRNAs)

Their size ranges from 90–300 nucleotides. They are named as U1, U2, U4, U5, U6 and U7. The U stands for the uracil rich nature of the snRNAs. They take part in the formation of spliceosomes. All of them are located in the nucleus. They complex with specific proteins, to form *small nuclear ribonucleoprotein particles (SnRNPs)*. It is pronounced as “**Snurps**”. Production of autoantibodies against “Snurps” is implicated in the pathogenesis of **systemic lupus erythematosus (SLE)**, a fatal autoimmune disease.

### Spliceosomes

SnRNPs associated with hnRNA at the exon-intron junction form spliceosomes. This is taking place inside the nucleus. Cuts are made at both ends of intron; it is removed; and exon-exon ends are ligated at G-G residues (Fig. 45.11). For elucidation of spliceosome activity, Richard Roberts and Phillip Sharp were awarded Nobel prize in 1993.

### Ribozymes

- i. *Enzymes made up of RNA are called ribozymes.* Ribozymes or RNA enzymes are catalytic RNA molecules with sequence specific cleavage activity. They also exhibit Michaelis-Menten kinetics. Thomas Cech and Sidney Altman discovered the ribozymes, for which they were awarded Nobel prize in 1989.
- ii. In the precellular era, nucleic acids were biological catalysts; and in course of evolution, proteins took up this activity. In that sense, the ribozymes are vestigial remnants.
- iii. **Spliceosomes** contain ribozymes as well as protein components which serve to stabilize the structure of ribozymes.
- iv. **RNAse-P** is another ribozyme, which generates the ends of tRNAs.
- v. **Peptidyl transferase** present in ribosomes (used for protein biosynthesis) is another example of ribozyme.

### Alternate Splicing

One form of gene regulation is the differential processing of mRNA. Suppose there are exons 1, 2 and 3. The splicing can be 1-2, 1-3, 2-3, etc. In one type of beta thalassemia, there is a mutation in the exon-intron junction, so that one intron is not removed, leading to absent synthesis of beta chain. The sequence of glucokinase (*GK*) gene has 10 exons and 9 introns. But expression of *GK* gene is regulated differently in liver and pancreas, because of 2 different promoters in these two tissues; these are produced by differential splicing of exons. Alternative splicing has been identified in the case of at least 40 different genes. So, calcitonin



Howard Temin  
NP 1975  
1934–1994



David Baltimore  
NP 1975  
b. 1938



Robert Holley  
NP 1968  
1922–1993

gene yields an RNA that synthesizes calcitonin (thyroid) or calcitonin-gene related peptide (CGRP, in brain). Alternative splicing in the  $\alpha$  tropomyosin transcript produces 8 different mRNAs.

### Alternate Editing of mRNA

*ApoB* gene is transcribed into an mRNA that leads to synthesis of 100 kDa protein in liver, which is called *apoB100*. In intestine the same primary transcript is formed; but a cytidine deaminase converts a CAA codon in the mRNA into UAA codon; thus codon for glutamine is changed to a termination codon. Thus 49 kDa protein is resulted; this is *apoB48*.

### Untranslated Regions of mRNA

Protein synthesis is often regulated at the level of initiation of translation, making it a critical step. This regulation occurs by both the cis-regulatory elements, which are located in the **5'- and 3'-UTRs (untranslated regions)**, and trans-acting factors. A breakdown in this regulation machinery can perturb cellular metabolism, leading to various physiological abnormalities. The highly structured UTRs, along with features such as GC-richness, upstream open reading frames and internal ribosome entry sites, significantly influence the rate of translation of mRNAs. Changes in the cis-regulatory sequences of the UTRs, for example, point mutations and truncations, influence expression of specific genes at the level of translation. Such modifications may tilt the physiological balance from healthy to diseased states, resulting in conditions, such as hereditary thrombocytopenia, breast cancer, fragile X syndrome, bipolar affective disorder and Alzheimer's disease. This shows the crucial role of UTRs, perhaps as much as that of coding sequences, in health and disease.

### Reverse Transcriptase

- i. Generally speaking, the genes are made up of DNA. Usually, DNA dependent RNA polymerase transfers the information of DNA to mRNA. However genetic

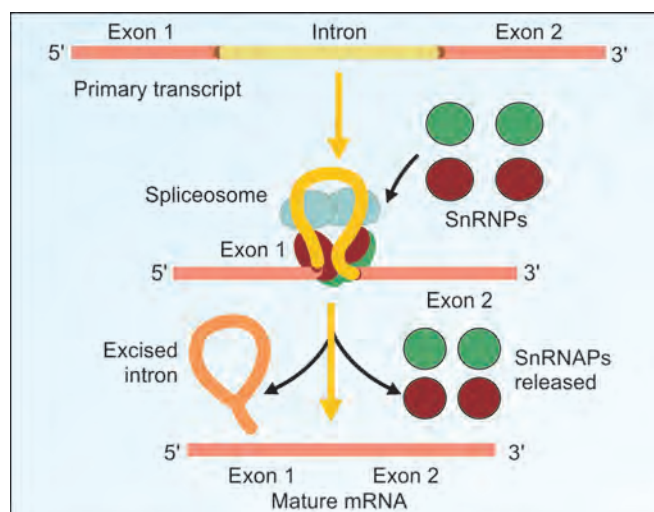


Fig. 45.11: Spliceosome excise intron

material of some animal and plant viruses is made up of RNA.

- ii. **Retrovirus** is a subgroup of RNA viruses. The human immunodeficiency virus (**HIV**) causing AIDS is a retrovirus. Here the RNA acts as a template. Based on this RNA, the enzyme, *RNA dependent DNA polymerase* or *reverse transcriptase* will make a new DNA strand. Temin and Baltimore isolated this enzyme in 1970 and they were awarded the Nobel prize in 1975.
- iii. From the RNA-DNA hybrid, the RNA part is hydrolysed by a specific **RNAse-H**. The remaining DNA acts as a template to produce double stranded

DNA. Thus genetic information is transferred from RNA to DNA (Fig. 45.12).

- iv. Some of the **tumor viruses** were also shown to possess reverse transcriptase. The presence of the enzyme may be taken as an indication of a retrovirus infection.

### Inhibitors of RNA Synthesis

*Actinomycin D* and *Mitomycin* intercalate with DNA strands, thus blocking transcription. They are used as anticancer drugs. *Rifampicin* is widely used in the treatment of tuberculosis and leprosy (Natural antibiotic rifamycin is produced from streptomyces). Other inhibitors of RNA synthesis are shown in Table 45.2.

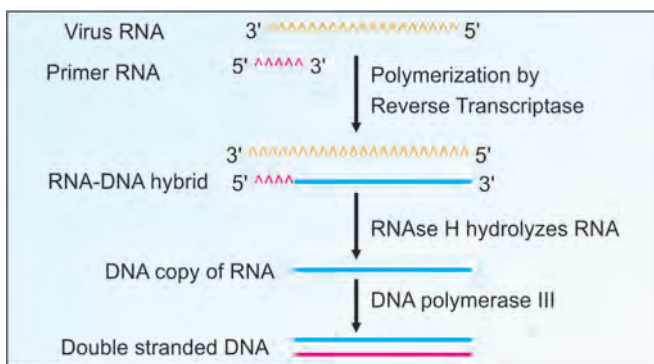


Fig. 45.12: Action of reverse transcriptase

TABLE 45.2: Inhibitors of RNA synthesis

Inhibitor	Source	Mode of action
Actinomycin-D	Antibiotics from streptomyces	Insertion of phenoxa-zone ring between two G-C bp of DNA
Rifampicin	Synthetic derivative of Rifamycin	Binds to beta subunit of RNA polymerase which is inactivated
Alpha amanitin	Toxin from mushroom	Inactivates RNA polymerase II
3' -deoxy adenosine	Synthetic analog	Incorrect entry into chain causing chain termination

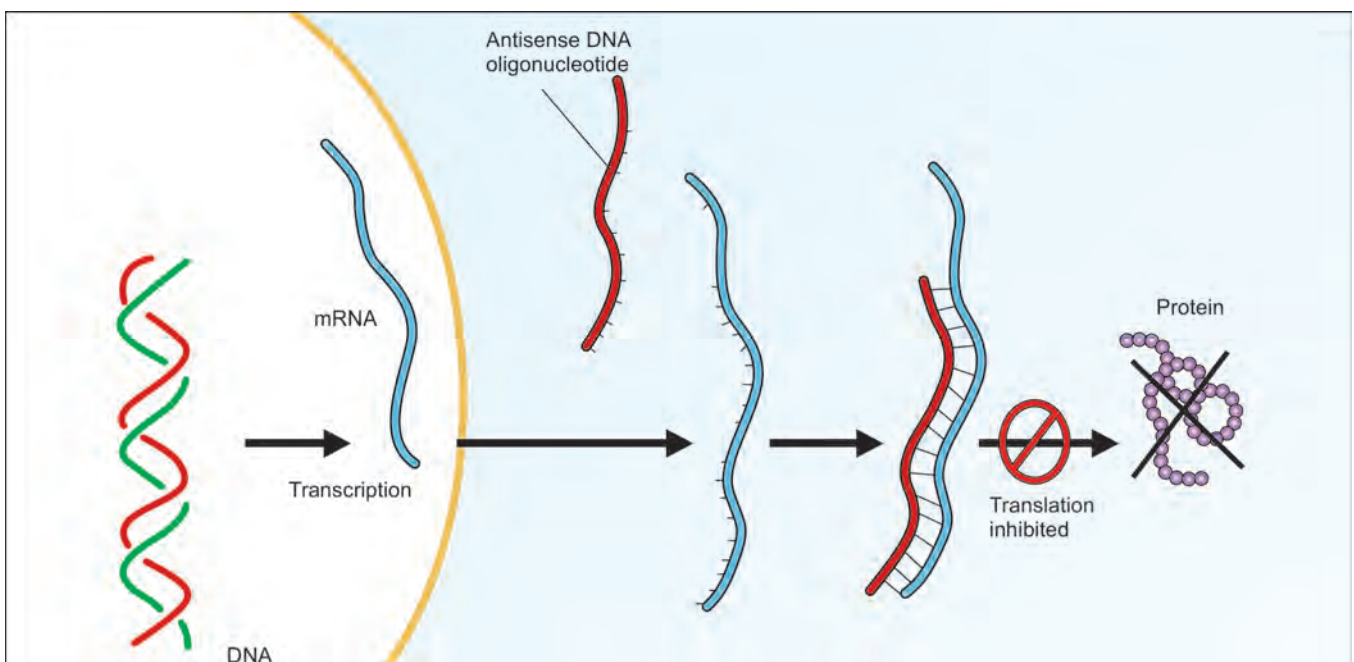


Fig. 45.13: Principle of anti-sense therapy

## Micro-RNA, Interfering RNA and RNA silencing

### Micro-RNA

Some genes produce tiny RNAs, known as **micro-RNAs** or **miRNA**, which are about 21 to 25 bases in length. There are more than 200 miRNAs found in human beings.

MicroRNAs are derived from large primary transcripts through specific nucleolytic processing. Primary transcripts are produced, then inside the nucleus, certain exonucleases reduce their length. They have RNA hairpin structure (showing internal hybridization to make it two strands), and are called **short hairpin RNA (shRNA)**. These are transported through nuclear pore into cytoplasm, where out of the two strands, one is broken by **dicer nuclease**. The selected strand is called the **guide strand**, which is incorporated into the RISC (**RNA induced silencing complex (RISC)**) to form functional silencer of mRNA. The guide strand provides specificity to RISC, which binds and then degrades complementary target mRNA in the cytoplasm.



Andrew Fire  
NP 2006  
b. 1959



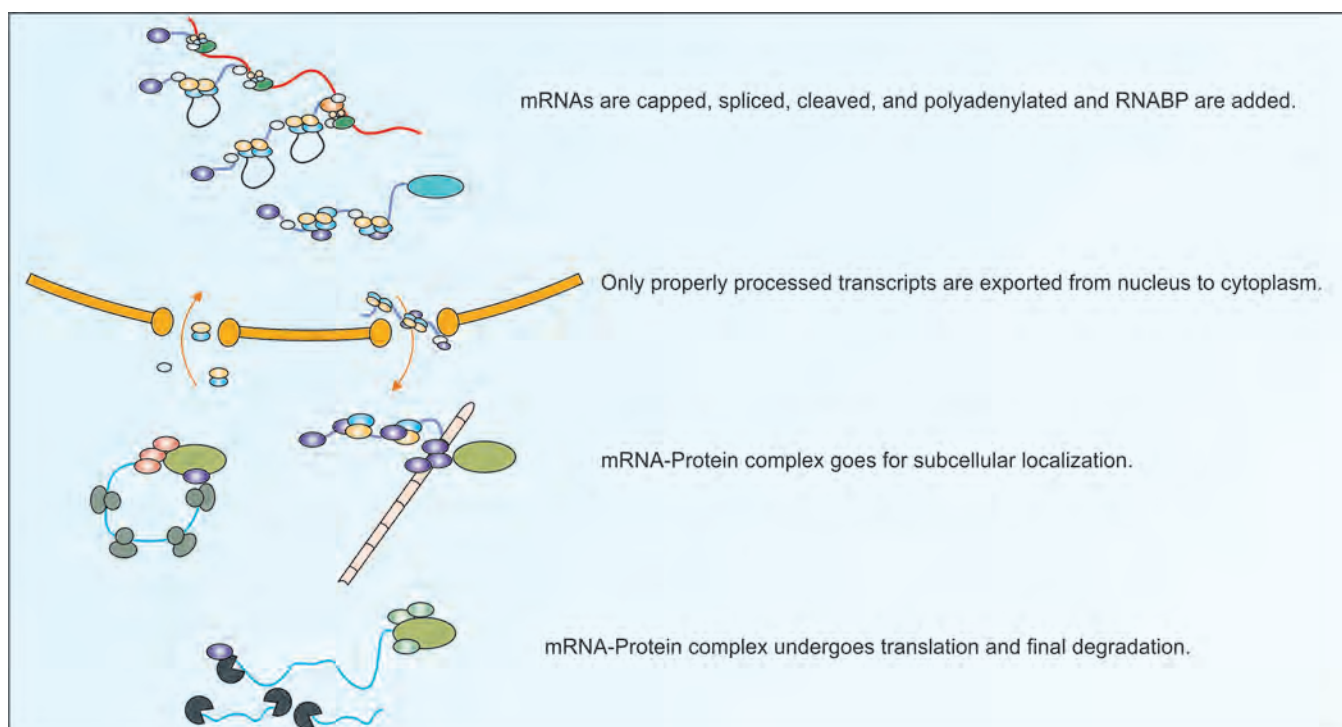
Craig Mello  
NP 2006  
b. 1960

The micro-RNAs bind to matching pieces of messenger RNA, turn it into a double strand and prevent it from doing its job. The process effectively blocks the production of the corresponding protein, causing translation arrest (Fig. 45.14).

### Interfering RNA or RNAi or siRNA

Andrew Fire and Craig Mello found that when double-stranded RNA was given to round worms, it would silence the gene corresponding to that RNA. They were awarded Nobel Prize in 2006. RNA interference is a protective mechanism against viruses, which sometimes create double-stranded RNA when they replicate. Short double-strand RNA, again about 21 to 25 bases, would silence the corresponding gene. RNAi is a faster way to turn off genes. Both RNAi and micro-RNA result in decreased levels of functional proteins in the cells. RNAi degrades the mRNA through specific cytoplasmic organelles called P bodies. (Micro-RNA reduces the translation of mRNA into protein). Scientists are aiming to use RNA interference to treat diseases, especially HIV infection.

RNA interference (RNAi) is a naturally occurring biological pathway in which small, double-stranded RNA molecules suppress gene expression in an exquisitely sequence-specific manner. Exogenous manipulation of RNAi is being explored as a powerful method of silencing disease-causing genes in incurable neurological disorders. Preclinical trials in animal models of various neurodegenerative diseases have demonstrated the feasibility and efficacy of this approach.



**Fig. 45.14:** The mRNA is regulated by mRNA-binding proteins. In the nucleus, transcripts are capped, spliced, cleaved, and polyadenylated by RNA-binding proteins that interact with the nascent transcript co- and posttranscriptionally

### Antisense Therapy

The mRNA contains a message or “sense” to be translated into protein. If a nucleotide having complementary sequence to an mRNA is made, it is said to be “antisense”. When antisense oligonucleotide (either RNA or DNA) is added, it will trap the normal mRNA and so protein biosynthesis can be stopped. This is called antisense strategy. (Fig. 45.13). Small oligo nucleotides (about 7 to 10 nucleotides length) can act as antisense molecules. The antisense nucleotides are delivered into the cells by liposome encapsulation. Clinical trials on HIV and cancer are being conducted using antisense molecules.

### QUICK LOOK OF CHAPTER 45

1. Template strand of the DNA is transcribed to mRNA.
2. RNAP type II or B is the enzyme synthesizing RNA in mammals. It is susceptible to amanitin.
3. A transcription bubble contains RNA polymerase, DNA and nascent RNA.
4. Termination of transcription can be Rho factor dependent or independent.
5. Post-transcriptional processing of the primary RNA transcript includes poly-A tailing at 3' end, capping at 5' end, methylation and intron splicing.
6. Ribozymes are enzymes made up of RNA. Examples are RNase P, peptidyl transferase and spliceosomes.
7. Reverse transcriptases are RNA dependent DNA polymerases. They synthesize a DNA strand using RNA as their template. Retroviruses such as HIV and tumor viruses possess this enzyme.



# CHAPTER 46

## Genetic Code and Translation

### Chapter at a Glance

The reader will be able to answer questions on the following topics:

- Transfer RNA
- Ribosomal RNA
- Genetic code
- Protein biosynthesis
- Post-translational processing
- Inhibitors of protein synthesis
- Mitochondrial DNA

### PROTEIN BIOSYNTHESIS

Synthesis of proteins are based on the genetic information present on the DNA which is transcribed into the mRNA nucleotide sequence and then translated to the amino acid sequence of the polypeptide chain. The mRNA encodes the information, the tRNA transports the amino acid and ribosomes provide the platform for the protein synthesizing machinery. Transfer RNA and ribosomal RNA (non-coding RNA) are transcribed from specific genes on DNA by RNA polymerases. This is summarized in Figure 46.1.

### Transfer RNA (tRNA) or (sRNA)

- They transfer amino acids from cytoplasm to the ribosomal protein synthesizing machinery; hence the name transfer RNA. RNA Polymerase III transcribes tRNA.
- Since, they are easily soluble, they are also referred to as **soluble RNA** or sRNA. They are RNA molecules present in the cytoplasm.
- Each molecule is only 73–93 nucleotides in length; much shorter than mRNA molecules.

- When transcribed, the tRNA molecules are large and they undergo post-transcriptional modifications.

### Structure of tRNA Molecule

- The transfer RNAs show extensive internal base pairing and acquire **clover leaf** like structure (Fig. 46.2A).
- They contain a significant proportion of **unusual bases**. These include dihydrouracil (DHU) (see Fig. 43.4), pseudouridine ( $\psi$ ) (see Fig. 43.9), and hypoxanthine (see Fig. 43.2). Moreover, many bases are methylated.

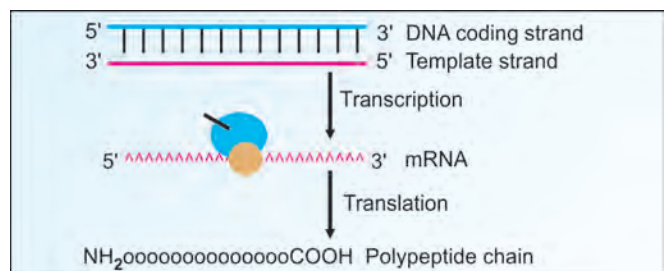


Fig. 46.1: Expression of a gene into a protein

### Acceptor Arm is at the 3' End

It carries the amino acid (Fig. 46.2A). This area has 7 base pairs. The end sequence is **CCA-3'**. The 3' end hydroxyl group is forming an ester bond with the carboxyl end of amino acids.

### Anticodon Arm of tRNA

At the opposite side of the acceptor arm is the anticodon arm (Fig. 46.2B). It recognizes the triplet nucleotide codon present in mRNA. The specificity of tRNA resides in the

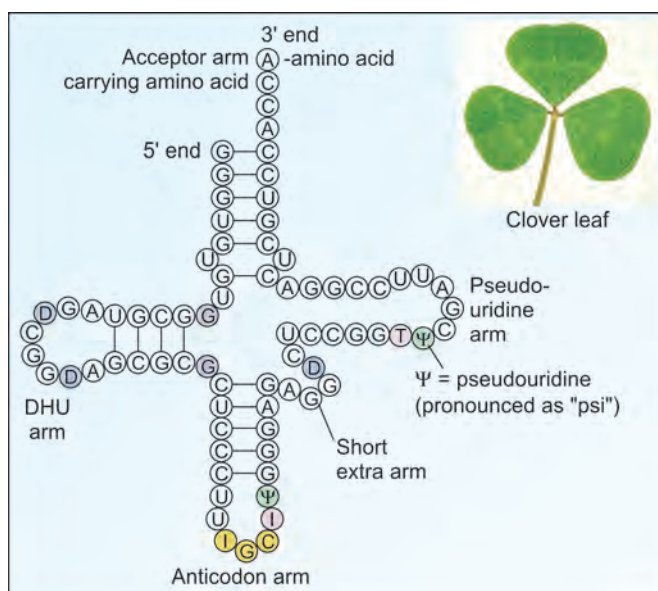


Fig. 46.2A: Transfer RNA general structure

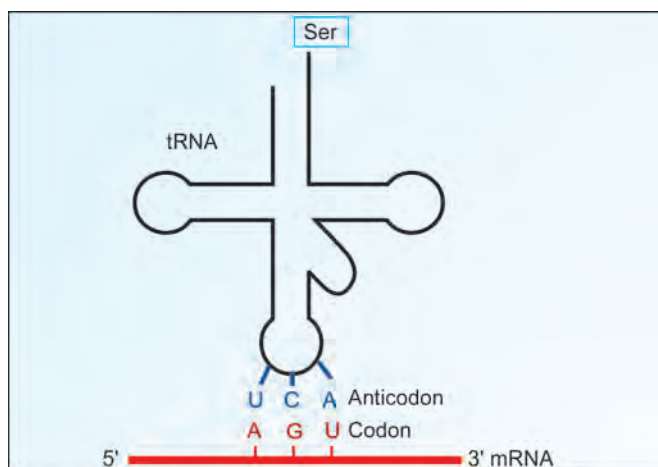


Fig. 46.2B: Transfer RNA carrying serine

anticodon site, which has *base sequences complementary to that of mRNA codon*.

For example, if the mRNA has a codon with the sequence UUU, the anticodon sequence of the tRNA will be AAA, by which it base pairs with mRNA codon. So, the specific tRNA can bind correctly to the mRNA codons. In this case, the **UUU codon is translated as phenylalanine**. Recognition of codon by the tRNA anticodon is illustrated in Figure 46.2B.

The tRNA molecule will show specificity in both aspects; in recognizing the mRNA codon as well as in accepting the specific amino acid coded by that codon. In this way the tRNA molecules play a pivotal role in translation.

The tRNAs act as **adapter molecules** between mRNA and the amino acids coded by it. The nucleotides of codons have no affinity for amino acids. So, the tRNA molecules act as mediators between the mRNA and amino acids. Methionine-tRNA was isolated by Paul Berg in 1956 (Nobel Prize, 1980). The complete sequencing of alanine-tRNA was done by Robert Holley in 1963 (Nobel prize, 1968). Khorana (Indian born US scientist) got Nobel Prize in 1968, for synthesizing the gene for alanine tRNA.

### DHU Arm of tRNA

The D arm or DHU region is so named due to the presence of a **dihydrouridine** in that area (Fig. 46.2A). The DHU arm serves as the recognition site for the enzyme which adds the amino acid.

### Pseudouridine Arm of tRNA

The opposite arm is called pseudouridine arm, as it contains a pseudouridine. It is generally denoted with the Greek alphabet “ $\psi$ ” which is pronounced as “psi” (Fig. 46.2A). It is involved in binding tRNA to ribosomes. About 75% of tRNA molecules possess a short extra arm, about 3 to 5 base pairs long and they belong to Class 1. The tRNA molecules belonging to Class 2, have a long extra arm, 13 to 21 base pairs in length.

### Processing of tRNA

The tRNA is synthesized as a long precursor and is trimmed by Ribonuclease P, a ribozyme. The CCA sequence is added at 3' end and bases are modified.

## Ribosomal RNA (rRNA)

Ribosomes provide necessary infrastructure for the mRNA, tRNA and amino acids to interact with each other for the translation process. Thus ribosomal assembly is the **protein synthesizing machinery**. Nucleolus is the area where rRNA is synthesized and ribosomal assembly is produced. For studies on structure and function of ribosomes, Nobel prize was awarded in 2009 to Venkataraman Ramakrishnan (born in India), Ada Yonath and Thomas Steitz. Ribosomal RNA is synthesized by RNAPI.

### Components of rRNA

The mammalian ribosome has a sedimentation constant of **80S unit**. It has a larger **60S subunit** and another smaller **40S subunit**. They contain different rRNAs and specific proteins. Ribosomal RNA has catalytic activity. Peptidyl transferase activity is carried out by 28 S RNA which acts as a ribozyme.

### Bacterial Ribosomes are Different

Bacterial ribosomes are smaller than mammalian ones. Bacteria has 70S ribosomes; with 30S and 50S subunits. So, many antibiotics will inhibit bacterial protein synthesis, but will do no harm to human cells. See end of this Chapter.

### Processing of rRNA

The rRNA is also synthesized as a 45S precursor which is cleaved to 28S, 18S, 5.8S and 5S rRNAs. The large ribosomal subunit has 28S, 5.8S and 5S rRNA and small ribosomal subunit has only 18S rRNA.

## Genetic Code

A triplet sequence of nucleotides on the mRNA is the codon for each amino acid. Since, there are four different bases, they can generate 64 ( $4^3$ ) different codons or code words by permutations and combinations. For example, the codon for phenylalanine is UUU. Nirenberg was awarded the Nobel prize in 1968 for deciphering the genetic code. There are 31 tRNA species, carrying 20 amino acids, which translate 61 codons. Important features of genetic code are shown in Box 46.1.

## Salient Features of the Genetic Code

### Triplet Codons

The codons are on the mRNA. Each codon is a consecutive sequence of three bases on the mRNA, e.g. UUU codes for phenylalanine (Table 46.1).

### Non-overlapping

The codons are consecutive. Therefore, the starting point is extremely important. The codons are read one after another in a continuous manner, e.g. AUG, CAU, GAU, GCA, etc.

### Non-punctuated

There is no punctuation between the codons. It is consecutive or continuous.

### Degenerate

Table 46.1 shows that 61 codons stand for the 20 amino acids. So, **one amino acid has more than one codon**. For example, Serine has 6 codons; while glycine has 4 codons. This is called degeneracy of the code. In general, if the amino acid has more than one codon, the first two bases in the codon will be the same, only the third one is different. This reduces the effect of mutations.

### Unambiguous

Though the codons are degenerate, they are unambiguous; or without any doubtful meaning. That is, one codon stands only for one amino acid.

### Universal

The codons are the same for the same amino acid in all species; the same for “Elephant and *E.coli*”. The genetic codon has been highly preserved during evolution.

#### Box 46.1: Salient features of genetic code

1. Triplet base sequence
2. Non-overlapping
3. Non-punctuated
4. Degenerate
5. Unambiguous
6. Universal



Paul Berg  
NP 1980  
b. 1926



Har Gobind Khorana  
NP 1968  
1922–2011



Marshall W Nirenberg  
NP 1968  
1927–2010



Gunter Blobel  
NP 1999  
b. 1936

### Wobbling Phenomenon

The reduced stringency between the third base of the codon and the complementary nucleotide in the anticodon is called *wobbling*. The pairing of codon and anticodon **can wobble at the third letter**. For example, GGU, GGC and GGA are the codons for glycine; all three will pair with the anticodon CCI (I = Inosinic acid) of glycine-tRNA. The degeneracy of genetic code and wobbling phenomenon together will reduce the possibility of mutations. Wobble positions in codon and anticodon interactions.

```

C A G U
G U C A
I I U G
      I
  
```

wobble nucleotides of the codon (in upper line) and the associated wobble nucleotides of the anticodon (in 2nd, 3rd or 4th line).

### Terminator Codons

There are three codons which do not code for any particular amino acid. They are “nonsense codons”, more correctly termed as *punctuator codons* or *terminator codons*. They mark end of protein synthesis. These three codons are UAA, UAG, and UGA. UGA is a stop codon; but in special circumstances, it stands for **seleno-cysteine** (the “21st” amino acid).

### Initiator Codon

In most of the cases, AUG acts as the initiator codon. AUG also acts as the codon for methionine. In a few proteins, GUG may be the initiator codon.

### Mitochondria Have Different Codons

The protein synthesizing machinery of mitochondria is distinct from that in the cytoplasm. There are only about 22 tRNAs in mitochondria; but there are 31 tRNA species in cytoplasm. The discovery of difference in codons representing different amino acids in mitochondria has now changed the ‘universal’ nature of the genetic code. For example, UGA is a terminator codon in nuclear DNA, but codes for arginine in mitochondrial DNA.

**TABLE 46.1:** Triplet codons and corresponding amino acids

First nucleotide 5' end	Second nucleotide				Third nucleotide 3' end
	U	C	A	G	
U	Phe	Ser	Tyr	Cys	U
	Phe	Ser	Tyr	Cys	C
	Leu	Ser	Stop	Stop	A
	Leu	Ser	Stop	Trp	G
C	Leu	Pro	His	Arg	U
	Leu	Pro	His	Arg	C
	Leu	Pro	Gln	Arg	A
	Leu	Pro	Gln	Arg	G
A	Ile	Thr	Asn	Ser	U
	Ile	Thr	Asn	Ser	C
	Ile	Thr	Lys	Arg	A
	Met	Thr	Lys	Arg	G
G	Val	Ala	Asp	Gly	U
	Val	Ala	Asp	Gly	C
	Val	Ala	Glu	Gly	A
	Val	Ala	Glu	Gly	G

## TRANSLATION PROCESS

Translation is a cytoplasmic process. The mRNA is translated from **5' to 3' end**. In the polypeptide chain synthesized, the first amino acid is the amino terminal one (Fig. 46.1). The chain growth is from amino terminal to carboxyl terminal. The process of translation can be conveniently divided into the phases of:

- Activation of amino acid
- Initiation
- Elongation
- Termination
- Post-translational processing.



Thomas A Steitz  
NP 2009  
b. 1940



Ada E Yonath  
NP 2009  
b. 1939

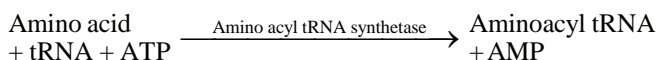


Venkatraman  
Ramakrishnan  
NP 2009  
b. 1952



## Activation of Amino Acid (Charging Reaction)

- The enzymes **aminoacyl tRNA synthetases** activate the amino acids. The enzyme is highly selective in the recognition of both the amino acid and the transfer RNA acceptor. There is at least one tRNA for each of the 20 amino acids.
- The D arm of tRNA is very important for the recognition by the enzyme. The CCA 3' terminus of the acceptor arm carries amino acid (Fig. 46.2A and B).
- Amino acid is first activated with the help of ATP. Then the carboxyl group of the amino acid is esterified with 3' hydroxyl group of tRNA.



This is a two-step reaction. First reaction is the formation of AMP-amino acid-enzyme complex. In the second reaction, this activated amino acid is transferred to the corresponding tRNA molecule. The AMP and enzyme are released.

- In this reaction, ATP is hydrolyzed to AMP level, and so two high energy phosphate bonds are consumed.

## Initiation of Protein Synthesis

Initiation can be studied as 4 steps: 1. Recognition steps. 2. Formation of pre-initiation complex, i.e. binding of ternary complex of met-tRNA, GTP and eIF-2 to 40S ribosome. 3. Binding of mRNA to the pre-initiation complex to form 43S initiation complex. 4. The 43S initiation complex is combined with the 60S ribosomal subunit to form 80S initiation complex.

### Recognition Steps

In eukaryotes, the first amino acid incorporated is methionine (AUG codon). But in prokaryotes, the same codon stands for N-formyl methionine, which is the first amino acid.

The first AUG triplet after the marker sequence is identified by the ribosome as the start codon. In mammalian cells, the marker is the “**Kozak**” sequence; in bacteria, it is the “**Shine-Dalgarno**” sequence. Shine-Dalgarno element is found on the 5' side of each initiator AUG codon in prokaryotic polycistronic mRNAs. This element is complementary to sequences present near the 3'-end of the 16S rRNA of the prokaryotic ribosome. For the process, **initiation factors** (eIF) are required; their properties are summarized in Table 46.2. The letter “e” is shown to differentiate eukaryotic initiation factors from those of prokaryotic factors. Shine-Dalgarno element is found at the 5' side of each initiator AUG codon in prokaryotic polycistronic mRNAs. This element is complementary to sequences present near the 3'-end of the 16S rRNA of the prokaryotic ribosome.

**Poly-A tail** of the mRNA and its binding protein, PAB1 are also important for the recruitment of 40S ribosomal subunit to the mRNA. PAB1 attaches to the poly-A tail, then interacts with eIF-4F that is bound to the cap of mRNA. This helps in the attachment of 40S ribosomal subunit to the 5' end of mRNA.

### Formation of 43S Pre-initiation Complex

**GTP, IF-2, met-tRNA** (tRNA carrying methionine) and **40S ribosomal** subunit are complexed to form **pre-initiation** complex (Fig. 46.3). This is the 43S pre-initiation complex. This is stabilised by eIF-3 and eIF-1A. Met-tRNA has the anticodon UAC.

There are 2 tRNAs for methionine; one for methionine for the initiator codon; the second one for methionine in the internal part of proteins. IF-2 is a control point for protein synthesis. It has 4 subunits; the alpha unit is phosphorylated by different protein kinases. During viral infection, these kinases are activated, and protein synthesis as a whole (including viral proteins) is inhibited.

This pre-initiation complex binds with mRNA; the 5' methylated cap of mRNA facilitates this binding. **Initiation factors** 4A, 4B, 4E, 4F and 4G are necessary for this binding. It also requires energy from hydrolysis of **ATP**. This forms initiation complex (Fig. 46.3).

IF-3 binds with 4F and links the complex with 40S subunit of ribosome. The 4E is important in controlling the rate of protein translation. The 4E is responsible for recognition of the mRNA cap, and this is the **rate limiting step** in the whole of translation process. Insulin and growth factors phosphorylate one serine residue of the 4E.

**TABLE 46.2: Eukaryotic protein factors**

Name	Approx. mol. wt. x 10 <sup>3</sup>	No. of subunits	Function
eIF-1	15	1	mRNA binding to 40S
eIF-2	150	3	met-tRNA binding to 40S
eIF-3	700	9	prevents reassociation of ribosomal subunits
eIF-4A	50	1	mRNA binding
eIF-4B	80	1	mRNA binding
eIF-4G		1	mRNA binding
eIF-4F	363	4	mRNA binding
eIF-4E	24	1	recognition of mRNA cap
eIF-5	150	1	association of 40S and 60S subunits of mRNA
EF-1	85	3	binding of aminoacyl tRNA
EF-2	100	1	translocation
RF	105	2	release of polypeptide

Phosphorylated 4E avidly binds the cap of mRNA, so that translation is enhanced. The anabolic effect of insulin, enhancing protein synthesis is by removing the inhibition of e-IF 4E.

The regulation of rate of translation in cells is primarily through regulation of 4E, at the level of transcription, post-translational modification and inhibition of interaction with other proteins. Progression of cell cycle, signal transduction pathways acting through RAS gene and the MAP kinase pathway are all regulated by their effects on 4E phosphorylation. The interaction of binding proteins is also affected by phosphorylation.

### Formation of 80S Ribosomal Assembly

The 43S initiation complex now binds with **60S** ribosomal unit to form the full assembly of **80S ribosome**. This needs hydrolysis of **GTP**; this hydrolysis is effected by IF-2 and IF-5. Then all initiation factors are released from 48S initiation complex (Fig. 46.3). See also Box 46.2.

**P and A Sites of Ribosomal Assembly:** The whole ribosome contains two receptor sites for tRNA molecules. The “P” site or **peptidyl site** carries the peptidyl-tRNA. It carries the growing peptide chain. The “A” site or **aminoacyl site** carries the new incoming tRNA with the amino acid to be added next. When the 80S ribosome is assembled, the tRNA-Met is now at the P site. The anti-codon of met-tRNA is correctly base pairing with the AUG codon on mRNA (Figs 46.3 and 46.4). A third site (E site) or exit site is occupied by the deacylated tRNA.

### Elongation Process of Translation

Elongation has 3 steps: 1. Binding of amino acyl tRNA to the A site. 2. Peptide bond formation and 3. Translocation of the ribosome on the mRNA.

### Binding of New Amino Acyl tRNA

A new aminoacyl tRNA comes to the “A” site. The next codon in mRNA determines the incoming amino acid. **Elongation factor-1 (EF-1)** (Table 46.2) and **GTP** are complexed with the incoming aminoacyl tRNA. The GTP is hydrolysed to GDP, the tRNA binds to the “A” site and EF-1 is released (Fig. 46.4).

### Peptide Bond Formation

- The alpha amino group at the incoming amino acid in the “A” site forms a peptide bond (CO-NH) with carboxyl group of the peptidyl tRNA occupying the “P” site. This reaction is catalyzed by the enzyme **peptidyl transferase** (28S rRNA, a component of 60S subunit). This is an example of **ribozyme**; RNA acts as the enzyme.
- Since, the amino acid brought in by the tRNA is already activated, there is no need for further energy supply for the purpose of peptide bond formation. Now, the growing peptide chain is occupying the “A” site (Fig. 46.4).

### Translocation Process

- At this time, the tRNA fixed at the “P” site does not carry any amino acid and is therefore released from

#### Box 46.2: Why only neurons are affected?

Vanishing White matter disease (VWMD) is characterized by a condition where the white matter of brain disappears and is replaced by CSF. The mutant protein has been identified as eukaryotic initiation factor 2. Strangely the disease is confined to white matter of the brain.

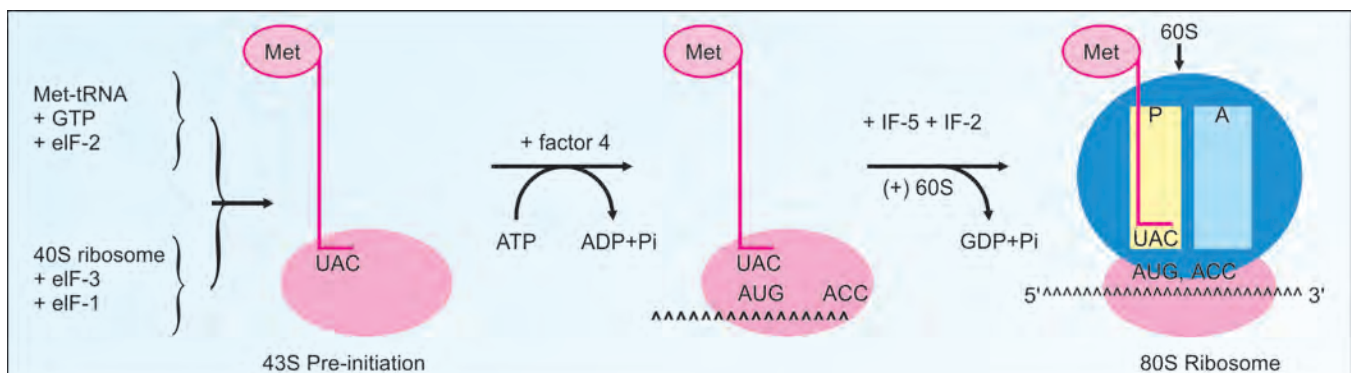


Fig. 46.3: Initiation steps; UAC= anticodon on met-tRNA; AUG= start signal; P= peptidyl site; A= amino acyl site

the ribosome. Then the whole ribosome moves over the mRNA through the distance of one codon (3 bases). The peptidyl tRNA is translocated to the “P” site; this is done with the help of **elongation factor 2 (EF2)**.

- ii. Now, the “A” site is ready to receive another aminoacyl tRNA bearing the appropriate anticodon. The new aminoacyl tRNA is fixed to the “A” site, by base pairing with the mRNA codon. Translocation requires **hydrolysis of GTP to GDP** (Fig. 46.4).
- iii. The elongation reactions (steps C-1, C-2 and C-3 above) are repeated till the polypeptide chain synthesis is completed.

## Energy Requirements

For each peptide bond formation, **4 high energy** phosphate bonds are used; two for the initial activation and one for EF-1 step (GTP to GDP) and one for EF-2 step (GTP to GDP). Actual peptide bond formation (**peptidyl transferase step**) **does not require** any energy, because the amino acids are already activated. Further, 1 ATP is used for initiation complex formation; 1 GTP for 80S ribosome formation and 1 GTP for termination.

## Termination Process of Translation

- i. After successive addition of amino acids, ribosome reaches the **terminator codon** sequence (UAA, UAG or UGA) on the mRNA. Since, there is no tRNA bearing the corresponding anticodon sequence, the “A” site remains free.
- ii. The **releasing factor 1 (RF1)** enters this site. The RF1 binds with RF3 and GTP. This complex along

hydrolyzes the peptide chain from the tRNA at the P site. This needs with hydrolysis of **GTP to GDP**. The completed peptide chain is now released.

- iii. Finally, 80S ribosome **dissociates** into its component units of 60S and 40S (Fig. 46.5).

## Polyribosomes

One eukaryotic ribosome can synthesize 5 to 6 peptide bonds per second. Many ribosomes can work on the same mRNA molecule simultaneously and these aggregates are called polyribosomes or **polysomes** (Fig. 46.6). In such cases each ribosome will be about 80 to 100 nucleotides apart on the mRNA. Polyribosomes may be attached on the walls of the endoplasmic reticulum to form the rough ER (see Chapter 2). The proteins are then transported through cisternal space to Golgi apparatus, where they are temporarily stored. Cytoplasmic proteins are synthesized by ribosomes that exist free in cytoplasm.

## Protein Targeting

### Proteins for External Secretion

The process is also called as “protein sorting” or “protein localization”. The secreted proteins, plasma membrane integral proteins, lysosomal enzymes and membrane proteins of ER are synthesized on rough **endoplasmic reticulum** by membrane bound polyribosomes. The newly synthesized protein is then delivered to the destined compartment. Blobel and Sabatini proposed the **signal hypothesis** to explain the different destination of proteins. Guenter Blobel was awarded Nobel prize in 1999.

The secretory proteins contain a **signal peptide (SP)** region of about 12 to 35 amino acids, located in the **amino terminal region** (Fig. 46.8). This signal peptide will cause anchoring of ribosomes on ER. Initially one free ribosome in the cytoplasm attaches on the mRNA and a small part about 70 amino acids in length, including the SP region, is synthesized.

Another **signal recognition particle (SRP)** is now attached to the SP region; this now blocks further protein synthesis. SRP-SP ribosome complex then binds to a **docking protein or receptor (SRPR)** available

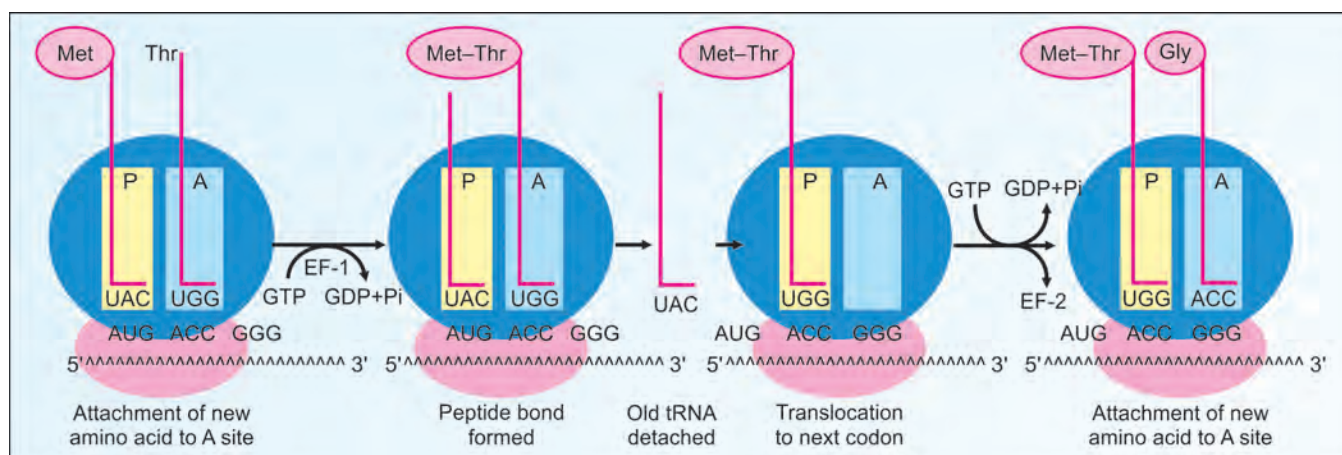


Fig. 46.4: Elongation phase. P= peptidyl site; A= amino acyl site



on ER. Only then the block is removed and further portion of the protein is synthesized. By this mechanism, the signal peptide directs the ribosome to be attached on the ER (Fig. 46.8). The arrangement of the docking protein on ER is such that, the nascent protein is passed through the membrane into the channels of ER. Later, the signal region is cleaved off by **signal peptidase**. Then protein synthesis is completed, and the protein molecule is now inside the endoplasmic membrane (Fig. 46.8). As the nascent protein is traversing the inner membrane of ER, carbohydrate moieties are added at particular regions by specific enzymes; this is called **co-translational glycosylation**.

### Proteins for Internal Parts of the Cell

Proteins destined to become proteins of cytosol, mitochondria and peroxisomes are lacking this signal sequence. Hence, they are synthesized on **free ribosomes**. After completion of synthesis, they do not enter the lumen of ER, but are available in the cytoplasm.

### Correct Address of Destination is Labeled

The signal peptide is on the amino terminal region of protein. Apart from that, the proteins carry an “address” that is specific for its correct destination inside the cell. This is present in the **carboxy terminal** end of proteins. For example, proteins possessing the amino acid sequence KDEL (Lys-asp-glu-leu) near the C-terminal end are destined to reach the *luminal surface of ER*. Integral membrane proteins of ER have amino acid sequences acting as a stop signal, which prevents escape of proteins from ER. Proteins destined to reach peroxisomes contain *peroxisome*

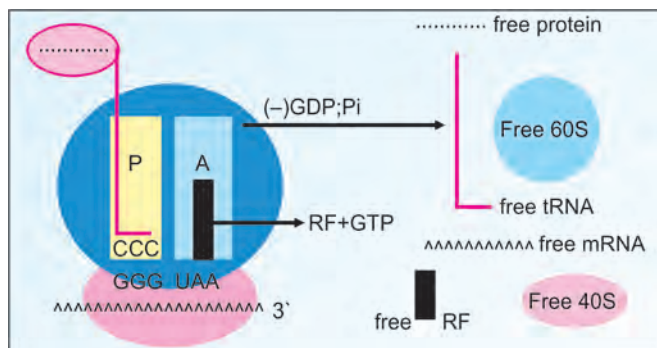


Fig. 46.5: Termination of translation

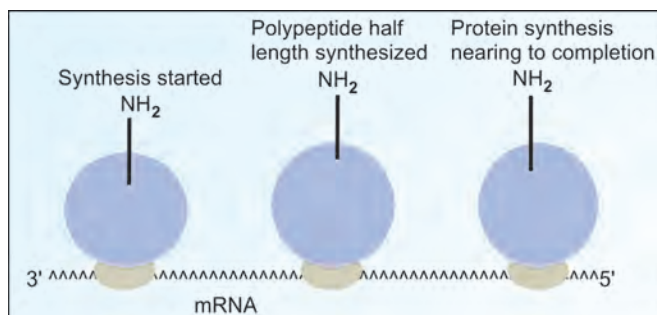


Fig. 46.6: Polyribosomes

*target sequence* (PTS) with 26–36 amino acids. Nuclear proteins and ribosomal proteins, which are imported into the nucleus, contain certain *nuclear import signal sequences*. The nuclear transport is energy requiring and is aided by the two cytoplasmic proteins, alpha-importin (60 kD) and beta-importin (90 kD). Diseases due to defective protein targeting are shown in Box 46.3.

## Post-translational Processing

These processes are categorized in Table 46.3.

### Proteolytic Cleavage

Conversion of pro-insulin to **insulin** (Fig. 46.7). See also Chapter 4.

### Modifications of Amino Acids

- Gamma carboxylation** of glutamic acid residues of prothrombin, under the influence of vitamin K (see Chapter 36).
- Hydroxylation** of proline and lysine in collagen with the help of vitamin C (see Chapter 58).
- Phosphorylation** of hydroxyl groups of serine, threonine or tyrosine by kinases, e.g. glycogen phosphorylase
- Cotranslational **glycosylation**: Carbohydrates are attached to serine or threonine residues through O-glycosidic linkages and to asparagine or glutamine residues through N-glycosidic linkages (Table 46.3).
- Formation of disulfide bonds: Intrachain and interchain disulfide bond formation is catalyzed by disulfide isomerase. Disulfide bond formation prevents unfolding

#### Box 46.3: Protein targeting

Zellweger syndrome is due to defective oxidation of very long chain fatty acids (VLCFA). Here the correct “address” is not printed on the protein packet; so that it could not be delivered to the correct locality. Peroxisomal enzymes are produced; but their entry into peroxisome is denied. This leads to insufficient oxidation of VLCFA. Accumulation of VLCFA in CNS causes neurological impairment and death in childhood.

Another example is primary hyperoxaluria, which causes kidney stones at an early age. The defect is due to protein targeting defect and the enzyme alanine glyoxylate amino transferase (see Fig. 16.7) is seen in mitochondria, instead of its normal peroxisomal location.

Some forms of familial hypercholesterolemia are due to deficient transport signals. Cause of cystic fibrosis include improper localization of proteins.

Inclusion cell disease is due to non-entry of normal enzymes into lysosomes. Mannose-6-phosphate is the marker to target enzymes to lysosomes; this is absent.



- of protein and holds together different polypeptide chains (e.g. insulin, immunoglobulins) or parts of polypeptide chains (ribonuclease).
- vi. Acetylation and methylation of lysine residues of histones modulate transcriptional activity of chromatin. Acetylation increases transcription (genes are switched on) and deacetylation represses transcription (genes are switched off).
  - vii. Many proteins are modified at their C-terminus by prenylation near a cysteine residue in the consensus CAAX where C is cysteine, A is any aliphatic amino acid (except alanine) and X is the C-terminal amino acid. Prenylation refers to the addition of the 15 carbon farnesyl group or the 20 carbon geranyl group to acceptor proteins (farnesyl and geranyl groups are described in cholesterol biosynthetic pathway). The three C-terminal amino acids (AAX) are first removed. Following attachment of the prenyl group, the carboxyl group of the cysteine is methylated, where S-adenosylmethionine as the methyl donor. One such protein that undergoes this type of modification is the proto-oncogene RAS. Some other important

prenylated proteins are those involved in leukocyte motility, activation, and proliferation and endothelial cell immune functions. The statin class of cholesterol synthesis—inhibiting drugs reduce the synthesis of farnesyl pyrophosphate and thus reduced extent of inflammatory events.

### Subunit Aggregation

Examples are immunoglobulin, hemoglobin and maturation of collagen. Failure of post-translational modification affects the normal function of many proteins. For example, poor cross linking of collagen in scurvy, since ascorbic acid is required for the hydroxylation of proline and lysine (see Chapter 38).

### Protein Folding and Chaperones

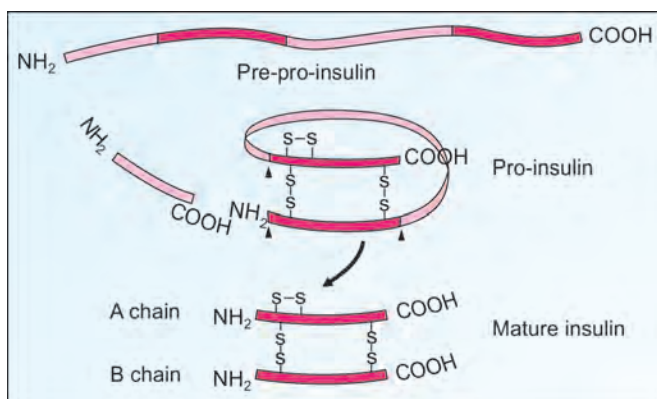
When a protein is being synthesized, it may assume different three-dimensional structures, out of which only one will have the biological activity. Abnormal folding of proteins may lead to **prion** diseases. Protein misfolding diseases are shown in Table 46.6. They are described in detail in Chapter 58.

**Chaperones** help to produce the correct spatial arrangement. The word “chaperone” literally means elderly lady in charge of unmarried girls on social occasions. Chaperones attach to nascent polypeptide chains and prevent wrong foldings; so that folding is allowed only in the correct direction. They help in the assembly of tertiary and quaternary structure of proteins.

Examples of chaperones are a large family of proteins called **heat shock proteins (HSPs)**. Any stress to the cell including heat, toxins, heavy metals, free radicals, radiation, bacteria, etc. will cause increased production of HSPs, and hence they are more correctly termed as

**TABLE 46.3:** Post-translational modifications

Reversible	Irreversible
Disulfide bridge	Proteolysis
glycosylation	Ubiquitination
Phosphorylation	Lysine hydroxylation
Acylation	Proline hydroxylation
N-acetylation	Methylation
ADP-ribosylation	



**Fig. 46.7:** Post-translational processing of insulin by proteolytic cleavage

**TABLE 46.4:** Comparison of translation in eukaryotes and prokaryotes. Mitochondria are similar to prokaryotes

Feature	Eukaryotes (mammalian cells)	Prokaryotes (bacteria)	Mitochondria
DNA	Open	Circular	Circular
Ribosomes	80S	70S	70S
tRNA (No.)	31	22	22
Initiating amino acid	Methionine	Formyl methionine	Formyl methionine
Effect of tetracycline	Not affected	Inhibited	Inhibited
Initiation factors	9	3	
Elongation factors	EF-1 alpha EF-1 beta EF-1 gamma EF-2	EF-Tu EF-Ts	

**stress proteins.** Chaperonopathies are disorders resulting from “sick chaperones”. These diseases progress with age.

## Inhibitors of Protein Synthesis

The modern medical practice is heavily dependent on the use of **antibiotics**. They generally act only on bacteria and are nontoxic to human beings. This is because mammalian cells have 80S ribosomes, while bacteria have 70S ribosomes.

### Reversible Inhibitors in Bacteria

These antibiotics are **bacteriostatic**. **Tetracyclines** bind to the 30S subunit of bacterial ribosome and so inhibit attachment of aminoacyl tRNA to the A site of ribosomes. **Chloramphenicol** inhibits the peptidyl transferase activity of bacterial ribosomes. **Erythromycin** (macrolides) and **clindamycin** prevent the translocation process.

### Irreversible Inhibitors in Bacteria

These antibiotics are **bactericidal**. **Streptomycin** and all other aminoglycoside antibiotics bind to 30S subunit of bacterial ribosomes. They cause misreading of mRNA and at high concentrations, they completely inhibit the initiation complex formation and totally inhibit protein synthesis.

### Inhibitors of Protein Synthesis in Mammals

They are not suitable for clinical use; but they are used as research tools. **Puromycin** is structurally similar to tyrosine-tRNA and gets attached to the “A” site of the ribosome. So, the incomplete peptide is released. It acts both in bacterial and mammalian cells. **Cycloheximide** inhibits peptidyl

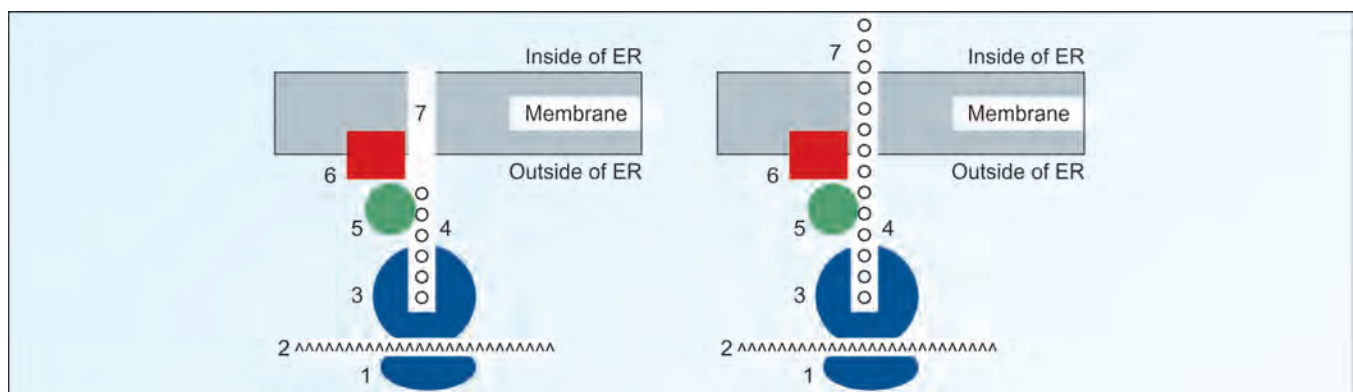
transferase in 60S subunit. It acts only on eukaryotic cells. **Diphtheria toxin**, liberated by the bacteria, corynebacterium diphtheria, causes inactivation of EF-2 by attachment of ADP to EF-2 and consequent inhibition of protein biosynthesis in mammalian systems. Inhibitors of transcription (described elsewhere in this Chapter) will also in turn inhibit translation process.

### Endoplasmic Reticulum Stress (ER Stress)

Proteins are transported from ER through Golgi bodies where they undergo several post-translational changes like glycosylation. But only correctly folded proteins are allowed to pass through the “checkpoint” manned by chaperones network (e.g. Calnexin cycle). These misfolded or damaged proteins are returned to the cytosol for ER associated degradation (ERAD). When the load of proteins to be degraded increases, the ER comes under stress. An example is the accumulation of excess proinsulin synthesized in beta cells, when insulin resistance develops. Accumulation of the unfolded or misfolded protein leads to unfolded protein response (UPR), by which the cell is saved by enhanced degradation of the accumulated proteins or by increasing the chaperone synthesis. If both these strategies fail, apoptosis is triggered and the cell dies finally resulting in diabetes type 2.

### Mitochondrial DNA and RNA

1. There is a dichotomy on the mitochondrial metabolism. Some of the mitochondrial protein synthesis is under the control of mitochondrial DNA; but important proteins of the outer membrane of the mitochondria are synthesized under the influence of nuclear DNA. Table 46.4 shows that mitochondria are similar to bacteria more than mammalian cells. This fact supports the theory that mitochondria are derived from prokaryotes symbiotically adapted to multicellular organisms.



**Fig. 46.8:** Synthesis of secretory proteins. Left side, protein synthesis initiated. Right side, protein is directed into the endoplasmic reticulum. ER = endoplasmic reticulum. 1= 40S ribosome; 2= mRNA attached to the ribosome; 3= 80S ribosome; 4= SP (signal peptide) new protein synthesis started; 5= SRP or signal peptide recognition particle; 6= SRPR or SRP-receptor; 7 (left side) = the SR protein is correctly aligned through the pore of endoplasmic reticulum. 7 (right side)= peptide is passing into the lumen of endoplasmic reticulum

- The mitochondrial DNA (mtDNA) is circular, has about 16,500 nucleotides. The mtDNA has information for synthesis of 2 ribosomal RNAs, 22 tRNAs and 13 proteins. All of them are components of electron transport chain. However, most of mitochondrial proteins are encoded by nuclear DNA and synthesized in the cytoplasm.
- Mitochondria require only 22 tRNAs. Mitochondrial DNA (mtDNA) replication takes about 1 hour. Other features of mitochondrial genes are:
- Maternal inheritance:** Since, the mitochondria are inherited cytoplasmically, the mtDNA is inherited from the mother. Mother transmits mtDNA through oocyte.
- There are hundreds of copies of mtDNA in each cell (nuclear DNA has only 2 copies). During cell division, mtDNA replicates and they segregate to the daughter cells. If a mutation occurs in mtDNA, the daughter cells may inherit the mutant or normal mtDNA. **Heteroplasmy** is defined as the presence of normal and mutant mtDNA in different proportions in different cells.
- High mutation rate.
- Age-related accumulation of mutations in mtDNA may be responsible for age-related decrease in cellular OXPHOS function, and progression of other degenerative diseases.
- Defects in mitochondrial genome will lead to mitochondrial **myopathies**. Leber's hereditary optic neuropathy is caused by a single base mutation which alters one arginine to histidine in the NADH Coenzyme Q reductase. OXPHOS (oxidative phosphorylation) diseases are shown in Table 46.5. Generally, there will be manifestations in nervous system (seizures, deafness, dementia), eyes (retinitis pigmentosa, optic atrophy, blindness, ptosis), heart (cardiomyopathy), kidneys (Fanconi's syndrome, with loss of metabolites in urine) and skeletal muscles (myoglobinuria). Treatment is limited to management of major symptoms.

**TABLE 46.5: OXPHOS diseases**

Syndrome	Features
Leber's Hereditary Neuropathy (LHON)	Complex I defect; Blindness, cardiac conduction defects
Myoclonic epilepsy ragged red fiber disease (MERRF)	Myoclonic epilepsy, myopathy, dementia
Mitochondrial encephalopathy lactic acidosis stroke like episodes (MELAS)	Complex I defect; lactic acidosis, strokes, myopathy, seizures, dementia
Leigh's syndrome	Complex I defect; NDUFS gene defect; movement disorders

**TABLE 46.6: Protein misfolding disorders**

Disease	Abnormal protein
Huntington's disease	Huntingtin
Cystic fibrosis	CFTR
Parkinson's disease	Alpha synuclein
Cruetzfeldt Jakob disease	Prions
Alzheimer's disease	Beta amyloid

## Genomics and Proteomics

- Genome** means all the DNA contained in an organism or a cell, which includes both the chromosomes within the nucleus and the DNA in mitochondria. Thus the genome of an organism is the totality of genes making up its hereditary constitution (Box 46.4).
- Genomics** is the study of the genome and its actions. Genomics thus involves the analysis of the full DNA sequence of the organism. **Genetics** scrutinizes the functioning and composition of the single gene where as genomics addresses working of all genes and their inter-relationships in order to identify their combined influence on the growth and development of the organism (Box 46.4).
- Proteome** is the sum of all proteins expressed by the genome of an organism, thus involving the identification of the proteins in the body and determination of their role in physiological and pathological functions. While the genome remains largely unchanged, the proteins of a particular cell change dramatically as genes are turned on and off in response to the environment (Box 46.4).
- Proteomics:** It directly addresses the protein complement of the genome. It has been defined as the study of protein properties (expression level, post-translational modification, interactions, etc.) on a large scale to obtain a global, integrated view of disease processes, cellular processes, and networks at the protein level. The study of all proteins by a cell type or an organism is called 'proteomics'.

## Fusion Proteins

A fusion protein is the product of a fused gene. A fusion gene is produced by removing a stop codon from the DNA sequence coding for a particular polypeptide and appending the DNA sequence coding for another protein. The product is a fusion protein. Sometimes a part of a chromosome is detached and fused with another region in the same or on another chromosome. Such chromosome translocations will also lead to formation of fusion genes and fusion proteins.

## QUICK LOOK OF CHAPTER 46

- Transfer RNA (tRNA) or soluble RNA (sRNA) is the adapter molecule between transcription and translation. Each amino acid has a specific tRNA.

### Box 46.4: Emerging concepts

<b>MOLECULAR DOGMA</b> (Pre-Bioinformatics era)	<b>MOLECULAR DOGMA</b> (Bioinformatics era)
<b>DNA</b>	<b>Genome</b> (Total genetic component)
<b>mRNA</b>	<b>Transcriptome</b> (Total mRNA produced by a cell)
<b>Protein</b>	<b>Proteome</b> (Sum total of all proteins synthesized by a cell)

2. The triplet sequence on the anticodon arm of the tRNA is complementary to the codon triplet on the mRNA.
3. Six important characteristics of the genetic code are that it is triplet, universal, degenerate, non-overlapping, non-punctuated and exhibit wobbling.
4. Three terminator codons are UAA, UAG and UGA.
5. Four high energy phosphate bonds are required for the formation of one peptide bond, two for initial activation, one for EF-1 step and one for EF-2 step.
6. Post-translational processing of proteins includes removal of the signal sequences, gamma carboxylations, methylations, acylation, subunit aggregation and phosphorylations.
7. Clinically useful protein synthesis inhibitors are streptomycin, chloramphenicol, tetracyclines, erythromycin.
8. Chaperones are proteins that govern protein folding. Improper protein folding may lead to Prion diseases.



# CHAPTER 47

## Control of Gene Expression

### Chapter at a Glance

The reader will be able to answer questions on the following topics

- Principles of heredity
- Dominant and recessive inheritance
- Mutations
- Operon concept
- Repression and de-repression

It is estimated that more than 6% of all infants born alive suffer from genetic diseases and 1% from chromosomal aberrations. The former conditions involve minor alterations in DNA make up, e.g. phenylketonuria. The latter ones are due to major changes in chromosomes; e.g. Down's syndrome, Turner's syndrome. Gregor Johann Mendel (1822–84), who was Abbot of Brun, described the principles of heredity in 1866. As it was printed in an obscure journal, it remained unnoticed for many years. In 1900, Hugo de Vries and C Correns, rediscovered and confirmed Mendel's theory. Walther Flemming demonstrated chromosomes in 1882. In 1902, Walter Sutton showed that chromosomes are in pairs and are the carriers of Mendel's Unit of heredity. The word 'Gene' was coined by Wilhelm Johannsen in 1909. According to Mendel's law, if "A" represents a dominant character and "b" recessive or latent character in parents, then  $(A+b)^2 = A^2+2 Ab +b^2$ , i.e. one-half of progeny will have mixed parental characters (2Ab); one-fourth will have dominant ( $A^2$ ) and one-fourth will have recessive ( $b^2$ ) characters. All genes are not equal in the eyes of evolution. Evolutionarily relevant mutations tend to accumulate in 'hotspot genes' and at specific positions within genes. Genetic evolution is constrained by gene function, the structure of genetic networks, and population biology.

### Basic Principles of Heredity

1. Heredity is transmitted from parent to offspring as individual characters.
2. The genes are linearly distributed on chromosomes at fixed positions (**loci**).

3. Genes that may replace one another at the same locus are called allelomorph genes or **alleles**. Alleles are genes responsible for alternate or contrasting characters. Usually, one allele is inherited from father and the other from mother.
4. When both alleles carry the same defect, it is said to be **homozygous**.
5. When one allele is normal, and the counterpart is defective; it is called **heterozygous**.
6. Genes on the same chromosome are **linked**; and the linkages are more pronounced in the nearby genes.
7. The observed character expressed by the gene is called **phenotype**.
8. The **genotype** represents the set pattern of genes present in the cell.

### Dominant Inheritance

- i. It is characterized by the *phenotypic expression of the disease, even if one allele is abnormal or in heterozygous state*. In the example, shown in Figure 47.1, the father has the defective gene, marked as D. The possible permutations of gametes are shown in the Figure 47.1.

- ii. Affected men and women transmit the abnormality to their children. When an affected heterozygote parent (Dd) has a normal spouse (dd), half of the progeny will have the disease.
- iii. Examples of diseases with autosomal dominant inheritance are chondrodystrophy (dwarfism) and some types of porphyrias.
- iv. The trait may be transmitted by either parent and can affect both male and female offsprings.

### Autosomal Recessive Inheritance

- i. Phenotype or a particular character is controlled by a pair of alleles located on a specified area on the chromosomes.
- ii. If the disease is manifested only in homozygous state (not expressed in heterozygous condition), it is known as **recessive** transmission.
- iii. For example, in a person suffering from sickle cell anemia, both the alleles for beta-globin gene have mutated. Hence, all beta, globin chains will be abnormal. He is homozygous for sickle cell disease.

- iv. In certain cases, the carrier state may be identified biochemically, then it is referred to as the **trait of the disease**. For example, in sickle cell trait, one beta-globin gene (allele) is normal; while the other one is abnormal (**carrier** state). Such individual is heterozygous to that character. Therefore, normal gene produces normal Hb and abnormal gene produces HbS. Thus inside the RBC, 50% of hemoglobin molecules are abnormal. This can be identified by electrophoresis.
- v. When both father and mother are carriers, one-quarter of siblings express the disease (both alleles abnormal), another one-quarter of siblings are normal, and half of the children are carriers (Fig. 47.2). This chance factor is acting on each progeny.
- vi. If only one parent is carrier and the other is normal; then there will be no affected child, but 50% children are carriers. When an affected child is born, each subsequent child has a 25% chance of being affected.
- vii. Most of the inborn errors of metabolism are recessively transmitted. A few examples are phenylketonuria, albinism, galactosemia and sickle cell anemia.

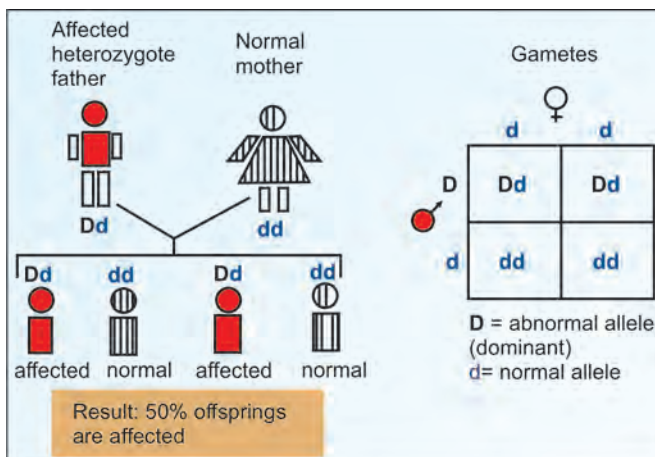


Fig. 47.1: Autosomal dominant inheritance

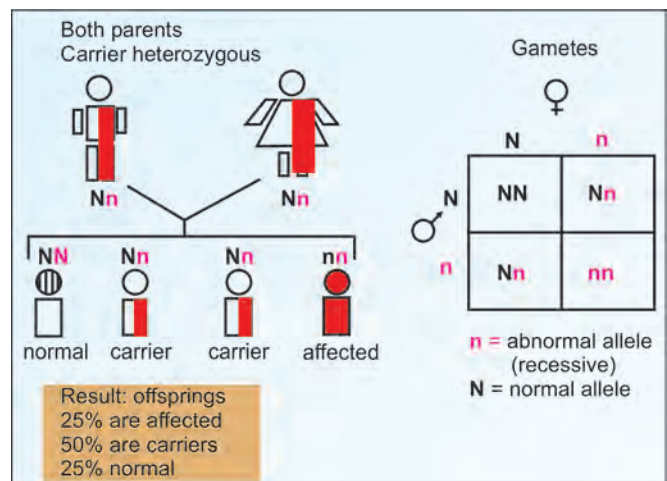


Fig. 47.2: Autosomal recessive inheritance



Gregor Mendel  
1822–1984



Hugo de Vries  
1848–1935



Walther Flemming  
1843–1905



Walter Sutton  
1877–1916



Wilhelm Johannsen  
1857–1927



Godfrey Hardy  
1877–1947



Wilhelm Weinberg  
1862–1937

## Sex-linked (X-linked) Recessive Inheritance

- In the autosomal conditions, the disease occurs in both sexes with equal frequency. But in sex-linked conditions, X-chromosome carries the abnormal gene (Fig. 47.3).
- When a normal male carries a carrier female (unaffected parent), the children can be affected male (25%), female carrier (25%), normal male (25%) and normal female (25%).
- All male children of an affected male and normal female will be normal; but all female children will be carriers since they inherit the abnormal X from their father (Fig. 47.3).
- There is no male-to-male transmission, but male-to-female and female-to-male transmission of the affected X can occur. X-linked traits are expressed in males who are hemizygous (XY) for the condition, but not in females who may be heterozygous (XX).
- Hemophilia, glucose-6-phosphate dehydrogenase deficiency, pseudohypertrophic muscular dystrophy (Duchenne type), and red-green color blindness are examples of sex-linked recessive inheritance.

### Y-linked Inheritance

- Y-chromosome carries relatively few genes, but they code for proteins that regulate the development of primary and secondary sexual characteristics (SRY gene)
- Only males are affected. Affected males always have an affected father and all sons of an affected male will be affected.

In all genetic conditions, phenotypic expressions may vary (Box 47.1).

## Population Genetics

A law stating the frequency of abnormal genes in population was discovered in 1908 independently by Hardy (Mathematician) and Weinberg (Physician). The **Hardy-Weinberg law** states that, if there are “p” gametes of ‘A’ type and “q” gametes of ‘a’ type and when  $p + q = 1$  in one generation, the genotypes and their frequency will be:

Genotype	AA	Aa	aa
Relative frequency	$p^2$	$2pq$	$q^2$

The law states that  $(p^2 + 2pq + q^2) = 1$  and the genotypes in the population from one generation to another generation will be in equilibrium. Or,  $p^2 : 2pq : q^2$  ratio is maintained in all generations (the ratio of normal and abnormal gene is maintained in all generations). This law is useful to calculate the frequency of a harmful gene in a population. It is known that 1 in 20,000 livebirths is an albino, which is inherited recessively. Let us say, they are ‘aa’ genotypes. Thus the remaining 19,999 are ‘AA’ or ‘Aa’ genotypes. The frequency of q of the recessive albino gene can be calculated as follows:  $q^2 = 1/20,000$ . Therefore,  $q = 1/141$ . Since  $p + q = 1$ , in this particular example,  $p = 140/141$ . Therefore, the ‘Aa’ genotype, or  $2pq = 1/70$ . Thus, 1 out of 70 individuals carries the abnormal gene for albinism. In other words, 1.4% of all persons are heterozygous for albino allele. So, there are 280 carriers for each albino patient.

### Spontaneous Mutations

The abnormal genes are produced by natural mutations and deleted by Darwin’s natural selection mechanism, e.g. phenylketonuria patient is mentally retarded and therefore lesser chances to procure a child. The law essentially states that *the rate of new mutation equals the elimination*. That means, spontaneous mutation is taking place on that gene in successive generations.

## Law of Selection Applied to Genes

However, an abnormal gene need not always be eliminated from a population, if there is a selective advantage for

		Affected male gametes		Normal male gametes		Affected male gametes	
		X	Y	X	Y	X	Y
Normal female gametes	X	XX Carrier daughter	XY Normal son	XX Carrier daughter	XY Affected son	XX Affected daughter	XY Affected son
	X	XX Carrier daughter	XY Normal son	XX Normal daughter	XY Normal son	XX Carrier daughter	XY Normal son

Fig. 47.3: Sex-linked recessive inheritance

heterozygous state. The best example is the sickle-cell anemia trait. The geographical distribution of sickle-cell anemia fairly well overlaps with malaria endemicity. Sickle-cell anemia is a lethal disease; patient dies before the reproductive age, and therefore the gene must have been eliminated. But the heterozygous persons carry RBCs having 50% normal Hb and 50% abnormal hemoglobin. So, the partial pressure of oxygen inside the RBC is lesser than normal individuals. Hence, malarial parasites do not multiply easily in heterozygous individuals (see Chapter 22). Therefore, in the malarial endemic areas, the lethal nature of the gene in the homozygous state is counterbalanced by the advantage in heterozygous state. This is called **balanced polymorphism**. Genes for thalassemia, GPD deficiency, etc. are also maintained in the population by such a mechanism.

### Marriages with Close-Cousins are Inadvisable

The probability of two carriers getting married is increased in consanguinous marriages (Latin, con = with; sanguis = blood). So, there is increased frequency of genetic diseases in their children. For example, phenylketonuria has an incidence of 1 in 25,000 in general population; but it is 13/25,000 in children of first cousin marriages.

### Cytoplasmic Inheritance

This follows a maternal line of transmission, e.g. mitochondrial inheritance. Transmission of mitochondrial genes ends with each son, because son does not pass the mitochondrial genes to his offspring. Mothers are heteroplasmic and are therefore unaffected, e.g. Leber's optic neuropathy (see Table 46.4), myoclonic epilepsy, etc.

### Chromosomal Recombination

During meiosis (reduction division), exchange of genetic information between homologous chromosomes is taking place. Homologous chromosomes are exactly aligned so that respective genes oppose. Then a process of **crossover** occurs, so that reciprocal exchange of genetic information is obtained. Such a recombination can explain the fact that the characteristics of offspring are not exactly like those of their parents. Often a genius is born to ordinary parents. The pattern of fingerprints will be different even in siblings.

#### Box 47.1: Variable phenotypic expression and penetrance

All genetic conditions are not congenital (present at birth). Even dominant characters may not show 100% penetrance in actual practice, so that an affected parent may not have an affected child, or the offspring may carry the mutant gene but will be phenotypically normal. When the phenotypic expression of a mutant trait occurs only in adult life, it is referred to as age-related penetrance, e.g. triplet expansion defects. In dominant conditions, variable expression of clinical features may be seen in different family members.

Rarely, the alignment of chromosomes may not be exact; then recombination results in **unequal exchange** of genes. There may be *deletion* in one chromosome, while the other one receives an *insertion*. A good example of unequal recombination is the *Lepore hemoglobin*, where instead of normal delta-and beta-hemoglobins a chimeric delta-beta hemoglobin is produced (**Chimera** is a Greek demon, similar to Narasimha, with lion's head and body of other animals).

### Transposon

It is a DNA sequence able to insert itself at a new location in the genome; these are jumping genes or movable genes. **Retroposon** is a transposon that mobilizes via an RNA form; the DNA element is transcribed into RNA, and then reverse-transcribed into DNA, which is inserted at a new site in the genome.

### Genetic Disorders

The locations of many genes have been identified on specific genes. A small selected list is given in Table 47.1. Genetic disorders are of different types:

- Chromosomal disorders:** These are identified by Karyo typing, e.g. 21 trisomy.
- Single gene defect, sometimes identified by biochemical methods, e.g. Phenylketonuria.
- Mitochondrial abnormalities.
- Multifactorial disorders.

### Treatment Policies of Genetic Diseases

- Replace the end-product of the missing enzyme, e.g. administer thyroxine in familial goiter.
- Limit the substrate of the missing enzyme. In phenylketonuria, reduce phenylalanine in diet. In galactosemia remove lactose from diet.
- Replace missing protein, e.g. administer AHG (anti-hemophilic globulin) in hemophilia.
- Activity of abnormal enzyme is enhanced, e.g. large quantities of vitamin B<sub>12</sub> is useful in methyl malonic aciduria.
- Induction of enzyme; in Crigler-Najjar syndrome, glucuronyl transferase enzyme can be induced by phenobarbitone.
- Gene therapy is still in experimental stages, but may become common in the next generation.

### Online Mendelian Inheritance in Man (OMIM)

The OMIM is a comprehensive and authoritative compendium of human genes and genetic phenotypes. It contains information on all known Mendelian diseases



and more than 12,000 genes. It focuses on the genotype-phenotype relationship (Box 47.2).

## MUTATIONS

- i. A mutation is defined as a change in nucleotide sequence of DNA. This may be either gross, so that large areas of chromosome are changed, or may be subtle with a change in one or a few nucleotides.
- ii. Mutation may be defined as an abrupt spontaneous origin of new character.
- iii. Statistically, out of every  $10^6$  cell divisions, one mutation takes place.

**TABLE 47.1:** Genes in human chromosomes

Chromosome No	Gene
1 :	Alkaline phosphatase (liver, bone, kidney); salivary amylase; Apoprotein A-II
2 :	Alkaline phosphatase (placental), apolipoprotein-B; immunoglobulin Kappa chain
3 :	Transferrin
4 :	Alcohol dehydrogenase; Fibrinogen; Interleukin-2; Huntington's chorea (disease)
5 :	hMG-CoA reductase; Acute myelogenous leukemia
6 :	MHC (Major histocompatibility) locus
7 :	Urea cycle enzymes; cystic fibrosis (disease)
8 :	Carbonic anhydrase
9 :	Interferon
11 :	Hemoglobin $\beta$ , $\gamma$ and $\delta$ chains; Proinsulin; Pepsinogen; Parathyroid hormone
12 :	Alpha-2-macroglobulin; Glyceraldehyde-3-P-dehydrogenase
13 :	Breast Cancer (BRCA2)
14 :	Immunoglobulin heavy chains; $\alpha$ -1-antitrypsin
15 :	Cytochrome P-450
16 :	Hemoglobin $\alpha$ -chain; polycystic kidney disease; Prostate cancer
17 :	Breast cancer (BRCA1), Growth hormone
18 :	Pre-albumin
19 :	Carcinoembryonic antigen; $\beta$ chain of hCG; Creatine kinase M chain; LDL receptor
20 :	Adenosine deaminase
21 :	Superoxide dismutase
22 :	Immunoglobulin, lambda chain
X :	Glucose-6-P-dehydrogenase; Antihemophilic globulin; HGPRTase; Duchenne type muscular dystrophy

## CLASSIFICATION OF MUTATIONS

Mutations can result from substitution, deletion or addition of one or more nucleotides. Substitution of one nucleotide by another is the most common type of mutation. A **point mutation** is defined as a change in a single nucleotide. This change may have mis-sense or nonsense effects. Deletion or insertion of a single nucleotide leads to a frameshift effect.

### Substitution

Replacement of a purine by another purine (A to G or G to A) or pyrimidine by pyrimidine (T to C or C to T) is called **transition mutation**. If a purine is changed to a pyrimidine (e.g. A to C) or a pyrimidine to a purine (e.g. T to G), it is called a **transversion**. The point mutation present in DNA is transcribed and translated, so that the defective gene produces an abnormal protein.

### Deletion

Deletions may be subclassified into

- i. **Large gene deletions**, e.g. alpha-thalassemia (entire gene) or hemophilia (partial)
- ii. **Deletion of a codon**, e.g. cystic fibrosis (one amino acid) 508th phenyl alanine is missing in the CFTR protein.
- iii. **Deletion of a single base** which will give rise to frameshift effect.

### Insertion

Insertions or additions or expansions are subclassified into:

- i. **Single base** additions, leading to frameshift effect.
- ii. **Trinucleotide** expansions. In Huntington's chorea, CAG trinucleotides are repeated 30 to 300 times. This leads to a polyglutamine repeat in the protein.

#### Box 47.2: Online Mendelian inheritance in man (OMIM)

This database was initiated in the early 1960s by Dr Victor A McKusick as a catalog of Mendelian traits and disorders, entitled Mendelian Inheritance in Man (MIM). Twelve book editions of MIM were published between 1966 and 1998. The online version, OMIM, was created in 1985. It was made generally available on the internet in 1987.

Every disease and gene is assigned a six-digit number of which the first number classifies the method of inheritance. For example, if the initial digit is 1, the trait is deemed autosomal dominant; if 2, autosomal recessive; if 3, X-linked. Initial digit is given as 6 for autosomal diseases after 1994. PKU – 261600; breast cancer BRCA1 – 113705, BRCA2 – 600185, X-linked hypophosphatemic rickets – 307800.

The severity of the disease is increased as the numbers of repeats are more.

- iii. **Duplications.** Gene duplication results from unequal crossing over of chromosomes during meiosis and plays an important role in evolution.

## Effects of Mutations

### Silent Mutation

A point mutation may change the codon for one amino acid to a synonym for the same amino acid. Then the mutation is silent and has no effect on the phenotype. For example, CUA is mutated to CUC; both code for leucine, and so this mutation has no effect.

### Mis-sense but Acceptable Mutation

A change in amino acid may be produced in the protein; but with no functional consequences. For example, in the normal hemoglobin A molecule, the 67th amino acid in beta-chain (HbA  $\beta$ -67) is valine. The codon in mRNA is GUU. If a point mutation changes it to GCU, the amino acid becomes alanine; this is called **Hb Sydney**. This variant is functionally normal. A **conserved mutation** occurs when the altered amino acid has the same properties of the original one; e.g. glutamic acid to aspartic acid.

### Mis-sense; Partially Acceptable Mutation

In this type, the amino acid substitution affects the functional properties of the protein. **HbS** or sickle-cell hemoglobin is produced by a mutation of the beta-chain in which the 6th position is changed to valine, instead of the normal glutamate. Here, the normal codon GAG is changed to GUG (**transversion**). HbS has abnormal electrophoretic mobility and subnormal function, leading to sickle-cell anemia. Details are given in Chapter 22.

### Mis-sense; Unacceptable Mutation

The single amino acid substitution alters the properties of the protein to such an extent that it becomes nonfunctional and the condition is incompatible with normal life. For example, **HbM** results from histidine-to-tyrosine substitution (CAU to UAU) of the distal histidine residue of alpha-chain. There is methemoglobinemia.

### Nonsense; Terminator Codon Mutation

A tyrosine (codon, UAC) may be mutated to a termination codon (UAA or UAG). This leads to **premature** termination of the protein, and so functional activity may be destroyed, e.g. beta-thalassemia. Or, a terminator codon is altered into a coding codon (UAA to CAA). This results in elongation of the protein to produce **run on polypeptide** (Hb Constant spring) (see Chapter 22).

### Frameshift Mutation

This is due to addition or deletion of bases. From that point onwards, the reading frame shifts. A “garbled” (completely irrelevant) protein, with altered amino acid sequence is produced. An example,

Normal	mRNA	AUG	UCU	UGC	AAA.....
Normal	protein	Met	Ser	Cys	Lys.....
DeletedU	mRNA	AUG	<u>CUU</u>	<u>GCA</u>	<u>AA</u> .....
Garbled	protein	Met	<u>Leu</u>	<u>Ala</u>	.....

In this hypothetical example, deletion of one uracil changes all the triplet codons thereafter. Therefore, a useless protein is produced. Frame shift mutations can also lead to thalassemia, premature chain termination and run-on-polypeptide.

### Conditional Mutations

Most of the spontaneous mutations are *conditional*; they are manifested only when circumstances are appropriate. Bacteria acquire resistance, if treated with antibiotics for a long time. This is explained by spontaneous conditional mutations. In the normal circumstances, wild bacilli will



Hermann Muller  
NP 1946  
1890–1967



George Beadle  
NP 1958  
1903–1989



Edward Tatum  
NP 1958  
1909–1975



Michael Smith  
NP 1993  
1932–2000

grow. In the medium containing antibiotic, the resistant bacilli are selected. In a tuberculous patient, a lung cavity may harbor about  $10^{12}$  bacilli. This may contain about  $10^6$  mutations, out of which a few could be streptomycin resistant. Therefore if only one drug is given, there will be overgrowth of drug resistant bacilli. To avoid this, combinations of two anti-tuberculous drugs are given. So, drug-1-resistant mutants are killed by drug-2 and drug-2-resistant mutants are removed by drug-1. The statistical probability of a single bacillus acquiring resistance against both drugs is negligible.

## Mutagens and Mutagenesis

Any agent which will increase DNA damage or cell proliferation can cause increased rate of mutations also. Such substances are called **mutagens**. X-ray, gamma-ray, UV ray, acridine orange, etc. are well-known mutagens. Müller (Nobel Prize, 1946) showed that the rate of mutation was proportional to the dose of irradiation. Beadle (Nobel prize, 1958) showed that the effect of X-irradiation on metabolism was due to mutations of genes. Tatum (Nobel Prize, 1958) further showed that a mutation of a single gene resulted only in a single chemical reaction, which gave evidence to the concept of “one gene, one enzyme”.

## Manifestations of Mutations

### Lethal Mutations

The alteration is incompatible with life of the cell or the organism. For example, a mutation which does not produce alpha chains (4 gene deletion) will result in intrauterine death of embryo.

### Silent Mutations

Alteration at an insignificant region of a protein may not have any metabolic effect.



Leland  
Hartwell  
NP 2001  
b.1939



Timothy Hunt  
NP 2001  
b.1943



Paul Nurse  
NP 2001  
b. 1949

### Beneficial Mutations

Although rare, beneficial spontaneous mutations are the basis of evolution. Such beneficial mutants are artificially selected in agriculture. Normal maize is deficient in tryptophan. Tryptophan-rich maize varieties are now available for cultivation. Microorganisms often have antigenic mutation. These are beneficial to microorganisms (but of course, bad to human beings).

### Carcinogenic Effect

The mutation may not be lethal, but may alter the regulatory mechanisms. Such a mutation in a somatic cell may result in uncontrolled cell division leading to cancer. Any substance causing increased rate of mutation can also increase the probability of cancer. Thus all carcinogens are mutagens.

### Ame's Test to Detect Mutagenicity

Special strains of *Salmonella typhimurium* (bacteria causing typhoid) are selected. They have the mutated histidine gene. They will grow only when histidine is provided in the culture medium. They are sensitive to mutagens because they are defective in excision repair system for correcting DNA damage. The compound to be tested is mixed with bacteria and introduced into histidine-deficient medium. All bacteria will die, except those who have reverted back to wild type and acquire the capacity to synthesize histidine. This is called **reverse mutation**. The number of colonies will be proportional to the quantity of mutagen.

### Site-directed Mutagenesis

Michael Smith (Nobel prize, 1993) described this technique. An oligo-deoxyribonucleotide is synthesized, whose sequence is complementary to a part of a known gene. A specific deletion/insertion is produced in the oligo. It is then extended by DNAP. After replication, one strand is normal and the other strand contains the mutation at the specific site. This allows study on the effect of that particular mutation.

## CELL CYCLE

- i. The term cell cycle refers to the events occurring during the period between two mitotic divisions. It is divided into G1 (gap-1), S (synthesis), G2 (gap-2), and M (mitosis) phases.
- ii. The cell division is taking place in **M phase**. It is the shortest phase, lasting about 1 hour. The daughter cells then either enter into G0 (undividing or dormant) phase or re-enter the cell cycle when there is necessity for growth and repair.
- iii. In a normal cell population, most of the cells are in G0 phase. General metabolic events are taking place in G0 phase.

- iv. **Interphase** is the period between the end of M phase and the beginning of the next mitosis.
- v. In **G1 phase**, protein and RNA increase. Duration of G1 phase is about 12 hours.
- vi. In the **S phase**, DNA is synthesized, but only once. DNA content doubles, nucleus becomes tetraploid ( $4n$ ). The entire diploid genome is replicated into a tetraploid genome. S phase lasts about 6 to 8 hours.
- vii. In the **G2 phase**, there is cytoplasmic enlargement. DNA repair is also taking place in the G2 phase. Proteins, especially histones are also produced. It lasts for about 4 to 5 hours. The total cell cycle is about 20–22 hours duration in mammalian cells (Fig. 47.4).

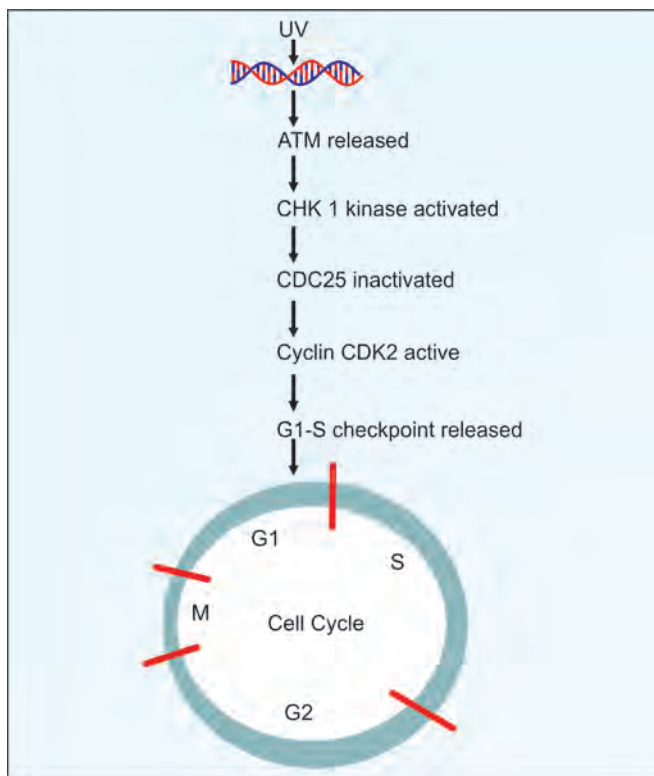


Fig. 47.4: Cell cycle phases (total 20–22 hours)



Sydney  
Brenner  
NP 2002  
b. 1927

Robert  
Horvitz  
NP 2002  
b. 1947

John E  
Sulston  
NP 2002  
b. 1942

Bruce N  
Ames  
b. 1928

## Cell Cycle Controls or Checkpoints

Hartwell, Hunt and Nurse were awarded Nobel prize in 2001 for their contributions in elucidating the cell cycle regulation. The important checks occur in 3 stages; at G1-S transition, during S phase or at G2-M boundary. Of this G1 phase checkpoint is more complex and is under strict control. Four types of **cyclins** (A, B, D and E) and 5 different cyclin dependent **kinases** (CDK 1, 2, 4, 5 and 6) control the cycle. Cyclins are so named because they are synthesized throughout the cell cycle, and are abruptly destroyed during mitosis. Cyclins activate CDKs which phosphorylate specific substrates (regulatory proteins). Mammalian cells in G0 phase are stimulated by growth factors, which trigger them to enter into G1 phase (Fig. 47.4). For the discovery of growth factors, Stanley Cohen and Rita Levi-Montalcini were awarded Nobel prize in 1986.

ATM is a protein kinase, which is associated with the DNA. If a break in DNA is produced (e.g. UV light), the ATM is dissociated, activated, and then initiates a series of cascade reaction. A simplified version is shown in Figure 47.4. CDK2-cyclin E complex directs the cells in G1 phase to enter into S phase. CDK2 complexed with cyclin A pushes forward the cells to complete the S phase. Then, CDK2, cyclin A and B make the cells complete the G2 phase and enter into the M phase (Fig. 47.4).

The **MPF** (M phase promoting factor) pushes the cell into mitosis. MPF has two subunits; p34 and p45; the number indicating molecular weight in kD. At the end of G2, p34 is activated by dephosphorylation, which phosphorylates many substrates, including histones (leading to chromosome condensation in M phase) and lamins (causing nuclear envelope breakdown). By the end of M phase the MPF becomes inactive by cyclin degradation. The action of many oncogenes (see Chapter 57) and growth factors are explained by cyclin-cyclin kinase system. For example, the **bcl oncogene**, associated with B cell lymphoma, is the gene for cyclin D.

Cell cycle arrest mediated by a checkpoint may fail for a variety of reasons. First, like all cellular processes, checkpoints have an intrinsic error rate. Second, after a period of arrest, even though damage remains unrepaired, the cell may resume the cycle. Third, checkpoints may be mutated, leading to unchecked growth, leading to cancer. If damage is not repaired and the cell passes to the next stage, secondary lesions result. For example, if a G1 cell with single-stranded breaks in DNA progresses through S phase, these are converted into double-stranded breaks. Segregation of broken chromosomes may lead to loss of certain fragments during M phase.

## Retinoblastoma (RB) Oncosuppressor Protein

RB protein is the product of an oncosuppressor gene (see Chapter 57). It is so named, because it was isolated from patients of retinoblastoma (cancer arising from retina). It is a cell cycle regulator. It binds and inactivates the E2F, a transcription factor. Thus Rb inhibits cell cycle at G1 phase. But in controlled cell cycles, cyclin D levels rise in the late G1 phase. The cyclin D inactivates Rb, which is separated from E2F. This is the normal mechanism to overcome the G1 arrest by Rb. Certain tumor antigens derived from viruses such as SV40, HSV, HPV may combine with Rb. Then, Rb cannot inhibit cell cycle, leading to continuous cell division and cancer (Fig. 47.5).

## The p53 Oncosuppressor Protein

So named because it is a protein with 53kD size, having 393 amino acids. The half-life is only 5–10 minutes. p53 inhibits cell division, allowing



time for any damage to DNA to be repaired. If damage is extensive and repair is not possible, the p53 directs the cell to apoptosis. PCNA gene encodes a nuclear protein that is a cofactor for DNA polymerase. The p53 downregulates PCNA transcription, blocks the DNA polymerase and causes arrest in G1. It is phosphorylated in a cell cycle dependent manner by CDK4. Maximum level of p53 phosphorylation is reached during mitosis.

### Embryo Development

Edward Lewis, Christiane Nusslein-Volhard and Eric Wieschaus have been awarded Nobel prize in 1995 for their discoveries on genetic control of early embryonic development. They identified and classified the genes determining the body axis and separate organs. These genes are called **homeotic** genes in drosophilia and **HOX genes** in mammals. Osamu Shimomura, Martin Chalfie and Roger Tsien were awarded Nobel Prize in 2008 for their discovery and development of the green fluorescent protein, GFP.

### Apoptosis (Programmed Cell Death)

Differentiation and growth needs reshaping of organs; this could be done only when old cells are removed from the area. Removal of superfluous, aged or partially damaged cell is done by apoptosis. The term literally means “dropping off”, similar to the old leaf falling from the tree. Nuclear shrinkage, chromatin condensation, membrane blebbing and step-ladder pattern of DNA in electrophoresis are characteristic features of apoptosis (Fig. 47.6A). Apoptosis-mediating genes (suicidal genes) (oncosuppressor genes) are c-fos, p53, Rb. Apoptosis-protecting genes are bcl-2 and other oncogenes. Stress and other stimuli activate certain cell surface receptors, and a cascade of activation takes place. The final effector mechanism of cell death is through the activation of caspases. Brenner, Horvitz and Sulston were awarded Nobel prize in 2002 for their contributions to apoptosis mechanisms.

### Mitochondrial Permeability Transition Pore (MPTP)

It is located between the inner and outer mitochondrial membrane. It is made up of voltage dependent anion channel (VDAC) located in the outer membrane, adenine nucleotide translocase (ANT) located in the inner membrane and cyclophilin-D. The pore is normally in the closed state and opened under oxidative stress or attack of free radicals. This causes increased matrix calcium ions. Opening of the pore results in an increase in the permeability of the mitochondrial membrane (see Chapter 20) to molecules weighing less than 1500 Daltons. Opening of the MPT pore causes ATP depletion and release of cytochrome c; the latter acts as a trigger for apoptosis. Reactive oxygen species (see Chapter 33) cause opening of MPTP, which leads to apoptosis. This leads to mitochondrial swelling and cell death.

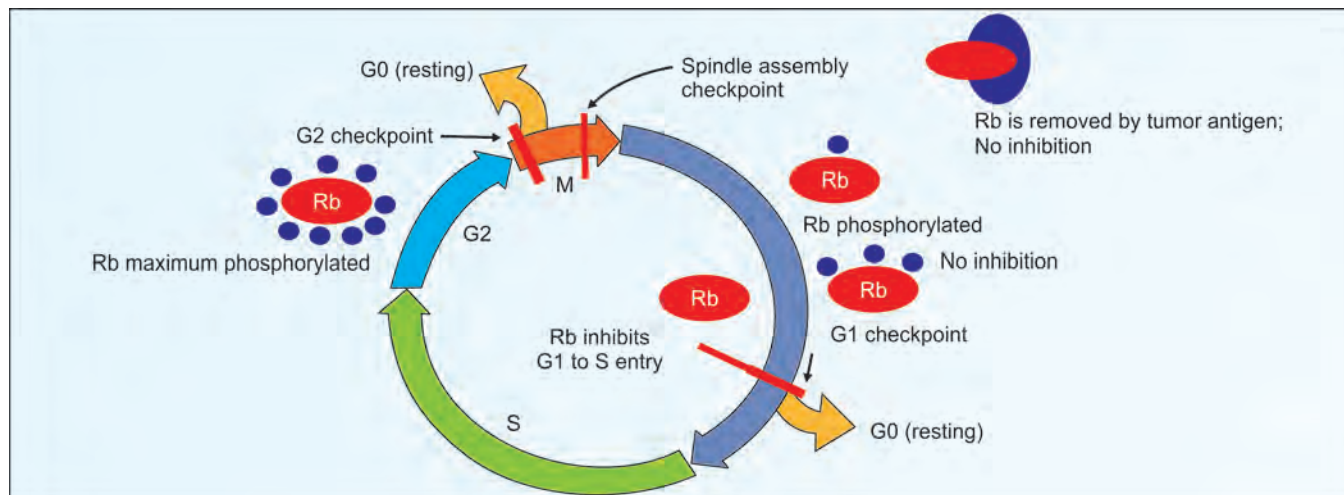
### Caspase Activation Cascade

CASPASE is the acronym for “Cysteiny l aspartate specific protease”. They are proteases with cysteine in their active centre. **Caspases 1 to 10** are identified; they are named in the order of their discovery. All these enzymes are secreted as inactive zymogen form; they are activated one by one. The caspase 8 is the first one activated, which is otherwise called the initiator. The final one is caspase 3, the executor of death, which is officially named as “*Yama*”, the *Hindu* God of Death. Caspase 3 will hydrolyze certain target proteins, like those maintaining cytoskeleton. Cytochrome c, when released from mitochondria into cytosol activates procaspase 9 to caspase 9. This causes activation of the whole pathway (Fig. 47.6B).

## REGULATION OF GENE EXPRESSION

### Induction and Repression

- i. Pioneer in genetic studies, Ochoa was awarded Nobel Prize in 1959. Synthesis of proteins under the influence



**Fig. 47.5:** Cell cycle controls or Checkpoints. Retinoblastoma protein inhibits cell cycle at G1 checkpoint. Body circumvents this block by phorsphorylation of Rb protein. This is done normally by cyclin D-CDK. Tumor antigens will attach with Rb protein, so Rb inhibition is lost; there will be uncontrolled cell division, leading to cancer

of gene is called **gene expression**. All genes of the cell are not expressed at all the time. For example, the insulin gene is expressed only in the beta cells of pancreas; but not in other tissues. In other words, insulin gene is in the state of **repression** in all other cells.

- ii. Some genes are expressed almost always in all cells. For example, enzymes of glycolysis are synthesized by all cells. Such genes are called **constitutive** genes or housekeeping genes.
- iii. The same gene may be alternatively opened and shut, as per the need of the metabolism. Such regulation is done by induction and repression mechanisms.
- iv. **Induction** is the phenomenon of increased synthesis of protein or enzyme in response to certain signal. Such enzymes are said to be **inducible**; and the signals are called **inducers**.
- v. Induction is turning “on” the switch of the gene. **Repression** is turning “off” the gene expression.

## Operon Concept of Gene Regulation

Francois Jacob and Jacques Monod put forward the operon concept in 1961, for which they were awarded Nobel prize in 1965. Andre Lwoff who worked on derepression was also received the Nobel prize in 1965. Jacob and Monod theory was based on the observations on lactose metabolism in *Escherichia coli* (bacteria). Cells grown in glucose medium do not contain beta-galactosidase (lactase). But when cells are transferred to a medium containing only lactose, then the enzyme level in the cell increases several thousand fold. Thus, lactose metabolism is regulated by an induction or derepression process.

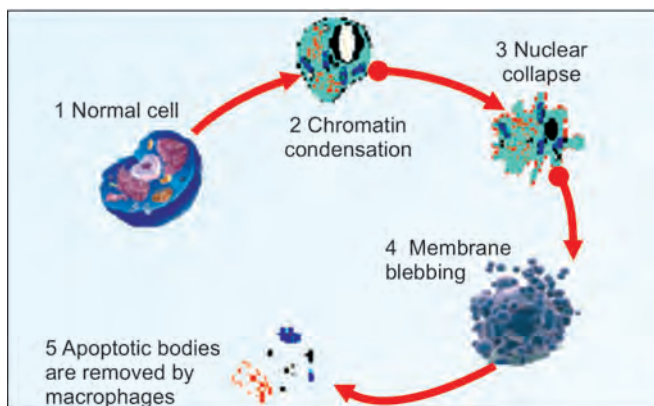


Fig. 47.6A: Salient features of apoptosis

## The Lac Operon

- i. Operon is a unit of gene expression; it includes structural genes, control elements, regulator/inhibitor gene, promoter and operator areas.
- ii. In the bacterial cell, the Z gene encodes beta-galactosidase, the enzyme which hydrolyzes lactose to galactose and glucose.
- iii. The Y gene is responsible for production of a permease which transports lactose and galactose into the cell. The A gene codes for thiogalactoside transacetylase.
- iv. Since Z, Y and A code for the structure of the proteins, they are called **structural genes**. These three genes are present as contiguous segments of DNA (Figs 47.7A and B).
- v. The transcription of these genes start from a common **promoter (P)**, located close to the Z gene. The RNA polymerase binds to the promoter and transcribes these three structural genes as a single mRNA.

## Transcription is Normally Repressed

- i. Transcription of the structural gene is under the control of another **regulator** or the “i” (**inhibitor**) gene. It is far away from the structural genes.
- ii. Regulatory gene produces a **repressor** molecule. The lac repressor has a molecular weight of 150 kD.
- iii. The lac repressor has strong affinity to the operator site. The operator region is 27 bp long, to which the repressor tightly binds. The operator site is between the promoter and structural genes (Fig. 47.7A).

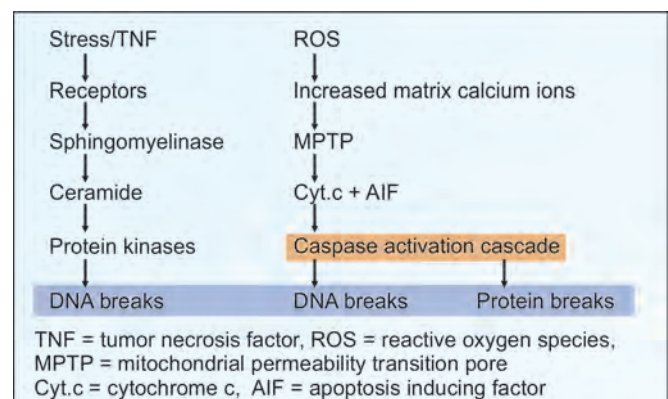


Fig. 47.6B: A simplified pathway of apoptosis

- iv. When RNAP identifies the promoter sequence and moves towards the structural genes, it is stopped by the hindrance produced by repressor molecule. This is like the action of a zip. If a thread is placed across its way, the zip cannot move further. Similarly, when repressor is attached to the operator, RNAP cannot move further. So, structural genes are not transcribed.
- v. Thus, when lactose is not available, the lactose utilizing enzymes are not synthesized (Fig. 47.7A).

### Derepression of Lac Operon

- i. When lactose is introduced into the medium, lactose binds to the repressor protein; one molecule on each subunit (Fig. 47.7B).
- ii. Repressor-lactose complex is inactive, which does not bind to the operator region. So there is no repressor molecule at the operator site.
- iii. Now, RNAP can transcribe the structural genes, which are then translated (Fig. 47.7B).
- iv. Thus lactose switches the genes “on”. Lactose induces the synthesis of lactose utilizing enzymes. Hence, lactose is an **inducer** of these genes and the mechanism is said to be **derepression** of the gene. Such regulation, where several proteins are regulated as one unit, is termed as **coordinate** gene regulation.

### Fine-regulation of Lac Operon

When the culture medium contains both glucose and lactose, the bacteria preferentially utilize glucose. Only when glucose is exhausted, lactose is

metabolized. Thus lac operon is induced by lactose only when glucose is not available. It was thought that the repression of lac operon is by some catabolite of glucose; hence this was called **catabolite repression**. This is now known to be mediated by the catabolite activator protein (**CAP**). The RNA polymerase can attach to promoter site, only when CAP combined with cyclic AMP (cAMP) is available. CAP-cAMP regulator is acting as a positive regulator. It is necessary for gene expression. Bacteria accumulate cAMP only when starved. When glucose is exhausted, cAMP is available in plenty and so CAP-cAMP complex is formed. Then RNAP can identify the promoter site. Thus lac operon is controlled by two factors; one that acts positively through CAP-cAMP complex, and the second one acts negatively through lac repressor that antagonizes binding of RNA polymerase to the promoter.

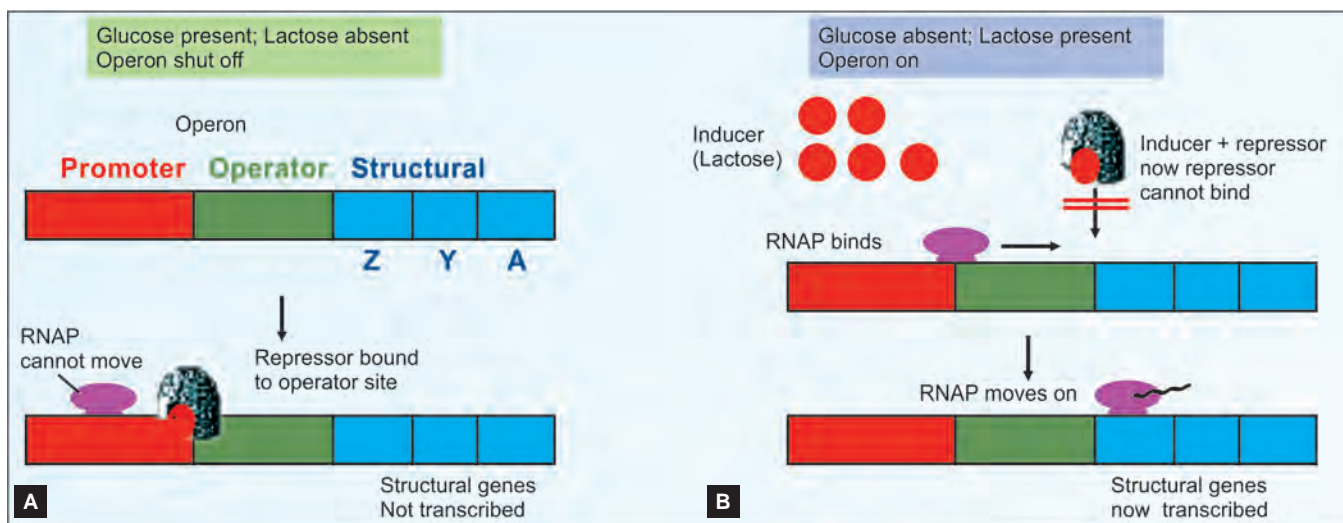
In case of mutation in lac operon, and the product is not able to bind the operator site, there will be constitutive expression of lac gene. Or, mutations in the lac operator region will not allow binding of normal repressor molecule; leading again to constitutive expression of lac gene.

### Clinical Applications

Lactase in human intestine is an inducible enzyme. Clinical manifestations of lactase deficiency and lactose intolerance are described in Chapter 9. In humans, examples of derepression include induction of tryptophan pyrrolase, and transaminases by glucocorticoids; as well as ALA synthase by barbiturates.

### Regulation of Genes by Repression

- i. Repression is the mechanism by which the presence of excess product of a pathway shuts off the synthesis of the key enzyme of that pathway.
- ii. Heme synthesis is an example. It is regulated by repression of **ALA synthase**, the key enzyme of the

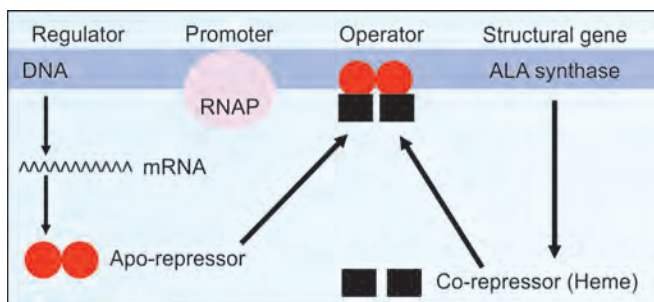


**Figs 47.7A and B:** (A) Repression of Lac operon. When lactose is absent, repressor molecules bind to the operator site. So RNAP cannot work, and genes are in “off” position. (B) Induction or Derepression of Lact operon. Lactose attaches to repressor; so repressor cannot bind to operator site which is free; genes are in “on” position; protein is synthesized



pathway (see Chapter 21). Transcription of structural gene for ALA synthase is controlled by a regulatory gene. It produces the **apo-repressor**, which binds with heme and becomes the active holo-repressor. Here heme acts as the **co-repressor** (Fig. 47.8).

- iii. The **holo-repressor** binds to the operator and stops transcription of the gene. Upstream to the structural genes lies the promoter site, where the RNA-polymerase (RNAP) attaches and starts mRNA synthesis. The operator site is in between promoter and structural genes. So when RNAP reaches operator site, it cannot move further (Fig. 47.8). So enzyme synthesis stops, and hemesynthesis slows down.
- iv. On the other hand, when heme is not available, co-repressor is not available, therefore, repression is not effective and enzyme synthesis starts. Thus, the synthesis of heme is autoregulated by the repression mechanism.
- v. Thalassemia is a condition when normal globin chains are produced in abnormal ratios (see Chapter 22). When alpha-chain synthesis is blocked due to a mutation on the promoter, there is compensatory increase in beta-chain synthesis. Instead of the  $\alpha_2\beta_2$  combination for normal hemoglobin, an abnormal  $\beta_4$  combination results.



**Fig. 47.8:** Repression by heme on the enzymes responsible for heme synthesis



Martin  
Chalfie  
NP 2008  
b 1947



Osamu  
Shimomura  
NP 2008  
b 1928



Roger  
Tsien  
NP 2008  
b 1952

The regulation of gene expression in eukaryotic cells is more complex. However, some common features have been identified (1) Organization of DNA into chromatin and DNA modification, (2) Assembly of general transcription factors (GTFs) at promoter site favoring binding of RNAPII and (3) Activation of transcription of specific genes by specific transcription factors that bind to response elements on the DNA.

Methylation of cytosine residues will lead to silencing of genes. About 70% of CpG sequences in human DNA are methylated and is mainly implicated in genomic imprinting which leads to choice of allelic expression. The role of small interfering RNA (siRNA) in gene silencing by induction of DNA methylation is being studied with great interest. Methylated DNA is recognized by proteins which prevent binding of transcription factors, which would otherwise facilitate gene expression.

The formation of an assembly of general transcription factors (GTFs) at the promoter site involves transcription factor II D (TFIID) and TATA binding protein (TBP). The appropriate interaction of RNAPII with the promoter is facilitated by the TF assembly. This is a general mechanism of transcription regulation and the eukaryotic transcription factors have some common structural motifs like zinc finger, helix turn helix, helix loop helix, leucine zipper, etc.

In the case of specific signal molecules regulating transcription, there are certain sequences on DNA called response elements, where transcription factors bind. The activation of these transcription factors requires either hormones that function as coactivators or other growth factors and cytokines which activate the transcription factors by dimerization and or phosphorylation.

## Hormone Response Elements (HRE)

In higher organisms, hormones or their second messengers function as inducers. Many hormones, particularly steroid hormones, elicit physiological response through controlling gene expression (Fig. 47.9). Glucocorticoids attach to a cytoplasmic receptor; then the receptor-hormone complex translocates to the nucleus. It finally attaches on the HRE in the DNA. The receptor binds at the enhancer region, which activates the promoter, so that transcription is accelerated. Examples are receptors for glucocorticoid, mineralocorticoid, progesterone, androgen, estrogen, thyroxine, vitamin D and retinoic acid.

**Hormone-receptor superfamily** includes receptors for glucocorticoid, mineralocorticoid, progesterone, androgen, estrogen, thyroxine, vitamin D, retinoic acid and erbioncogene protein. All these receptors have a conserved DNA-binding region in the middle and a conserved C-terminal hormone-binding site. When hormone binds, the receptor molecule becomes dimerised, which then specifically binds the HRE region of the DNA (see Table 50.2).

Abnormalities of different proteins in transcription regulation can lead to several disease states or provide therapeutic targets. Some examples are:

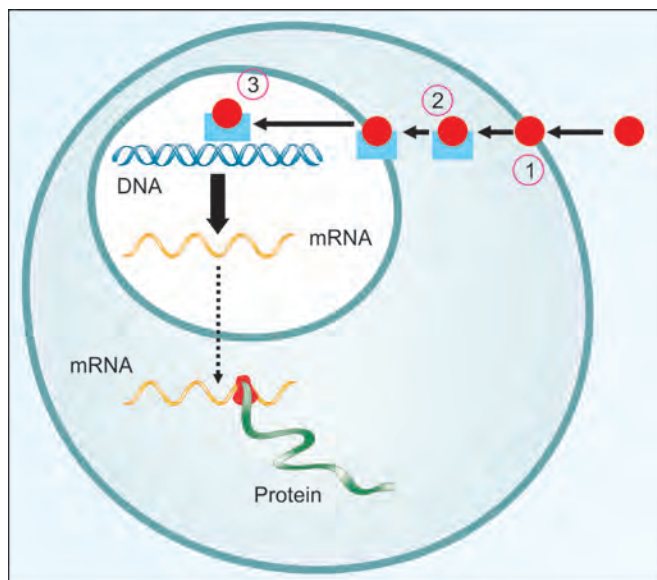


- i. Use of Tamoxifen, an inhibitor of estrogen receptor in treatment of carcinoma breast
- ii. Inhibition of DNA methylation to prevent silencing of Tumor suppressor genes (epigenetic modification)
- iii. Mutation in several transcription factors are now being identified to be the cause for several genetic disorders, e.g. Holt-Oran syndrome, Rubinstein-Taybi syndrome.
- iv. Huntington's disease is a devastating genetic disorder that causes degeneration of nerve cells in the brain. There is no known cure or treatment for the disease. It starts with changes in mood, memory, and leads to increasing physical disability, dementia and death. Individuals with Huntington's disease over-expressed the gene, H2AFY, in both the blood and brain. The expression of H2AFY was diminished in persons who received the drug sodium phenylbutyrate.

### Gene Amplification

This is a mechanism by which gene expression is increased thousand-fold. In *Drosophila* (fruit fly), during oogenesis, an amplification of a few genes of egg-shell protein occurs. This is generated by a process of repeated initiation of DNA synthesis. In electron microscopy, it is seen as a big replication bubble.

Such a mechanism is operating in human beings also. **Methotrexate** is a widely used anticancer drug, which acts by inhibiting dihydrofolate reductase (see Chapter 43). In patients receiving methotrexate for a long time, the malignant cells are seen to develop drug resistance by increasing the number of genes for dihydrofolate reductase by gene amplification. Oncogenes are also shown to be amplified in many cancer cells.



**Fig. 47.9:** Steroid hormone binds to the HRE (hormone response element) region of DNA, leading to gene activation. 1 = Steroid hormone reaches cytoplasm; 2 = Hormone binds with cytoplasmic receptor. 3 = Hormone binds HRE

### Gene Switching

Sometimes, one gene is switched off while a closely-related gene takes up its function. A good example is the **hemoglobin** synthesis. In embryo, hemoglobin is made up of 2 zeta and 2 epsilon chains. By the 6th month of intrauterine life, this is changed to HbF, consisting of alpha-2-gamma-2 chains. After birth, HbF is replaced by adult types of Hb, 97% HbA1 (alpha-2-beta2 chains) and 3% HbA2 (alpha-2-delta-2 composition) (see Chapter 22). Thus the gene expression is switched from epsilon-zeta to alpha-gamma and later to alpha-beta or alpha-delta.

Another example of gene switching is seen in the **immunoglobulin** (Ig) synthesis. During the primary immune response, IgM antibodies are produced. In the secondary immune response, IgG antibodies are seen. Thus switching of gene from IgM to IgG is taking place (see Chapter 55). Somatic recombination is described in Chapter 55. The process of gene switching is controlled by transcription factors that are expressed at specific periods to produce the appropriate globin chain. (See chapter 22 for details)

Similar proteins evolved from same gene, which undergo divergent evolution are called **paralogs** (e.g. hemoglobin and myoglobin). Orthologs are genes from different species evolved from a common ancestral gene (e.g. human and pork insulin).

### ■ VIRUSES

Viruses are absolute parasites on living cells. They contain only the bare minimum of genetic information for survival and replication. Salvador Luria in 1942 showed that viruses are visible only by electron microscopy. Alfred Hershey proved that nucleic acids, but not proteins, are the genetic material in viruses. Both got Nobel prize in 1969. Viruses generally bind to specific receptors on the host cell surface (Fig. 47.10). Binding of viruses involve specialized microdomains on the host cell membranes, the lipid rafts and the glycans. For example, binding of HIV to CD4 receptor occurs in lipid raft areas through GP120 (glycoprotein of the virus). Influenza virus binds NANA (N-acetyl neuraminic acid) residues on glycoprotein receptors on cell surface through hemagglutinin (H). The neuraminidase (N) present in the virus plays an important role in budding of new virions. There are 16 types of H and 9 types of N antigens that make the different strains of influenza virus. For example, avian flu virus has H5N1, and swine flue virus has H1N1 antigens. After entry into the host cell, the viruses utilize the host cell machinery for growth and replication.



Joshua Lederberg  
NP 1958  
1925–2008



Max Delbrück  
NP 1969  
1906–1981



Salvador E Luria  
NP 1969  
1912–1991



Alfred D Hershey  
NP 1969  
1908–1997

## Antiviral Agents

Usual antibiotics will not affect the replication of viruses. There are only a handful of antiviral drugs available, when compared to the vast array of antibacterial agents. This is because viruses are intracellular and secondly the virus utilizes the host cell machinery for its replication. They act at different steps of the virus cycle (Fig. 47.10).

**Site 1:** Adsorption and penetration of virus into host cell is inhibited by **antibodies**, either passive or active. Neuraminidase inhibitors can be used in the treatment of influenza virus infections, e.g. **oseltamivir** (Tamiflu) and **zanamavir**. Mutations in the virus at the neuraminidase binding site can lead to resistance to the drug.

**Site 2:** Uncoating of viral nucleic acid is prevented by **amantadine**. It is used in treatment and prophylaxis of influenza virus.

**Site 3:** Synthesis of DNA is inhibited by purine or pyrimidine analogs. **Acyclovir** is an analog of Guanosine. It was developed by Gertrude Elion and George Hitchings, who were awarded Nobel prize in 1988. In the host cell, it is first phosphorylated by the virus-specific thymidine kinase; then triphosphate form is produced by the cellular enzymes. The resulting nucleotide inhibits the viral DNA polymerase. This explains the high selectivity against the virus. **Iodo-deoxyuridine** is the first antiviral drug marketed. It is used for topical application. **ribavirin** is a guanosine analog. It inhibits capping of viral mRNA. It is useful against respiratory syncytial virus and viral hemorrhagic fever.

**Site 4:** Synthesis of RNA is abolished by inhibitors of reverse transcriptase. **zidovudine** is a deoxythymidine analog. It is useful against HIV infection. **didanosine** (di-deoxy inosine) also inhibits reverse transcriptase and is used in HIV infection.

**Site 5:** Late protein synthesis is controlled by protease inhibitors, such as **ritonavir**, saquinavir and Indinavir. They are used against HIV infection.

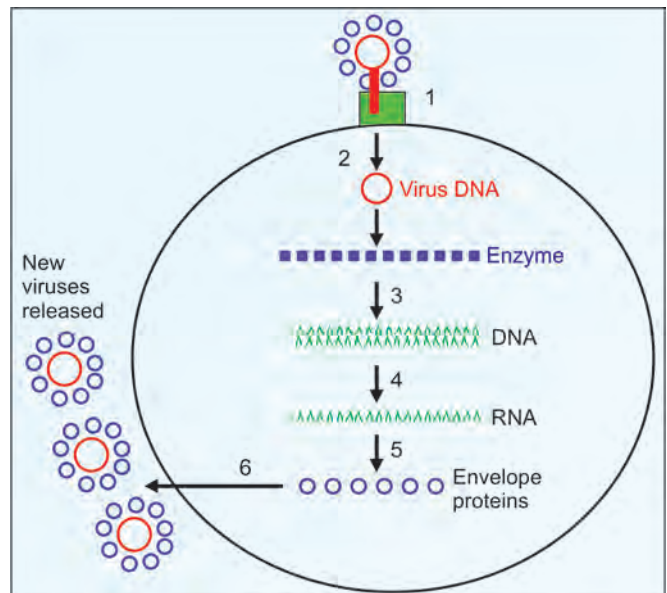
## Identification of Virus Infection in Host

Virus infection in patients is generally identified by demonstration of specific antibodies in the serum or by detection of virus in the host cells or fluids. Most viruses are grown in tissue culture cells. For example, Herpes simplex virus, if introduced into a culture of Vero cell line (monkey kidney cells), the virus produces lysis of cells. This is called **cytopathic effect**. Viruses were first grown in tissue culture by John Enders (Poliomyelitis), Frederick Robbins (Herpes simplex virus) and Thomas Weller (Varicella virus); all the three were awarded Nobel prize in 1954.

## Lytic Cycle and Lysogeny

Normally, virus is replicated inside the cell. Viral particles (virions) are released from the cell. Most often the host cell is lysed during this process. This is called lytic cycle. Instead of the lytic process, some viruses remain **dormant** for months or years inside the host cells. Herpes simplex virus (HSV) and varicella zoster virus are examples of dormant viruses in human cells producing recurrent manifestations. Sometimes the whole virus, or certain parts of virus may be **integrated** into the cellular DNA, this may lead to malignant transformation (see Chapter 57).

Viruses infecting bacteria are called **bacteriophages**. The lambda phage is a DNA virus. It enters the host bacteria, multiplied quickly, then the host cell is lysed and free viral particles come out, to infect neighboring cells. This is the **lytic cycle**. Instead, under certain conditions, virus enters in the **lysogenic pathway**. Viral DNA becomes



**Fig. 47.10:** Lifecycle of viruses in general. The numbers show the site of action of antiviral drugs mentioned in the text. 1= virus entry through receptor; 2 = uncoating; 3 = DNA synthesis; 4 = RNA synthesis; 5 = late protein synthesis; 6 = packaging or assembly of new daughter viruses

integrated into the bacterial DNA, and replicates as a part of host DNA. This stage is called dormancy of virus or prophage. This dormancy can be “induced” or “activated” by UV irradiation, iododeoxy uridine, etc. which damages DNA. This switch from dormant phase to lytic infection is as follows:

In the lambda DNA, there is the OR (operator right) gene. When the repressor gene is “on”, the Cro gene is off. OR1 region is the Cro promoter and OR3 is the repressor. In the dormant state, RNAP (RNA polymerase) can fix on OR3 region and repressor gene is transcribed. The repressor protein is synthesized, which binds on the OR1 region. Therefore, Cro promoter is blocked (Fig. 47.11, upper part).

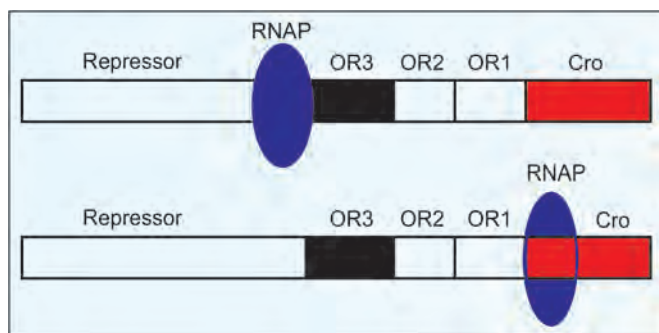
Under UV irradiation, fragments of single-stranded DNA are generated. These activate another bacterial gene, *recA*, which produces a specific protease. This protease hydrolyzes the lambda repressor protein. Now OR2 and OR1 are free. The RNAP starts transcribing Cro gene. The Cro protein now binds OR3. Thus the repressor gene is turned “off”, so that all other lambda genes are turned “on”. The lytic cycle ensues (Fig. 47.11, lower part).

### Transduction Process

Occasionally, the virus carries a portion of host DNA. Subsequent infection of a new host by such a virus may introduce new genes to the new host. This is called viral transduction. This process was studied by Joshua Lederberg (Nobel prize 1958) and Max Delbruck (Nobel prize 1969). This can be considered as genetic engineering by nature, or horizontal transmission of genes.

### Viruses as Jumping Genes

Viruses may be considered as genes escaped from the existing cells of a lower evolutionary scale; they are jumping genes (see also oncogenes and viral integration in Chapter 57). The advantage imparted by virus may be the transfer of genes horizontally. Fossil records show that exoskeleton appeared in different species more or less simultaneously. About 160 million years ago, ammonites with exoskeletons appeared all over the world. These organisms are very slow moving; but the gene moved rapidly throughout the world. It may be that the gene for alkaline phosphatase has originated in few organisms, which was then transferred horizontally within a short period of paleobiology. Thus, evolutionary



**Fig. 47.11:** Upper part, repressor gene of phage lambda is “on”, while Cro gene is “off”. Phage is in the dormant stage. Lower part, Cro gene is “on” and repressor gene is “off”. RNAP can now transcribe all the genes; thus lytic phase is started. RNAP = RNA polymerase

process is accelerated by viruses. In that case, cancer is the deferred payment by the individual for the benefit availed by the species as a whole.

### Epigenetic Modifications

This is a mechanism that results in stable propagation of gene activity states from one generation of cells to the next. The epigenetic modifications include changes in histones and DNA methylation. Epigenetic states can be modified by environmental factors which may result in the expression of abnormal phenotypes. These epigenetic modifications control gene expression and changes are also inherited.

Genetic code is comparable to writing in indelible ink using the sequence of 4 nucleotides. This information is normally transferred from generation to generation with high fidelity. Information provided by epigenome is like a code written in pencil which can be erased and rewritten. The epigenome is represented by methyl groups attached to DNA base cytosine and certain covalent modifications in histones. Unlike genetic information that distinguishes one person from another (molecular fingerprint) the epigenome distinguishes one cell type from another. Any mistakes that occur (**epimutations**) can be erased in the same germ line. However, at times pencil writing leaves smudges even after erasing, similarly, the epimutations may be transmitted to the next generation. But all the offspring are not affected and even affected persons may not transmit the defect to their progeny, since the genetic imprints are erased and rewritten. Epigenetic modifications referred to as genomic imprinting occurs very early in the embryo.

Certain reactions will not produce any effect on the DNA sequence; but the expression of a gene (protein structure) may be altered. For example, methylation of controlling elements in DNA leads to selective silencing of genes. This will explain genomic imprinting. In Prader-Willi syndrome, a mutant gene is derived from father and in Angelman syndrome, the mutant gene is from mother. In some other cases, mutation produces an abnormal protein, which is non-functional; but interferes with the functions of a normal gene of a normal allele. For example, in osteogenesis imperfecta type I, the abnormal protein interferes with normal triple helix formation of collagen. This is a dominant negative effect. Transcription factors play a crucial role in eukaryotic gene expression. Epigenetic modification of core histones (acetylation of specific lysine residues) facilitates an open structure and permits access to transcription factors for interaction with DNA. On the other hand, methylation at the CG sequence of the promoters transcriptionally inactivates chromatin.

Methylation occurs naturally on cytosine bases at CpG sequences and is involved in controlling the correct expression of genes. DNA methylation is usually associated with triggering histone deacetylation, chromatin condensation, and gene silencing. Differentially methylated cytosines give rise to distinct patterns specific for each tissue type and disease state. Such methylation-variable positions (MVPs) are not uniformly distributed throughout our genome, but are concentrated among genes that regulate transcription, growth, metabolism, differentiation, and oncogenesis. Alterations in MVP methylation status create epigenetic patterns that appear to regulate gene expression profiles during cell differentiation, growth, and development, as well as in cancer. Environmental stressors including toxins, as well as microbial and viral exposures, can change epigenetic patterns and thereby effect changes in gene activation and cell phenotype. Since DNA methylation is often

retained following cell division, altered MVP patterns in tissues can accumulate over time and can lead to persistent alterations in steady-state cellular metabolism, responses to stimuli, or the retention of an abnormal phenotype, reflecting a molecular consequence of gene-environment interaction.

The occurrence of **large offspring syndrome** in cattle is attributed to exposure of embryos in vitro to environmental changes. A similar condition, **Beckwith-Wiedemann syndrome**, which is an imprinted disorder was found to occur with increased frequency in children born by “assisted reproductive technologies”. Therefore, environmental factors might cause epigenetic modification of DNA leading to alteration of “imprinted gene expression”.

Alterations in gene expression are implicated in the pathogenesis of several neuropsychiatric disorders, including drug addiction and depression. Changes in gene expression in neurons, in the context of animal models of addiction and depression, are mediated in part by epigenetic mechanisms that alter chromatin structure on specific gene promoters.

### Aptamers

Aptamers are oligonucleotides that exhibit specificity against amino acids, drugs, proteins and other biomolecules. They are useful to purify other molecules. Aptamers, first reported in 1990, are attracting interest in the areas of therapeutics and diagnostics. They are ideal candidates for use as biocomponents in biosensors.

### Clinical Case Study 47.1

A healthy 10-year-old boy interested in sports started complaining of muscle cramps and weakness of lower limbs after the sports. On examination, he had mild wasting of the

lower limb muscles. History revealed that his mother had a younger brother, who had a similar illness to which he succumbed around the age of 20.

- A. What is the most probable cause?
- B. What are the investigations to be done?
- C. How does history give a clue in this case?
- D. What is the prognosis?
- E. Explain the nature of inheritance in this case.

### Clinical Case Study 47.1 Answer

X-linked muscular dystrophy. Creatinine in urine and CK in blood will be increased.

### QUICK LOOK OF CHAPTER 47

1. Mutations can be acceptable (Hb Bristol), partially acceptable (HbS) or unacceptable (HbM).
2. Mutagenicity of a compound can be detected by the Ames’ test.
3. Cell cycles have 5 phases: G<sub>0</sub>, M, G<sub>1</sub>, S and G<sub>2</sub>.
4. Caspases are ‘cysteinyll aspartate specific protease’. Ten caspases have been identified and participate in an activation cascade to bring out the effect.
5. Operon is a unit of gene expression. It includes structural genes, control elements, regulator/inhibitor gene, promoter and operator areas, e.g. Lac operon.



# CHAPTER 48

## Recombinant DNA Technology and Gene Therapy

### Chapter at a Glance

The reader will be able to answer questions on the following topics:

- Recombinant DNA technology
- Restriction endonucleases
- Vectors
- Molecular cloning
- Gene therapy

### RECOMBINANT DNA TECHNOLOGY

- Biotechnology may be defined as “the method by which a living organism or its parts are used to change or to incorporate a particular character to another living organism”.
- Biotechnology** involves the application of scientific principles to the processing of materials by biological agents.
- The use of new varieties of microorganisms to breakdown pollutants in soil or water to harmless end products is known as **bioremediation**.
- Genetic recombination** is the exchange of information between two DNA segments. This is a common occurrence within the same species. But by artificial means, when a gene of one species is transferred to another living organism, it is called **recombinant DNA technology**. In common parlance, this is known as *genetic engineering*.

### Applications of Recombinant Technology

#### *Quantitative Preparation of Biomolecules*

If molecules are isolated from higher organisms, the availability will be greatly limited. For example, to get 1 unit of growth hormone, more than 1000 pituitaries from cadavers are required. By means of recombinant technology, large scale availability is now assured.

#### *Risk of Contamination is Eliminated*

It is now possible to produce a biological substance without any contamination. Hepatitis, caused by the hepatitis B virus (HBV), is highly contagious. A vaccine is prepared from the hepatitis B virus surface proteins, which will give protection from infection. Originally the virus was isolated from pooled blood of patients, and the specific protein was isolated. However, blood of hepatitis patients is known to be highly infective. It is absolutely essential to make

sure that the preparations of vaccines or clotting factors are free from contaminants such as hepatitis B particles. Recombinant DNA technology provides the answer to produce safe antigens for vaccine production.

### Specific Probes for Diagnosis of Diseases

Specific probes are useful for:

- i. Antenatal diagnosis of genetic diseases. For example, many of the single gene defects (e.g. cystic fibrosis, phenyl ketonuria, etc.) could be identified by taking cell samples from fetus.
- ii. To identify viral particles or bacterial DNA in suspected blood and tissue samples.
- iii. To demonstrate virus integration in transformed cells.
- iv. To detect activation of oncogenes in cancer.
- v. To pinpoint the location of a gene in a chromosome.
- vi. To identify mutations in genes and for pedigree analysis: point mutations, deletions, insertions and rearrangements of DNA could be identified. Sickle cell disease is an example of point mutation (see Chapter 22). The substitution of T for A in the template strand of DNA in the beta globin gene changes the MstII restriction site (see Chapter 49). Thus normal, heterozygous and homozygous individuals in the family could be identified.

### Gene Therapy

An important application of recombinant technology is in gene therapy. Normal genes could be introduced into the patient so that genetic diseases can be cured. These techniques are described later.

### Restriction Endonucleases (RE)

The principle of DNA recombinant technology is summarized in Figure 48.4. In order to transfer a gene, it is to be first selectively split from the parent DNA. This is usually achieved by restriction endonucleases which are referred to as “molecular scissors”.

TABLE 48.1: Specificity of restriction enzymes (The arrows show the site or cut by the enzyme)		
Enzyme	Source of enzyme	Specific sequence identified by the enzyme
Eco RI	<i>Escherichia coli</i> RY 13	G $\uparrow$ AATT C C TTAA $\downarrow$ G
Hind III	<i>Haemophilus influenzae</i> Rd	A $\uparrow$ AGCT T T TCGA $\downarrow$ A
Taq I	<i>Thermus aquaticus</i>	T $\uparrow$ CG A A GC $\downarrow$ T
Hpa I	<i>Haemophilus parainfluenzae</i>	GTT $\uparrow$ AAC CAA $\downarrow$ TTG

Werner Arber showed that certain enzymes of bacteria restrict the entry of phages into host bacteria. Hence, the name restriction endonucleases. Hamilton Smith in 1970 isolated the first restriction enzyme beta Hind-I. Daniel Nathans in 1971 for the first time applied the enzyme to cut the DNA. All the three got Nobel prize in 1978. Paul Berg (Nobel prize 1980) developed the cutting technique for recombinant DNA. The restriction endonucleases are named after the species and strains of bacteria and the order of discovery. For example, the enzyme Eco RI is isolated from *Escherichia coli* RY13 strain. The Roman numeral “one” indicates the order of discovery of an enzyme from that species. Restriction enzymes are isolated from bacteria.

### Restriction Sites

Restriction endonucleases have specific recognition sites where they cut the DNA. (Table 48.1). There are more than 800 such enzymes now available commercially. These enzymes recognize specific sequence with **palindrome** arrangement. Palindrome in Greek means “to run backwards”. It is similar to a word that reads backwards or forwards similarly, e.g. “madam”. These are also called **inverted repeat** sequences, which means the nucleotide sequence in 5’ to 3’ direction is the same in both strands. The resultant DNA cuts will generally have overlapping or sticky ends (Fig.48.2). Restriction endonucleases may also produce blunt ends, e.g. Hpa-I.

### Restriction Map

The recognition site will be about 4 to 7 nucleotide pairs. If a piece of DNA from a species is made to react with a specific RE, a characteristic array of cut pieces will be produced, these are called restriction fragments. The same piece of DNA may be cut with a different enzyme to produce a different set of restriction fragments (Fig 48.1). By electrophoretic separation of overlapping fragments, a restriction map can be created. The study of the restriction map using suitable probes of short tandem repeats (STR) helps in developing a “DNA fingerprint” which is characteristic of each individual/organism. The restriction maps of lambda phage DNA with two restriction enzymes are given in Figure 48.1.

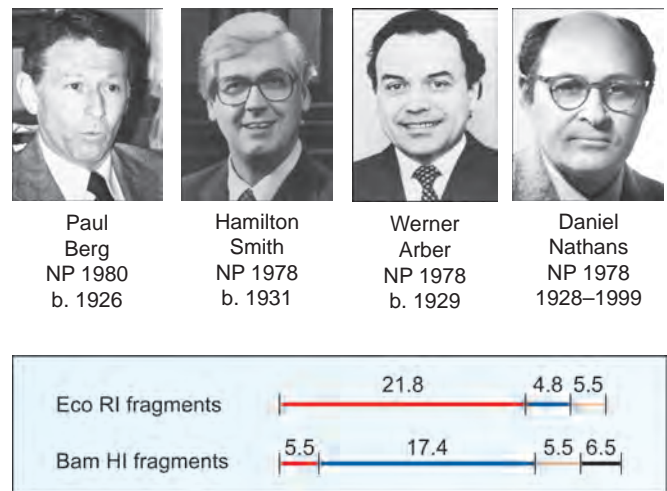


Fig. 48.1: Restriction map of DNA from lambda bacteriophage. The numbers denote the length of restriction fragment in kbp

## VECTORS

In order to introduce the human gene into bacteria, at first, the gene is transferred to a **carrier**, known as a **vector**. Most commonly used vectors are **plasmids**. Plasmids are circular double-stranded DNA molecules seen inside bacteria. In nature, plasmids confer antibiotic resistance to host bacteria. This feature has profound significance in clinical practice because, **antibiotic resistance** property is exchanged between bacteria. Plasmids replicate independent of bacterial DNA. Foreign DNA could be incorporated into them by using specific RE.

### Bacteriophages and Cosmids

Plasmids can accept only about 6–10 kbp long foreign DNA. If a DNA segment of 10–20 Kbp is to be introduced, **bacteriophages** may be the vectors of choice. The lambda phage DNA is linear, 40% of genome is nonessential. Therefore in this region, a large fragment of foreign DNA may be introduced. Cosmid vectors can take up still bigger fragments of 20–50 kbp length. **Cosmids** are plasmids that contain DNA sequences (cos sites) required for packaging of lambda DNA into phage.

## Procedure of DNA Recombination

### Preparation of Specific Human Gene

Isolation of a specific gene from the human DNA is a laborious process. The beta globin gene is about 1.6 kbp length, which represents only 0.00005% of total human genes. This is like searching for a needle in a haystack. This problem is generally solved by preparation of cDNA (**complementary copy DNA**). It is easier to start the work with mRNA, because there is selective expression of a particular gene in certain tissue. For example, insulin mRNA will be abundant in the beta cells of pancreas. Another advantage of using the mRNA is that RNA will have only coding sequences, since introns are already removed by splicing process. From the specific mRNA, the cDNA is produced by using reverse transcriptase (RT) (Fig.48.3).

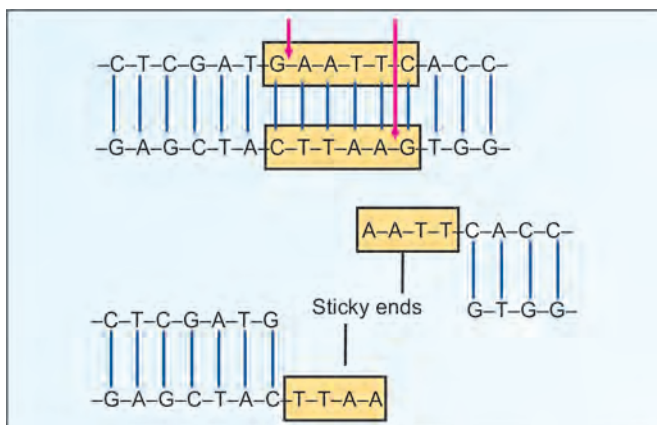


Fig. 48.2: Eco RI enzyme cuts the bonds marked with red arrow. This results in the sticky ends

## Preparation of Chimeric DNA Molecules

**Chimera** is the Greek mythological monster with a lion's head, goat's body and serpent's tail. Narasimha (lion's head and human body) is another example from Indian mythology. A vector carrying a foreign DNA is called chimeric DNA or hybrid DNA or Recombinant DNA. A summary of the procedure is given in Figure 48.3.

- i. A circular plasmid vector DNA is cut with a specific restriction endonuclease (RE). If EcoRI is used, **sticky ends** are produced with TTAA sequence on one DNA

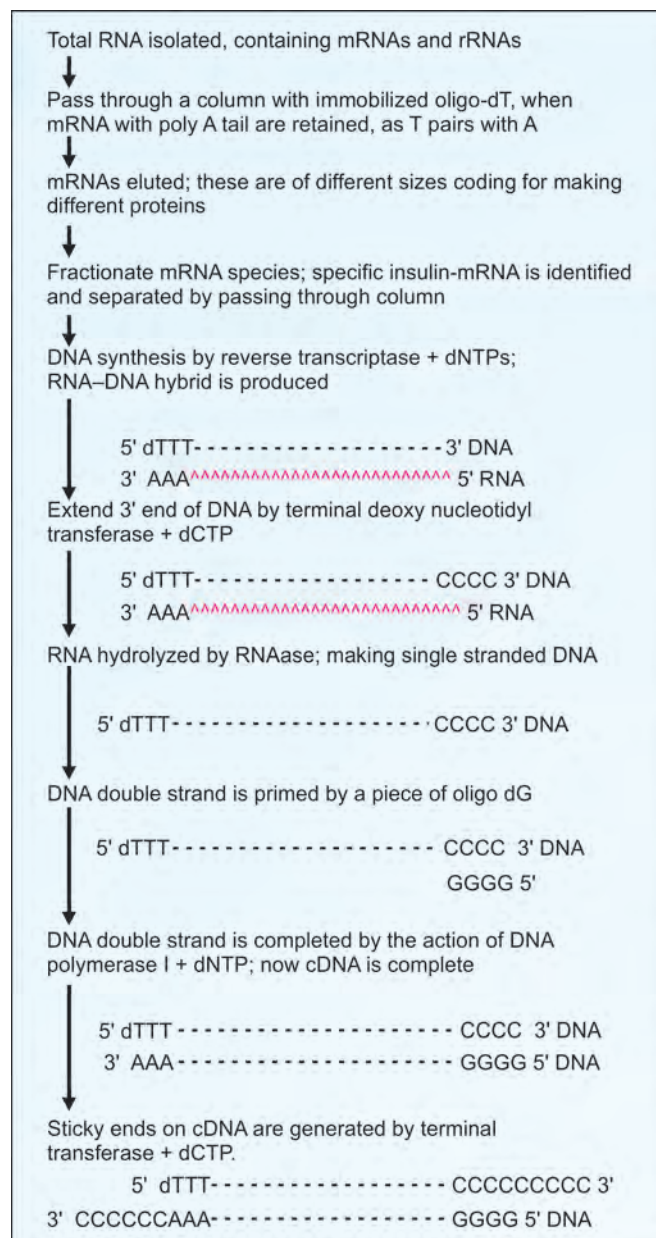


Fig. 48.3: Steps to produce cDNA from mRNA

- strand, and AATT sequence on the other strand (Table 48.1 and Fig. 48.4).
- ii. The human DNA is also treated with the same RE, so that the same sequences are generated at the sticky ends of the cut piece.
  - iii. Then the vector DNA and human cut-piece DNA are incubated together so that **annealing** takes place. The sticky ends of both vector and human DNA have complementary sequences, and therefore they come into contact with each other.
  - iv. Then **DNA ligase** enzyme is added, which introduces phosphodiester linkages between the vector and the insert molecules. Thus the chimeric DNA is finally produced.

### Homopolymer Tailing

The sticky ends of the vectors usually reconnect themselves without taking up the foreign molecule (recircularization). To circumvent this problem, homopolymer tailing is done in both vector and insert molecules. First the restriction enzyme, HpaI is used to produce blunt ends of vector. Then poly dG is added to the 3' end of foreign DNA and poly dC is added to the 3' end of vector DNA. When the two molecules are incubated, only hybrid varieties are formed.

### Cloning of Chimeric DNA

The next step is cloning. A clone is a large population of identical bacteria or cells that arise from a common ancestor molecule. Cloning allows the production of a large number of identical DNA molecules. The hybrid molecules are amplified by the cloning technique.

### Transfection of Vector into the Host

The process by which plasmid is introduced into the host is called *transfection*. Host *E. coli* cells and plasmid vectors are incubated in hypertonic medium containing calcium for a few minutes. Then calcium ion channels are opened, through which the plasmid is imbibed into the host cell. Now the host cells are allowed to grow in agar plates containing growth medium. Only 5% of bacterial colonies contain the desired vector. Therefore, we have to select the desired colonies.

### Plasmid Carries Antibiotic Resistance Genes

Plasmid pBR-325 vector contains *Apr* (ampicillin resistance), *Tcr* (tetracycline resistance) and *Cmr* (chloramphenicol resistance) genes (Fig. 48.5). The restriction

enzyme EcoRI will cleave the plasmid in the middle of *Cmr* gene. Now all plasmids have only two antibiotic resistance genes, one is inactivated by insertion. When the foreign DNA is inserted, the resistance against chloramphenicol is lost. This **insertional inactivation** of *Cmr* gene is the marker for hybrid DNA.

### Selection of Colony having Desired Gene

- i. After the transfection, the bacteria are cultured in a medium containing ampicillin and tetracycline. The antibiotics kill all the wild bacteria. Only the bacteria containing the plasmids will grow.
- ii. There will be many colonies, where the vector does not carry the foreign DNA. These colonies are replica-plated onto another agar

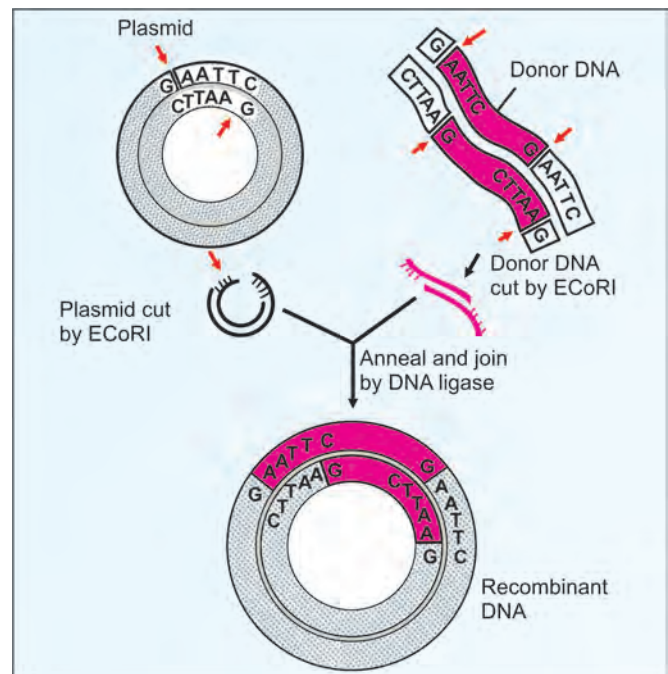


Fig. 48.4: Production of chimeric DNA molecule by using EcoRI restriction endonuclease. Red arrows show the site of cut by EcoRI

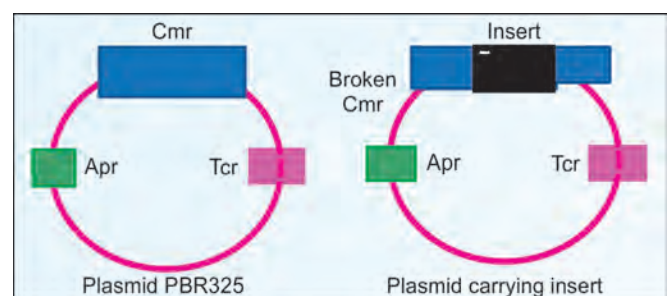


Fig. 48.5: Insertional inactivation of *Cmr* gene of plasmid  
*Cmr* = Chloramphenicol resistance gene. *Apr* = Ampicillin resistance gene; *Tcr* = Tetracyclin resistance gene



plate containing chloramphenicol. Since the insertion of foreign DNA abolishes chloramphenicol resistance, the desired colonies will not grow in the replica-plate.

- iii. Colonies in the original plate, corresponding to the dead colonies in the replica-plate are selected. They carry the foreign gene (Fig. 48.6).
- iv. These colonies are selected and further subcloned. The principle of gene transfer technology is summarized in Figure 48.7.
- v. Another technique of selecting colonies having plasmids with DNA insert is blue white screen. Here the plasmids have lac Z gene which is inactivated by insertion of target DNA. Hence, the blue product produced by the action of the beta galactosidase is not formed. Instead the colonies will appear white since the gene is interrupted by the DNA insert.

### Expression Vectors

To produce the human proteins, *E. coli* carrying the vector with the insert is allowed to grow, without any protein inhibitors. Such a vector carrying the foreign gene, which is translated into a protein, is called **expression vector**. The human proteins can be harvested from the bacterial culture.

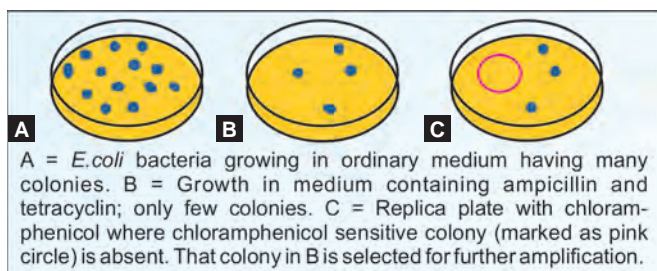


Fig. 48.6: Select the colony carrying hybrid DNA

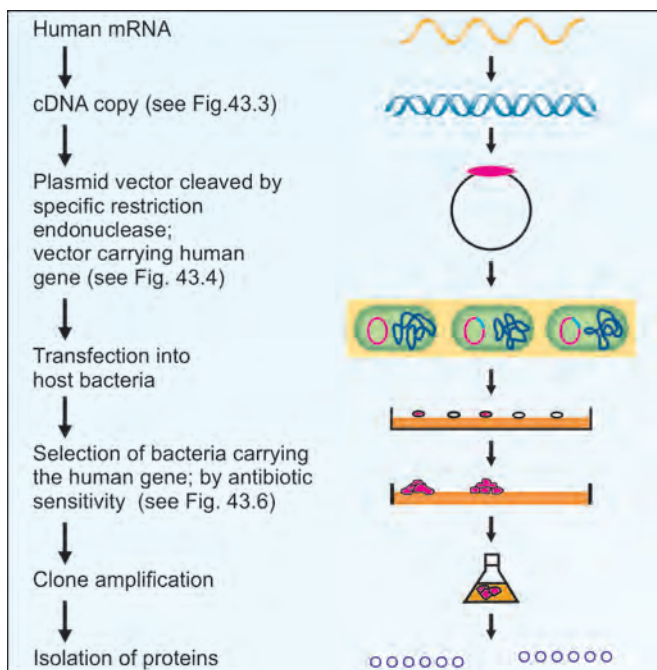


Fig. 48.7: DNA-recombinant technology

## Human Recombinant Proteins

Hundreds of human proteins are now being synthesized by the recombinant technology. A list of important proteins produced by recombinant technology is given in Box 48.1.

### Gene Library

Thousands of genes are arranged in specific order in the entire length of DNA. Isolation of the full length of DNA is practically impossible. To overcome this hurdle, the DNA of an organism is cut into small pieces of about 100 kbp by different restriction endonucleases. These cut pieces are then inserted into the vectors, and amplified in bacterial cells as recombinant DNA. A collection of these different recombinant clones, is called a gene library (Fig. 48.8). cDNA is preferred for the preparation of gene libraries.

### Linkage Analysis

If two genes are close together on the same chromosome, they do not assort independently during meiosis. Such genes are said to be **linked**. When two genes are far apart, they are not linked even though they are on the same chromosome. The 2 alleles are co-inherited with greater frequency if they are physically located close to each other. From this, we can understand the sequentially placed genes as 1,2,3, etc. Linkage analysis was the first step taken for human genome project. Linkage analysis of the genes is done by the technique of chromosome walking.

### Human Genome Project (HGP)

The US Department of Energy together with the US National Institutes of Health started this project in 1990. James Watson (co-discoverer of the structure of DNA, Nobel laureate, 1962) was the first head of the project; later Francis Collins succeeded him. The project included scientists from 16 centers all over the world, mostly from USA, with coordination from laboratories of Britain, France, Japan and Germany. So, the Project was named as International Human Genome Sequencing Consortium. By 1997, Celera Genomics, headed by Craig Venter, a private enterprise

#### Box. 48.1. Proteins produced by recombinant DNA technology

1. Recombinant human insulin
2. Recombinant human growth hormone (HGH, somatotropin) and other human hormones (e.g. FSH)
3. Recombinant blood clotting factor VIII and other clotting factors (Factor IX, tPA, hirudin)
4. Recombinant hepatitis B vaccine, HPV vaccine, etc.
5. Cytokines and growth factors (interferon, interleukins, etc.)
6. Monoclonal antibodies and other related products (rituximab, trastuzumab, etc.)
7. Recombinant enzymes (acid  $\alpha$  glucosidase [myozyme],  $\alpha$  L iduronidase [aldurazyme])
8. Recombinant HIV protein for HIV ELISA testing
9. Herbicide and insect resistant crops
10. Other products: Bone morphogenic protein (BMP), albumin, fibrinolytic and thrombolytic agents, etc.

funded by Perkin-Elmer Company independently embarked on a similar project, which hastened the work.

For HGP, the whole human DNA was fragmented into pieces of 100–200 kb length. These were matched with individual chromosomes by looking at marker sequences. These areas were further broken into small pieces and sequenced (shotgun technique). Overlapping sequences were arranged, and fragments were re-written with the help of computer programs. It is one of the greatest achievements of humanity. The ambitious project was to decode the whole human genome and to sequence the whole human DNA. One set of human DNA contains about 3 billion base pairs (one cell contains 2 sets) and about 10,000 genes. The “*Book of Human Life*” contains “23 Chapters”, as the 23 chromosomes.

The impact of HGP will be on all branches of medicine and related health sciences. It is now possible to isolate any human gene of interest. Many previously unknown genes have been identified. **Pharmacogenomics** is a recently emerged science from the genome project; it is the use of genetic information towards the development of new drugs and their targets of action.

By means of linkage analysis, human genetic mapping (location of important genes) was completed by 1994. The DNA sequences were identified by “shotgun sequencing” method, which involves breaking the DNA into small pieces, and sequencing each of them.

In 1995, gene map of chromosomes was published. By December 1998, human chromosome 5 (about 6% of human genome) was sequenced completely. By June 2000, “preliminary working draft” of the total human DNA sequence was announced. The final version of the sequence of the entire human genome was completed in 2003.

### Other Projects on Gene Sequencing

Along with human gene, genes of many other organisms were sequenced by other groups of researchers. Some of the important ones are, *Haemophilus influenzae* (1995), yeast (1996), *Escherichia coli* (1997), *Caenorhabditis elegans* (1998), *Mycobacterium tuberculosis* (1998), rat (2004) and chimpanzee (2005).

In 2003, the National Human Genome Research Institute initiated the **ENCODE** (Encyclopedia of DNA Elements) Project. The consortium of research workers aim to identify all the functional elements of the genome.

## GENE THERAPY

Gene therapy was once considered a fantasy. However, thousands of individuals have already undergone human clinical trials. A great leap in medical science has taken place on the 14th September 1990, when a girl suffering from adenosine deaminase deficiency (severe immunodeficiency) was treated by transferring the normal gene for adenosine deaminase.

### What is Gene Therapy?

It is intracellular delivery of genes to generate a therapeutic effect by correcting an existing abnormality. Only *somatic*

*gene therapy*, by inserting the new gene into somatic cell of the patient is under trial. Germ cell gene therapy is considered as unethical.

### Summary of the Procedure

1. Isolate the healthy gene along with the sequence controlling its expression.
2. Incorporate this gene into a carrier or vector as an expression cassette.
3. Finally deliver the vector to the target cells.

### How the Genes are Introduced?

There are three ways of applying gene carrying vectors:

- a. **Ex vivo strategy:** Where the patients’ cells are cultured in the laboratory, the new genes are infused into the cells; and modified cells are administered back to the patient (Fig. 48.9).
- b. **In situ strategy:** When the expression cassette is injected to the patient either intravenously or directly to the tissue (Fig.48.10).
- c. **In vivo strategy:** Where the vector is administered directly to the cell, e.g. CF (cystic fibrosis) gene to the respiratory tract cells.

### The Vectors

Different vector (carrier) systems used for gene delivery are: retroviruses, adenoviruses, adeno associated viral vectors and herpes simplex viruses. Nonvirus systems include liposomes, plasmids and physical methods.

#### Retroviruses

- i. Retroviruses are **RNA viruses** that replicate through a DNA intermediate. Moloney murine leukemia virus (MMLV) is commonly used. The *gag*, *pol*, *env* genes are deleted from the wild type retrovirus, rendering it incapable of replication inside human body. Then the human gene is inserted into the virus.
- ii. This is introduced into a culture containing packaging cells having *gag*, *pol* and *env* genes (Fig. 48.10). These cells provide the necessary proteins to pack the virus.
- iii. The **replication-deficient**, but infective, retrovirus vector carrying the human gene, now comes out of the cultured cells. These are introduced into the patient. The virus enters into the target cell via specific receptor.

- iv. In the cytoplasm of the human cells, the **reverse transcriptase** carried by the vector converts the RNA to proviral DNA, which is **integrated** into the target cell DNA. The normal human gene can now express (Fig. 48.10).
- v. **Advantage of retroviruses:** The virus is modified, and replication deficient. So infection with viral particle is limited to one cycle, and is very safe. They can infect a wide variety of human cells. This strategy is very suitable for treatment of all diseases produced by single gene mutations.
- vi. **Disadvantage of retroviruses:** Retrovirus requires dividing cells as the targets, and allows only low titers of virus to be generated. The length of the gene inserted should be less than 25 kbp. Moreover, illegitimate combination (the gene getting inserted at undesirable sites) and insertional mutagenesis are possibilities.

**Adenoviruses**

Adenoviruses are **DNA viruses**. The virus carrying the human gene reaches the nucleus of target cells. It is not integrated, but remains as **epichromosomal** (episomal). **Advantage** of adenovirus is that they can carry longer genes in higher titers. **Disadvantage** of adenovirus is that the expression is usually transient, the useful effect varying from a few weeks to months only.



Mario R Capecchi  
NP 2007  
b. 1937



Sir Martin J Evans  
NP 2007  
b. 1941



Oliver Smithies  
NP 2007  
b. 1925

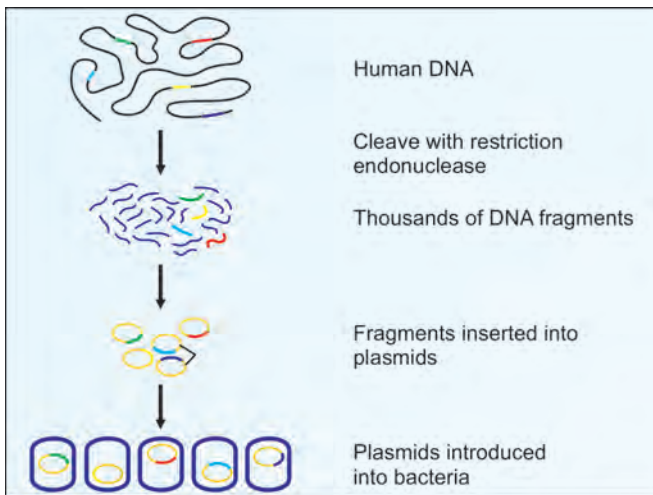


Fig. 48.8: Production of genomic library

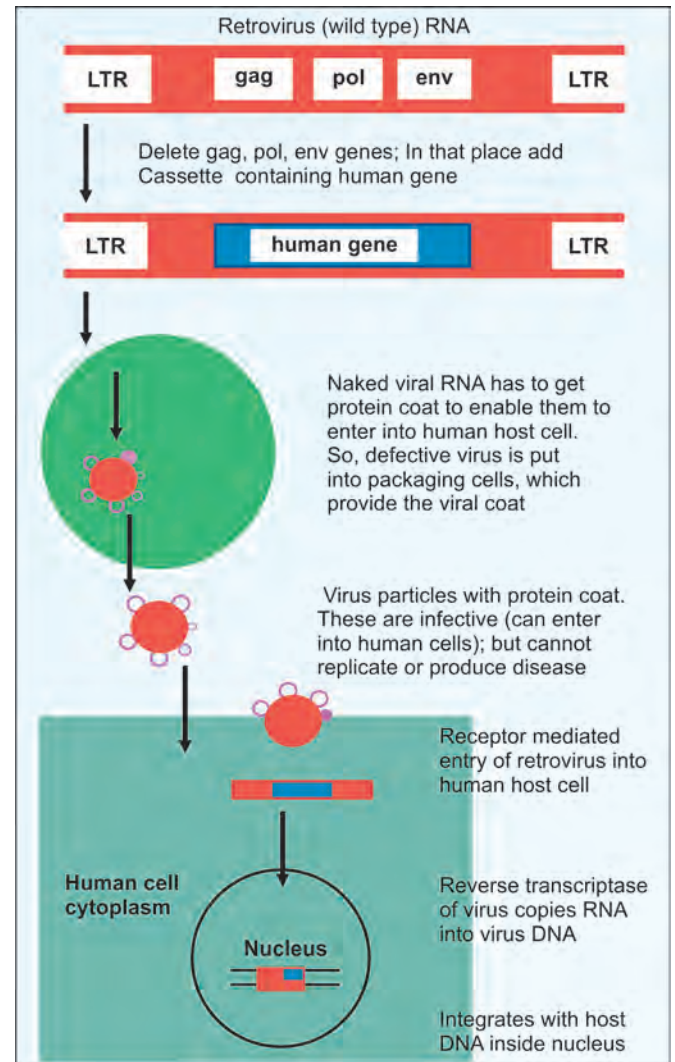


Fig. 48.10: Gene transfer by retroviral vector

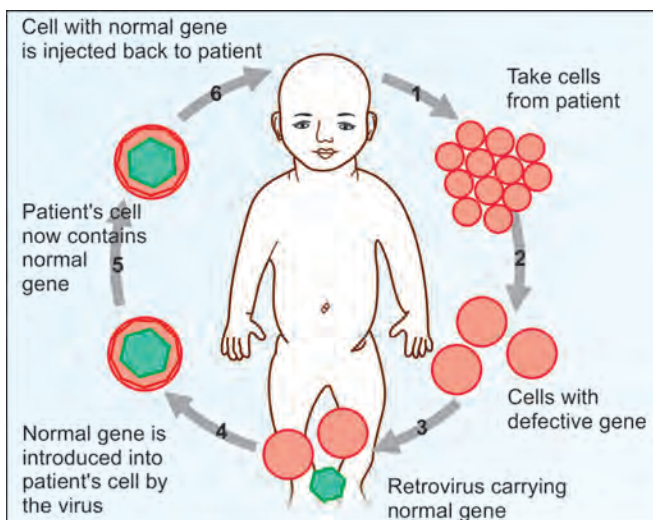


Fig. 48.9: Ex vivo gene therapy



### Plasmid Liposome Complex

It is a nonviral vector system. Liposomes are artificial lipid bilayers, which could be incorporated with plasmids carrying the normal human DNA. The complexes can enter into the target cells by fusing with the plasma membrane (Fig. 48.11). Cationic liposomes (positively charged) can form complexes spontaneously with DNA (negatively charged). The **advantages** with this strategy are that the vector can carry human gene of big size, do not replicate and evoke only very weak immune responses. The **disadvantage** is that most of the complexes are destroyed inside the host cell, and so the efficiency of gene transfer is less.

### Gene Gun Method

Tungsten particles are coated with plasmid DNA, and accelerated by helium pressure discharge. This enables particles to penetrate the target tissues. It is quick, and could be used in almost all tissues. Cellular damage and transient gene expression are the drawbacks.

### Combining Stem Cells and Gene Therapy

Patients with chronic liver cirrhosis from viral hepatitis (for example, HCV or HBV infection) conventionally treated by a liver transplant or transplantation of mature hepatocytes. However, the transplanted organ or cells are likely to become reinfected by the hepatitis virus. To avoid this, gene transfer of a vector encoding short hairpin RNAs (shRNAs) directed against the virus would make the transplanted cells resistant or ‘immune’ to reinfection. The resistant cells can repopulate the liver over time and restore normal liver function.

### Accomplishments

Gene therapy is effective in inherited disorders caused by single genes. Several clinical trials have been conducted. However, the progress is slow and it will take decades to make it a common clinical procedure. Success stories are few. The best developed and most successful cell therapy is hematopoietic stem cell transplantation (HSCT). Ex vivo gene transfer

procedures have been integrated into standard transplantation protocols. Autologous HSCT represents an emerging therapeutic option for several monogenic diseases of the blood and the immune system as well as for storage disorders. Another established gene therapy application is adoptive immunotherapy, which exploits *ex vivo* expanded T cells, in order to harness the power of immune effector and regulatory cells for use against malignancies, infections and autoimmune diseases. The most dazzling ones are shown in Table 48.2. In Duchenne muscular dystrophy (DMD), alternative splicing of the dystrophin gene (exon skipping) was tried to avoid the exon with the mutation, so that the reading frame is restored. Thus, a partially functional molecule is produced. Patient has a less severe form of the disease, Becker’s muscular dystrophy.

### Obstacles to Success

The potential of gene therapy is enormous. It is now theoretically possible to cure all the genetic diseases. However, it may take several years to get it available for common clinical use. The following limitations are encountered for gene therapy: (a) Inconsistent results (b) Lack of ideal vector (c) Lack of targeting ability in nonviral vectors (d) Death during the course of gene therapy for OTC (Ornithine transcarbamoylase) deficiency was reported (e) Reactivation of retroviral vector due to illegitimate combination of the inserted gene leading to leukemia in the patient has posed a setback in this field (Box 48.2).



Sir John Gurdon  
NP 2012  
b. 1933



Shinya Yamanaka  
NP 2012  
b. 1962

### STEM CELLS

Stem cells are defined as cells with the capacity for self-renewal and having potential to differentiate into progenitors of different lineages which ultimately give rise to mature tissues. Stem cell research is

TABLE 48.2: Success stories of gene therapy		
	Disease	Gene transferred by
1.	Severe combined immunodeficiency (SCID)	Adenosine deaminase enzyme in chromosome 13 and 20 into lymphocytes; by retrovirus
2.	Duchenne muscular dystrophy (DMD)	Dystrophin gene on short arm of x chromosome; by retrovirus
3.	Cystic fibrosis (CF)	CFTR gene on chromosome 7 to bronchial epithelium; adenovirus
4.	Familial hypercholesterolemia	LDL receptor gene on chrom 19 to hepatocytes; retrovirus
5.	Hemophilia	A and B genes for factor VIII and IX into fibroblasts; retrovirus
6.	Cancer	Activation of p53 (tumor suppressor gene) by liposome
7.	Leber’s hereditary optic neuropathy	Introducing the gene for the enzyme (isomerohydrolase) using an adenoviral vector directly to the retina

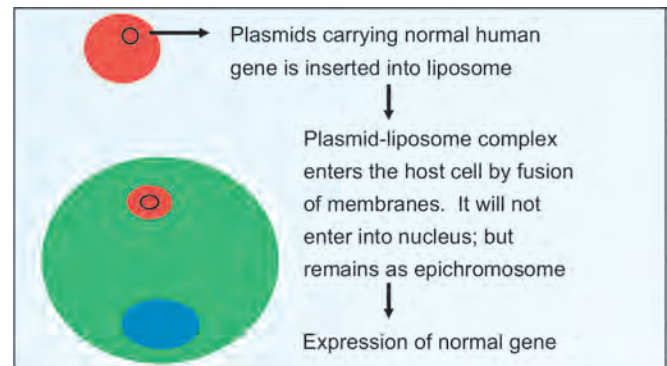


Fig. 48.11: Gene transfer by plasmid liposome

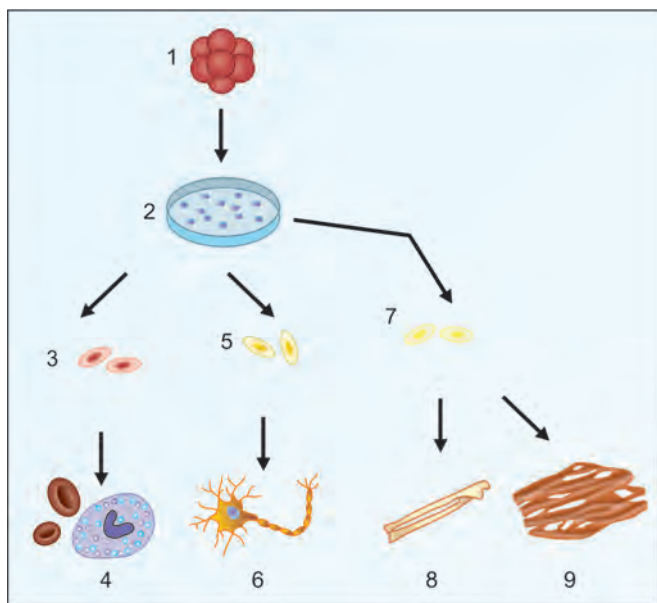
**Box 48.2. What happened to gene therapy trials?**

A few patients treated by gene therapy for diseases like SCID, developed leukemia and died. The gene introduced through a retroviral vector got inserted at a site (illegitimate recombination) that lead to activation of oncogenes that resulted in leukemia. At present trials are on, but restricted with stringent protocols and follow-up.



leading to promising results in treatment of various incurable diseases like coronary artery disease and cancer. Mario R. Capecchi, Sir Martin J Evans and Oliver Smithies were awarded Nobel prize in 2007 for their discoveries of principles for introducing specific gene modifications in mice by the use of embryonic stem cells. Stem cells have the ability to divide for an indefinite period. They can give rise to a variety of specialized cell types. This phenomenon is known as developmental plasticity. Stem cells can be isolated from embryos, umbilical cord as well as from adult bone marrow. Plasticity is more for embryonic stem cells. Plasticity is defined as the ability of stem cells from one germinal layer to give rise to tissues of another germinal layer.

Stem cells have the unique capacity to produce unaltered daughter cells (**renewal**) and also to generate specialized cells (**potency**). Stem cells may be capable of producing all types of cells of the organism (**totipotent**), or able to generate cells of the three germ layers (**pluripotent**), or able to produce only closely related cell types (**multipotent**), or may produce only one cell type (**unipotent**). Stem cells may be **embryonic** (capable to differentiate) or adult type (limited capacity to differentiate). The pluripotency and self-renewal are critical for sustaining the lifelong functions of organs. Stem cells reside in a special microenvironment called the **niche**. Stem cells interact with the niche via adhesion molecules and exchange molecular signals that maintain the specific features of stem cells. A schematic diagram of development of differentiated cells from the stem cell is shown in Figure 43.12. Active research is being done to utilize stem cells in the treatment of the following diseases: stroke, brain injury, Alzheimer's disease, Parkinsonism, wound healing, myocardial infarction, muscular



**Fig. 48.12:** Differentiation of stem cells. SC= stem cells; 1= Totipotent SC. 2= Cultured pluripotent SC. 3= Hemato-poeitic SC. 4= Differentiated blood cells. 5= Neural SC. 6= Differentiated nerve cell. 7= Mesenchymal SC. 8= Differentiated bone. 9= Cardiac muscle

dystrophy, spinal cord injury, diabetes, cancers. It has been suggested that tumor tissue contains a type of stem cell referred to as a cancer stem cell.

Cancer stem cells (CSC) are can give rise to new cancer cells. They are responsible for relapse of tumors and metastasis. Drugs which can destroy cancer stem cells can therefore be used to treat metastasis and relapse. However, isolation of cancer stem cells is a difficult procedure.

General belief was that only stem cells are plastic, and the differentiated matured cells will lose their plasticity. But Sir John Gurdon and Shinya Yamanaka have independently discovered that mature cells can be reprogrammed to become pluripotent; they were awarded Nobel Prize in 2012.

### Related Topics

Molecular biology techniques such as hybridization techniques, cloning, DNA finger printing, RFLP, PCR, hybridoma technology, DNA sequencing, etc. are described in Chapter 49.

## QUICK LOOK OF CHAPTER 48

1. Genetic recombination involves the exchange of information between two segments of DNA. When a gene of one species is transferred into another under laboratory conditions, the technique is called recombinant DNA technology or genetic engineering.
2. Restriction endonucleases (RE), also known as 'molecular scissors' cut at sequences which are palindromes. Each RE is characterized by a specific 'restriction site'.
3. Plasmids are commonly used vectors. They provide antibiotic resistance to their host bacteria. This property is used as a marker in genetic engineering.
4. A vector carrying a foreign DNA is called 'Chimeric DNA'.
5. The process of introducing a plasmid into a host is called transfection.
6. Gene therapy involves the delivering genes to generate a therapeutic effect by correcting an existing abnormality. Introducing genes involves three ways of applying gene carrying vectors, ex vivo, in situ and in vivo.
7. Retroviruses, adenoviruses and herpes simplex viruses have been used carrier systems in human gene studies.
8. Diseases for which gene therapy has been attempted are severe combined immunodeficiency (SCID), Duchenne muscular dystrophy (DMD), cystic fibrosis, hemophilia.

# CHAPTER 49

## Molecular Diagnostics and Genetic Techniques

### Chapter at a Glance

The reader will be able to answer questions on the following topics:

- DNA hybridization techniques
- Southern, Northern and Western blots
- Animal cloning
- Molecular cloning
- Restriction fragment length polymorphism
- Polymerase chain reaction (PCR)
- Monoclonal antibodies
- Single strand conformation polymorphism
- Heteroduplex analysis
- Conformation sensitive gel electrophoresis
- Protein truncation test (PTT)
- Denaturing HPLC (DHPLC)
- DNA sequencing
- Bioinformatics
- Nanotechnology

Molecular (DNA based) diagnostics is rapidly becoming a standard laboratory procedure for a large number of disorders. Many DNA based molecular techniques are being used in clinical practice. In addition to the diagnosis of a particular patient, molecular diagnostics can be used for diagnosis of index cases, prenatal diagnosis and screening. In many cases, the diagnosis is based on detecting mutations in genes involved, but in some cases it may be detecting changes in DNA copy number which leads to changes in gene expression. Still further, there may be changes at the transcription level (production of increased mRNA) which leads to increased protein synthesis by the corresponding gene. In this chapter, a brief review of major molecular techniques employed in clinical diagnosis is given.

### HYBRIDIZATION AND BLOT TECHNIQUES

#### Probes

A probe is defined as a single stranded piece of DNA, labeled (either with radioisotope or with non-radioactive label), the nucleotide sequence of which is complementary to the target DNA. The DNA of the specific gene is used for the hybridization techniques. The DNA is nicked (a few breaks are made) and repaired. During this process,  $^{32}\text{P}$ -labeled dCTP is added. Therefore, the radioactivity is tagged into the gene. This is called **Nick-translation**. Non-radioactive probes are also available and fluorescent probes are easier to detect.

## Southern Blot Technique

It is based on the specific base pairing properties of complementary nucleic acid strands. This technique is therefore based on **DNA hybridization** (Fig. 49.1). The blot technique was developed by EM Southern in 1975. This is used to detect a **specific segment of DNA** in the whole genome.

DNA is isolated from the tissue. It is then fragmented by **restriction endonucleases**. The cut pieces are **electrophoresed** on agarose gel. Treatment with NaOH denatures the DNA, so that the pieces become single-stranded. This is then **blotted** (adsorbed) over to a nitrocellulose membrane. The single-stranded DNA is adsorbed on the **nitrocellulose** membrane. An exact replica of the pattern in the gel is reproduced on the membrane (Fig. 49.2). The DNA is then fixed on the membrane by baking at 80°C. There will be many DNA fragments on the membrane, but only one or two pieces contain the target DNA. The radioactive **DNA probe** is placed over the membrane. If the target genes are present in the host DNA, the probe will detect the complementary nucleotide sequence in the host DNA (Figs 49.2 to 49.4A). So the probe is hybridized to the particular pieces of host DNA. The membrane is then thoroughly **washed** to remove excess probes. An X-ray plate is placed over the membrane in the dark for a few days. The radiation from the fixed probe will produce its mark on the X-ray plate. This is called **autoradiography** (Fig. 49.4B). Mutant genes such as HbS, cystic fibrosis, DMD, PKU as well as presence of viral DNA (hepatitis virus B and C) can be identified by this method.

## Northern Blotting for Identifying RNA

The Northern blot is used to demonstrate **specific RNA**. The total RNA is isolated from the cell, electrophoresed and then blotted on to a membrane. This is then probed with radioactive cDNA. There will be RNA-DNA hybridization. This is used to detect the gene expression in a tissue (Fig. 49.3).

## Western Blot Analysis for Proteins

In this technique, proteins (not nucleic acids) are identified. The proteins are isolated from the tissue and electrophoresis is done. The separated proteins are then transferred on to a **nitrocellulose** membrane. After fixation, it is probed with radioactive **antibody** and autoradiographed. Alternately, the specific antibody is poured over, washed and a second

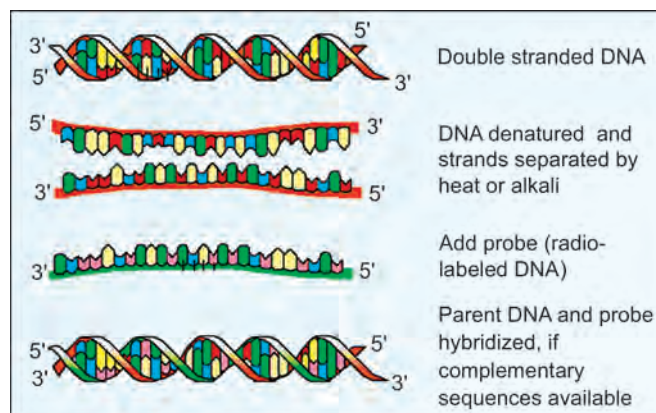


Fig. 49.1: DNA-DNA hybridization

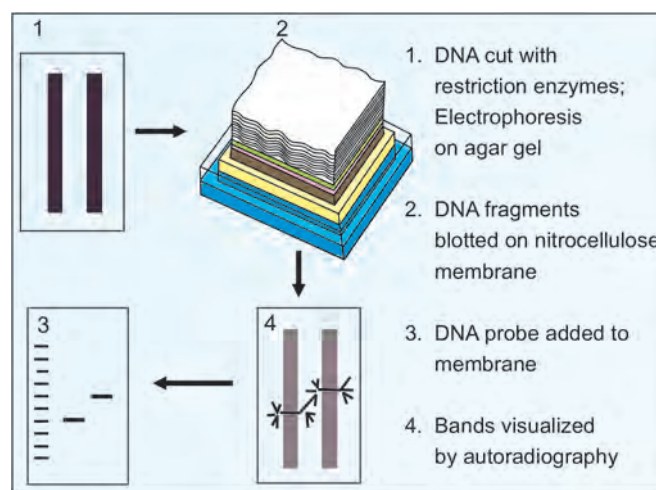


Fig. 49.2: Southern blot technique

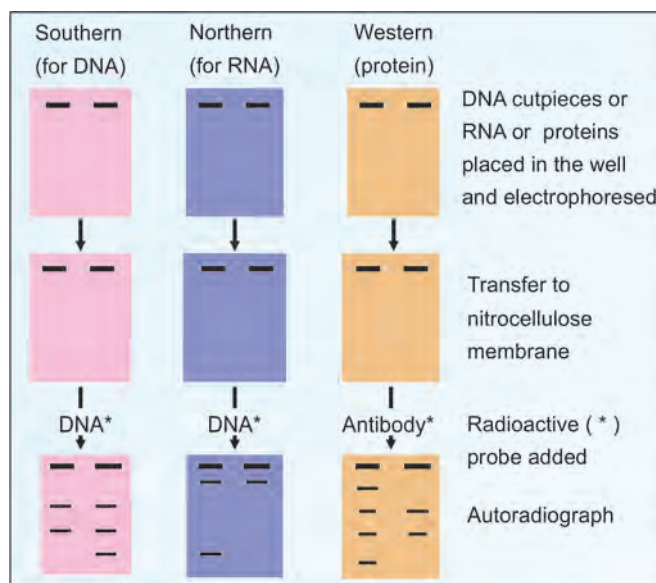


Fig. 49.3: Comparison of blot transfer techniques



antibody carrying horse radish peroxidase is added. Hydrogen peroxide and a chromogen are layered (Figs 49.3 and 49.4B). This technique is very useful to identify the specific protein in a tissue, thereby showing the expression of a particular gene. Southern, Northern and Western blots are compared in Figure 49.3.

### In situ Hybridization

It allows one to examine the tissue first by microscope. It is a modified version of DNA–DNA hybridization (Fig. 49.1). If a metaphase spread chromosome preparation is probed with a gene, the location of the gene on a specific chromosome can be identified. The principle may be applied to histology slide also. In the tissue preparation, DNA is denatured, the specific probe tagged with fluorescent labels, incubated, washed and seen under a fluorescent (UV) microscope. The process is named as Fluorescence in situ hybridization (FISH).

Histology section or single cells may be treated with specific antibodies tagged with fluorescence and seen under microscope (Fig. 49.5A). Histology section may be treated with antibody linked with peroxidase and color developed (Fig. 49.5B).

In situ hybridization has gained popularity over other molecular biology methods because the DNA/mRNA of interest can be viewed in the context of the tissue morphology. When the probe is tagged with fluorescein, it can be seen under UV microscope; then it is called FISH (fluorescent in situ hybridization).

Examples of applications of ISH and FISH are: (a) assessment of gene rearrangements in leukemia (b) diagnosis of B-cell lymphoma by demonstration of reduced light-chain mRNA (c) determination of amplification of *HER2/neu* in breast cancer and (d) diagnosis of various types of lymphomas. Chromogenic in situ hybridization (CISH) is used to diagnose melanoma and lymphoma using mRNA probes for kappa and lambda chains.

### Microarray Technique

A microarray is a series of thousands of microscopic spots of DNA oligonucleotides (probes) on a slide, that are used to hybridize a cDNA or cRNA sample (target). Microarray generally contains 5,000 to 20,000 genes in a gene chip (Fig. 49.6). Each gene (DNA probe) solution is prepared, a nanoliter sized drop is added to one well in the plate; the droplet dries in a few seconds, leaving the DNA in the well; thousands of such wells, each containing a different gene is prepared. The DNA from the clinical sample (or PCR amplified DNA) is tagged with a fluorescent dye. These tagged DNA fragments are then incubated with the chip. After the DNA–DNA hybridization is over, unbound DNA is washed away. The surface of the microarray is then scanned with a laser



Dolly and Bonnie. Roslin Institute, Scotland reported that the first cloned sheep “Dolly” was born in 1996. Her first lamb, Bonnie, was born in 1999. Dolly died in 2002.

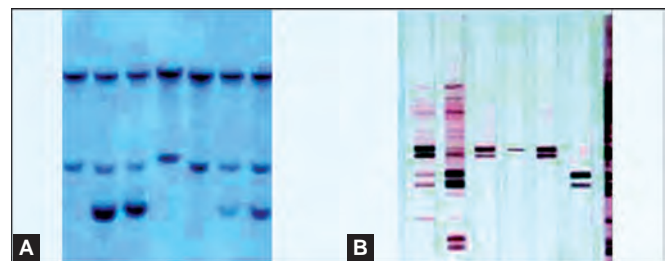
beam. Color intensity indicates the extent of hybridization. In a similar manner, specific proteins can be identified using monoclonal antibody microarray or aptamer microarray. (Aptamers are short oligonucleotides that bind specific proteins). The monoclonal antibody array is used in selecting the specific tyrosine kinase inhibitor to be used for a particular patient (personalized molecular medicine). Glioblastoma multiformi has been successfully treated using the specific tyrosine kinase inhibitor for chemotherapy. Microarray tests are useful in diagnosis of a) Cancer; b) Infectious diseases and c) Allergy.

DNA or cDNA prepared from patient’s tissue and labeled (targetDNA) is added to each well and hybridized. In a similar manner specific proteins can be identified using monoclonal antibody microarray and aptamer microarray. Aptamers are short oligonucleotides that bind specific proteins. The monoclonal antibody array is used in selecting the specific tyrosine kinase inhibitor to be used for a particular patient (personalized molecular medicine). Glioblastoma multiforme has been successfully treated using the specific tyrosine kinase inhibitor for chemotherapy.

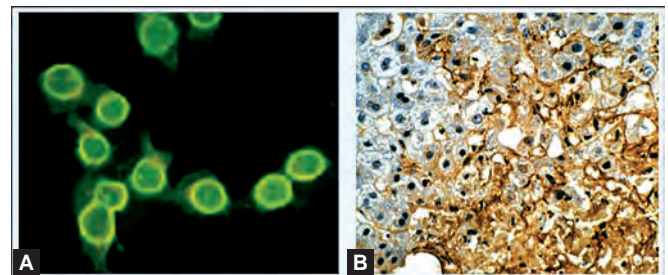
### Animal Cloning

The term cloning has two broad meanings. When a gene of higher organism is introduced into a bacterial DNA, it is called “cloning of the gene” or “**molecular cloning**”; details of which are described in Chapter 43. When a cell from an animal is grown to an exact duplicate of that animal, it is known as “**cloning of an animal**” or “somatic cloning”.

It made big news when Ian Wilmut and Keith Campbell of Scotland cloned a sheep named “Dolly” in July 1996. (Dolly died naturally in 2002, not due to any complications of cloning). Today the sheep, tomorrow it could be the shepherd. So this raised a number of moral, ethical and legal issues.



Figs 49.4A and B: A = Southern blot; B = Western blot



Figs 49.5A and B: A = Cells with specific antibody showing surface immunofluorescence. B = Immuno-peroxidase technique



A single adult cell contains all the genetic material for making the entire animal. In the case of Dolly, it was a cell from the udder (mammary cell).

Then, the nucleus of an oocyte was removed. Oocyte contains 1xn genes; when zygote is formed, another 1xn genes of the sperm are added, so zygote gets 2xn genes. In this experiment, the nucleus of the mature cell already contains 2xn genes. Therefore, the extra 1xn genes are to be removed from oocyte, to avoid triploid (3xn) status.

Next, the mammary cell and denucleated oocyte were fused. The fused cell was then implanted into the uterus of a surrogate mother, which delivered the baby in course of time.

### Applications of Cloning of Animals and Plants

1. Animals with genetically desirable traits could be bred more efficiently, e.g. cows yielding more milk.
2. Biopharmaceuticals: By November 1998, the first goats were born, who were genetically engineered to produce milk containing antithrombin III. Any human protein could be introduced into the make up of goat or cow and get the desired protein cheaply through milk. Eggs have been genetically manipulated to produce interferon and insulin in the egg-white.
3. Cloning is successfully employed in agriculture, to propagate plants such as rubber, banana, orchids, etc. If a good yielding rubber is available, it is cloned so that, thousands of progenies of the same quality could be produced within a short time.
4. Species threatening to become extinct, could be reproduced easily. In October 2000, a cow, "Bessie" gave birth to a wild gaur calf named "Naoh". Scientists took skin cells from a dead gaur and fused them with Bessie's eggs, from which the bovine genes had been removed. In the science fiction cinema, "Jurassic Park", scientists produced dinosaurs; it is quite improbable in actual life, but not impossible.

### Disadvantages of Cloning

Cloning will never replace selective breeding. Cloning halts any further progress. Cloning can produce the animals/plants with the same characteristics; new characteristics could not be developed. The cloned animal and parent need not be exactly identical. First, mitochondrial DNA invariably comes from the egg. Second, DNA in an adult cell differs from the DNA in a fetal cell by the accumulated damages of a life-time. Thirdly, any animal is not just the product of its genes, but also of its environment, both in utero and after birth; this is especially so when higher organisms are concerned.

## Applications of Molecular Cloning in Medicine

### Diagnosis of Genetic Diseases

Various genetic diseases can be identified by using appropriate probes from **defective genes**. A *point mutation may destroy or create a restriction enzyme cleavage site*. Then the fragment size produced from normal gene and

mutated gene will be different. This can be easily identified by Southern blot.

- For example, **sickle cell anemia** is caused by a point mutation. In the beta chain of the hemoglobin, the 6th amino acid normally is glutamate. In sickle-cell anemia, this is altered to valine. In the DNA, this is seen as a change from normal T replaced by abnormal A nucleotide (T to A substitution). The normal gene has the following nucleotide sequence.

CC ↓ TGA GG

Coding strand

Normal HbA GG ACT ↓ CC

Template strand

The arrows indicate the cleaving site for the restriction enzyme Mst-II. In the sickle cell anemia gene, the underlined T is replaced by A, and the DNA sequence is as follows:

CC TGT GG Coding strand

HbS gene GG ACA CC Template strand

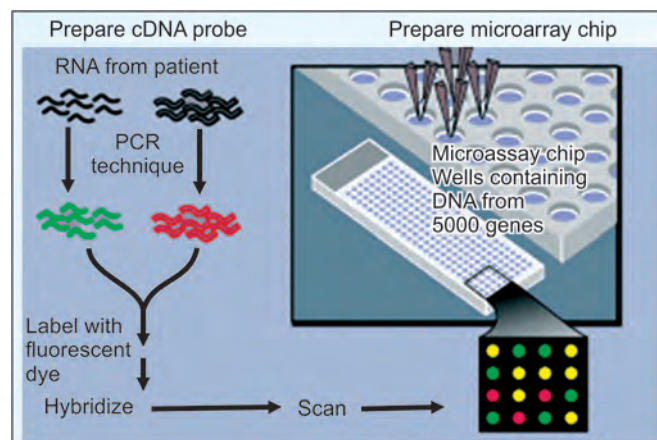


Fig. 49.6: Microarray technology

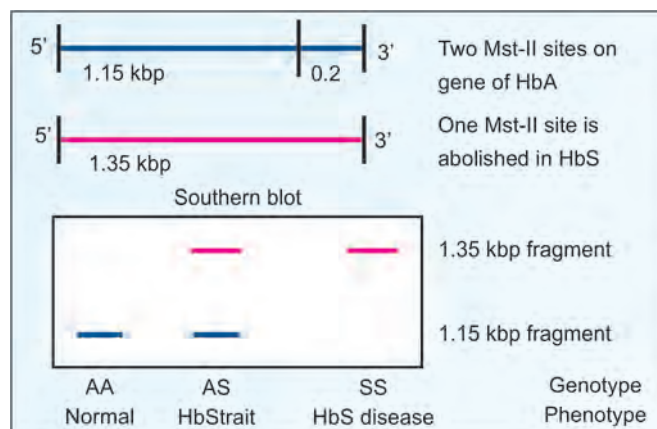


Fig. 49.7: Southern blot analysis of DNA from normal, HbS trait and sickle cell anemia disease

This alteration in base sequence abolishes the recognition site for this RE. But other Mst-II cleavage sites are preserved.

Therefore, analysis of DNA from AA (normal HbA), heterozygous AS (Sickle-cell trait) and homozygous SS (Sickle-cell disease) individuals fall into 3 different patterns in Southern blot technique (Fig. 49.7). The mutation eliminates one restriction site for Mst II enzyme, and hence a larger fragment is present in sickle cell anemia.

This becomes useful as a diagnostic test for the presence of the disease allele in heterozygotes (**carriers**) or individuals in which the disease has not yet been manifested.

Such a test is possible for **prenatal diagnosis** also. DNA from cells collected from amniotic fluid can be used for Southern blot analysis.

- ii. **Huntington's chorea** is a recessive condition. Symptoms usually begin around the age of 40, with involuntary jerky movements and muscle rigidity. Short arm of chromosome 4 codes for a normal protein "Huntingtin"; gene is named as IT-15. Diagnostic DNA test for this abnormal gene is now available.
- iii. **Duchenne muscular dystrophy** (DMD) is a degenerative disease of muscle affecting only male children. The gene is in the middle of the short arm of X-chromosome. This gene produces a protein called **dystrophin** with 3700 amino acids. It is one of the largest human genes known. In DMD patients, the gene for dystrophin is mutated. This could be identified by using a **cDNA probe** for dystrophin. In the Southern blot analysis, the fragment corresponding to this gene will be absent.

## Detection of Specific Sequences

By using a **virus probe**, the presence of viral genes in the host cells can be detected. An oncogene probe will demonstrate the activation of the gene in malignant tissues.

## DNA Finger Printing in Forensic Medicine

There are **tandem repeats** (TR) in chromosomes. These are short sequences of DNA, located at scattered sites. The number of these repeat units varies from person to person, but is unique for a particular person. Therefore, it serves as a molecular fingerprint. It is also known as **DNA profile**.

Probability of similarity between two persons is only 1 in  $3 \times 10^{10}$  persons.

DNA probes have been developed, so that at low stringency, they hybridize to a number of these loci to produce individual specific finger prints. The technique is used to pinpoint the **culprit** of the crime, and also in disputes of **parenthood**. DNA can be isolated from stains on clothing made of blood or semen stained even several years before. Sperm nucleic acid can also be separated from vaginal swabs of rape victims.

## Single Nucleotide Polymorphism

Single nucleotide polymorphism (SNP) is a change in a single nucleotide, which can produce change in a amino acid in a protein by altering single codon. The SNP may not produce clinical symptoms, so that the person will show only an abnormal genotype which is detected by DNA analysis. Restriction fragment length polymorphism (RFLP) is useful only if the mutation changes a restriction site. SNPs at other points is detected by single strand conformation polymorphism (SSCP, See below).

## Restriction Fragment Length Polymorphism

The human genome contains hundreds of variations in base sequences that do not affect the phenotype. The *property of the molecules to exist in more than one form is known as polymorphism*.

**Difference between mutation and DNA polymorphism:** If more than 1% of the population has a particular alteration in the sequence, it is polymorphism. If only a few individuals have it, then it is mutation. Polymorphism is normal variation, and generally having no deleterious effect. Mutation is abnormal, and sometimes will have defective function, e.g. phenyl ketonuria.

A polymorphic gene is one, in which the variant alleles are common in more than 1% of the total population. The existence of two or more types of **restriction fragment patterns** is called restriction fragment length polymorphism (RFLP). This can be used as a **genetic marker**.

DNA is treated with restriction enzymes, which cleave DNA into fragments of defined lengths. Then electrophoresis is done in agarose gels, when the fragments are separated. Finally, the DNA from the agarose gel is transferred on to nitrocellulose paper (Southern blotting) and hybridized with labeled probe sequences. Genotypic changes can be recognized by the altered restriction fragments.

## Clinical Applications of RFLP

1. An individual who is heterozygous for a polymorphism has a sequence variation in the DNA of one chromosome and not in the DNA of the companion chromosome. In such cases, each chromosome can be traced from parent to offspring by the presence or absence of this marker. This is thus useful in *disputed parenthood*.

- RFLP is also useful in human *population genetics*, geographical isolates and comparison of genetic make up of related species.
- Genetic diseases* will produce alteration in size distribution of RE fragments, and show RFLP; examples are shown in Figure 49.7.

## POLYMERASE CHAIN REACTION

Kary Mullis invented this ingenious method in 1989, who was awarded Nobel prize in 1993. Polymerase chain reaction (PCR) is an in vitro DNA amplification procedure in which millions of copies of a particular sequence of DNA can be produced within a few hours. It is like xerox machine for gene copying.

The flanking sequences of the gene of interest should be known. Two **DNA primers** of about 20–30 nucleotides with complementary sequence of the flanking region can be synthesised. The reaction cycle has the following steps:

**Step 1: Separation (Denaturation):** DNA strands are separated (**melted**) by heating at 95°C for 15 seconds to 2 minutes (Fig. 49.8).

**Step 2: Priming (Annealing):** The primers are **annealed** by cooling to 50°C for 0.5 to 2 minutes. The primers hybridize with their complementary single stranded DNA produced in the first step.

**Step 3: Polymerization:** New DNA strands are synthesised by **Taq polymerase**. This enzyme is derived from bacteria *Thermus aquaticus* that are found in hot springs. Therefore the enzyme is not denatured at high temperature. The polymerase reaction is allowed to take place at 72°C for 30 seconds in presence of dNTPs (all four deoxy ribonucleotide triphosphates). Both strands of DNA are now duplicated (Fig. 49.8).

**Step 4:** The steps of 1, 2 and 3 are **repeated**. In each cycle, the DNA strands are doubled. Thus 20 cycles provide for 1 million times amplifications. These cycles are generally repeated by automated instrument, called **Thermal cycler**.

**Step 5:** After the amplification procedure, DNA hybridization technique or Southern blot analysis with a suitable probe, shows the presence of the DNA in the sample tissue.

**Step 6:** According to new modifications in technology, all the three cycles of PCR are performed at 63°C for 60 minutes. The melting of DNA is achieved, not by high temperature, but by enzymes. This will reduce the cost of the test. Result will be available within a few hours.

## Clinical Applications of PCR

- Diagnosis** of bacterial and viral diseases: In early phases of tuberculosis, the sputum may contain only very few tubercle bacilli, so that usual acid fast staining may be negative. But PCR can detect even one bacillus present in the specimen. Any other bacterial infection can also be detected similarly. The specific nucleotide sequences of the bacilli are amplified by PCR and then detected by Southern blot analysis. If reverse PCR is done, living organisms can be detected.

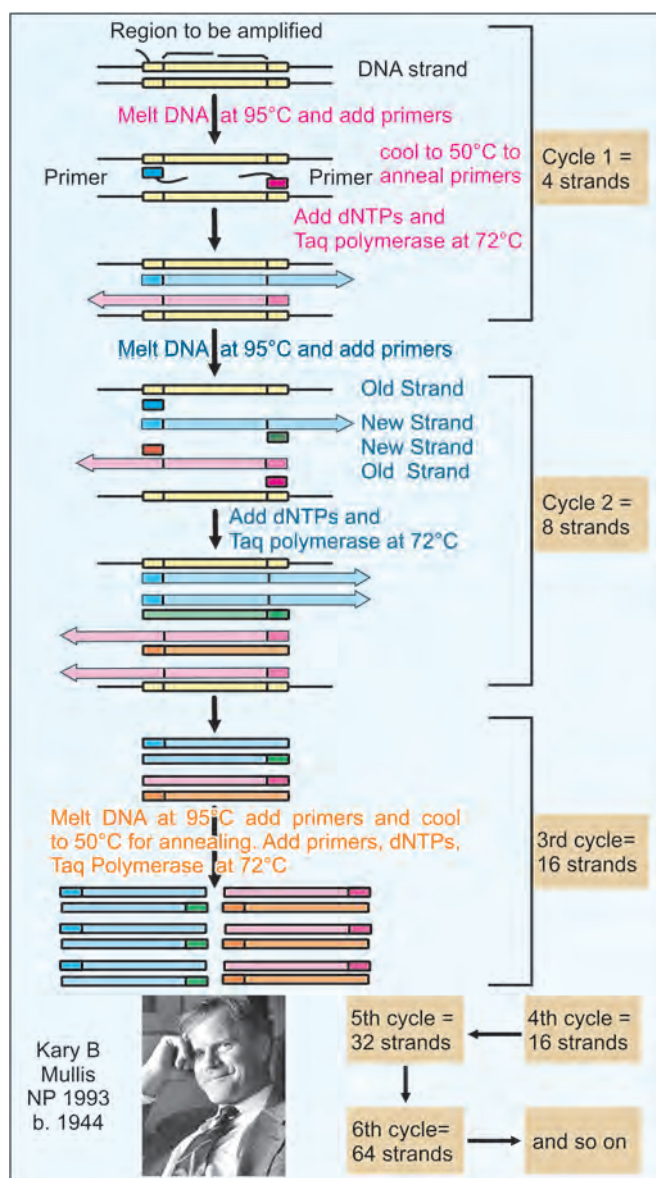


Fig. 49.8: Polymerase chain reaction (PCR)



This technique is widely used in the diagnosis of viral infections like hepatitis C, cytomegalovirus and HIV.

2. **Medicolegal cases:** PCR allows the DNA from a hair follicle or a blood cell to be analyzed. The restriction analysis of DNA from the hair follicle from the crime scene is studied after PCR amplification. This pattern is then compared with the restriction analysis of DNA samples obtained from various suspects; the culprit's sample will perfectly match with that of PCR amplified sample. The restriction analysis pattern of DNA of one individual will be very specific (DNA fingerprinting); but the pattern will be different from person to person. This is highly useful in forensic medicine to identify the criminal.
3. Diagnosis of **genetic disorders:** The PCR technology has been widely used to amplify the gene segments that contain known mutations for diagnosis of inherited diseases such as sickle cell anemia, beta thalassemia, cystic fibrosis, etc.
4. PCR is especially useful for **prenatal diagnosis** of inherited diseases, where cells obtained from fetus by amniocentesis are very few.
5. **Cancer detection:** PCR is widely used to monitor residual abnormal cells present in treated patients. Similarly identification of mutations in oncosuppressor genes such as p53, retinoblastoma gene, etc. can help to identify individuals at high risk of cancer (oncogenes and oncosuppressor genes are described in Chapter 57).

#### Box 49.1. Applications of PCR

##### Detection of infectious diseases

AIDS, tuberculosis, CMV, H1N1, hepatitis C, etc.

Lyme disease—joint inflammation from tick bites.

Detect 3 sexually transmitted diseases in one swab—herpes, papilloma virus, Chlamydia.

PCR can diagnosis even one bacteria or virus present in the specimen.

Latent viruses can also be diagnosed.

##### Detection of variations and mutations in genes

Detects people with inherited disorders and carriers

Track presence or absence of DNA abnormalities characteristic of cancer

Prenatal diagnosis of genetic disorders.

PCR combined with RE cleavage and Southern blotting is used for mutation detection.

##### PCR and the law

DNA fingerprinting—can multiply small amounts of DNA found in blood samples, hair, semen, and other body fluids

6. **Fossil studies:** DNA can be isolated and PCR amplified from fossils and used to study evolution by comparing the sequences in the extinct and living organisms (Box 49.1).

#### Reverse Transcriptase PCR (RT-PCR)

It is the method used to amplify, isolate or identify a known sequence from a cell or tissue RNA library. Essentially normal PCR is preceded by reverse transcription (to convert the RNA to cDNA). This is widely used in expression mapping, determining when and where certain genes are expressed. Instead of Taq polymerase described above, Tth polymerase from *Thermus thermophilus* may be used. This enzyme has both DNA polymerase and reverse transcriptase activities at high temperature. This allows both cDNA synthesis from mRNA followed by PCR amplification. In ordinary PCR, DNA is detected; that DNA could be from a living or non-living organism. But in reverse PCR, mRNA is detected; that means, it is derived from a living organism. Presence of HIV RNA in blood can be detected as early as 4 weeks after infection.

#### Nested PCR

Nested PCR is intended to reduce the contamination in products due to the amplification of unexpected primer binding sites. Two sets of primers are used in two successive PCR runs, the second set intended to amplify a secondary target within the first run product. This is very successful, but requires more detailed knowledge of the sequences involved.

#### Real Time PCR

By this method, quantitation of the number of virus present in a sample can be calculated, e.g. viral load in HIV or HBV. So, the treatment modalities can be planned and the response to treatment can be assessed.

#### Quantitative PCR

Q-PCR (Quantitative PCR) is used to rapidly measure the quantity of PCR product (preferably real-time), thus is an indirect method for quantitatively measuring starting amounts of DNA, cDNA or RNA. This is commonly used for determining whether a sequence is present or not, and if present the number of copies in the sample.

#### Quantitative Real-time PCR (RQ-PCR)

This method uses fluorescent dyes, such as Sybr Green, or fluorophore-containing DNA probes, such as TaqMan, to measure the amount of amplified product in real time.

#### RACE-PCR

**RACE**, or **Rapid Amplification of cDNA Ends**, is a technique used in molecular biology to amplify the ends of messenger RNA (mRNA) transcripts using a specialized reverse transcription-polymerase chain reaction (RT-PCR). It allows the amplification of an unknown end portion of a transcript using known information from the center of the transcript. It can be used to obtain the 5' end (5' RACE-PCR) or 3' end (3' RACE-PCR)



of mRNA. This technique is sometimes called *one-sided PCR* or *anchored PCR*.

### Multiplex-PCR

The use of multiple, unique primer sets within a single PCR reaction to produce amplicons of varying sizes specific to different DNA sequences. By targeting multiple genes at once, additional information may be elicited from a single test run that otherwise would require several times the reagents and technician time to perform. Annealing temperatures for each of the primer sets must be optimized to work correctly within a single reaction and amplicon sizes should be separated by enough difference in final base pair length to form distinct bands via gel electrophoresis. Nowadays, molecular diagnosis is applied to various clinical conditions, including diagnosis of infectious diseases; viral infections, bacterial genotyping; cancer diagnostics; mutation analysis; pharmacogenomics; chromosomal analysis for cytogenetic studies; gene expression patterns in disease states.

## Hybridoma Technology and Monoclonal Antibodies

### Differences Between Monoclonal and Polyclonal Antibodies

If an antigen is injected into an animal, the animal produces different types of antibodies against various epitopes of the



Georges  
Kohler  
NP 1984  
1946–1995

Cesar  
Milstein  
NP 1984  
1927–2002

Walter  
Gilbert  
NP 1980  
b.1932

Frederick  
Sanger  
NP 1958 and 1980  
b. 1918

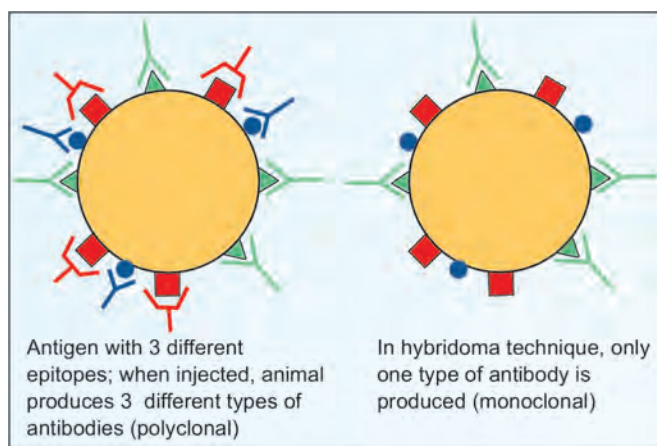


Fig. 49.9: Polyclonal and monoclonal antibodies

antigen. The antibodies thus generated are **polyclonal** in nature. Different molecules will have different specificities and affinities (Fig. 49.9). In all microbial infections, body reacts with polyclonal antibody production.

However, in nature, monoclonal antibodies are produced in multiple myeloma where only one clone secretes a particular type of antibody (see Chapter 28). But in multiple myeloma, the antibody thus generated is unwanted.

In the laboratory, **monoclonal** antibody can be generated. In this case, only a particular type of antibody against a specific epitope of the antigen is produced (Fig. 49.9). Monoclonal antibodies were first produced by Georges Kohler and Cesar Milstein in 1975. They were awarded Nobel prize in 1984.

### Production of Hybridoma

- i. The antigen is injected into mice.
- ii. Spleen cells from the immunized mice are fused with mice myeloma cells, so as to produce a hybrid cell. Polyethylene glycol (PEG-1500) is used as a fusion agent.
- iii. The **hybrid cells** now contain the gene of normal mice as well as the myeloma cells. (Fig. 49.10).
- iv. However, hybridization might have occurred between two normal cells. Normal cells lack the multiplication potential. So all the hybridized normal cells die in the usual culture conditions within 5–6 days.
- v. The myeloma cells are defective in the enzyme HGPRTase and so they lack the salvage pathway for DNA synthesis. In the culture, **HAT medium** is used containing hypoxanthine, aminopterin and thymidine. The aminopterin, a folic acid antagonist, will inhibit the de novo synthesis of DNA. Since both pathways are blocked, the non-fused myeloma cells also die in the special medium provided.
- vi. The only cells that survive are the cells where fusion has taken place between normal spleen cells with myeloma cells. In this case, normal cells provide the HGPRTase enzyme and so DNA synthesis is possible from the hypoxanthine and thymidine provided in the medium.
- vii. The normal cellular genes also provide the information for specific antibody synthesis. The myeloma cancer genes provide the endless multiplication drive, so that hybrid cells are immortalized (Fig. 49.10).

### Applications of Monoclonal Antibody

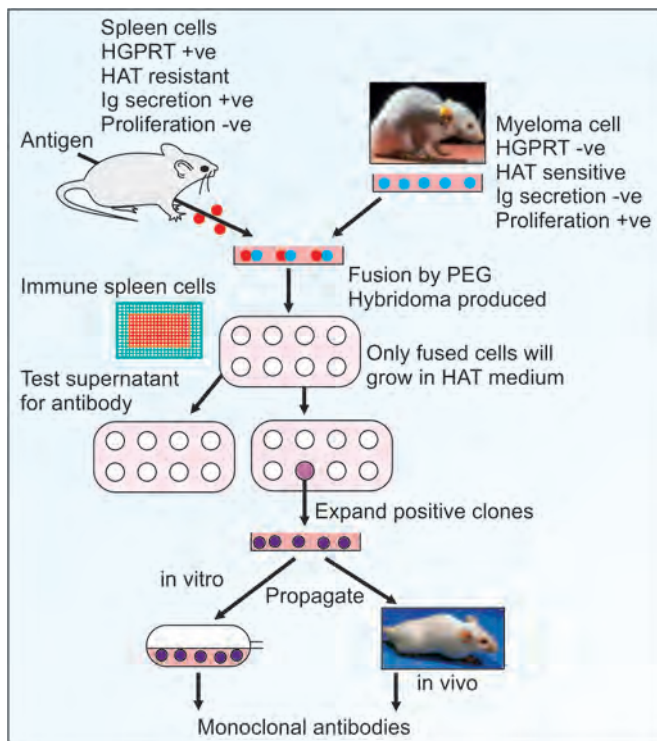
- Enumeration of lymphocyte subpopulations
- Quantitative preparation of specific cells
- As immunosuppressant in clinical conditions
- Nephelometric assays of blood components
- To do ELISA tests
- Quantitative preparation of pure antigens.
- Common therapeutic uses of monoclonal antibodies are shown in Table 49.1.

For drugs used for immunosuppression (Basiliximab and Daclizumab), see Chapter 55, under HLA antigens. For anti-TNF therapy for autoimmune diseases (Etanercept,

Infliximab, Adlimumab), see Chapter 55, under interleukins. For anticancer drugs, see Table 57.10.

### Advantages of Monoclonal Antibody

In a monoclonal preparation, all the antibody molecules are specific against a particular antigen. They have increased **avidity** for attaching with antigen. So in a reaction where polyclonal antibodies require 1 mL, the monoclonals require only microliter quantity. The initial cost for production is high; but when once produced, it could be harvested continuously. Because of these advantages, more and more monoclonal antibodies are now commercially produced. These are highly useful to detect a) serum proteins, b) enzymes, c) hormones, e) drugs, f) bacterial antigens, g) viral antigens, h) cell surface receptors, i) HLA antigens and j) cancer antigens.



**Fig. 49.10:** Principle of production of monoclonal antibodies by hybridoma technique. Myeloma cells propagated in mice ascites. Immunize normal mice with specific antigen. Immune spleen cells and myeloma cells are fused with the help of PEG-1500. The cells are incubated in HAT medium. Unfused lymphocytes will die as they do not have the proliferation capacity. Unfused myeloma cells lack in HGPRT gene, so alternate pathway for DNA synthesis is not available. The main pathway for DNA synthesis is blocked by aminopterin in the HAT medium. So, unfused myeloma cells die. Only fused cells can grow in HAT medium. Some of the wells contain the hybridoma cells secreting the specified antibody. The supernatant in each well is tested for the presence of antibody. Those wells containing the antibody, and selected further. The useful hybridoma cells can be cultured in vitro in culture flasks or in vivo as mice ascitic fluid. Indefinite amount of monoclonal antibodies could be harvested

## MUTATION DETECTION TECHNIQUES

### Single Strand Conformation Polymorphism

Single strand conformation polymorphism (SSCP) analysis involves the heat denaturation of PCR-amplified DNA followed by electrophoresis under non-denaturing conditions. The fragments are visualized by radiolabeling and autoradiography. A variety of non-isotopic methods are now available, including fluorescent labels, and ethidium bromide staining. The SSCP technique relies on the propensity for single-stranded DNA (ssDNA) in nondenaturing conditions to take on a three-dimensional, or secondary, structure that is highly sequence dependent. Consequently, sequence differences can cause alterations to the DNA's secondary structure as well as in electrophoretic mobility. (Fig. 49.11). The optimum sensitivity of SSCP is with fragments as small as 150 bp, where under a single condition, 90% of mutations are detected.

### Heteroduplex Analysis

Heteroduplexes are hybrid DNA molecules that, although largely matched, have one or more mismatched base pairs. Heteroduplexes have been used as a tool to scan for point mutations. They typically appear on native polyacrylamide gels as one or two bands of reduced mobility

**TABLE 49.1:** Common therapeutic uses of monoclonal antibodies

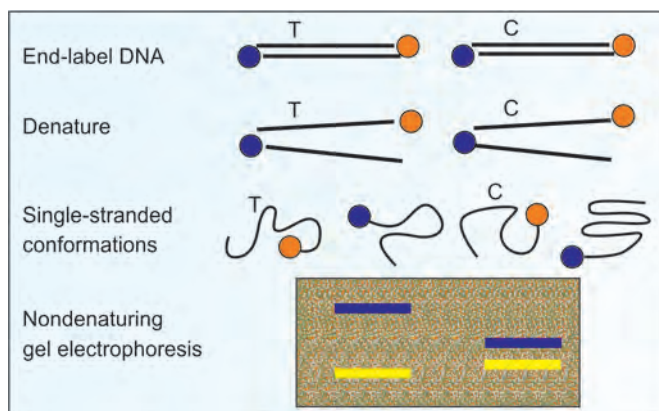
Indication	Target
Transplantation rejection	CD3
Non-Hodgkin's lymphoma	CD20
Rheumatoid arthritis	TNF - $\alpha$
Metastatic breast cancer	HER-2
Leukemias	
Humanized monoclonal antibodies are prepared to overcome problems with immunogenicity.	
Transgenic mice are used to produce fully human antibodies.	

relative to the homoduplex DNA. Heteroduplexes have been visualized using radioisotopes, silver staining, and ethidium bromide staining. The detection efficiency of heteroduplex analysis has been reported to approach 90% under ideal conditions and the optimum size, 250–500 bp.

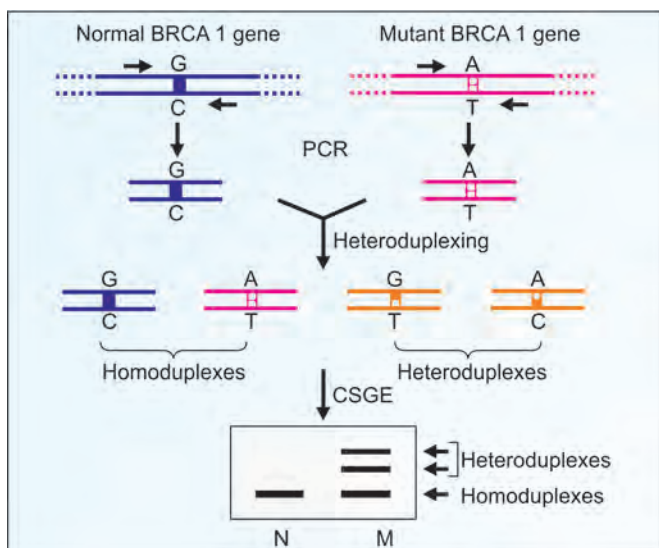
Combined SSCP/heteroduplex analysis exploits the features of both. The gel conditions for both SSCP and heteroduplex analysis are compatible and so it is possible to get “two techniques for the price of one”.

### Conformation Sensitive Gel Electrophoresis

The advantages of Conformation sensitive gel electrophoresis (CSGE) are 1) High sensitivity—More than 99.9% of single base mutations can be detected. 2) Less costly, compared to DNA sequencing. 3) Larger fragments can be analyzed. Conventional SSCP can detect mutations in fragments in the 150–350 bp size range. However, CSGE can be used to detect mutations in up to 500 bp PCR fragments.



**Fig. 49.11:** SSCP analysis. A single nucleotide polymorphism of either thymine (T) or cytosine (C) leads to different single stranded conformations of DNA, which results in different mobilities in electrophoresis



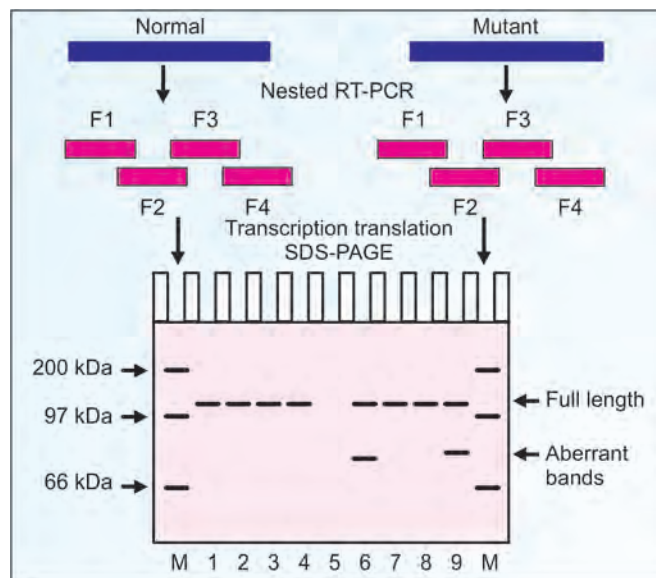
**Fig. 49.12:** Conformation sensitive gel electrophoresis

Single base mismatches produce conformational changes in double-stranded DNA, which leads to differential migration of heteroduplexes and homoduplexes. The gel contains partially denaturing agents, in the form of formaldehyde and ethylene glycol, the conformational changes produced in the first instance get increased further, leading to a clear separation of the heteroduplex bands. Therefore, a normal sequence will give a homoduplex band corresponding to normal DNA, whereas mutant DNA can give theoretically up to 4 bands (Fig. 49.12).

### Protein Truncation Test (PTT)

It is also referred to as the **in vitro synthesized-protein assay (IVSPA)**. This is a method for screening the coding region of a gene for mutations that result in the premature termination of mRNA translation. The polymerase chain reaction (PCR) is used to amplify a DNA template, usually of 1–3 kb in size, that is tested in an *in vitro* transcription and translation assay. Truncated proteins are identified by sodium dodecyl sulfate polyacrylamide gel electrophoresis (SDS-PAGE) and autoradiography or fluorography. The complete coding sequence of a large gene, with many small exons, can be amplified in several overlapping fragments by reverse-transcription PCR (RT-PCR). Amplifying the gene in several segments that overlap each other by 300–500 bp increases the sensitivity of protein truncation test. A truncating mutation located toward the 3' end of one segment will also occur near the 5' end of the next overlapping segment, thus increasing the likelihood of identifying a truncated protein. The size of the truncated protein indicates the position of the premature stop codon, and DNA sequencing of genomic DNA is performed to confirm the presence of a mutation (Fig. 49.13).

There are two main advantages of PTT compared to most other mutation detection methods. Several kilobase segments of a gene can be rapidly screened in a single reaction, and PTT only identifies those mutations that have a clear pathological effect (loss of function).



**Fig. 49.13:** Protein truncation test (PTT) or *in vitro* synthesized protein assay (IVSPA)



## Denaturing High Performance Liquid Chromatography

Denaturing high performance liquid chromatography (DHPLC) can be used to detect single-nucleotide substitutions or small insertions or deletions in double-stranded DNA fragments. Nucleic acids can be bound to a hydrophobic column. The affinity of this interaction is dependent on size, nucleotide composition, and column temperature. An increasing gradient of an organic solvent, usually acetonitrile, is passed over the column and gradually releases bound DNA from the column. After being eluted, the DNA can be detected by ultraviolet (UV) absorbance or, if the DNA has been labeled, by fluorescence.

Under non-denaturing conditions (double-stranded DNA remains fully paired), the interaction is almost completely dependent on fragment size. At high column temperatures, double-stranded DNA is completely denatured into single strands and elution from the column is dependent on both size and sequence. For most purposes, DHPLC is performed under partially denaturing conditions. DNA containing a mismatch has a slightly lower affinity for the column because it makes fewer ion-pairing bonds with the hydrophobic column and will elute before the fully paired DNA. Typically, single-nucleotide mismatches can be reliably detected in DNA fragments of 300–400 nucleotides.

## Transgenesis

It is a form of germ cell gene therapy. A recombinant DNA segment, containing the desired gene from another species, is introduced into the fertilized ova. The embryos are allowed to develop in the uterus of another animal. The animals born are called *transgenic animals*.

When growth hormone gene is introduced, the animals became twice as large as their normal counterparts. The potential applications of these findings are many. Attempts are already under way to increase milk production in cows by transgenic method. The transgenic approach has been used to correct genetically determined hypogonadism in mice. Production of biopharmaceuticals, described under the heading application of cloning of animals, is another example of transgenesis.

## Fusion Proteins

A fusion protein is the product of a fusion gene. A fusion gene is produced by removing a stop codon from the DNA sequence coding for a particular polypeptide and appending the DNA sequence coding for another protein. The product is a fusion protein. Tumor cell targeted immunotherapy can use fusion proteins associated with monoclonal antibodies.

## DNA Sequencing

In 1977, two sequencing techniques have been developed. Sanger's technique is based on constructing a complementary DNA (cDNA) copy of the molecule using deoxy nucleoside triphosphates (dNTPs), a specific synthetic oligonucleotide primer and a DNA polymerase. Gilbert developed the base-specific chemical cleavage method. Both were awarded Nobel prize in 1980.

Sanger's technique is called "controlled termination of synthesis"; it uses chain terminating agents. Suppose the sequence of the polynucleotide is 3' AACTCGAGTA5'. This DNA sample is taken in 4 different test tubes (Fig. 49.14). In all tubes, the **Klenow enzyme** (DNA polymerase without exonuclease activity) and radiolabeled TT as the

primer are added. In all tubes radioactive dNTPs (all the 4 nucleotides which are labeled with  $^{32}\text{P}$ ) are added. Synthesis of a new strand of DNA having a sequence of 5' TTGAGCTCAT3' is started. But in the first test tube, ddTTP (2',3'-di deoxy TTP) is also added. The ddTTP will add the T, but it cannot form the next phosphodiester link, and so further chain lengthening is stopped. In other words, ddTTP will stop chains at T. Instead of ddTTP, the polymerase might add a normal dTTP, in which case chain growth will continue till the next T. Thus in first test tube, TTGAGCT (7 nucleotides) and TTGAGCTCAT (10 nucleotides) are produced.

In the second test tube, ddATP is added, so chain length is stopped at A. So in the 2nd tube, DNA strands having sequences of TTGA (4 nucleotides) and TTGAGCTCA (9 nucleotides) are produced. Similarly, in the 3rd test tube, ddCTP is added, which will contain TTGAGC (6 nucleotides) and TTGAGCTC (8 nucleotides). In the 4th tube containing ddGTP will have TTG (3 nucleotide) and TTGAG (5 nucleotides).

Then the contents of each tube are simultaneously examined on polyacrylamide electrophoresis. The position of these fragments will correspond to the chain length; e.g. chain with 10 nucleotides will move least, while with 3 nucleotide will move maximum and other nucleotides will be arranged in their order of molecular size. The gel is then auto-radiographed. The radiation from  $^{32}\text{P}$  labelled primer will be available in all pieces and will be seen as dark bands in the X-ray plate (Fig. 49.14). From the picture, it can be inferred that 7th and 10th bases are T. Similarly the positions of other bases can also be deciphered. Thus the sequence of the newly synthesised strand is known. The complementary sequence will be present in the original unknown DNA.

Applications of the above mentioned techniques are summarized in Table 49.2.

## Bioinformatics

Bioinformatics is defined as the gathering, processing, data storage, data analysis, information extraction, and visualization of biological data. It allows easy access and retrieval of vast amounts of data. In a broad perspective, bioinformatics describes *any use of computers to handle biological information*. Bioinformatics may be regarded as a synonym for "computational molecular biology". It is the use of computers to characterize the molecular components of living things. It can be applied to store, retrieve, analyze or predict the composition or the structure of biomolecules. A more compact working definition would be: "A summation of all mathematical, statistical and computing methods that

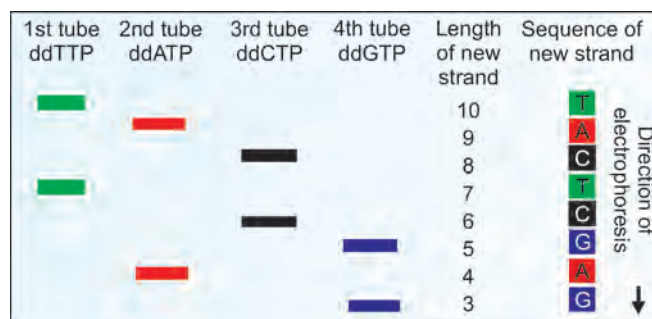


Fig. 49.14: DNA sequencing



aim to solve biological problems using DNA and amino acid sequences and related information.” According to this scheme, the monomers in a given macromolecule of DNA or protein can be treated computationally as **letters of an alphabet**, put together in pre-programmed arrangements to carry messages or do work in a cell.

Bioinformatics embraces Computational Biology, Mathematical Biology, Pharmacogenomics, Proteomics, Genomics, Biophysics, Medical Informatics and Cheminformatics.

### Applications of Bioinformatics

A lot of bioinformatics work is concerned with the technology of databases. These databases include both “public” repositories of gene data like GenBank or the Protein DataBank (the PDB). Databases of existing sequencing data can be used to *identify homologues* of new molecules that have been amplified and sequenced in the lab. The property of sharing a common ancestor, *homology*, can be a very powerful indicator in bioinformatics.

Bioinformatics can be used to obtain sequences of genes or proteins of interest, either from material obtained, labeled, prepared by individual researchers/groups or from repositories of sequences from previously investigated material.

Sequence analysis can be done by three ways: 1. They can be *assembled*. 2. They can be *mapped*. 3. They can be *compared* for their homologous nature with sequences already existing in the database. If a homologue (a related molecule) exists, then a newly discovered protein may be modeled, that is, the three dimensional structure of the gene product can be predicted without doing laboratory experiments.

Bioinformatics is used in *designing primers for PCR*. It is also used to attempt to *predict the function* of actual gene products. There

are tools which allow making *predictions* of the secondary structure of proteins arising from a given amino acid sequence. Structural biologists use “bioinformatics” to handle the vast and complex data from X-ray crystallography, nuclear magnetic resonance (NMR) and electron microscopy investigations and create the 3-D models of molecules.

### Nanotechnology

Nanotechnology is an exciting new science which deals with miniaturization of devices and processes at the nanometer ( $10^{-9}$  m) scale. To give an idea, human hair varies from 18 to 180 micrometers. Thus nanotechnology is working at a level 100–1000 times smaller than human hair. Nanotechnology is the science for understanding and control of matter at dimensions between 1 and 100 nanometers. Nanotechnology involves imaging, measuring, modeling, and manipulating matter at nanoscale, applicable to both engineering and medicine. Unusual physical, chemical, and biological properties can emerge in materials at the nanoscale. Richard Feynmann (1918–1988) is considered to be the father of modern nanotechnology. The word “nanotechnology” was coined by Norio Tanigushi (1974). It can be said that nanotechnology is a marriage of medicine and engineering disciplines. Many tools of nanotechnology are derived from biotechnology and have wider applications in medicine. When nanotechnology is used for biotechnological advances it is known as nanobiotechnology.

Bionanotechnology applications in medicine are very wide and include the fields of AIDS, cancer, gene therapy and drug delivery. Instruments like Atomic Force Microscope (AFM) and Scanning Tunneling Microscope (STM) are currently available which allow visualization at nanometer range. Biodegradable nanomaterials, nanocosmetics, fabrics, etc. are also using nanotechnology principles. In nature, the hanging of geckos (small lizards) from the rooftop and the folding of the flowers of touch-me-not plant are said to be based on nanobiology. Every square millimeter of a gecko’s footpad contains about 14,000 hair-like setae. Each seta has a diameter of 500 nanometers. Because of this special adaptation of Geckos can adhere to most surfaces without the use of liquids or surface tension.

### Drug Delivery

Nanoparticles could be used to deliver drugs to specific types of cells (such as cancer cells). Particles are attracted to diseased cells, which allow direct treatment of those cells. This technique reduces damage to healthy cells in the body and allows for earlier detection of disease. The drug to be administered is encapsulated in a nanoparticle which helps it pass through the stomach to deliver the drug into the bloodstream. Efforts are underway to develop oral administration of several drugs using a variety of nanoparticles.

### Therapeutics

Nanoshells may be used to concentrate the heat from infrared light to destroy cancer cells with minimal damage to surrounding healthy cells. Nanoparticles, when activated by X-rays, generate electrons that cause the destruction of cancer cells to which they have attached themselves. This is intended to be used in place of radiation therapy with much less

**TABLE 49.2: Techniques and their applications**

Technique	Applications
Southern blot	Specific DNA segment (sequence) detection
Northern blot	Detection of a specific gene expression
Western blot	Identification of a specific protein
In situ hybridization	Location of a gene on a specific chromosome
DNA microarray	Presence and expression of various genes
Polymerase chain reaction	In vitro amplification of a DNA sequence
Single strand	Detection of mutations in small fragments conformation polymorphism
Heteroduplex analysis	Scanning for point mutations
Conformation sensitive gel electrophoresis	Detection of single base mutations in longer fragments
Protein Truncation Test	Screening the coding region for truncation test termination mutations
Denaturing high performance chromatography	Detect single nucleotide substitutions liquid

damage to healthy tissue. Aluminosilicate nanoparticles can quickly reduce bleeding time in trauma patients by absorbing water, causing blood in a wound to clot quickly. Nanofibers can stimulate the cartilage production in damaged joints.

### Imaging Techniques

Quantum Dots (qdots) may be used in the future for locating tumors in patients and for performing diagnostic tests. The nanoparticle is coated with a peptide that binds to a cancer cell, once the nanoparticles are attached to the tumor the magnetic property of the iron oxide enhances the images from the magnetic resonance imaging scan. Nanoparticles can attach to proteins or other molecules, allowing detection of disease indicators in a sample at a very early stage.

### Antimicrobial Techniques

One of the earliest nanomedicine applications was the use of nanocrystalline silver which is an antimicrobial agent for the treatment of wounds. The nanoparticles containing nitric oxide gas are known to kill bacteria.

### Cellular Repair

Nanorobots could be programmed to repair specific diseased cells, functioning in a similar way to antibodies in our natural healing processes.

### Aquasomes

These are recently developed delivery systems that are making a niche as peptide/protein carriers. These are nanoparticle carrier systems with three layered self-assembled structures. They comprise the central solid nanocrystalline core coated with polyhydroxy oligomers onto which biochemically active molecules are adsorbed. The solid core provides the structural stability. The carbohydrate coating acts as dehydroprotectant and stabilizes the biochemically active molecules. Due to this property of maintaining the conformational integrity of bioactive molecules, aquasomes are being proposed as a carrier system for delivery of peptide based pharmaceuticals. The delivery system has been successfully utilized for the delivery of insulin, hemoglobin and various antigens. Oral delivery of enzyme peptidase has also been achieved.

### Nanotoxicology

It is the study of the toxicity of nanomaterials. Nanoparticles have much larger surface area to unit mass ratios, which in some cases may lead to greater proinflammatory effects. For example, silica nanoparticles when inhaled will cause inflammation and fibrosis in lung, named as silicosis.

## Clinical Case Study 49.1

A 4-year-old boy was brought to the hospital. His mother was concerned that he was walking in an awkward manner, fell over frequently, and had difficulty in climbing stairs. Family history revealed a maternal uncle who died due to muscular dystrophy at the age of 19. Clinical examination

showed muscle weakness in shoulder and pelvic girdles and enlargement of calf muscles. A tentative diagnosis of Duchenne muscular dystrophy was made. What is the defect in this condition?

## Clinical Case Study 49.1 Answer

Duchenne muscular dystrophy (DMD) is due to mutations in DMD gene. The gene encodes a protein known as dystrophin. All muscular dystrophies are progressive in nature and many are genetically inherited. Dystrophin acts as a link between actin in the cytoskeleton and the extracellular matrix and helps anchor the muscle fiber to the extracellular matrix. Dystrophin and its isoforms are found in skeletal muscles, smooth muscles and brain.

Patients usually present in the 3rd–5th year of life with motor delay or abnormal gait, difficulty in running, getting up from ground, frequent falls, etc. There may be pseudohypertrophy of calf muscles (fibro-fatty replacement of degenerating muscle tissue). Cardiac defects include cardiomyopathy and rhythm changes. Respiratory involvement by 16–18 years include scoliosis (which impairs pulmonary functions), respiratory failure (due to progressive failure of intercostals muscles), hypercapnia and severe respiratory infections.

Laboratory analysis reveals elevated serum CK (10–100 times above normal), AST, ALT and LDH. Muscle biopsy (shows deficient dystrophin), electromyography and PCR can be used for confirmatory diagnosis.

## QUICK LOOK OF CHAPTER 49

1. A probe is a single stranded piece of DNA, labeled with a radioactive or a non-radioactive label, the sequence of which of complementary to the target DNA.
2. Southern blot is a technique used to detect a specific segment of a DNA. It has diagnostic and forensic applications.
3. Northern blot is used to detect a specific RNA.
4. Western blot is used to detect a specific protein.
5. Molecular cloning in medicine can be used for diagnosis of genetic diseases such as Duchenne Muscular Dystrophy (DMD), Huntington's chorea, Sickle cell anemia, etc.
6. Polymerase chain reaction (PCR) is an in vitro DNA amplification procedure in which millions of copies of a particular sequence of DNA can be produced within hours.

7. The enzyme used in PCR is Taq polymerase. Applications of PCR include diagnosis of bacterial and viral diseases, genetic disorders, cancers, solving medicolegal cases and in paleontology.
8. Hybridoma technique is used to generate monoclonal antibodies. They are used in immunological research, ELISA, nephelometry, etc.
9. DNA microarray is used for identification of the presence and expression of various genes.
10. Polymerase chain reaction is used for in vitro amplification of a DNA sequence.
11. Single strand conformation polymorphism is employed for detection of mutations in small fragments.
12. Heteroduplex analysis is done for scanning for point mutations.
13. Conformation sensitive gel electrophoresis is used for detection of single base mutations in longer fragments.
14. Protein truncation test is useful for screening the coding regions for termination mutations.
15. Denaturing high performance liquid chromatography (DHPLC) is employed to detect single nucleotide substitutions.

# SECTION F

---

## Hormones

- Chapter 50 Mechanisms of Action of Hormones and Signaling Molecules
- Chapter 51 Hypothalamic and Pituitary Hormones
- Chapter 52 Steroid Hormones
- Chapter 53 Thyroid Hormones
- Chapter 54 Gut Hormones





# CHAPTER 50

## Mechanisms of Action of Hormones and Signaling Molecules

### Chapter at a Glance

The reader will be able to answer questions on the following topics:

- Signal transduction
- Cyclic AMP and G-proteins
- Protein kinases
- Hormones acting through calcium
- Hormones acting through PIP2 cascade
- Cyclic GMP
- Hormone response element

The nervous system and endocrine system are the major control mechanisms that integrate the functions of the tissues in the body. The nervous system transmits electrochemical signals between the brain and peripheral tissues for coordinating the diverse body functions. The endocrine system releases chemical mediators or hormones into the circulation. However, both these systems converge, so that neural regulation of endocrine glands is effected. Moreover, neurotransmitters have several features in common with hormones. EH Starling in 1905 introduced the term “hormone”.

Signal molecules are of different types and the process of transferring the signal into the cell is called signal transduction. There are two types of cells in signal transduction—the **sender cell** where the signal originates and the **target cell** that receives the signal. The signal alters or modulates the activity/function of the cell.

**Autocrine** signaling occurs when same cell acts as sender and recipient, e.g. growth, differentiation, immune and inflammatory response. **Paracrine** signaling is

effected by local mediators which have their effect near the site of secretion without entering the circulation. The effect is rapid and transient. **Juxtacrine** signaling occurs when the two type of cells are adjacent to each other so that contact is established through gap junctions or through protein molecules on the surface of the two cells. **Endocrine** signaling is between cells which are located at a distance from each other and the signal may be hormones or chemical messengers secreted into circulation. Once they reach the target cell, they bind to specific target cell receptors with high affinity.

Plasma carrier proteins exist for all classes of endocrine hormones. Carrier proteins for peptide hormones prevent hormone destruction by plasma proteases. Carriers for steroid and thyroid hormones allow these hydrophobic hormones to be present in the plasma. Carriers for small, hydrophilic amino acid-derived hormones prevent their



Earl  
Sutherland  
NP 1971  
1915–1974

Alfred  
Gilman  
NP 1994  
b. 1941

Martin  
Rodbell  
NP 1994  
1925–1998

filtration through the renal glomerulus, greatly prolonging their circulating half-life.

The classical **definition** of a hormone is “substances released from ductless or endocrine glands directly to the blood”. A more modern definition of a hormone is that it is *synthesized by one type of cells and transported through blood to act on another type of cells*. Based on mechanism of action, the hormones may be classified into two (Table 50.1):

- I. Hormones with cell surface receptors
- II. Hormones with intracellular receptors.

## Hormones Acting through Cyclic AMP

Cyclic AMP (cAMP) was first discovered by Earl Sutherland in 1961, who was awarded Nobel prize in 1971. Signal transduction pathways are like a river flowing in one direction only; components closer to the receptor are called “upstream” and closer to the response are called “downstream”.

### Signal Transduction through G-Protein

Action is through G-protein coupled receptors (GPCRs). Binding of different types of signal molecules to G-protein coupled receptors is a general mechanism of signal transduction. Action of several hormones is effected through this mechanism (Table 50.1). The GPCRs are transmembrane proteins with 7 helical segments spanning the membrane.

When any ligand binds, the GPCRs activate heterotrimeric **GTP** binding regulatory proteins (**G**-proteins). The G-protein in turn will interact with effector proteins which may be enzymes or ion channel proteins, which result in the desired effect. Different types of G-proteins are present in the cells that are coupled with different receptors and activating different effector proteins.

The extracellular messenger, the hormone (H) combines with the specific receptor (R) on the plasma membrane (Fig. 50.3). The H-R complex activates the regulatory

**TABLE 50.1:** Mechanism of action of hormones (for expansions or abbreviations, see Appendix No.I)

Group	Mechanism of action	Examples of hormone
I A	Hormones bind with cell surface receptors with cAMP as the second messenger	ACTH, ADH, FSH HCG, LH, TSH MSH, PTH, CRH Glucagon, Calcitonin Catecholamines Retinoic acid
I B	Hormones having cell surface receptors; cGMP as second messenger	ANF (atrial natriuretic factor), NO (nitric oxide)
I C	Hormones having cell surface receptors; second messenger is calcium or phosphatidyl inositol (PIP <sub>2</sub> )	TRH, GnRH catecholamines Acetylcholine CCK, Gastrin Vasopressin Oxytocin, PDGF
I D	Hormones having cell surface receptors and mediated through tyrosine kinase	Insulin Somatomedin EGF, FGF PDGF, CGSF NGF, IGF
I E	Hormones having cell surface receptors, but intracellular messenger is a kinase or utilize phosphatase cascade	IL, GH, PRL, TNF, Adiponectin, Leptin, Resistin, Erythropoietin
II	Hormones that bind to intracellular receptors	Glucocorticoids Mineralocorticoids Estrogens, Progesterone Androgens Calcitriol, Thyroxine

component of the protein designated as G-protein or nucleotide regulatory protein. G-proteins are so named, because they can bind GTP and GDP. GDP-GTP exchange is mediated by the GEF (**G**uanine nucleotide exchange factor). The G- protein is a trimeric membrane protein consisting of alpha, beta and gamma subunits (Fig. 50.3). Alfred Gilman and Martin Rodbell were awarded Nobel prize in 1994 for their work on G-protein. Robert Lefkowitz and



Robert  
Lefkowitz  
NP 2012  
b. 1943



Brian Kobilka  
NP 2012  
b. 1955

Brian Kobilka were awarded Nobel prize in 2012 for their studies on G-protein-coupled receptors (GPCRs). Most of the hormone/ligand signals are transduced through GPCR. Around 50% of medicines are acting through GPCR.

### G-protein Activates Adenyl Cyclase

When the hormone receptor complex is formed, the activated receptor stimulates the G-protein, which carries the excitation signal to adenylate cyclase (Fig. 50.4-2).

The hormone is not passed through the membrane; but only the signal is passed; hence this mechanism is called **signal transduction**. The adenyl cyclase is embedded in the plasma membrane (Fig. 50.4).

### Subunit Activation of G-protein

The inactive G-protein is a trimer with alpha, beta and gamma subunits. When activated, GTP binds and the beta-gamma subunits dissociate from the alpha subunit. Adenylate cyclase is activated by G-alpha-GTP (Fig. 50.4-2). The binding of hormone to the receptor triggers a configurational change in the G-protein which induces the release of bound GDP and allows GTP to bind. The hormone has an amplified response, since several molecules of G-alpha-GTP are formed.

### Inactivation

The active G-alpha-GTP is immediately inactivated by GTPase. The G-alpha-GDP form is inactive (Fig. 50.2). The activation is switched off when the GTP is hydrolyzed to GDP by the GTPase activity of the alpha subunit (Fig. 50.2). This is a built-in mechanism for deactivation. Thus GTPase acts as a molecular switch. The alpha subunit, which is bound to GDP, can re-associate with beta and gamma subunits. The GTP-GDP exchange rate decides the activity of adenyl cyclase.

### Cyclic AMP

Adenyl cyclase or adenylate cyclase converts ATP to cAMP (3',5'-cyclic AMP), and phosphodiesterase hydrolyzes cAMP to 5' AMP (Fig. 50.1). Structure of cAMP is shown in Figure 43.8. Table 50.1 contains the list of hormones mediated through cyclic AMP. Box 50.2 shows the hormones which stimulate or inhibit the adenyl cyclase. Cyclic AMP is a second messenger produced in the cell in response to activation of adenylate cyclase by active

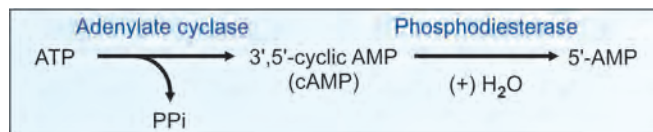


Fig. 50.1: Synthesis, degradation of cyclic AMP

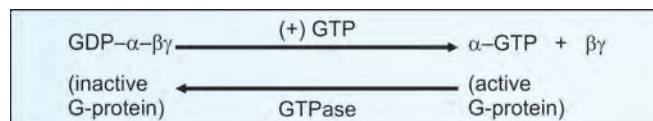


Fig. 50.2: Inactive and active forms of G-protein

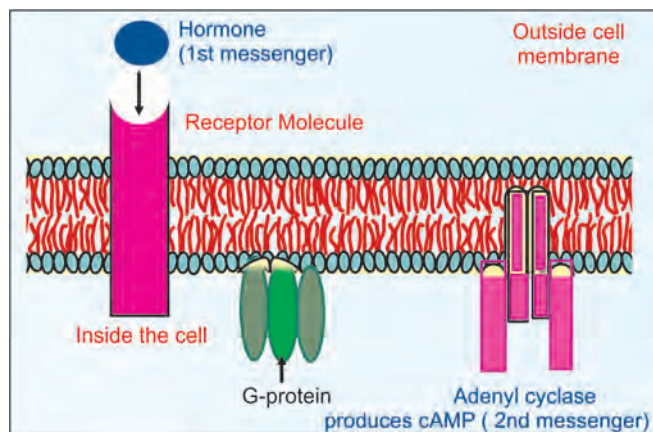


Fig. 50.3: Hormone binding activates G-protein

G-protein. During hormonal stimulation, cyclic AMP level in the cell increases several times.

The level of cyclic AMP in the cell is regulated by its rate of production by adenylate cyclase (AC) and hydrolysis by phosphodiesterase (PDE). The action of PDE is also regulated by hormones and drugs. Therefore, cellular level of cyclic AMP can be increased by inhibition of PDE. For example insulin activates PDE, decreasing the cellular level of cAMP while caffeine and theophylline inhibit PDEs increasing cAMP levels.

### Second Messenger Activates PKA

The cAMP (second messenger), in turn, activates the enzyme, PKA (Cyclic AMP dependent protein kinase). Cyclic AMP binds to the regulatory subunits of PKA so that the catalytic subunits having kinase activity can phosphorylate proteins. The cascade amplification effect is seen in this series of activation reactions. This PKA is a tetrameric molecule



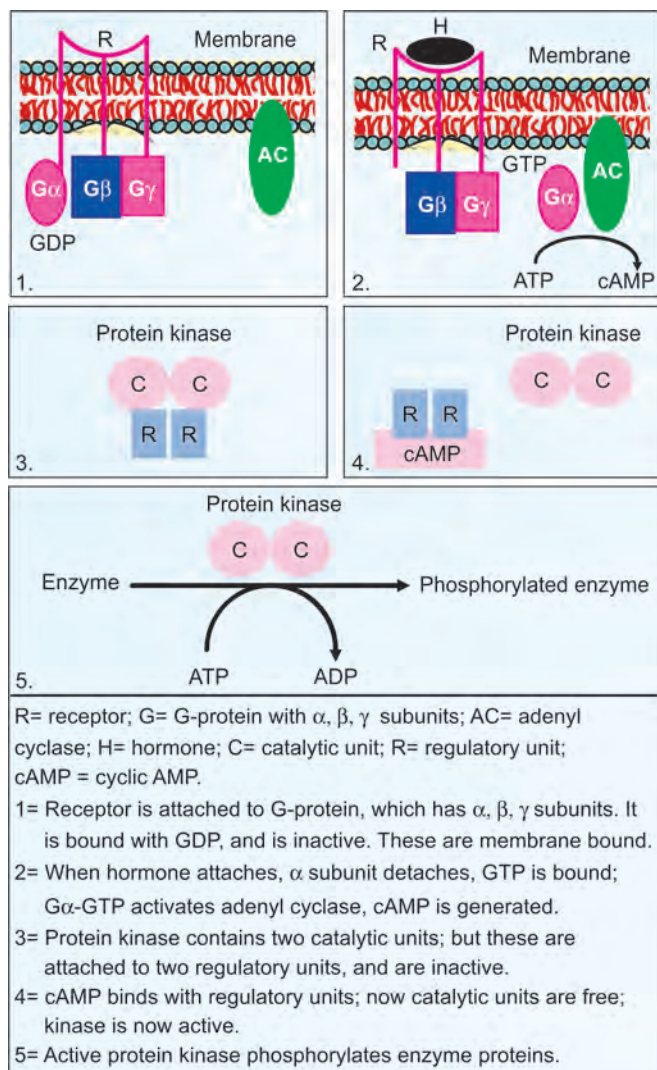


Fig. 50.4: Action of hormone through G-protein

having two regulatory (R) and two catalytic (C) subunits (R<sub>2</sub>C<sub>2</sub>) (Fig. 50.4-3). This complex has no activity. But cAMP binds to the regulatory subunit and dissociates the tetramer into regulatory and catalytic subunits (Fig. 50.4-4). The catalytic subunit is now free to act.

### Kinase Phosphorylates the Enzymes

The catalytic subunit then transfers a phosphate group from ATP to different enzyme proteins (Fig. 50.4-5). Phosphorylation usually takes place on the OH groups of **serine, threonine or tyrosine** residues of the substrates.

Hence, these kinases are called Ser/Thr kinases. The enzymes may be activated or inactivated by this phosphorylation. This is an example of covalent modification. A

summary of the cascade activation of enzymes by the hormone is shown in Figure 50.5. Glycogen phosphorylase (see Fig. 10.5) and hormone sensitive lipase (see Fig. 12.16) are controlled by cyclic AMP. The hormones that are acting through cyclic AMP are enumerated in Table 50.1.

### There are Many G-proteins

About 30 different G-proteins are identified, each being used for different signal transduction pathways. The G-protein, which stimulates adenylyl cyclase, is called G<sub>s</sub> (**G-stimulatory**) and the opposite group is called G<sub>i</sub> (**G-inhibitory**). An example of inhibitory G-protein is the inhibition of adenylyl cyclase. The alpha subunit of the G<sub>s</sub> and G<sub>i</sub> are different, but beta and gamma are the same (Table 50.2). G-proteins are also involved in toxic manifestations of cholera and pertussis. Mutations in gene encoding the alpha subunit of G<sub>s</sub>-protein or abnormalities in G-protein signaling have been found to result in the action of toxins (Box 50.1).

### There are Many Protein Kinases

More than thousand protein kinases are now known. Some important hormone responsive protein kinases are, cAMP-dependent kinases, epidermal growth factor-dependent tyrosine kinase, insulin-dependent tyrosine kinase. All the known effects of cAMP in eukaryotic cells result from activation of protein kinases, which are serine/threonine kinases (Table 50.3).

## Glycogen Phosphorylase is a Typical Example

Glycogen phosphorylase and hormone sensitive lipase are activated by cAMP mediated cascade (Figs 50.5 and 10.5). Table 50.1 contains the list of hormones, where cyclic AMP is the second messenger.

The termination of the effect of the hormonal action by **phosphorylation** is effected by the action of protein phosphatases. For example, glycogen phosphorylase becomes

TABLE 50.2: G-protein families and their functions

G $\alpha$ class	Initiating signal	Downstream signal
G <sub>s</sub>	$\beta$ -adrenergic amines, glucagon, PTH, TSH, corticotrophin, many others	Stimulates adenylyl cyclase
G <sub>i</sub>	Acetylcholine, $\alpha$ adrenergic amines, many neurotransmitters, chemokines	Inhibits adenylyl cyclase
G <sub>q</sub>	Acetylcholine, $\alpha$ adrenergic amines, many neurotransmitters, TRH	Increases IP <sub>3</sub> and intracellular calcium
G <sub>t</sub> (Transducin)	Photons	Stimulates cGMP phosphodiesterase

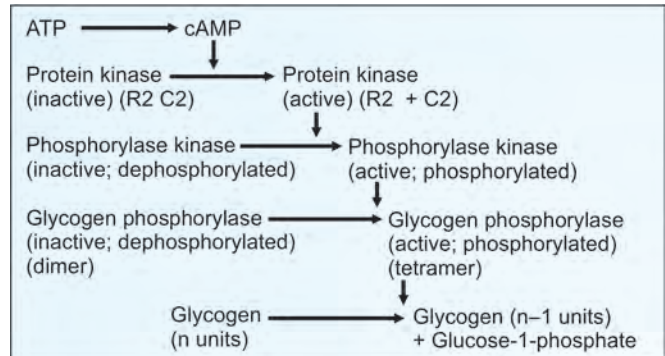
**Box 50.1: Abnormal G-protein signaling**

**Cholera** toxin is encoded by a bacteriophage present inside the bacteria *Vibrio cholerae*. The enterotoxin contains two A subunits and 5 B subunits. The B subunit binds to a ganglioside GM1 on the surface of intestinal mucosal cell. The A subunit then enters into the inner part of the membrane, which leads to ribosylation of the alpha subunit of Gs protein. This results in the inhibition of the inherent GTPase activity and irreversible activation of G protein. Therefore, adenyl cyclase remains continuously active and keeps cyclic AMP levels high. This prevents absorption of salts from intestine leading to watery diarrhea and loss of water from body. In the large intestine, chronic elevation of cAMP results in a sustained PKA mediated phosphorylation of chloride channels (CFTRs) that normally regulate salt and water transport. Hyperactivity of these channels will result in loss of sodium chloride with watery diarrhea (liquid stools), that may have fatal results. The patient may lose as much as 1 L of water per hour.

**Pertussis** toxin ribosylates the alpha subunit of Gi-protein and prevents the Gi-GDP complex from interacting with the activated receptor. Hence, the action of hormones acting through Gi is inhibited.

Effects of bacterial toxins from *Clostridium tetani* are exerted through proteases, that attack proteins involved in synaptic vesicle and plasma membrane fusion. The toxin has two polypeptides, one of which binds to cholinergic motor neurons and facilitates the entry of the second polypeptide. It is a protease that cleaves the protein necessary for vesicle fusion. Failure to release the neurotransmitter leads to fatal paralysis of the chest muscles.

Mutations in gene encoding the alpha subunit of Gs-protein (gsp gene) has been found to result in decreased GTPase activity of the alpha subunit, leading to continued activation of Gs alpha and adenyl cyclase. The resultant increase in cAMP has been found to lead to PKA-dependent phosphorylation of cyclic AMP sensitive gene regulatory proteins. Over-expression of cAMP inducible genes has been found to produce growth hormone/ACTH secreting tumors of the pituitary.



**Fig. 50.5:** cAMP mediated cascade

**Box 50. 2: Second messengers**

They are produced in response to binding of signal molecules (hormones) to receptors.

They bring about activation of enzyme cascades or changes in plasma membrane potential.

They may be water soluble or lipid soluble.

Water soluble messengers are cAMP, cGMP, Inositol triphosphate (ITP).

Lipid soluble messengers are Diacyl glycerol (DAG) and Phosphatidyl inositol triphosphate (PIP3).

**Box 50.3: Hormones acting through adenyl cyclase**

**Hormones stimulate adenyl cyclase:** ACTH, ADH, Calcitonin, CRH, FSH, Glucagon, epinephrine, hCG, LH, LPH, MSH, PTH and TSH.

**Hormones inhibit adenyl cyclase:** Acetylcholine, angiotensin II and somatostatin.

inactive in the dephosphorylated state. But, glycogen synthase is active in dephosphorylated state (see Fig.10.5).

Certain enzymes are activated by dephosphorylation (Table 50.1). Hepatic **Protein Phosphatase-1** is a typical example where the enzyme

**TABLE 50.3:** Protein kinases (Phosphorylated proteins)

Signal molecule	Second messenger	Protein kinase	Type	Substrates
Hormones (glucagon, epinephrine, HSL, ADH, glycogen, ACTH, PTH, etc.	cAMP	Protein kinase A	Ser/Thr	Enzymes like phosphorylase, PFK2, CREBs, etc.
Nitric oxide, AMP	cGMP	Protein kinase G	Ser,Thr	Myosin, transducin
Serotonin, TRH	Calcium, IP3	Cam kinase	Ser/Thr	Exocytosis, smooth muscle contraction
Oxytocin, PDGF	DAG	Protein kinase C	Ser/Thr	Transcription factors, ion channel transporters
Growth factors, cytokines	PIP3	Protein kinase B	Ser/Thr	Glycogen metabolism, glucose transport, death signals like BAD
Insulin and insulin like growth factors	RTK in receptor	Tyrosine kinase	Tyr	IRS-1 (Insulin response substrate 1), IRS-2, MAP kinase, PDK
GH, prolactin, cytokines	RTK in receptor	Janus kinase (JAK)	Tyr	STAT (Signal transducers and activators of transcription

**TABLE 50.4:** Hormone response elements (HREs); N means any nucleotide may be present at that place

Hormone	Name of HRE	Nucleotide sequence at the specific area of binding on DNA
Glucocorticoid	GRE	(GGTACA)NNN (TGTTCT)
Mineralocorticoid	MRE	do
Androgens	ARE	do
Estrogens	ERE	(AGGTCA)NNN (TGACCT)
Thyroxin	TRE	(GATCA)NNNNN (TGACC)
Vitamin D	VDRE	do
Cyclic AMP	CRE	TGACGTCA

itself is inhibited by phosphorylation of its regulatory subunit. When cyclic AMP level falls, the regulatory subunit is dephosphorylated and protein phosphatase becomes active, which in turn hydrolyzes phosphate group from the enzyme. Protein kinases as well as protein phosphatases are involved in the action of different hormones. The actions of cAMP in eukaryotic cells is multifaceted and these include:

- A. Activation of protein kinase and phosphorylation of effector proteins like enzymes and ion channels. These enzymes may directly phosphorylate enzymes or secondary kinases that phosphorylate other enzyme. For example,
  - i. PKA phosphorylates hormone sensitive lipase thus activating it.
  - ii. Phosphorylase kinase that phosphorylates glycogen phosphorylase.
  - iii. When ion channel proteins or transporters are phosphorylated, the membrane potential is modified, thus regulating the influx of calcium.
- B. cAMP also has a long lasting effect on gene expression. The translocation of the active PKA subunits to the nucleus induces phosphorylation of cAMP regulated gene regulatory proteins or CREBs. These proteins will bind to cAMP sensitive regulatory elements (CRE) on genes, thus controlling their expression.
- C. G-protein mediated signal transduction also requires scaffold and adapter proteins that increase the fidelity and speed of a signaling cascade. Anchoring proteins localize and concentrate the signaling proteins at their site of action. The interaction of these proteins involve specific domains within the protein like SH2 (Src homology type 2), PTB (phosphor tyrosine binding), etc.

## Calcium-based Signal Transduction

Calcium is an important intracellular regulator of cell function like contraction of muscles, secretion of hormones and neurotransmitters, cell division and regulation of gene regulation. Rapid but transient increase in cytosolic calcium result from either opening of calcium channels in the plasma membrane or calcium channels in the ER. The released calcium can be rapidly taken-up by ER to terminate the response.

The intracellular calcium concentration is low ( $10^{-7}$ ) where as extracellular calcium concentration is very high ( $10^{-3}$ ), maintaining a 10,000 fold calcium gradient across the membrane. The inside has a negative potential therefore influx of calcium is rapid. Even small increase in cytosolic free calcium can have maximal effect on calcium regulated cellular functions. There are mainly 3 types of calcium transport systems:

- a. Voltage gated calcium channels
- b. Sodium/calcium antiport transporter
- c. Calcium transporting ATPase.

The calcium transporting ATPase transporter accumulates calcium within the lumen of ER (sarcoplasmic reticulum) in muscle. These calcium ions can be released into the cytoplasm by an inositol triphosphate (IP<sub>3</sub>) gated calcium channel or by a ligand gated calcium release channel (ryanodine receptor).

When cytosolic calcium increases, binding regulatory proteins, activation of several calcium binding regulatory proteins occurs. Calmodulin is expressed in various tissues and mediates the regulatory actions of calcium ions. Calcium binding causes conformational change in calmodulin resulting in interaction with kinases, phosphatases, NOS, etc. Some of these CAM kinases can phosphorylate a wide range of proteins that alter cellular functions. When bound to calmodulin, CAM kinase II also autophosphorylates, so that its activity is sustained. Intracellular calcium acts as a mediator of hormone action either independently or in conjunction with cAMP. As an example, see **phosphorylase kinase** reaction, in Chapter 10.

Hormones can increase the cytosolic calcium level by the following mechanisms:

- A. By altering the permeability of the membrane.
- B. The action of Ca-H<sup>+</sup>-ATPase pump which extrudes calcium in exchange for H<sup>+</sup>.
- C. By releasing the intracellular calcium stores.
- D. **Calmodulin**, the calcium dependent regulatory protein within the cell has four calcium binding sites. When calcium binds there is a conformational change to the calmodulin, which has a role in regulating various kinases. Calmodulin is a 17 kDa protein which has structural and functional similarity with the muscle protein troponin C. Examples of enzymes or functional proteins regulated by calmodulin are: Adenyl cyclase, calcium-dependent protein kinases, calcium-magnesium-ATPase, cyclic nucleotide phosphodiesterase, nitric oxide synthase and phosphorylase kinase.

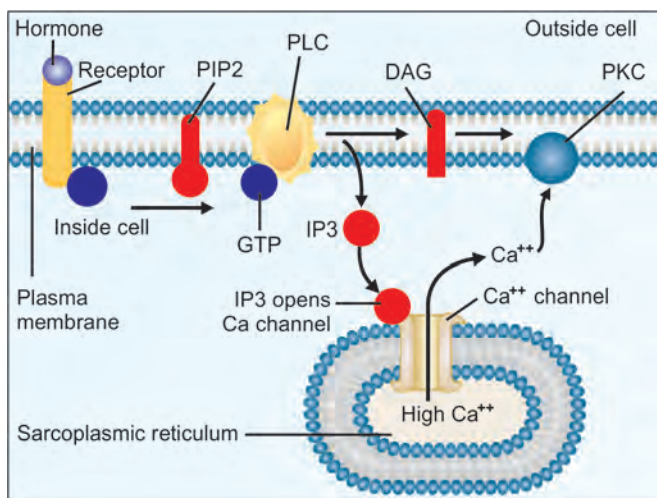


## Hormones Acting through PIP<sub>2</sub> Cascade

The major player in this type of signal transduction is phospholipase C that hydrolyses phosphatidyl inositol in membrane lipids to 1,4,5-Inositol triphosphate (IP<sub>3</sub>) and Diacyl Glycerol (DAG) that act as second messengers. PIP<sub>3</sub> (Phosphatidyl Inositol 3,4,5- phosphate) is another second messenger produced by the action of a phosphoinositide kinase. The phospholipase C may be activated either by G-proteins or calcium ions. DAG can also be generated by the action of phospholipase D that produces phosphatidic acid which is hydrolyzed to DAG.

The binding of hormones like serotonin to cell surface receptor triggers the activation of the enzyme **phospholipase-C** which hydrolyzes the phosphatidyl inositol to diacylglycerol. **IP<sub>3</sub>** can release Ca<sup>++</sup> from intracellular stores, such as from endoplasmic reticulum and from sarcoplasmic reticulum (Fig. 50.6). The elevated intracellular calcium then triggers processes like smooth muscle contraction, glycogen breakdown and exocytosis.

PIP<sub>3</sub> can be formed by the action of PI<sub>3</sub>-kinases that are activated through growth factors and cytokine mediated receptor tyrosine kinases. PIP<sub>3</sub> which is a lipid second messenger has a role in regulation of cell motility, membrane trafficking and cell survival signaling pathways. The major mediator of PIP<sub>3</sub> action is PKB (Protein kinase B) which has a role in glucose transport, glycogen metabolism and cell death signaling pathways. Active PKB/Akt is the major mediator of PIP<sub>3</sub> action. It represses the activity of



**Fig. 50.6:** PIP<sub>2</sub> and DAG acting as second messengers. PIP<sub>2</sub> = phosphatidyl inositol bisphosphate. IP<sub>3</sub> = inositol triphosphate. DAG = diacyl glycerol. PLC = phospholipase C. PKC = protein kinase C.

cell death signaling pathways. The PDK (Phosphatidylinositol dependent kinase) and IP<sub>3</sub> kinase are also involved in glucose transport and glycogen metabolism.

There is “cross talk” between the various signal transduction pathways that are coordinately regulated.

## Diacylglycerol Pathway

Diacylglycerol (DAG), the messenger formed by the hydrolysis of PIP<sub>2</sub> activates protein kinase C (PKC) which in turn would phosphorylate other target proteins. PKC activates several serine threonine kinases that phosphorylate several substrates including transcription factors, ion channels and transporters. Most effects of IP<sub>3</sub> and DAG are found to be synergistic. DAG also increases the affinity of protein kinase-C for calcium. The enzymes are thus activated, even at physiological levels of calcium within the cell.

## Role of Cyclic GMP

Cyclic GMP (cGMP) is another important second messenger involved in contractile function of smooth muscles, visual signal transduction and maintenance of blood volume. Cyclic GMP degradation is catalyzed by membrane bound PDEs.

- i. It is formed from GTP by the action of **guanyl cyclase**. Several compounds have been found to increase the concentration of cGMP by activating guanyl cyclase.
- ii. These include drugs like nitroprusside, nitroglycerin, sodium nitrite and atriopeptides (a group of peptides produced by atrial cardiac tissue). All these compounds act as potent vasodilators, by inhibiting the phosphodiesterase. See mechanism of action of nitric oxide (see Chapter 17).
- iii. Cyclic GMP activates cGMP-dependent protein kinase G (PKG), which phosphorylates important effector proteins that can regulate calcium dependent contraction or motility by modulating calcium influx. An example is smooth muscle myosin, leading to relaxation and vasodilatation.
- iv. Cyclic GMP is also involved in the rhodopsin cycle. The role of cGMP in the light sensing cells of retina and its interaction with the G-protein transducin is described under visual cycle, Chapter 36.
- v. NO (Nitric oxide) is the major activator of guanylate cyclase. NO in turn is produced by the action of NOS (Nitric oxide synthase) in tissues like vascular endothelial cells (see Chapter 17). NO can easily diffuse through the membrane and activate guanylate cyclase. Increased level of cyclic GMP in smooth



muscle triggers rapid and sustained relaxation of the smooth muscles. The vasodilatation resulting from NO induced increase in cGMP has great physiological and pharmacological significance. The drugs that act via NO release are nitroprusside, nitrites (used in angina as coronary vasodilators) and sildenafil citrate (Viagra). Even though nitroglycerin was used to relieve angina for the last few decades, its role as an exogenous NO donor has been described only recently.

### Hormones with Intracellular Receptors

- i. The hormones in this group include the steroid hormones and thyroid hormones. They diffuse through the plasma membrane and bind to the receptors in the cytoplasm (Fig. 50.8).
- ii. The hormone receptor (HR) complex is formed in the cytoplasm. The complex is then translocated to the nucleus. Steroid hormone receptor proteins have a molecular weight of about 80–100 kD. Each monomer binds to a single steroid molecule at a hydrophobic site, but on binding to genes they dimerize (Fig. 50.7).
- iii. In the nucleus, the HR binds to the **hormone response elements** (HRE) or steroid response elements (SRE) (Table 50.4). The SRE acts as an enhancer element and when stimulated by the hormone, would increase the transcriptional activity (Fig. 50.8). The newly formed mRNA is translated to specific protein, which brings about the metabolic effects. Binding to the SRE sequence leads to dimerization of the receptor. Steroid hormones influence gene expression, so that the rate of transcription is increased. The stability of mRNA is also increased. This would lead to induction of protein synthesis. Steroid receptors have been found to enhance initiation of transcription by formation of complexes at promoters (Fig. 50.7).
- iv. Best examples of the effect of hormones on genes are:
  - a. The induction of synthesis of amino transferases by glucocorticoids.
  - b. Synthesis of calcium binding protein by calcitriol (see Fig. 36.10).

### Insulin Signaling Pathway

Insulin acts by binding to a plasma **membrane receptor** on the target cells. Insulin receptor is described in detail in Chapter 24. It has 2 alpha and 2 beta subunits. Insulin binds with the alpha subunits. This binding

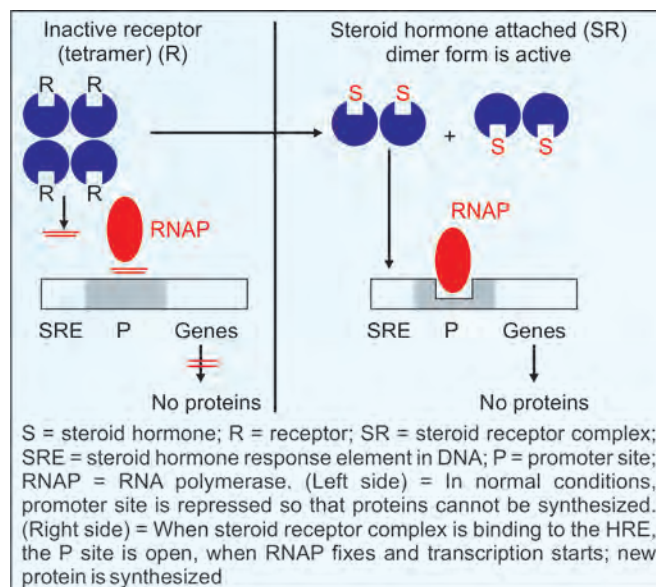


Fig. 50.7: Mechanism of action of steroid hormones

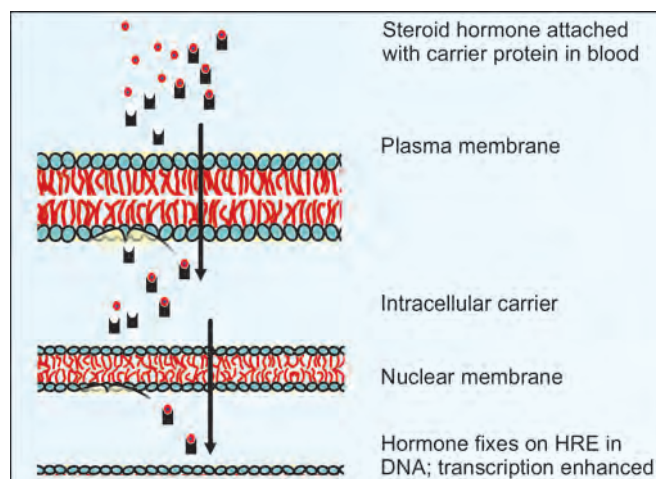


Fig. 50.8: Steroid hormone enters nucleus

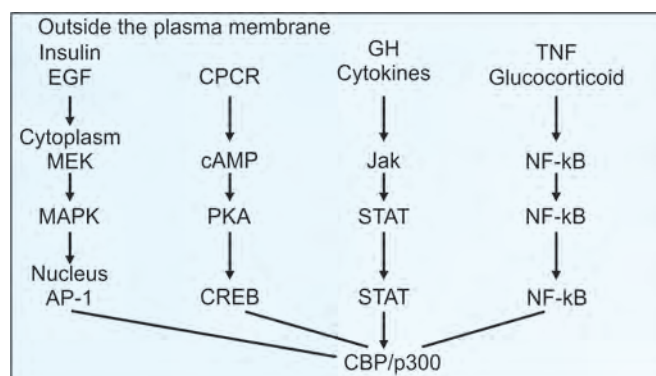


Fig. 50.9: Most of the signaling pathways converge into the final effector molecule, the CBP

activates the tyrosine kinase activity of the beta subunit, leading to autophosphorylation of the beta subunit (see Fig.24.7). This event, in turn, phosphorylates insulin receptor substrates (IRS). There are different IRS molecules, named as IRS 1 to 4.

Activation of IRS2 results in activation of the PI-3 kinase, which eventually activates various protein kinases, PKB, PKC, SGK (serum glucocorticoid regulated kinase), etc. This leads to transcription of specific genes for key enzymes of glycolysis, such as glucokinase. There are more than 100 enzymes influenced by insulin.

An alternate pathway involves activation of IRS1. The message is later transmitted into a series of serine/threonine kinases, such as IRS2 → GRB2 → mSOS → Ras → Raf → MEK → MAPK, etc. which causes cell growth and new DNA synthesis. GRB = growth factor receptor binding protein; mSOS = mammalian son of sevenless; MAPK = mitogen activated protein kinase. IRS is further described in Chapter 60.

A third pathway is IRS3 → mTOR → p70S6K. (mTOR = mammalian target of rapamycin; p70S6K = p70 ribosomal protein S6 kinase). This pathway leads to increased synthesis of glucose transporters, insulin receptors, etc.

### mTOR

Mammalian target of rapamycin (**mTOR**) also known as FK506 binding protein 12-rapamycin associated protein 1 (**FRAP1**) is a protein which in humans is encoded by the FRAP1 gene. The mTOR is a serine/threonine protein kinase that regulates cell growth, cell proliferation, cell motility, cell survival, protein synthesis, and transcription. The mTOR integrates the input from upstream pathways, including insulin, growth factors (such as IGF-1 and IGF-2), and mitogens. It also senses cellular nutrient and energy levels and redox status. The mTOR pathway is dysregulated in certain cancers. Rapamycin is a bacterial product that can inhibit mTOR by associating with its intracellular receptor FKBP12. The FKBP12-rapamycin complex binds directly to the FKBP12-Rapamycin Binding (FRB) domain of mTOR.

### Jak/STAT Pathway

Some hormones (GH, prolactin, erythropoietin, cytokines) when complexed with the receptor, activate cytoplasmic tyrosine kinases, such as Tyk, Jak, etc. (Jak means Janus kinase. Janus is a greek mythological figure with two heads; the name is given because Jak dimerises. The name for the month of January is also derived from this Janus; January faces both the previous and present year). Jak in turn activates STAT (signal transducers and activators of transcription). The phosphorylated STAT dimerizes and translocates into the nucleus, where it binds to a specific DNA element and activates transcription.

### NFκB and Glucocorticoids

NFκB is the abbreviation for nuclear factor kappa-light-chain-enhancer of activated B-cells. It is a protein complex that controls the transcription of DNA. NFκB is found in almost all animal cell types and is involved in cellular responses to stimuli such as stress, cytokines, free radicals, ultraviolet irradiation, oxidized LDL, and bacterial or viral antigens. NFκB plays a key role in regulating the immune response to infection. Conversely, incorrect regulation of NFκB has been linked to cancer,

inflammatory and autoimmune diseases, septic shock, viral infection, and improper immune development. NFκB has also been implicated in processes of synaptic plasticity and memory. Active NFκB turns on the expression of genes that keep the cell proliferating and protect the cell from conditions that would otherwise cause it to die via apoptosis. NFκB is a **transcription factor**. It is a heterodimeric complex; it has two subunits, p50 and p65. Normally NFκB is in cytoplasm, and is complexed with inhibitors, and so is inactive. Stimuli such as cytokines, ROS, mitogens will activate IKK (= IκB kinase), which phosphorylates IκB (=inhibitor of NFκB). Phosphorylated IκB is attached with ubiquitin and is degraded by proteasomes. So, NFκB is now free, which translocates to nucleus. It binds to various gene promoters and activates transcription of proteins involved in inflammatory response. Glucocorticoids are used widely in clinical practice as anti-inflammatory agents. Glucocorticoids increase IκB; the glucocorticoid receptors bind to the p65 subunit of NFκB; in both ways glucocorticoids inhibit the NFκB activity, and so reduce the inflammation.

### Nuclear Receptors

Their middle region contains the **DNA binding domain** (DBD) through which they bind the specific region of DNA, termed hormone response elements (Table 50.3). The receptors also have a **ligand binding domain** (LBD) at the carboxy terminal half. A hinge region separates the DBD and LBD regions. Nuclear receptors were identified for all the hormones listed in Table 50.4.

### CREB binding Protein (CBP/p300)

The CBP binds to CREB and mediates activation in response to cAMP. CRE means, cAMP sensitive regulatory elements. CBP and p300 are closely related proteins. p300 is so named, because it is a protein with molecular weight of 300 kD. Most of the signaling pathways finally converge in the CBP (Fig. 50.9). The final effector, CBP has the histone acetyl transferase activity, by which the DNA region is made available for transcription.

### Related Topics

Insulin and glucagon (see Chapter 24); adrenalin and noradrenalin (see Chapter 18); renin, angiotensin (see Chapter 30); calcitriol (see Chapter 36); parathyroid hormone and calcitonin (see Chapter 39). C-Jun, C-kit, EGFR, ERK, GSK, GCSF, GMCSF, HSP, HGF, HER2/neu, IRS, JNK, MAPKK, MMP, p38, p53, p70S6, Rantes, Rb, STAT, TGF, TNF, VCAM and VEGF are described in Chapter 60.

## Clinical Case Study 50.1

A 25-year-old woman working in a rural school suddenly began to pass profuse watery stools almost continuously. Immediately she started to vomit and her general condition deteriorated. She was rushed to the hospital and on admission, she was cyanotic, skin turgor was poor, BP was 70/50 mm Hg and pulse was rapid and weak. The stool sample was taken for culture and treatment was started immediately. What is the diagnosis? What is the basis of clinical findings?

### Clinical Case Study 50.1 Answer

The patient is suffering from cholera, an acute diarrheal disease that can result in rapidly progressive dehydration and death within a few hours. It is caused by the bacteria, *Vibrio cholerae*. People are infected when they consume contaminated food or water. Patients present with watery diarrhea and vomiting, with no fever. Diagnosis is confirmed by identifying bacteria in stool sample. Treatment includes replacing lost fluids and giving antibiotics.

Certain toxins produced by the bacteria (cholera toxin) leads to activation of the enzyme, adenylyl cyclase, converting cAMP to ATP. The activated protein leads to continuous activation of protein kinase A which opens a chloride channel (CFTR channel) and inhibits Na<sup>+</sup> - H<sup>+</sup> exchanger. The net effect is inhibition of absorptive sodium transport system in intestinal villus cells and activation of secretory chloride channel transport in crypt cells. This leads to accumulation of sodium chloride in lumen; water moves passively to maintain osmolality and watery diarrhea results. Unless replaced, this leads to shock (due to fluid depletion) and acidosis (due to loss of bicarbonate).

The cholera toxin can also enhance intestinal secretion via prostaglandins and neural histamine receptors.

### QUICK LOOK OF CHAPTER 50

1. Definition of a hormone is that is synthesized by one type of cells and transported through blood to act on another type of cells.
2. G-protein is a peripheral membrane protein consisting of alpha, beta and gamma subunits. When GTP is attached, it becomes active. It then activates the enzyme adenylyl cyclase.
3. G-proteins are used for different signal transduction pathways. There are 2 major types of G-proteins; Gs (G-stimulatory) and Gi (G-inhibitory).
4. G-protein activity can be inhibited by GTPase.
5. Examples of hormones that use cyclic AMP as second messenger are ACTH, FSH, LH, PTH, etc.
6. Example of a hormone that use cGMP as second messenger is ANF.
7. Examples of hormones that use calcium or PIP<sub>2</sub> as second messenger are TRH, GnRH, CCK, etc.
8. Examples of hormones whose actions are mediated via a tyrosine kinase mechanism are insulin, EGF, PDGF, NGF, etc.
9. Cholera toxin binds to a ganglioside on intestinal mucosal cell, which leads to ribosylation of the alpha subunit of Gs-protein.  
 Pertussis toxin ribosylates the alpha subunit of Gi-protein and prevents the Gi-GDP complex from interacting with the activated receptor.
10. Diacylglycerol (DAG), the second messenger formed by the hydrolysis of PIP<sub>2</sub> activates protein kinase C which in turn phosphorylates other target proteins.
11. Hormones bind to the specific area of the gene, referred to as the hormone response element (HRE).  
 Eg. Thyroid hormones and steroid hormones.

# CHAPTER 51

## Hypothalamic and Pituitary Hormones

### Chapter at a Glance

The reader will be able to answer questions on the following topics:

- Antidiuretic hormone
- Oxytocin
- Hypothalamic releasing factors
- Growth hormone
- Adrenocorticotrophic hormone
- Thyroid stimulating hormone
- Gonadotropins

The hypothalamus produces two types of endocrine factors; (a) the hypothalamic neuropeptides and (b) the hypothalamic releasing factors. The releasing factors are neurosecretions synthesized in the hypothalamus and released through the hypothalamic pituitary portal circulation. They have their effect on the secretion of pituitary tropic hormones.

### ■ HYPOTHALAMIC NEUROPEPTIDES

The hypothalamic neuropeptides are produced by the supraoptic and paraventricular nuclei of the hypothalamus. These neurohormones are antidiuretic hormone (ADH) and oxytocin. The precursors of ADH and oxytocin are long polypeptides. They are synthesized in hypothalamus. It is cleaved into the active molecule, and then transported to posterior pituitary and stored there. They are released to bloodstream by exocytosis.

### Antidiuretic Hormone

- It is also called vasopressin. The structure is shown in Figure 51.1. If arginine is replaced by lysine, it is called lysine vasopressin (LVP).
- Its main action is to prevent diuresis. So it reduces the urine output. The ADH acts on the distal convoluted tubules of the kidney, producing reabsorption of water (Box 51.1).

- The ADH binds to membrane receptor and activates adenylate cyclase. The cyclic AMP thus produced will activate the protein kinase. This, in turn, phosphorylates proteins of the microtubules and microfilaments. The net effect is the reabsorption of water.

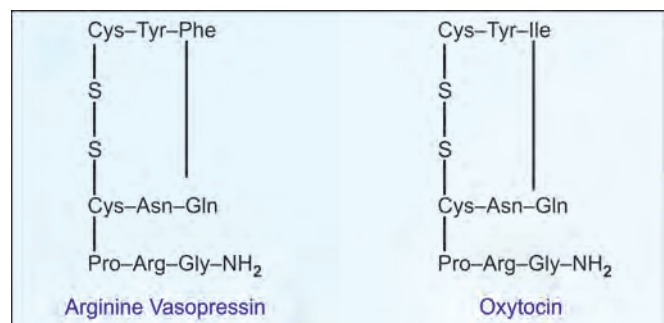


Fig. 51.1: Structure of ADH and oxytocin

### Box 51.1: ADH and aquaporins

Aquaporins are responsible for the reabsorption of water from kidney tubules under the effect of ADH. There are eight different types of isoforms of aquaporins located at different sites along the proximal convoluted tubules, loop of Henle and collecting ducts. Low levels of expression of aquaporins are found in nephrogenic diabetes insipidus. Mutant proteins also result in defective water reabsorption.



- iv. The regulation of ADH secretion is through the osmolality of blood. Lowering of the osmolality (hemodilution) suppresses ADH secretion. Conversely, an increase in osmolality (hemoconcentration or dehydration) leads to stimulation of the secretion of ADH.
- v. Deficiency of ADH results in **diabetes insipidus**. It is characterized by excretion of large volumes of dilute urine. Hyponatremia and hypertonic contraction of extracellular fluid volume are also seen. It is a very rare condition.
- vi. Excess secretion of ADH often results from ectopic production of ADH by malignant tumors elsewhere, referred to as the “**syndrome of inappropriate secretion of ADH**” or SIADH. Here ADH is continuously secreted and is not subjected to any control mechanisms. Generally, there is hypotonic expansion of extracellular volume, but sometimes euvoemia is seen associated with hyponatremia. Slow onset is mostly asymptomatic and goes unnoticed but those with acute onset will manifest the symptomatology of water intoxication (headache, confusion, anorexia, nausea, vomiting, coma and convulsions). Hyponatremia and impaired urinary dilution are seen.

### Oxytocin

The term means “to stimulate birth”. Its structure is shown in Figure 51.1. Oxytocin acts on an estrogen-primed uterus. The synthetic derivative of oxytocin, pitocin, is used to induce labor.

Oxytocin has an effect on the mammary glands. Suckling generates a neurogenic reflex, which stimulates the production of oxytocin. It causes contraction of the myoepithelial cells expelling the milk into milk ducts from the acini.

### Hypothalamic Releasing Factors

Andrew Schally in 1971 isolated TRH. Roger Guillemin isolated LHRH (now termed GnRH) and somatostatin in 1973; both of them were awarded Nobel prize in 1977. The secretion of hormones by adenohypophysis or anterior pituitary is under the control of peptides secreted by hypothalamus. Several peptides having effects on anterior pituitary, either stimulant (releasing factors), or inhibitory, have been identified. Table 51.1 shows a list of these factors. The secretion of the

hypothalamic peptides are also under the feedback control of anterior pituitary tropic hormones (short loop feedback) as well as the target gland hormones (long loop feedback) (Fig. 51.2).

The paraventricular nucleus (PVN), located in the anterior medial area of hypothalamus, is involved in oxytocin and vasopressin release from the pituitary. The arcuate nucleus (ARC) is involved in secretion of various pituitary releasing hormones, the dorso medial hypothalamic nucleus (DMH) is involved in stimulating gastrointestinal activity, and the ventromedial nucleus (VMN) is involved in satiety (sensation of being full). The overall function of the hypothalamus is to link the central nervous system to the endocrine system via the pituitary gland (also termed the hypophysis). Somatostatin is described in Chapter 54.

### HORMONES OF ANTERIOR PITUITARY

The anterior pituitary hormones are tropic in nature, stimulating the secretion of hormones from target organs. Secretions of all these hormones are under the control of hypothalamic releasing or inhibitory factors. Table 51.2 lists them.

#### Growth Hormone

- i. It is also called **somatotropin**. It is a single polypeptide chain with 191 amino acids. Growth hormone (GH) is synthesized by **acidophils** (somatotrophic cells) of anterior pituitary.
- ii. Plasma concentration of GH is less than 2 ng/mL during day time, with secretory peak appearing 3 hours after meals. Maximum level of GH is seen during deep sleep. For measurement of serum GH,



Roger  
Guillemin  
NP 1977  
b. 1924



Andrew  
Schally  
NP 1977  
b. 1926

**TABLE 51.1:** Major hypothalamic releasing factors

Name	Chemical nature	Biological actions
TRH; thyrotropin releasing hormone	Tripeptide; (pyro-Glu-His-Pro-NH <sub>2</sub> )	Induces secretion of TSH and PRL; neuromodulator
GnRH; gonadotropin releasing hormone	Biologically active portion is a decapeptide	Releases LH and FSH; induces spermatogenesis, ovulation and testosterone
GHRH; growth hormone releasing hormone	37–44 amino acid; amino terminal end is tyrosine	Stimulates growth hormone secretion
CRF; corticotropin releasing factor	Amidated peptide with 41 amino acids	Release of ACTH. Inhibited by cortisol
Somatostatin; growth hormone inhibitory factor	Cyclic peptide with 14 amino acids	Inhibits secretion of GH and TSH. Inhibits gut hormones, pancreatic and gastric secretion
PIF; prolactin inhibitory factor	Dopamine	Inhibits PRL release

the samples are collected during sleep and also during waking hours to assess the circadian rhythm.

- iii. The GH secretion is regulated by the balance between GHRH and GHIH (**somatostatin**). The regulation of secretion is predominantly inhibitory. Hypoglycemia stimulates GH secretion, and hyperglycemia suppresses it. The hypothalamic growth hormone releasing hormone (**GHRH**) stimulates GH synthesis and release. **Ghrelin**, a peptide derived from stomach induces GHRH and directly stimulates the release of GH. Somatostatin synthesized in the hypothalamus inhibits the GH secretion.

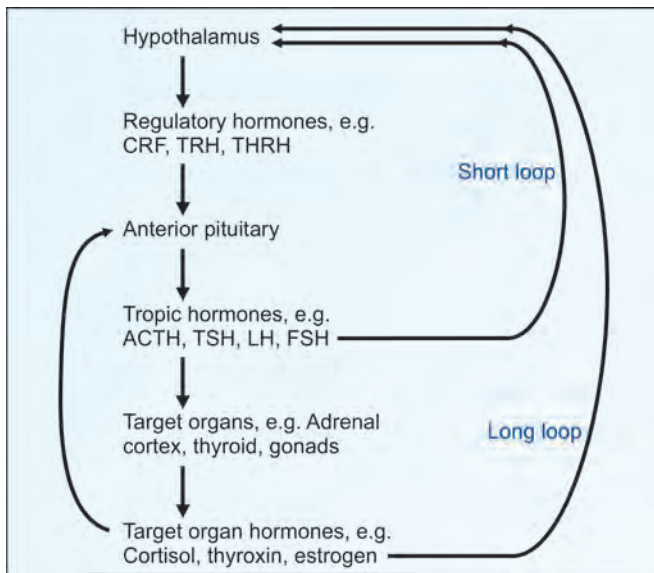


Fig. 51.2: Long and short loops of feedback

TABLE 51.2: Hormones of anterior pituitary

Acronym	Full name	Chemical nature	Mol.wt. in kD	Amino acids
GH	Growth hormone	Polypeptide	22	191
ACTH	Adrenocorticotrophic hormone	Polypeptide	4.5	39
LH	Luteinizing hormone	Glycoprotein; $\alpha, \beta$ chains	29	$\alpha = 89$ $\beta = 115$
FSH	Follicle stimulating	Glycoprotein; $\alpha, \beta$ chains	29	$\alpha = 89$ $\beta = 115$
TSH	Thyroid stimulating hormone	Glycoprotein; $\alpha, \beta$ chains	28	$\alpha = 96$ $\beta = 115$
MSH	Melanocyte stimulating hormone	Polypeptide	13	$\alpha = 13$ $\beta = 18$ $\gamma = 12$
PRL	Prolactin b Endorphins	Polypeptide Polypeptides	22 4	198 31
LPH	Lipotrophic hormone	Polypeptide	11	$\beta = 91$ $\gamma = 60$

- iv. The metabolic effect of GH is partly mediated by **somatomedin**, also known as insulin-like growth factor-1 (IGF-1). The growth of long bones is stimulated by this factor. IGF-1, the peripheral target hormone of GH exerts feed back inhibition.
- v. GH increases the uptake of amino acids by cells; enhances protein synthesis, and produces positive nitrogen balance. The anti-insulin effect of GH causes lipolysis and hyperglycemia. The overall effect of GH is to stimulate growth of soft tissues, cartilage and bone. It is anabolic. Growth hormone is lipolytic, inducing the breakdown of tissue lipids and thus providing energy supplies.
- vi. Excess secretion by GH secreting tumor, leads to **gigantism** in children and **acromegaly** in adults.
- vii. Deficiency of GH secretion in early childhood results in pituitary dwarfism. **Dwarfism** may also result from congenital deficiency of GH due to end organ resistance. It is treated by giving GH produced by recombinant technology.
- viii. Inhibition of GH secretion by hyperglycemia (GTT) and stimulation by hypoglycemia (insulin infusion) are used to check the status of GH secretion in hyper as well as hypopituitarism.

### Adrenocorticotrophic Hormone

- i. It is secreted as a large precursor molecule, known as pro-opiomelanocortin (POMC), with a molecular weight of 32 kD. It is cleaved to give about 30 different endorphins and several hormones. The major products are shown in Figure 51.3. The active adrenocorticotrophic hormone (ACTH) is a polypeptide with 39 amino acids.
- ii. The secretion of POMC is under the control of CRF. ACTH is released from the pituitary in a pulsatile manner, with a definite diurnal rhythm, the secretion being highest in the early morning, and minimum at midnight. This pattern of secretion is reflected in cortisol also. Factors that increase ACTH secretion include stresses such as pain, cold exposure, acute hypoglycemia, trauma, depression, and surgery.
- iii. ACTH binds to specific receptors on the adrenal gland, then activates adenylate cyclase and so, cAMP level is raised. ACTH induces adrenocortical steroidogenesis through the melanocortin-2 receptor. Steroid hormones in turn cause feed back inhibition of HPA (hypothalamopituitary adrenal axis).
- iv. ACTH secreting tumors of pituitary will cause Cushing's disease. Deficiency of ACTH secretion may occur as a part of panhypopituitarism.

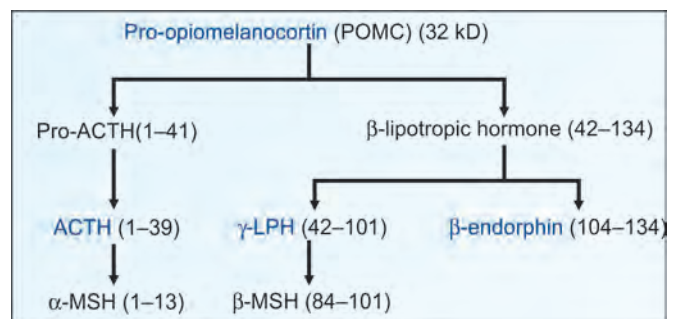


Fig. 51.3: Cleavage of pro-opiomelanocortin (POMC). The numbers denote the amino acid sequence

- v. **Cosyntropin stimulation (Rapid ACTH) test:** With rapid administration of ACTH, blood cortisol level will be raised. If there is adrenal insufficiency, adrenal gland cannot be stimulated by the administered ACTH and subnormal or low response of cortisol occurs.
- vi. **Dexamethasone suppression test:** Dexamethasone, an analog of cortisol suppresses ACTH hormone and cortisol production in normal subjects; but not in patients with Cushing's syndrome.

## Endorphins

Small peptides formed from POMC have endogenous morphine-like or opiate-like activity. They are responsible for increasing the threshold of pain, especially under conditions of stress. Morphine binds to the receptors for endorphins, by which morphine induces the pain relief.

## Glycoprotein Hormones

TSH, FSH and LH are the glycoprotein hormones of pituitary. All the three are made up of two subunits. The alpha unit is common to all the three, while the beta subunit is specific for each of them.

The alpha unit is also common to human chorionic gonadotropin (HCG); so beta HCG is estimated as an index of pregnancy. Beta HCG is a tumor marker for choriocarcinoma (see Chapter 57).

## Thyroid Stimulating Hormone (Thyrotropin)

- i. The thyroid stimulating hormone (TSH) increases the secretion of thyroid hormones by stimulating all the steps of production of synthesis of thyroxine (see Chapter 53). It acts through cAMP by binding with a receptor on thyroid cell surface.
- ii. The TSH secretion is stimulated by TRH. The TRH also stimulates prolactin secretion. Whereas, the prolactin inhibitory factor (PIF) inhibits secretion of TSH to some extent. The TSH secretion is also controlled by the level of thyroid hormones.
- iii. High levels of TSH may occur due to primary hypothyroidism and lack of feedback control. Normal TSH level is 0.5–5 microunits per mL. Deficiency may occur as a part of hypopituitarism.
- iv. **Increased** serum TSH levels are seen in primary hypothyroidism (3–100 times normal), Hashimoto's thyroiditis, ectopic TSH secretion by tumors (lung, breast), and in thyroid hormone resistance. The TSH is elevated in euthyroid patients during treatment of hyperthyroidism but TSH is low for 4–6 weeks after achieving euthyroid state in treated hyperthyroid patients.
- v. **Decreased** levels are observed in primary hyperthyroidism, secondary hypothyroidism (pituitary origin), tertiary hypothyroidism (hypothalamic), subclinical hyperthyroidism (e.g. toxic multinodular goiter, exogenous thyroid hormone administration, autonomous thyroid hormone secretion) and in euthyroid sick syndrome.

## Gonadotropins

- i. They are LH (Luteinizing hormone) and FSH (Follicle stimulating hormone) from pituitary. The placenta also produces human chorionic gonadotropin (hCG). FSH and LH are secreted under the effect of gonadotropin releasing hormone (GnRH). Puberty

does not set in until the pulsatile secretion of LHRH is started by hypothalamus. The fundamental change during puberty is a reduction in hypothalamic inhibition of LHRH release.

- ii. The FSH stimulates growth of ovarian follicles in females and spermatogenesis (Sertoli cells) in males.
- iii. Testosterone in males (secreted by Leydig interstitial cells) and progesterone in females (secreted by corpus luteum), are increased under the influence of LH.
- iv. The FSH secretion rises during the follicular phase of the menstrual cycle, reaches a peak by the 14th day and starts falling when ovulation occurs. Ovulation occurs as a result of positive feedback effect of estrogen producing the preovulatory LH surge. The level of FSH and LH falls during the postovulatory phase, unless fertilization and implantation occur.
- v. The gonadotropin production is under the feedback control by the sex hormones. High levels of FSH and LH are seen in postmenopausal women due to lack of this feedback. Abnormalities in gonadotropin secretion are listed in Table 51.3.
- vi. The FSH is a hormone found in humans and other animals. It is synthesized and secreted by gonadotrophes of the anterior pituitary gland. FSH regulates the development, growth, pubertal maturation, and reproductive processes of the body. The FSH levels are normally low during childhood and, in females, high after menopause. High FSH levels are an indication of subfertility and/or infertility. Diminished secretion of FSH can result in hypogonadism. This condition is typically manifested in males as failure in production of normal numbers of sperm. In females, cessation of reproductive cycles is commonly observed.
- vii. Serum level of FSH is **raised** in primary gonadal failure, ovarian or testicular agenesis, castration, Klinefelter's syndrome, alcoholism, menopause, orchitis and gonadotropin secreting pituitary tumors. Serum level of FSH is **decreased** in anterior pituitary hypofunction, hypothalamic disorders, pregnancy, anorexia nervosa, polycystic ovary disease, hemochromatosis, sickle cell anemia, and in hyperprolactinemia. In hypogonadism, if the levels of FSH and LH are lower than normal for the patient's age, it suggests hypothalamic or pituitary disease and if more than normal, indicates gonadal problem.
- viii. Serum level of LH is **raised** in primary gonadal dysfunction, polycystic ovary syndrome, postmenopausal women and in pituitary adenoma. Serum level of LH is **decreased** in pituitary hypothalamic impairment, Kallmann's syndrome (isolated gonadotropin deficiency associated with anosmia or hyposmia), anorexia nervosa and severe illness.

**TABLE 51.3:** Abnormalities of gonadotropin

	Male	Female
Prepubertal deficiency	Failure to attain puberty. No secondary sexual characteristics	Failure to attain menarche
Postpubertal deficiency	Infertility, loss of libido, impotence testicular failure	Infertility, amenorrhea, ovarian failure
Excessive secretion	Precocious puberty	Precocious puberty

### Human Chorionic Gonadotropin

It is produced only during pregnancy. The human chorionic gonadotropin (hCG) binds to the receptor, LHCGR, in the luteal cells of the ovary. Initially the developing embryo synthesizes and secretes hCG. Following implantation of the embryo, the cells of the placenta secrete hCG. Its appearance in the plasma and urine is one of the earliest signals of pregnancy and the basis of many pregnancy tests. The role of hCG during pregnancy is to prevent disintegration of the corpus luteum so as to maintain the synthesis of progesterone by this tissue.

### Prolactin (Somatomammotropin)

Prolactin (PRL) secreted by lactotropic cells of adenohypophysis is under the control of hypothalamus. Lactotroph hyperplasia is induced by estrogen (during last two trimesters of pregnancy). Its secretion is primarily controlled by inhibitory effect of dopamine and GABA. Its release is stimulated by TRH and vasoactive intestinal peptide. It controls the initiation and maintenance of lactation. The PRL secretion is pulsatile; highest levels during rapid eye movement sleep and peak serum level occurs between 04:00–06:00 hours. Prolactin stimulates lactation on estrogen primed breast. It increases synthesis of milk protein and fat. Hyperprolactinemia is a cause of infertility in females. Secretion of PRL is stimulated by TRH and inhibited by PIF.

**Prolactin stimulation test by chlorpromazine:** Chlorpromazine increases PRL secretion by competitive inhibition of dopamine receptors in the hypothalamus and pituitary in normal individuals.

**Prolactin suppression test by L-dopa:** Failure to respond to L-dopa indicates autonomous function of pituitary prolactin secreting cells.

### Human Placental Lactogen

The amino acid composition of human placental lactogen (hPL) is similar to human growth hormone. At its height the hormone is secreted at a rate of about 1 g/day, the highest secretory rate of any known human hormone. However, little hPL reaches the fetal circulation. The amount

of hPL that is secreted is proportional to the size of the placenta. Low levels of hPL during pregnancy are a sign of placental insufficiency. The biological actions of hPL are similar to those of growth hormone.

### Clinical Case Study 51.1

A 40-year-old male complains that his face has coarse features. On examination, his height was above normal. He has large nose, large tongue, and frontal bossing of his forehead. His hands are enlarged with soft tissue swelling, and his heel pad is thickened. What is the most likely diagnosis? What is the biochemical mechanism of this disorder?

### Clinical Case Study 51.1 Answer

**Diagnosis:** Acromegaly.

**Biochemical mechanism:** Acromegaly is a disorder with excessive growth hormone (GH), usually due to a nonmalignant anterior pituitary tumor. When increased GH occurs prior to bone growth plate closure, gigantism may result; after the bone growth plates close, the patients usually develop coarse features and large hands and feet. In normal persons, an oral glucose load (75 g) will cause decreased GH secretion within 1–2 hours. The diagnosis is confirmed by demonstrating the failure of GH suppression by glucose. Increased GH will cause diabetes mellitus and hypertension. In 30% cases, cardiac arrhythmias, cardiomyopathy and left ventricular hypertrophy, etc. may be seen. The primary therapy is surgical removal of the tumor. Further, somatostatin analogs or dopamine agonists are used.



# CHAPTER 52

## Steroid Hormones

### Chapter at a Glance

The reader will be able to answer questions on the following topics:

- Synthesis of steroid hormones
- 17-ketosteroids
- Biological effects of glucocorticoids
- Assessment of glucocorticoid secretion
- Adrenal hyper and hypofunction
- Ovarian hormones
- Testicular hormones

### ADRENAL CORTICAL HORMONES

The adrenal cortex has three different zones each responsible for production of different classes of steroid hormones (C21, C19 and C18). The smallest and outermost zona glomerulosa produces the C21 steroids, mineralocorticoids. They have effects on water and electrolyte balance. The middle zone of the adrenal cortex, the zona fascicularis produces the glucocorticoids mainly; and adrenal androgens and estrogens to a lesser extent. The innermost zona reticularis produces the androgens (C19) and estrogens (C18). Cortisone was isolated by Tadeus Reichstein; the structure was identified by Edward Kendall, while Philip Hench in 1948 showed its efficacy in rheumatoid arthritis. All the three were awarded Nobel prize in 1950.

### Synthesis of Steroid Hormones

- Cholesterol is first acted upon by **desmolase** and a 6-carbon unit is cleaved off, forming the 21 carbon steroid, **pregnenolone** (Fig. 52.1). It is a common precursor for all the steroid hormones. Adrenocorticotrophic hormone (ACTH) stimulates this step. This is the **rate limiting** step for synthesis of all steroid hormones.
- Progesterone** is the first steroid hormone formed from pregnenolone in two steps. The beta hydroxyl group is converted to a keto group by a 3-beta-ol-dehydrogenase and the  $\Delta^5$  double bond shifted to  $\Delta^4$  (Fig. 52.2).

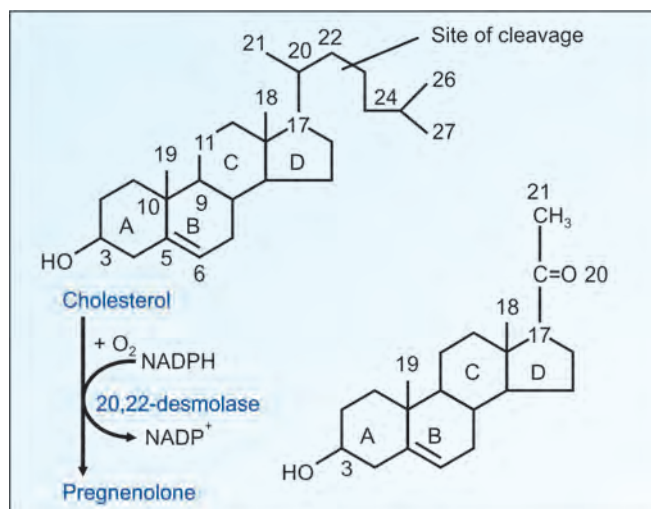


Fig. 52.1: Synthesis of pregnenolone



Tadeus Reichstein  
NP 1950  
1897–1996

Edward C. Kendall  
NP 1950  
1886–1972

Philip S. Hench  
NP 1950  
1896–1965

Adolf F.J. Butenandt  
NP 1939  
1903–1995

- iii. Progesterone is further converted into glucocorticoids (Fig. 52.2), mineralocorticoids (Fig. 52.3) and sex steroids (Fig. 52.4).
- iv. The major adrenal glucocorticoids are cortisol, cortisone and corticosterone in that order. The major mineralocorticoid is aldosterone, but 11-deoxycorticosterone and corticosterone also have significant mineralocorticoid activity.
- v. These reactions are effected by hydroxylation. These specific hydroxylases are mono-oxygenases. All these enzymes are NADPH dependent. These hydroxylation reactions are summarized in Figure 52.5.
- vi. The ACTH stimulates the synthesis of all steroid hormones by activating desmolase so that the availability of pregnenolone is increased.

### Secretion of Adrenal Hormones

- i. Secretion of all adrenocortical hormones is under the control of ACTH.

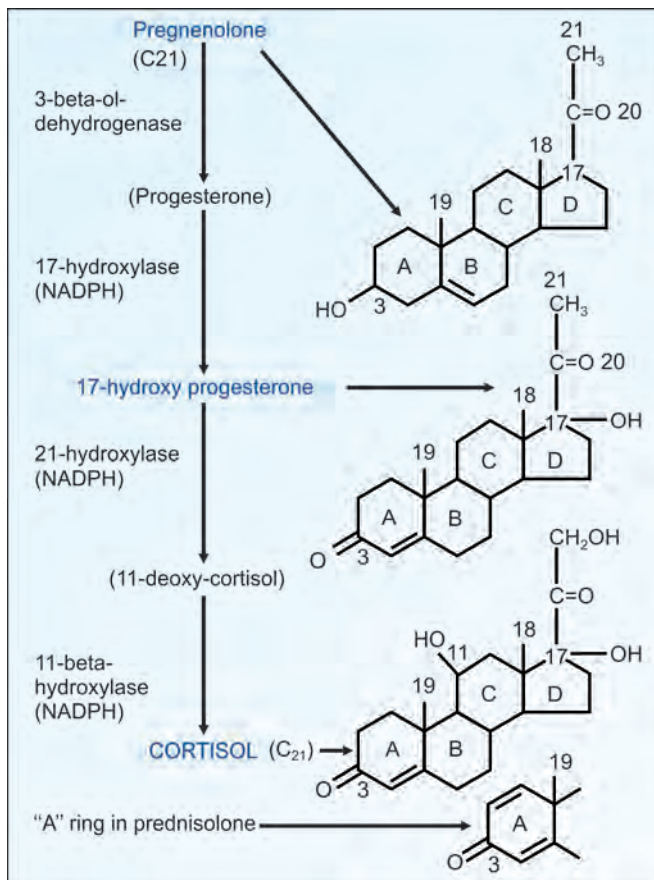


Fig. 52.2: Cortisol synthesis

- ii. The diurnal variation of secretion of cortisol (highest values early in the morning and minimum at night) parallels the pulsatile release of ACTH from anterior pituitary under the influence of CRF.
- iii. Cortisol exerts the negative feedback effect on ACTH secretion.
- iv. The ACTH also increases the secretion of aldosterone.
- v. The level of aldosterone is also affected by position, highest values in upright posture and lowest while lying down.
- vi. All steroid hormones act through intracellular messengers and increase the rate of transcription.

### Transport and Metabolism

- i. Approximately 70% of cortisol in blood is bound to an alpha-1-globulin called **cortisol binding globulin (CBG)** or transcortin.
- ii. About 20% is bound to albumin and the rest is free, which is the biologically active fraction. The half-life of cortisol is about 2 hours.

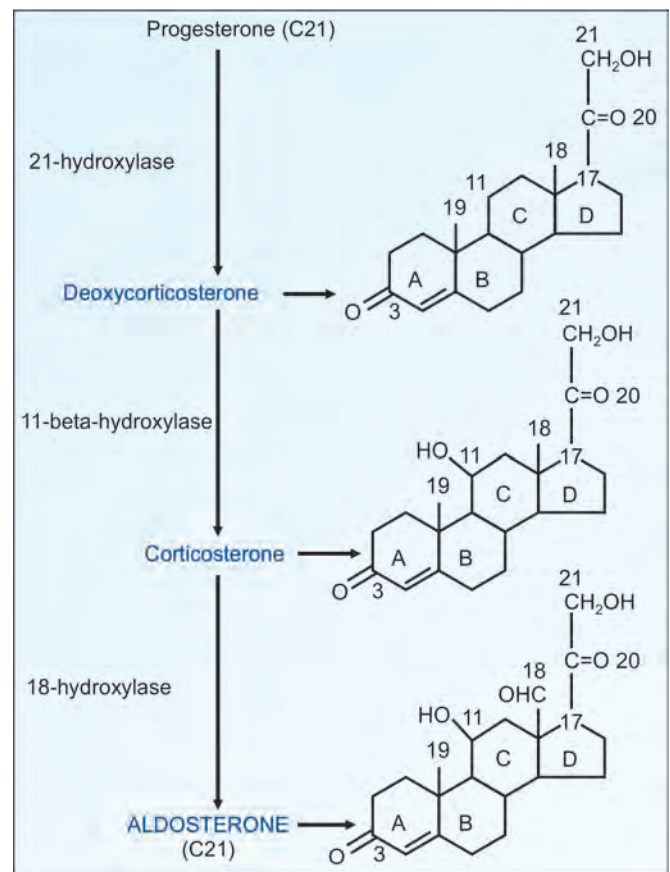


Fig. 52.3: Synthesis of mineralocorticoids

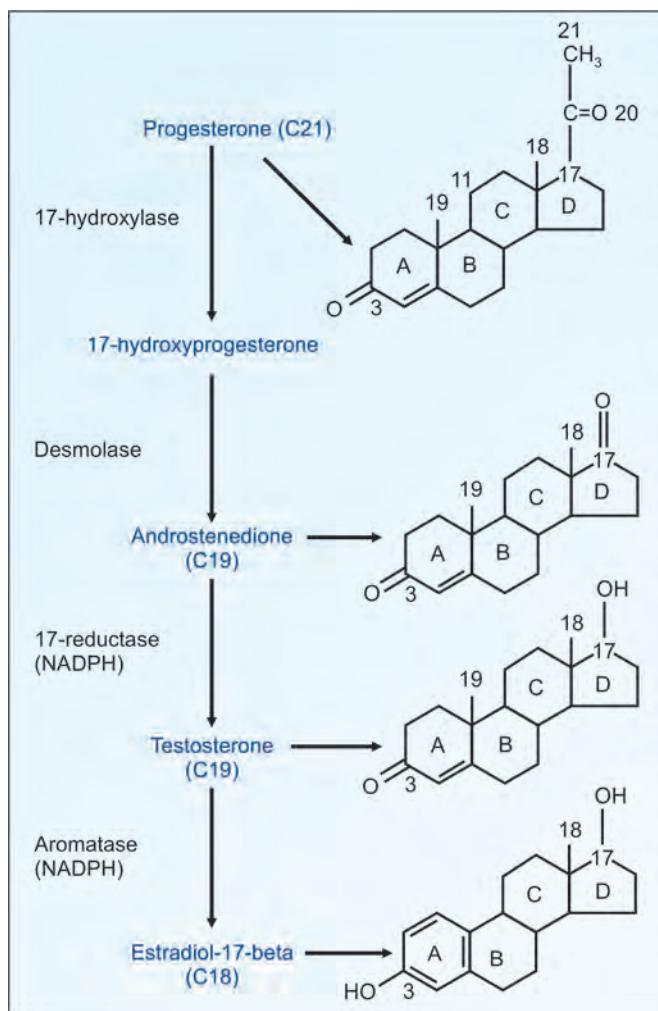


Fig. 52.4: Synthesis of sex hormones

- iii. The steroid hormones are metabolized and inactivated by the liver. The major processes are reduction and conjugation.
- iv. The C<sub>21</sub> steroids are reduced to their tetrahydro derivatives, which are excreted as their glucuronides or sulfates in urine.

### Urinary Steroids

- i. The urinary steroids are referred to as 17-ketosteroids and 17-hydroxy steroids (see structure in Figure 52.6).
- ii. The 17-ketosteroids may be derived from both adrenal steroids and androgens from the gonads. However, the 11-oxygenation index is a measure of adrenal steroid production since 11-hydroxylation occurs only in adrenal cortex.
- iii. **Zimmerman reaction** is used to estimate the 17-ketosteroids. The 17-keto group reacts with meta dinitrobenzene to produce purple color.

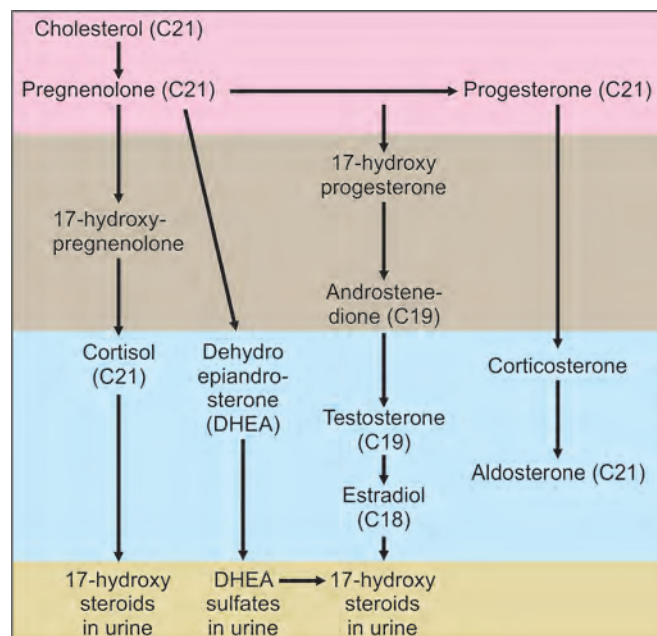


Fig. 52.5: Summary of major pathways for production of glucocorticoids, mineralocorticoids and sex steroids. Precursors in red box; intermediaries in gray box; hormones in blue box; excretory products in brown box

- iv. The **17-hydroxy steroids** are directly derived from the adrenal steroids (glucocorticoids and mineralocorticoids). It is measured by **Porter-Silber reaction**.
- v. The term **17-ketogenic steroids** is used to include all the compounds having a keto or hydroxyl group at 17th carbon.

### Biological Effects of Glucocorticoids

The glucocorticoids, as the name suggests, mainly affect metabolism of glucose. The major biological effects of glucocorticoids are given in Table 52.1.

### Biological Effects of Mineralocorticoids

Mineralocorticoids (mainly aldosterone) increases sodium reabsorption from renal tubules, leading to sodium retention and resultant water

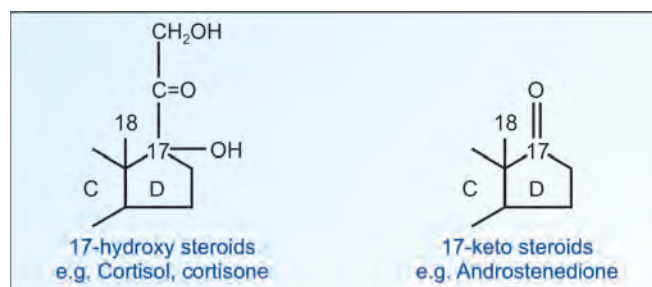


Fig. 52.6: Structural difference between 17-hydroxy and 17-keto-steroids (Only the D ring of structure is shown)

**TABLE 52.1:** Effects of glucocorticoids

System	Effect
Carbohydrates	Activity of transaminases and gluconeogenic enzymes (PC, PEPCK, F-1,6-BPase and GPase) are stimulated, increasing gluconeogenesis. Glycolytic enzymes (GK, PFK and PK) are suppressed. Decreased glucose uptake by peripheral tissues. All these lead to hyperglycemia
Lipids	Increase lipid mobilization; facilitate lipolytic hormones leading to increase in free fatty acids
Proteins and nucleic acids	Catabolism of proteins and nucleic acids increased. Increased urea production
Fluid and electrolytes	Promotes water excretion by increase in GFR and inhibition of ADH secretion
Bone and calcium	Decrease serum calcium by inhibiting osteoblast function, leading to osteoporosis
Secretory action	Stimulates secretion of gastric acid and enzyme. Induces acid peptic disease
Connective tissue	Impaired collagen formation. Poor wound healing
Immune system	Immunosuppressant. Lysis of lymphocytes. Anti-inflammatory and antiallergic

retention, acting through RAS (see Chapter 30). The sodium potassium exchange at the renal tubules lead to increased potassium excretion.

## Mechanism of Action of Steroid Hormones

Steroid hormones in general have nuclear receptors and act by regulation of gene expression. Steroid hormones being lipid soluble can easily pass through plasma membrane and enter the cytoplasm. Here they combine with specific receptors (see Fig. 50.8) and the HR complex translocates to the nucleus. The steroid hormone response elements on DNA (specific sequences bind specific hormones) and regulate transcription of genes. The proteins produced in response to the hormonal stimulation produce metabolic effects, e.g. enzymes and transporters.

## Assessment of Glucocorticoid Secretion

### Basal Level of Cortisol

The plasma cortisol level is determined by radioimmunoassay (RIA), enzyme-linked immunosorbent assay (ELISA) or chemiluminiscent immunoassay (CLIA). The normal range is 5–25 µg/dL at 9 am and 2–5 µg/dL at 10 pm. A loss of diurnal rhythm may be an early indication of disease.

### Estimation of Urinary Free Cortisol

The free cortisol in plasma is the biologically active fraction. A definite fraction of the unbound cortisol is excreted in urine unchanged. Estimation of this fraction is a sensitive index of adrenal activity. High levels are seen in hyperfunction and low levels in hypoactivity.

### Plasma ACTH

Suppressed ACTH levels are seen in hyperadrenalism and high ACTH levels in hypoadrenalism as well as in *Cushing's disease*: In hyperadrenalism due to ectopic ACTH secretion, ACTH levels are elevated.

### Dexamethasone Suppression Test

Dexamethasone produces a fall in cortisol secretion due to feedback suppression of ACTH. In normal people, the overnight suppression with low dose (2 mg) causes a 50% fall in the original value. But this dose may fail to produce suppression in cases of adrenal hyperactivity.

### Urinary Steroids

Estimation of 17-ketogenic steroids is indicated only in AG syndrome. Since the 24-hour excretion is measured, the diurnal variation is also taken care of. Estimation of 17 ketosteroids in urine is often very useful in observing the response of patients to suppression and simulation tests as well as to assess the effectiveness of replacement therapy.

### Stimulation Test

Infusion of synthetic ACTH (Synacthen or tetracosactrin) is given. In the absence of reserve, stimulation tests fail to evoke any response.

### Metyrapone Test

Metyrapone inhibits the 11-hydroxylase enzyme. Hence, alternate androgenic pathways are enhanced and urinary excretion of 17-ketosteroids increase. When it is given, cortisol is not formed. Then there is no feedback inhibitory effect. Hence, alternate pathways of sex steroids are more operative and the urinary excretion of 17-ketosteroids tends to elevate.

### CRH Test

The test is of importance in establishing the cause of adrenal hyperfunction (primary, secondary or tertiary).



## Assessment of Adrenal Androgen Secretion

These tests are done in cases of suspected adrenogenital (AG) syndrome. There is excessive production of adrenal androgens, leading to virilism and hirsutism.

### Adrenal Hyperfunction

Hyperactivity of adrenal cortex may be due to primary defect in adrenal gland itself (**Cushing's syndrome**) or secondarily by excessive production of ACTH from pituitary (**Cushing's disease**) or ectopic ACTH production by other malignant tumors (Table 52.2).

### Adrenal Hypofunction

The most common cause of adrenal hypofunction is primary adrenal insufficiency or **Addison's disease**. It is characterized by tiredness, dehydration, hyponatremia and hyperpigmentation (due to high ACTH levels and its MSH activity). The diagnostic findings are given in Table 52.3.

## Primary Hyperaldosteronism (Conn's Syndrome)

This may result from an aldosterone secreting tumor. The condition may be diagnosed by:

- Elevated plasma aldosterone levels and no change with posture
- Plasma renin activity is decreased due to feedback effect
- Serum electrolytes show hypernatremia and hypokalemia

- Plasma pH is elevated (hypokalemic alkalosis)
- Osmolality is elevated (hypertonic expansion).

### Aldosterone in Blood

Secondary aldosteronism can result from indiscriminate use of diuretics, congestive cardiac failure, following hypovolemia, etc.

**Decreased** levels are seen in Addison's disease, isolated aldosterone deficiency, syndrome of hypoaldosteronism due to renin deficiency, excess deoxycortisone secretion, corticosterone. Drugs decreasing the levels are angiotensin converting enzyme inhibitors (captopril, enalapril, lisinopril, glutethimide, deoxycorticosterone, prolonged heparin therapy, indomethacin, saline and saralasin).

## Adrenogenital Syndrome (AG Syndrome)

There is congenital deficiency of steroid hydroxylases leading to deficient secretion of cortisol. Since cortisol, the major feedback effector is not present, ACTH secretion continues leading to adrenal hyperplasia (CAH). Depending on the enzyme defect the manifestations also vary (Table 52.4).

**21-Hydroxylase deficiency:** It is the most common type, where the production of cortisol is totally absent. The lack of feedback leads to increased androgen synthesis. This would result in virilization of female children who develop ambiguous genitalia. Precocious puberty is seen in male children. Early diagnosis and supplementation of cortisol is effective in children.

**11-Hydroxylase deficiency:** In this condition, the symptoms are more serious. The hypertensive variety of the AG syndrome manifests and the child may not survive. A differential diagnosis of AG syndrome is given in Table 52.4.

**TABLE 52.2:** Findings in adrenal hyperfunctions

Cause	Plasma cortisol	Urinary free cortisol	Plasma ACTH	Dexamethasone suppression
Adrenal adenoma	Increased; diurnal rhythm is lost	Increased	Decreased	No suppression with low dose
Adrenal carcinoma	Increased; diurnal rhythm is lost	Increased	Decreased	No suppression even with high dose
Pituitary adenoma	Increased; no diurnal rhythm	Increased	Increased	Suppression with high dose
Ectopic ACTH production	Increased; no diurnal rhythm	Increased	Increased	No suppression

**TABLE 52.3:** Laboratory findings in adrenal hypofunction

Cause of adrenal insufficiency	Plasma cortisol	Urinary free cortisol	Plasma ACTH	ACTH stimulation	CRH stimulation	Na <sup>+</sup> and K <sup>+</sup> in blood
Primary	Low	Low	Elevated	No effect	No effect	Na <sup>+</sup> ↓; K <sup>+</sup> ↑
Secondary	Low	Low	Low	Normal/exaggerated	No effect	Na <sup>+</sup> ↓; K <sup>+</sup> ↑
Tertiary	Low	Low	Low	Normal/exaggerated	Exaggerated	Na <sup>+</sup> ↓; K <sup>+</sup> ↑

**TABLE 52.4:** Laboratory findings in adrenogenital (AG) syndrome and related diseases

	17-hydroxy progesterone	Testosterone	DHEAS	LH	FSH
AG syndrome	↑↑	↑	↑	N or ↑	N or ↓
Simple hirsutism	N	Slight ↑	Slight ↑	N	N
Adrenal tumor	N	N or slight ↑	↑	N or ↓	N or ↓
Ovarian tumor	N	↑↑	N	N or ↓	N or ↓

DHEAS = dehydroepiandrosterone sulfate; N = normal, ↑ = increase; ↓ = decrease

**TABLE 52.5:** Summary of steroid hormones

Hormone	Tissue of origin	Function
Estrogen (Estradiol)	Ovarian	Maturation and function of female secondary sex organs
Estrogens	Placental	Maintenance of pregnancy
Progestins (Progesterone)	Ovarian	Implantation of ovum and maintenance of pregnancy
Progestins	Placental	Mimic action of progesterone
Androgens (Testosterone)	Testicular	Maturation and function of male secondary sex organs
Glucocorticoids (Cortisol and corticosterone)	Adrenal cortex	Diverse effects on inflammation and protein synthesis
Mineralocorticoids (Aldosterone)	Adrenal cortex	Maintenance of salt balance

## SEX HORMONES

These are secreted by the gonads in response to pituitary gonadotropins (LH and FSH). Adolf Butenandt isolated estrogen (1929), progesterone (1934) and testosterone (1935), for which he was awarded Nobel prize in 1939.

### Ovarian Hormones

They are C18 estrogens, C19 androgens and C21 progesterone. These are produced by the ovarian follicles. The follicular thecal cells produce C19 androgens. These are converted to C18 estrogens by granulosa cells, by aromatization of ring A and loss of C19 methyl group (Fig. 52.4). **Estradiol** is the most important estrogen. It is converted to estrone by liver. It is further hydroxylated to estriol, which is inactive. Estradiol is bound to plasma SHBG (**sex hormone binding globulin**). Estradiol (E2) is the predominant sex hormone present in females; however, it is present in males, at lower levels, as well. Estradiol has not only a critical impact on reproductive and sexual functioning, but also affects other organs including the bones.

Estradiol enters cells freely and interacts with a cytoplasmic target cell receptor; then, estradiol enters the nucleus of the target cell, and regulates gene transcription. Estradiol binds with equal affinity to both estrogen receptors, ER-alpha, and ER-beta. **Selective estrogen**

**receptor modulators** (SERMs) preferentially act on one of these receptors.

### Regulation of Ovarian Hormones

- FSH** influences follicles to ripen, which produces estrogen. Estrogen level gradually increases in the second week of the menstrual cycle. Estrogen level is maximum 24 hours before the **LH peak**.
- High doses of estrogen can suppress the LH release and, therefore effective as contraceptive.
- Under the influence of estrogen, uterine endometrium proliferates, glands in endometrium are hypertrophied, ducts in mammary gland are proliferated and progesterone receptors are synthesized.
- LH level peaks 16 hours before the ovulation. The surge of LH induces the ovulation. The corpus luteum then starts secreting progesterone.
- Under the influence of progesterone, endometrium enters the secretory phase, and prepares for implantation of the fertilized ovum.
- LH is required for maintenance of corpus luteum. If implantation occurs (day 22–24), the LH function is taken over by the hCG, produced by the cytotrophoblast cells of the early embryo. The hCG can be detected 5–7 days after missing a period.
- If implantation has not occurred, hormone levels are decreased and the secretory glands of the endometrium are denuded. **Clomiphene citrate** competes with estrogen for receptors in hypothalamus, thus removing the feedback inhibition. So GnRH level is increased, with consequent high levels of LH and FSH, which may produce follicular stimulation and ovulation. Clomiphene is therefore used to produce ovulation in infertile females.

Certain breast cancers, especially in perimenopausal women are estrogen-dependent. In such patients, estrogen receptor antagonists (**Tamoxifen**) will block the estrogen receptors, and cancer cells tend to die.

### Testicular Hormones

- i. In humans, **testosterone** is the major male hormone, while in animals, it is androstenedione. Androgen is derived from Greek word, *ander*, meaning male.
- ii. The Leydig cells (interstitial cells), secrete the androgens, under the influence of LH. LH is also called **ICSH** (interstitial cell stimulating hormone). The androgens exert feedback effect on LH secretion, through inhibition of GnRH. Thus, in patients with hypogonadism, LH level is high.
- iii. FSH binds to **Sertoli cells** (basement membrane cells of seminiferous tubules) and promotes the synthesis of **androgen binding protein** (ABP). Thus high concentration of androgen is made available locally at the seminiferous tubules, at the site of spermatogenesis.
- iv. In patients with azoospermia, the FSH level is very high, due to lack of negative feedback.
- v. Androgens stimulate spermatogenesis, produce hypertrophy of prostate, seminal vesicles, muscle, bone and kidney cells. It is anabolic.
- vi. **Dihydrotestosterone** (DHT) is the cause for the benign prostate hypertrophy, that affects more than 75% of men over the age of 60 years.
- vii. The enzyme 5-alpha-reductase is needed to convert testosterone to DHT. **Finasteride** can inhibit 5-alpha-reductase, and hence it is used as a treatment for prostate hypertrophy.
- viii. Prostate cancers are androgen dependent, so androgen ablation is used for treatment of advanced prostate cancer. Androgen receptor (AR) is believed to play critical roles in the development and progression of cancer. Over-expression of proto-oncogenes may be driven by AR.

Action of steroid hormones is summarized in Table 52.5.

### Clinical Case Study 52.1

A 45-year-old man presented with vague symptoms of weakness, fatigue, and extreme lethargy from the past few months. He reports that he developed tanning of skin all over the body and is losing weight in spite of normal appetite. Nausea and abdominal pain were present. He had low BP and fainted on two occasions. On examination, BP was 100/60 mm Hg and pulse was 66/minute. Skin was bronze colored. No other abnormalities were seen. The doctor suspected an endocrine disorder. Laboratory assessment showed low blood and urine cortisol level. What is the probable diagnosis? What further tests are needed to confirm the diagnosis? What is the pathogenic mechanism involved?

### Clinical Case Study 52.2

A 42-year-old woman presented with symptoms of fatigue, weakness, lethargy, decreased concentration and decreased memory over 2 years. She had gained about 18 kg weight over the last 3 months with central distribution of fat and neck obesity. Her physical examination showed Cushingoid appearance with body weight of 100 kg, high BP, palmar erythema and hirsutism. Blood cortisol levels were also very high. Dexamethasone suppression test was consistent with Cushing's disease. What is the defect in Cushing's disease?

### Clinical Case Study 52.3

A female baby with ambiguous genitalia was brought to the pediatrician. The child was referred to an endocrinologist. He suggested some laboratory tests and asked the parents to bring the two elder siblings (boys) to him during the next visit.

- A. What is the most likely cause?
- B. What are the laboratory tests to be done in this case?
- C. Explain the metabolic defect.
- D. What is the possible treatment?
- E. Explain the rationale for examining the elder children.

### Clinical Case Study 52.1 Answer

The probable diagnosis is Addison's disease, also known as chronic adrenal insufficiency or hypocortisolism. Adrenal steroid hormone production (glucocorticoids and mineralocorticoids) is reduced. It may be primary adrenal insufficiency (commonly due to an autoimmune process or due to tuberculosis, adrenoleukodystrophy, bilateral hemorrhage, tumor metastasis, HIV, CMV, amyloidosis, sarcoidosis, genetic defect, etc) or secondary adrenal insufficiency (due to lack of ACTH, cortisol is low and aldosterone will be normal).

Clinical features are chronic worsening fatigue, muscle weakness, loss of appetite, weight loss, nausea, vomiting, diarrhea, postural hypotension, skin changes, irritability, depression, craving for salty food, hypoglycemia (more severe in children) and irregular menstruation in women. Acute adrenal insufficiency or Addisonian crisis may be seen and symptoms are sudden penetrating pain in lower back, abdomen or legs, severe vomiting and diarrhea,

dehydration, low BP and loss of consciousness. These may be precipitated by an illness and may be fatal if untreated.

Laboratory assessment includes urine and blood cortisol, ACTH stimulation test, CRH stimulation test and estimation of serum electrolytes (Na, Cl<sup>-</sup>, HCO<sub>3</sub><sup>-</sup> are reduced and K may be high). During Addisonian crisis, ACTH and cortisol will be low, glucose and Na<sup>+</sup> will also be low and K<sup>+</sup> may be high. Diagnosis may be achieved by ACTH stimulation test once the crisis is treated.

### Clinical Case Study 52.2 Answer

Symptoms are (1) upper body obesity, rounded face, increased fat around neck, thinning arms and legs, typical “moon” face, “buffalo hump” (adipose tissue deposition in interscapular area), “truncal” obesity, (2) thin and fragile skin, purplish skin stretch marks, (3) fatigue, muscle weakness, (4) high BP, (5) hyperglycemia, (6) weak bones, (7) hirsutism in women, (8) increased thirst and urination, and (9) opportunistic bacterial infections.

Diagnostic tests are (1) 24-hour urine free cortisol level—High, (2) Midnight plasma cortisol and late-night salivary cortisol—Midnight suppression does not occur, as is normally seen, (3) Low dose dexamethasone suppression test, (4) Plasma ACTH—Low level, (5) CRH test, (6) CRH stimulation test and (7) High dose dexamethasone suppression test.

### Clinical Case Study 52.3 Answer

Adrenogenital syndrome. See Chapter for details.

### QUICK LOOK OF CHAPTER 52

1. The adrenal cortex has three different zones each responsible for production of different classes of steroid hormones (C21, C19 and C18).
2. Zona glomerulosa produces the C21 steroids, mineralocorticoids.
3. Zona fascicularis produces the glucocorticoids mainly; and adrenal androgens and estrogens to a lesser extent.
4. Zona reticularis produces the androgens (C19) and estrogens (C18).
5. Approximately 70% of cortisol in blood is bound to an alpha-1-globulin called cortisol binding globulin (CBG) or transcortin.
6. Hyperactivity of adrenal cortex may be due to primary defect in adrenal gland itself (Cushing’s syndrome) or secondarily by excessive production of ACTH from pituitary (Cushing’s disease) or ectopic ACTH production by other malignant tumors.
7. Congenital deficiency of steroid hydroxylases leading to deficient secretion of cortisol is the cause for Adrenogenital syndrome.



# CHAPTER 53

## Thyroid Hormones

### Chapter at a Glance

The reader will be able to answer questions on the following topics:

- Synthesis of thyroxine
- Metabolic effect of thyroid hormones
- Assessment of thyroid function
- Hyperthyroidism
- Hypothyroidism

### Iodine Metabolism

- i. Daily requirement of iodine is 150–200 µg/day. Its sources are drinking water, fish, cereals, vegetables and iodinated salt.
- ii. Total body contains 25–30 mg of iodine. All cells do contain iodine; but 80% of the total is stored in the thyroid gland. Iodine level in blood is 5–10 µg/dL.
- iii. In most parts of the world, iodine is a scarce component of the soil. Upper regions of mountains generally contain less iodine. Such areas are called **goitrous belts**, e.g. Himalayan region.
- iv. Commercial source of iodine is seaweeds. The program of iodination of common salt has resulted in increased availability of iodine.
- v. Ingredients in foodstuffs, which prevent utilization of iodine are called **goitrogens**. Goitrogens are seen in cassava, maize, millet, bamboo shoots, sweet potatoes and beans. Cabbage and tapioca contain **thiocyanate**, which inhibits iodine uptake by thyroid. Mustard seed contains **thiourea**, which inhibits iodination of thyroglobulin.
- vi. The only biological role of iodine is in formation of thyroid hormones, thyroxine (T4) and tri-iodo thyronine (T3).

### Synthesis and Secretion of Thyroxine

#### Step 1: Uptake of Iodine

Thyroid gland takes up and concentrates iodine (Step 1 in Fig. 53.1). This step is inhibited by **thiocyanate** and **perchlorate**, which compete for the carrier mechanism. This step is stimulated by TSH. The congenital defect, iodine trapping defect, may be treated by large doses of iodine.

#### Step 2: Oxidation of Iodine

The iodide taken up by the thyroid cell is oxidized to active iodine (Step 2 in Fig. 53.1). The thyroid is the only organ which can perform this oxidation step. This is catalyzed by the enzyme **thyroperoxidase**. The reaction needs hydrogen peroxide, which is produced by an NADPH-dependent reaction (Fig. 53.2). The **NADPH** is generated by the hexose monophosphate shunt pathway. This second step is stimulated by TSH and inhibited by **antithyroid drugs** such as thiourea, thiouracil and methimazole (Fig. 53.3). In patients with an inborn error of iodide oxidation defect, treatment is T4 administration.

#### Step 3: Iodination

Then thyroglobulin (Tgb) is iodinated. **Thyroglobulin** is synthesized by the thyroid follicular cells. It is a large protein

with about 5000 amino acids (660 kD). It contains about 10% carbohydrates. There are 115 tyrosine residues in the Tgb, out of which 35 residues can be iodinated. Iodination of the tyrosine is taking place on the intact Tgb molecule in the follicular space. Thus 3-monoiodotyrosine (MIT) and 3,5-di-iodotyrosine (DIT) are produced (Fig. 53.4).

#### Step 4: Coupling

Some of the tyrosine residues in the thyroglobulin are aligned opposite each other, and are coupled (Step 4, Fig. 53.1). When two DIT molecules couple, one molecule of tetraiodothyronine (T<sub>4</sub>) is formed (Fig. 53.4). Tri-iodothyronine (T<sub>3</sub>) may be formed by de-iodination of outer ring of T<sub>4</sub> by 5'-deiodinase. Under normal conditions, 99% of the hormone produced by the thyroid gland is T<sub>4</sub>. The T<sub>4</sub> residues are now attached to the thyroglobulin molecule. The iodination and coupling are taking place in the borders of the follicular cells. The iodotyrosyl coupling defect, an inborn error, affects this 4th step. Treatment is to give T<sub>4</sub>.

#### Step 5: Storage

The thyroid gland is unique, in that it is the only endocrine gland to store appreciable amounts of the hormone (Step 5 in Fig. 53.1). The thyroglobulin contains about 8 T<sub>4</sub> residues per molecule. It is stored as colloid in the thyroid acini.

#### Step 6: Utilization

When necessity arises, thyroglobulin is taken up from the acinar colloid, into the cell by pinocytosis (Step 6, Fig. 53.1).

#### Step 7: Hydrolysis

The T<sub>4</sub> is liberated by hydrolysis by specific proteases. This activity is markedly enhanced by TSH. This hydrolysis is

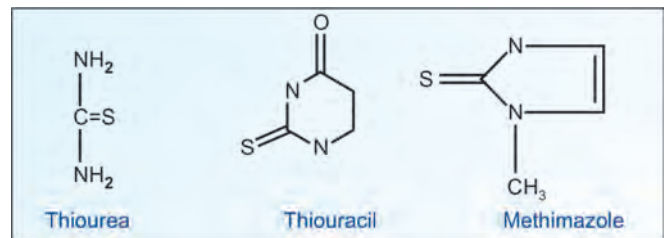


Fig. 53.3: Antithyroid drugs

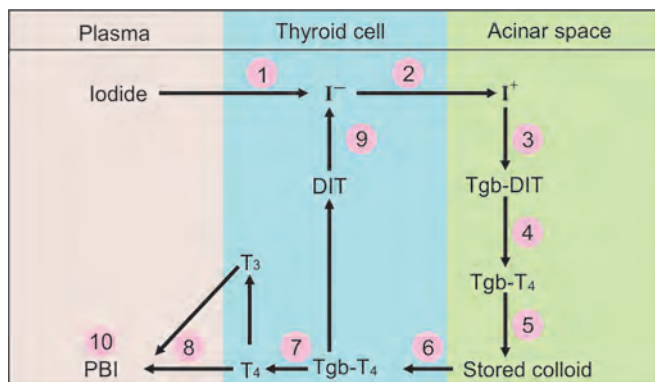


Fig. 53.1: Metabolism of thyroid hormones

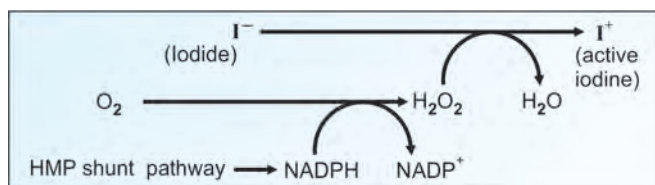


Fig. 53.2: Step 2 of thyroxine synthesis

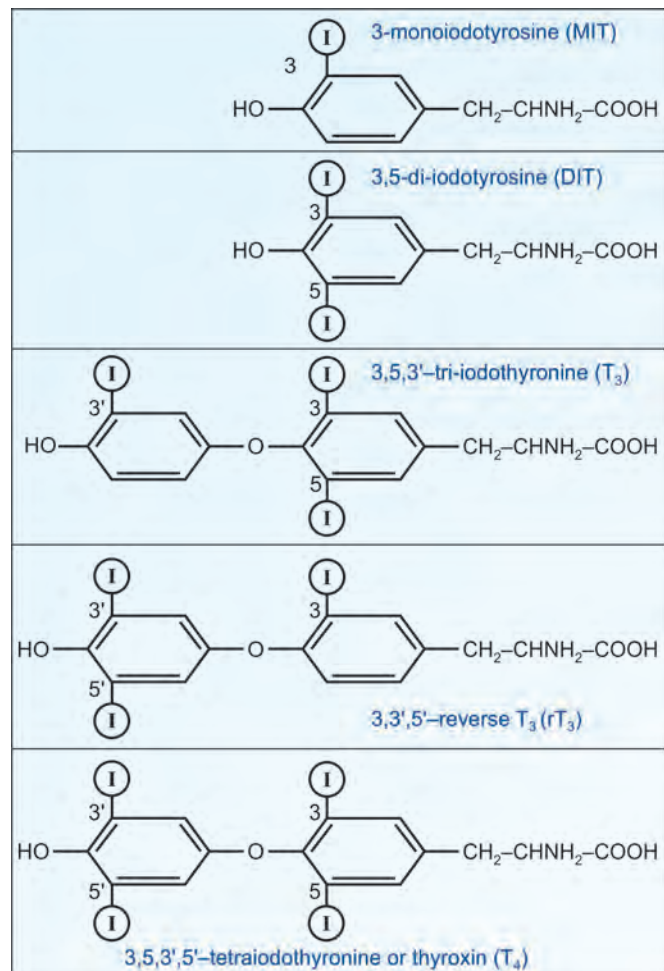


Fig. 53.4: Thyroid hormones and precursors

depressed by **iodide** and therefore potassium iodide (KI) is used as an adjuvant in hyperthyroidism. In a genetic disorder, abnormal Tgb is synthesized, resulting in deficient proteolysis and deficiency of thyroxine.

### Step 8: Release

The T4 thus generated is released into the bloodstream. The T3 is produced by de-iodination at 5' position, either inside the thyroid cell or in the peripheral tissues. Reverse T3 (rT3) is formed by the inner ring de-iodination by 5-deiodinase. Its biological activity is negligible.

### Step 9: Salvaging of Iodine

The MIT and DIT that are not utilized are de-iodinized and salvaged for re-utilization inside the cell itself (Step 9 in Fig. 53.1). Deiodinase defect is the inborn error of metabolism affecting this step. In such cases, DIT and MIT are seen in urine. Since iodine is excreted, iodine deficiency is manifested. Treatment is to give iodine.

### Step 10: Transport of Thyroid Hormones

Thyroid hormones are transported in plasma by proteins (Step 10 in Fig. 53.1). The bound form is biologically inactive, but they can be rapidly released. Total protein bound iodine (PBI) is about 10 µg/dL; out of which T4 constitutes 8 µg/dL. The thyroxine binding globulin (TBG) (54 kD) carries about 80% of T4 and 60% of T3. The rest of thyroid hormones are loosely bound with Transthyretin (TTR) (prealbumin with 55 kD) and albumin (69 kD).

### Step 11: Catabolism of Thyroid Hormones

T4 has a half-life of 4–7 days, while T3 has about 1 day. T3 is biologically more active. T4 is a prohormone which is de-iodinated to T3. In the peripheral tissues, de-iodination takes place. This is done by a de-iodinase, a selenium containing enzyme. Part of the T3 and T4 are conjugated with glucuronic acid and excreted through bile, and to a lesser extent, through urine. Deamination of T4 produces tetraiodothyroacetic acid (Tetrac); and T3 gives rise to tri-iodothyroacetic acid (Triac). These are only one-fourth as active as the parent compound.

## Mechanism of Action of Thyroid Hormone

The hormone attaches to specific nuclear receptors. Then the receptor-hormone complex binds to the DNA. The T3 receptor complex binding sequence in the DNA or the thyroid responsive element (TRE) has been identified

(see Table 50.4). The T3 binding results in increase in transcription rate.

## Metabolic Effects of Thyroid Hormones

- i. The hormone exerts action on every cell of the body. Calorigenic effect or **thermogenesis** is the major effect of thyroid hormone. One milligram of T4 will produce an excess of 1000 kcal. This thermogenic effect is mediated by uncoupling of oxidative phosphorylation.
- ii. Basal metabolic rate (BMR) is increased. Thyroxine increases cellular metabolism.
- iii. Earliest effect of T4 is stimulation of RNA synthesis and consequent increase in protein synthesis. Higher concentration of T3 causes **protein catabolism** and negative nitrogen balance.
- iv. Loss of body weight is a prominent feature of hyperthyroidism.
- v. **Gluconeogenesis** and carbohydrate oxidation are increased. Glucose tolerance test shows rapid absorption.
- vi. Fatty acid metabolism is increased. **Cholesterol** degradation is increased and hence cholesterol level in blood is decreased, which is another hallmark of hyperthyroidism.

## Thyroid Function Tests

### Assay of Hormones

- i. The plasma levels of T4 and T3 levels may be measured by any of the techniques of immunoassay like Radioimmunoassay (RIA), enzyme-linked immunosorbent assay (ELISA), chemiluminescent immunoassay (CLIA) or fluorescent immunoassay (FIA) for the diagnosis of thyroid diseases.
- ii. In hyperthyroidism, thyroid hormone levels are increased. Both T3 and T4 levels are increased, while TSH is reduced due to feedback inhibition.
- iii. In hypothyroidism, T3 and T4 are reduced; but TSH levels are increased due to lack of feedback effect.
- iv. But when hypothyroidism is due to hypothalamic or pituitary defect, then TSH, T3 and T4, all are decreased.

### Free T3 (fT3) and fT4

The free hormones are the really active molecules. Nowadays, very sensitive ELISA techniques are available

to quantitate this free fraction. The values of free hormones are not affected by the amount of carrier proteins in the blood. The free fractions of the hormones are the active forms which can be measured accurately by CLIA or FIA. The free T4 constitutes only 0.03% of the total T4, where as free T3 forms 0.3% of total T3. Variations in binding proteins do not affect the free hormone levels and therefore more reliable in diagnosing true hyper and hypofunction.

## Plasma TSH

In primary hypothyroidism, TSH level is elevated due to lack of feedback. But in secondary hypothyroidism, TSH, T3 and T4 levels are low; this could point to a pituitary or hypothalamic cause. Hyperthyroidism due to primary thyroid disease has high T3 and T4 levels, but suppressed TSH levels. Hyperthyroidism due to pituitary cause is indicated by high TSH, T3 and T4 levels.

### Binding Proteins

Availability of the assay of free hormone has made this test only of historical importance. The abnormalities in the level of binding proteins may be reflected as abnormal hormone levels.

The binding proteins are increased in pregnancy, when estrogen level is high. In malnutrition and nephrotic syndrome, binding proteins are low. Since sensitive and accurate assay techniques are available now for measurement of free T4 and free T3, the fallacies due to alteration of binding proteins do not affect the assessment of the functional status of the gland.

### TRH Response Test

The TRH administration will stimulate the production of TSH. If the hypothalamo-pituitary-thyroid axis is normal, the T3 and T4 secretions will be increased. An abnormal response is observed in:

- Hyperthyroidism:** The negative feedback effect of high T4 overpowers the stimulant effect of TRH. Here the thyroid hormone levels are elevated.
- Hypopituitarism:** The pituitary could not respond to TRH. In these cases the plasma thyroid hormone levels are subnormal.
- An exaggerated response is observed in primary hypothyroidism since the negative feedback effect of T4 is reduced.

### Cholesterol

In hypothyroidism, cholesterol level in blood is increased. It is not diagnostic, because hypercholesterolemia is seen not only in hypothyroidism, but also in diabetes mellitus, hypertension, obstructive jaundice and nephrotic syndrome. However, cholesterol level is a useful index in monitoring the effectiveness of the therapy in thyroid conditions. Cholesterol level is increased in hypothyroidism, because cholesterol carrying lipoprotein degradation is decreased.

### Radioactive Iodine Uptake

Radioactive iodine uptake (RAIU) by thyroid gland and thyroid scanning with Tc<sup>99m</sup> (radioactive technetium) are of diagnostic value (see Chapter 59). These tests are contraindicated in pregnancy and childhood.

### Detection of Thyroid Antibodies

In Grave's disease, the presence of thyroid stimulating immunoglobulin (TSIg), also known as long acting thyroid stimulator (LATS) is seen in circulation. The LATS can bind to TSH receptors on thyroid gland and produce stimulation which is not under feedback control. The TSIg is an antibody generated against the TSH receptor.

The prevalence of autoimmune thyroid disease is on the increase. Therefore, the measurement of antibody levels is of special significance in treatment. The measurement of Anti-TPO antibodies is useful in autoimmune thyroiditis (Hashimoto's thyroiditis). Antithyroglobulin antibodies are measured in thyroid cancer as well.

### Abnormalities of Thyroid Function

In 1835, Robert James Graves and in 1840 Carl Adolph Basedow described hyperthyroidism (Graves-Basedow disease). In 1915, Kendall (Nobel prize, 1950), isolated thyroxine. Emil Kocher was the first surgeon to excise thyroid gland to treat goiter in 1883. For his contributions in thyroid pathology he was awarded Nobel prize in 1909. Diseases of the thyroid are the most common afflictions involving endocrine system. The most common types of thyroid diseases are hyperthyroidism (excess secretion), hypothyroidism (decreased secretion) and goiter (enlargement of thyroid gland). Goiter may or may not be associated with abnormal function, e.g. euthyroid goiter (diffuse enlargement); nodular goiter which may lead to hyperfunction, or iodine deficiency goiter which may result in hypothyroidism.

## Hyperthyroidism

- Hyperthyroidism may be due to:
  - Increase in binding protein
  - Increased affinity of binding protein
  - Effects of autoantibodies
  - TSH secreting tumors and
  - T4 toxicosis (T4 increase; T3 low).



Robert James Graves  
1797–1853



Carl Adolph Basedow  
1799–1854



Emil T Kocher  
NP 1909  
1841–1917



Edward Kendall  
NP 1950  
1886–1972



- ii. Patients have an increased rate of metabolism, weight loss, tachycardia, fine tremors, sweating, diarrhea, emotional disturbances, anxiety and sensitivity to heat.
- iii. Common causes for hyperthyroidism are:
  - a. Toxic goiter
  - b. Graves' disease
  - c. Excess intake of thyroid hormones
  - d. Rarely, TSH secreting tumors of pituitary can lead to hyperthyroidism. Table 53.1 summarizes the laboratory findings in common types of hyperthyroidism.
- iv. **Secondary hyperthyroidism:** It is due to diseases of pituitary or hypothalamus. It is seen in TSH secreting pituitary adenoma, thyroid hormone resistance syndrome, chorionic gonadotropin secreting tumors and in gestational thyrotoxicosis.
- v. **Primary hyperthyroidism:** It is due to diseases of thyroid gland. It is seen in Graves' disease, toxic multinodular goiter, toxic adenoma, functioning metastatic thyroid carcinoma, TSH receptor mutation, Struma ovarii (teratomas of ovary), iodine excess (see Table 53.1).

## Hypothyroidism

- i. **Primary hypothyroidism:** It is due to diseases of thyroid gland. It is seen in autoimmune hypothyroidism (e.g. Hashimoto's thyroiditis), thyroidectomy and radiation therapy. Drugs producing hypothyroidism are lithium, antithyroid drugs and para-aminosalicylic acid. Congenital hypothyroidism is seen in iodine deficiency, absent or ectopic thyroid gland, dysmorphogenesis and in TSH receptor mutation.
- ii. **Secondary hypothyroidism:** It is due to diseases of Pituitary or Hypothalamus. Hypopituitarism is caused by tumors, pituitary surgery or irradiation,

infiltration, Sheehan's syndrome and isolated TSH deficiency. Hypothalamic diseases causing secondary hypothyroidism are tumors, trauma and infiltration. The measurement of TSH level and TRH test will help to differentiate these two different types (Table 53.2).

- iii. Most common cause is primary thyroid disease, often seen in autoimmune thyroiditis, leading to myxedema in adults. Women are more affected than males. Symptoms are lethargy, tolerance to heat, cold intolerance, slow heart rate, weight gain, dry coarse skin, slow responses and sluggishness.
- iv. In children, hypothyroidism produces mental and physical retardation, known as **cretinism**. The TBG may be elevated due to maternal hyperestrogenism and therefore total T4 and T3 may be normal. The lack of feedback will give elevated TSH level also. Prompt diagnosis and treatment are important in cretinism since any delay in starting replacement may lead to irreversible damage. Maternal hypothyroidism may also cause congenital hypothyroidism in the newborn.

Assessment of thyroid function and interpretation of the results should be done only on the basis of history of thyroidal and nonthyroidal illness as well as on clinical picture. Under the current scenario, there is a strong view that those with TSH levels above 2.5 mIU/L should be periodically retested to diagnose symptomatic hypothyroidism at the earliest. The present practice is to perform thyroid screening in all pregnant women and peri- and postmenopausal women.

## Euthyroid Goiter

Iodine deficiency may lead to euthyroid goiter. There is raised TSH level which would produce continued stimulation of gland leading to hyperplasia and goiter. Hormone levels are seen in the lower limits of the normal values.

## Congenital Hypothyroidism

Congenital hypothyroidism is seen in approximately 1 in 4000 newborns. Thyroid hormones are very low or completely absent from birth. Symptoms include puffy face, dullness, thick protruding tongue, which

**TABLE 53.1:** Laboratory findings in hyperthyroidism

	Plasma total T3 and T4	fT4	Plasma TSH	Response to TRH
Grave's disease	Increase	High increase	Decrease	Nil
Toxic goiter	Increase	High increase	Decrease	Nil
T3 toxicosis	T3 increase T4 normal	Increase	Decrease	Sluggish
Excess intake of thyroxin	Increase	Mild increase	Decrease	Sluggish

**TABLE 53.2:** Laboratory findings in hypothyroidism

	T <sub>3</sub> and T <sub>4</sub> in blood	TSH in blood	Response to TRH
Primary hypothyroidism	Decreased	Increased	Exaggerated response
Secondary hypothyroidism	Decreased	Decreased	No response

get worsened with time. Infants may have choking episodes, constipation, dry brittle hair, jaundice, floppiness, sluggishness and sleepiness. Many hospitals routinely screen all newborn for this disease. Treatment consists of oral administration of thyroid hormone, which is simple and cheap. If untreated, child will have mental and growth retardation. Newborn screening helps to totally avoid this condition.

### Nonthyroidal Illness

When thyroid hormones are measured in acutely ill patients, T<sub>3</sub>, T<sub>4</sub> and TSH are found to be lowered. These values are not reliable and referred to as nonthyroidal illness. Therefore it is advisable to defer the assessment of thyroid function in acutely ill patients till they recover completely in order to get a correct picture of the functional status of the thyroid gland.

### Related Topics

Insulin and glucagon (see Chapter 24); adrenaline and noradrenaline (see Chapter 18); renin, angiotensin (see Chapter 30); calcitriol (see Chapter 36); parathyroid hormone and calcitonin (see Chapter 39).

### Clinical Case Study 53.1

A 50-year-old female presents to the clinic complaining of feeling tired all the time. She has cold intolerance and constipation. On examination, she is afebrile and appears in good health. She has an enlarged, nontender swelling on her neck. Her reflexes are diminished, and her skin is dry. What is the most likely diagnosis? What laboratory test would you need to confirm the diagnosis? What is the treatment of choice?

### Clinical Case Study 53.2

A 17-year-old lean female was referred to the endocrinology clinic. She had intermittent palpitations and tremor. On examination, the patient had tachycardia (100 beats/min). She had a small diffuse goiter without retrosternal extension or bruit. Auscultation of the precordium revealed murmurs in systole and diastole consistent with mixed aortic valve disease. An echocardiogram had demonstrated a bicuspid aortic valve with good flow and minor regurgitation.

Biochemically, the patient had TSH <0.03 mIU/L (reference interval, 0.3–5.6 mIU/L) and an increased concentration of free thyroid hormone (fT<sub>4</sub> = 43 pmol/L) (reference interval, 7.5–21.1 pmol/L). Her total calcium (9.08 mg/dL) and phosphate (3.9 mg/dL) were both within their reference intervals. The serum albumin concentration was 4.1 g/dL (reference interval, 3.5–5.0 g/dL), and the magnesium concentration was 0.71 mmol/L (reference interval, 0.74–1.00 mmol/L). Her thyroid peroxidase antibodies was 582 IU/L (reference interval, 0–60 IU/L) and

TSH receptor antibodies was 6.9 U/L (reference interval, 0–1.5U/L). Thyroid imaging revealed a diffusely enlarged thyroid gland, with no visible parathyroid tissue apparent on ultrasound and MRI evaluations. What is the diagnosis? What effect does thyrotoxicosis have on serum calcium? What other endocrine disorders affect serum calcium?

### Clinical Case Study 53.1 Answer

Diagnosis: Hypothyroidism

Laboratory tests: TSH and free T<sub>4</sub>

Treatment: Thyroid hormone replacement. Hypothyroidism is quite common in older adults. It may induce coma or pericardial effusion. The most common etiology is primary hypothyroidism, or failure of the thyroid gland to produce sufficient thyroid hormone. The diagnosis is established by an elevated TSH and decreased T<sub>4</sub>.

### Clinical Case Study 53.2 Answer

Diagnosis: Graves' disease; hyperthyroidism. Graves' disease is an autoimmune process in which circulating immunoglobulins bind to the TSH receptor on the thyroid follicular cells and stimulate thyroid hormone production. The diagnosis is confirmed by increased thyroid stimulating IgG antibodies

## QUICK LOOK OF CHAPTER 53

1. Goitrogens that decrease utilization of iodine are found in food stuffs, e.g. Thiocyanates in cabbages and tapioca, thiourea in mustard seeds. Goitrogens are seen in cassava, maize, millet, bamboo shoots, sweet potatoes and beans.
2. The main hormones secreted by the thyroid gland are tri-iodothyronine (T<sub>3</sub>) and tetraiodothyronine or thyroxine (T<sub>4</sub>).
3. Measurement of T<sub>4</sub> and T<sub>3</sub> levels in blood are done by RIA or ELISA.
4. Cholesterol is increased in blood in hypothyroidism.
5. Graves' disease and Hashimoto's thyroiditis are produced by autoimmune mechanisms.
6. The most common cause of hypothyroidism is primary thyroid disease, often autoimmune in nature, leading to myxedema in adults. Women are more affected than males.
7. In children, hypothyroidism produces mental and physical retardation, known as cretinism.
8. Euthyroid goiter can result from iodine deficiency.

# CHAPTER 54

## Gut Hormones

### Chapter at a Glance

The reader will be able to answer questions on the following topics:

- Signal molecules produced at specific sites
- Peptide hormones regulating digestion
- Peptide hormones regulating appetite
- Adipose tissue derived hormones
- Growth factors

There are more than 30 peptides expressed within the digestive tract, making the gut the largest endocrine organ in the body. These are identified as regulatory peptide hormones, peptide neurotransmitters and growth factors. Several of these peptides were first identified in the central nervous system; and they have subsequently been found in endocrine cells of the gut. Important factors among them are shown in Table 54.1.

### Hormones Regulating Digestion of Food

The gastrointestinal peptide hormones are synthesized and secreted in the gastrointestinal tract. Their action is mainly on gastrointestinal secretions, digestion and absorption of nutrients and food intake. These gut hormones are gastrin group (Gastrin, Cholecystokinin); Secretin like peptides [Secretin, Vasoactive intestinal polypeptide (VIP), Glucagon, GLP-1, GLP-2, Glicentin, GIP]; Pancreatic polypeptide group of hormones (Pancreatic polypeptide, Neuropeptide Y), Gaunynin, Serotonin. These gastrointestinal hormones are secreted by epithelial endocrine cells. Most of them are small peptides. They regulate the rate of secretion and composition of digestive juices. They are derived from a common precursor peptide and shows sequence homology especially at the C terminal fragment.

### Peptide Hormones Regulating Food Intake

The discovery of a group of peptides secreted by the GIT which influences food intake has led to the understanding of the relation between hunger and satiety signals in the genesis of obesity. The major peptides included in this group are Ghrelin, glucose-dependent insulintropic polypeptide (GIP), Somatostatin (SS), Neuropeptide Y and glucagon-like peptide (GLP). These are described in the alphabetical order. The neuroendocrine control of intake of metabolism of nutrients protects a person against starvation and extreme obesity. Upon the entry of nutrients into the small intestine, nutrient sensing mechanisms are activated to allow the body to adapt appropriately to the incoming nutrients. There is an upper intestinal **lipid-induced gut-brain neuronal axis** to regulate energy homeostasis. See also discussion on regulators of appetite, in Chapter 40.

### Adipose Tissue Derived Hormones

These include peptide hormones like Leptin, Adiponectin and Resistin that can regulate the energy intake, storage and metabolism. Initially these were called **adipokines** (mediators of endothelial function and inflammation involved in atherosclerosis), but presently they are more often referred to as adipose tissue derived hormones.

**TABLE 54.1:** Peptide hormones of gastrointestinal tract

Name	Site of Origin	Structure	Function
Bombesin	Stomach, Duodenum	27 amino acid gastrin releasing peptide and 10 amino acid neuromedin	Stimulates release of gastrin and CCK. Negative feedback on eating behavior
Cholecystokinin (CCK)	Cells of duodenum, jejunum	33 amino acids	Stimulates gallbladder contraction and bile flow, increases secretion of digestive enzymes from pancreas
Enkephalins	CNS, stomach, duodenum, gallbladder	Pentapeptides (2 forms, met-enkephalin and Leu-enkephalin)	They bind to opiate receptors, opiate-like actions
Gastrin	Gastric antrum, duodenum	17 amino acids	Stimulates acid and pepsin secretion, also stimulates pancreatic secretions
Ghrelin	Stomach and hypothalamus	28 amino acids; acylated on Ser3 with <i>n</i> -octanoic acid	Increases appetite, stimulates NPY release, energy homeostasis, gastric secretion and emptying, insulin secretion
Glucagon	Alpha cells of pancreas	29 amino acids	Increases lipid mobilization; glycogenolysis
Glucagon-like peptide (GLP-1),	L cells in ileum and colon	Two forms: 31 amino acids, GLP-1 (7-37)	Potentiates glucose-dependent insulin secretion, inhibits glucagon secretion, inhibits gastric emptying
Glucose-dependent insulinotropic polypeptide (GIP)	K cells of duodenum and proximal jejunum	Polypeptide of 42 amino acids	Inhibits secretion of gastric acid, enhances insulin secretion
Insulin	Beta cells of pancreas	A and B chains; 21 + 30 amino acids, total 51 amino acids	Increases glucose uptake and utilization, increases lipogenesis
Motilin	Small intestine	22 amino acids	Increases intestinal motility, stimulates release of PP, stimulates gallbladder contractions
Neuropeptide Tyrosine, NPY	CNS, N cells of ileum, adrenal, pancreas	36 amino acids	Inhibits glucose stimulated insulin secretion; controls feeding behavior and energy homeostasis; inhibits gastric motility and gastric acid secretion. Levels increase during starvation to induce appetite
Obestatin	Stomach	23 amino acids derived from preproghrelin protein	Opposes ghrelin; effect on appetite
Pancreatic polypeptide (PP)	Pancreatic F cells, colon	36 amino acids	Increases glycogenolysis, suppresses glucose-induced insulin secretion, regulation of gastrointestinal motility inhibits pancreatic bicarbonate and protein secretion
Secretin	5 cells of duodenum, jejunum	27 amino acids	Stimulates pancreatic bicarbonate secretion so that gastric HCl is maintained and optimum pH is maintained for the action of pancreatic enzymes. It also inhibits gastric secretion
Somatostatin (SS)	Delta cells of pancreas, gut and hypothalamus	14 amino acids variety by hypothalamus; 28 amino acids by gastrointestinal tract	Inhibits release of numerous gut peptides, e.g. CCK, gastrin, secretin, motilin, GIP; insulin and glucagon
Substance P	Entire gastrointestinal tract	11 amino acids	CNS function in pain (nociception), induces vasodilation. Antagonists have anti-depressant properties
Vasoactive intestinal peptide (VIP)	Pancreas, hypothalamus	28 amino acids	Relaxes smooth muscles of GI, stimulates pancreatic bicarbonate; inhibits acid and pepsin secretion; neurotransmitter in peripheral autonomic nervous system



## Growth Factors

There are many regulatory factors described in literature. Since a complete classification of them is not possible, for convenience sake, they are described in the alphabetical order. Cytokines and lymphokines are briefly described in Chapter 55; Growth factors in Chapter 60, Prostaglandins in Chapter 14 and Nitric oxide in Chapter 17.

### Adiponectin

It is an adipokine; a peptide with 224 amino acids. It is produced exclusively by adipose tissue. The circulating adiponectin has pronounced effects on the metabolism of both carbohydrates and lipids in liver and muscle. It promotes the uptake and oxidation of fatty acids by myocytes, but blocks the synthesis of fatty acids and gluconeogenesis by hepatocytes. At the same time, uptake and metabolism of glucose by muscle and liver are favored. The effects are exerted through an AMP mediated Kinase (AMPK) that can phosphorylate several target proteins, thus affecting metabolic pathways. Net effect is to increase the sensitivity to insulin, to promote fatty acid oxidation and improving the glucose tolerance. Levels of the hormone are inversely correlated with body fat percentage. The hormone plays a role in the suppression of the metabolic derangements that may result in type 2 diabetes, obesity, atherosclerosis and non-alcoholic fatty liver disease (NAFLD). The plasma level of adiponectin parallels with the HDL level. Low levels of both are seen in metabolic syndrome and diabetes mellitus. Thiazolidine drugs have been found to increase the adiponectin levels that can modify the sensitivity of target cells to insulin. Decreased adiponectin is associated with polycystic ovarian syndrome (PCOS) independent of body mass index.

### Bile Acids

In the past, bile acids were considered to be just detergent molecules derived from cholesterol in the liver. They were known to be important for the solubilization of cholesterol in the gallbladder and for stimulating the absorption of cholesterol, fat-soluble vitamins, and lipids from the intestines. However, during the last two decades, it has been discovered that bile acids are regulatory molecules. Bile acids have been discovered to activate specific nuclear receptors (farnesoid X receptor, pregnane X receptor, and vitamin D receptor), G protein coupled receptor TGR5 (TGR5), and cell signaling pathways (c-jun N-terminal kinase 1/2, AKT, and ERK 1/2) in cells in the liver and gastrointestinal tract. Bile acids appear to function as nutrient signaling molecules primarily during the feed/fast cycle as there is a flux of these molecules returning from the intestines to the liver following a meal. Bile acid-controlled signaling pathways are promising novel drug targets to treat common metabolic diseases, such as obesity, type II diabetes, hyperlipidemia and atherosclerosis.

### Cholecystokinin (CCK)

Formerly called pancreozymin, this peptide hormone is secreted by C cells of duodenum and jejunum and has 33 amino acids. The major effect is on stimulation of gallbladder contraction and secretion of bile. It decreases appetite. The main stimulus is the ingestion of food containing lipids. CCK

also stimulates the secretion of pancreatic enzymes. The sulfated tyrosine residues present in gastrin and CCK increase their potency.

### Glucose-dependent Insulinotropic Polypeptide

The old name was **gastric inhibitory polypeptide**. GIP is derived from a 153-amino acid proprotein. The active GIP has 42-amino acids. It is secreted by the neuroendocrine K cells of the duodenum and proximal jejunum. It increases glucose-mediated insulin release and inhibits gastrin production. The hormone regulates glucose and lipid metabolism by increasing the release of insulin through an **incretin** effect. The secretion is stimulated by oral intake of food especially LCFA. Intestinal motility is reduced, but fluid and electrolyte secretions are stimulated. Further, GIP inhibits gastric acid secretion; stimulates lipoprotein lipase (increased uptake of fatty acids by adipocytes) and stimulates proliferation of pancreatic  $\beta$ -cells. Response to GIP is defective in type 2 diabetes mellitus. GIP is also described in Chapter 24, under Insulin secretion.

### Gastrin

It is secreted by G cells of antral mucosa of the stomach and proximal part of duodenum. It can exist in 3 forms, big gastrin with 34 amino acids (G-34) that is cleaved to give little gastrin with 17 amino acids (G-17) and minigastrin (G-14). G-17, produced by antral mucosa has a half life of only 5 minutes, and is the main form. The biologically active portion of gastrin is the C terminal pentapeptide which is also available as a synthetic peptide, called penta gastrin. The major effect of gastrin is stimulation of HCl secretion. Normally gastrin secretion is under feedback control depending on the pH of gastric juice. Gastrin secretion is stimulated by high pH, proteins in stomach and central vagal stimulation. Excessive gastrin secretion occurs when gastrin producing tumors are present. This condition is referred to as Zollinger-Ellison syndrome, resulting in very high levels of acidity and chronic gastric ulcers. Adult reference value is 25–90 pg/mL.

### Glucagon-like Peptides

Insulin production is 70% greater when glucose is administered orally than when similar blood concentrations were reached after intravenous administration of glucose; this increment is due to intestinal factors, termed **incretins**. The most important incretins are GLP1 and GIP (GIP is described above). GLP1 and GLP2 are both secreted by enteroendocrine L cells in ileum, colon and central nervous system. The glucagon gene encodes a precursor protein, proglucagon which can be processed into several different biological peptides. In the alpha cells of pancreas, glucagon is produced. In intestinal cells, the precursor protein is converted into GLP-1 and GIP. Bioactive GLP-1 consists of 2 forms; GLP-1 (7-37) and GLP-1 (7-36) amide, where the latter form constitutes the majority (80%) of the circulating hormone.

The GLP1 secretion is dependent on the presence of nutrients in the lumen of small intestine. It has an inhibitory effect on glucagon secretion and enhances glucose utilization after meals by stimulating insulin secretion. The incretin effect is by acting through second messengers in the beta cells to increase the sensitivity of these cells. GLP decreases food intake and its secretion is affected by oral ingestion of nutrients and vagal stimulation. Somatostatin has an inhibitory effect on GLP secretion.

GLP is a good target for treating diabetes mellitus. GLP has a half life of about 90 seconds, and newer drugs are being developed to increase the half-life to a few days.

GLP-1 increases the level of insulin resulting in significant reduction in circulating levels of glucose. This activity of GLP-1 is transient, as the half-life of this hormone in the circulation is less than 2 minutes. GLP-1 also proliferates pancreatic  $\beta$ -cells, reduces  $\beta$ -cell apoptosis (programed cell death), increases expression of the glucose transporter-2 (GLUT-2) and glucokinase genes. GLP-1 is also described in Chapter 24, under Insulin secretion.

### Ghrelin

Ghrelin stimulates the release of growth hormone. The name ghrelin is derived from **growth-hormone release**. It is secreted by oxyntic cells of stomach and duodenum. As a result of alternative splicing, the 117 amino acid preproghrelin protein is processed into ghrelin (28 amino acids) and obestatin (23 amino acids). Bioactive ghrelin is acylated on the serine at position 3 with *n*-octanoic acid. Ghrelin stimulates arcuate nucleus to release neuropeptide Y (NPY). The action of NPY is to enhance appetite. Production of ghrelin is increased by fasting, hypoglycemia and leptin. Conversely, inhibition of ghrelin production is exerted by food intake, hyperglycemia, and obesity. Additionally ghrelin inhibits the expression of proinflammatory cytokines, controls gastric motility, influences sleep patterns, memory and anxiety-like behavioral responses.

Ghrelin increases appetite, and decreases insulin secretion. It is a hunger signal effective between meals. It is secreted under conditions of fasting. Ghrelin has receptors in pituitary (to stimulate growth hormone production) and hypothalamus (to regulate appetite). The level is high before a meal but falls rapidly after taking food. Patients with Prader-Willi syndrome have been found to have high levels of ghrelin that may account for excessive food intake and obesity in these patients. See also discussion on Ghrelin in Chapter 40.

### Obestatin

The effect of obestatin is exactly opposite to that of ghrelin. Release of obestatin suppresses food intake and gastric emptying activity. Obestatin binds to a G-protein coupled receptor (GPCR) identified as GPR39. Activation of the receptor results in increased cAMP and consequent activation of PKA mediated signaling pathways.

### Neuropeptide Y

It is secreted by the N cells of ileum and also those present in entire nervous system, adrenal gland and pancreas. The action is to inhibit glucose-stimulated insulin secretion. See also discussion on Neuropeptide Y in Chapter 40.

### Pancreatic Polypeptide

Stimulates biliary flow and exocrine pancreatic secretion. It is produced by pancreatic PP cells. Increased levels are seen in insulinomas, gastrinomas, carcinoid tumors arising outside the pancreas, adenocarcinomas of pancreas, stomach, colon, rectum, duodenal ulcer, diabetes mellitus, MEN Type I, medullary carcinoma thyroid and Zollinger-Ellison syndrome. Decreased levels are seen in chronic pancreatitis with exocrine insufficiency.

### Secretin

A polypeptide having 27 amino acids released by the S cells of the small intestine in response to a low luminal pH ( $< 5$ ). Secretin stimulates secretion of pancreatic juice having a high bicarbonate content, that maintains the optimum pH for the action of pancreatic enzymes by neutralizing gastric HCl. It acts synergistically with CCK.

### Somatostatin

There are two forms; SS-14 has 14 amino acids and SS-28 has 28 amino acids. The synthetic analog has 8 amino acids. Half-life of SS-14 is only 2 minutes; it is present in brain, pancreas; while SS-28 is seen in intestinal mucosa. SS is the main inhibitory peptide of the GI tract. It produces its effects through binding with 5G-protein-coupled SS receptors (SSTR1 to 5). SS inhibits the production of gastrin, CCK, secretin, VIP, insulin, pancreatic enzymes and secretion of electrolytes into the intestine. Somatostatinoma is rare, but may occur in pancreas or upper small intestine.

### Vasoactive Intestinal Polypeptide

A potent secretagogue of NaCl and water in the intestine and pancreas. It is a neuropeptide released by enteric neurons that regulate electrolyte and NaCl secretion. VIP is found in highest concentrations in brain and GIT. VIP is present in the nerve fibers supplying GIT. Functions of VIP are a) neurotransmitter in the central and autonomous nervous system, b) vasodilatation and relaxation of smooth muscles of the gut, c) secretion of water and electrolytes from the pancreas and gut as well as d) release of hormones from the hypothalamus, pancreas and gut. Normal fasting value is  $< 50$  pg/mL. It is increased in pancreatic VIP secreting tumors (VIPomas, Verner-Morrison syndrome), neural crest tumors in children (ganglioneuroblastoma), pancreatic islet cell hyperplasia, liver disease, pheochromocytoma, medullary thyroid carcinoma, MEN Type I (multiple endocrine neoplastic syndrome Type I). Tumors producing VIP (VIPomas) result in a triad of symptoms; watery diarrhea, hypokalemia and achlorhydria; this is referred to as pancreatic cholera (WDHA syndrome).



# SECTION G

---

## Advanced Biochemistry

Chapter 55 Immunochemistry  
Chapter 56 Biochemistry of AIDS and HIV  
Chapter 57 Biochemistry of Cancer  
Chapter 58 Tissue Proteins in Health and Disease  
Chapter 59 Applications of Isotopes in Medicine  
Chapter 60 Signal Molecules and Growth Factors  
Appendices





# CHAPTER 55

## Immunochemistry

### Chapter at a Glance

The reader will be able to answer questions on the following topics:

- Immune response
- Effector mechanisms
- Structure of immunoglobulins
- Immunoglobulins G, M, A, D and E
- Multiple myeloma
- Bence-Jones proteinuria
- Complement system
- Primary and secondary immune response
- Transposition of genes
- Lymphokines and interleukins

Immunology is one of the rapidly advancing branches of medical science. Small pox has been completely eradicated from the world by 1985; this is a triumph of immunology. Three salient features of immunological reactions are: **Recognition of self** from nonself or foreign substances; **specificity** of the reactions, and **Memory** of the response.

When injected with 100 different proteins, the animal will produce 100 different antibodies; this is called specificity. If a person belongs to A group antigen of RBC, antibodies against B group are seen in circulation. There is an extra N-acetyl group in antigen A; this is the only molecular difference between

A and B antigens. Immune system is exquisitely specific to recognize even this small difference at molecular level. If the same antigen is introduced for a second time, body will react immediately; this memory is the basis of vaccination.

Introduction of cowpox vaccination by Jenner in 1798 paved the foundation for immunization procedures. This does not mean that he had discovered the procedure. For 10 years, he was in Punjab, India as a doctor, when he came to know about the inoculation procedure available throughout India from time immemorial. Jenner has developed and simplified the procedure. Rabies vaccine was discovered by Pasteur in 1881. Emil von Behring (Nobel prize, 1901) introduced therapy with antibodies, especially against diphtheria. In 1908, Nobel prize was



Edward Jenner  
1749–1823



Emil Adolf Behring  
NP 1901  
1854–1917



Paul Ehrlich  
NP 1908  
1854–1915



Henry H Dale  
NP 1936  
1875–1968



Karl Landsteiner  
NP 1930  
1868–1943



Daniel Bovet  
NP 1957  
1907–1992



Niels K Jerne  
NP 1984  
1911–1994



Rosalyn Yalow  
NP 1977  
1921–2011



Peter Doherty  
NP 1996  
b.1940

Rolf  
Zinkernagel  
NP 1996  
b. 1944

Bruce Beutler  
NP 2011  
b. 1957

Ralph Steinman  
NP 2011  
1943–2011

awarded to Paul Ehrlich for explaining the antibody production and to Metchnikov for discovery of phagocytosis. Life saving blood transfusion was made possible by the pioneering work on human blood groups, the ABO and Rh system by Karl Landsteiner (Nobel prize, 1930). By employing specific antibodies, nanogram or picogram quantities of biologically important substances can be estimated. This is termed *radioimmunoassay* (see Chapter 35). Radioimmunoassay was first described by Rosalyn Yalow (Nobel prize, 1977). Peter Doherty and Rolf Zinkernagel were awarded Nobel Prize in 1996 for their work on the specificity of cell mediated immune response. Bruce Beutler and Jules Hoffman were awarded Nobel Prize in 2011 for their discoveries concerning the activation of immunity. Nobel prize was awarded to Ralph Steinman in 2011 for his work on dendritic cells in immunity.

## Antigens

Certain components of the cell membranes act as specific antigens. They will be different from person to person in chemical composition and three dimensional structure. Hence, the immunocompetent cells could recognize the self from nonself. Any substance which invokes an immunological response is an **antigen** or immunogen. Antibody response will usually be selective against specific spatial configurations on the antigen, which are called antigenic determinant sites, known as **epitopes**.

## Immune Response

The lymphocytes generated from the bone marrow, passed through and processed by the thymus gland, are then called **T-lymphocytes**. They can directly kill the target cells and are the effector cells for the **cell-mediated immunity** (CMI). The T-lymphocytes are found mainly in the paracortical areas of lymph nodes and periarteriolar sheaths in the spleen. In peripheral blood 80% lymphocytes are T-cells, and 15% are B-cells.

Certain other cells originated from bone marrow and processed by the Bursa of Fabricius in avians, are called **B-cells**. The Bursa equivalent organs in human beings are gut associated (including Peyer's patches) and lung

associated lymphoid organs. Immunoglobulins are secreted by **Plasma cells** belonging to the B-lymphocytes. The B-cells govern the **humoral immunity**.

**Clonal selection:** Immunoglobulins of different specificity are available on the B-cell surface. When an antigen is introduced, the antigen selects out that particular cell carrying the specific antibody. This results in a series of divisions of that cell and a clone of cells are produced. These cells are finally differentiated into plasma cells. This is the antigen dependent **clonal selection**. A particular clone of cells secretes antibodies of the same specificity.

## Effector Mechanisms

The following are the immunological effector mechanisms by which foreign cells are destroyed or particles are removed:

### Cell Mediated Immunity

The following are the major activities of T-lymphocytes.

- A. **Immunity against infections:** T-cells mediate effective immunity against bacteria, such as mycobacteria, many viruses and almost all parasites.
- B. **Rejection of allograft:** When an organ (heart, kidney) is transplanted from one person to another, it is called allograft. Body tries to reject such transplanted organs, mainly by T-cell mediated mechanism.
- C. **Tumor cell destruction:** Although other mechanisms are also involved in killing tumor cells, T-cell activity is the predominant one.
- D. **Helper function:** T helper (TH) cells are a sub-group of cells which carry CD4 determinants on the cell surface (CD = cluster determinant). They are necessary for optimal antibody production by plasma cells and for generation of cytotoxic T-cells. They are selectively destroyed in AIDS (see Chapter 56).
- E. **Suppressor function:** T suppressor (TS) cells are CD8 positive cells. They downregulate the activities of both T-and B-cells.
- F. **Production of lymphokines:** T-cells when stimulated by antigens, liberate many soluble substances called cytokines or lymphokines. They are described at the end of this Chapter.
- G. **Delayed type hypersensitivity:** When tuberculin (antigen prepared from tubercle bacilli) is injected intradermally in a patient with tuberculosis, an erythematous indurated lesion develops slowly reaching its maximum within 48–72 hours. This is called delayed type hypersensitivity. Hypersensitivity is the over-reaction of the immune system, often resulting in unwanted tissue destruction. This is responsible for caseation and lung cavity formation in the case of tuberculosis, granulomatous skin lesions in tuberculoid leprosy, skin lesions in herpes simplex and contact hyper sensitivity to chemicals and plant products.

## Humoral Immunity

Antibodies are produced by plasma cells. These are immunoglobulins, described in detail below. The antigen-antibody reaction leads to activation of complement system, which destroys the foreign cells. The antibodies can destroy the target cells by the following mechanisms: (1) Classical complement pathway, (2) Antibody dependent cell mediated cytotoxicity (described below), (3) Agglutination, (4) Opsonization of target cells, thereby making them more susceptible to phagocytosis.

### Antibody Dependent Cell Mediated Cytolysis

Antibody dependent cell mediated cytotoxicity (ADCC) requires antibody, but the cytolysis does not require complement activity. The effector cells are neither T nor B cells but are called K-(Killer) cells. The specificity of this reaction resides in the antibody molecule. Only very small amounts of antibody are required; so this mechanism is effective in areas where antibody concentration may be minimal, e.g. at the site of tumors.

## Macrophages

Phagocytosis is the nonspecific mechanism by which body tries to eliminate invading organisms. Foreign materials are ingested by the phagocytes and later digested intracellularly. The myeloperoxidase present inside the phagocytes destroys the bacteria (see Chapter 33). When a foreign particle enters the body, the macrophages phagocytose it, and present the antigens to the lymphocytes.

## STRUCTURE OF IMMUNOGLOBULINS

Immunoglobulin is abbreviated as Ig. The terms gamma globulin and immunoglobulin are not synonymous. Gamma globulin is the term describing its mobility in electrical field. Most of the immunoglobulins have the gamma mobility; but some may move along with beta or even with alpha globulins. **Immunoglobulin** is a functional term, while **gamma globulin** is a physical term. The antibody reacts with antigen very specifically. This property is widely used in purification of proteins and for affinity chromatography. This affinity is based on the complementary nature of the three dimensional structure of antigen and antibody. If there is a protuberance in the antigen, there is a corresponding cleft in the antibody structure.

In 1962, Rodney Porter and Gerald Edelman independently proposed the structure for immunoglobulin molecule, for which both of them were awarded Nobel prize in 1972.

## Heavy and Light Chains

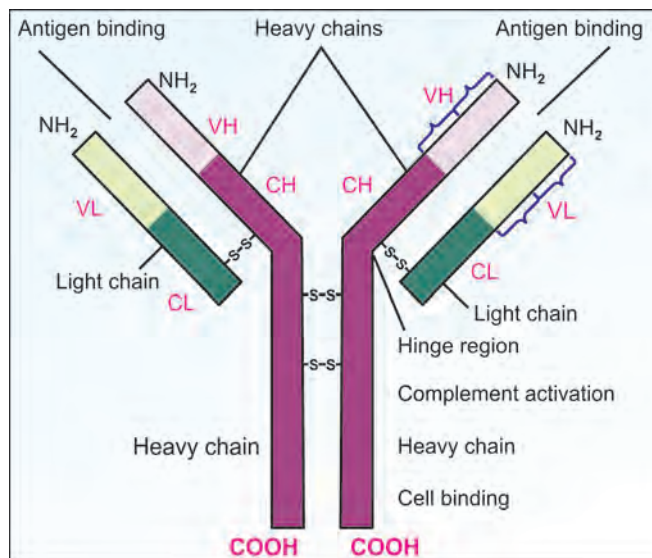
The structure of IgG molecule is shown in Figure 55.1. It is made up of 2 heavy (H) chains and 2 light (L) chains, combined through disulfide bridges. In the case of IgG, H chains are composed of 440 amino acids and L chains made up of 214 amino acids. Depending on the heavy chain make up, the immunoglobulins are differentiated into **5 major classes**.

1. **Immunoglobulin-G (IgG)** is made up of heavy chain  $\gamma$  (gamma)
2. **IgM** has  $\mu$  (mu) heavy chain
3. **IgA** has  $\alpha$  (alpha) heavy chain
4. **IgD** contains  $\delta$  (delta)
5. **IgE** heavy chain is called  $\epsilon$  (epsilon).

The **light chains** are either  $\kappa$  (kappa) or  $\lambda$  (lambda) in all the classes. For example, IgG may consist of either  $\gamma_2 \kappa_2$  or  $\gamma_2 \lambda_2$ . In human beings, 60% light chains are of  $\kappa$  variety and 40% are of  $\lambda$  type.

## Variable and Constant Regions

Both the heavy and light chains contain relatively variable (V) and constant (C) regions with regard to their amino acid composition. VL and CL are the general terms for these regions on the light chain; while VH and CH specify variable and constant regions on the heavy chain (Fig.55.1).



**Fig. 55.1:** Immunoglobulin molecule.  $\text{NH}_2$ =amino terminal end;  $\text{COOH}$ =carboxy terminal end; Constant regions are shown as dark; VH= variable heavy region; VL= variable light chain; CH= constant heavy region; CL= constant light region. Chains are connected by disulfide bridges, shown as -S-S- linkages



The first 108 amino acids in light chains and first 118 amino acids in  $\gamma$  heavy chains constitute the variable region. Here the amino acid sequence can vary in H and L chains, so that the body could synthesise enormous varieties of different antibodies.

## Fab and Fc Portions

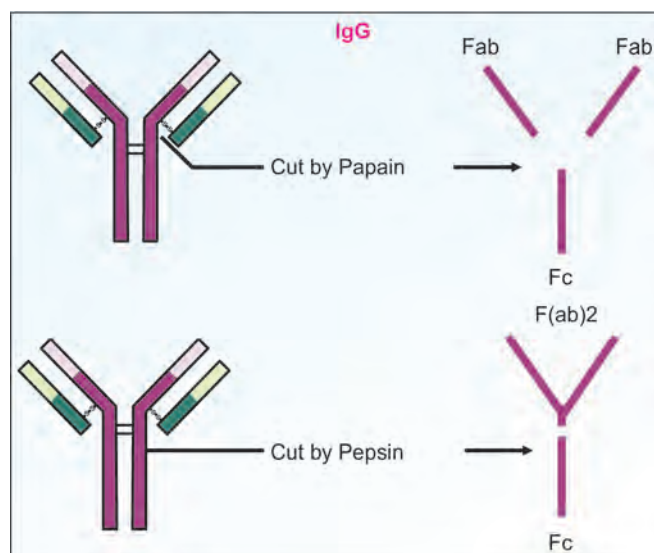
- Papain** (proteolytic enzyme from papaya) cleaves the Ig (Fig. 55.2), so that two Fab (fraction antibody) portions and one Fc (fraction crystallizable) portion are produced. The **antigen binding part** of the antibody is in the Fab fragment.
- The cleavage takes place in the **hinge region**, where Ig molecule can have mobility in 3-dimensional space, so as to adjust for tight grip on the antigen. Carbohydrate groups of the Ig molecule are also situated in the hinge region. The area capable of **complement binding** lies in the Fc portion.
- Another proteolytic enzyme, **pepsin** cleaves Ig at an other site (Fig. 55.2) so as to yield F(ab)<sub>2</sub>, where two Fab portions are combined together. Fab part can combine with antigen very weakly, but combination with F(ab)<sub>2</sub> is stronger.

## Different Classes of Immunoglobulins

### Immunoglobulin G (IgG)

- IgG contains two heavy chains and two light chains; heavy chains being of gamma type (Figs 55.1, 55.3 and Table 55.1). Due to its sedimentation coefficient, it is sometimes referred to as 7 S Ig.
- IgG is the major antibody; it constitutes about 75–80% of total immunoglobulins in circulation.

- It is the antibody seen in **secondary** immune response.
- It can pass from vascular compartment to interstitial space. It can cross placental barrier, and protects the newborn child from infections. These maternal antibodies are seen in neonatal circulation up to 2–4 months.
- Placental crossing of IgG also explains the **Rh iso-immunization**. This occurs when mother is Rh negative, and fetus is Rh positive, and when ABO system antigens are similar to both mother and fetus. During parturition, fetal RBCs may enter into maternal



**Fig. 55.2:** Papain cuts the immunoglobulin molecule at a site towards the amino terminal part of the disulphide linkages. So, two Fab and one Fc portions are produced. Pepsin cleaves the molecule towards the carboxy terminal part of the disulfide linkages, so that one F(ab)<sub>2</sub> and one Fc portion are produced

**TABLE 55.1:** Characteristics of different immunoglobulin classes

	IgG	IgA	IgM	IgD	IgE
Nomenclature of heavy chain	$\gamma$	$\alpha$	$\mu$	$\delta$	$\epsilon$
Heavy chain domains	4	4	5	4	5
No. of basic 4-peptide units (2L + 2H)	1	2	5	1	1
Additional unit	—	S and J	J piece	—	—
Molecular weight (Daltons)	1,46,000	3,85,000	9,70,000	1,85,000	1,90,000
Sedimentation coefficient	7 S	11 S	19 S	7 S	8S
Carbohydrate content (%)	2–3	8–10	12	10–13	11–12
Concentration in normal serum / 100 mL	800–1200 mg	150–300 mg	50–200 mg	1–10 mg	1.5–4.5 $\mu$ g
Half-life in days	20	6	10	3	2
Distribution (% intravascular)	45	5	95	75	50

circulation, leading to formation of anti Rh antibodies. During next pregnancy, these antibodies, being IgG in class, can enter into fetal circulation, causing fetal hemolysis, neonatal jaundice, and in severe cases, neonatal death or miscarriage. Passively injected anti-Rh antibody, when injected within 24 hours of delivery of first child, will avert the isoimmunization and can protect future pregnancy.

In cows, placental crossing of immunoglobulin does not occur, but the colostrum (first day's milk) contains good quantities of antibody which can cross the intestinal walls of newborn calves. Human colostrum contains immunoglobulins to a lesser extent.

IgG can bind with microbes, and the Fc portion can fix with macrophage, so that phagocytosis is made easier. This is called **opsonization** effect of antibody. Antibodies coating the target

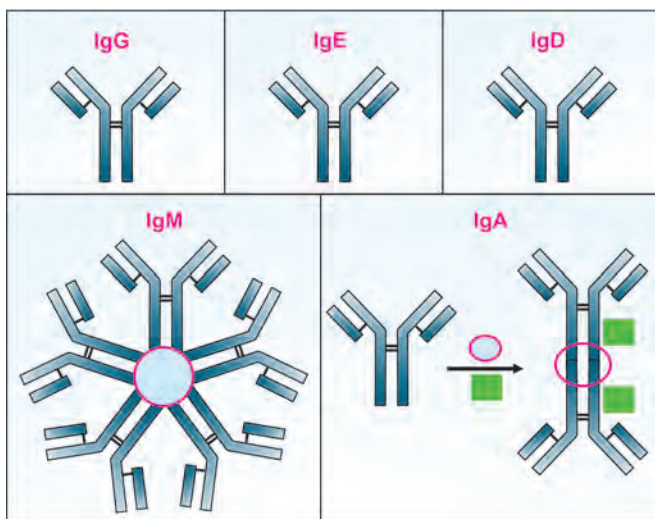
cells will sensitize them for killing by lymphocytes by *antibody dependent cell mediated cytotoxicity* (ADCC). Only IgG class is active for ADCC mechanism (Table 55.2).

### Immunoglobulin M (IgM)

- IgM are **macroglobulins** or 19 S immunoglobulins.
- Five subunits, each having 4 peptide chains (total 10 heavy chains and 10 light chains) are joined together by a J-chain polypeptide (Fig.55.3). It can combine with 5 antigens simultaneously, and so IgM is very effective for agglutinating bacteria.
- Being a large molecule, it cannot come out of vascular space.
- IgM are the predominant class of antibodies in **primary** response.
- Natural** antibodies are IgM in nature. Thus, a person having blood group A antigen will have anti-B antibodies in his circulation (isohemagglutinins). These are produced without any known antigenic stimulation, and hence called natural antibodies. These IgM antibodies cannot cross placenta, and therefore the fetus, even though it carries an incompatible antigen, is protected from natural antibodies of the mother.

**TABLE 55.2:** Functions of immunoglobulins

	IgG	IgA	IgM	IgD	IgE
Placental transfer	+	-	-	-	-
Complement fixation	+	+	++	-	-
Agglutination	+	++	+++	-	-
Binding to macrophages	+	-	-	-	-
Fixation to mast cells	-	-	-	-	+
Primary response antibody	-	-	+	-	-
External secretions	-	+	-	-	-
Natural antibodies	-	-	+	-	-



**Fig. 55.3:** IgG, IgE and IgD have one basic unit each, Ig M has 5 basic units and IgA has 2 basic units. Red circles represent J pieces. Green squares are secretory pieces

### Immunoglobulin A (IgA)

- IgA usually are dimers (total 4 heavy chains and 4 light chains). The J chain connects the dimers (Fig.55.3).
- They are the **secretory antibodies** seen in seromucous secretions of gastrointestinal tract, nasopharyngeal tract, urogenital tract, tears, saliva, sweat, etc.
- The dimers are stabilized against proteolytic enzymes by the secretory piece. The **secretory piece** is produced in liver, reaches to the intestinal mucosal cells, where it combines with IgA dimer to form the secretory IgA which is then released.

### Immunoglobulin E (IgE)

- They are cytophilic antibodies. They mediate allergy (Greek, allo = other; ergon = work), hypersensitivity and **anaphylaxis**.
- They have the property to fix on mast cells and basophils. When certain antigens such as penicillin are injected a few times, IgE class antibodies are produced which anchor on **mast cells**. When the same chemical is injected next time, the antigens fix on

such antibodies, causing mast cell degranulation, and release of **histamine** and slow reacting substance.

- c. This leads to vasodilatation, hypotension and bronchiolar constriction. This is the basis of penicillin anaphylaxis, hay fever caused by fungus, asthma by pollen and urticaria by absorbed food elements. The peak of this reaction will be at about 30 minutes; hence called **immediate type** hypersensitivity.
- d. IgE level in serum is markedly increased in helminthic infections.

The role of histamine in anaphylaxis was elucidated by Sir Henry Dale (Nobel prize, 1936). The first antihistaminic drug, mepyramine was prepared in 1944 by Daniel Bovet who was awarded Nobel prize in 1957.

### Isotypes, Allotypes and Idiotypes

**Isotypes** are variants in molecules seen in all normal persons; e.g. classes and subclasses of immunoglobulins (G, M, A, etc.). **Allotypes** are a variation within a subclass, and depend upon allelic forms. Thus only one form will be seen in one person; e.g. the Gm groups of IgG molecules. If a person is G<sub>m</sub> +ve, each of his IgG1 molecules has a sequence Asp-Glu-Leu-Thr. Another person with G<sub>m</sub> -ve will have this sequence changed to Met-Glu-Glu-Thr. About 30 genetic markers of Gm groups on g heavy chain are discovered. **Idiotypic** variation is individually specific to each immunoglobulin molecule. The idiotypic determinants are located in the variable part of antibody, i.e. the antigen recognition site. In 1984, Nobel prize was awarded to Niels Jerne for his work on idiotypes as well as for theories on antibody production.

## PARAPROTEINEMIAS

### Multiple Myeloma (Plasmacytoma)

- A. When Ig-secreting cells are transformed into malignant cells, one clone alone is enormously proliferated. Thus, Ig molecules of the very same type are produced in large quantities. This is seen on electrophoresis as the myeloma band or **monoclonal band** or M band with a sharp narrow spike (see Fig. 28.2).
- B. Multiple myeloma is characterized by paraproteinemia, anemia, lytic bone lesions and proteinuria. Bone marrow examination reveals large number of malignant plasma cells. Spontaneous pathological fracture of weight bearing bones, rib and vertebrae may occur. X-ray shows punched-out osteolytic lesions.
- C. Hypercalcemia and hypercalciuria are therefore common features. Raised beta-2-microglobulin (Mol. wt. 11,800 D) is another feature of multiple myeloma.
- D. Total Ig content may be very high; but useful antibodies may be very low, so that general immunity is depressed and recurrent infections are common.

- E. The prognosis is generally good, and average survival is more than 5 years with adequate chemotherapy and local irradiation.

Monoclonal gammopathies are characterized by the presence of a monoclonal protein which can be detected by serum protein electrophoresis and typed by immunofixation electrophoresis. The light chains are produced in excess which is excreted in urine as Bence-Jones proteins (BJP) when their serum level increases. Detection of BJP in urine and assay of free light chains in serum are of diagnostic and prognostic significance in multiple myeloma. It is seen that excretion and deposition of monoclonal light chains in kidney results in impairment of renal function.

### Bence-Jones Proteinuria

- A. Henry Bence-Jones described it in 1848. This disorder is seen in 20% of patients with multiple myeloma. Monoclonal light chains are excreted in urine. This is due to asynchronous production of H and L chains or due to deletion of portions of L chains, so that they cannot combine with H chains.
- B. The Bence-Jones proteins have the special property of precipitation when heated between 45°C and 60°C; but redissolving at higher than 80°C and lower than 45°C. These proteins may block kidney tubules, leading to renal failure. So, myeloma with Bence-Jones proteinuria has poor prognosis.
- C. Bradshaw's test is also positive, when a few mL of urine is layered over a few mL of concentrated hydrochloric acid, a white ring of precipitate is formed.

### Heavy Chain Disease

Some portions of H chains are deleted during synthesis, so that they cannot join with L chains to form normal Ig. These defective heavy chains are excreted through urine. Gamma chain disease is associated with hepatosplenomegaly and lymphadenopathy. Alpha chain disease is associated with abdominal lymphoma and malabsorption.

### Waldenstrom's Macroglobulinemia

In this condition, IgM level in blood is increased considerably with a monoclonal peak. This is due to malignant proliferation of IgM clones. Males are affected mostly. Since IgM are macromolecules, they may form aggregates or cryoprecipitates, serum viscosity is increased. This is the basis of **Sia test**. A drop of serum is allowed to fall into a tube containing water. Normal serum will spread. Hyperviscous serum will form globular precipitate. Hyperviscosity leads to recurrent bleeding.

### Amyloidosis

About 20% patients with myeloma develop amyloidosis. Amyloid deposits are seen in liver and kidney. Congo Red will stain amyloid deposits. In the case of myeloma, the amyloid fibrils contain polymerized variable region of light chains of Ig and termed AL. Amyloidosis may

also be seen secondary to chronic inflammatory conditions, where the deposited proteins are *Amyloid-A* (AA) with a molecular weight of 8,000. This is derived from another serum precursor termed S-AA, an acute phase protein of 90 kDa. Beta-2-microglobulin and transthyretin are other precursor proteins of amyloid deposits. S-AA and S-APP are further described in Chapter 60.

### Hypergammaglobulinemia

- Chronic infections, where antibody production is high. Examples are leprosy, tuberculosis, syphilis, malaria, kala-azar, subacute bacterial endocarditis.
- Aberrant immune reactions, such as rheumatoid arthritis, collagen disorders, glomerulonephritis, and such autoimmune disorders where cryoglobulins may also be present.
- Paraproteinemias such as in multiple myeloma and Waldenstrom's macroglobulinemia.
- Monoclonal Gammopathy of undetermined significance (MGUS) is characterized by hypergammaglobulinemia and M band on electrophoresis. But these patients do not have any end organ disease like anemia or bone involvement. The plasma cells in bone marrow is less than 10%. They, however, have a higher chance of progressing to multiple myeloma.

### Hypogammaglobulinemia

Decrease or absence of immunoglobulin levels may be seen in congenital or acquired conditions. Deficiency can also occur due to loss of proteins as in nephrotic syndrome. A primary failure in production may occur as a congenital X-linked disorder (*Bruton's disease*). Decreased production may also be secondary to diseases like myeloma, leukemia or drug induced.

## COMPLEMENT SYSTEM

Complement factors are proteins present in serum. The cell lysis by antibody is mediated by complement system. Complement is generally abbreviated as C'. There are 9 components, designated as C1 to C9.

The complement activity is abolished if serum is incubated at 56°C for 30 minutes, as most of the components are thermolabile. The half-life of complement system at room temperature is only a few hours. The characteristics of complement components are shown in Table 55.3.

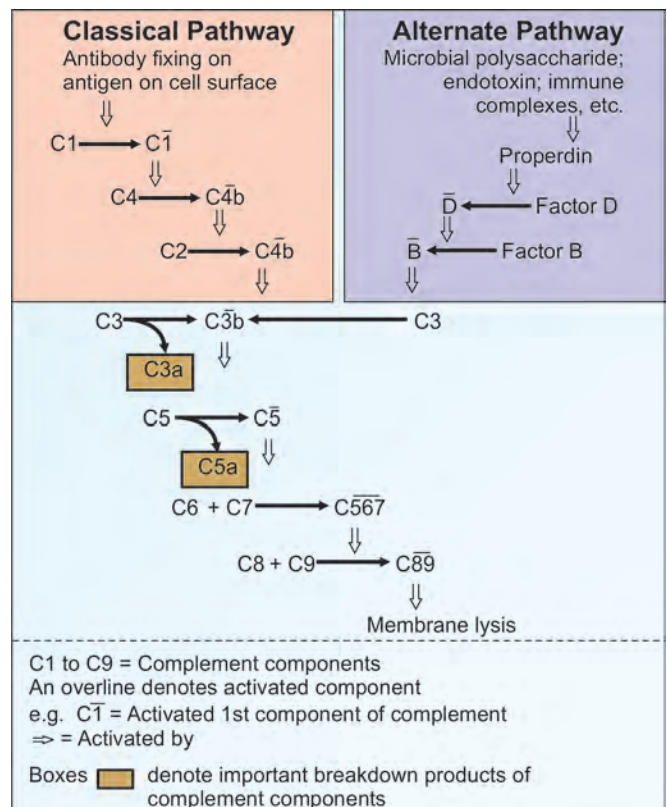
### Complement Activation

When Ig is bound on the bacteria, the Ig fixes the first component of complement, C1. It has 3 subunits; C1q, C1r and C1s which are stabilized by Ca<sup>++</sup>. C1q binds with the antibody. It has 18 polypeptide chains, branching into 6 flower like blooms connected to one stem. These branches can fix to antibody subunit chains. Then C1r and C1s are bound. C1s (C-1-esterase) when thus activated, acquires proteolytic activity. It in turn, cleaves and activates the next component, C4. Thus a multi-enzyme **cascade system**

is activated, leading to chemical amplification of the original message. The waterfall like pathway of activation of complement system is given in Figure 55.4. The final components when activated, create microscopic holes in the target cell membrane. Osmotic entry of water through these pores will cause lysis of the target cell.

**TABLE 55.3:** Characteristics of complement system

Complement component	Electrophoretic mobility	Main site of synthesis
C1q	γ	Epithelial cell of intestine
C1r	β	do
C1s	α	do
C2	α-2	Reticuloendothelial cells
C3	β-2	Hepatocytes
C4	β-1	Reticuloendothelial cells
C5	β-1	Macrophages
C6	β-1	Hepatocytes
C7	β-1	Macrophages
C8	γ	Macrophages
C9	α	Macrophages



**Fig. 55.4:** Pathways of complement activation



The breakdown products, C3a and C5a activate phagocytosis, chemotaxis and immune adherence while increasing the capillary permeability.

### Alternate Pathway

Apart from this classical pathway, microbial polysaccharides can activate the **properdin system**, so as to bypass the initial complement components. This system includes properdin, Factor D, Factor B, Factor I, and Factor H. Since this does not require specific antibodies, the alternate pathway acts as the first line of defense against invading microorganisms.

C1-esterase-inhibitor is an alpha-2 globulin with molecular weight of 105,000. It can inhibit not only C1-esterase (C1s) but many other plasma enzymes such as plasmin, kallikrein, Hageman factor, etc. Hereditary **angioneurotic edema** is an inherited autosomal dominant disease, in which C1-esterase inhibitor is absent. This leads to uncontrolled activation of early components of complement system, with generation of kinin-like substances. Death may occur due to laryngeal edema.

Diagnosis is by showing normal C1 but diminished C4 and C1-esterase inhibitor.

## IMMUNODEFICIENCY STATES

### Combined Immunodeficiency

There is defect in maturation of stem cells. Both cellular and humoral immunity are defective. Relatively benign types are Wiskott-Aldrich syndrome (sex-linked) and ataxia telangiectasia (autosomal recessive). In both, lymphoreticular malignancies are common.

### Humoral Immune Deficiency

This may be a selective primary deficiency affecting only one of the G, M or A classes of immunoglobulins. In IgG deficiency, the affected persons suffer from repeated pyogenic infections. IgA deficiency lowers the resistance to gut commensals leading to malabsorption syndrome. Incidences of autoimmune diseases such as hemolytic anemia are high in primary agammaglobulinemia.

### Cellular Immune Deficiency

Primary deficiency of T-cell leads to severe viral and monilial infections. Thymus may be absent (Nezelof's syndrome), aplastic (Di George syndrome), or normal.

### Defective Phagocytosis

Chronic granulomatous disease is a sex-linked inherited disease, where peroxidase is deficient inside the phagocytes. Macrophages can engulf bacteria, but cannot digest them; and bacteria may multiply inside the macrophages. Recurrent granulomas due to catalase positive and peroxidase negative organisms (*Staphylococcus aureus*) are common. In myeloperoxidase deficiency, infections by peroxidase positive bacteria such as hemophilus are common. In Chediak-Higashi syndrome, the neutrophils show defective degranulation and sluggish motility with consequent pyogenic infections.

### Secondary Immunodeficiency

Secondary defects in lymphocyte function are seen in many clinical conditions, such as malnutrition, leukemias and lymphomas. In multiple myeloma, though total immunoglobulins are increased, the biologically active ones are depressed. The acquired immunodeficiency syndrome (AIDS) is described in detail in Chapter 56.

## Primary and Secondary Immune Responses

When an antigen is injected, antibodies in blood appear within about 10 days, reach a peak level within 20 days and response declines by about 30 days. The IgM molecules will be predominant in this **primary response**.

When the same antigen is reinjected into the same animal after a few months, the antibody response is **quicker** (within 3 days), **stronger** (100 to 1000 times more quantity of antibody), more **avid** (IgG type) and more **prolonged** (response lasts for months). This is the **secondary immune response**, which is due to the memory cells produced in the primary response (Fig. 55.5). This is the basis of immunization.

**Active immunity** is induced by immunization with toxoid, or killed or attenuated organisms. Examples are diphtheria, pertussis, tetanus (DPT) vaccine, oral polio vaccine and hepatitis B vaccine.

In **passive immunity**, protection is given by preformed antibodies. This is used in immunotherapy against diphtheria, tetanus, snake bites, etc.

### Transposition of Genes

Body can easily produce  $10^{10}$  diverse antibodies against different antigenic stimulation. Such huge numbers of genes are not available

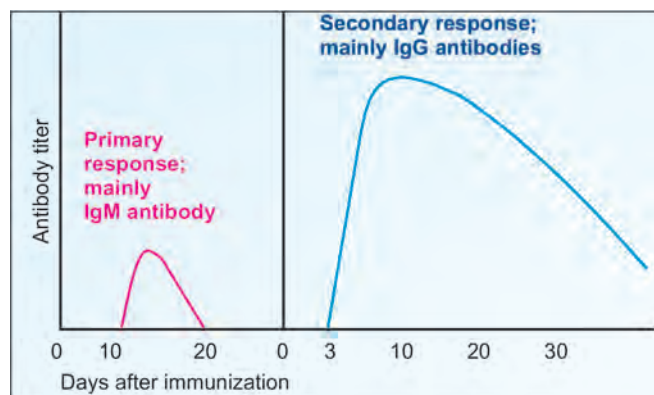


Fig. 55.5: Primary and secondary immune responses

in the Ig loci. It is possible to explain the mechanism as transposition of genes or gene rearrangement or **somatic recombination of DNA**. In humans, the gene for kappa light chain is in chromosome No. 2, that for lambda chain is in chromosome No. 22 and those for heavy chains are in chromosome No. 14. Each L chain gene contains over 500 VL (variable light) segments, 5–6 JL (joining light) segments and 10–20 CL (constant light) segments. During differentiation of B lymphocytes, one out of 500 VL segment is brought from a distant site on the same chromosome to the genes of JL and CL segments. This recombination system is similar to the spliceosomes described (see Fig. 45.11). In Figure 55.6, it is depicted that 200th VL, 4th JL and 9th CL segments of germ line are brought together by cutting and splicing at specific points of DNA. In this given example, random rearrangement allows VL (200)-JL(4)-CL(9) segments to remain in the gene, while other regions of genes are deleted. These VL-JL-CL segments are transcribed as a single mRNA, and later translated into a specific immunoglobulin light chain. Another permutation is taking place in another cell. Thus millions of cells together can produce an infinite variety of light chains.

### Gene, Cistron, Split Gene, Polypeptide

In classical genetics, it is stated that one **gene** determines one character, which is the result of combined action of many proteins. In classical biochemistry, a **cistron** is the basic unit which encodes one polypeptide chain. But this concept is also changed. As shown previously, many such cistrons could be spliced and rearranged. In other words, **many genes together can produce one peptide chain**, by means of transposition. Susumu Tonegawa did pioneering work in somatic recombination (gene shuffling) in relation to antibodies, who was awarded Nobel prize in 1987.

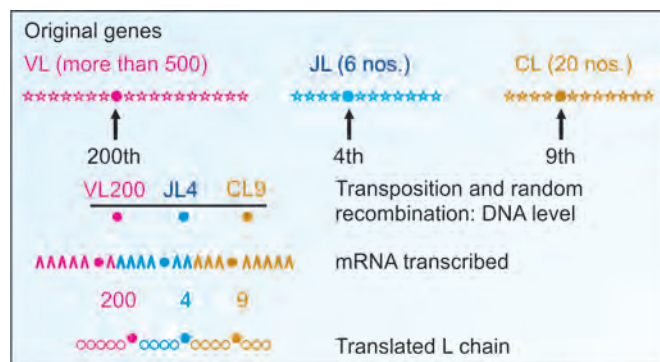


Fig. 55.6: Production of diversity in immunoglobulins

### Molecular Structure of Antigens

Blood groups of RBCs express more than 160 antigens. The most important of them is called ABO system. The RBC of the person may carry antigen A, B or AB; if none of these antigens are present, it belongs to blood group O. Group A person's serum contains anti-B antibody. Therefore, when RBCs of B group are introduced into the person having blood group A, there will be agglutination of the introduced cells. This is the basis of **blood transfusion**.

The ABO system antigens are glycoproteins present on surface of all cell membranes. The membrane surface will carry a protein into which oligosaccharide unit is attached. The H locus codes for fucosyl transferase, which adds fucose to a terminal galactose unit through alpha-1,2 linkage. This is the precursor for both A and B antigens.

Since "h" allele of H locus codes for an inactive fucosyl transferase, a person having "hh" combination will not produce the precursor; neither A nor B substances are added; hence the person's blood **group becomes O**.

Those individuals having Hh or HH allele combinations can produce precursor molecules. Such persons having **BB or BO alleles** will generate a specific transferase which adds a galactose unit to the fucose with alpha-1,3 glycosidic linkage.

Persons having **AA or AO alleles** can generate another transferase, which adds N-acetyl galactosamine to the fucose through alpha-1,3 glycosidic linkage. Thus the molecular difference between A group and B group is only with regard to the N-acetyl unit. The immunological system can differentiate even this minor alteration.

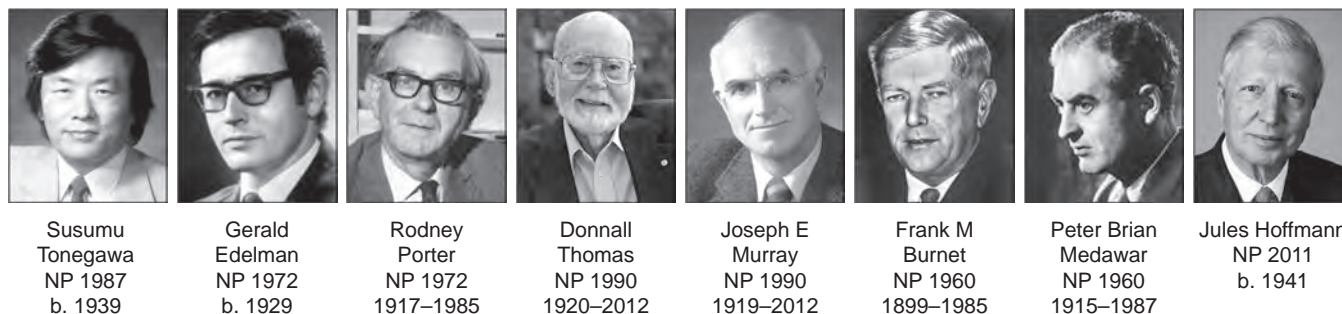
If the person is belonging to **AB group** both transferases are active and both antigens are produced. In persons lacking in A and B alleles, the transferases are absent; the oligosaccharide is ending with fucose unit and his blood group will be designated as O (see Chapter 11).

### T-Cell Receptors

The B-cells have immunoglobulins on their cell surface, which are involved in the antigen recognition by B cells. However, the T-cell receptors are more complex (Fig. 55.7). The receptor molecule is made of two polypeptide chains, alpha and beta, each with two immunoglobulin-like domains. The two chains are held together by one interchain disulfide bridge. Each chain has a transmembrane hydrophobic part, which anchors the polypeptide into the T-cell membrane. Both chains are glycosylated.

### HLA Antigens

The T-cell recognition is also closely related with the HLA (human leukocyte antigen) system. When organs are transplanted, the donor and



receiver are matched for HLA system. Joseph Murray did the first kidney transplantation in 1954 and Edward Thomas did the first bone marrow transplantation in 1956; both of them received Nobel prize in 1990. But Christian Bernard, who did the first heart transplantation in 1964, was omitted from the Nobel prize list. The genes of major histocompatibility complex (MHC) are involved in the recognition between self and non-self antigens. In human beings, the MHC genes are present on chromosome 6. There are A, C, B, D and DR loci. All these loci together contain more than 150 alleles. Permutation and combination of them could produce an astronomical number of variations. Hence, the antigenic constitution of one person will be entirely different from another one. These are main transplantation antigens, responsible for rejection of allograft. Frank Macfarlane Burnet and Peter Brian Medawar were awarded Nobel prize in 1960 for elucidation of basic rules in transplantation immunity and acquired immunological tolerance. Body will try to reject the transplanted organs. To reduce such rejection reactions, various immunosuppressive drugs are used. Basiliximab and daclizumab are monoclonal antibodies which will inhibit IL-2 on activated T cells.

### Soluble Factors

Soluble factors released by cells are known as **cytokines** in general. Cytokines are a unique family of growth factors. Factors produced by leukocytes are termed **interleukins**; those by myeloid cells are **monokines** and those produced by lymphocytes are called **lymphokines**. The lymphokines include the following:

### Interleukins (IL)

Many of the lymphokines are also known as **interleukins (ILs)**, since they are not only secreted by leukocytes but also able to affect the cellular responses of leukocytes. Specifically, interleukins are growth factors targeted to cells of hematopoietic origin. More than 30 interleukins are known, some important ones are listed in Table 55.4.

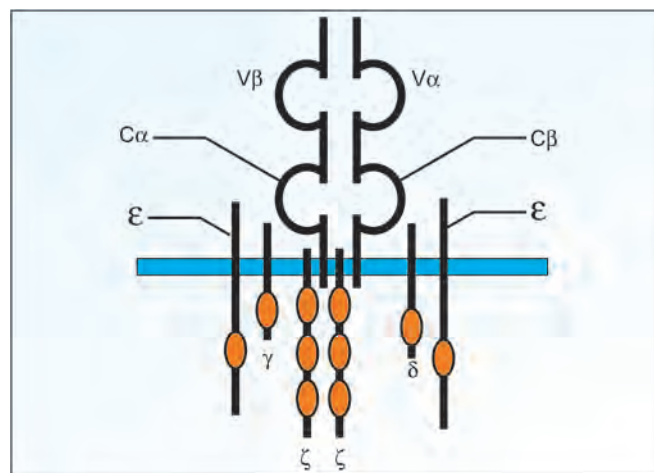


Fig. 55.7: Structure of T-cell receptor

TABLE 55.4: Lymphokines, interleukins and interferons

Name	Secreted by	Target cell / Function
IL - 1 $\alpha$ and $\beta$	Macrophages and other antigen presenting cells	Induces IL-2 receptors; induces acute phase proteins co-stimulation of APCs and T cells
IL-2	Activated T helper (Th1) cells	Maturation of T and NK cells into LAK (lymphokine activated killer) cells
IL-4	T helper (Th2) cells	B-cell proliferation, IgE expression on B cells
IL-6	Activated Th2 cells, hepatocytes and adipocytes	Acute phase response, B cell proliferation, synergistic with IL-1 and TNF on T cells
IL-8	Macrophages	Chemoattractant for neutrophils and T cells
IL-10	T suppressor (CD8+) cells	Inhibits cytokine production, suppresses cellular immunity
IL-15	Mononuclear phagocytes	Induces production of NK cells
IL-18	Macrophages	Increases NK cell activity, induces production of IFN gamma
IFN-alpha	Macrophages, neutrophils	Proliferation of macrophages and NK cells, antiviral effects
IFN-beta	Fibroblasts	Antiviral effects
IFN - gamma	Activated Th1 and NK cells	Differentiates cell lines, antiviral effects, activates macrophages, neutrophils, NK cells
C-reactive protein (CRP)	Hepatocytes, adipocytes	Level of CRP parallels inflammatory process in the body. Level is increased by IL-6. CRP enhances phagocytosis by macrophages; induces expression of various cell adhesion molecules, e.g. ICM, VCAM and selectins; attenuates NO production by downregulating NOS expression
TNF-alpha	Macrophages	Inflammation, fibrosis, pyrexia, acute phase proteins, necrosis
TNF-beta	T cells	Inflammation
G-CSF	Macrophages	Stem cell stimulation of granulocytes
GM-CSF	T cells and macrophages	Stem cell stimulation of granulocytes and macrophages
MIF	T cells	Activation and inhibition of mobility of macrophages

IL= Interleukin; IFN= Interferon; TNF= Tumor Necrosis Factor; G-CSF= Granulocyte Colony Stimulating Factor; GM-CSF = Granulocyte Macrophage Colony Stimulating Factor; MIF= Macrophage Migration Inhibition Factor.

They are a group of cytokines (signaling molecules) that were first seen to be expressed by white blood cells (leukocytes). The function of the immune system depends in a large part on *interleukins*, and rare deficiencies of a number of them have been described, all featuring autoimmune diseases or immune deficiency. The majority of interleukins are synthesized by helper CD4<sup>+</sup> T-lymphocytes, as well as through monocytes, macrophages, and endothelial cells. They promote the development and differentiation of T, B, and hematopoietic cells.

**IL-1:** The predominant function of IL-1 is to enhance the activation of T-cells in response to antigen. This leads to increased IL-2 and of the IL-2 receptor on T cells. IL-1 also induces expression of IFN-gamma by T-cells. There are 2 distinct IL-1 proteins, termed IL-1alpha and beta.

**IL-2** stimulates T cells and NK cells and differentiates them into effector cells capable of killing cancer cells. IL-2 is therefore useful to produce lymphokine-activated killer (**LAK**) cells. Lymphocytes cultured with cancer antigens and stimulated by IL-2 can act as specific (LAK) cells. Experimentally these LAK cells are being used as a form of immunotherapy in cancer patients with limited success.

**IL-6** is produced by macrophages, hepatocytes, adipocytes and activated T-helper cells. IL-6 is the primary inducer of the **acute-phase response** in liver. IL-6 also enhances the differentiation of B-cells and their consequent production of immunoglobulin. Glucocorticoid synthesis is also enhanced by IL-6.

**IL-8** is an interleukin has chemoattractant activity to leukocytes and fibroblasts. Such chemoattractive proteins are termed **chemokines**. IL-8 is produced by monocytes, neutrophils, and NK cells and is chemoattractant for neutrophils, basophils and T-cells.

### Interferons (IFN)

Interferons (alpha, beta, gamma) are proteins made and released by the cells of most vertebrates in response to the presence of pathogens — such as viruses, bacteria, or parasites — or tumor cells. They allow communication between cells to trigger the protective defenses of the immune system that eradicate pathogens or tumors. IFNs belong to the large class of glycoproteins known as cytokines. Although they are named after their ability to “interfere” with viral replication within host cells, IFNs have other functions: they activate immune cells, such as natural killer cells and macrophages; they increase recognition of infection or tumor cells by up-regulating antigen presentation to T-lymphocytes; and they increase the ability of uninfected host cells to resist new infection by virus. Certain host symptoms, such as aching muscles and fever, are related to the production of IFNs during infection. About ten distinct IFNs have been identified in mammals; seven of these have been described for humans. They are typically divided among three IFN classes: Type I IFN, Type II IFN, and Type III IFN. IFNs belonging to all IFN classes are very important for fighting viral infections. All interferons share several common effects; they are antiviral agents and can fight tumors. Another function of interferon is to upregulate major histocompatibility complex molecules, MHC I and MHC II, and increase immunoproteasome activity. The immune effects of interferons have been exploited to treat several diseases, e.g. actinic keratosis, superficial basal cell carcinoma, papilloma and external genital warts. Synthetic IFNs are also made, and administered as antiviral, antiseptic and anticarcinogenic drugs, and to treat some autoimmune diseases. Interferon beta-1a and interferon beta-1b are used to treat and control multiple sclerosis. This treatment is effective

for slowing disease progression and activity in relapsing-remitting multiple sclerosis and reducing attacks in secondary progressive multiple sclerosis. Interferon therapy is used (in combination with chemotherapy and radiation) as a treatment for many cancers. This treatment is most effective for treating hematological malignancy; leukemia and lymphomas including hairy cell leukemia, chronic myeloid leukemia, nodular lymphoma, cutaneous T-cell lymphoma. Patients with recurrent melanomas receive recombinant IFN- $\alpha$ 2b. Both hepatitis B and hepatitis C are treated with IFN- $\alpha$ , often in combination with other antiviral drugs.

### Cytokines

They are a) messenger molecules that can communicate signals from one cell type to another; b) soluble mediators of inflammatory immune response; c) low molecular weight proteins with a cellular regulatory action produced by different cells and operating preferentially in the immuno-inflammatory response and d) effectors that instruct the receiving cells to proliferate, differentiate and secrete additional cytokines.

Based on their main function, cytokines may be classified into:

- i. **Colony stimulating factors/hematopoietins** that mediate the development and differentiation of immune cells from bone marrow precursors.
- ii. **Interferons (IFN)** produced by T cells have antiviral activity since they interfere with viral replication in cells and regulate the immune response. IFN gamma also activates the macrophages also upon entry of bacterial and viral pathogens into host cells.
- iii. **Interleukins (IL)** (about 30 in number in all) regulate innate and adaptive immune response by information transfer among different types of leukocytes.
- iv. **Tumor necrosis factors (TNF)** are a mixed group of cytokines that have activity towards transferred cell types that are proinflammatory. They also stimulate osteoclasts and bone resorption.
- v. **Chemokines** are cytokines that bring about chemokinesis movement in response to chemical stimuli.

### Cytokine Receptors

The receptors exist as hetero oligomeric complexes with 2 or more different receptor subunits. Binding of cytokine requires interaction with at least 2 receptor subunits. The amino terminal extracellular domain has the binding site for cytokines. The cytokine binding triggers conformational change in the intracellular domain of the receptor subunits. This would facilitate their rapid association with other intracellular signal transducing enzymes. There are six major cytokine receptor families based on the structural conformation.

- i. Hematopoietic receptors. Responsible for cytokine binding and a shared ‘c’ chain for signal transduction.
- ii. Interferon receptors. In addition to INF alpha, beta and gamma, this group includes the IL 10 receptor.
- iii. TNF receptors: For example, receptors of TNF, LT, NGF and TRAIL.
- iv. Chemokine receptors: These are G protein coupled receptors. They have the common property of promoting chemotaxis when chemokines bind. They can bind multiple cytokines.
- v. TGF receptor: Cytoplasmic signaling domains with Ser/Thr kinase activity.



- vi. IgSF cytokine receptors including those of IL1, M-CSF and stem cell factor receptors.

### Granulocyte Colony Stimulating Factor

Granulocyte colony stimulating factor (GCSF) is also known as colony-stimulating factor 3 (CSF 3). It is a glycoprotein, growth factor or cytokine produced by different tissues. GCSF then stimulates the bone marrow to release them into the blood. It also stimulates the survival, proliferation, differentiation and function of neutrophil precursors. The GCSF-receptor is present on precursor cells in the bone marrow, and, in response to stimulation by GCSF, initiates proliferation and differentiation into mature granulocytes. GCSF can also act on neuronal cells as a neurotrophic factor. Indeed, its receptor is expressed by neurons in the brain and spinal cord. The action of GCSF in the central nervous system is to induce neurogenesis, to increase the neuroplasticity and to counteract apoptosis. These properties are currently under investigations for the development of treatments of neurological diseases such as cerebral ischemia. A recombinant GCSF is used in cancer patients to accelerate recovery from neutropenia after chemotherapy, allowing higher-intensity treatment regimens.

### Granulocyte Macrophage Colony Stimulating Factor

Granulocyte macrophage colony stimulating factor (GMCSF) is a protein secreted by macrophages, T cells, mast cells, endothelial cells and fibroblasts. GMCSF is a cytokine that functions as a white blood cell growth factor. GMCSF stimulates stem cells to produce granulocytes (neutrophils, eosinophils, and basophils) and monocytes. Monocytes exit the circulation and migrate into tissue, whereupon they mature into macrophages. Activation of a small number of macrophages can rapidly lead to an increase in their numbers, a process crucial for fighting infection. GMCSF is used as a medication to stimulate the production of white blood cells following chemotherapy. It has also recently been evaluated in clinical trials for its potential as an adjuvant in HIV-infected patients.

### Macrophage Colony Stimulating Factor (MCSF)

A cytokine which influences hemopoietic stem cells to differentiate into macrophages. MCSF also helps to combat intercellular viral infection. It may also be involved in development of the placenta.

### Macrophage Inflammatory Proteins (MIP)

These belong to the family of chemotactic cytokines known as chemokines. In humans, there are two major forms, MIP-1alpha and MIP-1beta, that are now officially named CCL3 and CCL4 respectively. Both are major factors produced by macrophages after they are stimulated with bacterial endotoxins. They activate human granulocytes (neutrophils, eosinophils and basophils) and induce the synthesis and release of other pro-inflammatory cytokines such as interleukin 1 (IL-1), IL-6 and TNF-alpha from fibroblasts and macrophages.

### Macrophage Migration Inhibition Factor

The MIF helps the accumulation of macrophages at the site of reaction. The resulting erythema and induration form the basis of skin tests. Details of such cytokines are given in Table 55.4.

### Monocyte Chemotactic Protein-1 (MCP1)

Also known as **Chemokine C-C Motif Ligand 2 (CCL2)**. It is a cytokine belonging to the CC chemokine family. CCL2 recruits monocytes, memory T cells, and dendritic cells to sites of tissue injury and infection. In the bone, CCL2 is expressed by mature osteoclasts and osteoblasts and is under the control of NFκB. CCL2 causes the degranulation of basophils and mast cells, an effect potentiated by pre-treatment with IL-3 and other cytokines.

### Tumor Necrosis Factor-alpha (TNF-α)

It is produced by activated macrophages. It induces the expression of other autocrine growth factors, increases cellular responsiveness to growth factors and induces signaling pathways that lead to proliferation. Like other growth factors, TNF-α induces expression of a number of nuclear proto-oncogenes as well as of several interleukins.

### Tumor Necrosis Factor-beta (TNF-β)

It is produced by cytotoxic T-lymphocytes (CTL cells). It is characterized by its ability to kill a number of different cell types, as well as inhibition of lipoprotein lipase present on the surface of vascular endothelial cells.

### Anti-TNF Therapy

**Etanercept, infliximab and adalimumab** are three *anti-TNF* medications. Adalimumab was constructed from a fully human monoclonal antibody, while infliximab is a mouse-human chimeric antibody and etanercept is a TNF receptor-IgG fusion protein. Etanercept is a drug that inhibits TNF and is therefore useful to treat autoimmune diseases like rheumatoid arthritis, psoriatic arthritis, plaque psoriasis and ankylosing spondylitis. Etanercept is a fusion protein “fusing” TNF receptor to IgG1. Infliximab is used to treat autoimmune diseases like psoriasis, Crohn’s disease, ankylosing spondylitis, rheumatoid arthritis and ulcerative colitis.

### Related Topics

Gut derived factors are described in Chapter 54; adipocytokines in Chapter 40. Hybridoma technique to produce monoclonal antibody is described in Chapter 49. GCSF, GMCSF, ICAM, Interferons, MCSF, MIP, MCP, PDGF, Selectin, TGF, VCAM and VEGF are described in Chapter 60.

## Clinical Case Study 55.1

A 45-year-old man presented with severe back pain and weakness. He had lost 7 kg in the last 3 months. Loss of appetite is present. No history of fever. He reports extreme fatigue, body pain and complains that he is unable to do any work. X-ray of skull revealed punched out lesions. Bone marrow biopsy was done and it showed plasma cells in excess. Serum electrophoresis was ordered on the basis of clinical features. It showed an abnormal band between β globulin and γ globulin. Urine was positive for Bence-Jones Proteins (BJP). What is the probable diagnosis? What is the significance of laboratory findings in this patient?

## Clinical Case Study 55.2

A 70-year-old man with benign prostatic hyperplasia was admitted for pain in left hip. He also complained of fatigue, weakness. Physical examination revealed lymphadenopathy and hepatosplenomegaly. A hip X-ray revealed a large osteolytic lesion in the left greater trochanter, and a bone scintigraphy evaluation showed increased activity in the same area. Metastasis from prostate carcinoma was suspected, and bone biopsies were performed. Ten days later, the patient was hospitalized in emergency department after a fall that fractured the femoral neck. At admission, plasma sodium, chloride, and potassium concentrations were all within their respective reference intervals. The plasma concentration of total protein was 5.0 g/dL, and that of albumin was 1.5 g/dL. Hematology tests showed normocytic anemia, low hemoglobin level and leukopenia. Urine protein was 540 mg/24 h (reference interval, 0–30 mg/24 h). Urine protein electrophoresis showed the presence of an unusual spike in the  $\beta$  region (Fig. 55.8). Immunoglobulin quantification revealed an increased IgG value 2950 mg/dL [reference interval, 700–1000 mg/dL]. IgA and IgM were within their respective reference intervals.

Serum protein electrophoresis (SPEP) showed an increased  $\alpha_1$  region, along with decreased albumin and regions and an increased  $\beta$  region, along with a loss of separation between the  $\beta_1$  and  $\beta_2$  regions because of a narrow spike (Fig. 55.9). What is the most probable diagnosis? What are the potential causes of increased

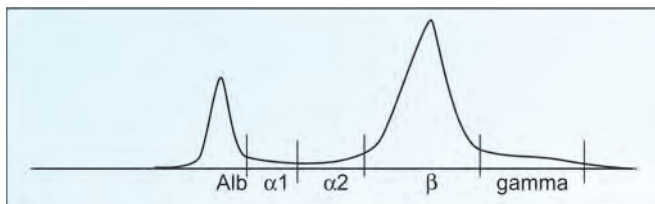


Fig. 55.8: Protein electrophoresis of concentrated urine sample; presence of a spike in the beta region

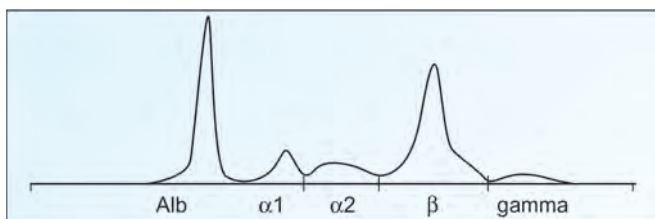


Fig. 55.9: Serum protein electrophoresis showed a spike in the beta region

$\beta$ -globulins? What investigations should be performed to characterize the protein responsible for the spike in the  $\beta$  region of the Urine?

## Clinical Case Study 55.1 Answer

The patient is suffering from multiple myeloma. Multiple myeloma represents a malignant proliferation of plasma cells, from a single clone of cells. Multiple myeloma can produce varied symptoms including bone pain or fracture, soft tissue masses, lytic lesions in the skeleton, renal failure, spinal cord compression, susceptibility to infections, anemia, leukopenia, thrombocytopenia, hypercalcemia, occasionally clotting abnormalities, neurological problems, manifestations of hyperviscosity, amyloidosis, etc.

The classic triad of multiple myeloma is marrow plasmacytosis (>10%), lytic bone lesions and serum and/or urine M component. Diagnosis is confirmed by; (1) Electrophoresis—Monoclonal antibodies seen as M band (myeloma band) are seen as a sharp spike, (2) Bone marrow shows a large number of malignant plasma cells, (3) X-ray skull shows punched out lesions, (4) Hypercalcemia and hypercalciuria are seen, (5) Proteinuria is seen as a rule and in 20% of patients it is seen as Bence-Jones protein which is excreted in urine, (6)  $\beta_2$  microglobulin is increased in patients with renal failure, (7) Serum free light chains—These are superior to urine tests and are detected in multiple myeloma and related plasma cell dyscrasias.

In most patients with multiple myeloma, myeloma cells also secrete excessive amounts of light chains of Ig. The excess light chains are either k or l. Sometimes they are excreted as a dimer. In normal conditions, they are not excreted in urine. Free light chains can also be detected in serum. They are also present as k or l; their ratio is also sometimes measured.

## Clinical Case Study 55.2 Answer

Fibrinogen (found with or incomplete blood clotting) and hemoglobin (no hemolysis in the sample) are the most common confounding factors leading to apparent monoclonal peaks in the  $\beta$ -globulin region of an electrophoresis analysis. Further, serum immunofixation electrophoresis revealed the presence of a monoclonal gamma band with no corresponding light chain. This finding is consistent with the diagnosis of gamma-heavy chain disease (GHCD). HCD is a proliferative B-cell disorder characterized by the production of monoclonal proteins with incomplete

heavy chain components and without associated light chains. Fatigue, weakness, and lymphadenopathy are the most frequent initial symptoms, and hepatosplenomegaly are the most common physical findings, which are often accompanied by anemia. GHCD can also be associated with other lymphoproliferative diseases or autoimmune disorders. Patient's hip pain, subsequent fractured femur neck and associated proteinuria and anemia suggested a gammopathy. A monoclonal peak with  $\beta$  mobility was present in both serum and urine electrophoresis.

### QUICK LOOK OF CHAPTER 55

1. Immune response could be cell mediated (by T cells), or humoral (by B cells/Plasma cells). Other immunological effector mechanisms include antibody dependent cell mediated immunity, natural killer cells and macrophages.
2. Immunoglobulins (Ig) are made up of 2 heavy chains and 2 light chains combined through disulphide bridges. Base on heavy chains, Igs are of 5 classes; IgG, IgM, IgA, IgD, IgE.
3. The light chains are either lambda or kappa.
4. The antigen-binding region of the Ig is the Fab portion (2 in number). The rest of the molecule is the Fc portion. IgG, the major antibody of secondary immune response forms about 75–80% of the total Igs. They can cross the placenta and is responsible for Rh isoimmunization.
5. IgM are macroglobulins; a pentameric structure joined by J chains and are the predominant class of antibody in primary response. Natural antibodies are of IgM type.
6. IgA are secretory dimeric antibodies seen in mucus secretions in the body.
7. IgE are cytophilic antibodies responsible for mediating allergic reaction, hypersensitivity and anaphylaxis.
8. Malignancy of Ig secreting plasma cells leads to enormous proliferation of one clone and result in multiple myeloma where monoclonal M band is seen in electrophoresis. In Bence Jones proteinuria, there is monoclonal light chain excretion in urine. BJ proteins precipitates at 45 – 60°C and redissolve at > 80°C. In heavy chain defective diseases, heavy chains are excreted in urine.
9. Hyper gamma globulinemia occurs in chronic infections, autoimmune disorders and paraproteinemias, while, hypogammaglobulinemia may be congenital X linked disorder or secondary to other diseases.

# CHAPTER 56

## Biochemistry of AIDS and HIV

### Chapter at a Glance

The reader will be able to answer questions on the following topics:

- Acquired immunodeficiency syndrome (AIDS)
- Human immunodeficiency virus (HIV)
- Immunology of AIDS
- Laboratory analysis of AIDS

### Epidemic of AIDS

Towards the end of the 20th century, medical science was able to control and even conquer many of the previously incurable diseases. But AIDS has now become a disease of pandemic proportions. By the end of 2011, about 34 million HIV seropositive individuals were living in the world, which included 3.5 million children. Every minute, around 12 people become newly infected with HIV.

In 1981, a cluster of 5 cases of *Pneumocystis carinii* pneumonia were reported in USA. These protozoa can produce pneumonia only in immunodeficient individuals. Based on the clinical manifestations, the disease was named as **acquired immunodeficiency syndrome** with acronym of AIDS. In 1983, Françoise Barré-Sinoussi (Nobel prize, 2008) showed that

the disease is due to a retrovirus (virus having reverse transcriptase enzyme). The isolation of a virus from the lymphocytes of the AIDS patients was done in 1984 independently by Robert Gallo at the National Institute of Health, USA and Luc Montagnier at the Pasteur Institute, Paris. The latter was awarded Nobel prize in 2008. The virus was originally designated as HTLV-III (human T cell leukemia virus). In 1986, it was redesignated as HIV (human immunodeficiency virus). By retrospective analysis, it was inferred that the human pandemic started in Africa by around 1970, and that a simian virus transformed into HIV by around 1700.

### The Indian Scenario

The virus entered in India in 1980. From 1986 onwards, the Indian Council of Medical Research has started the serosurveillance against HIV. The first seropositive individuals in India were identified in 1986. The Government of India has established the National AIDS Control Organization (NACO) in July 1992 for the prevention of AIDS. **The adult HIV prevalence in India is declined from 0.41% in 2000 to 0.31% in 2010.** India has the third largest number of HIV infected people, with an estimated 2.4 million people infected.

### Transmission

1. About 80% of the total patients got the infection as a sexually transmitted disease.



Robert Charles Gallo  
b. 1937



Luc Montagnier  
NP 2008  
b. 1932



Françoise Barré-Sinoussi  
NP 2008  
b. 1947



- In about 15% of patients, the disease was transmitted through blood. The drug abusers usually use the same needle without any sterilization for intravenous injection. The risk of getting HIV is high in patients who receive blood transfusion many times, e.g. hemophilia patients.
- In the remaining 5% cases, virus may be transmitted from mother to fetus through placenta. About 30% of infants born to HIV positive mothers may get the infection.

## Natural Course of the Disease

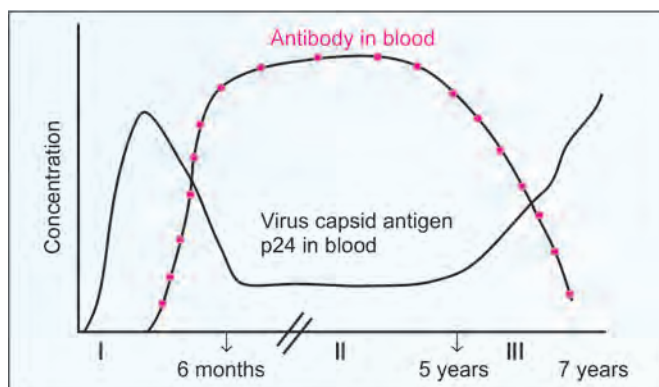
### Window Period

When the virus enters the body, it is multiplied in the body cells, but it cannot be detected easily. This is called the window period (Fig. 56.1). The viral capsid antigen p24 can be detected in the blood during this time.

### Seropositive Stage

After a few months, antibodies are seen in circulation. This is called **seropositivity** (Fig. 56.1). During this period, the person is completely normal. However, this person is a **carrier** of the disease, and can transmit the disease to others. About 10% of seropositive individuals progress to the 3rd stage of AIDS within 5 years, 50% within 10 years and 90% within 15 years if no proper treatment is given.

For each AIDS patient, there are 100 seropositive persons in the general population.



**Fig. 56.1:** Course of HIV infection; I = window period; II = seropositive period; III = AIDS disease. Black line is antigen in blood; Red dots indicate antibody response

## AIDS Disease

The third stage is when the clinical manifestations start. By this time, the immune status of the individual is depressed. Therefore, commensal microbes will start multiplication inside the body. Patient usually succumbs to death within about 2 years after entering this stage. HIV infection can lead on to infection with other organisms; fungi like *Candida* and *Cryptococcus*, other viruses like cytomegalovirus and herpes simplex parasites like *Pneumocystis carinii*, as well as bacteria like *Mycobacterium* and *Salmonella*. Cancers associated with AIDS are Kaposi sarcoma and non-Hodgkin's lymphoma (NHL). Cognitive impairment due to meningitis, neuropathies and neuropsychiatric manifestations may occur later.

### Clinical Presentations

**Lymphadenopathy** and fever may be seen by the end of the second stage. The AIDS related symptoms (ARS) are wide. Since the immunity is deficient, nonpathogenic microorganisms enter into the body and produce lesions in skin, gastrointestinal tract, lungs, urinary tract and brain. Gastroenteritis and **tuberculosis** are the predominant pattern in India. In all the cases, there will be weight reduction.

### Laboratory Analysis

- The antibodies in the blood are detected by the ELISA test (see Chapter 35). ELISA positive blood is then confirmed with Western blot analysis (see Chapter 49). In ELISA, antibody against only one antigen (**gp 120**) is being tested; so there is probability of false results.
- In **Western blot** analysis, antibodies against 6 different components of the virus are analyzed; so it is confirmatory.
- T-helper count** is lowered. The normal level is more than 400 cumm. In AIDS patients, the level is always below 300. As the disease progresses, the helper cell count is correspondingly lowered.
- In the last stages, the antigen, especially, p24 starts to rise.
- By **real time PCR (RT-PCR)** (see Chapter 49), the number of HIV particles in blood can be estimated. A value of less than 5000 copies per mL of blood has good prognosis, while a count more than 1 lakh per mL means very bad prognosis.

- vi. **Nucleic acid testing (NAT)** involves amplification and detection of one or more specific target sequences located in specific HIV genes, GAG, POL and ENV. Detection limit is 200 to 400 copies per mL. By this test, window period is shortened to less than 2 weeks. Viral load is monitored during treatment by RT-PCR.

## THE HUMAN IMMUNODEFICIENCY VIRUS

### Structure

- i. HIV belongs to the **retrovirus** group. They are RNA-containing viruses that replicate with the help of the reverse transcriptase (RT) or RNA dependent DNA polymerase. A schematic representation of the structure of the virus is shown in Figure 56.2.
- ii. The virus has a cylindrical core, containing two copies of single stranded genomic RNA.
- iii. The protein components are named after its molecular weight. For example, protein having molecular weight 32,000 Daltons is called p32.
- iv. The core of the virus contains **reverse transcriptase** (p66 and p55), an endonuclease (p32), nucleocapsid protein (p9) and a protease (p10). The viral core is surrounded by the major capsid antigen (p24). The outer shell is composed of a myristoylated protein, the membrane antigen (p17).

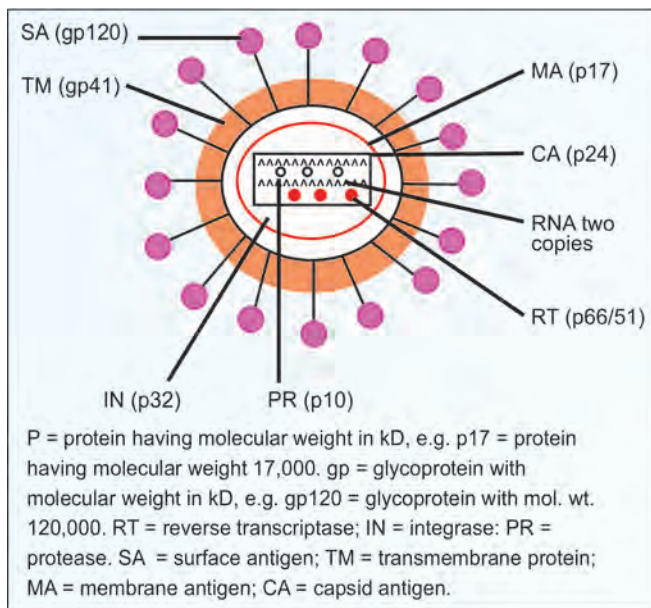


Fig. 56.2: Structure of HIV

### Virus Entry

- i. The binding of HIV with target cell is through a receptor mechanism. The **gp 120** of the virus envelope will specifically bind with CD4 molecule on the surface of target cells. Thus **CD4 acts as a receptor** for the virus.
- ii. The CD4 molecules are present on the surface of **T-helper cells** and therefore helper cells receive the maximum attack of HIV.
- iii. Macrophages, monocytes, Langerhans' cells, follicular dendritic cells and glial cells are also susceptible to HIV entry and propagation. Macrophages act as the reservoir of the virus.
- iv. HIV uses CD4 and chemokines as entry receptors. They are partitioned in lipid rafts. HIV binds to CD4 cell surface through gp120. The gp41 mediates fusion of the viral envelope with the plasma membrane of the target cell. Interaction with the chemokine coreceptors CCR5 and CXCR4 acts as the trigger for conformational changes in gp120 and gp41 that leads to virus entry.

### Replication of HIV

The virus has an extraordinary rate of replication; over 10 billion particles are produced per day inside the host. After entry, the viral RNA is acted upon by the **reverse transcriptase** (RT). Based on the RNA, a DNA strand with complementary sequence (minus strand) is produced. Then RNA strand is hydrolyzed by RNase-H. Keeping the DNA minus strand as the template, a complementary (plus strand) of DNA is synthesized. This DNA double strand (proviral DNA) migrates into the nucleus of the host cell. The viral DNA is then integrated into the host cell DNA by the action of the viral integrase (p32). Retroviruses do not replicate in nondividing cells. Similarly HIV also requires activation and division of T cells for the viral particle synthesis. The viral genes are transcribed and translated by the host cell mechanisms (Fig. 56.4).

### Assembly and Maturation of HIV

The products of gag and pol genes, proteins p55 and p160, the big precursor proteins are incorporated into the virus assembly. The cleavage pattern and mature forms are shown in Figure 56.3. This is then cleaved by host cell proteases into gp120 and gp41. These are then inserted to host cell membrane. Then the virions are evaginated out. During this process, part of the host membrane, along with gp120 and gp41 are added. The infected host cell lives only for a day and half (Fig. 56.4).

### HIV Genes

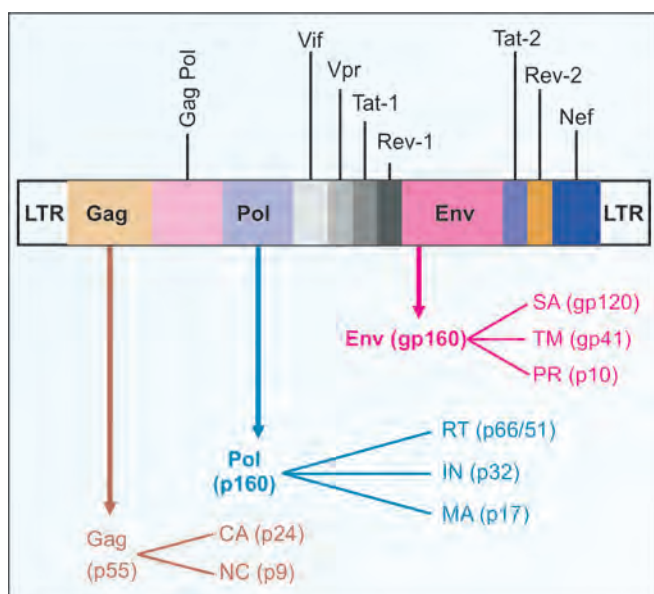
There are 3 structural genes (gag, pol and env), 3 regulatory genes (tat, rev and nef) and 5 accessory genes (vif, vpr, vpu, vpt and tev/tnv) in between *long terminal repeats* (LTR) (Fig. 56.3). The LTR contains transcriptional control elements. LTR is also useful for the integration of provirus into cellular genes.

An interesting finding is that gag and pol genes overlap by 241 nucleotides (Fig. 56.3). The transcription start signal as well as some direct control elements are in the LTR region. The positions of the other 3 regulatory genes (tat, rev and nef) are shown in Figure 56.3. The *enhancer element* is between -79 and -120 nucleotides. One factor, NFkB, released from the activated T cell, binds in this region, and then transcription is enhanced. In the resting T-cell, this factor is not available.

The **negative regulatory element (NRE)** is at -157 to -410 nucleotides. This generally inhibits the transcription. But a protein induced in activated T cells, designated as nuclear factor of activated T cells (NFAT-1) binds in this region, and the inhibition is removed.

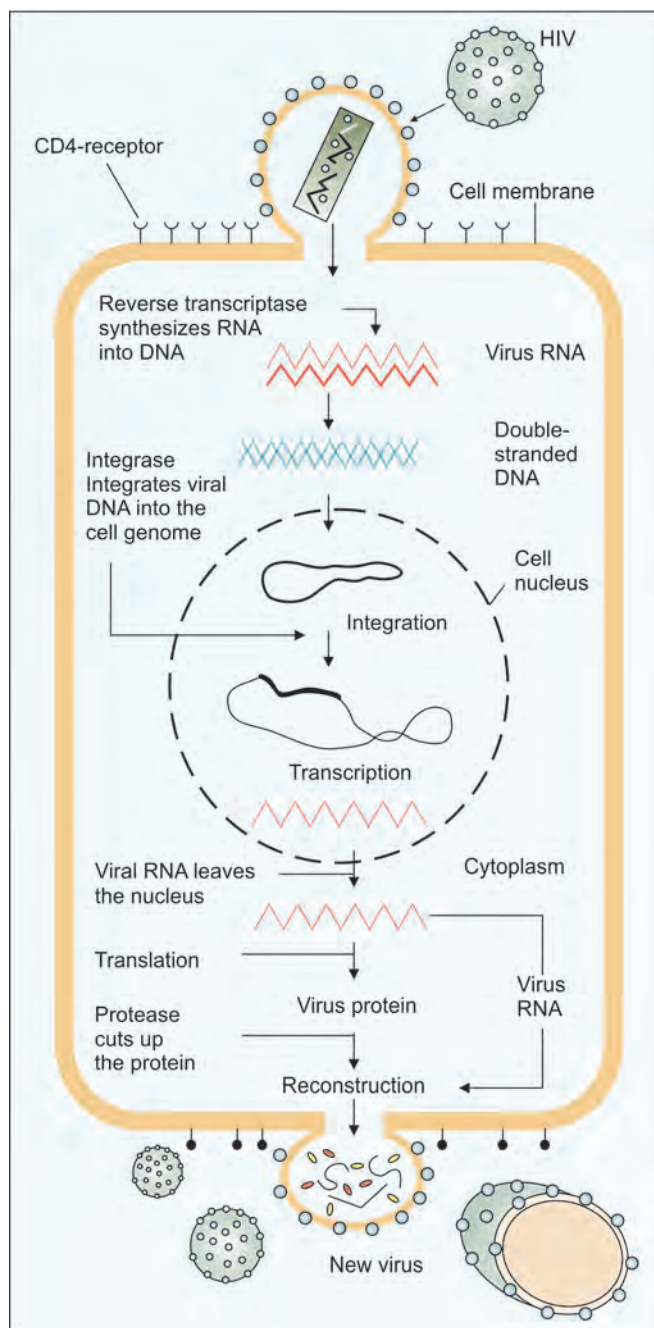
## Immunology of AIDS

- The CD4 (T-helper) lymphocytes are decreased in number, leading to immunodeficiency. The gp120 surface unit could specifically attach with CD4 molecule present on the surface of T-helper cells. Therefore, HIV preferentially enters into the T-helper cells and they are lysed.
- Macrophages and monocytes act as the reservoir of HIV infection, which disseminate the virus to various organs, including CNS. In turn, macrophage activity is also reduced.
- Since T-helper cells play a pivotal role in the immunological system, their deficiency will lead to suppression of almost all the immunological effectors.
- T-helper (CD4) count is less than 400 cumm of blood. T-killer cytotoxic activity is reduced.



**Fig. 56.3:** The genes and gene products of HIV. The nomenclature and abbreviations of the active proteins are given under the Figure 56.2

- Antibody response against a foreign antigen is poor. Lymphokines such as interferon, interleukin-2, etc. are lowered.
- When all the effector mechanisms of immunity are thus paralyzed, opportunistic pathogens get entry into the body.



**Fig. 56.4:** HIV replication cycle



## Immunoselection of Virus

In the early phase, the HIV enters macrophages through a **receptor** jointly made by **CD4 and CCR5** proteins on the surface of macrophages. The HIV surface antigen (gp120) has a perfect fit only for this type of receptors on the macrophage (M-tropic HIV). So in the early period, lymphocytes are spared. After a few years, gp120 is mutated, so that dual tropic viruses are produced. In the late phases of the diseases, T-tropic HIV are generated. By this time, all the gp120 molecules are mutated, such that they can fit only with T lymphocyte receptors made up of **CD4 and CXCR4** proteins. So T helper lymphocytes are preferentially killed leading to disease manifestations. Viruses that use only the CCR5 receptor are termed R5, those that only use CXCR4 are called X4, and those that use both, are named X4R5.

## Genetic Resistance

About 1% of population is resistant to HIV infection. CCR5 and CD4 proteins together form the receptors for HIV. Thus normal CCR5 gene allows the entry of HIV into macrophages. In contrast, in people having mutated CCR5 gene, the protein is not displayed on the macrophage surface. Without the CCR5 protein to latch onto, HIV fails to invade macrophages. Thus an individual with mutated CCR5 gene escapes the HIV infection.

## Genetic Heterogeneity of Virus

Two types, HIV-1 and HIV-2 are characterized; HIV-1 is more virulent, infective and predominant. It is seen all over the world. HIV-2 has lower infectivity and poor capacity for transmission and is largely seen to West Africa. In India, both types are reported. HIV-1 is related to viruses found in chimpanzees and HIV-2 is related to viruses found in sooty mangabeys. There are many subtypes of HIV-1. Different subtypes may be seen in the same patient. Out of the subtypes, HIV-1 M predominates (M stands for Major), which is responsible for the AIDS pandemic globally. Group M is further subdivided into sub-subtypes based on genetic sequence. 12 subtypes are known, out of which subtype C is the dominant form in South Africa, India and Nepal. Some of the subtypes are more virulent and resistant to presently available therapy. Moreover, each type exhibits remarkable micro-heterogeneity. There is high mutation rate in the virus. Such mutations accumulate to produce the various types, strains and microvariations. About 15% of amino acids in the envelope gp120 are highly variable. Therefore, the antigenicity of the virus also varies, and virus can escape from the immune attack.

## Prospects of a Vaccine

This hypervariability in the gp120 also makes it difficult to produce an effective vaccine. Trials are running with recombinant gp120 and gp160 vaccines. About 15 candidate vaccines are in the different stages of testing. But it may take few more years to perfect an efficient vaccine.

## ANTI-HIV DRUGS

- i. Reverse transcriptase (RT) inhibitors; nucleoside analogs: Dideoxy nucleosides are nucleosides, where oxygen is absent from both 2' and 3' positions of the ribose group. The DNA chain is produced by 3',5'-phosphodiester linkages. In the dideoxynucleoside, there is no hydroxyl group in the 3' position and hence chain is terminated. So, they inhibit RT of the HIV. The drugs licensed for clinical use are AZT (dideoxy thymidine, azidothymidine, Zidovudine); ddI (dideoxy inosine, didanosine, Zidanosine); ddC (dideoxy cytidine, Zalcitabine); d4T (Stavudine), 3TC (Lamivudine) and Abacavir.
- ii. RT inhibitors; non-nucleoside analogs: These agents bind to regions outside the active site of the HIV-RT, and make the enzyme inactive. Examples are Delavirdine, Nevirapine, Loviride and Efavirenz.
- iii. RT inhibitors; nucleotide analog: One example is Adefovir.
- iv. Protease inhibitors: They are extremely selective for HIV protease. So, they block final assembly and package of HIV particles. Examples include Saquinavir, Ritonavir, Indinavir and Nelfinavir.
- v. A combination of drugs (HAART, highly active anti-retroviral therapy) will reduce the virus load and prolong the life of the patient. At present, there is no absolute cure for HIV.
- vi. **RNA interference (RNAi)** was one of the breakthrough discoveries in the year 2002 for which Fire and Mello were awarded the Nobel Prize. It had so much potential as a therapeutic strategy that it is termed as "RNAissance". RNAi mediated gene silencing could be achieved by using synthetic siRNAs and shRNAs which are tailored by ribozymes. HIV was the first viral infection to be put under therapeutic trial, targeting viral genes or human receptor genes. Several trials are being held. Initial problems in targeted delivery systems have been overcome. The treatment modality can be successfully implemented once the final hurdles are overcome.
- vii. **Newer drugs**—Drugs which prevent the entry of HIV into cells: Fusion of HIV envelope with target cell membrane is crucial for the entry of virus into target cells. Gp 41 plays an important role and is now a therapeutic target. Specific functional regions of the gp41 (fusion peptide) FP, N and C terminal peptide repeats (NHR and CHR) can be inhibited to prevent the entry of HIV into cells. CCR5 co-receptor antagonists selectively bind to human chemokine receptor CCR5 present on cell membrane preventing the interaction of gp120 and CCR5.

## Prevention

Since there is no cure for AIDS, and vaccines are still decades away, public education and awareness are the only means to limit the spread of HIV infection. Since the major method of transmission is through sexual contact, avoidance of extramarital relationships will stop the spread. All the blood samples should be tested for the presence of HIV antibodies before transfusion. All surgical instruments should be properly sterilized. Disposable syringes and needles are to be used and destroyed immediately after use. Boiling for 10 minutes will inactivate the virus. Ordinary autoclaving at 120°C for 20 minutes is effective to sterilize instruments and gloves. Blood spills can be decontaminated by washing with 1% sodium hypochlorite solution, containing 10,000 ppm chlorine. Heat sensitive instruments may be decontaminated by immersing in 2%



glutaraldehyde (cidex) for 3 hours. Global strategy aims at reducing sexual transmission by half and eliminating vertical transmission. All new HIV infections are to be prevented and infected persons to get universal access to anti-retroviral therapy (ART).

### Clinical Case Study 56.1

A 32-year-old man presented with complaints of chills and breathing difficulty. He had lost 12 kg weight since last few months. On examination, he had multiple enlarged lymph nodes. Several nodules were present on the skin of chest and arms. Body temperature was 40°C, respiratory rate was 40 breaths/min and respiration was shallow. Chest radiograph showed diffuse pneumonia. What is the possible diagnosis? What are the laboratory tests to be done in this patient? What is the biochemical basis?

### Clinical Case Study 56.1 Answer

Patient is suffering from acquired immunodeficiency syndrome (AIDS); there is collapse of immune system leading to a series of viral, fungal and protozoal infection which are otherwise not seen. Kaposi's sarcoma and *Pneumocystis carinii* infection are typical features of HIV infection, but are rare in India.

Infection is transmitted when virus enters blood or tissue and comes in contact with suitable host cells, classically CD4 lymphocytes. Tissues and cells which are susceptible include B lymphocytes, monocytes, macrophages, specialized macrophages like alveolar macrophages in lungs, Langerhans cells in dermis, glial cells, microglial cells and follicular dendritic cells from tonsils.

Damage caused to CD4+ lymphocytes include (1) T4 cells decrease and T4: T8 ratio reverses, (2) decreased cytokines, (3) cell mediated immune system is dampened, (4) cell mediated and humoral immunity is affected, (5) AIDS patients are unable to respond to new antigens, (6)

there is polyclonal activation of B lymphocytes leading to hypergammaglobulinemia which are nonspecific, (7) monocyte macrophage system is depressed, (8) activity of NK cells and Tc (T cytotoxic) cells are affected, (9) all these features lead to decreased immunity and patient becomes susceptible to life-threatening opportunistic infections and malignancies.

Laboratory tests include; (1) Total leukocyte and lymphocyte count—Decreased, (2) T cell subset assays—Absolute CD4+ count < 200, T4:T8 count reversed, (3) Platelet count—Decreased, (4) IgA and IgG—Increased, (5) Diminished cell mediated immunity as evidenced by skin tests, (6) Lymph node biopsy, (7) Demonstration of p24 antigen (p24 capture ELISA assay), (8) Screening tests—include ELISA, rapid tests (Dot blot assay, particle agglutination tests and simple tests based on ELISA), (9) Supplemental tests—Western blot, indirect immunofluorescence test, radio and (10) Demonstration of viral nucleic acid—by PCR and RT-PCR.

### QUICK LOOK OF CHAPTER 56

1. Upon entry of the human immunodeficiency virus (HIV), it multiplies within the cells and cannot be detected easily in this period. This is called 'window period'.
2. Seropositivity indicates presence of antibodies against the viral antigen.
3. This may also be regarded as the carrier state of the disease.
4. Laboratory investigation for the presence of HIV are ELISA to detect presence of gp120, Western blot to detect the presence of six components of the virus. RTPCR is used to estimate viral load.
5. The CD4 present on the T helper cells acts as a receptor for the virus.
6. Hypervariability of gp120 makes it difficult to develop a vaccine against HIV.

# CHAPTER 57

## Biochemistry of Cancer

### Chapter at a Glance

The reader will be able to answer questions on the following topics:

- Mutagens and carcinogens
- Oncogenic viruses
- Oncogenes and oncosuppressor genes
- Oncofetal antigens
- Tumor markers
- Anticancer drugs
- Tumor immunology

The term “cancer” is derived from Latin word “cancrum” or Greek “karkinoma”, that is equivalent to Sanskrit term “karkitakam”, which means “crab”. The disease is so called because of swollen veins around the area, resemble a crab’s limbs. Indian Medical Science had identified cancer, gave the name “arbuda”, which literally means the number  $10^8$ , identifying the extreme cellularity of the cancer tissue. The International Union Against Cancer (UICC; Union Internationale Contre le Cancer) has defined cancer as a disturbance of growth characterized by excessive proliferation of cells without apparent relation to the physiological demands of the organs involved. Oncology deals with the etiology, diagnosis, treatment, prevention and research aspects of cancer.

### Etiology of Cancer

All cancers are multifactorial in origin. They include genetic, hormonal, metabolic, physical, chemical and environmental factors. Most human cancers are spontaneous.

All cancers originate usually from one aberrant cell, which goes on to multiply and produce a tumor mass. One mutation occurs out of  $10^6$  cell divisions. By the time a person reaches adulthood, about  $10^{26}$  cell divisions have occurred. Thanks to the surveillance by the immune system, these aberrant cells are usually destroyed. As age advances, the number of mutations accumulate, hence the statistical

probability of the incidence of cancer is increased. No wonder, cancer is a disease of old age, especially after 60 years.

Cancer is the second most common cause for death in developed countries, second only to cardiovascular diseases. When the average life-expectancy is less, as in the case of India, the death due to cancer is also low. Table 57.1 shows the incidence of cancer in different organs. The figures are compiled from WHO and ICMR publications. Oral cavity and upper gastrointestinal tract are the organs where cancer occurs most often in India. On the other hand, lungs and colon are the common sites for cancer in Western countries.

### Mutagens

Any substance which increases the rate of mutation can also enhance the rate of incidence of cancer. Therefore, all carcinogens are mutagens. Examples are X-rays, gamma-rays, ultraviolet rays. Some human cancers are caused by chemicals. These may be introduced into the body by means of (a) occupation (aniline, asbestos), (b) diet (aflatoxins) or (c) lifestyle (smoking). Chemical carcinogens act cumulatively. Tobacco, food additives, coloring agents, and aflatoxins are common carcinogens in our environment.

Thousands of chemicals are known mutagens and carcinogens. A selected small list of chemical carcinogens is

given in Table 57.2 and Figure 57.1. **Methyl cholanthrene** is a powerful carcinogen, only nanograms are sufficient to produce a tumor in a mouse (Figs 57.1 and 57.2).

## Aflatoxins

They are a group of chemically related compounds synthesized by the fungi, *Aspergillus flavus*. The mould grows on rice, wheat and groundnut, when kept in damp conditions. The fungi may grow in cattle fodder, which may enter into human body through the cow's milk. Aflatoxins are powerful carcinogens, which produce hepatomas (Fig. 57.1).

## Cigarette

Lung cancer is associated with the habit of cigarette smoking. Cigarette contains many carcinogens, the most important group being benzo(a)pyrenes. Other important deleterious substances in cigarette smoke are nicotine, carbon monoxide, nitrogen dioxide and carbon soot. Statistically, it is estimated that one cigarette reduces 10 minutes from the lifespan of the individual. The incidence of lung cancer is increased to 15 times more in persons smoking 10 cigarettes per day and 40 times more when smoking 20 cigarettes per day. Thus, WHO suggested the

slogan 'Cigarette smoke is injurious to health'. Moreover, non-smoking spouse of a heavy smoker will have 5 times more probability to get lung cancer than a non-smoker. This effect of '**passive smoking**' made the International Union against Cancer (UICC) to change the slogan to 'Your smoking is injurious to our health'.

Oral cancer is strongly associated with chewing of **tobacco**. Oral cancer constitutes 20% of all cancers seen in India, whereas it is less than 1% in Western countries.

**Alcohol** intake increases the risk of oral, pharyngeal, esophageal and liver cancers. Diet high in **total fat** and cholesterol, increases the risk of colon, breast and prostate cancers.

An often asked question is, why only some smokers are getting cancer and not all smokers? **Glutathione-S-transferase (GST)** is involved in the detoxification of various carcinogens, including cigarette smoke. About 5% of population are lacking in GST. Smokers who are devoid of GST are more prone to develop lung cancer. There are 3 different genes and 3 iso-enzymes for GST.

## Promoters of Cancer

Most carcinogens require promoters for the production of a cancer. Benzopyrene applied on skin does not produce cancer. Croton oil application also does not lead to skin cancer. But when benzopyrene application is followed by croton oil, tumor is developed. In this case, croton oil is termed as the promoter. The active agent in croton oil is a phorbol ester, tetradecanoyl phorbol acetate (TPA). It activates protein kinase-C.

TABLE 57.1: Incidence of common neoplasms					
		In India		In developed countries	
Cancers in Male					
	Oral	30%	Lung		30%
	Pharynx	10%	Colon and rectum		25%
	Esophagus	6%	Oral		2%
Cancers in Female					
	Cervix	30%	Breast		20%
	Oral	18%	Colon and rectum		25%
	Breast	16%	Cervix		10%

TABLE 57.2: Some chemical carcinogens		
Polycyclic aromatic hydrocarbons	—	Benzopyrenes, Cholanthrenes, Dimethyl benzanthracene (DMBA)
Aromatic amines	—	N-Methyl-4-aminoazobenzene (MAB)
Nitroso compounds	—	Dimethyl nitrosamine
Natural compounds	—	Aflatoxins

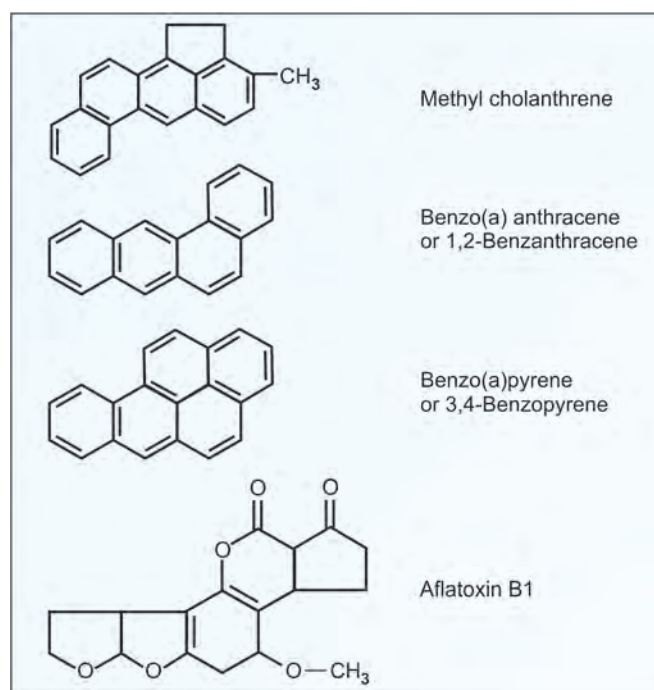


Fig. 57.1: Powerful chemical carcinogens

This results in phosphorylation of membrane proteins, leading to the triggering of malignancy. The carcinogen produces a mutation, but the promoter gives the drive for unchecked cell division.

### Progression

The biological history of a tumor shows progression of malignancy. Cells with faster growth rate have a selection advantage. Thus, cells with increased malignant character are progressively selected. **Familial adenomatous polyposis** is a typical example for **multistep progression**. Mutations in the APC gene are inherited from parents. By the time the patient becomes adult, there will be different dysplastic aberrant crypts in the large intestine. Some of the cells will get somatic mutations in the *K-Ras* gene; these will progress to form adenomas. Further mutation in *TGF* gene or *p53* gene or *Bax* gene will give the push for the development of malignancy.

### Action of Chemical Carcinogens

Chemical carcinogens are usually ingested as **procarcinogens**. They are metabolised in the body, usually in liver, to become the active carcinogen, e.g. 2-acetyl amino fluorene (AAF) when ingested, is metabolized to produce the ultimate carcinogen, sulfate ester of N-hydroxy-AAF. The enzymes responsible for the activation of procarcinogens are cytochrome P-450 system (Chapter 41). On the other hand, **direct carcinogens** are the ones which interact directly with the target molecules, e.g. methyl cholanthrene.

Mechanisms of action of chemical carcinogens are: (a) Carcinogens are generally electrophiles (molecules deficient in electrons); they readily attack nucleophilic (electron rich) groups of DNA, (b) Carcinogens may bind covalently to cellular DNA. N2, N3, and N7 atoms of guanine are highly prone to addition of carcinogen groups, (c) These changes will lead to DNA alterations, in spite of DNA repair, with increased probability of mutations. Chemical carcinogens may produce the cancer: (a) At the site of exposure, e.g. buccal cancer in tobacco chewers, skin cancer in tar workers, (b) At the site of metabolism, e.g. liver cancer produced by aflatoxin, (c) At the site of elimination, e.g. bladder cancer in persons working with aromatic dyes.



**Fig. 57.2:** Solid tumor in a mouse induced by injection of methyl cholanthrene (from author's laboratory)

### Physical Carcinogens

X-ray, gamma-ray and UV-ray may cause: (a) formation of pyrimidine dimers, (b) apurinic sites with consequent break in DNA, and (c) formation of free radicals and superoxides which cause DNA break, leading to somatic mutations. Exposure of X-ray in fetal life will increase the risk of leukemia in childhood. In population studies, 1 rad per year will increase the cancer incidence by 40/million people per year.

### Antimutagens

- i. These are substances which will interfere with tumor promotion. **Vitamin A** and carotenoids are shown to reverse precancerous conditions.
- ii. **Vitamin E** acts as an antioxidant, preventing the damage made by free radicals and superoxides.
- iii. **Vitamin C** regularly given to persons working with aniline prevented the production of new cancer cases.
- iv. Tubers, beans and leafy **vegetables** are shown to interrupt tumor promotion.
- v. **Curcumin**, the yellow substance in Turmeric is known to prevent mutations.
- vi. The beneficial effect of the fiber content of the diet is described in Chapter 40. Low protein, low fat, diet decreases the risk of cancer in animal studies.
- vii. Flavinoids are phytochemicals that possess antimutagenic properties. Phenolic compounds found in fruits like grapes, strawberries, walnuts, etc. are found to be antimutagenic. Green tea is shown to be effective against smoke induced mutations. Yeast cell wall polysaccharides like beta glycan inhibits lipid peroxidation and protects DNA from oxidative damage (Box. 57.1).

## ONCOGENIC VIRUSES

Another etiological factor of carcinogenesis is the integration of viral genes into the host DNA. This is diagrammatically represented in Figure 57.5. The circularization of virus DNA will help in this process. Thus, the virus genes become part and parcel of the cellular DNA. The drive for multiplication by the virus genome overrules the regulatory checks and balances of the cellular mechanism. So, there is uncontrolled



Ludwik  
Gross  
1904–1999



Denis  
Burkitt  
1911–1993



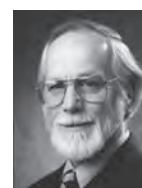
Jozsef  
Marek  
1868–1952



Peyton  
Rous  
NP 1966  
1879–1970



Renato  
Dulbecco  
NP 1975  
1914–2012



Michael  
Bishop  
NP 1989  
b. 1936



Harold E  
Varmus  
NP 1989  
b. 1939



multiplication of the cells. This is called **transformation** by oncogenic virus.

Rous in 1911 demonstrated that sarcoma in avians can be transferred from one animal to another by injecting the soluble fractions. In 1944, Gross finally proved that viruses could be oncogenic. A homogenate of mice tumor was prepared, passed through bacterial filter, and the supernatant was injected into another mouse. A new tumor developed at the site of injection. Gross argued that the filtrate could contain only viruses (and not bacteria or cancer cells) which produce a tumor. After a long time, at the ripe age of 87, Rous was awarded Nobel Prize in 1966.

A list of important oncogenic viruses in animals is shown in Table 57.3. The list is only representative and is far from exhaustive. Simian virus (SV) is the virus producing lytic infection in monkeys. But in mice and hamsters, SV-40 when introduced, produces sarcoma. In 1930s, an aggressive form of lymphoma (cancer arising from lymphocytes) was seen as an epidemic in chicken in North America, wiping out almost two-third of the total poultry population. For the first time, a cancer was accepted to be transmissible. Soon, the Marek virus was isolated which was proved to be the etiologic agent. By the end of 1940s, an effective vaccine was prepared and the disease was controlled.

If cancers are produced by viruses in so many different species, could there be viruses oncogenic to human beings? A direct association of a virus with a human cancer is difficult to prove. Demonstration of a virus in a cancer tissue is not a proof, because the virus may enter after the cancer formation. On the other hand, the whole virus is not necessary for transformation. A list of possible oncogenic viruses in man is given in Table 57.4.

Burkitt in 1964 reported a type of lymphoma seen mainly in African children. Epidemiology suggested a strong possibility for a transmitting agent for the **Burkitt's lymphoma** (BL). In 1969, Epstein reported that all the biopsies of BL when placed in tissue culture for some time, generated the viral particles which could be seen

under electron microscope (Barr was the technician who first perfected this technique). The new virus was named as **Epstein-Barr (EB) virus**.

The lymphoma progression is through 3 different events. The first step is **infection** with EBV which specifically infects B lymphocytes. The B cells are now immortalized, that is, they can be cultured indefinitely in artificial medium. But they are still dependent on the B cell growth factor (BCGF) for proliferation.

The second step is the **chromosome translocation**, usually from chromosome 8 to 14, but sometimes from 8 to 2 or from 8 to 22. The chromosome 14 contains gene for immunoglobulin heavy chain, 2 contains gene for kappa light chain and 22 for lambda light chain. The transposing region in chromosome 8 contains the oncogene *c-myc*. This transposition of oncogenes to one of the Ig loci confers BCGF-independence; but these B cells can grow very slowly.

The third step is the activation of ***c-myc* oncogene**, with consequent malignancy. EBV is also strongly associated with **Nasopharyngeal carcinoma** (NPC) in Chinese. This is typically seen in Malaysia, where NPC is very rare in native people as well as in people of South Indian origin. But NPC is the commonest cancer in people of Chinese descent in Malaysia. This is true in North East India also. In Nagaland, about 40% of total cancers constitute NPC, which may be associated with EBV.

Similarly, in chronic myeloid leukemia, deletion of short arm of chromosome 22, called **Philadelphia (Ph') chromosome** is seen in 80% cases. In the rest, there is translocation of 9 to 22 leading to activation of *c-abl* present in chromosome 9.

In non-Hodgkin's lymphoma, translocation of chromosome 14 to 18 is very common, involving the ***bcl-2* oncogene**. The *bcl-2* product suppresses programmed

#### Box 57.1: Antimutagens

- Prevent transformation of a mutagenic compound into mutagens
- Inactivate the mutagens
- Prevent the interaction between mutagens and DNA

**TABLE 57.3: Viruses producing tumors in animals**

Virus	Nucleic acid of virus	Host	Type of tumor produced
Papova virus group			
SV-40	DNA	Mouse	Sarcoma
Papilloma	DNA	Rabbit	Papilloma
Marek	DNA	Chicken	Lymphoma
Retrovirus type C			
Gross	RNA	Mouse	Leukemia
Rous	RNA	Avian	Sarcoma
Retrovirus type B			
Bittner	RNA	Mouse	Mammary tumor

**TABLE 57.4: Human oncogenic viruses**

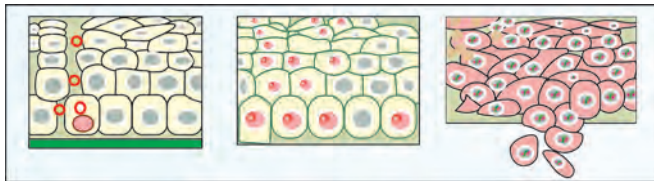
Virus	Abbreviation	Associated human cancer
Epstein-Barr virus	EBV	Burkitt's lymphoma (BL); Nasopharyngeal carcinoma (NPC)
Human papilloma virus	HPV	Uterine cervical carcinoma
Hepatitis B virus	HBV	Hepatoma
Hepatitis C virus	HCV	Hepatocellular carcinoma
Human immunodeficiency virus	HIV	Kaposi's sarcoma

cell death (see apoptosis, Chapter 47) leading to tumor formation.

**HPV (Human Papilloma Virus)** is the most common sexually transmitted infection in adults. It has a circular double stranded DNA. More than 100 HPV types are known. HPV types 16 and 18 are associated with human uterine cervical cancer; they cause 70% of all cervical cancers. Harald zur Hausen (Nobel prize, 2008) showed the HPV DNA in the cancer cells. HPV infects epithelial cells in the cervical mucosa; the virus multiplies and lyses the host cells, causing a lesion. In 99% of such cases healing occurs within 6 months to 2 years. But in about 1% cases, the HPV DNA is integrated into some of the host cells. After about 10–30 years, these cells develop invasive cancer. Vaccines against high risk HPV16 and 18 types are now developed that provide 95% protection from infection of HPV, thereby reducing the chances of developing cervical cancer (Figs 57.3 and 57.4). HPV vaccine is now recommended for all girls and women between the age of 9–25 years in Western countries.



**Fig. 57.3:** zur Hausen showed that HPV is integrated into the host DNA of human cervical cancer cells. Host cell DNA is isolated, cut with restriction endo-nucleases, electrophoresed, and hybridized with radioactive probes of HPV DNA. The DNA from patients are seen to hybridize with virus probes, as shown +ve in the slide. Details of DNA hybridization are given in Chapter 49



**Fig. 57.4:** HPV and host interaction. Left slide, HPV infects one cell in the basal layer in human uterine cervix. Middle slide, within few weeks, HPV spreads to most of the cells; replicates, and a lesion is manifested. Some host cells will escape the infection. In 99% cases, the lesion subsides within 6 months to 2 years time. Right slide, In 1% cases, virus is integrated into the host DNA, remains dormant. After 10–30 years, cancer is developed. Here malignant cells are shown to break the basal layer and invade into surrounding tissues

## ONCOGENES

### Oncogenes are Normal Constituents of Cells

- i. These are genes capable of causing cancer (Box 57.2). Michael Bishop and Harold Varmus, pioneers in the oncogene research were awarded Nobel Prize in 1989. A definite proof for an oncogene was first demonstrated in Rous sarcoma virus. The full virus produces sarcoma in avians but a strain of virus deficient in a particular gene, could not cause the disease. Hence, this gene was named as sarcoma gene, abbreviated as Src.
- ii. However, the same DNA sequences are available in normal avian cells also. This reveals that normal cells do contain DNA sequences similar to viral oncogenes.
- iii. To distinguish these two genes, they are denoted as **V-src** (viral gene) and **C-src** (cellular gene). The oncogenes present in normal cells are also called as **proto-oncogenes**.
- iv. Today, more than 100 human proto-oncogenes are known. They are located on specific chromosomes. A list of some important c-oncogenes is given in Table 57.5.
- v. Proto-oncogenes are important regulatory genes of the cells. In fact, viruses carry these genes accidentally picking them from the host cells.

### Proto-oncogenes are Regulatory Genes

- i. Products of many oncogenes are polypeptide **growth factors**, e.g. sis gene produces platelet derived growth factor (PDGF). This factor is required for normal wound healing.
- ii. Some of the products act as **receptors** for growth factor, e.g. erb-B produces receptor for EGF (epithelial growth factor).
- iii. Some other oncogene products act on key intracellular pathways involved in growth control, e.g. src product, a membrane-bound enzyme, **phosphorylates** a specific tyrosine residue, leading to cascade activation of cellular events. Receptors for EGF, insulin, PDGF, etc. are also activated by src-product protein.
- iv. The c-oncogenes are under the control of regulatory genes, and expressed only when required. When virus enters, an extra oncogene is inserted so as to produce continuous expression of the gene leading to uncontrolled cellular activity and malignant

#### Box 57.2: Oncogens and oncogenes are different

1. Oncogen is the chemical which produces cancer.
2. Oncogens are the chemicals that produce cancer.
3. Oncogene is the gene causing cancer.
4. Oncogenes are the genes causing cancer.
5. Oncogenes are written with small letters, and antioncogenes are written with capital letters.
6. The gene present in normal cell is named with prefix c- (to show that it is in the cell), whereas the corresponding gene present in the virus is denoted with prefix v- (standing for virus).

transformation. Proto-oncogene activation has been demonstrated in different types of human tumors.

### Many Factors Activate Oncogenes

The oncogenes also provide an explanation for the multifactorial origin of cancer. Thus viruses, chemical carcinogens, chromosome translocations, gamma-rays, spontaneous mutations, and all such factors may converge into one biochemical abnormality, the activation of oncogenes. This would lead to malignancy. This unified theory is depicted in Figure 57.7. Chromosomal translocation is described previously. Another cause for oncogene activation is point mutation.

**Point mutation of proto-oncogene:** The ras gene produces a protein termed P21 (Mol. wt. 21,000) related to the GTPase, that suppresses the activity of adenylyl cyclase. Adenylyl cyclase has a key role in cellular response to hormones (see Chapter 50). C-ras oncogene product is a mutated version of P21. So, GTPase activity is decreased leading to continuous activity of adenylyl cyclase.

### Antioncogenes or Oncosuppressor Genes

These are the genes, which normally protect the individual from getting the cancer. When the gene is deleted or mutated, cancer results (Table 57.6). Antioncogenes are written with capital letters, whereas oncogenes are represented by small letters.

A part of short arm of chromosome 17 was shown to be deleted in various human cancers. This region is now known to contain an oncosuppressor gene, called **p53**. It is so called because the gene encodes a **phosphoprotein** with molecular weight 53,000; with 375 amino acids in length. Arnold Levine in 1979 identified the p53. It blocks the cells that have damaged DNA by triggering the production of another protein p21, which blocks cell division until the damage is repaired. If the DNA damage is severe, p53 directs the cell to commit suicide by apoptosis. It can complex with other transforming proteins generated by other oncogenic viruses. (e.g. T antigen of SV 40; E6 of HPV-16). Most tumors have a complete absence of p53, whereas others show mutant nonfunctional p53. Normal p53 can suppress transforming ability of oncogenic viruses in vitro. It is also seen that p53 activates the expression of genes that suppress cell proliferation.

Similarly **RB gene** encodes a protein designated as p105 (Molecular weight: 105,000). This protein also is found to suppress cell proliferation, and to prevent the activity of various oncogenes. Only when both alleles of the RB gene are deleted (homozygous), retinoblastoma results. Mechanisms of actions of p53 and Rb proteins are explained under cell cycle, in Chapter 47.

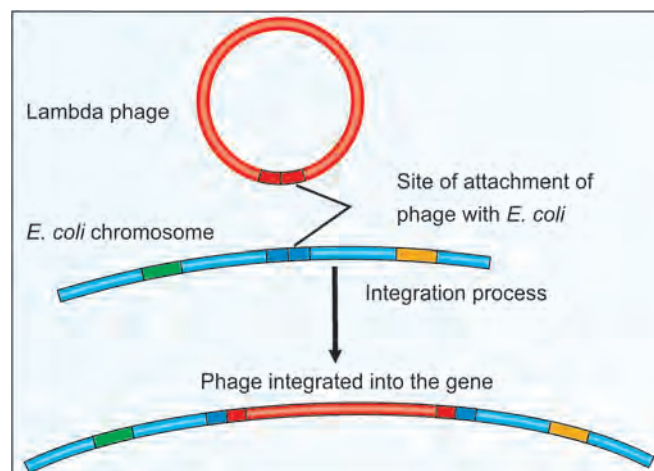
**BRCA gene mutations:** It is not a routine test like PAP smear. A blood test is done for women who are likely to have BRCA mutations (those with a family history of breast cancer). Mutations are seen in 5% of breast cancers and 10–15 % of ovarian cancers and more than 50% of patients with positive family history of breast or ovarian cancer.

**TABLE 57.5:** Some cellular oncogenes

Oncogene	Location in human chromosome No.	Virus carrying the gene	Oncogene product	Subcellular localization of the oncogene product
abl	9	Abelson leukemia virus in mouse	Tyrosine kinase	Plasma membrane
erb-B	7	erythroblastosis virus in chicken	Receptor for epidermal growth factor (EGFR)	Membrane
erb-A	17	do	Transforming growth factor receptor (TGF-R)	Nucleus
myc	8	Myelocytoma virus in chicken	DNA binding protein	Nucleus
sis	22	Simian sarcoma virus in monkey	Platelet derived growth factor (PDGF)	Membrane
src	20	Rous sarcoma in chicken	Tyrosine kinase	Membrane
ras	12	Rat Sarcoma	GTPase	Cytoplasm

**TABLE 57.6:** Important oncosuppressor genes

Name of the oncosuppressor	Abbreviation	Chromosome no.
Retinoblastoma	RB	13
Wilms tumor	WT	11
Familial adenomatous polyposis	FAP	5
Deleted in colon cancer	DCC	18
Gene for protein-53	p53	17
Familial breast cancer	BRCA1	17
von Hippel-Lindau gene	VHL	3



**Fig. 57.5:** Virus integrated into *E. coli* chromosome

Another example is MEN 1 gene, which encodes a protein called Menin with 610 amino acids. MEN is a tumor suppressor gene. Mutations will lead to loss of tumor suppression, causing multiple endocrine neoplasias (MEN). Patients will have tumors of parathyroid, pituitary, carcinoid, adrenal cortex, adrenal medulla, etc.

### Growth Factors

Many of the oncogenes act through the production of growth factors. The growth factors generally cause mitosis or differentiation of target cells. These may be considered as **local hormones**. There are more than 100 growth factors; a few important ones are shown in Table 57.7. Fibroblast growth factor (FGF), hepatocyte growth factor (HGF), keratinocyte growth factor (KGF), vascular endothelial growth factor or vasculotropin (VEGF) are some other well-characterized growth factors. Some of them are described in Chapter 60. Interleukins and interferons are growth factors released by lymphocytes/macrophages (see Chapter 55).

### Differences between Normal and Tumor cells Tumor Kinetics

**Cell cycle** has been described in Chapter 47. The cell cycle is divided into G1, S, G2 and M phases, the cycle being completed within 18–24 hours. The cell cycle time is more or less same for normal cells and cancer cells. In a normal tissue, only 1% cells are in the dividing state. In cancer tissues, about 2–5% of cells are in the cell cycle and this number demarcates a mildly growing tumor (2%) from an aggressive one (5%). This difference is made use of in treatment. Cytotoxic drugs and radiation will kill the cells in the cell cycle, while sparing the resting cells. Cyclin dependent kinase inhibitors (p16 and p27) have been shown to be lost in various cancers.

### Doubling Time

Growth of a tumor mass depends on: (1) Cellular proliferation. The proliferation co-efficient is the ratio of cells in the cycle to the resting

cells. The more the ratio, the more aggressive is the cancer. (2) Cell death by apoptosis, lack of oxygen or nutrition and destruction by immunological mechanisms. The doubling time is the time taken by a tumor to exactly double its mass, and is a constant for a particular growth over a long period. The tumor doubling time in human cancers varies widely between 10 days to 450 days, with a mean of about 100 days. Very rapidly growing tumors will need lesser days to double the volume. In the case of tumor with a doubling time of 100 days, the time taken for this growth to reach 1cm size from the initial mutated cell is about 8–10 years. Thus, the tumor was present in the body for a considerable period before the clinical detection. The same fact explains the development of the secondaries several years after the treatment of the primary growth.

### Malignant Transformation

When a normal cell has acquired malignant character, it is said to be transformed. For his pioneering work in transformation studies in tissue culture, Renato Dulbecco was awarded Nobel prize in 1975. In the cell culture, this is seen as alterations in morphology as well as changes in the alignment among the cells (Figs 57.6A and B). Normal cells form a monolayer, while cancer cells show multilayered appearance.

### Contact Inhibition

It is a characteristic of normal cells. If a cut is made in the skin, the cells from both sides start to multiply. This multiplication is stopped when the cells come into contact. This is called contact inhibition. Adjacent cells form tight junctions through which cell to cell communication occurs. But in the case of cancer cells, tight junctions are rare, the property of contact inhibition is lost and adjacent cells continue to multiply to form multilayered or jumbled appearance.

### Anchorage Dependence

Yet another malignant character is the loss of anchorage dependence in tissue culture system. Normal cells adhere firmly to the surface of the

**TABLE 57.7:** Some important growth factors

Growth factor	Abbreviation	Mol. wt. kD	Chromosome No.	Produced by location	Function
Epidermal growth factor	EGF	6	7	Fibroblasts, submaxillary gland	Stimulates epidermal and epithelial cells
Transforming growth factor- $\alpha$	TGF- $\alpha$	5.6	-	Tumor cells, placenta	Similar to EGF
Transforming growth factor- $\beta$	TGF- $\beta$	25	-	Platelets, placenta	Inhibition of fibroblasts
Platelet derived growth factor	PDGF	32	5	Platelets	Accelerates wound healing
Nerve growth factor	NGF	26	1	Submaxillary gland	Growth of sensory neurons
Insulin-like growth factor	IGF-1	11	15	Serum	Sulfation into cartilage
Erythropoietin	EP	39	7	Kidney	Stimulates erythropoiesis
Granulocyte macrophage colony stimulating factor	GMCSF	18–30	5	Endothelial cells, and T cells	Stimulates granulocytes, monocytes, magakaryocytes
Granulocyte colony stimulating factor	GCSF	20	17	Endothelial cells, and fibroblasts	Stimulates granulocytes
Monocyte colony stimulating factor	MCSF	70–90	5	Endothelial cells	Stimulates monocytes
Tumor necrosis factor- $\alpha$	TNF- $\alpha$	17	6	Monocyte	Necrosis of tumor cells, proliferation of leukocytes



glass bottle, but cancer cells do not. **Vinculin** is a protein found in the focal adhesion plates, that is, the structures involved in adhesion between the cells as well as the basement in the case of normal cells. Oncogene product, especially **tyrosine kinase**, causes abnormal phosphorylation of vinculin. So, there is diminished adhesion to substratum as well as the rounded appearance of transformed cells (Fig. 57.6B).

### Sialic Acid and Sialylation

Most cancer cells carry more negative surface charges on their cell surface than their normal counterparts. This abnormality is due to the higher **N-acetyl neuraminic acid** (NANA) content of the cancer cell membrane. Due to the higher content of negative charges the cancer cells tend to repel each other, resulting in lesser adhesiveness. Altered **sialylation of cell surface** glycoproteins and glycolipids is closely related to the malignant phenotype of cancer cells, including the metastatic potential and invasiveness. Human sialidases are indeed related to malignancy and may be potential targets for cancer diagnosis and therapy.

### Cell Fusion

Cell fusion plays an essential role in fertilization, immune response, tissue repair, and regeneration. Cell fusion may contribute to the initiation and progression of cancer. Experimental and clinical studies suggest a potentially multifaceted involvement of cell fusion in different stages of tumor progression, including aneuploidy and tumor initiation, origin of cancer stem cells, multidrug resistance, and the acquisition and diversification of metastatic abilities.

### Metastasis and Secondaries

Cancer cells have a tendency to disintegrate from the main mass and to disseminate to nearby or distant organs. This forms *metastasis*. The word cancer is derived from a Greek word meaning crab. The cells

from the main cancer tissue migrate farther away, like the feet of a crab. The **collagenase** and stromolysin released by most cancers help in the penetration of cancer cells into surrounding areas.

### Metabolic Alterations in Cancer Cells

Many cancer cells are shown to delete different enzymes or even whole metabolic pathways. Generally cancer cells thrive on minimal enzymes. A good example is that many tumors prefer anaerobic glycolysis and eliminate citric acid cycle enzymes. **Warburg's hypothesis** is described in Chapter 9. Another example is the deletion of asparagine synthetase in certain lymphomas.

### Why Cancer Cells are Immortal?

One reason is that cancer cells have increased and persistent activity of telomerase, the enzyme that maintains the length of telomeres (end region of chromosomes). See Figure 44.19.

### Apoptosis

Programed cell death is called apoptosis (see Chapter 47). It is a Greek word, meaning "falling of leaves". In normal organs, the number of cells newly produced will be equal to the number of dead cells. In those cells which are progressing to apoptosis, there will be condensation of chromatin, shrinking of cells, DNA fragmentation and finally disintegration of the cell. Examples of apoptosis mediating genes (*suicidal genes*) are c-fos, p53, Rb; and so they in turn are oncosuppressor genes. By the same argument, apoptosis protecting genes are cancer producing genes, e.g. bcl-2 and other oncogenes.

### Tumor Immunology

All forms of treatment of cancer (surgery, radiotherapy and chemotherapy) leave some residual cancer cells in the body. These are annihilated by the body's immune mechanism. All the effector arms of immunological mechanisms described in Chapter 55 are active against cancer cells. These are (a) T cells, (b) NK cells, (c) antibody dependent complement mediated lysis, (d) antibody dependent cell mediated cytotoxicity (ADCC), and (e) macrophages. Burnet (Nobel prize, 1960) had postulated that the major purpose of immunological system is the surveillance against spontaneously occurring cancer cells. In the tumor bearing host, appreciable level of immunological reaction against the cancer is detected. This is because of the presence of **tumor associated antigens** (TAA) on the surface of cancer cells.

Virally induced tumors show **virus-specific antigens**. The same virus may produce tumors in different species; but all of them carry same antigen. This is because the virus is integrated at specific regions of the DNA, causing the same alterations in all the instances.

Chemically induced cancers show **individually specific antigens**. The same carcinogen injected at two different sites of the same animal may produce two tumors, with distinct antigens. This is because chemicals react with DNA at random sites, causing mutations at different loci. Most of the human cancers show the emergence of oncofetal antigens.

### Oncofetal Antigens

During the fetal life, a particular gene is active, and the product, a protein is therefore produced in the cell (Fig. 57.8). During the differentiation

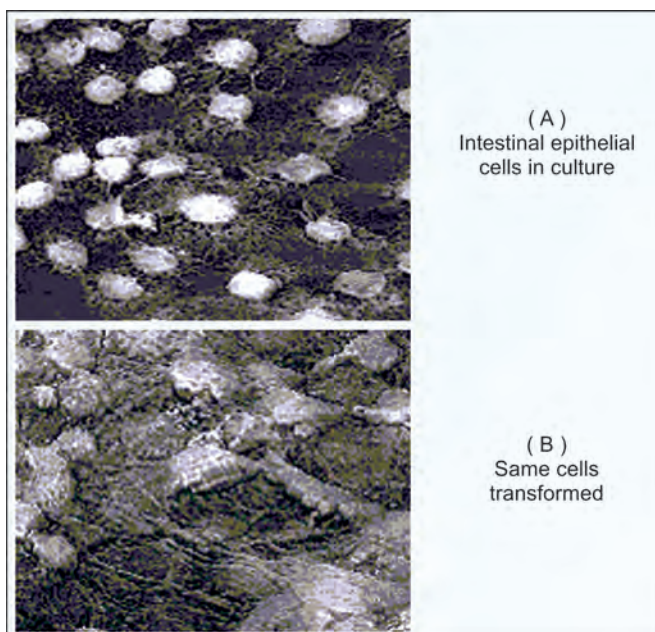


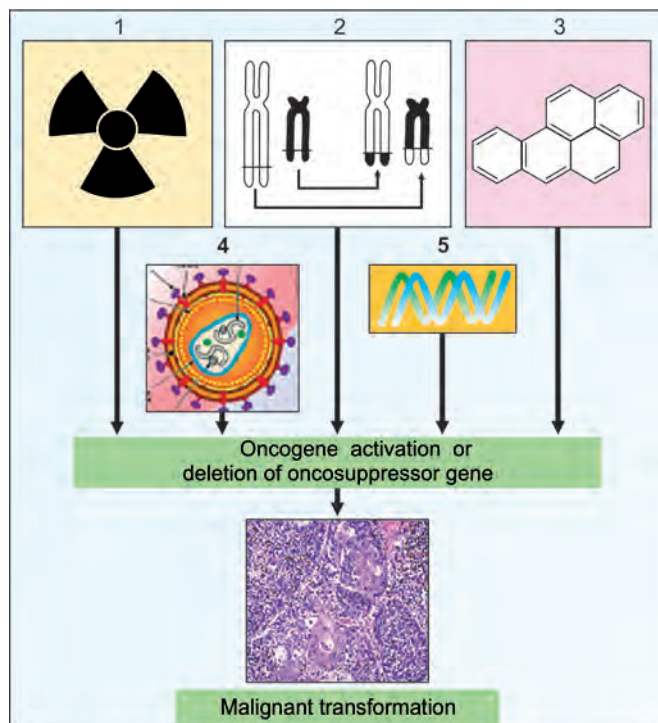
Fig. 57.6: Transformation of cells in tissue culture

process, this gene is suppressed and therefore the protein is not present in adult cells. However, along with the malignant transformation, de-differentiation occurs, the gene is derepressed and the protein is again available in the cell. Such products are classified as oncofetal proteins. The best examples are the appearance of alpha-feto protein (AFP) in hepatomas and carcino-embryonic antigen (CEA) in colon cancers. They generally serve as tumor markers.

## TUMOR MARKERS

They are also called as **tumor index substances**. They are factors released from the tumor cells, which could be detected in blood and therefore indicate the presence of the tumor in the body. They are useful for the following purposes.

- For follow-up of cancer and to **monitor** the effectiveness of the therapy and also to detect the recurrence of the tumor (Fig. 57.9).
- To facilitate detection of cancer. The presence of tumor marker suggests the **diagnosis**, but caution is to be taken to rule out other non-malignant conditions.
- For **prognosis**. Serum level of the marker may indicate roughly the tumor load, which in turn indicates whether the disease is curable or not.



**Fig. 57.7:** Unified concept of carcinogenesis. 1= ionising radiation; 2= chromosome translocation; 3= chemical carcinogens; 4= oncogenic viruses; 5= spontaneous mutations

d. For localization. Experimentally it is shown that radiolabeled antibodies against the marker will be fixed on the tissues producing the marker.

e. **Precautions:** Tumor markers are sometimes elevated in nonmalignant conditions. Not every tumor will cause a rise in the level of its associated marker, especially in the early stages of some cancers. When a marker is used for cancer screening or diagnosis, the physician must confirm a positive test result by using imaging studies, tissue biopsies, and other procedures.

## Clinically Important Tumor Markers

### Alpha Fetoprotein (AFP)

In 1963, Abelev demonstrated AFP. Its molecular weight is 70,000 D. It is fetal albumin and has similarities with adult albumin. It is increased in the circulation of patients with **hepatocellular carcinoma**, germ cell tumors, teratocarcinoma of ovary and in pregnancy with fetal malformations of neural tube (Table 57.8). In adult males and nonpregnant females, normal value is less than 15 ng/L. A value of AFP above 300 ng/L is often associated with cancer, although levels in this range may be seen in nonmalignant liver diseases. Levels above 1000 ng/L are almost always associated with cancer (except in pregnancy). The gene for AFP is located in chromosome No. 4. The fucosylated fraction of AFP (AFP-L3) has been reported to be a more specific marker for hepatocellular carcinoma.

### Carcinoembryonic Antigen (CEA)

The CEA level is markedly increased in **colorectal cancers**. Its molecular weight is 180 kD (Table 57.8). In 1965, Gold and Freedman identified the CEA. Over 50% of persons with breast, colon, lung, gastric, ovarian, pancreatic, and uterine cancer have elevated levels of CEA. CEA levels may also be elevated in inflammatory bowel disease (IBD), pancreatitis, and liver disease. Heavy smokers and about 5% of healthy persons have elevated plasma levels of CEA.

### Beta Chain of Chorionic Gonadotropin

**Beta-hCG** is synthesized by normal syncytiotrophoblasts (cells of placental villi). Its molecular weight is 45 kD. hCG is a glycoprotein; it has alpha and beta subunits. The alpha subunit is identical with those of FSH, TSH and LH.

The beta subunit is specific for hCG. It is increased in hydatidiform mole, **choriocarcinoma** and germ cell tumors (Fig. 57.9). About 60% of testicular cancers secrete hCG. Normal value is less than 20 IU/L for males and nonpregnant females. Greater than 100,00 IU/L indicates trophoblastic tumor.

### Cancer Antigen 125 (CA-125)

CA-125 is a tumor maker for **ovarian cancers**. It is a glycoprotein with a molecular weight of 10 million; one

of the biggest molecules identified. The name is so given because it reacted with a monoclonal antibody, originally termed as OC-125 (Bast, 1981). Approximately 75% of persons with ovarian cancer will have elevated serum levels. (50% of persons with stage I disease and 90% with stage II). Elevated levels of CA-125 are also found in approximately 20% of persons with pancreatic and digestive tract cancers. CA-125 levels correlate with tumor mass; consequently, this test is used to determine whether recurrence of the cancer has occurred following chemotherapy. Normal blood level of CA-125 is less than 35 U/mL.

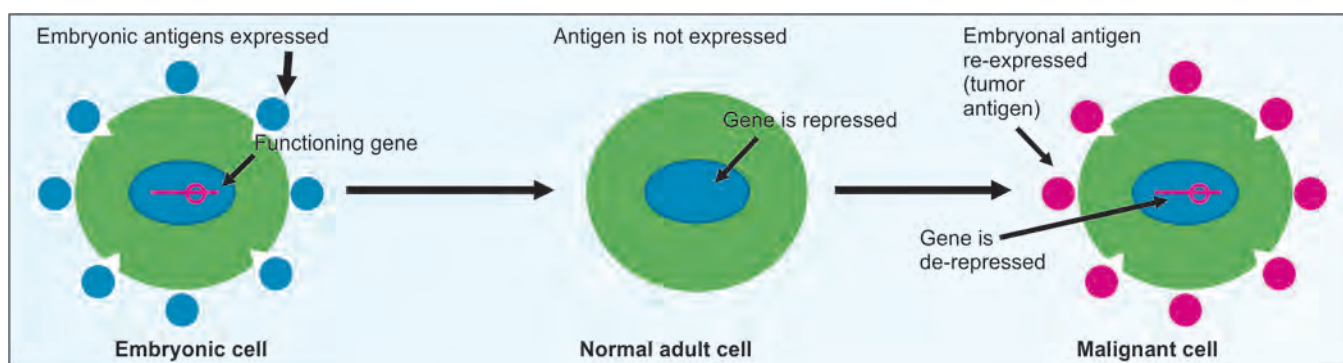


Fig. 57.8: Oncofetal antigen

TABLE 57.8: Common tumor markers

Name	Serum level increased in
Oncofetal Products Alpha fetoprotein (AFP)	Hepatoma, germ cell cancers
Carcinoembryonic antigen (CEA)	Colorectal, gastrointestinal, and lung cancer
Carbohydrate Antigens CA-125	Ovarian cancer of epithelial origin
Tissue Antigens Tissue polypeptide antigen	General cancer load
Enzymes Alkaline phosphatase (ALP) Bone secondaries Placental type ALP (Regan)	Lung, seminoma
Prostatic acid phosphatase (PAP)	Prostate cancer
Prostate specific	Prostate cancer Antigen (PSA)
Neuron Specific Enolase	Neuro-endocrine tumors
Hormones and their Metabolites	
Beta-hCG	Choriocarcinoma
Calcitonin	Medullary thyroid carcinoma
Big ACTH	Lung oat cell cancer
Vasoactive intestinal polypeptide (VIP)	Apudomas (Amine precursor uptake decarboxylation-omas)
Vanillyl mandelic acid (VMA)	Pheochromocytoma and neuroblastoma
Hydroxy indole acetic acid	Carcinoid syndrome
Tissue Catabolic Product	
Hydroxy proline	Bone metastasis
Serum Proteins Immunoglobulins (Ig)	Multiple myeloma, macroglobulinemia
Bence-Jones proteins (in urine)	Multiple myeloma

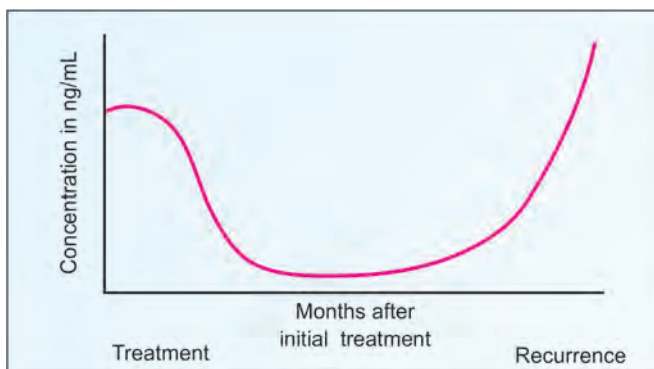


### Tissue Polypeptide Antigen (TPA)

It was isolated by Bjorklund in 1957. It is a common human carcinoma antigen, produced during G2 phase and released into surrounding fluids during mitosis. It is not specific for cancer of a particular site; but it is useful to assess the activity of the tumor. It is seen in blood as long as the tumor cells proliferate. The TPA blood test is sometimes used along with other tumor markers to help follow patients being treated for lung, bladder, and many other cancers.

### Prostate Specific Antigen (PSA)

Chu isolated it in 1980. It is produced by secretory epithelium of prostate gland. It is normally secreted into seminal fluid, where it is necessary for the liquefaction of seminal coagulum. It is a 32 kD glycoprotein. It is a protease, and in serum it is seen complexed with alpha-1-antitrypsin. The PSA level, especially the complexed form, is increased in prostate cancers. PSA has been found to be elevated in 60–70% patients with **cancer of the prostate**. Most PSA is bound to antitrypsins in plasma but some PSA circulates unbound to protein (free PSA). Normal blood level of total PSA is less than 4 ng/L. Persons with a borderline total PSA (between 4–10 ng/L), but who have a low free PSA are more likely to have malignant prostate disease. Mutations throughout the mitochondrial genome are associated with prostate cancer. There is strong association of tRNA mutations with elevated levels of PSA in men diagnosed with prostate cancer. Prostate cancer is one of the most prevalent cancers.



**Fig. 57.9:** Monitoring of serum level of beta-HCG in chorionic carcinoma (The level is decreased after treatment and goes up when the disease recurs)

## Other Tumor Markers

### Estrogen Receptor (ER)

It is a protein found in the nucleus of breast and uterine tissues. The level of ER in the tissue is used to determine whether a person with breast cancer is likely to respond to therapy with tamoxifen, which binds to the receptors blocking the action of estrogen. Women who are ER-negative have a greater risk of recurrence than women who are ER-positive. Less than 6 femtomol/mg protein is negative; greater than 10 fmol/mg protein is positive.

### Progesterone Receptor (PR)

It consists of two proteins, which are located in the nuclei of both breast and uterine tissues. PR has the same prognostic value as ER, and is measured by similar methods. Tissue that does not express the PR receptors is less likely to bind estrogen analogs used to treat the tumor. Persons who test negative for both ER and PR have less than a 5% chance of responding to endocrine therapy. Those who test positive for both markers have greater than a 60% chance of tumor shrinkage when treated with hormone therapy. Normal value is less than 6 fmol/mg protein. Greater than 10 fmol/mg protein is positive.

### Bladder Tumor-associated Analytes (BTA)

It is comprised of type IV collagen, fibronectin, laminin, and proteoglycan, which are components of the basement membrane that are released into the urine when bladder tumor cells attach to the basement membrane of the bladder wall. These products can be detected in urine using a mixture of antibodies to the four components. BTA is elevated in about 30% of persons with low-grade bladder tumors and over 60% of persons with high-grade tumors.

### Beta-2-Microglobulin (B2M)

The B2M blood levels are elevated in **multiple myeloma**, chronic lymphocytic leukemia (CLL), and some lymphomas. Levels may also be higher in some non-cancerous kidney disease. Normal levels are usually below 2.5 mg/L. B2M is useful to help predict the long-term prognosis in these cancers. Patients with higher levels of B2M usually have a poorer prognosis. B2M is also checked during treatment of multiple myeloma to see how well the treatment is working.

### Bladder Tumor Antigen (BTA)

It is found in the urine of many patients with bladder cancer. It may be seen in some non-cancerous conditions such as kidney stones or urinary tract infections. It is sometimes used along with NMP22 to test patients for the recurrence of bladder cancer. This test is not often used.



### Calcitonin

It is a hormone produced by cells called parafollicular C cells in the thyroid gland (see Chapter 35). It normally helps regulate blood calcium levels. Normal calcitonin levels are below 5 to 12 pg/mL (picograms per milliliter) (A picogram is  $10^{-12}$  of a gram.) In **medullary thyroid carcinoma** (MTC), a cancer of parafollicular C cells, blood levels of calcitonin are often greater than 100 pg/mL. This is one of the rare tumor markers that can be used to help detect early cancer. Because MTC is often inherited, blood calcitonin can be measured to detect the cancer in its very earliest stages in family members who are known to be at risk.

### HER2/neu (or *erbB-2*, or *EGFR2*)

It is a protein that stimulates breast cancer cells to grow. Higher than normal levels can be found in some other cancers, too. The HER2 level is usually found by testing a sample of the cancer tissue itself, not in blood. HER2 is positive in about 1 in 5 breast cancers. These cancers tend to grow and spread more aggressively than other breast cancers. All newly diagnosed breast cancers should be tested for HER2. HER2-positive cancers are more likely to respond to certain treatments such as trastuzumab (Herceptin) and lapatinib (Tykerb), which work against the HER2 receptor on breast cancer cells.

### Neuron Specific Enolase (NSE)

It is a marker for neuroendocrine tumors such as small cell lung cancer, neuroblastoma, and carcinoid tumors. It is most useful in the follow-up of patients with small cell lung cancer or neuroblastoma. Elevated levels of NSE may also be found in some non-neuroendocrine cancers. Abnormal levels are usually higher than 9  $\mu\text{g/mL}$  (micrograms per milliliter).

### Thyroglobulin

Thyroglobulin is a protein synthesized by the thyroid gland. Thyroglobulin levels are elevated in many thyroid diseases, including some common forms of **thyroid cancer**. Treatment for thyroid cancer often involves removal of the entire thyroid gland. Thyroglobulin levels in the blood should fall to undetectable levels after treatment. A rise in the thyroglobulin level may indicate the recurrence of cancer. In some persons, anti-thyroglobulin antibodies may be present in circulation, which can affect test results. This is why levels of anti-thyroglobulin antibodies are often measured at the same time.

Paraproteinemia and multiple myeloma are described in Chapter 55. Oncofetal proteins and tumor markers are listed in Table 57.8.

## ANTICANCER DRUGS

Surgery and radiotherapy are most effective to reduce the initial tumor load. These are the prime modalities of treatment in solid tumors. Chemotherapy is the sheet anchor of therapy in leukemias, advanced lymphomas, choriocarcinoma and other widely disseminated malignancies. The effectiveness of

cytotoxic drugs is directly proportional to the doubling time of the tumors, and is inversely proportional to the number of cancer cells. Cytotoxic drugs affect all the cells which are in the dividing phase. Rapidly dividing normal cells (gastrointestinal tract, hematopoietic system, hair follicles, gonads) are also affected by chemotherapeutic drugs, leading to toxicity. In fact, pharmacological dose and toxic dose usually overlap in the case of these drugs.

Cell destruction by cytotoxic drug follows the first order kinetics, that is, it reduces a constant percentage and not a constant number of cancer cells. This is explained in Table 59.3. The same dose, which reduces the cancer cells from  $10^8$  to  $10^7$ , is required to reduce them from  $10^3$  to  $10^2$ . Therefore, it is difficult to eradicate the residual cancer cells by chemotherapy. These are lysed by the immune mechanisms, when a complete cure is achieved. Some important anticancer drugs are listed in Tables 57.9 and 57.10.

### Methotrexate

It inhibits dihydrofolate reductase. Methotrexate has structural similarity to folic acid, and hence will competitively inhibit folate reductase (Fig. 57.10). So in presence of methotrexate, tetrahydrofolic acid is not produced, which is necessary for incorporation of C2 and C8 of purines and C5 methyl group in thymidine. Thus, there is inhibition of DNA synthesis and consequently of cell division. Methotrexate is commonly employed in the treatment of **choriocarcinoma**, which is a curable cancer. It is also useful in acute leukemia, where highly toxic doses are first administered so as to kill maximum number of leukemia cells, and then patient is retrieved by citrovorum factor (folinic acid).

### 6-Mercaptopurine

It is a purine analogue (Fig. 57.11, upper part). It is activated into 6-mercaptopurine ribotide, which prevents amination of IMP to AMP, so that the availability of AMP is reduced (see Fig. 43.13). This leads to inhibition of synthesis of DNA, and in turn cell division. It is commonly employed in treating acute lymphoblastic leukemia.

### Thioguanine

It is also a purine analogue (Fig. 57.11, middle). The mechanism of action is more or less similar to that of 6-mercapto purine. Both these drugs were developed by Gertrude Elion and George Hitchings; both were awarded Nobel prize in 1988.

### 5-Fluorouracil

It is an analog of uracil or can be considered as an analog of thymine. Fluorouracil will inhibit thymidylate synthase, thereby reducing the conversion of dUMP to dTMP (see Fig. 43.20). Thereby thymine incorporation in the DNA, and consequent DNA synthesis are prevented. The drug is widely used in the treatment of **adenocarcinoma** of colon and breast.

### Cyclophosphamide

It is a nitrogen mustard derivative. It is extensively used in different cancers, especially lymphomas and myeloid leukemias. It is an alkylating agent, causing cross linkage between adjacent bases of the double helix. Nitrogen of guanine is especially attacked. Thus, DNA strands cannot separate, and new DNA synthesis is blocked.

### Mitomycin C

It is derived from streptomyces. The drug causes cross bridge between DNA strands, preventing separation of strands, and inhibiting new DNA synthesis. It is used in adenocarcinomas of stomach, breast, colon, etc.

### Vincristine and Vinblastine

They are alkaloids isolated from the leaves of the garden plant, periwinkle or *vinca rosea*. Indian medicine had been using this plant from time immemorial. In 1949, Robert Noble found that an extract of periwinkle leaves reduce the WBC count in leukemic rats. In 1954, Noble isolated the vincristine, out of about 300 different alkaloids present in the leaves. From one ton of leaves, only 1 mg of the active ingredient could be isolated. In 1958, Irving Johnson first established the clinical usefulness of the drug in human leukemias. The drugs are now widely used in leukemias, lymphomas as well as in solid tumors. It has stathmokinetic (spindle movement) inhibitory effect. So, the cells are arrested in metaphase and cell division is inhibited.

### Azaserine

It is a derivative of serine, diazo acetyl serine. The structure of azaserine is shown in Figure 16.11, under serine metabolism. It is a glutamine analogue. So it will block the reactions in which glutamine takes part. So, the following reactions are inhibited : phosphoribosyl amine

synthesis (step 1 purine synthesis, Fig. 43.12); formyl glycinamide ribonucleotide (step 4 of purine synthesis, Fig. 43.12); and guanosine monophosphate synthesis (see Fig. 43.14). Thus, purine synthesis and thereby DNA synthesis are inhibited.

### L-asparaginase

It is an enzyme useful in the treatment of lymphomas and leukemias. It will convert asparagine to aspartic acid by removing one molecule of ammonia. When asparaginase is injected, blood asparagine level is lowered. Asparagine starvation will destroy cancer cells, which are deficient in asparagine synthetase. However, normal cells are spared because they contain asparagine synthetase, so that asparagine can be synthesized from aspartic acid (see Fig. 17.3).

### Monoclonal Antibody

These drugs are a relatively new innovation in cancer treatment. Technique for monoclonal antibody production is described in Chapter 49. The mechanism of action of monoclonals against cancer may be:

- The antibody marks the cancer cell and makes it easier for the immune system to attack. The drug **rituximab** attaches to CD20 found only on B cells; makes the cells more visible to the immune system, which can then attack.
- Block growth factors.** Certain cancer cells make extra copies of the growth factor receptor. This makes them grow faster than the normal cells. Monoclonal antibodies can block these receptors and prevent the

**TABLE 57.9:** Common anticancer drugs

Name	Type	Mode of action
Methotrexate	Folic acid analogue	Competitive inhibitor of dihydrofolate reductase. THFA is required for nucleotide synthesis
6-Mercapto purine	Purine analogue	Inhibits the conversion of IMP to AMP
6-thio guanine	Purine analogue	Inhibits the conversion of IMP to AMP
Cyclophosphamide	Alkylating agent	Cross linking of bases of DNA; inhibition of strand separation
MitomycinC	Antibiotic	Cross bridges are formed between DNA base pairs
Actinomycin D	Antibiotic	Intercalates with guanine bases of DNA; prevents transcription
Vincristine and Vinblastine	Alkaloids from <i>Vinca rosea</i>	Interferes with assembly of cytoskeleton and inhibits Stathmokinesis (spindle movement)
Adriamycin	Anthracyclins	Topo-isomerase mediated breaks in DNA
Etoposide	Podophyllo toxin	Stabilises topo-isomerase-II-DNA cleavage complexes
Camptothecin		Modifies function of topo-isomerase-I to DNA breaking agent
Cisplatin	Platinum compound	Forms intrastrand DNA adducts
Imatinib	Monoclonal antibody	Tyrosine kinase inhibitor
Fluorouracil (FU)	Pyrimidine analog	Inhibits thymidylate synthase

growth signal. For example, **Cetuximab** attaches to epidermal growth factor receptors (EGFR) on cancer cells. Blocking this signal from reaching its target on the cancer cells may slow or stop the cancer from growing.

- c. **Stop new blood vessels from forming.** To attract blood vessels, cancer cells send out growth signals. Monoclonal antibodies that block these growth signals may help prevent a tumor from developing a blood supply, so that it remains small. The monoclonal antibody **bevacizumab** intercepts vascular endothelial growth factor (VEGF) and stops them from connecting with their targets (Table 57.10).

## Drug Resistance

The mechanisms of drug resistance include:

1. The target enzyme or pathway is deleted.
2. Alternate minor pathways for drug catabolism are opened.
3. Drug uptake is reduced or inhibited. Multi-drug resistance in cancer chemotherapy is due to over-expression of a membrane protein, called **P-glycoprotein** (Pgp). This acts as an efflux pump of drugs. It pumps hydrophobic drugs out of the cell by an ATP dependent process (ABC protein), thereby reducing their cellular concentration. This leads to resistance for many anticancer drugs.
4. Increased synthesis of enzymes degrading the drug. Methotrexate is a good example. Methotrexate inhibits

dihydro folate reductase. When methotrexate is given, tumor cells increase 400 times the synthesis of the enzyme. This is by **gene amplification**. The amplified genes, measuring up to 1000 kbp could be detected as homogeneously staining regions in the chromosome.

## Related Topics

Anti-oxidants (see Chapter 33), telomerase (see Chapter 44), cell cycle (see Chapter 47), retinoblastoma gene (see Chapter 47), Ame's test for mutagenesis (see Chapter 47) and apoptosis (see Chapter 47).

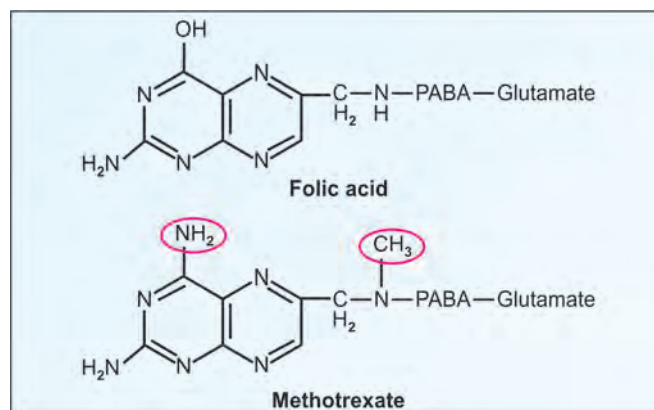


Fig. 57.10: Folic acid and methotrexate. Red circles denote the structural alterations in methotrexate

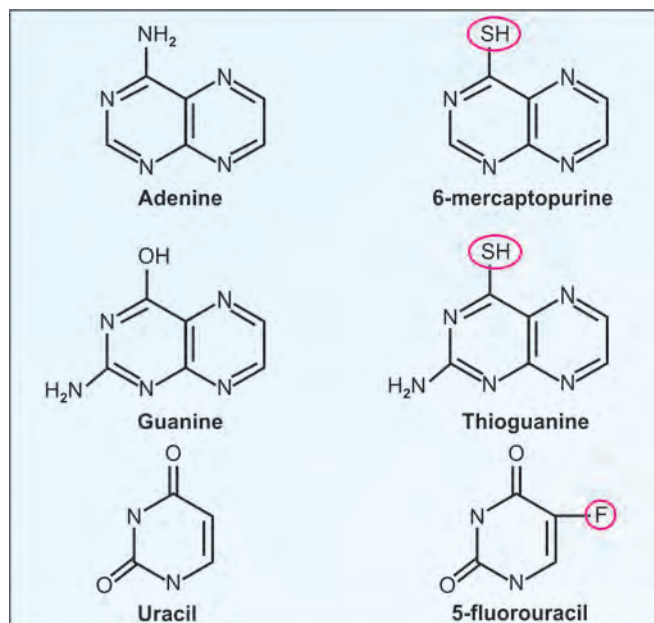


Fig. 57.11: Purine and pyrimidine analogs, commonly used as anticancer agents. Red circles denote the structural alterations from the parent compounds

**TABLE 57.10:** Some monoclonal antibodies used as anticancer agents

Name	Target	Used against the cancer
Rituximab	CD20 on B cells	NHL, CLL, B cell leukemia
Trastuzumab (Herceptin)	HER-2/neu (EGFR2, Erb-B2)	Breast cancer
Bevacizumab	VEGF	Colorectal, solid tumors of kidney, breast
Alemtuzumab	CD52 on B cells	CLL
Cetuximab	KRas	Colorectal, head and neck
Panitumumab	EGFR	Colorectal
Imatinib	Tyrosine kinase	CML
Gefitinib	Tyrosine kinase	Non small cell lung cancer
Nilutinib	Tyrosine kinase	Solid cancers
Ipilimumab	Antigen-4	Melanoma

### Clinical Case Study 57.1

A 40-year-old female presented to the clinic with lump in right breast. A mammogram performed revealed a breast mass measuring 3 cm with numerous microcalcifications suggestive of breast cancer. The family history revealed that she had a sister who was diagnosed with breast cancer at the age of 35. She also recalls that one of her aunts had died long ago with great abdominal distension (probably ovarian carcinoma). On physical examination, there was a fixed and nontender mass on right breast, measuring 3 cm. Axillary lymph nodes were palpable on the right side. Skin was not involved. The biopsy report was intraductal carcinoma. What cancer gene might be associated with cancer breast? What is the likely mechanism of activation of oncogene in this case?

### Clinical Case Study 57.1 Answer

Most likely cancer gene: Breast cancer (BRCA) gene  
Likely mechanism: Inhibition of tumor-suppressor gene  
Discussion: This patient has developed breast cancer. Her two relatives had breast or ovarian cancer prior to menopause. This makes BRCA gene mutation likely. Proto-oncogenes are normal genes that are present in normal cells and involved in normal growth, but if mutated, they become oncogenes, leading to cancer. The BRCA1 gene encodes a protein which is necessary for DNA repair. A woman with a BRCA1 mutation has 70% risk of developing breast cancer, and 30% risk of ovarian cancer. However,

it should be emphasized that the vast majority of breast cancers are not genetically based, but occurs sporadically. BRCA2 mutations are also associated with ovarian cancers and male breast cancers.

### QUICK LOOK OF CHAPTER 57

1. All cancers are multifactorial in origin. They include genetic, hormonal, metabolic, physical, chemical and environmental factors. Examples of physical carcinogens are X-ray, gamma-ray, ultraviolet ray. Examples of chemical mutagens are Aflatoxins, Methylcholanthrene, Nicotine.
2. Examples of antimutagens include Vitamin A, Vitamin E, Vitamin C and Curcumin.
3. Example of viruses producing tumors in animals are Polyoma, SV 40, Gross, Rous, etc.
4. Viruses possibly oncogenic in man are EBV, HPV and Hepatitis B.
5. Genes capable of causing cancer are termed oncogenes, e.g. myc, src, ras, abl, erb-B etc.
6. Genes which normally protect the individual from getting a cancer are called Anti-oncogenes or Oncosuppressors, e.g. p53, pRB.
7. Examples of oncofetal antigens are alpha-fetoprotein (AFP) in hepatomas and carcino-embryonic antigen (CEA) in colon cancers.
8. Tumor markers are useful for diagnosis and follow-up of cancer chemotherapy, e.g. CA-125, VMA, Placental ALP, Prostate specific antigen.



# CHAPTER 58

## Tissue Proteins in Health and Disease

### Chapter at a Glance

The reader will be able to answer questions on the following topics:

- Collagen, structure and synthesis
- Abnormal collagens
- Elastin
- Keratins
- Muscle proteins
- Myosin, Actin, Troponins
- Lens proteins and cataract
- Biochemistry of aging
- Prions and Alzheimer's disease

### COLLAGEN

The major structural protein found in connective tissue is the collagen. Collagen is a Greek word which means the substance to produce glue. It is the most abundant protein in the body. About 25–30% of the total weight of protein in the body is collagen. It serves to hold together the cells in the tissues. It is the major fibrous element of tissues like bone, teeth, tendons, cartilage and blood vessels.

#### Structure of Collagen

The **tropocollagen**, has a molecular weight of 285 kDa. The tropocollagen is made up of three polypeptide chains. Depending on the amino acid variations, there are 27 types of collagens described. Different methods utilized for collagen analysis are ELISA, Western blotting, dye based assays and tissue hydrolysis followed by analysis of hydroxyproline by HPLC. Type I is the most abundant

form, seen in connective tissues in almost all regions of the body. Type II is mainly seen in cartilage and vitreous humor, Type III is seen in skin, lung and vascular tissues and Type IV is seen in the basement membranes. Others are seen in minor quantities. About 30 genes are responsible for collagen synthesis, and the enzymes necessary for collagen synthesis.

Each polypeptide chain of collagen has about 1000 amino acid residues. The amino acid composition of collagen is quite unique. About 33% of the amino acids is **glycine**, that is, every third residue is glycine. The repetitive amino acid sequence may be represented as Gly - X - Y - Gly - X - Y - ; where X and Y are other amino acids, most commonly proline and hydroxyproline. Moreover, 4-hydroxyproline, 3-hydroxyproline and 5-hydroxylysine are found in fairly large proportions in collagen. The hydroxylated amino acid residues are of special functional significance.

## Synthesis of Collagen

The collagen is synthesized by fibroblasts intracellularly, as a large precursor, called procollagen (molecular weight 360 kDa). It is then secreted. The extracellular procollagen is cleaved by specific peptidases to form tropocollagen.

## Post-translational Modifications

The **hydroxylation of proline and lysine** residues of collagen is a post-translational modification taking place intracellularly. Prolyl hydroxylase and lysyl hydroxylase are both di-oxygenases using molecular oxygen. The enzyme also contains ferrous iron at its active site and requires a reducing agent like **ascorbic acid** to preserve the iron in the reduced ferrous state. So, vitamin C deficiency leads to poor hydroxylation. It is the major biochemical defect in scurvy (see Chapter 38). The hydroxylation is site specific. Proline is hydroxylated in position 4. Lysine is hydroxylated in position 5.

## Glycosylation of Procollagen

The hydroxylated polypeptides are next glycosylated. The common carbohydrate residues added are galactose and glucose, which are added sequentially by galactosyl and glucosyl transferases. The glycosylation occurs only on the **hydroxylysine** residues. The extent of glycosylation is different in various sites, e.g. tropocollagen in tendons has only 6 carbohydrate residues, whereas in the lens capsule there are about 110 units.

## Extracellular Maturation of Collagen

Inside the fibroblasts; polypeptides are synthesized, proline and lysine residues are hydroxylated and glycosylation of lysine takes place. Then the procollagen molecules are secreted. Outside the cell, procollagen is cleaved by fibroblast-specific peptidases. About 150 amino acids in N-terminal area and 300 amino acids in C-terminal area are cleaved off. Then tropocollagen molecules are assembled into collagen. Finally covalent crosslinks are formed. Deficiency of the peptidase leads to **dermatopraxis**, where the skin is prone to be torn easily.

## Triple Stranded Helix

The collagen is a rod like structure. Each of the 3 polypeptide chains is held in a helical conformation by

winding around each other. The resulting superhelical cable is made in a manner that 3.3 amino acid residues make one turn and each turn is separated by 2.9 Å. The three strands are hydrogen bonded to each other. Glycine, because of its small size can fit into the crowded interior of the collagen triple helix (Fig. 58.1). For the same reason, glycine also produces a shallow groove into which other polypeptide strands are intertwined.

Type IV collagen is an exception; the triple helices are discontinuous. Type IV is mainly seen in basement membranes, where it produces mesh like formation.

When a solution of collagen is boiled, the viscosity of the solution decreases. The native rod like structure is altered and a protein, with random coil structure results. It is then called **gelatin**.

## Quarter Staggered Arrangement

The tropocollagen molecules are arranged in a '*quarter staggered array*' to form the collagen fibers (Molecules in each row separated by 400 Å and adjacent rows by 680 Å). The structure repeats after each row (Fig. 58.2). Thus, the collagen fiber has **triple stranded, quarter staggered** arrangement. This arrangement helps in mineralization.

## Crosslinks in Collagen Fibers

The collagen fibers are strengthened by covalent cross-links between lysine and hydroxylysine residues. The crosslinks are formed by **lysyl oxidase** which converts these amino acids into aldehydes. These are called **aldol crosslinks**. Lysyl oxidase is a copper containing enzyme, the copper ion



Fig. 58.1: Triple stranded collagen fiber

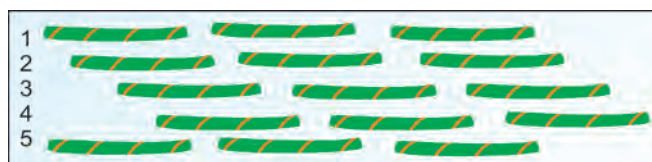


Fig. 58.2: Quarter staggered arrangement in collagen fiber; each row moves one-fourth length over the last row; the 5th row repeats the position of the first row

being located at its active site. Box 58.1 gives a summary of the steps in collagen formation.

In **copper** deficiency, reduced crosslinking of collagen results (see Chapter 39). The aldehyde derivatives of lysine residues can form an aldol condensation. Such aldol crosslinks are formed near the amino terminal of the chains.

The older the collagen, the more the extent of crosslinkages. The process continues, especially in **old age**, so that the skin, blood vessels and other tissues become less elastic and more stiff, contributing a great extent to the medical problems of the old people.

## Functions of Collagen

1. To give support to organs.
2. To provide alignment of cells, so that cell anchoring is possible. This in turn, helps in proliferation and differentiation of cells.
3. In blood vessels, if collagen is exposed, platelets adhere and thrombus formation is initiated.

## Degradation of Collagen

**Collagenases** are enzymes that can degrade collagen. Collagen is a protein resistant to attack by ordinary enzymes. The collagenase produced by *Clostridium histolyticum*, the pathogen responsible for producing gas gangrene splits each polypeptide chain at the site indicated; X-Gly-Pro-Y. The bacterium can destroy connective tissue barriers and this accounts for its invasiveness. Tissue collagenases are active in animals whose tissues have to undergo a great degree of remodeling, e.g. tadpoles. Adult human tissues do not have any appreciable amount of collagenase activity.

Degradation of collagen is seen when there is bone and cartilage resorption, osteoporosis, **tumor metastasis**, during postpartum involution of uterus, Paget's disease, rickets, osteoarthritis, rheumatoid arthritis, and scurvy.

### Box 58.1: Post-translational processing of collagen

#### Intracellular alterations:

- a. Hydroxylation of proline and some lysine residues.
- b. Glycosylation of some of the hydroxylysine residues.
- c. Formation of intrachain and interchain disulphide bonds, mainly in the carboxy and amino terminal ends.
- d. Formation of triple helix.

#### Extracellular alterations:

- a. Cleavage of 25–35 kDa portions at both carboxy and amino terminal ends.
- b. Formation of quarter staggered alignment.
- c. Oxidative deamination of epsilon amino groups of lysine and hydroxylysine residues.
- d. Formation of intra and interchain crosslinks.

## Abnormalities in Collagen

### *Osteogenesis Imperfecta*

It is inherited as a dominant trait. It is the result of a mutation which results in the replacement of a single glycine residue by cysteine (or other bulkier amino acid) in Type I collagen. Over 100 different types of mutations in the gene are reported. This change disrupts the triple helix near the carboxy terminus, hence the polypeptide becomes excessively glycosylated and hydroxylated. So, unfolding of the helix takes place and fibrillar array cannot be formed. The result is **brittle bones** leading to multiple fractures and skeletal deformities.

### *Ehlers-Danlos Syndrome (EDS)*

It is due to defective Type III collagen formation due to defective lysyl oxidase or lysyl hydroxylase. It is characterized by weakening of collagen, loose skin, hypermobile and lax joints. Hyperextensibility of skin and joints are the hall mark of this condition. 10 different types of this disease are described. In Type 4 EDS, the Type III collagen is abnormal. In Type 6 EDS, lysyl hydroxylase is absent.

### *Alport Syndrome*

Type IV collagen is abnormal, so basement membrane of kidney glomerular apparatus is abnormal. Hence hematuria is seen, which will eventually progress to kidney failure.

### *Epidermolysis Bullosa*

Type VII collagen (otherwise called anchoring fibril) is abnormal due to mutations in the gene. Skin blisters and breaks are observed.

### *Marfan's Syndrome*

Inherited as an autosomal dominant trait. Arachnodactyly (long digits), ectopia lentis (dislocation of lens), hyperextension of joints, aortic aneurysm are manifestations. A defect in the gene, coding for a connective tissue protein, **fibrillin-1**, leads to this disease. The gene for fibrillin-1 is on chromosome 15. Fibrillin-1 is a glycoprotein, with a molecular weight of 350 kDa. It is a *component* of microfibrils, which normally give the substratum for deposition of elastin. So, fibrillin and elastin are deposited in lower concentrations. Closely related protein, fibrillin-2 is produced by a gene

present on chromosome 5. Mutation in fibrillin-2 leads to congenital contractural arachnodactyly.

### Menke's Disease

Deficiency of copper results in defective function of lysyl oxidase, and reduced crosslinkage of collagen (see Chapter 39).

### Deficiency of Ascorbic Acid

It is characterized by defective hydroxylation of collagen. The collagen formed is weak, leading to fragility of blood vessels, poor wound healing, etc. (see Chapter 38).

### Hyperhomocysteinemia

The accumulated homocysteine in this condition, reacts with lysyl aldehydes to block crosslinking. The skeletal deformities, vascular and ocular defects are thus produced (see Chapter 16 and 25).

### Lathyrism

It is due to ingestion of lathyrus sativa or sweet pea. It is due to a toxic agent beta oxalyl amino alanine (see Chapter 40). This compound has been found to inhibit lysyl oxidase. This would interfere with formation of lysyl crosslinking.

## ■ ELASTIN

Elastin is a protein found in connective tissue and is the major component of elastic fibers. The elastic fibers can stretch and then resume their original length. They have high tensile strength. They are found in the ligaments as well as in the walls of the blood vessels, especially large vessels like aorta. One-third of the residues are glycine. Proline is present in large amounts, so also alanine. Hydroxyproline is present in small amounts while hydroxylysine and glycosylated hydroxylysine are absent. Triple helix structure is also absent. When elastin matures, **desmosine** cross links are formed from 4 lysine residues. (Collagen has **aldol cross links**, while elastin has **desmosine crosslinks**). **Once mature**, elastin is very stable; the turn over rate is very low.

**Williams-Beuren syndrome:** The gene for elastin is in chromosome 7. Deletion of this gene leads to a clinical condition called Williams-Beuren syndrome with severe developmental abnormalities in connective tissues all over the body.

**Pseudoxanthoma elasticum:** It is an inherited defect in the formation of elastin. Clinical manifestations are similar to Ehlers-Danlos syndrome.

**Copper deficiency:** Copper deficiency blocks the formation of aldehydes, which are essential for crosslinking. Some lysine residues are oxidized by copper containing **lysyl oxidase** and the resulting aldehyde

derivative can condense with an unmodified lysine to form lysino-norleucine. The elastic nature of elastin fiber is due to these different crosslinks.

### Fibronectin

Fibronectin is a cell surface protein that is involved in the interaction of cells with the extracellular matrix. It has been found to play key roles in cell adhesion, cell migration, blood clotting and wound healing. Deficiency of fibronectin in tumor cells account for their lack of adhesive properties and chances of metastasis (see Chapter 57). Plasma fibronectin is produced by hepatocytes and secreted into bloodstream. Cellular fibronectin is produced by fibroblasts. Fibronectin has binding sites for collagen, integrin, heparin, fibrin, DNA and cell surface. The fibronectin binds to cells through the integrins present on the cell surfaces. Fibronectin receptor interacts with actin microfilaments present in the cytosol. Fibronectin is a glycoprotein, a dimer, each subunit has molecular weight of 230 kDa.

### Laminin

It is a basement membrane protein with adhesive properties that enable epithelial cells to fix to underlying connective tissue. It is the first extracellular matrix protein manifested during embryogenesis. It has a vital role to play in neuronal outgrowth and nerve regeneration. It is a glycoprotein with three polypeptide chains. High levels of laminin have been reported in patients suffering from Alzheimer's disease. Increased expression of laminin is associated with senile plaques and amyloid proteins.

Basal lamina is made up of laminin, **entactin**, Type IV collagen and heparan sulfate. Laminin is an elongated molecule, with molecular weight of 850 kDa.

### Keratins

Keratins are proteins present in hair, skin and nails, horn, hoof, etc. The fibers present are called alpha keratins and matrix as keratohyalin. They mainly have the alpha helical structure. Each fibril has 3 polypeptide chains and each bundle has about 10–12 fibrils. The keratohyalin matrix has cysteine-rich polypeptide chains which are held together by disulfide bonds. The more the number of disulfide bonds, the harder the keratin is. Moreover, covalent bonds are also seen between lysine and glutamic acid residues of adjacent polypeptide chains, forming amide bonds (similar to formation of hard clot).

The keratin present in hair has significantly more number of disulfide bonds, which give the mechanical strength. On disrupting these bonds by reduction, the solubility increases, while the tensile strength decreases. This is used in artificial waving of hair.

### Contractile Proteins

Movement is an important property of life, especially of the members of the animal kingdom. The organism may move as a whole (walking) or movement of cells may occur (diapedesis or sperm movement) or it may occur at the subcellular level (transfer and exocytosis of secretory proteins). The important contractile proteins are **actin** and **myosin** in muscles. Beating of cilia or sperm is achieved by **tubulin** and **dyenin**. Tubulin, actin, microfilaments, kinesin, and intermediate filaments



are involved in the movement of secretory granules from their site of production to their release.

### Kartagener's Syndrome

Absence of dyenin in cilia and flagella results in immotile cilia and flagella. This will lead to chronic respiratory infection and male infertility.

## MUSCLE PROTEINS

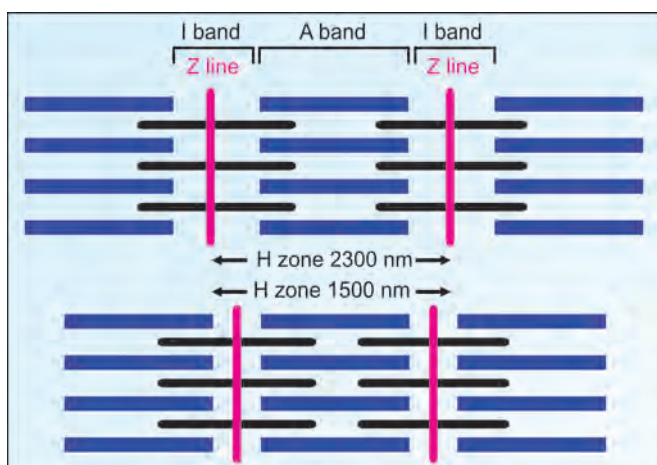
Striated muscle is made up of multinucleated cells bound by plasma membrane called **sarcolemma**. Sarcomere is the functional unit of muscle. Each muscle cell contains myofibrils about 1 mm in diameter. The myofibrils are immersed in a cytosol that is rich in glycogen, ATP, creatine phosphate and glycolytic enzymes.

The functional unit of a myofibril is a **sarcomere**. The dark A bands and light I bands alternate regularly (Fig. 58.3). The central H zone of A band is lighter, while the dark M line is found in the middle of the H zone. The I band is bisected by a very dense narrow Z line.

These bands are formed by variable combination of thick and thin filaments (Fig. 58.3). The thick filaments have a diameter about 150 Å whereas thin filaments have a diameter about 70 Å.

The thick filament is primarily **myosin** and thin filament contains **actin**, **tropomyosin** and **troponin**. The Z line contains 2 actin molecules and M protein is located in the M line (Fig. 58.3).

Thick and thin filaments slide past each other during the muscle contraction, so that the muscle shortens by as



**Fig. 58.3:** Sliding and shortening of actin and myosin is the basis of muscle contraction. Compare the distance between Z lines in the upper and lower pictures

much as a third of its original length. However, the lengths of the thick and thin filaments do not change during muscle contraction (Fig. 58.3). The mechanism is explained in Figure 58.4.

### Myosin

Myosin has 3 different biological activities:

- Myosin molecules assemble into filaments.
- Myosin acts as the enzyme ATPase.
- Myosin binds to actin polymer which is the major component of the thin filaments.

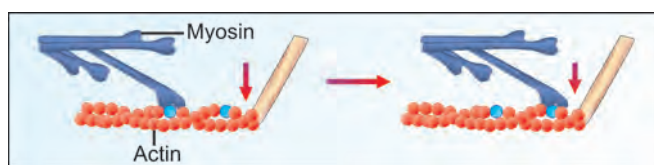
Myosin molecules are large (about 540 kD), each with 6 polypeptide chains; 2 identical heavy chains and 4 light chains. The myosin molecule has a double headed globular end. They are joined to a long double stranded alpha helical coil formed by the heavy chain. At the head portion of each heavy chain, 2 light chains are bound. The heavy chain is thus demarcated into an amino terminal globular head and C-terminal tail (Fig. 58.5). Part of the amino acid sequence in the heavy chain is similar to that at the active site of other ATPases.

Trypsin cleaves myosin into 2 parts; light meromyosin (LMM) and heavy meromyosin (HMM) types (Fig. 58.6). The LMM can form filaments but has no enzymatic activity. HMM has enzymatic activity and binds actin, but cannot form filaments. HMM can further be split into the S1 fragments having the ATPase site plus the actin binding site and the S2 subfragment.

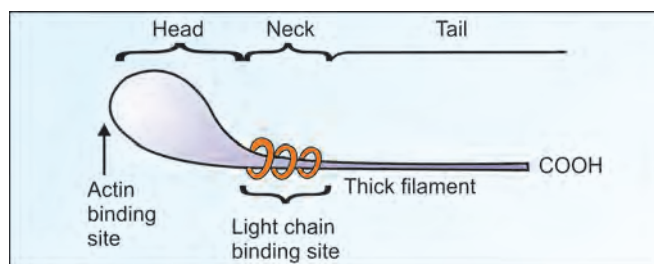
### Actin

It is the major protein of the thin filaments. It is a monomeric protein often referred to as G-actin due to its globular shape. It can polymerize into a fibrous form, called F-actin, which is a helix of actin monomer.

The muscle contraction results from interaction of actin and *myosin*, to form *actomyosin*, with energy provided by *ATP*. When the two thin filaments that bind the cross bridges of a thick filament are drawn towards each other, the distance between Z lines becomes shorter (Figs 58.3 and 58.4).



**Fig. 58.4:** During muscle contraction, myosin moves over actin filament



**Fig. 58.5:** Heavy chain of myosin

This could result in the process of contraction of muscle fibers. This needs energy from hydrolysis of ATP, effected by the ATPase activity of myosin. The cyclical events are depicted in Figure 58.7.

The contractile force is generated by conformational changes, leading to dissociation of actin and S1 heads of myosin. There is a reversible attachment and detachment of myosin S1 head to actin. This is due to the hinge like movements between the domains of myosin.

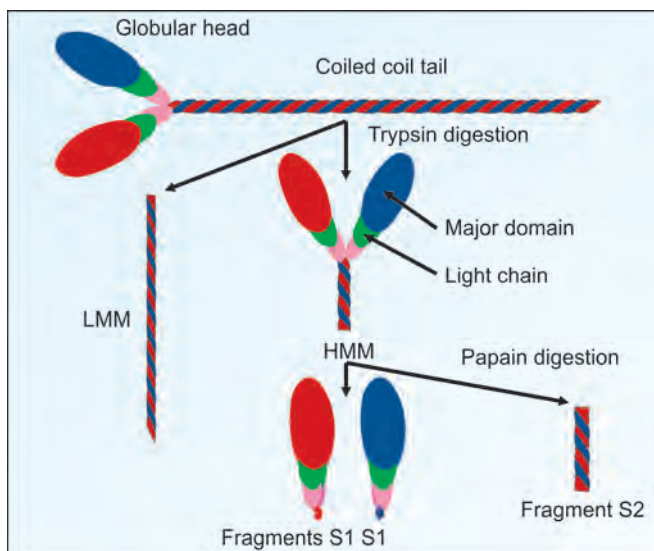
## Troponins

The muscle contraction is modulated by troponin and tropomyosin through  $\text{Ca}^{++}$  which is the physiological regulator of muscle contraction. In the resting muscle, the  $\text{Ca}^{++}$  is within the sarcoplasmic reticulum. The nerve impulse releases  $\text{Ca}^{++}$  from the sarcoplasmic stores and increases its cytosolic concentration about 10 times (1 mM to 10 mM). The action of calcium is brought about by 2 proteins, troponin complex and tropomyosin located in the thin filament.

The troponin complex has 3 different polypeptide chains. Out of this, **troponin-C** (TnC, 18 kD) binds calcium. **Troponin-I** (TnI, 21 kD), otherwise called “actomyosin-ATPase inhibitory element”, binds to actin and inhibits binding of actin to myosin. Troponin I is a marker for myocardial infarction (see Chapter 23). Its level in serum is increased within 4 hours of myocardial infarction, and remains high for about 7 days. It is about 75% sensitive index for myocardial infarction. The cardiac form of TnI is 31 amino acids longer than the skeletal muscle form of TnI. Cardiac isoform of TnI has a molecular weight of 24 kD.

**Troponin-T** (TnT, 37 kD) binds to tropomyosin. Two isoforms of cardiac TnT, called TnT1 and TnT2 are present in adult human cardiac tissue. Serum levels of TnT2 increases within 4 hours of myocardial infarction, and remains high for up to 14 days. The TnT2 is 100% sensitive index for myocardial infarction.

The TnC has both high affinity (C-terminal) and low affinity (N-terminal) calcium binding sites. TnC has calmodulin like properties. In the resting muscle, only the high affinity sites are occupied by Calcium, but when  $\text{Ca}^{++}$  is released from sarcoplasmic reticulum, low affinity sites



**Fig. 58.6:** Proteolytic digestion of myosin  
LMM: Light meromyosin; HMM: Heavy meromyosin

are also occupied by  $\text{Ca}^{++}$ . This results in a conformational change that is transmitted to tropomyosin. This shift in position of tropomyosin alters the binding of actin to S1. The events may be depicted as  $\text{Ca}^{++} \rightarrow \text{troponin} \rightarrow \text{tropomyosin} \rightarrow \text{actin} \rightarrow \text{myosin}$

## Transduction of Chemical Energy to Mechanical Energy

The amount of ATP in muscle is sufficient to sustain contractile activity for less than one second. The reservoir of high energy phosphate in skeletal muscle is creatine phosphate. The reaction (*Lohman's reaction*) is catalysed by Creatine Kinase (CK) (see Chapter 23).

$$\text{Creatine phosphate} + \text{ADP} \xrightarrow{\text{CK}} \text{ATP} + \text{Creatine}$$

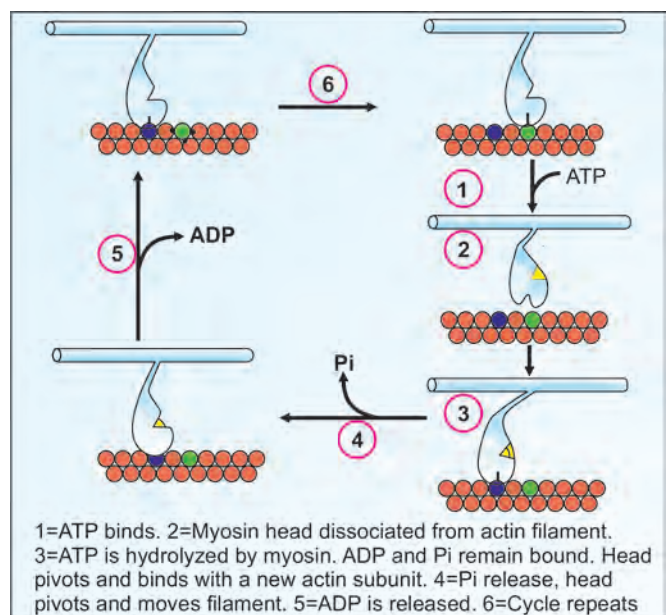
The  $\Delta G^\circ$  of creatine phosphate is -10.3 kilocalories per mol, whereas that for ATP is only -7.3 kilocalories. Resting muscle has a high concentration of the creatine phosphate (25 mM) when compared to ATP (4 mM). The creatine phosphate is therefore able to provide a high ATP concentration during muscle contraction (In athletes, it is the major source of energy during the first 4 seconds of a short sprint).

During muscle contraction, the ATP level remains high as long as creatine phosphate is present. But following contractile activity, the levels of ADP and  $\text{P}_i$  rise. The reduced energy charge of active muscle stimulates glycogen breakdown, glycolysis, TCA cycle and oxidative phosphorylation. The red striated muscle has an active aerobic metabolism compared to white muscle.

In smooth muscle, the contraction is not regulated by the troponin-tropomyosin mechanism, but through calcium mediated phosphorylation of myosin light chains.

## Calcium and Muscle Contraction

**Sarcoplasmic reticulum** (SR) regulates intracellular levels of calcium in skeletal muscle. In the resting state, calcium ions are pumped into the SR through Ca-ATPase. Inside the SR, calcium ions are bound with specific



**Fig. 58.7:** Cycle of events in muscle contraction

calcium-binding protein, called **Calsequestrin**. When nerve impulse excites the sarcolemma, the calcium channel is opened, calcium ions are released from SR into sarcoplasm. The calcium ion concentration in the cytoplasm is increased to 3000 fold. The calcium binding sites of TnC are now saturated with calcium. The TnC-4Ca<sup>++</sup> complex attaches with TnI and TnT, which then interacts with tropomyosin. This starts the contraction cycle depicted in Figure 58.7.

The calcium release channel is also known as the **ryanodine receptor** (RyR). The RyR1 is present in skeletal muscles and RyR2 in cardiac muscles. The receptor is so named because Ryanodine, a plant alkaloid could bind with the receptor. The channel is ligand-gated; calcium ions and ATP act synergistically. The sequence of events in the muscle contraction and relaxation are summarized in Box 58.2. Nitric oxide is a powerful muscle relaxant (see Chapter 17).

### Inherited Diseases due to Abnormality of Proteins

In **Malignant hyperthermia**, following halothane and succinylcholine (used in anesthetic practice) high fever is seen. Here calcium channels remain open, and so cytosolic calcium concentration is remains high. The drug of choice in the treatment is dantrolene, which inhibits release of calcium from the sarcoplasmic reticulum, so that cytoplasmic calcium is kept at a reduced rate. In this condition, there are different mutations in the **calcium release channel protein** (*RyR1* gene) or in *DHPR* gene (**dihydropyridine receptor**, a voltage gated calcium channel).

**Dystrophin** is a structural protein, attached to muscle cell membrane. Dystrophin is part of a large complex, consisting of dystroglycan, laminin and sarcoglycans. Dystrophin links the actin of cytoskeleton of the cell into the extracellular matrix. Mutations in the dystrophin gene cause Duchenne muscular dystrophy or a milder form called Becker muscular dystrophy. Some forms of cardiomyopathy are also related to mutations in dystrophin. Mutations in sarcoglycans cause limb girdle dystrophy. Mutations in the genes for the glycosyl transferases (which add the sugar groups to proteins) are also responsible for some types of muscle dystrophies. Mutations in the cardiac myosin heavy chain cause familial hypertrophic cardiomyopathy.

### Cellular and Subcellular Movements

In multicellular organisms, maintenance of the size and shape of the cell is essential for cellular function. At subcellular levels, transfer of

#### Box 58.2: Muscle contraction-relaxation events

1. Nerve impulse releases acetyl choline (ACh) at motor end-plate. This ACh binds with the receptors.
2. Sodium-potassium conductance in neuromuscular end-plate, so that a potential is generated at the endplate.
3. This is transmitted as the action potential to muscle fibers.
4. Depolarization; release of calcium ions from SR
5. Binding of calcium ions to TnC.
6. Crosslink formation between actin and myosin
7. Sliding of thin filaments over thick filaments; muscle contracts.
8. Calcium is pumped back into SR.
9. Release of calcium from troponin.
10. Actin and myosin are separated; muscle relaxed.

secretory granules from its sites of production to the exterior of the cells is important (e.g. hormone secretion). Cells also need contractile proteins for self-propulsion (e.g. Leukocyte migration, movement of the sperms).

### Cytoskeleton

The plasma membrane of a cell is anchored to the cytoskeleton. It is made up of a network of microfilaments and microtubules, and is responsible for the shape of the cell, its mobility and chromosomal movements. RBC cytoskeleton contains **spectrin**, a tetramer composed of alpha (240 kD) and beta (220 kD) polypeptides, as well as **ankyrin** (200 kD) which binds to spectrin. A meshwork of actin filaments and spectrin is attached to the plasma membrane by ankyrin. Spectrin and ankyrin are seen not only in RBCs, but in the microtubular network of a large variety of cells. **Adducin**, a calmodulin associated protein increases spectrin binding to actin. In the muscle, **dystrophin** joins a sarcolemmal glycoprotein to the actin filament. (Dystrophin is deficient in Duchenne muscular dystrophy).

### Calmodulin

It controls the contractile apparatus and cytoskeleton through calmodulin-binding proteins. Spectrin (erythrocyte) and spectrin-like proteins (brain and other tissues), are major members of the cytoskeleton. Tau protein (brain micro tubules) and **caldesmon** (smooth muscle) are *collectively referred to as flip-flop switch proteins*. These proteins interact with calmodulin and cytoskeletal proteins (tubulin or actin). Calcium first binds calmodulin, that attaches to calmodulin-binding protein, which in turn connect with the target proteins in cytoskeleton. Calmodulin is a calcium-activated switch. It has 2 high affinity calcium binding sites. When calcium is bound, there is a conformational change in calmodulin; this exposes the active centre. Calmodulin binds with myosin light chain kinase and phosphorylase kinase of glycogen degradation (see Fig.10.2).

### Microfilaments

Main constituent of the microfilaments is actin. **Actin** may occur as monomer (G) or polymer (F), depending on the ratio of ATP/ADP in the cells. Polymerization of actin occurs in the presence of Mg<sup>++</sup> and K<sup>+</sup> ions. Repeated dissociation and reassembly of actin is essential for cell motility.

### Microtubules

Intracellular movement of the secretory granules is achieved by microtubular system. These consist of alpha and beta **tubulins**. The functions include formation of mitotic spindle, and movement of secretory granules (exocytosis or endocytosis). They also form integral part of axons and involved in axoplasmic transport of materials. Microtubules energize cilia and flagella for cell movement. Cytoplasmic microtubules are composed of tubulin (55 kD) and several accessory proteins called MAPs (**microtubular associated proteins**) (300 kD and 60 kD).

### Intermediate Filaments

Integrity of the cell is maintained by structural proteins, belonging to the microfilament intermediate class. The size of these filaments is midway between microtubules and microfilaments. They are structurally more



stable and do not undergo chemical or physical conformational changes. Hence they act more as a structural protein for the integrity of cytoskeleton. The groups of intermediate filaments include keratin, **desmin**, **vimentin**, neurofilaments and glial filaments. Intermediate filaments are of 6 types; Type I (acidic keratin), Type II (basic keratin), Type III (vimentin-like, vimentin, desmin, glial fibrillary acid protein), Type IV (neurofilaments, NF-L, NF-H and NF-M), Type V (nuclear lamins A, B and C) and Type VI (nestin). Epidermolysis bullosa simplex is due to mutations in either of the two types of keratins.

## ■ LENS PROTEINS

India has the maximum number of blind persons in the world. Cataracts and opacities of cornea are the cause for 70% of blindness. The eyes of older people and diabetics are prone to cataract formation. Being avascular, lens relies on the aqueous humor for the provision of oxygen and essential metabolites. Uppermost part of the lens consists of a monolayer of epithelial cells, which divides and differentiates to form the long fibre cells, that make up the lens. These normal lens cells (but not the old cells) possess the usual protein synthesizing machinery. The proteolytic activity of the lens is quite low and is due to the presence of endogenous protease inhibitors. Lens tissue has a very active HMP shunt pathway, and has the maximum concentration of NADPH. Lens also contains high quantity of ascorbic acid. They scavenge the free radicals and maintain the transparency of lens.

### Crystallins

Major lens proteins are alpha, beta and gamma crystallins. Small quantities of delta and epsilon varieties are also described. They undergo no replacement throughout the life of the individual. There is no turnover of these proteins. The proteins at the centre of the lens are as old as the individual. The orderly arrangements of the molecules make the lens proteins transparent. Alpha crystallin is present not only in lens, but is seen in almost all cells of the body.

### Cataracts

When there is change in three dimensional structure of lens proteins, the lens becomes opaque (Fig. 58.8). This is similar to the clear albumin becoming white and opaque when heated and denatured. In diabetes mellitus, when the blood glucose level is increased, lysine residues of these proteins are glycosylated. This leads to increased susceptibility for sulphhydryl oxidation and consequent aggregation of the proteins, resulting in opalescence and cataract. Protein aggregates with molecular weight more than 50 million will produce scattering of light.

In lens, the enzyme aldose reductase reduces monosaccharides to corresponding sugar alcohols; glucose to sorbitol and galactose to galactitol. These polyols do not readily cross cell membranes and hence accumulate; causing osmotic swelling, and consequent disruption of cell architecture. Thus **diabetes mellitus** (increased glucose in blood) and galactosemia (high galactose level) cause cataract. Drugs that inhibit aldose reductase are shown to retard cataract formation in diabetic rats.

## ■ PRIONS

The central dogma in molecular biology postulated by Watson and Crick in 1953 was that genetic information passes from DNA to RNA

and then to protein. In general, this rule still holds good. In 1970, Temin and Baltimore showed that DNA could be synthesized from RNA by reverse transcriptase. This has partly shattered the central dogma. But could proteins act as an information molecule? Could proteins replicate themselves? This question was considered to be heretical till a few years ago, but no longer so. There are a few diseases characterized by very long incubation period of many years. These “slow disease agents” were originally thought to be “unconventional viruses”, but now they are proved as prion proteins.

## Prion Proteins : Abnormal Tertiary Structure

“Prions” is the acronym for “proteinaceous infective particles”. Stanley Prusiner has described **prion proteins (PrP)** in 1982, who was awarded Nobel Prize in 1997. PrP is a normal protein of 253 amino acids, found in leukocytes and nerve cells. The matured prion protein (PrP) has 210 amino acids. It exists as a sialoglycoprotein, anchored on the cell surface. PrP molecules can undergo a change in structural conformation. The altered molecule is resistant to heat and proteolytic enzymes. The abnormal protein is called **PrP<sup>sc</sup>**; “sc” stands for scrapie, the disease in which it was first isolated. Thus, **prions are proteins with correct primary structure, but with abnormal tertiary structure**. The PrP is in alpha helical form; but PrP<sup>sc</sup> is in beta pleated sheets (Fig. 58.9).



Stanley  
Prusiner  
NP 1997  
b. 1942



Baruch  
Blumberg  
NP 1976  
1925–2011

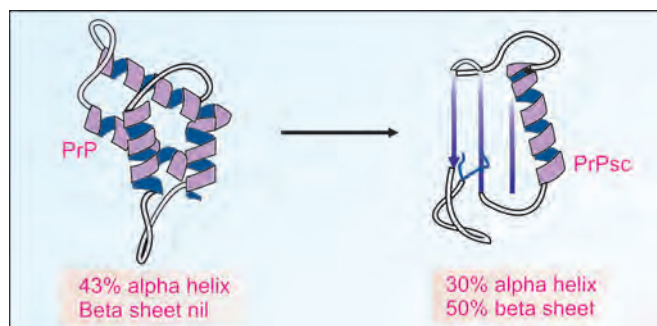


Carleton  
Gajdusek  
NP 1976  
1923–2008



Fig. 58.8: Cataract. Lens becomes opaque





**Fig. 58.9:** Prions have correct primary structure, but have altered tertiary structure

Protein folding occurs in a stepwise process. As the polypeptide is being synthesized by the ribosome, the initial segment of protein starts to fold. That in turn favours only certain foldings in the next part of the protein. By this time, hydrophobic regions aggregate into interior of the protein molecule. Chaperons (see Chapter 46) also help in the formation of correct folding of proteins. This process is orderly. Minor alterations in the process may alter the tertiary structure.

## Abnormal Proteins can be Infectious

A normal gene makes the normal PrP protein. Disease is produced when the gene is mutated or if an abnormal PrPsc is injected or ingested. The “**Seeding Model**” explains that the infectious prion induces the nearby normal protein molecules to unfold to abnormal form. It is similar to the conversion of the good “Dr Jekyll” to the criminal “Mr Hyde” (same person with two personalities, described in the famous novel). These abnormal proteins now convert further normal proteins into abnormal varieties, producing a “chain reaction” that generates new infectious materials.

## Pathogenesis of Prion Diseases

The lysosomal enzymes could break down the normal PrP; but PrPsc cannot be digested. Hence, the prions are accumulated inside the cells, and eventually the cell dies. One part of prion protein can cause apoptosis (programed cell death), which also leads to loss of cells. As a group, they are also called **transmissible spongiform encephalopathies (TSE)**, because the brain becomes riddled with small holes like a sponge. Neurons degenerate, protein deposits may accumulate as plaques and glial cells grow larger. Clinically, rapidly progressive dementia sets in with neurological defects and ataxia. All the prion diseases are slowly progressive, but eventually become fatal.

## Human Prion Diseases

Prion diseases in human beings are **Kuru**, Creutzfeldt-Jakob disease (**CJD**), Gerstmann-Straussler-Scheinker disease (**GSSD**) (familial CJD) and fatal familial insomnia (**FFI**). Cerebral cortex becomes sponge like in CJD. Thalamus is affected in FFI. In Kuru, cerebellum is affected. It is

seen in Fore aborigines in Papua New Guinea. The term “Kuru” means “laughing death” in the tribal language. Baruch Blumberg showed that the disease was transmitted by ritual cannibalism (eating of brain of dead person); Carleton Gajdusek isolated the “unconventional virus” from the affected individuals; both of them were awarded Nobel Prize in 1976.

## Prion Diseases in Animals

Classical example of the “slow disease” is **scrapie** disease in sheep. It is characterized by constant scratching; hence the name. The disease is manifested only about 10 years after the entry of the agent. In **Bovine spongiform encephalopathy (BSE)** (mad cow disease) the brainstem is affected. It has resulted in economic disaster in Great Britain in 1996. Cattle feed containing infected meat from sheep suffering from Scrapie caused the entry of prions into millions of cows. Thus, it is obvious that prions had crossed the species barrier from sheep to cattle. Could it cross to human beings? Hundreds of thousands of infected animals have been eaten by Europeans. Already there are reports that some of them did get CJD; this is called new variant of CJD (nvCJD).

## Alzheimer’s Disease (AD)

It was first reported by Aloysius Alzheimer in 1906. It is not proved to be a prion disease. But it is known that the disease is due to alteration of a normal protein. About 5–10% of people above 60 years are affected by AD. As the number of aged persons is increasing, the condition is becoming a major health problem in India. It is characterized by slow progression of memory loss, confusion, dementia, hallucinations, personality changes, and finally patient enters into a vegetative state with no comprehension of the outside world. Shakespeare’s King Lear; who is losing his memory and becoming disoriented is a well-known example. Patient may require round the clock care and protection. The abnormal behavior of patient affects the whole family and is a serious psychosocial problem. Death occurs about 10 years after the first onset of the symptoms. There is no definite treatment now available. The drug that antagonizes N-methyl-aspartate receptors is available, which will slow down the progression of the disease. Omega-3 fatty acids may be helpful in prevention of the disease.

## Molecular Defects in AD

The pathological hallmarks of AD are neurofibril tangles in CNS, senile neuritic plaques and cerebral amyloid deposition. Inflammation within the brain plays a role in the development of Alzheimer’s disease; and long-term use of anti-inflammatory drug was found to reduce the incidence of this disease. The **neurofibrillary tangles** are paired helical filaments made up of **Tau protein**. Normal Tau is soluble and catabolized easily; but abnormal Tau is insoluble, cannot be degraded by tissue cathepsins and are deposited around neurons. Tau is required for stabilizing axonal microtubules, the communication channels in nerve fibres. As insoluble Tau is deposited, there is loss of microtubules in AD. The synthesis of acetylcholine is also reduced, leading to memory loss. Diabetes mellitus and hypertension are associated risk factors for AD.

## Amyloid Precursor Protein (APP)

Neuritic plaques are composed of **beta-APP**; a 40 amino acid fragment derived from APP (Amyloid precursor protein). APP is a normal

constituent of human serum. It is produced by a gene located in the long arm of chromosome No. 21. Mutation in APP gene leads to a valine to isoleucine substitution. Then APP cannot be cleaved at appropriate position. Alpha secretase cleavage produces soluble APP where as beta secretase cleavage produces beta protein which gets deposited. It is also known that **aluminium** can change the alpha helices of APP into beta-pleated sheets; then also APP becomes insoluble. This is similar to prion action. Aluminium toxicity causes AD-like disease.

**Alpha secretases** are a family of proteolytic enzymes that cleave amyloid precursor protein (APP) in its trans-membrane region. Action of beta and gamma secretases on the amyloid precursor protein can result in the formation of a toxic conformation, called alpha-beta peptide. Alpha secretases are members of the ADAM (a disintegrin and metalloprotease domain) family, which are expressed on the surfaces of cells and are used to anchor cells on the cell membrane. Upon cleavage by alpha secretases, APP releases a fragment known as APPs-alpha into the extracellular environment. The secretase complex is a prime target for pharmacological intervention in Alzheimer's disease and so far drug discovery efforts have yielded a large variety of potent and rather specific inhibitors of this enzymatic activity. However, as gamma-secretase is able to cleave a wide variety of physiological important substrates, the real challenge is to develop substrate-specific compounds.

The **amyloid precursor protein** (beta APP) is cleaved by beta and gamma secretases to form amyloid beta protein (AbP) with 40-42 amino acids. The AbP fibrils are proved to be neurotoxic by studies **conducted on mice. Early onset of Alzheimer's have been seen in patients** with Down's and those with mutations in Beta PP. The gene encoding Beta APP is located on Chromosome 21 and in trisomy 21 the rate of production of beta APP and therefore AbP is increased. The toxic effects of neurofibrils include oxidative injury, changes in intracellular calcium homeostasis and cytoskeletal reorganization. Transmembrane proteins **presenilin 1** and presenilin 2 gene mutations have also been found to be responsible for excessive production of AbP.

27-hydroxycholesterol (27-OHC) may regulate a number of key enzymes within the brain. It regulates the generation of beta-amyloid peptides. 27-OHC is able to suppress expression of cytoskeleton-associated protein (Arc), a protein important in memory consolidation which is reduced in patients with Alzheimer's disease (AD).

The amounts of soluble amyloid precursor protein beta (sAPP $\beta$ ) and Tau in CSF were significantly higher in people who went on to develop Alzheimer's disease. There is a clear correlation between DHEA in blood and the degree of cognitive impairment found in Alzheimer's disease, this is another promising test.

### Familial AD and Apo-E4 gene

About 30% cases have genetic background; and these are called familial AD. Genes identified with AD are that coding for APP, presenilin-1 (chromosome 14), presenilin-2 (chromosome 1) or AD3 (chromosome 14) or AD4 (chromosome 1). Another major susceptibility gene for AD is the **Apo-E4** (apolipoprotein E4) gene situated in chromosome

number 19. The presence of Apo-E4 gene is the major risk factor for AD. **Apo-E2** gene reduces the risk of AD. Apo-E2 acts as chaperone for the production of Tau. But apo-E4 binds with Tau to form tangles. Apo E gene is polymorphic and located on gene 19. There are three alleles of this gene with 6 possible combinations. Of these, the genotype acquisition of two apo-epsilon-4 allele increases the risk for Alzheimer's disease about 8 fold. Each copy of the gene is increasing the risk and shifting the age of onset. Other genes on chromosome 12, 14 and 21 are implicated in the rare early-onset type of the disease. Abnormal forms of gene *S182* located on chromosome 14 are responsible for early-onset familial Alzheimer's disease.

### Parkinsonism

Parkinsonism is a degenerative disease, affecting muscular coordination. Two new genes associated with Parkinson's disease have been reported. The first, called **alpha-synuclein**, is mutated in Parkinson's disease. The second, codes for a protein called **parkin**, which is associated with a juvenile form of Parkinson's disease. In most of the Parkinson's diseases, an inclusion body, known as a **Lewy** body, is seen in many regions of the brain. The Lewy body is associated with neuronal degeneration and is also seen in Alzheimer's disease. Alpha-synuclein is also found in Lewy bodies.

### Protein Misfolding Diseases

Most proteins in the body maintain their natural configuration or if that is partially lost are renatured by the action of molecular chaperones. If not successful, they will be degraded. However, about 18 different diseases, most of them fatal, are associated with extracellular deposition of normally soluble proteins, which become insoluble as amyloid deposits. These include Alzheimer's disease, Transmissible spongiform encephalopathies and other forms of familial amyloidosis. All these diseases are due to misfolding of proteins leading to a toxic conformation. A common feature in the altered conformation of the protein is the change from alpha helical to beta sheet structure which makes the proteins and aggregates resistant to normal proteolysis. The cause may be mutations, defects in chaperones or presence of inappropriate proteins.

Fibrillogenesis is initiated by the association of beta domains of two or more unfolded or misfolded amyloidogenic proteins to form a more extensive beta sheet. More protein molecules are recruited by the toxic conformer to form plaques.

Misfolded proteins undergo endoplasmic reticulum associated degradation. Disorders due to defective intracellular membrane transport include Chediak-Higashi syndrome, combined deficiency of factors V and VIII, Hermansky-Pudlak syndrome, I-cell disease, ocular-cerebrorenal syndrome, etc.

### Tau Protein

Normal function of Tau protein is to stabilize the microtubules in neurons by enhancing polymerization of tubulin. Tauopathies result from hyperphosphorylation of tau proteins leading to formation of fibrillar polymers. There is enhanced activity of protein kinases and diminished activity of protein phosphatases.

## BIOCHEMISTRY OF AGING

Aging is a natural phenomenon. As the average lifespan is increasing in developing countries, the percentage of aged persons in the population is also increasing. In India, 7% of the population are above 60 years. The medical branch dealing with age related diseases, is called *Geriatrics* or *Gerontology*. All the *physiological processes decline* as age advances. However, differences are observed in individuals, with regard to the disease progression, or how much physical and mental functions are deteriorated. These may be due to differences in lifestyle, diet, diseases and genetics. Onset of aging is earlier in persons with hyperglycemia, hyperlipidemia and hypertension. Obesity and lack of exercise are other factors which hasten the ageing process. Numerous theories have been proposed to explain the causes of aging. The simplest theory is that aging is governed by an organism's genetic inheritance or "Genetic clock". Organisms may have "aging genes" that control the rate of aging and thus lifespan.

### Cellular Theories of Aging

Hayflick found that cultured human fibroblasts double only a limited number of times before they deteriorate, become senescent (aged), lose their capacity to divide and finally die. The number of cell divisions of cultured cell is roughly related to (a) the age of the cell donors and (b) the longevity of the species. For example, fibroblasts from the human embryos, when sustained in tissue culture, divide about 50 times before they die. Those taken from person after birth divide only 20 to 30 times. Many theories have been proposed for explaining why cells become incapable of divisions.

- Mutation or "error" theory:** Most biologists of gerontology, believe that as a person grows older, his genetic material (DNA) gradually becomes impaired. This deterioration may in some cases be caused by accumulated errors in the replication of DNA. Thus mutation may cause ageing.
- "Error catastrophe" theory:** According to this theory accumulation of errors in the amino acid sequence in proteins, specially errors that affect the specificity of enzymes needed for protein synthesis, will result in further mistakes in protein synthesis and consequently will lead to cell deterioration and death. These errors may not be the result of blind chance but may be purposefully programed by the "aging genes".
- Free radical reaction theory:** It is proposed that certain free radicals generate oxidative reactions which can lead to the deterioration of lipids, collagen elastin and other body substance and may cause aging (see Chapter 33).

### Pacemaker Theories of Aging

Aging is caused in part by progressive breakdown in the immunological system. At present, evidence strongly indicates that the age-related decline in the immunological functions is mainly due to the decrease in activity of the T cells. The body can also produce antibodies called **auto-antibodies** that attack not only foreign substances but also to the natural proteins of the body. These auto-antibodies are speculated to cause age-associated diseases such as rheumatoid arthritis, systemic lupus

erythematosus, etc. As age advances, immunological system becomes less able to distinguish "self" from "non-self" and as a result, proceeds to destroy normal and desirable proteins of the body.

### Chalones

In normal tissues of the full-grown mammals an equilibrium state is reached between mitosis and cell death. Such **inhibition of cell division** is apparently the result of products of the tissues themselves. These tissue-specific inhibitors of mitosis are collectively called **chalones**. Each tissue produces 2 types of chalones, one of low molecular weight (about 1000 to 3000) and another of high molecular weight (about 30,000 to 50,000). When cells in tissue culture are freed of chalones by washing they resume mitosis and proliferation. Chalones presumably attach to specific receptor sites on cell membranes and exert their inhibitory effects. In summary, the major contributory factors of aging process are: a) Reactive oxygen species; b) Cellular senescence; c) Apoptosis or programmed cell death; d) Somatic mutations in cellular and mitochondrial DNA.

### Telomerase

Another molecular cause for senescence is the declining activity of **telomerase** (see Fig. 44.19). Telomerases are essential for stabilizing the chromosomes. As age of the cell progresses, telomerase activity progressively decreases. So there is sequential shortening of the length of the DNA at each division. This leads to eventual cell death. Malignancy leads to continuous expression of telomerase, with consequent immortality of cancer cells.

### Mutations in Mitochondrial DNA

Mitochondrial DNA is more exposed and susceptible to damage by free radicals (reactive oxygen species). Such damages when accumulated, lead to reduction of oxidative phosphorylation. The exposure to oxidative stress leads to irreparable damage, and final destruction of the cell.

### Heat Shock Proteins (HSP)

They are products of highly conserved genes. HSPs protect the cell against a variety of stresses such as, heat, heavy metals, drugs and toxins. The HSPs will mediate the disposal of damaged proteins and guide towards the correct folding into exact three-dimensional structure (see Chapter 46). The HSP response is reduced in senescent cells and in older individuals.

## QUICK LOOK OF CHAPTER 58

- Collagen has a triple helical structure, where the 3 strands are hydrogen bonded to each other and further stabilized by hydrogen bonds between OH groups and water molecules, thus giving high tensile strength to the fiber.
- Tropocollagen molecules are arranged in a quarter staggered array.

3. The strength of collagen fibers is due to covalent crosslinks between lysine and hydroxylysine residues. These are formed by lysyl oxidase, which is a Cu containing enzyme.
4. Abnormalities of collagen structure are seen in osteogenesis imperfecta, homocystinuria, Marfan's syndrome, ascorbic acid deficiency and copper deficiency.
5. Myosin molecules act as ATPase and binds to actin.
6. Actin is the major protein of the thin filament. Muscle contraction is effected by the sliding of actin over myosin.
7. Prions are proteinaceous infective particles. Prion particles (PrP) undergo change in the structural conformation and result in PrPsc. PrPsc is resistant to heat and proteolysis.
8. Human Prion diseases are Kuru, CJD, GSSD and FFI.
9. In animals prions can cause scrapie, BSE, nvCJD.



# CHAPTER 59

## Applications of Isotopes in Medicine

### Chapter at a Glance

The reader will be able to answer questions on the following topics:

- Isotopes
- Radioactive decay and half-life
- Units of radioactivity
- Research applications
- Diagnostic applications
- Treatment applications
- Biological effects of radiation

### INTRODUCTION

Lord Ernest Rutherford (Nobel prize, 1908) put forward the nuclear theory of atom. Accordingly, the atoms are composed of a central dense positively charged *nucleus*, around which negatively charged *electrons* revolve. Subatomic stable particles are proton, neutron and electron.

**Proton** carries one positive charge ( $+4.8 \times 10^{-10}$  esu) (esu = electrostatic unit). Proton is generally abbreviated as  $P^+$ . The nucleus of hydrogen contains only one proton. Therefore, ionized hydrogen is otherwise called as proton. Although protons are said to be stable in the ordinary sense, in the cosmological sense, protons also decay. The half-life of proton is  $10^{15}$  years. The body of a person contains about  $10^{40}$  protons.

**Neutron** is abbreviated as 'n'. It carries no net charge. It has the same mass as that of proton. Protons and neutrons together constitute the nucleus of atoms. Therefore, the atomic weight of an element will correspond to the total number of protons and neutrons present in the nucleus.

**Electron** is generally abbreviated as  $e^-$ . It is negatively charged ( $-4.8 \times 10^{-10}$  esu) and revolves around the nucleus. The mass of an electron is only 1/2000 of a proton. Electrons are the fundamental units of electricity. An electric current is produced by a stream of electrons.

**Valency:** Electrons are taking part in all chemical reactions. The electrons revolve around the nucleus at different energy levels or in shells. Sodium has the atomic number 11. It contains 11 electrons, distributed as 2 in K shell, 8 in L shell and the remaining 1 in M shell. The natural



Ernest Rutherford  
NP 1908  
1871–1937



Wilhelm Röntgen  
NP 1901  
1845–1923



Antoine Becquerel  
NP 1903  
1852–1908



Willard Frank Libby  
NP 1960  
1908–1980



Pierre Curie  
NP 1903  
1859–1906



Marie Sklodowska Curie  
NP 1903, 1911  
1867–1934



Frederic Joliot  
NP 1935  
1900–1958



Irene Joliot Curie  
NP 1935  
1897–1956

tendency for an atom is to completely fill up the shells with electrons. Hence, sodium atom tends to lose the electron from the outermost shell, and exist as  $\text{Na}^+$  ion. Similarly chloride contains 17 electrons, 2 in K, 8 in L and 7 in M shells. If one more electron is accepted by the atom, the outermost shell will be completed. Hence, the tendency for chlorine to gain one electron to become ionized. Thus, sodium can donate one electron and chlorine can receive it. This is the basis of the chemical reaction between sodium and chloride. In the above example, the valency of both sodium and chlorine is said to be one, because they exchange one electron.

## ISOTOPES

Isotopes are the elements having the **same atomic number** (protons) but **different mass number** (varying number of neutrons). The Greek word “iso” means equal and “topy” means place; that is, isotopes occupy the same place in the periodic table. The accepted convention is that mass number is written on the upper left side of the symbol letters to denote the particular isotope. Atomic number may be shown on the left lower corner of the symbol.

For example,  $^1\text{H}$  is normal hydrogen with 1 proton. It is present 99.985% of hydrogen ions in nature.  $^2\text{H}$  is heavy hydrogen or **Deuterium**. It has  $1p + 1n$ . It is present only 0.015% in nature.  $^3\text{H}$  is **Tritium** with  $1p + 2n$ . It is not present in nature, but may be produced artificially. These three isotopes of hydrogen will react similarly in chemical reactions, because all of them contain only one electron.

To take another example,  $^{16}\text{O}$  is normal oxygen,  $^{17}\text{O}$  is unstable and  $^{18}\text{O}$  is stable isotope.

**Isobars** are atoms having same mass number, but are having different atomic numbers, e.g.  $^{14}\text{C}$  and  $^{14}\text{N}$ .

### Atomic Number and Atomic Weight

The number of protons (or electrons) in an atom will determine the **mass number** or its place in the periodic table. The presence of neutrons will add on the mass of the atom. The **atomic weight** or mass number is equal to the number of protons plus neutrons in the atom.

The atomic weight of chlorine is actually 35.457. When calculated from the theoretical “ $p + n$ ”, the value should be the round figure of 35. This difference is because, in nature, chloride is made up of atoms having mass numbers of 35 and 37, in approximately 3:1 ratio.

## RADIOACTIVITY

Isotopes may be stable or unstable (radioactive), and the latter may be naturally occurring or artificially made. In the above example, Deuterium is stable, which will not alter its nuclear composition during passage of time. But tritium is unstable and will transform by nuclear decay.

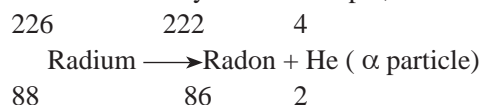
**The spontaneous degradation of nucleus** and transmutation of one element to another with consequent emission of rays or particles is known as radioactivity. Chemical reactions are based on the activity of electrons, while radioactivity is due to subnuclear components. Elements capable of undergoing radioactive decay are called **radionuclides**.

Antoine Becquerel was the pioneer in demonstrating spontaneous radioactivity (Nobel prize, 1903). Marie Curie and Pierre Curie were awarded Nobel prize in 1903 in physics, for their study on radiation phenomena. Marie Curie was awarded the Nobel prize again in 1911, but this time in chemistry, for the isolation of radium and polonium. In 1935, Nobel prize was awarded to Frederic Joliot (son-in-law of Madam Curie) and Irene Joliot (daughter of Curie) for artificial production of radioactive phosphorus from aluminium.

## Radioactive Decay

### Alpha Decay

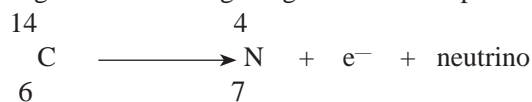
When the alpha particle ( $2p + 2n$ ) is released, the element changes, the atomic number is reduced by 2 and mass number is lowered by 4. For example,



The nucleus of Radium, being unstable, emits 2 protons and 2 neutrons (one helium nucleus) to become Radon-222. The alpha particles will carry 2 positive charges and produce maximum ionization in their path. Thus, they are **most damaging** to tissues. Alpha particles emitted have a high mass and therefore a high momentum. They do not travel far and can be stopped by a few layers of paper. However, they collide with other molecules and cause a lot of damage, hence considered to be most hazardous. The alpha radiations are not useful in clinical medicine. In fact, radium needles are covered so that alpha particles are absorbed, before applying to tissues. If not, the radiation in the vicinity of the needle will be hazardously high (Table 59.1).

### Beta Radiation

When a neutron is split, one proton, one electron (beta particle) and one neutrino are generated. The element is changed to one having a higher number in periodic table.

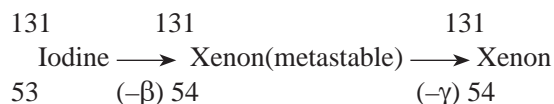


One neutron from carbon is changed to a proton. Therefore, mass remains the same, but the element is changed with one

number more in atomic number. The electrons thus emitted become the beta rays. So they are negatively charged. Since their mass is negligible, they can penetrate more distance. But they can be absorbed by metal sheets. The interaction with matter is less. Tritium ( $^3\text{H}$ ) gets converted to helium on losing a beta particle. These beta particles have low velocity and tritium is said to be a soft beta emitter.  $^{32}\text{P}$ , a hard beta emitter, on the other hand, has more kinetic energy.

### Gamma Radiation

While alpha and beta radiations are particles, gamma radiation is in the form of **electromagnetic waves**. Gamma ray has no mass and no charge, and therefore penetration power is maximum. It is now widely used for treatment of cancer cases. X-rays and gamma rays are similar electromagnetic waves (Table 59.1). But the former is less powerful (wavelength 100 Å to 1 Å), whereas gamma rays are more penetrating (wavelength 1 Å to 1/1000 Å). The gamma radiation is produced by:



The first part of the nuclear reaction is similar to the beta radiation described previously. Thus the element with one more proton is produced. Here the resulting xenon is at a metastable state. It will release further energy in the form of gamma irradiation within a fraction of second to form the stable xenon. A comparison of different forms of radiation is given in Table 59.1.

### Half-life of Radioactivity

The radioactivity is halved within a fixed time. For example, if 100 mCi of  $^{131}\text{I}$  is kept, after 8 days the activity is seen to be 50 mCi. The half-life of  $^{131}\text{I}$  is 8 days (Fig. 59.1). **The half-life is the time taken for a radioactive isotope to**

**become half of its original activity.** The rate of decay or the half-life is a constant for a particular isotope. A decay time of 7 half lives reduces the radioactivity to < 1% and that after 10 half lives is less than 0.1 %. This is important in planning experiments and disposal of radioactive waste. The hazard of improper disposal of radioactive waste has caused exposure of innocent laymen in a recent incident in Delhi. Commonly used isotopes are listed in Table 59.2.

### Units of Radioactivity

Originally the units used for expressing the radioactivity were Curie and Rads. But the present system uses SI units, Becquerel and Gray.

#### Curie (Ci)

One Curie, abbreviated as Ci, is equivalent to  $3.7 \times 10^{10}$  disintegrations per second (dps) or 37 giga becquerels (gBq). This unit is used to measure the radioactivity of the source.

#### Becquerel (Bq)

Becquerel (Bq) is defined as decay per second, (dps). 1 Bq = 1 dps. It is often expressed as kilobecquerels (kBq). Since bq is very small and Curie very large, their multiples and submultiples are used to express radioactivity. 1 micro Curie = 37 mega Bq. In clinical practice, it is not the radioactivity of the source, but the effect produced in the tissues is more important. Therefore, for therapeutic purposes, the following units are used.

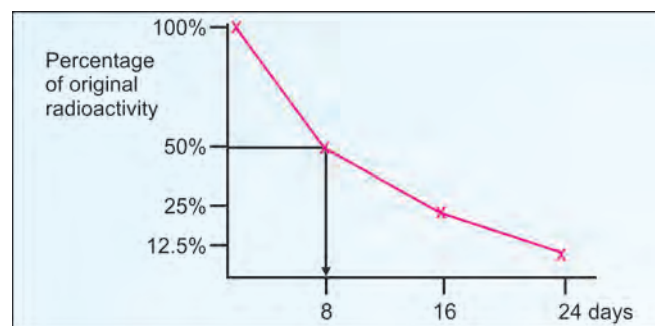


Fig. 59.1: Radioactive decay and half-life of  $^{131}\text{I}$

TABLE 59.1: Different forms of radiation

Type of radiation	Composed of	Mass	Charge	Ionization ion pairs per cm of travel in air	Range in air	Stopped by	Application
Alpha		4	+2	20,000	3–8 cm	Few sheets of paper	Radiation hazard
Beta	$e^-$	Negligible	-1	100	15–100 cm	Few sheets aluminum	Research/ diagnosis
Gamma	Electromagnetic waves	Nil	0	1	100 m	Few cm thick lead	Diagnosis/ treatment

### Rontgen (R)

It is the measurement of exposure dose. The radioactivity produces ionization in tissues. This is dependent on the quantity of radioactivity at the source, the distance from the source and the time of exposure. 1 R is the radiation which will give rise to  $2 \times 10^9$  ion pairs/cc of air. One mCi source kept at a distance of 1 cm will produce 12.9 R/hour.

### Rad and Gray

Rad is the absorbed dose by tissue. 1 Rad =  $1.5 \times 10^{12}$  ion pairs/g tissue. One Gray (Gy) =  $10^7$  ergs /kg tissue = 100 rads.

The biological effect of absorbed physical dose is expressed in Rads or Kilo Gray. Biological dose in SI units is expressed in Sievert (Sv).

### Rem

It is the Rontgen equivalent in man; where absorbed dose of rads is multiplied by the quality factor of the type of radiation. The biological effect of 1000 rads given as a single dose or in divided doses will be different. This biological effect of radiation is expressed in Rem.

## Applications of Radioactivity in Research

Isotopes of an element will have identical chemical reactions. Hence, when a radiolabeled compound is administered, these molecules are metabolised by the body similar to normal molecules. This is called **Tracer technique**. Almost all biochemical research will utilize such tracer methods. A few examples are given below.

- i. Almost all the **pathways** described in earlier chapters were studied by using tracers. For example,  $^{14}\text{C}$ -labeled acetoacetic acid is shown to be incorporated into palmitic acid. Suppose labeled "A" is administered to an animal. After a few minutes, liver contains labeled "B" and after one hour, labeled "C" is seen in liver. Thus, we can say that the pathway is A to B to C.
- ii. The **turnover rate** of a substance in the body, that is, the rate of synthesis and breakdown could also be studied by tracer techniques. For example, if  $^{131}\text{I}$ -labeled immunoglobulin is injected, the quantity of the labeled molecules in the circulation will be proportional to the catabolism of the Ig. By such methods, it is shown that the half-life of IgG is 15 days, of albumin is about 21 days.
- iii.  $^{32}\text{P}$  is useful to trace the nucleic acid synthesis in vivo and in vitro. It is therefore employed in genetic research.  $^3\text{H}$ -labeled thymidine is incorporated in the newly synthesized DNA and therefore used in assessing cell division kinetics.  $^{51}\text{Cr}$  is taken up by living cells and the label is liberated when the cell is lysed. Therefore, it is used in vitro to quantitate the cell lysis by immunological or pathological mechanisms.
- iv. The total body content of a particular substance (also designated as the "pool" of the substance) can be quantitated by the **isotope dilution technique**. To cite an example, 1 mL of  $^{131}\text{I}$ -labeled albumin is seen to have 1 million dps. This is injected intravenously to a man. The radioactivity will be uniformly mixed in the total blood volume. After 10–15 minutes, a blood sample is withdrawn. One mL of blood is shown to have a radioactivity with 200 dps. The volume injected and removed is the same 1 mL, but the original count is now diluted 5,000 times. Thus, the intravascular space is 5,000 times more than the volume injected. Therefore, the blood volume is 5,000 mL.
- v. Similarly extracellular volume (intravascular + interstitial spaces) is determined by  $^{24}\text{Na}$ -labeled NaCl, and the total body water by means of  $^3\text{H}$ -labeled water. From such experiments it is shown that intracellular compartment is 40%, interstitial compartment is 16% and intravascular volume is 4% of the total body weight (see Chapter 30).
- vi.  $^{14}\text{C}$  is the most widely used isotope as a tracer in biochemical research, especially to study the pathways.

**TABLE 59.2:** Commonly used radioisotopes

Element	Isotope	Approximate half-life	Major radiation	Important applications
Carbon	$^{14}\text{C}$	5600 years	Beta	Research in metabolism, carbon dating
Hydrogen	$^3\text{H}$	12 years	Beta	Research in cell biology
Phosphorus	$^{32}\text{P}$	14 days	Beta	Nucleic acid research, treatment for polycythemia
Chromium	$^{51}\text{Cr}$	28 days	Gamma	RBC kinetics in diagnosis
Iodine	$^{125}\text{I}$	60 days	Gamma	Radioimmunoassay
Iodine	$^{131}\text{I}$	8 days	Gamma	Treating hyperthyroidism and thyroid cancer
Technicium	$^{99}\text{Tc}$	6 hours	Gamma	Blood flow experiments, gamma imaging
Radium	$^{226}\text{Ra}$	1600 years	Gamma	Interstitial implantation for treating cancer
Cobalt	$^{60}\text{Co}$	5.3 years	Gamma	Teletherapy for cancer
Caesium	$^{137}\text{Cs}$	30 years	Gamma	Teletherapy for cancer



- vii. Autoradiography for detection of specific nucleotide sequences (see Chapter 49). Radiolabeling of nucleic acids by nick translation using  $^{32}\text{P}$ .
- viii. Irradiation of food for packaging is carried out under the strict provisions of food safety procedures prescribed by FDA and radiation protection agencies. The radiations that can be used for irradiating food are specified. These include gamma rays from sealed units  $^{60}\text{Cobalt}$  and  $^{137}\text{Caesium}$ .
- ix. **Carbon dating** technique is an important tool in paleobiology, the technique was developed by Willard Libby who was awarded Nobel prize in 1960.

## Applications of Radioactivity for Diagnosis

The branch of medicine that deals with the diagnostic applications of radioactivity is referred to as **Nuclear Medicine**. A quick and accurate diagnosis can be made by radioimaging of organs like thyroid, liver bone, etc. In some cases, radioisotopes are used in the treatment of neoplasms in these organs. Diagnostic uses of radioactive tracers are using gamma ray emitters. These are short lived isotopes linked to chemical compounds that permit the observation of specific physiological processes. They may be given by injection, inhalation or orally.

The earliest application of radioisotopes was in the 1950s,  $^{131}\text{I}$  for the diagnosis and treatment of thyroid disease

- i. RBCs can be tagged with  $^{51}\text{Cr}$ . These cells when injected back will remain in circulation till the RBC is lysed. Therefore, **lifespan of RBC** and intravascular hemolysis, if any, may be detected.
- ii. **Thyroid uptake studies** by  $^{131}\text{I}$  are used to detect functional derangements of thyroid gland. About 15 mCi of  $^{131}\text{I}$  is given intravenously. After a few hours, the patient is monitored at the neck region by a movable gamma-ray counter, which will pick up the radiation emitted by the thyroid gland. The normal values are about 25% uptake by thyroid within 2 hours and about 50% uptake within 24 hrs. In hyperthyroidism there will be increased uptake and hypothyroidism shows the reverse effect.
- iii. **Thyroid scanning:** Twenty-four hours after administering the dose of  $^{131}\text{I}$  intravenously, the patient is placed under the scanner, which detects the radioactive emissions from the neck region. The actual distribution of radioactivity, with a picture of approximate size and shape of thyroid gland is produced. In hyperthyroidism, the increased radioactivity uptake is shown as heavily shaded areas. Sometimes, the uptake of iodine is seen defective in certain circumscribed region of the gland, such a “silent nodule” is suggestive of cancer thyroid.
- iv. **Bone scanning:**  $^{90}\text{Sr}$  (radioactive strontium) is employed. Osteoblastoma (cancer arising from bone forming cells) could be detected very early by this method, even before the appearance of radiological changes.
- v. **Kidney scanning** is done by injecting  $^{131}\text{I}$ -labeled hippuran or  $^{131}\text{I}$ -labeled diodrast. Both are excreted by kidney within a few minutes after injection. Anatomical and physiological defects in the renal excretion could be easily identified.
- vi. **Technium for blood flow studies:** Blood flow of heart could be analyzed by  $^{99}\text{Tc}$  (radioactive technium). The half-life of  $^{99}\text{Tc}$  is less than 6 hrs. The method is sometimes called “nuclear stethoscope”.
- vii. **Positron emission tomography (PET) scan** is a more precise and sophisticated technique. Here the isotope is produced on the spot by a cyclotron. The emission of positrons and their combination with an electron resulting in the simultaneous emission of two gamma rays is detected by a PET camera. PET scan is widely used in Oncology with  $^{18}\text{F}$  as a tracer. Combination of PET and CT (PET/CT) improves the diagnostic accuracy. The abnormality may be either lesser uptake of the isotope by the organ (cold spot) or more uptake (hot spot). A series of images taken over a period of time will give specific patterns that indicate normal or malfunction of the organ concerned. An advantage over X-ray imaging is that both bone and soft tissues can be studied. The mean effective dose is 4.6 mSv per procedure (Sv is the abbreviation of sievert, the biological dose equivalent).
- viii. **Targeting:** A more recent use of radionucleides is by tagging them to monoclonal antibodies so that they can be specifically targeted to tissues.
- ix. **Radioimmunoassays (RIA):** Assays using  $^{125}\text{I}$ -labeled antigens are used to quantitate hormones, tumor markers and other biological substances present in blood in very small quantities. Details are given in Chapter 35.  $^{125}\text{I}$  with a half-life of about 60 days is used for tagging the proteins in vitro, as in the case of RIA. Another isotope of iodine,  $^{131}\text{I}$  with half-life of about 8 days is employed for in vivo purposes, such as thyroid scanning and for treatment purposes. The reduced half-life is advantageous in vivo to reduce the side effects of radioactivity to the patient.

## Applications of Radioactivity in Treatment

Radioactivity is used for treatment of cancer. Radiations when absorbed by the tissues, produce ionization in the path. Nucleic acids in the cell are damaged, so that next cell division is not possible. Radiotherapy mainly affects cells in the division phase. Since cancer tissue contains more dividing cells than normal tissue, cancer cells are preferentially affected by radiation. Radiotherapy may be classified as:

## Unsealed Sources

These are radioactive substances kept in liquid form. The beta rays are the main effective radiation in these sources. For **thyroid cancer** and secondaries of thyroid cancer,  $^{131}\text{I}$  (dose 50–100 mCi) is administered. Similarly,  $^{32}\text{P}$  is used to treat **polycythemia vera**.

## Sealed Sources

They utilize gamma irradiation. The source is applied on the cancer or sometimes implanted as a needle into the tissue.

**Radium needles** have the advantage of very long half-life. However, during the decay, radioactive gas xenon is generated which may escape out if there is a leak in the covering. Because of this hazard, radium needles are now rarely used.

$^{137}\text{Cs}$  (**cesium**) with a half-life of 30 years, is the preferred sealed source nowadays. Application of such sources directly on cancer tissue is called **Brachytherapy**. Intracavitary applications (for cancer body of uterus, cancer of cervix uteri, cancer of vagina) and interstitial applications (buccal cancer, tongue cancer) are common.

## Teletherapy

The term “tele” means distant (as in the case of telescope, telephone, etc.). Here the source of radiation is kept at a distance from the patient. Historically, teletherapy started with deep X-ray. X-ray was discovered by Wilhelm Röntgen in 1895 (Nobel prize, 1901). Due to its inefficiency, deep X-ray is no more used for cancer treatment. Instead, **gamma rays** from cobalt ( $^{60}\text{Co}$ ) or caesium ( $^{137}\text{Cs}$ ) are used for teletherapy. Here the energy equivalent is in the order of 2 MV (1 mega volt = 1 million volts). Therefore, penetration power is more, and deep-seated cancers can be irradiated satisfactorily.

**Linear accelerator (LINAC):** Cesium-based radiotherapy is no more used in western countries. In India also, gamma ray treatment is being slowly replaced by Linear Accelerator. Here electrons are accelerated to higher energy levels of 8–12 MV and directed into the cancer tissue. It has more penetrating power and accurate beam focussing capabilities. As there is no permanent radioactive source in the machine, the radiation hazards are minimal. LINAC is used for external beam radiation treatments for patients with cancer. The linear accelerator can also be used in stereotactic radiosurgery similar to that achieved using the gamma knife on targets within the brain; for Intensity-Modulated Radiation Therapy (IMRT) and Image Guided Radiation Therapy (IGRT).

The linear accelerator uses microwave technology to accelerate electrons, then allows these electrons to collide with a heavy metal target. As a result of the collisions, high-energy X-rays are produced from the target. These high energy X-rays will be directed to the patient’s tumor and shaped as they exit the machine to conform to the shape of the patient’s tumor.

## Radiosensitivity

The effectiveness of radiotherapy varies with different tumors. In general, lymphomas, Hodgkin’s disease and neuroblastoma are *highly radiosensitive*. Epithelioma, cancer of oral cavity, cancer cervix, cancer

breast and cancer lung are *moderately* radiosensitive. Poorly radiosensitive tumors are osteosarcoma, and malignant melanoma.

## Fractionation of Doses

Cancer cells show more active division. In cancer tissue, about 5–10% cells are in division, while in normal cells only less than 1% cells are dividing at particular time. Radiotherapy takes advantage of this difference between normal and cancer cells. Since radiotherapy affects only cells in division cycle (especially S phase), the radiation affects mainly the cancer cells. Recovery from radiation damage is quicker in normal cells than in cancer cells. The aim is to inflict maximum damage to cancer cells, while retaining the power of repair of the surrounding normal tissues.

However, radiation given in a single dose is not effective. Because dividing cells are only 5% in the cancer population and radiation kills only this fraction. Moreover, a single large dose will be lethal. Instead, small divided doses are given to the cancer tissue. Thus, the fractionated dose is employed. By the next day more cells enter the S phase which are killed by the second dose. The total radiation dose is usually given in 15–20 fractions, administered within 25–35 days.

Cellular death after radiation depends on the number of cells in division. This produces a curious effect, each increment in dose kills a constant fraction of the cancer cells; but not a constant number of cells. An arbitrary example is shown in Table 59.3. While the first dose kills  $1 \times 10^9$  cells, the 3rd dose can kill  $1 \times 10^7$  cells only. However, the percentage of cells killed is the same by each dose. In other words, the size of tumor is rapidly diminished in the initial phases of radiotherapy, but the last few cells are difficult to destroy. In fact, all the cancer cells cannot be eradicated by radiotherapy. The last few residual cells are annihilated by the immunological system.

**TABLE 59.3:** Effect of radiotherapy differs

Day	Dose in rads	Initial number of cells	Fraction of cells in division	No. of remaining cells	No. of cells killed
1	400	$1 \times 10^{10}$	10%	$9 \times 10^9$	$1 \times 10^9$
2	400	$1 \times 10^9$	10%	$9 \times 10^8$	$1 \times 10^8$
3	400	$1 \times 10^8$	10%	$9 \times 10^7$	$1 \times 10^7$
4	400	$1 \times 10^7$	10%	$9 \times 10^6$	$1 \times 10^6$

## BIOLOGICAL EFFECTS OF RADIATION

### Direct Effects on Cancer Tissues

The radiation damages DNA molecules. No effects are visible immediately. But the damage is observed during the next mitosis. Since new DNA cannot be synthesized, cells die at the attempt of the next division. Chromosome breakage is often noticed. Radiation produces large quantities of free radicals in tissues. The catastrophic effects of free radicals on different biological compounds (including DNA) are described in Chapter 33.

### Indirect Effects on Cancer Tissues

Damage to local blood supply cuts off the nutrition and causes local necrosis and cell death.

### Effects of Radiation on Normal Tissues

In 1904, Madam Curie went for a lecture-demonstration class, keeping a few mg of impure radium ore in her breast pocket. Within 1 hour, this caused severe dermatitis. That was the first indication of a health hazard by radioactivity. Madam Curie succumbed to radiation-induced leukemia in 1934.

#### *Effects on Skin*

Radiation will produce epilation, however hair may grow after 3 months. Sweat glands may be permanently damaged. There may be erythema and sometimes blisters. This is called **acute** radiodermatitis. **Chronic** radiodermatitis is seen after a few months of radiotherapy. There will be atrophy of skin, hypopigmentation, fibrosis, loss of elasticity, etc.

#### *Effects on Mucous Membrane*

The gastrointestinal mucosa is very sensitive to radiation. These include nausea, vomiting, diarrhea and in severe cases ulceration and bleeding. Late sequelae such as adhesions, fibrosis, stenosis and obstruction may appear many months after radiotherapy.

#### *Effects on Blood Cells*

Bone marrow and lymphoid tissues are highly radiosensitive because of the higher rate of cell division in these organs. Leukopenia and thrombocytopenia is an accepted

side effect of radiotherapy. If WBC count is below 2,000/cu mm and platelet count is below 80,000/cu mm, the therapy is temporarily stopped till recovery is effected.

#### *Effects on Reproductive Organs*

Gonads (ovary and testis) are highly radiosensitive. Complete sterility is effected at 1000 rads. Even low doses of radiation, too low to have any obvious effect on mitosis, can still affect the genes, so as to produce genetic alterations in the offspring. This is especially important when radiation is given in pelvic region.

#### *Radiation Sickness*

Dose above 700 rads given, as whole body irradiation, is usually fatal. Even 150 rads to the whole body will cause severe illness. In clinical practice, this is avoided by shielding the tissues in such a way that the beam is focussed to the cancer tissues only.

#### *Carcinogenic Potential*

During the period 1900–1910, people were working with X-rays without any precautions. This caused non-healing ulcers in many of them. During 1910s and 20s, lip cancer was common among painters of watch dial with radioactive stain. Gradually, along with the increasing knowledge on radiation hazard, stringent safeguard for radiation protection was introduced.

#### **Acute Radiation Syndrome (ARS)**

This may occur in accidents in nuclear reactors (e.g. Chernobyl accident) or the use of nuclear weapons in war (Hiroshima and Nagasaki). About 15 to 25 rads will alter the blood count in exposed people, whereas the threshold for death in an individual is 150 rads. Other high dose effects are skin burns, hair loss, sterility and cataracts. Skin burns result from erythema, desquamation and blisters. Hair loss can occur after 500 rads. Cataracts (200 rads) are produced by neutrons because of the high water content in the lens.

#### **Radiation Protection**

There is always some amount of background radiation, of about 150 m Rem/year. Out of this, about 50% is from the cosmic rays, about 30% from terrestrial environment and 20% from internal environment (e.g. decay of  $^{40}\text{K}$ ). Granite and brick walls will increase external background. At higher elevation, cosmic rays are more. At an altitude of 2000 m (e.g. Gangtok, Sikkim state), the background irradiation is 20% more. In some coastal areas (e.g. Kerala state) natural deposits of radioactive thorium is seen, where background is 20–30% high. One diagnostic X-ray exposure may cause 75 milliRem.

### Maximum Permissible Dose

The MPD of radiation for whole body among radiation workers (doctors, technicians) is 5 mRem/year, and for general population is 0.5 mRem/year. Small doses (less than 10 cGy) of radiation may be good to living systems, while large doses are harmful; this is called **Hormesis**.

### Radiation Monitoring and Precautions

Doctors, nurses, radiographers and research workers using the radioactive substances should wear a badge containing a piece of film. If radiation is reaching the film, it is blackened, and hence exposure could be detected. The following precautions will reduce the radiation hazards:

1. Keep the source farther away.
2. Shield the radioactive sources; cover them with lead bricks.
3. Handling is done by remote devices. Use lead-rubber gloves and aprons.
4. Radioactive materials are to be handled with speed. The shorter the time spent near the source, the lower the dose received.

### QUICK LOOK OF CHAPTER 59

1. Isotopes are the same element having the same atomic number (protons) but different mass number (varying number of neutrons).
2. Spontaneous degradation of nucleus and transmutation of one element to another with consequent emission of rays or particles is known as radioactivity.
3. The total body content of a particular substance can be quantitated by the isotope dilution technique.
4. Applications of radioisotopes in medicine include radioimmunoassays, thyroid uptake studies, blood flow studies, bone and kidney scanning, radiotherapy in cancers.
5. Radiations affect mucous membrane, skin, blood cells, reproductive organs and can damage DNA preventing mitosis.



# CHAPTER 60

## Signal Molecules and Growth Factors

### Chapter at a Glance

The reader will be able to answer questions on the following topics:

- Signal molecules produced at specific sites
- Peptide hormones regulating digestion
- Peptide hormones regulating appetite
- Adipose tissue derived hormones
- Growth factors

The modern definition of a hormone is that, it is *synthesized by one type of cells and transported through blood to act on another type of cells*. There are hundreds of polypeptides that come under this category; an exhaustive survey of all of them is out of the objective of this textbook. These are local hormones, or signal molecules produced at the local sites, and therefore are generally called as “factors”. Some important ones are described below.

### Cadherins

Short form for Calcium dependent adhesion molecules. They are transmembrane proteins. They play important roles in cell adhesion, ensuring that cells within tissues are bound together. They are dependent on calcium ( $\text{Ca}^{2+}$ ) ions for their function, hence the name. The cadherin superfamily includes cadherins, protocadherins, desmogleins, and desmocollins. E-cadherins are found in epithelial tissue; N-cadherins are found in neurons; and P-cadherins are found in the placenta. In epithelial cells, E-cadherin-containing cell-to-cell junctions are often adjacent to actin-containing filaments of the cytoskeleton. Loss of E-cadherin has been implicated in cancer progression and metastasis. E-cadherin downregulation decreases the strength of cellular adhesion within a

tissue, resulting in an increase in cellular motility. This in turn may allow cancer cells to cross the basement membrane and invade surrounding tissues.

### c- Jun

The c-Jun knockout is lethal. The c-jun produces the c-Jun protein which binds with Fos; hence c-jun protein is also called as Fos-binding protein or p39. The c-Jun in combination with c-Fos, forms the AP-1 “early response transcription factor”. It is activated through double phosphorylation by the JNK pathway. This gene is intronless and is mapped to 1p32-p31, a chromosomal region involved in both translocations and deletions in human malignancies. For c-Jun N-terminal kinases (JNKs), see under JNKs.

### c Kit (CD117)

Also called KIT or C-kit receptor; it is a cytokine receptor expressed on the surface of hematopoietic stem cells as well as other cell types. This receptor binds to the stem cell factor. Mutations in this gene are associated with various cancers such as gastrointestinal stromal tumors, mast cell disease, chronic myelogenous leukemia and seminomas. The CD117 is a proto-oncogene, meaning that overexpression or mutations of this protein can lead to cancer.

### Epidermal Growth Factor Receptor (EGFR)

Also called ErbB-1, (HER1 in humans), it is the cell-surface receptor which binds extracellular protein ligands. The epidermal growth factor receptor is a member of the ErbB family of receptors, a subfamily of four closely related receptor tyrosine kinases; namely, EGFR (ErbB-1), HER2/c-neu (ErbB-2), Her 3 (ErbB-3) and Her 4 (ErbB-4). Mutations affecting EGFR could result in cancers, including lung cancer, large intestinal cancers and glioblastoma multiforme. In this latter case a more or less specific mutation of EGFR, called EGFR VIII is often observed. Mutations of EGFR are implicated in about 30% of all epithelial cancers. The identification of EGFR as an oncogene has led to the development of anticancer antibodies, directed against EGFR, including gefitinib and erlotinib for lung cancer, and cetuximab for colon cancer. Other monoclonal antibodies in clinical development are zalutumumab, nimotuzumab, and matuzumab. Gefitinib, erlotinib, and lapatinib (mixed EGFR and ERBB2 inhibitor) are examples of small molecule kinase inhibitors.

### Erythropoietin (EPO)

Otherwise called **hematopoietin** or **hemopoietin**, it is a glycoprotein hormone that controls erythropoiesis, or red blood cell production. It is a cytokine for erythrocyte-precursors in the bone marrow. It is produced by the peritubular capillary endothelial cells in the kidney. It also plays an important role in the brain's response to neuronal injury. EPO is also involved in the wound healing process. Erythropoietin is available as a therapeutic agent produced by recombinant DNA technology in mammalian cell culture. It is used in treating anemia resulting from chronic kidney disease and myelosuppression induced by chemotherapy or radiation.

### ERK

The **MAPK/ERK pathway** is a signal transduction pathway that couples intracellular responses to the binding of growth factors to cell surface receptors. Activation of this pathway promotes cell division. The kinase cascade is relevant to many cancers, e.g. Hodgkin's disease. The first drug licensed to act on this pathway is sorafenib - a Raf kinase inhibitor.

### Fibroblast Growth Factor (FGF)

The beta-FGF is found in almost all tissues of mesodermal and neuroectodermal origin and also in tumors derived from these tissues. It is important for cell growth and differentiation. Beta-FGF stimulates the growth of fibroblasts, myoblasts, osteoblasts, neuronal cells, endothelial cells, keratinocytes and chondrocytes. In capillary endothelial cells, beta-FGF acts in an autocrine manner. The mitogenic action of beta-FGF for endothelial cells can be potentiated by thrombin, transferrin and HDL. The beta-FGF promotes the maturation and maintenance of cholinergic neurons and acts as a mitogen for chromaffin cells. It also influences the proliferation, differentiation, and function of astrocytes and oligodendrocytes.

### Gaunynin

A peptide produced by mucin secreting cells and released into the intestinal lumen. It stimulates NaCl secretion by binding to a brush border receptor

and stimulating guanylate cyclase which elevates the level of cyclic GMP. An enterotoxin produced by *E. Coli* mimics the action of this hormone and causes Traveller's diarrhea.

### Glycogen Synthase Kinase 3 (GSK 3)

The GSK 3 $\alpha$  and GSK 3 $\beta$  are serine/threonine protein kinases, that mediate the addition of phosphate molecules on serine and threonine in specific cellular substrates. GSK-3 is known for phosphorylating and thus inactivating glycogen synthase. It has also been implicated in the control of cellular response to damaged DNA. Its role as an NFAT kinase also places it as a key regulator of both differentiation and cellular proliferation. GSK-3 can be inhibited by Akt phosphorylation, which is part of insulin signal transduction. Therefore, Akt is an activator of many of the signaling pathways blocked by GSK-3. For example, in the setting of induced Akt signaling, it can be shown that NFAT is dephosphorylated. This inhibition of GSK-3 is currently believed to underlie the therapeutic usefulness of lithium salts for the treatment of mood disorders. Furthermore, cytokine-dependent GSK-3 phosphorylation in hemopoietic cells may regulate growth.

### Heat Shock Proteins (HSP)

They are a class of functionally related proteins whose expression is increased when cells are exposed to elevated temperatures or other stress. The dramatic upregulation of the heat shock proteins is a key part of the **heat shock response**. Heat-shock proteins are named according to their molecular weight. For example, Hsp60, Hsp70 and Hsp90 refer to families of heat shock proteins on the order of 60, 70 and 90 kilodaltons in size, respectively. The small 8 kilodalton protein ubiquitin, which marks proteins for degradation, also has features of a heat shock protein. Functions of HSP include in (1) upregulation in stress, (2) role as chaperone, (3) housekeeping, (4) cardiovascular role, and (5) immunity.

### Hepatocyte Growth Factor (HGF) and HGF Receptor (HGFR)

Also called MET (mesenchymal epithelial transition factor). It is a proto-oncogene. Hepatocyte growth factor regulates cell growth, cell motility, and morphogenesis by activating a tyrosine kinase signaling cascade after binding to the proto-oncogenic c-Met receptor. Hepatocyte growth factor is secreted by mesenchymal cells and acts as a multi-functional cytokine on cells of mainly epithelial origin. MET is a membrane receptor that is essential for embryonic development and wound healing. Hepatocyte growth factor (HGF) is the only known ligand of the MET receptor. MET is normally expressed by cells of epithelial origin, while expression of HGF is restricted to cells of mesenchymal origin. Upon HGF stimulation, MET induces several biological responses that collectively give rise to invasive growth. Abnormal MET activation in cancer correlates with poor prognosis. Active MET triggers tumor growth, formation of new blood vessels (angiogenesis) that supply the tumor with nutrients, and cancer spread to other organs (metastasis). MET is deregulated in many types of human malignancies, including cancers of kidney, liver, stomach, breast, and brain. Normally, only stem cells and progenitor cells express MET, which allows these cells to grow invasively in order to generate new tissues in an embryo or regenerate damaged tissues in an adult. However, cancer stem cells are thought to hijack the ability of normal stem cells to express MET, and thus become the cause of cancer persistence and spread to other sites in the body.

### HER2/neu

Also known as ErbB-2, which stands for “Human Epidermal growth factor Receptor 2” and is a protein giving higher aggressiveness in breast cancers. HER2 is a cell membrane surface-bound receptor tyrosine kinase and is normally involved in the signal transduction pathways leading to cell growth and differentiation. It is encoded within the genome by HER2/neu, a known proto-oncogene. Approximately 15–20% of breast cancers have an amplification of the HER2/neu gene or overexpression of its protein product, leading to increased disease recurrence and worse prognosis. Because of its prognostic role as well as its ability to predict response to trastuzumab (Herceptin), breast tumors are routinely checked for overexpression of HER2/neu. Overexpression also occurs in other cancer such as ovarian cancer, stomach cancer, and aggressive forms of uterine cancer.

### HMGB (High Mobility Group Box Protein)

Originally known as amphoterin, it mediates neural growth and binds receptors for advanced glycation end products (R-AGE). HMGB1 has 219 amino acid residues. It is located in the nucleus. It is a chromatin-associated nuclear protein that plays an important role in transcription and DNA recombination. It plays a critical role in HIV, sepsis, tumors, cardiovascular diseases, neurologic disorders and amyloidosis.

### Hypoxia Inducible Factors (HIFs)

The HIFs are transcription factors that respond to changes in available oxygen in the cellular environment, specifically, to *decrease* in oxygen, or hypoxia. Hypoxia promotes the formation of blood vessels, and is important for the formation of a vascular system in embryos. The hypoxia in wounds promotes the formation of blood vessels and the migration of keratinocytes and the restoration of the epithelium. In general, HIFs are vital to development.

### ICAM

It is the intercellular adhesion molecule, present in low concentrations on the membranes of leukocytes and endothelial cells. Upon cytokine stimulation, the concentrations greatly increase. It stabilizes cell-to-cell interactions and facilitates leukocyte endothelial transmigration. ICAM-1 has been characterized as a site for the cellular entry of human rhinovirus. ICAM-1 possesses binding sites for a number of immune-associated ligands. Notably, ICAM-1 binds to Macrophage Adhesion Ligand-1 (Mac-1), Leukocyte Function Associated Antigen-1 (LFA-1), and Fibrinogen. These three proteins are generally expressed on endothelial cells and leukocytes, and they bind to ICAM-1 to facilitate transmigration of leukocytes across vascular endothelia during the inflammatory response.

### Insulin-like Growth Factor (IGF)

Secreted by hepatocytes, it produces hypoglycemia. It mediates some actions of growth hormone.

### Insulin-like Growth Factor Receptor (IGFR)

It is a transmembrane receptor that is activated by IGF1 and IGF2. It belongs to the large class of tyrosine kinase receptors. IGF-1 plays an

important role in growth and continues to have anabolic effects in adults. It can induce hypertrophy of skeletal muscle and other target tissues. The IGFR is implicated in several cancers, including breast and prostate cancers. It has role in insulin signaling and on the normal aging process as well.

### Insulin Receptor (IR)

Insulin binds to its receptor which in turn starts many protein activation cascades. These include: translocation of Glut-4 transporter to the plasma membrane and influx of glucose, glycogen synthesis, glycolysis and fatty acid synthesis. The main effect of activation of the insulin receptor is increased glucose uptake. For this reason “insulin insensitivity”, or a decrease in insulin receptor signaling, leads to diabetes mellitus type 2. The alpha and beta subunits of the IR are encoded by a single gene (*INSR*). The insulin receptor has also recently been designated as **CD220** (cluster of differentiation 220) (see Chapter 24).

### Insulin Receptor Substrate (IRS)

It is an important ligand in the insulin response of human cells. IRS1 plays a key role in transmitting signals from the insulin receptors to intracellular pathways PI3K / Akt and Erk MAP kinase pathways. IRS-1 plays important biological function for both metabolic and mitogenic pathways. Mice deficient of IRS1 have pronounced growth impairment. IRS1 may also play a role in breast cancer (see chapters 24 and 50).

### Jun N-terminal kinases (JNKs)

These are kinases that bind and phosphorylate c-Jun on Ser63 and Ser73. They are mitogen-activated protein kinases which are responsive to stress stimuli, such as cytokines, ultraviolet irradiation, heat shock, and osmotic shock. JNK1 is involved in apoptosis, neurodegeneration, cell differentiation, proliferation and inflammatory conditions. JNK1 also functions in cytokine production mediated by AP-1 (Activation Protein 1). Inflammatory signals, changes in levels of reactive oxygen species, ultraviolet radiation, protein synthesis inhibitors, and a variety of stress stimuli can activate JNK.

### MAP Kinase Activated Protein Kinase 2

It is an enzyme that is encoded by the *MAPKAPK2* gene. In conjunction with p38 MAP kinase, this kinase is known to be involved in many cellular processes including stress and inflammatory responses, nuclear export, gene expression regulation and cell proliferation. Heat shock protein HSP27 was shown to be one of the substrates of this kinase in vivo.

### Matrix Metalloproteinases (MMPs)

These are zinc-dependent endopeptidases; other family members are **adamalysins**, **serralysins**, and **astacins**. The MMPs belong to a larger family of proteases known as the **metzincin** superfamily. Collectively they are capable of degrading all kinds of extracellular matrix proteins. They cleave cell surface receptors, release the apoptotic ligands (such as the FAS ligand), and inactivate chemokines/cytokines. MMPs also play a major role on cell proliferation, migration (adhesion/dispersion), differentiation, angiogenesis, apoptosis and host defense. The MMPs play an important role in tissue remodeling associated

with morphogenesis, angiogenesis, tissue repair, cirrhosis, arthritis and metastasis. MMP-2 and MMP-9 are thought to be important in cancer metastasis. MMP-1 is involved in rheumatoid arthritis, osteo-arthritis and aortic aneurysm. Excess MMPs degrade the structural proteins of the aortic wall. The MMPs are inhibited by specific endogenous tissue inhibitor of metalloproteinases (TIMPs), which comprise a family of four protease inhibitors: TIMP-1, TIMP-2, TIMP-3 and TIMP-4.

### Mitogen Activated Protein Kinase Kinase

Abbreviated as MAPKK or MAP2K, it is a kinase enzyme which phosphorylates Mitogen-activated protein kinase (MAPK). There are 7 genes—MEK 1 and 2, MKK 3 to 7. The activators of p38 (MKK3 and MKK4), JNK (MKK4), and ERK (MEK1 and MEK2) define independent MAP kinase signal transduction pathways.

### Osteocalcin

A noncollagenous protein found in bone and dentin. It is secreted by osteoblasts and plays a role in mineralization and calcium ion homeostasis. As osteocalcin is manufactured by osteoblasts, it is often used as a biochemical marker, or biomarker, for the bone formation process. It has been routinely observed that higher serum osteocalcin levels are relatively well correlated with increases in bone mineral density (BMD) during the treatment with anabolic bone formation drugs for osteoporosis, such as Forteo. Osteocalcin is used as a preliminary biomarker on the effectiveness of a given drug on bone formation. See Chapter 39 for calcium metabolism.

### Osteonectin

A glycoprotein in the bone that binds calcium. It is secreted by osteoblasts during bone formation, initiating mineralization and promoting mineral crystal formation. It also shows affinity for collagen in addition to bone mineral calcium. Osteonectin also increases the production of matrix metalloproteinases, a function important to invading cancer cells within bone. Overexpression of osteonectin is reported in chronic pancreatitis and in many human cancers such as breast, prostate and colon.

### Osteopontin (OPN)

Synonyms for this protein include sialoprotein I and 44K BPP (bone phosphoprotein). It is an important factor in bone remodeling. OPN binds to several integrin receptors expressed by leukocytes. These receptors function in cell adhesion, migration, and survival in these cells. OPN plays an important role in neutrophil recruitment. Activated T cells are promoted by IL-12 to differentiate towards the Th1 type, producing cytokines including IFN-gamma. OPN inhibits production of the Th2 cytokine IL-10, which leads to enhanced Th1 response. OPN influences cell-mediated immunity and has Th1 cytokine functions. It enhances B cell immunoglobulin production and proliferation. OPN is an important anti-apoptotic factor; it blocks the cell death of macrophages, T cells, fibroblasts and endothelial cells exposed to harmful stimuli. OPN prevents the cell death in inflammatory colitis. OPN is an active player in wound healing, bone turnover, tumorigenesis, inflammation, ischemia and immune responses. Therefore, manipulation of OPN may be useful in the treatment of autoimmune diseases, cancer metastasis, osteoporosis and some forms of stress.

### Osteoprotegerin (OPG)

Also known as **osteoclastogenesis inhibitory factor** (OCIF), it is a cytokine, which can inhibit the production of osteoclasts. It is a member of the tumor necrosis factor (TNF) receptor superfamily. Osteoprotegerin inhibits the differentiation of osteoclast precursors. Osteoclasts are related to monocyte/macrophage cells and are derived from granulocyte/macrophage-forming colony units (CFU-GM) into osteoclasts. Recombinant human osteoprotegerin acts on bone, increasing bone mineral density and bone volume. Osteoprotegerin has been used experimentally to decrease bone resorption in women with postmenopausal osteoporosis and in patients with lytic bone metastases.

### p38

It is so named, because it is a protein with molecular weight 38 kDa. **Mitogen activated protein kinases** are a class of protein kinases which are responsive to stress stimuli, such as cytokines, ultraviolet irradiation, heat shock, and osmotic shock, and are involved in cell differentiation and apoptosis. Similar to the SAPK/JNK pathway, p38 MAP kinase is activated by a variety of cellular stresses including osmotic shock, inflammatory cytokines, lipopolysaccharides (LPS), ultraviolet light and growth factors.

### p53

It is so named, because it is a protein with molecular weight 53 kDa. It is a tumor suppressor protein that in humans is encoded by the *TP53* gene. The p53 regulates the cell cycle and thus functions as a tumor suppressor that is involved in preventing cancer. As such, p53 has been described as “the guardian angel gene,” and the “master watchman,” referring to its role in conserving stability by preventing genome mutation. It can activate DNA repair proteins when DNA has sustained damage. It can induce growth arrest by holding the cell cycle at the G<sub>1</sub>/S regulation point on DNA damage recognition. It can initiate apoptosis (programed cell death), if the DNA damage proves to be irreparable. Activated p53 binds DNA and activates expression of several genes including WAF1/CIP1 encoding for p21. This p21(WAF1) binds to the G1-S/CDK (CDK2) and S/CDK complexes (molecules important for the G1/S transition in the cell cycle) inhibiting their activity. The p53 has many anticancer mechanisms, and plays a role in apoptosis, genetic stability, and inhibition of angiogenesis. People who inherit only one functional copy of the *TP53* gene will most likely develop tumors in early adulthood, a disease known as Li-Fraumeni syndrome. The *TP53* gene can also be damaged in cells by mutagens (chemicals, radiation, or viruses), increasing the likelihood that the cell will begin decontrolled division. More than 50 percent of human tumors contain a mutation or deletion of the *TP53* gene. (Please also see cell cycle regulation in Chapter 47).

### p70S6 kinase

The p70S6K is a serine/ threonine kinase that acts downstream of PIP3 and phosphoinositide-dependent kinase-1 in the PI3 kinase pathway. As the name suggests, its target substrate is the S6 ribosomal protein. Phosphorylation of S6 induces protein synthesis at the ribosome. Physical exercise activates protein synthesis via phosphorylation (activation) of p70S6K in a pathway that is dependent on mTOR.



This has been demonstrated by using an inhibitor of mTOR, rapamycin, to block an increase in muscle mass. Exercise has been shown to increase levels of IGF-1 in muscle, thus inducing the IGF-1/PI3K/Akt/P70S6K signaling pathway, and thereby increasing the protein synthesis required to build muscle.

### Phosphatidylinositol Glycan Biosynthesis Class F Protein (PIGF)

It is a protein that is encoded by the *PIGF* gene. The protein is involved in glycosyl phosphatidylinositol (GPI) anchor biosynthesis. The GPI-anchor is found on many blood cells and serves to anchor proteins to the cell surface. This protein and another GPI synthesis protein, PIGO, function in the transfer of ethanolamine phosphate (EtNP) to the third mannose in GPI.

### Platelet Derived Growth Factor (PDGF)

It regulates cell growth and division. In particular, it plays a significant role in blood vessel formation (angiogenesis), the growth of blood vessels from already existing blood vessel tissue. Uncontrolled angiogenesis is a characteristic of cancer. PDGF plays a role in embryonic development, cell proliferation, cell migration, and angiogenesis. PDGF is required in cellular division for fibroblasts. In essence, the PDGF allows a cell to skip the G1 checkpoints in order to divide. PDGF is also known to maintain proliferation of oligodendrocyte progenitor cells. PDGF has provided a target for protein receptor antagonists to treat disease. There are 2 proteins, PDGF-A and B. They activate the mitogen-activated protein kinase (MAPK), PI-3 kinase and phospholipase (PLC) pathways; these are key downstream mediators of the PDGFR signaling.

### Poly (ADP-ribose) Polymerase (PARP)

The PARP is a protein involved in DNA repair and programmed cell death. PARP enzymes are essential in a number of cellular functions, including expression of inflammatory genes. One important function of PARP is assisting in the repair of single-strand DNA nicks. Upon DNA cleavage by enzymes involved in cell death (such as caspases), PARP can deplete the ATP of a cell in an attempt to repair the damaged DNA. ATP depletion in a cell leads to lysis and cell death. PARP also has the ability to directly induce apoptosis, via the production of PAR, which stimulates mitochondria to release AIF. This mechanism appears to be caspase-independent. PARP mediated post-translational modification of proteins such as CTCF can affect the amount of DNA methylation at CpG dinucleotides. This regulates the insulator features of CTCF that can differentially mark the copy of DNA inherited from either the maternal or paternal DNA through the process known as genomic imprinting. PARP has also been proposed to affect the amount of DNA methylation by directly binding to the DNA methyltransferase.

### Protein C

It is a protein that in humans is encoded by the *PROC* gene. Protein C is a major physiological anticoagulant. It is a vitamin K-dependent serine protease enzyme that is activated by thrombin into **activated protein C (APC)**. The activated form (with protein S and phospholipid as a cofactor) degrades Factor Va and Factor VIIIa. The activated protein C provides physiologic antithrombotic activity and exhibits both anti-inflammatory and anti-apoptotic activities. Protein C deficiency is a rare

genetic disorder that predisposes to venous thrombosis and habitual abortion. If homozygous, this presents with a form of disseminated intravascular coagulation in newborns termed purpura fulminans; it is treated by replacing the defective protein C. Activated protein C resistance is the inability of protein C to cleave factors V and/or VIII. This may be hereditary or acquired. The best known and most common hereditary form is Factor V Leiden. Warfarin necrosis is acquired protein C deficiency; it is due to treatment with the vitamin K inhibitor anticoagulant warfarin. In initial stages of action, inhibition of protein C may be stronger than inhibition of the vitamin K-dependent coagulation factors (II, VII, IX and X), leading to paradoxical activation of coagulation and necrosis of skin.

### RANTES

Also known as **Chemokine (C-C motif) ligand 5** or **CCL5**. It is a protein which is encoded by the *CCL5* gene. CCL5 is an 8 kDa protein classified as a chemotactic cytokine or chemokine. CCL5 is chemotactic for T cells, eosinophils, and basophils, and plays an active role in recruiting leukocytes into inflammatory sites. With the help of particular cytokines (i.e., IL-2 and IFN gamma, that are released by T cells, CCL5 also induces the proliferation and activation of NK (natural-killer) cells to form LAK (lymphokine activated killer) cells. It is also an HIV-suppressive factor, released from CD8 + T cells. RANTES is a CC chemokine and expressed in more than 100 human diseases. RANTES expression is regulated in T lymphocytes by Kruppel like factor 13 (KLF13).

### Rb

The **retinoblastoma protein** is a tumor suppressor protein that is dysfunctional in many types of cancer. One highly studied function of Rb is to prevent excessive cell growth by inhibiting cell cycle progression until a cell is ready to divide. Rb prevents the cell from replicating damaged DNA by preventing its progression along the cell cycle through G1 (first gap phase) into S (synthesis phase). In the hypophosphorylated state, pRb is active and carries out its role as tumor suppressor by inhibiting cell cycle progression. Phosphorylation inactivates Rb, during the M-to-G1 transition, Rb is progressively dephosphorylated by PP1, returning to its growth-suppressive hypophosphorylated state. (Please also see cell cycle regulation in Chapter 47).

### Resistin

Resistin is a cysteine-rich protein with a molecular weight of 12 kDa. It is secreted by adipose tissue of mice and rats. In other mammals, resistin is secreted by immune and epithelial cells. It was called "resistin" because of the observed insulin resistance in mice injected with resistin. The effects are exactly opposite of the adiponectin. Resistin is found to increase the insulin resistance of tissues in obesity as well as in type 2 diabetes mellitus. Current research has linked resistin to inflammation and energy homeostasis.

### SAA (Serum Amyloid A)

The SAA proteins are a family of apolipoproteins associated with high-density lipoprotein (HDL) in plasma. Acute-phase serum amyloid A proteins (A-SAAs) are secreted during the acute phase of inflammation. These proteins recruit immune cells to inflammatory sites, and induce

enzymes that degrade extracellular matrix. A-SAAs are implicated in several chronic inflammatory diseases, such as amyloidosis, atherosclerosis, and rheumatoid arthritis. Please also see Chapter 58, under Amyloidosis.

### SAPP-alpha and beta

The accumulation of beta-amyloid in Alzheimer's disease (AD) is only one of the results of proteolytic cleavage of **amyloid precursor protein** (APP). Cleavage by beta- and gamma-secretase leads to A-beta production, whereas alpha-secretase cleavage results in a soluble form, sAPP-alpha. It is released from neurons in response to electrical activity and may function in modulation of neuronal excitability, synaptic plasticity, neurite outgrowth, synaptogenesis, and cell survival. A signaling pathway involving guanosine 3', 5'-cyclic monophosphate is activated by sAPP-alpha and modulates the activities of potassium channels, N-methyl-D-aspartate receptors, and the transcription factor NFkB. Genetic mutations or age-related metabolic changes may promote neuronal degeneration in Alzheimer's disease by increasing production of A-beta and/or decreasing levels of neuroprotective sAPP-alpha. Proteolytic cleavage of beta-amyloid precursor protein (beta APP) by alpha-secretase results in release of one secreted form (sAPP) of APP (sAPP-alpha), whereas cleavage by beta-secretase releases a C-terminally truncated sAPP (sAPP-beta) plus amyloid beta-peptide (A-beta). APP-beta mutations are linked to some inherited forms of Alzheimer's disease. In such cases, the levels of sAPP-alpha are reduced and levels of sAPP-beta are increased. The sAPP-alpha may play important roles in neuronal plasticity and survival, whereas A-beta can be neurotoxic. sAPP-alpha is approximately 100-fold more potent than sAPP-beta in protecting hippocampal neurons against excitotoxicity.

### Selectins

They are a family of cell adhesion molecules (or CAMs). There are three subsets of selectins: E-Selectin, L-Selectin and P-Selectin. During an inflammatory response, stimuli such as histamine and thrombin cause endothelial cells to mobilize P-selectin from stores inside the cell to the cell surface. In addition, cytokines such as TNF-alpha stimulate the expression of E-selectin and additional P-selectin. The best-characterized ligand for the three selectins is P-selectin glycoprotein ligand-1 (PSGL-1), which is a mucin-type glycoprotein expressed on all white blood cells. Selectins are tried experimentally, to kill cancer cells, and to treat osteoporosis.

### STAT

It is the abbreviation of **Signal Transducers and Activator of Transcription**. These proteins regulate cell growth, survival and differentiation. The transcription factors of this family are activated by the Janus Kinase (JAK). Dysregulation of this pathway is frequently observed in tumors and leads to increased angiogenesis and immunosuppression. STAT proteins play a role in maintaining immune tolerance and tumor surveillance. STAT proteins were originally described as latent cytoplasmic transcription factors that require phosphorylation for nuclear retention. The unphosphorylated STAT proteins shuttle between cytosol and the nucleus waiting for its activation signal. Once the activated transcription factors reaches the nucleus, they bind to consensus DNA-recognition motif called gamma activated sites (GAS) in the promoter region of cytokine inducible genes and activate transcription of these genes.

### Tau Proteins

Tau are microtubule-associated proteins that are abundant in neurons in the central nervous system. Phosphorylation of Tau is regulated by a host of kinases. For example, PKN, which is a serine/threonine kinase. When PKN is activated, it phosphorylates tau, resulting in disruption of microtubule organization. Hyperphosphorylation of the Tau protein (tau inclusions), however, can result in the self-assembly of tangles of paired helical filaments and straight filaments, which are involved in the pathogenesis of Alzheimer's disease and other Tauopathies.

### Transforming Growth Factor (TGF)

The TGF-beta is a protein that controls proliferation, cellular differentiation, and other functions in most cells. It plays a role in immunity, cancer, heart disease and diabetes. TGF-beta acts as an antiproliferative factor in normal epithelial cells and at early stages of oncogenesis. Some cells secrete TGF-beta and also have receptors for TGF-beta. This is known as autocrine signaling. Cancerous cells increase their production of TGF, which also acts on surrounding cells. TGF-beta exists in three isoforms called TGF-beta1, TGF-beta2 and TGF-beta3. The TGF is part of a superfamily of proteins, which includes inhibins, activin, bone morphogenetic protein and Vg-1. TGF-beta induces apoptosis in two ways: through the SMAD pathway or through the DAXX pathway. TGF-beta is important in regulation of the immune system by CD25+ Regulatory T cell and the development of both CD25+ Regulatory T cell and Th17 cells. TGF-beta blocks the activation of lymphocytes and monocyte derived phagocytes.

### Thrombopoietin

Secreted by hepatocytes, it stimulates platelet development and hematopoietic stem cells.

### Thrombomodulin

Also called CD141 or BDCA-3. It is an integral membrane protein expressed on the surface of endothelial cells. In humans, thrombomodulin is encoded by the THBD gene. It is a cofactor in the thrombin-induced activation of protein C in the anticoagulant pathway by forming a 1:1 stoichiometric complex with thrombin. This raises the speed of protein C activation thousand-fold. Thrombomodulin-bound thrombin has no procoagulant effect. The TT-complex also inhibits fibrinolysis by cleaving thrombin-activatable fibrinolysis inhibitor (TAFI) into its active form.

### Thrombospondin 2 (TSP2)

It inhibits angiogenesis in vitro by limiting proliferation and inducing apoptosis of endothelial cells (ECs). TSP2 can also modulate the extracellular levels of gelatinases (matrix metalloproteinases, MMPs) and potentially influence the remodeling of the extracellular matrix (ECM).

### TIMP (Metalloproteinase Inhibitor)

The TIMP-1, is a glycoprotein that is expressed from the several tissues of organisms. This protein is a member of the TIMP family. The glycoprotein is a natural inhibitor of the matrix metalloproteinases (MMPs), a group of peptidases involved in degradation of the extracellular matrix.

Moreover, the protein is able to promote cell proliferation in a wide range of cell types, and have an anti-apoptotic function. Transcription of this gene is highly inducible in response to many cytokines and hormones. The gene is located within intron 6 of the synapsin I gene and is transcribed in the opposite direction.

### Tumor Necrosis Factor Receptor (TNFR)

Otherwise known as **death receptor**; it is a cytokine receptor that binds tumor necrosis factor (TNF). TNF alpha is otherwise called, CD120.

### Vascular Cell Adhesion Molecule (VCAM)

VCAM-1, also known as **CD106**, mediates the adhesion of lymphocytes, monocytes, eosinophils, and basophils to vascular endothelium. It also functions in leukocyte-endothelial cell signal transduction, and it may play a role in the development of atherosclerosis and rheumatoid arthritis. Upregulation of VCAM-1 in endothelial cells by cytokines occurs as a result of increased gene transcription (e.g. in response to Tumor necrosis factor-alpha (TNF- $\alpha$ ) and Interleukin-1 (IL-1)) and through stabilization of Messenger RNA (mRNA) (e.g. Interleukin-4 (IL-4)). The promoter region of the VCAM-1 gene contains functional NFkB (nuclear factor-kappa B) sites. Primarily, the VCAM-1 protein is an endothelial ligand for VLA-4 (Very Late Antigen-4) of the beta1 subfamily of integrins. VCAM-1 expression has also been observed in other cell types (e.g. smooth muscle cells). Certain melanoma cells can

use VCAM-1 to adhere to the endothelium. VCAM-1 may participate in monocyte recruitment to atherosclerotic sites. As a result, VCAM-1 is a potential drug target.

### Vascular Endothelial Growth Factor (VEGF)

It is a chemical signal produced by cells that stimulate the growth of new blood vessels. VEGF is a sub-family of the platelet-derived growth factor family of cystine-knot growth factors. It is part of the system that restores the oxygen supply to tissues when blood circulation is inadequate. The normal function of VEGF is to create new blood vessels during embryonic development, after injury, and collateral circulation to bypass blocked vessels. Solid cancers cannot grow beyond a limited size without an adequate blood supply; cancers that can express VEGF are able to grow and metastasize. Drugs, such as bevacizumab can inhibit VEGF and control such cancers. VEGF has been associated with breast cancer, rheumatoid arthritis, diabetic retinopathy, age related macular degeneration, angiosarcoma, etc. Anti-VEGF therapies involve monoclonal antibodies such as bevacizumab (Avastin), antibody derivatives such as ranibizumab (Lucentis), or orally available small molecules that inhibit the tyrosine kinases stimulated by VEGF: these are lapatinib (Tykerb), sunitinib (Sutent), sorafenib (Nexavar), axitinib, and pazopanib. All members of the VEGF family stimulate cellular responses by binding to tyrosine kinase receptors (VEGFRs) on the cell surface, causing them to dimerize and become activated through transphosphorylation.

# APPENDICES

## Appendix I

### Abbreviations Used in this Book

A	= Adenine	Asp	= Aspartic acid
A	= Alanine	AST	= Aspartate amino transferase
Å	= Angstrom unit ( $10^{-10}$ m)	Asx	= Asparagine or aspartic acid
ACAT	= Acyl cholesterol acyl transferase	ATP	= Adenosine triphosphate
ACh	= Acetylcholine		
ACP	= Acid phosphatase	B	= Bursa derived (lymphocyte)
ACP	= Acyl carrier protein	BMR	= Basal metabolic rate
ACTH	= Adrenocorticotrophic hormone	bp	= Base pair
ADH	= Antidiuretic hormone (vasopressin)	BSP	= Bromsulphthalein
ADH	= Alcohol dehydrogenase	BUN	= Blood urea nitrogen
ADP	= Adenosine disphosphate		
AFP	= Alpha fetoprotein	C	= Carbon
AG	= Anion gap	C	= Cytosine
A/G	= Albumin-globulin (ratio)	C	= Cysteine
AHG	= Antihemophilic globulin	C	= Complement
AIDS	= Acquired immunodeficiency syndrome	Ca	= Calcium
Ala	= Alanine	cal	= Calorie
ALA	= (delta) Amino levulinic acid	cAMP	= Cyclic AMP (3',5'-cyclic AMP)
ALP	= Alkaline phosphatase	CBG	= Cortisol binding globulin
ALT	= Alanine amino transferase	cDNA	= Complementary copy DNA
AMP	= Adenosine monophosphate	CEA	= Carcinoembryonic antigen
ANF	= Atrial natriuretic factor	ChE	= Choline esterase
APUD	= Amine precursor uptake decarboxylase (cell)	Ci	= Curie (unit)
Arg	= Arginine	CK	= Creatine kinase
Asn	= Asparagine	CKK	= cholecystokinin



Cl	= Chlorine, chloride	F	= Phenylalanine
CNS	= Central nervous system	Fab	= Fraction antibody (of immunoglobulin)
CMP	= Cytidine monophosphate	FAD	= Flavin adenine dinucleotide
Co	= Cobalt	FADH <sub>2</sub>	= Reduced FAD
CO	= Carbon monoxide	Fc	= Fraction crystallizable (of immunoglobulin)
CO <sub>2</sub>	= Carbon dioxide	Fe	= Iron
CoA	= (CoA-SH); Co-enzyme A	FFA	= Free fatty acid
COMT	= Catechol-o-methyl transferase	FIGLU	= Formiminoglutamic acid
CoQ	= Co-enzyme Q	FMN	= Flavin mononucleotide
CPS	= Carbamoyl phosphate synthetase	FSH	= Follicular stimulating hormone
Cr	= Chromium	FTM	= Fractional test meal
CRH	= Corticotrophin releasing hormone	FT4I	= Free thyroxine index
CRP	= C-reactive protein		
Cs	= Cesium	g	= Gram
CSF	= Cerebrospinal fluid	G	= Glycine
CTP	= Cytidine triphosphate	G	= Guanine
Cu	= Copper	ΔG	= Change in free energy
Cys	= Cysteine	GABA	= Gamma aminobutyric acid
		GAG	= Glycosaminoglycans
D	= Aspartic acid	Gal	= Galactose
D	= Dalton (molecular weight or molecular mass)	GalNAc	= N-acetyl galactosamine
DAG	= Diacyl glycerol	GCSF	= Granulocyte colony stimulating factor
dATP	= Deoxyadenosine triphosphate	GDP	= Guanosine diphosphate
ddNTP	= 2',3'-dideoxynucleoside triphosphate	GFR	= Glomerular filtration rate
DHA	= Docosahexaenoic acid	GGT	= Gamma glutamyl transaminase
DHEA	= Dehydroepiandrosterone	GH	= Growth hormone
DHU	= Dihydrouracil	GHRH	= Growth hormone releasing hormone
DIT	= Di-iodotyrosine	GIP	= Gastric inhibitory polypeptide
DMT	= Divalent metal transporter	GIT	= Gastrointestinal tract
DNA	= Deoxyribonucleic acid	GK	= Glucokinase
dNTP	= Deoxynucleoside triphosphate	Gln	= Glutamine
DOPA	= Dihydroxyphenylalanine	Glu	= Glutamic acid
		Glu	= Glucose
E	= Glutamic acid	Gly	= Glycine
ECF	= Extracellular fluid	Glx	= Glutamine or glutamic acid
ECG	= Electrocardiogram	GnRH	= Gonadotropin releasing hormone
EDTA	= Ethylenediaminetetraacetate	GOD	= Glucose oxidase
EF	= Elongation factor (protein synthesis)	GP	= Glutathione peroxidase
EFA	= Essential fatty acid	GPD	= Glucose-6-phosphate dehydrogenase
EGFR	= Epidermal growth factor receptor	GR	= Glutathione reductase
ELISA	= Enzyme-linked immunosorbent assay	GSH	= Glutathione
EMIT	= Enzyme multiplied immunoassay	GTT	= Glucose tolerance test
EPA	= Eicosapentaenoic acid	GTP	= Guanosine triphosphate
ESR	= Erythrocyte sedimentation rate		
ETC	= Electron transport chain		

H	= Hydrogen	kD	= Kilo daltons (see D)
H	= Histidine	Km	= Michaelis constant
Hb	= Hemoglobin	L	= Leucine
HbA1c	= Glycated hemoglobin	LATS	= Long acting thyroid stimulator
HbS	= Hemoglobin sickle cell	LCAT	= Lecithin cholesterol acyl transferase
hCG	= Human chorionic gonadotropin	LDH	= Lactate dehydrogenase
HCl	= Hydrochloric acid	LDL	= Low density lipoproteins
HCO <sub>3</sub> <sup>-</sup>	= Bicarbonate ion	Leu	= Leucine
HDL	= High density lipoprotein	LH	= Luteinizing hormone
HER2	= Human epidermal growth factor receptor	Li	= Lithium
Hg	= Mercury	LLAT	= Lecithin lysolecithin acyl transferase
HGF	= Hepatocyte growth factor	Lp	= Lipoproteins
HGPRT	= Hypoxanthine guanine phosphoribosyl transferase	LpL	= Lipoprotein lipase
His	= Histidine	LT	= Leukotrienes
HIV	= Human immunodeficiency virus	LTR	= Long terminal repeat
HK	= Hexokinase	Lys	= Lysine
HMGCoA	= (beta)hydroxy (beta)methyl glutaryl CoA	M	= Molar
HpBsAg	= Hepatitis B surface antigen	M	= Monoclonal (band)
HPL	= Human placental lactogen	M	= Methionine
HPLC	= High performance liquid chromatography	MAG	= Monoacyl glycerol
HRE	= Hormone response element	MAO	= Monoamine oxidase
HSP	= Heat shock protein	MCFA	= Medium chain fatty acid
HSV	= Herpes simplex virus	MCSF	= Macrophage colony stimulating factor
I	= Isoleucine	Met	= Methionine
I	= Iodine	mEq	= Milli equivalents
IDL	= Intermediate density lipoprotein	mg	= Milligram
IF	= Initiation factor	Mg	= Magnesium
IFN	= Interferon	MIF	= Macrophage migration inhibition factor
Ig	= Immunoglobulin	mM	= Milli molar
IGF	= Insulin like growth factor	Mn	= Manganese
IL	= Interleukin	Mo	= Molybdenum
Ile	= Isoleucine	mol	= Mole (s)
IMP	= Inosine monophosphate	mmol	= Milli mole
INH	= Isonicotinic acid hydrazide (isoniazid)	MMP	= Matrix metalloproteinase
IP3	= Inositol triphosphate	mol wt	= Molecular weight
IRE-BP	= Iron response element binding protein	mRNA	= Messenger RNA
IRES	= Internal ribosomal entry site	MSH	= Melanocyte stimulating hormone
IRS	= Insulin receptor substrate	MUFA	= Monounsaturated fatty acid
IUdR	= Iododeoxyuridine	N	= Asparagine
K	= Lysine	N	= Nitrogen
K	= Potassium	Na	= Sodium
kbp	= Kilo base pair	NaCl	= Sodium chloride
kcal	= Kilocalorie	NAD <sup>+</sup>	= Nicotinamide adenine dinucleotide
		NADH	= Reduced nicotinamide adenine dinucleotide

NADP <sup>+</sup>	= Nicotinamide adenine dinucleotide phosphate	Pro	= Proline
NADPH	= Reduced nicotinamide adenine dinucleotide phosphate	PRPP	= Phosphoribosyl pyrophosphate
NANA	= N-acetyl neuraminic acid	PTH	= Parathyroid hormone
NEFA	= Non-esterified fatty acid	PUFA	= Polyunsaturated fatty acid
ng	= Nanogram (10 <sup>-9</sup> gram)	Q	= Glutamine
NH <sub>3</sub>	= Ammonia	QPRT	= Quinolinate phosphoribosyl transferase
NH <sub>4</sub> <sup>+</sup>	= Ammonium ion	R	= Arginine
Ni	= Nickel	Ra	= Radium
NSE	= Neurone specific enolase	RBC	= Red blood cell
NTP	= Nucleoside triphosphate	RBP	= Retinol binding protein
O	= Oxygen	RDA	= Recommended daily allowance
OD	= Optical density	Rf	= Ratio of fronts
OMP	= Orotidine monophosphate	RFLP	= Restriction fragment length polymorphism
osm	= Osmoles (osmolality)	RIA	= Radioimmunoassay
P	= Proline	RNA	= Ribonucleic acid
P	= Phosphorus	RNase	= Ribonuclease
PABA	= Para amino benzoic acid	RQ	= Respiratory quotient
PAGE	= Polyacrylamide gel electrophoresis	rRNA	= Ribosomal RNA
PAH	= Para amino hippurate	RT	= Reverse transcriptase
PAH	= Phenyl alanine hydroxylase	rT3	= Reverse T3
PAP	= Prostatic acid phosphatase	S	= Svedberg unit
PAPS	= Phosphoadenosine phosphosulfate	S	= Serine
PBI	= Protein bound iodine	[S]	= Substrate concentration
pCO <sub>2</sub>	= Partial pressure of carbon dioxide	SAH	= S-adenosyl homocysteine
PCR	= Polymerase chain reaction	SAM	= S-adenosyl methionine
PDGF	= Platelet derived growth factor	SCFA	= Short chain fatty acid
PDH	= Pyruvate dehydrogenase	SDA	= Specific dynamic action
PEM	= Protein energy malnutrition	Se	= Selenium
PEPCK	= Phosphoenol pyruvate carboxykinase	Ser	= Serine
PFK	= Phosphofructokinase	SH	= Sulfhydryl (group)
pH	= Hydrogen ion concentration	SHBG	= Sex hormone binding globulin
Phe	= Phenylalanine	SRE	= Steroid response element
Pi	= Protease inhibitor	sRNA	= Soluble RNA
Pi	= Inorganic phosphate	T	= Threonine
pI	= Iso-electric point	T	= Thymus derived (lymphocyte)
PIF	= Prolactin inhibitory factor	T	= Thymine
PIP <sub>2</sub>	= Phosphatidylinositol diphosphate	T3	= Tri-iodothyronine
pKa	= Dissociation constant of acid	T4	= Tetraiodothyronine (thyroxine)
PL	= Phospholipid	TAG	= Triacylglycerol
PLP	= Pyridoxal phosphate	TBG	= Thyroxine binding globulin
pO <sub>2</sub>	= Partial pressure of oxygen	Tc	= Technicium
PPi	= Inorganic pyrophosphate	TCA	= Tricarboxylic acid (cycle)
		TfR	= Transferrin receptor

TG	= Triglyceride	$\mu\text{M}$	= Micromolar
Tgb	= Thyroglobulin	UMP	= Uridine monophosphate (uridylic acid)
TGF	= Transforming growth factor	UTP	= Uridine triphosphate
THFA	= Tetrahydrofolic acid	V	= Velocity
Thr	= Threonine	V	= Valine
TIBC	= Total iron binding capacity	Val	= Valine
TLC	= Thin layer chromatography	VEGF	= Vascular endothelial growth factor
Tm	= Tubular maximum	VIP	= Vasoactive intestinal polypeptide
Tm	= Melting temperature	VLCFA	= Very long chain fatty acid
TNF	= Tumor necrosis factor	VLDL	= Very low density lipoprotein
TPP	= Thiamine pyrophosphate	VMA	= Vanillyl mandelic acid
TRH	= Thyrotrophin releasing hormone	Vmax	= Maximal velocity
tRNA	= Transfer RNA	W	= Tryptophan
Try	= Tryptophan	XMP	= Xanthosine monophosphate
TSH	= Thyroid stimulating hormone	Y	= Tyrosine
Tyr	= Tyrosine	Z	= Glutamine or glutamic acid
U	= (international) Unit	Zn	= Zinc
$\mu$	= Micrometer ( $10^{-6}$ meter)		
$\mu\text{L}$	= Microliter		



# Appendix II

## Normal Values (Reference Values)

P = plasma; B = blood; S = serum; E = erythrocyte; U = urine  
 CSF = cerebrospinal fluid; pg = picogram; ng = nanogram; µg = microgram;  
 mg = milligram; d = day

Analyte	Sample	Units	SI units
Ammonia	P/S	< 50 µg/dL	
Acetoacetate	S	0.3–1 mg/dL	
Acid phosphatase (ACP), Total	P/S	0.5–4 KAU/dL	2.5–12 IU/L
Acid phosphatase (tartarate labile)	P/S	< 0.9 KAU/dL	<1 IU/L
ACTH (corticotropin)	P	2.5–10 ng/dL	2–10 pmol/L
Alanine amino transferase (ALT/SGPT)	S	< 45.0 IU/L	
Male:			
Female:		< 35.0 IU/L	
Albumin	S	3.5–5 g/dL	35–50 g/L
Albumin	CSF	15–30 mg/dL	150–300 mg/L
Aldolase	S	2.5–10 IU/L	
Aldosterone, standing	S	7–30 ng/dL	0.19–0.83 nmol/L
Alpha-1- acid glycoprotein	S	50–120 mg/dL	0.5–1 g/L
Alpha-1-antitrypsin	S	90–200 mg/dL	0.9–2.0 g/L
Alkaline phosphatase (ALP)	S		40–125 IU/L
Alpha fetoprotein (AFP)	S	< 15 ng/mL	< 15 µg/L
Amino acids, Total	P/S	30–50 mg/dL	
Amylase	S	80–180 S U/dL	28–100 IU/L
	U		0–375 IU/L
Angiotensin converting enzyme	S		10–50 IU/L
Angiotensin-I	P	1.8–8 ng/dL	
Angiotensin-II	P	1–6 ng/dL	
Antidiuretic hormone (ADH) (arginine vasopressin)	P	1–13 pg/mL	

Analyte	Sample	Units	SI units
Ascorbic acid (vitamin C)	P	0.4–1.5 mg/dL	23–85 µmol/L
Aspartate amino transferase (AST/SGOT)	S	< 35.0 IU/L	
Bicarbonate (HCO <sub>3</sub> <sup>-</sup> )	S	22–26 mEq/L	22–26 mmol/L
Bilirubin, total	S	0.2–1 mg/dL	4–17 µmol/L
do, unconjugated, free, indirect		0.2–0.7 mg/dL	
do, conjugated, direct	S	0.1–0.4 mg/dL	
Calcium	S	9–11 mg/dL	2.1–2.5 mmol/L
Calcitonin	S	< 9.0 pg/mL	< 9.0 ng/L
Calcitriol (1,25-dihydroxy vitamin D)	S	1.5–6 µg/dL	40–150 pmol/L
Ceruloplasmin	S	20–60 mg/dL	
Chloride	S/P	96–106 mEq/L	96–106 mmol/L
Chloride	CSF	120–130 mEq/L	120–130 mmol/L
	U	110–250 mEq/L	110–250 mmol/L
Cholesterol, Total	S/P	150–200 mg/dL	4–6 mmol/L
(HDL fraction)	S	30–60 mg/dL	0.75–1.58 mmol/L
Male:			
Female:		35–75 mg/dL	0.98–1.95 mmol/L
(LDL fraction)	20–29 yr	60–150 mg/dL	
	30–39 yr	80–175 mg/dL	
	40–60 yr	90–200 mg/dL	
Cholinesterase	B		40–80 U/L
Chorionic gonadotropin, (beta-hCG) (non-pregnant)	S	< 5.0 mU/mL	< 5.0 U/L
Complement C <sub>3</sub>		90–180 mg/dL	
Complement C <sub>4</sub>		10–40 mg/dL	

Analyte	Sample	Units	SI units
Complement-1-esterase		5-10 mg/dL	
Complement-1-esterase inhibitor	S	10-25 mg/dL	
Copper	P	70-140 µg/dL	11-22 µmol/L
Cortisol 8 AM	P	0.6-1.6 µg/dL	17-44 nmol/L
4 PM	P	0.2-0.9 µg/dL	6-25 nmol/L
C-Reactive Protein (CRP)		< 0.5 mg/dL	
Creatine	S	0.2-0.4 mg/dL	15-30 µmol/L
Creatine kinase (CK)			
Female:	S		10-80 U/L
Male:	S		15-100 U/L
Creatinine	S	0.7-1.4 mg/dL	60-125 µmol/L
	U	15-25 mg/kg/d	0.15-0.2 mmol/kg/d
Cyanocobalamin (vitamin B <sub>12</sub> )	S	20-70 ng/dL	150-500 pmol/L
Electrophoresis	S	Alb: 55-65%	3.5-4.7g/100 mL
		α <sub>1</sub> : 2-4%	0.2-0.3 g/dL
		α <sub>2</sub> : 6-12%	0.4-0.9 g/dL
		Beta: 8-12%	0.5-1.0 g/dL
		gamma: 12-22%	0.7-1.5 g/dL
Epinephrine	P	< 90.0 pg/mL	< 500 pmol/L
	U	0.5-20 µg/day	5-100 nmol/day
Estradiol Female (Midcycle)	S	10-50 ng/dL	0.3-2 nmol/L
Male:		< 5 ng/dL	<180 pmol/L
Ferritin Male:	S	2-25 µg/dL	20-250 µg/L
Female:		1-12 µg/dL	10-120 µg/dL
Fibrinogen	P	200-400 mg/dL	5.8-8.5 µmol/L
Folic acid	S	2.5-12.0 ng/mL	6-28 nmol/L
FSH Male:	S		1.4-15.4 IU/L
Female (midcycle)	S		0.2-20 IU/L
Gamma glutamyl transpeptidase (GGT)	S		< 55.0 IU/L
Globulins	S	2.5-3.5 g/dL	25-35 g/L
Glucagon	S	7-18 ng/dL	
Glucose (Fasting)	P	70-110 mg/dL	4.0-6.1 mmol/L
	CSF	50-70 mg/dL	2.8-4.2 mmol/L
Glucose-6-phosphate dehydrogenase (GPD)	E		8-16 U/g Hb
Glutamic acid	S	0.2-3 mg/dL	
Glutathione	E	20-40 mg/dL	2 mmol/L
Growth hormone (GH)	S		2-5 µg/L
Haptoglobin	S	30-200 mg/dL	300-2000 mg/L
Hemoglobin Male:	B	14-16 g/dL	2.17-2.4 mmol/L
Female:	B	13-15 g/dL	

Analyte	Sample	Units	SI units
Hemoglobin A <sub>2</sub>	E	2-3% of total	
Hb A <sub>1c</sub> (glycohemoglobin)	S	< 5.5 % of total	
Hemopexin	S	50-100 mg/dL	
17-hydroxy corticosteroids,			
Female:	U	2-8 mg/d	5.5-22 µmol/d
Male:	U	3-10 mg/d	8-28 µmol/d
5-hydroxy indole acetic acid (HIAA)	U	5.2-13.4 mg/d	10-47 µmol/d
Immunoglobulins	S		
IgG		700-1600 mg/dL	
IgM		40-230 mg/dL	
IgA		70-400 mg/dL	
IgD		0-8 mg/dL	
IgE		0-3.8 µg/dL	
Immunoglobulins	CSF	4-5 mg/dL	
Insulin	S	2-25 µU/mL	12-150 pmol/L
Iodine	S	5-10 µg/dL	
Iron	B	5 mg/dL	
Iron	S	100-150 µg/dL	20-30 µmol/L
Iron binding capacity	S	250-400 µg/dL	44-70 µmol/L
17-ketogenic steroids			
Female:	U	3-15 mg/d	10-15 µmol/d
Male:	U	5-23 mg/d	17-80 µmol/d
17-ketosteroids	U		
Up to 1 year		< 1 mg/d	
1-4 years		< 2 mg/d	
5-8 years		< 3 mg/d	
8-12 years		3-10 mg/d	
13-16 years		5-12 mg/d	
Male, adult		8-20 mg/d	
Female, adult		6-15 mg/d	
Lactic acid	P	5-12 mg/dL	0.5-1.2 mmol/L
Lactate dehydrogenase (LDH)	S		180-360 U/L
LH Male	S		1.5-8 IU/L
Female (midcycle)	S		20-60 IU/L
Lipase	S		< 40 U/L
Lipoproteins Alpha	S	40 mg/dL	
Beta		180 mg/dL	
Magnesium	S	1.6-2.6 mg/dL	0.45-0.6.0 mmol/L
Nonesterified fatty acids (NEFA) (FFA)	P	10-20 mg/dL	0.3-0.7 mEq/L
Norepinephrine	P	70-700 pg/mL	1-4 nmol/L
	U	15-80 µg /day	100-500 nmol/day
Nucleotide phosphatase (NTP) (5'-Nucleotidase)	S		2-10 IU/L

Analyte	Sample	Units	SI units
Osmolarity	S	280–296 mosmol/kg	280–296 mmol/kg
Parathyroid hormone (PTH)	S		10–65 ng/L
pCO <sub>2</sub> , arterial	B	35–45 mm Hg	
pH	B	7.35–7.45	[H <sup>+</sup> ] = 35–45 nmol/L
Phenylalanine	S	0.8–1.8 mg/dL	0.05–0.1 mmol/L
Phosphate	S	2.5–4.5 mg/dL	1–1.5 mmol/L
	U	0.5–1.5 g/day	13–42 mmol/day
	B	40 mg/dL	
Phospholipids		150–200 mg/dL	2–2.5 mmol/L
Placental lactogen (HPL)–pregnant	S	0.5–10 mg/L	20–500 nmol/L
Plasminogen	S	10–30 mg/dL	
pO <sub>2</sub> arterial	B	90–100 mm Hg	150–220 mL/L
Potassium	S	3.5–5 mEq/L	3.5–5 mmol/L
Pre-albumin (Transthyretin) (TBPA)	S	25–30 mg/dL	
Progesterone Male	S	13–97 ng/dL	0.4–3.1 nmol/L
Female (after midcycle)	S	0.6–3 µg/dL	19–95 nmol/L
Prolactin Male	S		< 10 µg/L
Female Normal	S		3.6–12 µg/L
Pregnancy	S		95–475 µg/L
Prostaglandin E	P	2.5–20 ng/dL	70–550 pmol/L
Prostate specific antigen (PSA) Male	S	100–500 ng/dL	0–5 µg/L
Proteins—total	S	6–8 g/dL	60–80 g/L
	CSF	10–30 mg/dL	
Prothrombin	P	10–15 mg/dL	
Pseudocholinesterase		8–18 IU/mL	
Renin (normal salt intake, upright position)	P	0.5–1 ng/L/sec	
Retinol binding protein		3–6 mg/dL	
Secretin	S	3–4.5 ng/dL	
Selenium	S	63–160 µg/L	0.8–2.0 µmol/L

Analyte	Sample	Units	SI units
Serotonin	B	5–20 mg/dL	0.2–2 µmol/L
Sodium	S	136–145 mEq/L	136–145 mmol/L
Sulfate	S	0.5–1.5 mEq/L	
T3 (Tri iodothyronine)	S	120–190 ng/dL	1.8–3 nmol/L
rT <sub>3</sub> (reverse T <sub>3</sub> )	S	10–25 ng/dL	0.15–0.4 nmol/L
T <sub>4</sub> (thyroxine)	S	5–12 µg/dL	65–150 nmol/L
Testosterone, Free			
male, morning	S	50–210 pg/mL	174–729 pmol/L
female, morning	S	1.0–8.5 pg/mL	3.5–29.5 pmol/L
Testosterone, Total			
male, morning	S	260–1000 pg/mL	9–35 pmol/L
female, morning	S	15–70 pg/mL	0.5–2.5 pmol/L
Thyroglobulin (Tg)	S	3–42 ng/mL	3–42 µg/L
TRH	S		5–60 ng/L
TSH	S	0.5–5 µU/mL	0.5–5 mU/L
Thyroxine binding globulin		1–2 mg/dL	
Transcortin	S	3–3.5 mg/dL	
Transferrin	S	200–360 mg/dL	2.0–3.6 g/L
Transketolase	B	0.75–1.3 U/ gm Hb	
Transthyretin	S	20–40 mg/dL	
Triglycerides, fasting, Male:	S	50–150 mg/dL	0.5–1.6 mmol/L
Female:		40–150 mg/dL	0.4–1.6 mmol/L
Troponin I	S		1–10 µg/L
Urea	S	20–40 mg/dL	2.4–4.8 mmol/L
Urea Nitrogen	S/P	6–20 mg/dL	2.1–7.1 mmol/L
Uric acid Male	S/P	3.5–7 mg/dL	0.21–0.4 mmol/L
Female	S/P	3.0–6 mg/dL	0.18–0.35 mmol/L
Children	S/P	2.0–5.5 mg/mL	0.12–0.32 mmol/L
Vanillyl mandelic acid (VMA)	U	2–6 mg/d	7–32 µmol/d
Vitamin A	S	30–80 µg/dL	1.0–2.8 µmol/L
Vitamin E	S	0.5–1.8 mg/dL	12–42 µmol/L
Zinc	S	80–120 µg/dL	12–18 µmol/L

# Appendix III

## Conversion Chart

<i>Units of Length</i>	
1 megameter	(M) = $10^6$
1 kilometer	(km) = $10^3$
1 meter	(m) = 1
1 centimeter	(cm) = $10^{-2}$ m
1 millimeter	(mm) = $10^{-3}$ m
1 micrometer	( $\mu$ m) = $10^{-6}$ m
1 nanometer	(nm) = $10^{-9}$ m
1 angstrom	( $\text{\AA}$ ) = $10^{-10}$ m
1 picometer	(pm) = $10^{-12}$ m
1 femtometer	(fm) = $10^{-15}$ m

<i>Units of Mass</i>	
1 Megagram	(Mg) = $10^6$ g
1 kilogram	(kg) = $10^3$ g
1 gram	(g) = 1
1 centigram	(cg) = $10^{-2}$ g
1 milligram	(mg) = $10^{-3}$ g
1 microgram	( $\mu$ g) = $10^{-6}$ g
1 nanogram	(ng) = $10^{-9}$ g
1 picogram	(pg) = $10^{-12}$ g
1 femtogram	(fg) = $10^{-15}$ g

# Appendix IV

## Greek Alphabet (Commonly used letters as symbols)

<i>Letters</i>	<i>Capital</i>	<i>Small</i>
Alpha	A	$\alpha$
Beta	B	$\beta$
Gamma	$\Gamma$	$\gamma$
Delta	$\Delta$	$\delta$
Epsilon	E	$\epsilon$
Zeta	Z	$\zeta$
Eta	H	$\eta$
Theta	$\Theta$	$\theta$
Kappa	K	$\kappa$
Lambda	$\Lambda$	$\lambda$
Mu	M	$\mu$
Xi	$\Xi$	$\xi$
Pi	$\Pi$	$\pi$
Rho	P	$\rho$
Sigma	$\Sigma$	$\sigma$
Phi	$\Phi$	$\phi$
Chi	X	$\chi$
Psi	$\Psi$	$\psi$
Omega	$\Omega$	$\omega$



# Appendix V

## Recommended Daily Allowance (RDA) of Essential Nutrients

	Nutrient	Requirement per day
<b>1.</b>	<b>Proteins</b>	
	Adult	
	Males	- 0.8 g/kg
	Females	- 0.8 g/kg
	Children	
	Infants	- 2.4 g/kg
	Up to 10 years	- 1.75 g/kg
	Boys	- 1.6 g/kg
	Girls	- 1.4 g/kg
	Pregnancy and lactation	
	Pregnancy	- 2 g/kg
	Lactation	- 2.5 g/kg
<b>2.</b>	<b>Essential amino acids</b>	
	Phenylalanine	- 14 mg/kg
	Leucine	- 11 mg/kg
	Lysine	- 9 mg/kg
	Valine	- 14 mg/kg
	Isoleucine	- 10 mg/kg
	Threonine	- 6 mg/kg
	Methionine	- 14 mg/kg
	Tryptophan	- 3 mg/kg
<b>3.</b>	<b>Fat soluble vitamins</b>	
	Vitamin A	
	Adult	- 750 µg
	Children	- 400–600 µg
	Pregnancy	- 1000 µg
	Lactation	- 1200 µg
	Vitamin D	
	Adult	- 5 µg

	Nutrient	Requirement per day
	Children (preschool)	- 10 µg
	Pregnancy and lactation	- 1200 µg
	Vitamin E	
	Adult males	- 10 mg
	Females	- 8 mg
	Old age	- 10 mg
	Pregnancy	- 11 mg
	Vitamin K	
	Adult	- 50–100 µg
	Children	- 1 µg/kg
<b>4.</b>	<b>Water soluble vitamins</b>	
	Thiamine (B <sub>1</sub> )	
	Adult	- 1–1.5 mg
	Riboflavin (B <sub>2</sub> )	
	Adult	- 1.5 mg
	Pregnancy and lactation	- 1.7–2 mg
	Niacin	
	Adult	- 20 mg
	Pregnancy	- 22 mg
	Lactation	- 25 mg
	Pyridoxine (B <sub>6</sub> )	
	Adult	- 2 mg
	Pregnancy	- 2.5 mg
	Pantothenic acid	- 10 mg
	Biotin	- 200–300 µg
	Folic acid	
	Adult	- 100 µg
	Pregnancy	- 300 µg
	Lactation	- 150 µg

	<i>Nutrient</i>	<i>Requirement per day</i>
	B <sub>12</sub>	
	Adult	- 1 µg
	Pregnancy and lactation	- 1.5 µg
	Ascorbic acid	
	Adult	- 70 mg
	Pregnancy and lactation	- 100 mg
<b>5.</b>	<b>Minerals</b>	
	Calcium	
	Adult	- 0.5 g
	Children	- 1 g
	Pregnancy and lactation	- 1.5 g
	Phosphorus	- 500 mg

	<i>Nutrient</i>	<i>Requirement per day</i>
	Magnesium	- 400 mg
	Manganese	- 5–6 mg
	Sodium	- 5–10 g
	Potassium	- 3–4 g
	Iron	
	Males	- 15–20 mg
	Females	- 20–25 mg
	Pregnancy	- 40–50 mg
	Copper Adult	- 1.5–3 mg
	Iodine Adult	- 150–200 µg
	Zinc Adult	- 8–10 mg
	Selenium Adult	- 50–100 µg

# Appendix VI

## Composition of Nutrients in Selected Common Food Materials

	<i>Food materials</i>	<i>Protein g/100 g</i>	<i>Fat g/100 g</i>	<i>Carbo-hydrate g/100 g</i>	<i>Energy kcal/ 100 g</i>	<i>Calcium mg/100g</i>	<i>Iron mg/100g</i>	<i>Vitamin A IU/100g</i>	<i>Vitamin B<sub>1</sub> µg/100g</i>
<b>I.</b>	<b>Cereals:</b>								
1.	Wheat flour, whole	12.1	1.7	72.2	358	35	7.3	–	70
2.	Rice, raw, milled	6.9	0.4	79.2	348	10	1.0	–	50
3.	Rice, parboiled	6.4	0.4	79.1	346	10	2.2	–	210
4.	Bajra	11.6	5.0	67.1	360	50	8.8	220	330
5.	Barley	11.5	1.3	69.3	355	30	3.7	–	450
6.	Sorghum, Juar, Cholam	10.4	1.9	74.0	335	30	6.2	136	345
<b>II.</b>	<b>Legumes and Pulses:</b>								
1.	Bengal gram, (Channa)	17.1	5.3	61.2	361	190	9.8	316	300
2.	Black gram (Urad dal)	24.0	1.4	60.3	350	200	9.8	64	420
3.	Green gram (Mung)	24.0	1.3	54.6	334	140	8.4	158	465
4.	Horse gram (Kulthi)	22.0	0.5	57.3	322	280	7.6	119	420
5.	Peas (Mattar) dried	19.7	1.1	56.6	315	70	4.4	–	450
6.	Red gram (dal) (arhar)	22.3	1.7	57.2	333	140	8.8	220	450
7.	Soybean	43.2	19.5	20.9	432	240	11.5	710	730
<b>III.</b>	<b>Vegetables, A group, (low calorie)</b>								
1.	Amaranth (lal cholai)	4.9	0.5	5.7	47	500	21.4	8,000	50
2.	Cabbage	1.8	0.1	6.3	33	30	0.8	2,000	60
3.	Tomato, ripe	1.0	0.1	3.9	21	10	–	320	120
4.	Ashgourd (Peetha)	0.4	0.1	3.2	15	30	0.5	–	60
5.	Bittergourd (Karela)	1.6	0.2	4.8	25	20	2.2	210	70
6.	Brinjal	1.3	0.3	6.4	34	20	1.3	5	45
7.	Broad beans (Sem)	4.5	0.1	10.0	59	50	1.6	–	80
8.	Cauliflower	3.5	0.4	5.3	39	30	1.3	40	100
9.	Cucumber	0.4	0.1	2.8	14	10	1.5	–	30
10.	Drumstick leaves	6.7	1.7	10.9	96	440	7.0	11,000	60
11.	Drumstick	0.5	0.1	4.0	26	30	5.3	180	60
12.	Radish (Muli)	0.6	0.3	6.2	21	50	–	6	60

13.	Watermelon	0.1	0.2	3.8	17	–	–	–	20
<b>IV. Vegetables, B group, (Medium calory)</b>									
1.	Carrot	0.9	0.2	10.7	47	80	1.5	4,000	40
2.	Onion, big (sabola)	1.2	–	11.6	51	180	0.7	25	80
3.	Ladies finger (Bhindi)	2.2	0.2	7.7	41	90	1.5	60	60
4.	Peas with pods	7.2	0.1	19.8	109	20	1.5	135	250
5.	Gram leaves	8.2	0.5	27.2	146	310	28.3	6,700	10
6.	Pumpkin, ripe	1.4	0.1	10.3	48	10	0.7	84	60
<b>V. Vegetables, C group (Roots and Tubers)</b>									
1.	Beet root	1.7	0.1	13.6	62	200	1.0	–	40
2.	Colocasia (Arwi)	3.0	0.1	22.1	101	40	2.1	40	90
3.	Potato (Aloo)	1.6	0.1	22.9	99	–	0.7	40	100
4.	Sweet potato	1.2	0.3	31.0	132	20	0.8	10	80
5.	Tapioca (cassava)	0.7	0.2	38.7	159	50	0.9	–	45
6.	Yam (Ratalu)	1.4	0.1	27.0	115	60	1.3	–	72
<b>VI. Fruits</b>									
1.	Apple	0.3	0.1	13.4	56	–	1.7	–	120
2.	Banana, ripe	1.3	0.2	36.4	153	10	–	–	150
3.	Dates	3.0	0.2	67.3	280	70	10.6	600	90
4.	Grapes, ripe	0.8	0.1	10.2	45	30	–	15	40
5.	Mango, ripe	0.6	0.1	11.8	50	10	–	4,800	40
6.	Orange	0.9	0.3	10.6	50	10	–	350	120
7.	Papaya, ripe	0.5	0.1	9.5	40	10	–	3,000	40
8.	Pineapple	0.6	0.1	12.0	50	20	0.9	60	–
<b>VII. Milk and Milk Products</b>									
1.	Cow's milk	3.3	3.8	4.4	69	100	–	160	50
2.	Buffalo's milk	4.3	8.8	5.3	117	210	–	160	40
3.	Goat's milk	3.7	5.6	4.7	84	170	–	180	–
4.	Human milk	1.0	3.8	7.5	71	34	–	200	–
5.	Curd (Yogurt) (dahi)	2.9	2.9	3.3	51	120	–	130	–
6.	Cheese (Paneer)	24.1	25.1	6.3	548	790	2.1	275	–
<b>VIII. Meat and Other Products</b>									
1.	Mutton, muscle	18.5	11.3	0.5	194	150	2.5	30	180
2.	Beef muscle	22.6	2.6	0.5	114	10	0.8	60	150
3.	Pork, muscle	18.7	4.4	0.5	114	30	2.3	–	540
4.	Sheep liver	19.3	7.5	1.4	150	10	6.3	22,000	360
5.	Fish	22.6	0.6	0.2	91	20	0.9	20	100
6.	Egg, Hen	13.3	13.3	0.2	173	60	2.1	1,200	130
<b>IX. Miscellaneous Items</b>									
1.	Cashewnut	21.2	46.9	22.3	596	50	5.0	100	600
2.	Coconut	4.5	41.6	13.0	444	10	1.7	–	45
3.	Groundnut	26.7	40.1	20.3	549	50	1.6	60	900
4.	Jaggery	0.4	0.1	95.0	383	80	11.4	–	20



# Appendix VII

## Table Showing Surface Area for Different Heights and Weights

<i>Height in cm</i>	<i>Weight in kg</i>	<i>Surface area in square meters</i>
75	15	0.52
80	20	0.62
85	25	0.70
90	30	0.80
95	32	0.85
100	34	0.90
105	35	0.95
110	37	1.00
115	39	1.05
120	40	1.10
125	41	1.15
130	42	1.20
135	44	1.25
140	45	1.30
145	40	1.25
	45	1.32
	50	1.38
	55	1.45
150	40	1.30
	45	1.35

<i>Height in cm</i>	<i>Weight in kg</i>	<i>Surface area in square meters</i>
	50	1.42
	55	1.47
155	45	1.40
	50	1.46
	55	1.52
	60	1.57
160	50	1.50
	55	1.55
	60	1.60
	65	1.65
	70	1.72
165	60	1.65
	65	1.70
	70	1.75
	75	1.81
	80	1.88
170	72	1.85
175	75	1.90
178	78	1.95
180	80	2.00

# Appendix VIII

## Ideal Body Weight and Height of Different Age Groups

(Adapted from the Indian Council of Medical Research)

Age	Males		Females	
	Height in cm	Weight in kg	Height in cm	Weight in kg
1	75	10.0	74	9.5
2	85	11.0	85	10.0
3	95	13.5	93	13.0
4	100	15.0	98	14.0
5	105	16.5	102	15.5
10	139	32.0	139	33.5
12	149	39.0	150	42.5
15	165	48	155	45.0
20	168	59	158	50.0
30	168	62	158	55.0
40	168	65	158	55.0
50	168	65	158	55.0



Page numbers followed by *f* refer to figure and *t* refer to table

## A

- Abdominal pain 310
- Abetalipoproteinemia 341, 342
- Abnormal
- constituents of urine 364
  - G-protein signaling 653
  - GTT curve 315
  - metabolism of copper 521
  - PRPP synthetase 567
- Abnormalities in
- absorption of lipids 150
  - coagulation 386
  - collagen 722
- Abnormalities of
- gonadotropin 662*t*
  - thyroid function 675
- Absorption of
- amino acids 198
  - carbohydrates 106
  - folic acid 488
  - glucose 106
  - iron 357, 514, 516*f*
  - lipids 148
  - long chain fatty acids 148
  - vitamin
    - A 464
    - B<sub>12</sub> 492, 492*f*
- Acanthocytes 341
- Acceptance of hydrogen 479*f*, 481*f*
- Acesulfame potassium 81
- Acetaldehyde dehydrogenase 141
- Acetate buffer 392
- Acetazolamide 363, 401
- Acetic acid 85, 547
- Acetoacetyl CoA 239
- Acetone 165, 326
- Acetyl
- CoA carboxylase 159, 320, 321, 486
  - serotonin 216
- Acetylation 548
- Acetylcholine 214, 495
- esterase 49, 61, 307, 553
  - receptor 18*f*, 19
  - synthesis 495
- Acid
- base
    - abnormalities 405*t*
    - balance 393
    - catalysis 51
    - disturbances 398, 399
    - parameters 398
    - peptic disease 190
    - phosphatase 306, 308
- Acidic amino acids 27, 198, 223
- Acidification of urine 395
- Acidity of solution and pH 391
- Acidophils 660
- Acidosis 103, 395, 397, 398, 507
- Acquired
- hyperammonemia 206
  - hyperbilirubinemias 280
  - hyperhomocysteinemias 221
  - immunodeficiency syndrome 699, 704
  - porphyrias 276
- Acrodermatitis enteropathica 522
- ACTH stimulation 668
- Action of
- allosteric enzymes 62*f*
  - aspirin 189
  - calmodulin 504*f*
  - chemical carcinogens 707
  - chymotrypsin 52
  - epinephrine 235
  - hemoglobin 395
  - insulin on enzyme 321
  - medicines in gout 568*t*
  - phospholipases 90
  - proteases 198*f*
  - proteolytic enzymes 198*t*
  - reverse transcriptase 593*f*
  - steroid hormones 656*f*
  - vitamin
    - A 467*f*
    - D 472
- Activation of
- amino acid 600
  - enzymes 218, 320, 503
  - fatty acids 151
  - glucose 125
  - vitamin D 470
- Active
- adrenocorticotrophic hormone 661
  - center of
    - enzyme 54
    - lysozyme 52*f*
- Activity of chromatin 578
- Acute
- abdominal pain 275
  - glomerulonephritis 370
  - hepatitis 305
  - hepatocellular injury 354
  - illness 533
  - inflammation 436
  - intermittent porphyria 274
  - kidney injury 369



- liver failure 353
- lymphatic leukemia 309
- manifestation 554
- metabolic complications 326
- nephritis syndrome 374
- pancreatitis 197, 307-309, 358, 508
- phase proteins 383
- poisoning 402
- radiation syndrome 738
- respiratory acidosis 404
- Acyclovir 61
- Addison's disease 404, 412, 415, 417, 508, 668
- Addisonian pernicious anemia 493
- Adenine nucleotide translocase 268
- Adenosine 561
  - deaminase deficiency 568
  - phosphosulfate 258
  - triphosphate 50, 258, 344, 562*f*
- Adenosyl cobalamin 492
- Adenoviruses 630
- Adenylcyclase 504, 506
- Adipokines 161
- Adiponectin 162, 537
- Adipose tissue 88, 100, 101, 107, 132, 176
  - and diabetes mellitus 161
  - and obesity 161
  - derived hormones 161
  - in fasting condition 161
- Adrenal
  - adenoma 668
  - carcinoma 668
  - cortex 132
  - cortical hormones 664
  - gland 353, 545
  - hypofunction 668
  - insufficiency 412
- Adrenaline 322
- Adrenocorticotrophic hormone 322, 661
- Adrenodoxin reductase 545
- Adrenogenital syndrome 415, 668
- Adrenoleukodystrophy 13, 185
- Adsorption chromatography 448, 449*f*
- Advantages of
  - monoclonal antibody 641
  - multi-enzyme complex 156
- Aerobic dehydrogenases 257
- Aflatoxins 706
- Agarose 80
- Age-related macular degeneration 474
- AIDS disease 700, 700*f*
- ALA
  - dehydratase deficiency 275
  - synthase deficiency 275
  - synthesis 271
- Alanine 26, 120, 214, 215, 239, 450, 451
  - amino transferase 305, 308, 348
  - transaminase 141
- Albumin 277, 380, 352, 408
  - globulin ratio 382
- Alcian blue staining 429
- Alcohol
  - abuse 354
  - and cardiovascular system 141
  - dehydrogenase 48, 140, 466, 546
  - metabolism 140*f*
- Alcoholic
  - cirrhosis 141, 351
  - hepatitis 353-355
  - liver disease 353
- Aldehyde
  - dehydrogenase 140, 546
  - tests for tryptophan 31
- Aldonic acid 74
- Aldosterone 409
  - in blood 668
  - secretion 397
- Alimentary glucosuria 316, 317
- Aliphatic
  - amino acids 24
  - carboxylic acids 84
- Alkaline phosphatase 59, 305, 308, 348, 350, 353, 360, 472, 505, 509
- Alkaloids 555
- Alkalosis 393, 397, 398, 415, 507
- Alkapton bodies 238
- Alkaptonuria 237, 318, 429, 431
- Allergy 483
- Allopurinol 61, 62, 571
- Allosteric
  - inhibition 63*f*
  - regulation 62, 63
- Alpha
  - amino
    - acids 24
    - group 226
  - fetoprotein 352, 354, 359, 423, 425, 713
  - helix 37
  - ketoglutaric acid 118*f*, 201
  - ketoglutarate dehydrogenase 250*f*, 253, 254, 257, 478
  - methenyl bridge 277
  - methyl dopa 235
  - oxidation 155
  - secretases 729
  - thalassemias 294
  - tocopherol 473*f*
- Aluminum toxicity 552
- Alzheimer's disease 175, 225, 522, 606, 728, 729, 745
- Amanita phalloides 589
- Amantadine 621
- Ame's test 614
- Amide formation 30
- Amino acid 24, 27, 99, 208, 220, 245, 355, 482, 509, 661
  - derivatives of importance 30
  - metabolism 347
  - oxidation 479
  - pool 201*f*
  - profile in HPLC 451*f*
  - sequence
    - number 284
    - of globin 284*t*
  - substitution 290
  - transport 217
  - with amide groups 25*f*
- Amino
  - aciduria 139, 220, 230*t*, 232, 242, 400
  - isobutyric acid 571
  - sugars 75, 75*f*
  - transferases 201, 353
- Aminoacidurias 245
- Aminoacyl
  - adenylate 258
  - tRNA synthetases 600

- Aminoguanidine 330  
 Aminolevulinic acid 281  
 Aminopterin 491  
 Aminopyrine 135  
     excretion test 350  
 Ammonia 200, 201, 223, 355  
     trapping glutamine 202*f*, 204*f*  
 Amniocentesis 140  
 Amniotic fluid 422  
 Ampicillin 412  
     resistance gene 527  
 Amylase 307, 359  
 Amyloid precursor protein 728,  
     729, 745  
 Amyloidosis 690  
 Amylopectin 78  
 Anabolic steroids 412  
 Anaerobic  
     dehydrogenases 257  
     exercise 102  
     glycolysis 536  
 Analogs purine  
     synthesis inhibitors 565  
 Anaphylaxis 244  
 Anaplerotic role of TCA cycle 253  
 Andersen's disease 144  
 Androgen binding protein 670  
 Anemia 295, 295*f*, 483, 498  
 Angina pectoris 228  
 Angioneurotic edema 692  
 Angiotensin  
     converting enzyme 409  
     production 409  
 Angles of rotation in peptide bond 34*f*  
 Angular stomatitis 480  
 Animal  
     cloning 635  
     steroid 169  
 Anion gap 399  
 Anomeric carbon atoms 72  
 Anomers of D-glucose 71*f*  
 Anserine 215  
 Antagonists of nitric oxide 228  
 Antibody dependent cell  
     mediated cytolysis 687  
 Anticancer drug 564, 716  
 Anticoagulants 388, 441  
 Anticodon arm of tRNA 597  
 Anticonvulsant therapy 508  
 Antidiuretic hormone 409, 411, 659  
 Antigens 143, 686  
 Antiglomerular basement  
     membrane antibody 375  
 Anti-HIV drugs 703  
 Anti-insulin hormones 323  
 Antimalarial drugs 133  
 Antimicrobial techniques 645  
 Antineutrophil cytoplasmic  
     antibody 375  
 Antioncogenes 710  
 Antioxidants 438  
 Antiphospholipid syndrome 388  
 Antiport system 362  
 Anti-retroviral therapy 704  
 Antisense therapy 595  
 Antithrombin deficiency 387  
 Antithyroid drugs 673*f*  
 Anti-TNF therapy 696  
 APL antibody syndrome 92  
 Apoferritin 517  
 Apolipoprotein 173  
 Apoprotein 175, 337  
 Apoptosis 268, 616, 712  
 Appearance of albumin 361  
 Applications of  
     bioinformatics 644  
     cloning of  
         animals 636  
         plants 636  
     diuretics 363  
     glycolytic enzymes 117  
     isotopes in medicine 732  
     lysosomes 12  
     molecular cloning in medicine 636  
     monoclonal antibody 641  
     PCR 639  
     radioactivity  
         for diagnosis 736  
         in treatment 736  
     recombinant technology 624  
 Aquaporins 18  
 Aquasomes 90, 645  
 Arabinose 76  
 Arachidonic acid 186, 187, 187*f*, 190  
 Arcuate nucleus 660  
 Argemone mexicana 555  
 Argentaffin cells 241  
 Argentaffinomas 241  
 Arginase deficiency 206  
 Arginine 26, 29, 223, 226, 450, 451  
     phosphate 258  
 Argininemia 431  
 Argininosuccinate  
     lyase deficiency 206  
     synthetase 204  
 Argininosuccinic aciduria 206, 431  
 Aromatic  
     amino acids 24, 26*f*, 232  
     hydrocarbon hydroxylases 545  
 Arsenic toxicity 552  
 Arterial  
     blood gas  
         analyzer 404  
         values 405  
     oxygen saturation 404  
 Arthritis 567  
 Arthur Harden 107  
 Ascites 349  
     fluid analysis 423  
 Ascitic fluid 423  
 Ascorbic acid 317, 318, 488,  
     495, 499, 515  
 Asparaginase 225*f*  
 Asparagine 26, 81, 203, 223, 226  
     synthetase 225*f*  
 Aspartate  
     amino transferase 118*f*, 201,  
         226, 305, 308, 348  
     transcarbamoylase 63  
 Aspartic acid 26, 29, 120, 223,  
     226, 450, 451, 563  
*Aspergillus flavus* 555, 706  
 Aspirin 62, 189, 340, 546  
 Assessment of  
     acid-base parameters 404  
     adrenal androgen secretion 668  
     B<sub>12</sub> deficiency 494  
     deficiency 468  
     Folate deficiency 490  
     gastric function 357  
     glucocorticoid secretion 667

- hyperkalemia 416
  - hybernatiemia 414
  - hypokalemia 416
  - hyponatremia 414
  - pancreatic function 358
  - sodium 410
  - water balance 410
  - Asthma 404
  - Ataxia telangiectasia 584-586
  - Atherosclerosis 169, 330, 334, 342
    - infarction 436
  - Atomic
    - force microscope 644
    - number 733
    - weight 733
  - ATP synthase 264
  - Atrial natriuretic peptide 304, 409
  - Augmented histamine test 357
  - Autoimmune
    - disease 375
    - hemolysis 295
    - hemolytic anemias 280
    - hepatitis 353
  - Automated photometric analyzers 457
  - Automatic sequencing 40
  - Autosomal
    - dominant inheritance 609*f*
    - recessive inheritance 609*f*
  - Avidin 486
  - Azaserine 31, 61, 214, 564, 717
  - Azotemia 370
- B**
- Babinski's sign 494
  - Bacterial
    - and mammalian cells 5
    - cell wall 16, 82
    - DNA polymerases 580
    - infections 351, 422
    - meningitis 422
    - RNA polymerase 589
    - system 589
  - Bactericidal action of penicillin 16
  - Bacteriophages 626
  - Balanced polymorphism 611
  - Bantu siderosis 520
  - Barbiturates 135, 273
  - Barlow's disease 497
  - Bartter syndrome 20
  - Basal metabolic rate 528, 674
  - Basic amino acids 27, 198
  - Becker's muscular dystrophy 631
  - Beckwith-Weidmann syndrome 623
  - Beer-Lambert law 455
  - Bell shaped curve 58
  - Bence-Jones
    - proteins 372, 696
    - proteinuria 690
  - Benedict's
    - reaction 73
    - reagent 365
    - test 73*f*, 76*f*, 121, 135, 138, 238, 316, 365, 429, 496
  - Benign familial hypercalcemia 508
  - Benzene 26
  - Benzoic acid 213, 547
  - Benzoquinone acetate 238
  - Beriberi 478
  - Beta
    - alanine 215
    - amino acids 198
    - chain of chorionic gonadotropin 713
    - glycosidic linkage 77
    - oxalyl amino alanine 555
    - oxidation 153
      - of fatty acids 151
    - thalassemia 293
  - Bevacizumab 718
  - Bhopal gas tragedy 554
  - Bial's test 317
  - Bicarbonate
    - buffer system 392, 393
    - diagram 399*f*
  - Bile
    - acid 150, 212
      - binding resins 340
    - pigments 276, 349, 365
    - salts 147, 276, 349, 350, 364, 365
  - Biliary
    - cirrhosis 281
    - obstruction 306, 344
      - stricture 351
  - Bilirubin 277, 547
    - metabolism 347
    - toxicity 281
  - Biliverdin 277
  - Binding
    - of new amino acyl tRNA 601
    - proteins 675
  - Biochemical
    - analysis of CSF 422
    - effects of vitamin D 470
    - functions of
      - inositol 495
      - polyamines 229
      - vitamin A 467
      - vitamin C 496
    - role of vitamin
      - A 465
      - E 473
      - K 475
  - Biochemistry of
    - AIDS 699
    - cancer 705
    - HIV 699
  - Biogenic amines 230
  - Biomarkers for kidney diseases 369
  - Biomolecules 4
  - Biosynthesis of
    - ascorbic acid in animals 496
    - cholesterol 170
    - glycoproteins 143
    - heme 271
    - insulin 318
    - prostaglandins 189
    - purine nucleotides 563
  - Biotin 477, 486
    - avidin complex 454
    - CO<sub>2</sub> fixation reactions 486
    - independent carboxylation reactions 486
  - Birth defects 490
  - Bisphenols 553
  - Bisphosphoglycerate 110
    - kinase 256
  - Bitot's spots 467

- Biuret  
   method 44  
   reaction 31  
 Black liver jaundice 280  
 Blackening of urine 238  
 Bladder tumor antigen 715  
 Blood  
   ammonia 354  
   brain barrier 381  
   cells 632*f*  
   flow experiments 735  
   group substances 143  
   level 175, 366, 524  
   phenylalanine 237  
   transfusion 693  
   urea nitrogen 370  
   vessels 228  
 Bloom's syndrome 585, 586  
 Body  
   mass index 536  
   metabolism 66  
   water compartments 407  
 Bone 504  
   deformities 472  
     in rickets 472*f*  
   demineralization 509  
   diseases 308, 354, 511  
   marrow 353  
   mineral density 510  
   mineralization 509  
   osteoblasts 470  
   scanning 736  
 Bovine spongiform  
   encephalopathy 728  
 Brachytherapy 737  
 Brain 100, 101  
   and acetoacetate 100  
   natriuretic peptide 304  
   tumor 422  
 Branched  
   and circular proteins 35  
   chain  
     amino acids 24, 25*f*,  
       100, 103, 230  
     fatty acids 85  
     glycogen molecule 78*f*  
     organic acidurias 429  
 Branching enzyme 125  
 Breast milk jaundice 280  
 Brittle bones 722  
 Bromide intoxication 401  
 Bromsulphthalein excretion test 354  
 Bronchitis 404  
 Bronchodilator 190  
 Bronchopneumonia 403  
 Bronchopulmonary dysplasia 436  
 Bronze diabetes 520  
 Brown adipose tissue 162, 266  
 Buffer  
   capacity 392  
   of body fluids 393  
   systems of body 393*t*  
 Buffering against acid load 396  
 Burkitt's lymphoma 708  
 Burning foot syndrome 485  
 Butyric acid 85
- C**
- Cadaverine 230  
 Cadherins 740  
 Caenorhabditis elegans 629  
 Caesium 735  
 Caffeine 438, 566  
 Cahill cycle 120  
 Calbindin 470, 503*f*  
 Calcinosis 473  
 Calcitonin 470, 505-507, 509, 716  
 Calcitriol 470, 471, 503*f*, 505, 506  
   increases calcium  
     absorption 470*f*, 503*f*  
     receptor complex 470, 503*f*  
 Calcium 363, 539, 758  
   and muscle contraction 725  
   based signal transduction 654  
   channel blockers 20  
   disodium versenate 552  
   homeostasis 506*f*  
   in blood 505  
   in cells 503  
   load test 508  
   pump 20  
 Calmodulin 504*f*, 654, 726  
 Calnexin 144  
 Calomel electrode 457  
 Calorie requirement 538  
 Calpains 504  
 Calpastatin 505  
 Calreticulin 144  
 Calsequestrin 726  
 Cancer 490, 705  
   antigen 714  
   cachexia 114  
   cells 114, 586, 712  
   detection 639  
   of prostate 715  
   tissues 738  
 Capillary  
   blood 441  
   electrophoresis 448  
 Carbamoyl  
   aspartate 569  
   phosphate 258  
     synthesis 569  
 Carbohydrate 69, 241, 251,  
   478, 480, 530, 539, 667, 758  
   metabolism 347  
 Carbon  
   atoms 532  
   dioxide 563  
   metabolism 196  
   monoxide 277, 553  
     poisoning 289  
   monoxy Hb 289  
 Carbonic anhydrase 395,  
   395*f*, 396, 396*f*  
 Carboxyhemoglobin 289  
 Carboxyl proteases 52  
 Carboxylase 154  
 Carboxylation  
   of acetyl CoA 157  
   reactions 485  
 Carboxypeptidases 198  
 Carcinoembryonic antigen 359, 713  
 Carcinoid  
   syndrome 482  
   tumors 241, 357



- Carcinoma  
 head of pancreas 351  
 of pancreas 349
- Cardiac  
 biomarkers 301  
 diseases 417  
 failure 411  
 markers 337  
 muscle 101, 102, 632*f*  
 troponins 303, 308
- Cardiovascular  
 diseases 336, 178, 334, 521  
 system 243
- Carnitine 152  
 acyltransferase 102, 151  
 deficiency 152
- Carnosine 215, 216
- Carnosinuria 215
- Carpopedal spasm in tetany 509*f*
- Casal's necklace 481
- Cascade  
 pathway of coagulation 387*f*  
 system 691
- Caspase activation cascade 616
- Catabolic pathway of hemoglobin 277*f*
- Catabolism of  
 branched chain amino acids 230*t*  
 glycoproteins 145  
 heme 276  
 phenylalanine and tyrosine 233*f*  
 pyrimidines 572*f*  
 serine 214  
 serotonin 241  
 thyroid hormones 674  
 tyrosine 233
- Catalase 13, 258, 435
- Cataract 135, 328, 436, 727*f*
- Catechol-O-methyl transferase 236
- Cathepsins 199
- Causes of  
 acid-base disturbances 404  
 acquired porphyrias 276*t*  
 adrenal insufficiency 668  
 anemias 295  
 B<sub>12</sub> deficiency 493  
 cholestatic liver disease 351  
 fat deposition in liver 162  
 fatty liver 162  
 hepatocellular damage 351  
 hypercalcemia 508  
 hyperkalemia 416  
 hyponatremia 412  
 hyperphosphatemia 512  
 hypocalcemia 508  
 hypokalemia 415  
 hypomagnesemia 513  
 hyponatremia 412  
 hypophosphatemia 512  
 iron deficiency 518  
 jaundice 351  
 oxaluria 213*f*  
 renal tubular acidosis 401
- Celiac disease 150
- Cell  
 count 422  
 cycle 582, 583*f*, 614, 711  
 fusion 712  
 mediated immunity 686  
 membranes 169
- Cellular  
 buffers 397  
 immune deficiency 692  
 movements 726  
 repair 645  
 respiration 255  
 theories of aging 730
- Cellulose 79  
 acetate membrane 447  
 of plants 69
- Central  
 dogma of molecular  
 biology 588, 588*f*  
 nervous system 228, 429
- Cephalin 91, 91*f*
- Ceramide 91*f*, 92, 194*f*  
 oligosaccharides 92
- Cerebral beriberi 478
- Cerebrospinal fluid 421
- Ceruloplasmin 308, 352, 355, 384,  
 438, 516, 520
- Cetavlon test 429
- Cetuximab 718
- Chain  
 amino acids 223  
 breaking antioxidants 438  
 reaction 437
- Channel protein 19*f*
- Characteristics of  
 enzymes 48  
 peptide bond 34
- Charley Chaplin gait 221
- Cheilosis 480
- Chemical  
 bond energy 257  
 carcinogens 713*f*  
 characteristics of urine 364  
 score 534
- Chemiluminescent  
 immunoassay 454, 455
- Chemiosmotic theory 263
- Chemistry of  
 folic acid 488  
 lipids 83  
 niacin 480  
 vitamin  
 C 496  
 K 474
- Chemotroph 256
- Chloramphenicol resistance gene 627
- Chloride 416  
 channels 20, 224, 417  
 resistant 402
- Chlorodinitrobenzene 218
- Chlorpropamide 351
- Cholecystectomy 360
- Cholecystokinin 197, 358
- Cholelithiasis 351
- Cholera 653  
 toxin 193
- Cholestasis 354, 355  
 of pregnancy 360
- Cholesterol 172*f*, 531, 675  
 content of food items 532*t*  
 degradation 674  
 efflux regulator protein 180  
 ester transfer protein 180  
 pool in liver 173*f*  
 synthesis 171*f*

- Choline 90, 163, 207, 494  
synthesis 214
- Cholinesterase 307
- Chondroitin sulfate 80, 143
- Choriocarcinoma 714, 716
- Chorionic villus sampling 425
- Chovstek's signs 524
- Christmas disease 386
- Chromatin 576  
fibers 577
- Chromatography 448
- Chromium 523, 735
- Chromosomal disorders 611
- Chromosome 576, 577  
banding 577*f*  
location 144  
translocation 708, 713*f*
- Chronic  
active hepatitis 281, 355  
alcoholism 141  
blood loss 518, 519  
complications of  
diabetes mellitus 328  
diarrhea 512  
glomerulonephritis 436  
granulomatous disease 134, 434  
illness 533  
infections 375, 382  
inflammation 436  
iron deficiency anemia 357, 493  
kidney disease 369, 371, 517  
liver disease 355  
lung disorders 292  
lymphocytic leukemia 715  
pancreatitis 221, 351, 359  
pulmonary diseases 288  
pyelonephritis 370  
recurrent infections 326  
renal failure 412  
respiratory acidosis 404
- Chvostek's sign 508, 509
- Chylomicrons 149, 173, 175
- Chylothorax 150
- Chyluria 150
- Chymotrypsin 197
- Chymotrypsinogen 59
- Circulating leukocytes 353
- Cirrhosis 128, 163, 348,  
352, 354, 355, 360
- Cis and trans forms of fatty acid 85*f*
- Cistron 693
- Citrate 121, 253, 442  
synthase 63, 248, 253
- Citric acid cycle 205*f*, 247, 249*f*, 250
- Citrulline 206
- Citrullinemia 206, 431
- Class of jaundice 349
- Classical  
hemophilia 386  
oral glucose tolerance test 314
- Classification of  
acid-base disturbances 398  
amino acids 24  
anemias 518  
enzymes 48  
fatty acids 85*t*  
hypolipoproteinemias 342*t*  
jaundice 349*t*  
lipids 83, 84*t*  
liver function tests 348*t*  
mutations 612  
prostaglandins 188  
proteins 42  
renal function tests 361
- Clathrin-coated pits 21, 177
- Cleavage of aromatic ring 233
- Clindamycin 605
- Clomiphene citrate 669
- Cloning of  
animal 635  
chimeric DNA 627
- Clostridium*  
*histolyticum* 722  
*tetani* 653
- Cobalamin 491, 492*f*  
deficiency 221
- Cobalophilin 492*f*
- Cockayne syndrome 324, 585
- Cockcroft-Gault equation 368
- Co-enzyme  
activity of  
biotin 485  
pantothenic acid 484  
riboflavin 479
- forms of niacin 480  
functions of folic acid 488  
of fatty acid synthesis 159
- Colchicine 568
- Collagen helix 38
- Colloid osmotic pressure 380, 408
- Color blindness 466
- Colorectal cancers 713
- Colostrum 421
- Coma 166
- Combined  
immunodeficiency 692  
regulation of purine 571
- Combining stem cells and  
gene therapy 631
- Common  
amino acids 26*t*  
industrial pollutants 554*t*  
monosaccharides 70*t*  
pyrimidines 560*f*  
sugar substitutes 81  
therapeutic uses of  
monoclonal antibodies 641*t*
- Compare oxygen with superoxide  
anion 433*f*
- Comparison of  
blot transfer techniques 634*f*  
cell with factory 14  
sizes of lipoproteins 174*f*
- Compensated metabolic acidosis 402
- Complete  
blood count 524  
lipid profile 329  
oxidation of acetyl CoA 250  
group of vitamins 477
- Components of  
DNA replisome 579  
gallstones 360  
rRNA 598
- Composition of  
buffer 392  
cerebrospinal fluid in health  
and diseases 422*t*  
milk 420*t*  
nucleotides 559  
nutrients in common  
food materials 758

- Compound lipids 83
- Concentration  
of products 58  
of salt and acid 392  
test 373
- Concept of carcinogenesis 713*f*
- Cones for color vision 466
- Congenital  
cataract 139  
disorders of glycosylation 144  
erythropoietic porphyria 274, 275  
hyperbilirubinemias 279  
hypothyroidism 427, 676  
methemoglobinemia 289  
spherocytosis 280
- Congestive cardiac failure 363, 412
- Conjugated  
bilirubin 280, 350  
protein 270
- Conjugation  
of bilirubin 134  
of steroids 134  
with  
amino acids 548*f*  
glutamine 548  
glycine 548
- Conn's syndrome 668
- Conservation of iron in body 518*f*
- Constituents of gastric secretions 357
- Contractile proteins 723
- Copper 520  
deficiency 234  
anemia 521  
toxicity 521
- Cori's  
cycle 114, 114*f*, 120  
disease 144
- Corneal arcus 342
- Coronary artery disease 341, 490, 536
- Corrin ring 491
- Corticosteroid stressed GTT 316
- Cortisol  
binding globulin 665  
synthesis 665*f*
- Cosyntropin stimulation 662
- Co-translational glycosylation 603
- Covalent  
bond 5, 5*f*  
catalysis 52  
modification 64, 171, 214
- C-reactive protein 383
- Creatine  
kinase 302, 308  
reaction 302*f*  
metabolism 212*f*  
phosphate 211, 212*f*, 258, 259  
shuttle 267
- Creatinine 363  
clearance test 367
- Creb binding protein 657
- Creutzfeldt-Jakob disease 728
- CRH  
stimulation 668  
test 667
- Crigler-Najjar syndrome 279, 349, 611
- Creutzfeldt-Jakob disease 606
- Cryoglobulinemia 374
- Crystallins 727
- C-type natriuretic peptide 304
- Cumulative sum chart 444
- Cushing's  
disease 324, 412, 668, 670  
syndrome 333, 402,  
404, 415, 417, 668
- Cutanea tarda 274
- Cyanide 267  
nitroprusside test 220, 221, 429  
poisoning 550
- Cyanocobalamin 492, 499
- Cyanogenic glycosides 555
- Cyanopsin 466
- Cyanosis 289
- Cycle of events in muscle  
contraction 725*f*
- Cyclic  
amp mediated  
activation cascade 126*f*  
hydrocarbons 89
- Cycloheximide 605
- Cyclo-oxygenase 62, 189
- Cyclophilin 268
- Cyclophosphamide 717
- Cycloserine 31, 214, 484
- Cystathionase deficiency 221
- Cystathionine beta  
synthase deficiency 221
- Cystathioninuria 220, 221, 431
- Cysteine 26, 29, 210, 214, 217,  
450, 451, 548  
formation 217*f*  
proteases 52
- Cystic fibrosis 20, 417, 606, 631
- Cystine 30, 450  
crystals in urine 220*f*  
stone in bladder 220*f*
- Cystinuria 199, 219, 220, 431
- Cytidine 561
- Cytochrome 257  
A 262  
B 261  
C 261  
oxidase 262  
P-450 system 13, 545  
reductase 261
- Cytokines 536, 695
- Cytomegalovirus 375
- Cytoplasm 11, 151, 156
- Cytoplasmic  
inheritance 611  
sodium ions 19*f*
- Cytosine 560  
arabinoside 61
- Cytoskeleton 17, 726
- D**
- Dark adaptation time 466
- De novo synthesis 158, 563  
of fatty acids 156  
of pyrimidine 569
- Decarboxylation 29, 130, 217, 483, 569  
of amino acid 29*f*  
of cysteine 218*f*  
of serine 214*f*
- Deficiency  
disease 486, 499  
in weight for height 535  
manifestations of  
pyridoxine 483

- thiamine 478
- vitamin A 467
- vitamin C 497
- vitamin E 474
- Deficiency of
  - biotin 486
  - enzymes of salvage pathway 567
  - fructokinase 317
  - galactose-1-phosphate uridyl transferase 317
  - glycolytic enzymes 117
  - HBA 294
  - insulin 165
  - magnesium 508
  - pantothenic acid 485
  - vitamin
    - D 471, 508
    - K 475
- Deficient enzyme 129, 143, 154
- Degradation of
  - adrenaline 236
  - collagen 722
  - cysteine 217
  - glycogen 124
  - insulin 319
  - proline 244*f*
  - purine nucleotides 565, 566*f*
  - pyrimidine nucleotides 571
- Dehydration 166, 417, 508
- Dehydrogenase 130, 257
- Dementia 481
- Demyelination 494, 495
- Denaturation of
  - DNA strands 576
  - protein 42, 42*f*
- Denaturing high performance
  - liquid chromatography 643
- Density gradient centrifugation 448
- Dental caries 530
- Deoxy sugars 76, 76*f*
- Deoxyribonucleic acid 297, 559, 574
- Deoxyribonucleoside phosphates 562
- Deoxyribonucleotide 561
  - formation 571
- Deoxyribose 76
- Depletion of glucose 311
- Depresses glycogen 313
- Depressive psychosis 241
- Derivation of
  - equilibrium constant 55
  - Michaelis constant 55
- Derived
  - amino acids 26*f*
  - proteins 43
- Dermatan sulfate 81, 143
- Dermatitis 275, 481
- Desaturation of fatty acids 186
- Desulfhydrase 20
- Detection of
  - HIV 453
  - infectious diseases 639
  - thyroid antibodies 675
- Determination of glucose in
  - body fluids 312
- Detoxification 545
  - of ammonia 203
  - of drugs 133
- Dexamethasone
  - suppression test 662, 667
- Dextrose 71
- Di acyl glycerol 655*f*
- Diabetes
  - insipidus 373, 660
  - mellitus 73, 107, 135, 162, 163, 165, 311, 314, 317, 323, 324, 326, 336, 338, 416, 536, 727
  - ketoacidosis 332, 326, 333, 400, 417
  - ketosis 404
  - nephropathy 332
  - nephrosclerosis 316
  - prone states 324
- Diacylglycerol pathway 655
- Diarrhea 400, 404, 411, 412, 481
- Diastereoisomers of glucose 71
- Dibasic
  - amino acids 26*f*
  - monocarboxylic acids 24
- Dicarboxylic
  - aciduria 155, 156
  - amino
    - acids 25*f*
    - aciduria 226
- Dichlorodiphenyltrichloroethane 553
- Dickens-Horecker pathway 129
- Dicoumarol 61, 475*f*
- Dietary
  - carbohydrates 530
  - deficiency of tryptophan 482
  - fiber 81, 531
  - sources of
    - niacin 482
    - riboflavin 480
    - vitamin A 469
    - vitamin B<sub>6</sub> 484
    - vitamin C 498
- Diet-induced thermogenesis 529
- Digestion 5
  - in intestines 147
  - in stomach 147
  - of carbohydrates 105
  - of lipids 147
  - of medium chain fatty acids 184
  - of nucleic acids 563
  - of proteins 196
  - of triacylglycerols 148
- Dihydrofolic acid 572*f*
- Dihydrolipoyl
  - dehydrogenase 115
  - transacetylase 115
- Dihydrotestosterone 670
- Dihydrouridine 597
- Diisopropyl fluorophosphates 61
- Dilutional hyponatremia 409
- Dinitrophenylhydrazine test 208, 429
- Dipalmitoyl lecithin 91
- Dipeptidases 198
- Diphilobothrium latum infection 494
- Diphtheria toxin 605
- Diseases
  - associated with
    - DNA repair 584
    - mitochondria 268
  - of eye 436
- Disorders of
  - branched chain amino acids 428
  - heme synthesis 274
  - histidine metabolism 428
  - proline and hydroxyproline 428
  - purine metabolism 566, 569*t*
  - pyrimidine metabolism 570, 571*t*
  - urea cycle 205



- Disposal of ammonia 203
- Distal  
 convoluted tubules 362, 396, 397  
 histidine 283
- Distribution of iron 514
- Disturbances in  
 acid-base balance 397  
 electrolyte balance 410  
 fluid balance 410
- Diuretic therapy 404
- Dixon plot 57
- DNA  
 finger printing in  
 forensic medicine 637  
 polymerase 580  
 repair mechanisms 582, 585  
 sequencing 643, 643*f*  
 synthesis 320, 621*f*
- Docosahexaenoic acid 184
- Donnan membrane equilibrium 8, 8*f*
- Dopa-decarboxylase 235
- Dopamine 235
- Double reciprocal plot 57
- Down syndrome 324
- Doxorubicin 267
- Drug induced hemolytic  
 anemia 133, 307
- Dry  
 beriberi 478  
 chemistry systems 457
- Dubin-Johnson syndrome 279, 280, 351
- Duchenne muscular dystrophy 631, 637, 645
- Duodenal ulcer 357
- D-xylose absorption test 359
- Dysuria 296
- E**
- Ecchymoses 498
- Ectopia lentis 221
- Ectopic secretion of tumors 508
- Edema 381, 412, 535
- Ehrlich's  
 aldehyde reagent 279  
 test 279, 350, 365
- Eicosanoids 188
- Eicosapentaenoic acid 184
- Electrolyte imbalance 410
- Electromagnetic waves 734
- Electron transport chain 13, 255, 256
- Electrophoresis 292, 304, 378, 422, 446  
 apparatus 446, 447*f*  
 of CSF 422
- Electrophoretic  
 and ultra-centrifuge patterns  
 of lipoproteins 174*f*  
 mobility 303, 386, 691  
 pattern of hyperlipidemias 343*f*
- Electrospray ionization 458
- Electrostatic bonds 5
- Elemental mercury 552
- ELISA test 309, 453
- Elongation  
 of DNA strand 580  
 of fatty acids 186  
 process of  
 transcription 590  
 translation 601
- Emden-Meyerhof-Parnas  
 pathway 108, 108*f*
- Embryonic hemoglobins 289
- Emission spectroscopy 456
- Emphysema 352
- Endocarditis 374
- Endocytic vesicle 21
- Endocytosis 21, 22*f*
- Endogenous triglycerols 177
- Endoplasmic reticulum 11, 14, 155, 186, 602  
 of liver 545  
 stress 605
- Endorphins 662
- Energetics of  
 beta oxidation 153  
 oxidative phosphorylation 257  
 urea cycle 204
- Energy  
 density 527  
 equivalent 99  
 Kcal 539, 758
- Enterohepatic circulation 278  
 of bile salts 149
- Enzymatic method 313
- Enzyme 38, 254, 257  
 concentration 56, 56*f*  
 containing metals 51  
 contains heme 227*f*  
 defect 193, 206, 274  
 deficiencies in porphyrias 275*f*  
 engineering 66  
 indicating hepatocellular  
 damage 353  
 inhibited 61, 276  
 kinetics 47, 55  
 linked immunosorbent assay  
 453, 674  
 multiplied immunoassay  
 technique 454  
 profile in liver diseases 305  
 substrate complex 52*f*, 53  
 theory 53
- Epidemic dropsy 556
- Epimerism of aldoses 71
- Epimers of D-glucose 71*f*
- Epinephrine 161, 216, 235, 322
- Epstein-Barr virus 708
- Eruptive xanthomata 342
- Erythroblastosis fetalis 280
- Erythrocyte 393  
 membrane integrity 133
- Erythroextrin 78
- Erythrodonia 275
- Erythromycin 351, 605
- Erythropoietic  
 porphyrias 274  
 protoporphyria 275  
 regulation 516
- Erythropoietin 270, 741
- Escherichia coli* 580, 629
- Essential  
 amino acids 196, 532  
 fatty acids 187, 531  
 pentosuria 135
- Estimation of urinary free cortisol 667
- Estradiol 669
- Estrogen receptor 715
- Etanercept 696
- Ethanol 121, 484,

- Ethanolamine 214, 216  
 plasmalogen 91*f*
- Ethylenediaminetetraacetic acid 442
- Eukaryotic cell 5
- Euthyroid goiter 676
- Ex vivo gene therapy 630*f*
- Examples of  
 allosteric enzymes 63*t*  
 competitive inhibition 568*f*  
 hydrolysis 547*f*  
 stereospecificity 65*f*
- Excessive mobilization of fat 162
- Excretion of  
 ammonium ions 397  
 hydrogen ions in proximal tubules 395*f*  
 iron 518
- Exocrine glands 243
- Exocytosis 22*f*
- Exonucleolytic proofreading 583, 584*f*
- Extensor plantar reflex 494
- Extracellular  
 fluid 409, 411  
 maturation of collagen 721  
 osmolality 410
- Extrahepatic  
 cholestasis 349, 351  
 obstruction 305, 354  
 tissues 164
- F**
- FAB portion 688
- Fabry disease 193, 428, 429
- FAD  
 dependent enzymes 479  
 linked dehydrogenase 152
- Familial  
 adenomatous polyposis 707  
 hypercholesterolemia 631  
 hyperlipoproteinemias 336  
 hypo beta lipoproteinemia 342
- Fanconi's  
 anemia 585  
 syndrome 316, 512
- Fasting blood sugar 313
- Fat  
 balance studies 359  
 soluble vitamins 463  
 A 463  
 D 463  
 E 463  
 K 463
- Fatal familial insomnia 728
- Fate of  
 carbon skeletons of amino acids 244  
 chylomicrons 150  
 conjugated bilirubin in intestine 278  
 glucose-6-phosphate 109*f*  
 propionyl CoA 154
- Fatty  
 acid 84, 147, 155, 251  
 synthase complex 156  
 synthesis 156  
 transport protein 181  
 liver 141, 162, 163, 495, 535
- Favors glycogen synthesis 313
- Ferric  
 chloride test 237, 238, 429  
 reductase 515
- Ferrochelatase deficiency 275
- Ferroprotoporphyrin 271
- Ferrous iron 515
- Fetal  
 alcohol syndrome 141  
 hemoglobin 288  
 warfarin syndrome 476
- Feulgen staining 76
- Fibrinogen 385
- Fibroblast growth factor 512, 741
- Fibrocystic disease 359
- Fibrosis 163
- Fibrous  
 proliferation 335  
 proteins 43
- FIGLU excretion test 244, 490, 494
- Finasteride 670
- Fine regulation of lac operon 618
- Finger printing method 40
- First law of thermodynamics 7
- Fischer's template theory 53, 53*f*
- Fish tapeworm 494
- Flame photometer 456, 457*f*
- Flavonoids 499
- Flavoproteins 479
- Fluid mosaic model 14  
 of membrane 15*f*
- Fluorescence activated cell sorter 458
- Fluorescent immunoassay 454
- Fluoride 111, 522
- Folate  
 antagonists 491, 491*f*  
 deficiency 489, 493  
 reductase 489*f*  
 trap 494
- Folic acid 243, 488, 499, 519, 572*f*  
 and methotrexate 718*f*  
 deficiency 244  
 metabolism 497  
 therapy 491
- Food 539  
 allergy 199  
 exchange  
 content 540  
 system 539, 540*t*
- Formaldehyde 553
- Formation of  
 active  
 methionine 216*f*  
 sulfate 219  
 alpha ketoglutarate 248  
 ammonia 200  
 AMP 563  
 arginine 204  
 argininosuccinate 204  
 bile  
 acids 182  
 salts 181*f*  
 branches in glycogen 125*f*  
 carbamino compound 30  
 carbamoyl phosphate 203  
 citric acid 248  
 citrulline 204  
 disulfide bridges 30*f*  
 dopa quinone 234  
 esters 75  
 free radicals 435*f*  
 fumarate 248

- glutamine 30*f*
  - glutathione 217
  - indolequinone 234
  - isocitrate 248
  - malate 248
  - serine 214*f*
  - succinyl CoA 248
  - taurine 219
  - vitamin D 469
  - Fossil studies 639
  - Fouchet's test 279, 350, 365
  - Fractional
    - excretion of
      - bicarbonate 374
      - phosphate 374
      - sodium 374
    - tubular reabsorption of
      - phosphate 374
  - Fractionation of doses 737
  - Frederickson's classification 342, 343*t*
  - Free
    - bilirubin 279
    - fatty acid 100, 150, 154, 161, 171, 174, 181, 322, 428
    - radical
      - reaction theory 730
      - scavenging enzymes 133*f*, 435*f*
      - toxicity 437*f*
  - Friedreich ataxia 324
  - Fructokinase 137
  - Fructosamine 330
    - albumin 330
  - Fructose 142
    - entering glycolysis 138*f*
    - intolerance 144
    - metabolism 137
  - Fructosuria 138, 144, 317
  - Frusemide 363
  - Fumaryl acetoacetate hydrolase 239
  - Functions of
    - albumin 380
    - calcium 503
    - carbohydrates 69
    - cholesterol 169
    - citric acid cycle 247
    - collagen 722
    - copper 521
    - glycogen 123
    - glycoproteins 145*t*
    - immunoglobulins 689*t*
    - kidney 361
    - lipids 83
    - liver 346, 347
    - magnesium 512
    - muscle and liver glycogen 123*f*
    - phosphate ions 511
    - pyridoxal phosphate 482
    - pyridoxine 482
    - serotonin 240
    - sulfur 513
    - thiamine 482
    - tubules 362
  - Fungal infections 555
  - Fusion proteins 606, 643
  - Futile cycling of lipids 536
- G**
- GABA
    - metabolism 224*f*
    - pentin 31
  - Galactokinase
    - deficiency 140
    - reaction 139
  - Galactose 71, 194*f*, 355
    - 1-phosphate uridyl transferase 139
    - metabolism 138, 139*f*
    - tolerance test 354
  - Galactosemia 139, 139*f*, 144, 430
  - Galactosuria 139, 317
  - Gallstones 349, 360
  - Gamma
    - amino butyric acid 30, 224, 483
    - carboxyglutamic acid 224, 475
    - carboxylation 603
    - globulin 352, 687
    - glutamyl
      - cycle 198, 199*f*, 429
      - transferase 141, 146, 305, 306, 308, 348, 354, 360
      - transpeptidase 141
    - linolenic acid 187
  - Gangliosides 92
  - Gas liquid chromatography 449, 450*f*
  - Gastrectomy 316
  - Gastric
    - and pancreatic function tests 356
    - atrophy 493
    - carcinoma 357
    - cell hyperplasia 357
    - digestion of proteins 197
    - function tests 356
    - inhibitory polypeptide 680
    - lipase 147
  - Gastrin 357
  - Gastritis 357
  - Gastrointestinal
    - hormones 319
    - loss 415
    - tract 190
  - Gaucher's disease 192, 193, 428-430
  - Gel filtration chromatography 450
  - Gene
    - amplification 620
    - gun method 631
    - library 628
    - switching 620
    - therapy 625, 629
    - transcription 320
  - Generation of
    - bilirubin 276
    - calcitriol 470*f*
    - cyclic amp 127
    - free radicals 434
    - nerve impulse 465
    - one-carbon groups 207
    - reducing equivalents 132
    - ROS in macrophages 133*f*, 434*f*
    - succinate 248
  - Genetic heterogeneity of virus 703
  - Gerstmann-Straussler-Scheinker
    - disease 728
  - Gestational diabetes mellitus 315, 324, 333
  - Ghrelin 537, 661
  - Gibb's free energy concept 7
  - Gilbert's
    - disease 279
    - syndrome 349
  - Globin chain 290
  - Globular proteins 43

- Glomerular  
   dysfunction 374  
   filtration rate 362, 366, 368  
   proteinuria 371  
 Glucagon 161, 165, 313, 322, 323  
   inhibits lipogenesis 160  
 Glucocorticoids 113, 322, 323  
 Glucogenic  
   amino acid 120, 215, 216, 226, 251  
   pathway 211  
 Glucokinase 109  
 Glucometer 313, 457, 458*f*  
 Gluconeogenesis 101, 103, 117,  
   118*f*, 165,  
   200, 312, 322, 323, 674  
 Gluconeogenic  
   enzyme 117, 120*f*  
   pathway 119*f*  
 Glucosamine 142  
 Glucose 71, 108, 142,  
   194*f*, 273, 318, 364  
   6-phosphatase  
     deficiency 567  
     in liver 124  
     reaction 118  
   6-phosphate dehydrogenase  
     67, 130, 133*f*, 134, 136,  
     290, 307, 435*f*, 555  
   absorption 106*f*  
   alanine cycle 120, 120*f*  
   metabolism 107  
   oxidase 309, 313  
   phosphorylation 512  
   tolerance test 314  
   transporters 18, 106, 106*t*  
 Glucosuria 73, 317, 326  
 Glucuronic acid 74, 547  
   pathway of glucose 134  
 Glucuronides 317  
 Glutamate  
   dehydrogenase 202, 257  
   transporters 225  
 Glutamic acid 26, 29, 30,  
   118*f*, 120, 202, 203, 223,  
   225*f*, 450, 451, 488  
   decarboxylase 324  
 Glutaminase 203, 224*f*, 397  
   142, 145*t*, 143  
 Glycosides 75, 75*f*, 75*t*  
 Glycosphingolipids 91, 92  
 Glycosuria 317  
 Glycosylation 143, 329, 603  
   of procollagen 721  
 Gmelin's test 279  
 Golberg-Hogness box  
   in eukaryotes 589  
 Golgi  
   apparatus 12, 14, 22  
   bodies 14, 605  
   complex 11  
   membrane 144  
 Gonadotropins 662  
 Gopalan's burning foot syndrome 485  
 Gout 566, 567  
 Grading of chronic kidney disease 369*t*  
 Gramicidin 19, 265  
 Granulocyte  
   colony stimulating factor 696  
   macrophage colony  
     stimulating factor 696  
 Grave's disease 676, 677  
 Growth hormone 322, 323, 660  
 Guanidoacetic acid 211  
 Guanosine 561  
 Guthrie test 237, 237*f*
- H**
- Haemophilus influenzae* 629  
 Haptoglobin transferrin 355  
 Hardy-Weinberg law 610  
 Harrison's sulcus 472  
 Hartnup disease 21, 199, 242,  
   243, 431, 482  
 Hashimoto's thyroiditis 675-677  
 Hawkinsinuria 239  
 Hay's test 350  
 Heal wounds 499  
 Heart  
   attacks 189, 221, 467  
   diseases 531, 554  
   failure 416  
 Heat  
   and acetic acid test 365



- coagulation 43*f*
- shock proteins 604, 730, 741
- stability 67
- Heavy
  - chain disease 690
  - chain of myosin 724*f*
  - metal poisons 550, 551
- Helicobacter pylori* 358, 500
- Hematopoietic stem
  - cell transplantation 631
- Hematuria 365
- Heme
  - carrier protein 517
  - containing proteins 514
  - molecule 273*f*
  - oxygenase 517
  - synthesis 270, 271*f*, 483, 552
- Hemochromatosis 520
- Hemoglobin 283, 288, 290, 293
  - derivatives 289
  - lepore 294
  - metabolism 497
- Hemoglobinopathies 290
- Hemoglobinuria 372, 365
- Hemolysis 441, 490
- Hemolytic
  - anemia 295, 519, 555
  - disease 280, 423
  - of newborn 280
  - jaundice 280, 281, 350
- Hemophilia 631
  - A 386
  - B 386
- Hemorrhage 190, 295, 518
- Hemosiderin 517
- Hemosiderosis 519, 520
- Henderson-Hasselbalch equation 392
- Heparan sulfate 143
- Heparin 80, 176, 442
- Hepatic
  - coma 206
  - diseases 308, 508
  - encephalopathy 354
  - lipase 344
  - porphyrias 274
  - scavenger receptor 180
  - triglyceride lipase 180
  - vein thrombosis 348
- Hepatitis
  - A 351
  - B 351
    - infection 351
    - virus 163, 351
  - C 351
    - virus 375
  - D 351
  - E 351
- Hepatocellular
  - carcinoma 713
  - jaundice 280, 281, 350
- Hepatorenal tyrosinemia 239
- Hereditary
  - fructose intolerance 138, 146
  - hypophosphatemia 512
  - polyposis colon cancer 585
  - protoporphyrin 274
- Hermansky-Pudlak syndrome 729
- Herpes simplex virus 621
- Hers' disease 144
- Heterocyclic amino acids 24
- Heteroduplex analysis 641
- Heteroglycans 78, 79
- Heteronuclear mRNA 591
- Heteropolysaccharides 70
- Hexokinase 49, 108, 109
- Hexose monophosphate 129, 130
- High
  - anion gap 404
  - metabolic acidosis 400
  - blood sugar stimulates
    - insulin secretion 322*f*
  - density lipoproteins 179, 173, 180
  - energy phosphate bond 111
  - mobility group box protein 742
  - pressure liquid chromatography 450
  - sensitivity C reactive protein 338
  - voltage electrophoresis 448
- Higher organization of DNA 576
- Hill equation 58
- Hippuric acid 97, 213, 548
- Histamine 31, 243, 357
  - fast achlorhydria 357
- Histidine 26, 28, 29, 31, 203, 207, 216, 232, 243, 450, 451
  - load test 490
- Histidinemia 244, 431
- HIV
  - genes 701
  - replication cycle 702*f*
- HLA antigens 693
- Hodgkin's disease 375
- Homeostasis of blood glucose 312*f*
- Homocysteine 221, 483
  - methyl transferase 489*f*, 493
- Homocystinuria 220, 431, 494
- Homogentisate oxidase 237
- Homogentisic acid 317, 318
- Homopolymer tailing 627
- Homopolysaccharides 70
- Hookworm infection 518, 519
- Hopkins-Cole test 31
- Hormonal regulation of
  - gluconeogenesis 121, 121*f*
- Hormone 18, 312, 452, 647, 654, 669
  - acting adenylcyclase 653
  - binding activates G-protein 651*f*
  - inhibit adenylcyclase 653
  - of anterior pituitary 660, 661*t*
  - sensitive lipase 161, 181, 321
  - stimulate adenylcyclase 653
- Host DNA of human cervical
  - cancer cells 709*f*
- Human
  - chorionic gonadotropin
    - 425, 662, 663
  - immunodeficiency virus 701
  - oncogenic viruses 708*t*
  - papilloma virus 709
  - placental lactogen 663
  - prion diseases 728
  - recombinant proteins 628
  - T cell leukemia virus 107
- Humoral
  - immune deficiency 692
  - immunity 686, 687
- Huntington's
  - chorea 637
  - disease 225, 324, 606

- Hyaluronic acid 80, 145  
 Hybrid cells 640  
 Hybridoma 98  
 Hydrochloric acid 550  
   secretion 356*f*  
 Hydrogen 735  
   bonding 5, 575  
   peroxide 185, 257, 434, 566  
 Hydrolases 49  
 Hydrolysis 546, 673  
   of DNA 586  
   of starch 78  
   of triacylglycerols 88  
   of triglycerides 88*f*  
 Hydroperoxidases 258  
 Hydrophobic interaction 6, 6*f*  
 Hydroxyamino acids 24, 25*f*  
 Hydroxycobalamin 492  
 Hydroxyecosatetraenoic acid 191*f*  
 Hydroxyfatty acids 85  
 Hydroxyindoleacetic acid 239  
 Hydroxylases 258  
 Hydroxylation of  
   proline and lysine 497  
 Hydroxyproline 244  
 Hydroxypyruvate 214  
 Hyperammonemia 205, 207, 208*f*  
   hyperornithinemia homocitrullinuria  
   syndrome 208  
 Hyperargininemia 206  
 Hyperbilirubinemia 278, 279  
 Hypercalcemia 401, 507, 508, 512  
 Hyperchloremic acidosis 400, 401, 507  
 Hyperemesis 165  
 Hypergammaglobulinemia 382, 691  
 Hyperglycemia 313, 326, 412  
 Hyperglycemic  
   glucosuria 317  
   hormone 313, 322  
 Hyperhomocysteinemia 221, 222, 490  
 Hyperhydroxyprolinemia 244  
 Hyperkalemia 397, 402, 415  
 Hyperkalemic periodic paralysis 416  
 Hyperkeratosis 468  
 Hyperlipidemias 326, 334, 342  
 Hyperlipoproteinemia 343  
 Hyperlysinemias 226  
 Hypermagnesemia 513  
 Hypermethioninemias 220  
 Hypernatremia 412  
 Hyperornithinemia 206, 428  
 Hyperosmolar nonketotic coma 328  
 Hyperparathyroidism 507,  
   508, 511, 512  
 Hyperphenylalaninemias 428  
 Hyperprolinemia 431  
 Hypertension 336, 339, 411, 536  
 Hypertonic  
   contraction 411  
   expansion 411  
   fluids 413  
   hyponatremia 413  
 Hypertyrosinemia 239, 431, 428  
 Hyperuricemia 128, 566  
 Hyperventilation 395, 404  
 Hypervitaminosis 469  
   D 473  
   E 474  
   K 476  
 Hypoalbuminemia 382, 401, 535  
 Hypo-alpha-lipoproteinemia 342  
 Hypocalcemia 508, 512  
 Hypochloremia 417  
 Hypochloremic alkalosis 402  
 Hypochromic microcytic anemia 294  
 Hypogammaglobulinemia 691  
 Hypoglycemia 139, 140, 313, 330, 535  
   fatal 331*f*  
 Hypoglycemic hormone 311  
 Hypokalemia 397, 402, 414, 535  
 Hypolipidemic drugs 340  
 Hypolipoproteinemias 341  
 Hypomagnesemia 415, 513, 535  
 Hyponatremia 412  
 Hypoparathyroidism 508, 511, 512  
 Hypophosphatemic rickets 472, 512  
 Hypopigmentation 236  
 Hypopituitarism 675  
 Hypoproteinemia 382  
 Hypothalamic  
   and pituitary hormones 659  
   neuropeptides 659  
 Hypothalamus 537  
 Hypothyroidism 336, 344, 676  
 Hypotonic  
   contraction 411  
   expansion 411  
   fluids 413  
   hyponatremia 413  
 Hypouricemia 568  
 Hypoventilation 403  
 Hypovolemia 410  
 Hypoxanthine 560  
 Hypoxia 292  
  
 Identification of virus infection 621  
 Imidazole aminoaciduria 244  
 Imino  
   acid 24, 26, 198  
   glycinuria 199  
 Immobilized enzymes 309  
 Immunoelectrophoresis 448, 448*f*  
 Immunofluorescence 454, 454*f*  
 Immunoglobulin 689  
   molecule 687*f*  
 Immunological tests in  
   liver disease 355  
   renal diseases 374  
 Immunology of AIDS 702  
 Immunoselection of virus 703  
 Impaired  
   fasting glycemia 315, 324  
   glucose  
     regulation 315  
     tolerance 315, 324  
 Importance of  
   carbohydrates 530  
   creatinine clearance 367  
   glucuronic acid pathway 134  
   proteins 532  
   pyruvate dehydrogenase 116  
   urea clearance 369  
 In situ hybridization 635  
 In vitro synthesized-protein assay 642  
 Indole ring 240  
 Infantile  
   beriberi 478  
   Refsum's disease 155  
   scurvy 497

- Infarction 335  
 Infliximab 696  
 Infusion of fluids 411  
 Ingram's technique 40  
 Inheritance  
   of HBS-C disease 293*f*  
   pattern of hemophilia 388*f*  
 Inherited disorders 155  
 Inhibition of cell division 730  
 Inhibitors of  
   ATP synthesis 265  
   DNA replication 586  
   oxidative phosphorylation 265  
   protein synthesis 605  
     in mammals 605  
   RNA synthesis 593, 593*t*  
   TCA cycle 254  
 Inhibits  
   gluconeogenesis 313  
   plasminogen activation 179*f*  
 Initial number of cells 737  
 Initiation of  
   protein synthesis 600  
   transcription 590  
 Inorganic  
   acidosis 401  
   ions 59  
   mercury 552  
   pyrophosphate 258  
 Inositol triphosphate 495, 655*f*  
 Insulin 113, 165, 318, 323  
   biosynthesis 318*f*  
   deficiency 323, 416  
   dependent diabetes mellitus 323  
   injections 330  
   like growth factor receptor 742  
   resistance syndrome 325, 333  
   signaling pathway 656  
   therapy 512  
 Insulinoma 331  
 Integral membrane proteins 16  
 Integration of major  
   metabolic pathways 251  
 Interconversion of  
   amino acids 201  
   one-carbon groups 207  
   vitamin A molecules 464*f*  
 Intermediate  
   density lipoprotein 173, 176  
   filaments 726  
 Internal hemorrhage 498  
 Interorgan transport of  
   amino acids 200, 200*f*  
 Interpretation of  
   blood urea value 370  
   creatinine clearance 368  
   gastric juice analysis 357  
   glycohemoglobin values 329  
   urea clearance value 370  
 Interrelations of amino sugars 142*f*  
 Interstitial  
   fluid 408  
   implantation for treating cancer 735  
 Intestinal  
   digestion of proteins 198  
   malabsorption 508  
   system 228  
   villous cells 470  
 Intracellular  
   fluid 408, 409  
   protein degradation 199  
 Intrahepatic cholestasis 305, 349, 351  
 Intralysosomal accumulation 145  
 Intravenous GTT 316  
 Inulin 79  
   clearance 371  
 Iodine 521, 735  
   metabolism 672  
   number 88  
 Ion  
   channels 18  
   exchange chromatography 451, 451*f*  
 Ionic  
   bond 5, 5*f*  
     in protein interactions 5*f*  
   forms of amino acids 27*f*  
 Ionization of aspartic acid 28*f*  
 Ionized calcium 505  
 Ionophores 19  
 Iron  
   absorption 517  
   containing proteins 514*t*  
   deficiency 518  
     anemia 518, 519*f*  
   produces free radicals 435*f*  
   sulfur complexes 514  
   toxicity 520  
   vessels 520  
 Ischemia modified albumin 305  
 Ischemic heart disease 342  
 Isocitrate dehydrogenase 248, 253, 257  
 Isoelectric  
   focusing 448  
   precipitation 41  
 Isoenzymes of  
   alkaline phosphatase 306  
   CK 302  
 Isohydric transport of  
   carbon dioxide 287  
 Isoleucine 26, 27, 223, 230, 450, 451  
 Isomaltose 77, 78*f*  
 Isoniazid 482  
 Isonicotinic acid hydrazide 60  
 Isopentenyl pyrophosphate 171*f*  
 Isosthenuria 373  
 Isotonic  
   contraction 410  
   expansion 411  
   fluids 413  
 Isotope dilution technique 735  
 Isovaleric aciduria 208, 230, 430
- J**
- Jaffe's test 367  
 Jaundice 278, 346*f*, 348  
 Jejunal mucosa 149
- K**
- Kartagener's syndrome 724  
 Karyorrhesis 163  
 Kaschinbeck disease 523  
 Keratan sulfate 80, 143, 145  
 Keratomalacia 467, 468*f*  
 Keshan disease 523  
 Ketogenesis 141, 163, 165,  
   322, 323, 326  
 Ketogenic amino acids 245, 252  
 Ketone bodies 100, 101, 103, 364, 365  
 Ketonemia 165, 326

- Ketonuria 165, 326  
 Ketosis 165, 166, 326, 327, 400  
 Kidney 470  
   distal tubular cells 470  
   function tests 329, 361  
   scanning 736  
 Kill bacteria 185  
 Kimmelsteil-Wilson  
   syndrome 316, 328  
 Kinase phosphorylates enzymes 652  
 Kjeldahl's procedure 44  
 Klenow  
   enzyme 643  
   fragment 580  
 Klinefelter syndrome 324  
 Klotho protein 505  
 Kornberg's enzyme 580  
 Koshland's induced fit theory 54*f*  
 Krabbe's  
   disease 428  
   leukodystrophy 193  
 Krebs  
   citric acid cycle 251*f*  
   cycle 247, 249*f*, 254  
 Kussmaul's respiration 166, 402  
 Kwashiorkor 535
- L**
- Lactalbumin 420  
 Lactate 77  
   dehydrogenase 67, 111, 303  
   production 100  
 Lactic  
   acid cycle 114  
   acidemias 429  
   acidosis 117, 128, 140, 328,  
     400, 404, 428, 430, 478  
 Lactose 77, 77*f*  
   free diet 140  
   intolerance 144, 430  
   synthesis 138, 420  
 Lactosuria 317  
 Lactosyl ceramidoses 193  
 Lambert's law 455  
 L-amino acid oxidase 202*f*
- Large offspring syndrome 623  
 L-asparaginase 717  
 Late protein synthesis 621*f*  
 Latent jaundice 278  
 Lathyrus sativus 555  
 Lead poisoning 276, 518, 519, 551  
 Leber's  
   hereditary 631  
   neuropathy 606  
   optic neuropathy 268  
   optic neuropathy 611  
 Lecithin 90  
   cholesterol acyl transferase 180*f*  
   lysolecithin acyl transferase 192  
 Left ventricular hypertrophy 336  
 Leigh's syndrome 606  
 Lens  
   of eye 133  
   proteins 727  
 Lepore hemoglobin 611  
 Leprosy 375, 508  
 Lesch-Nyhan syndrome 430, 568  
 Lethal  
   infantile mitochondrial  
     ophthalmoplegia 268  
   mutations 614  
 Leuconostoc mesenteroides 66  
 Leucine 26, 27, 223, 230, 450, 451  
   aminopeptidase 198  
 Leukemia 641, 469  
 Leukocyte  
   adhesion deficiency 144  
   alkaline phosphatase 306  
   esterase 364  
   migration 726  
 Leukoderma 234  
 Leukopenia 490  
 Leukotriene 188, 190, 191*f*  
 Levels of organizations of proteins 37*f*  
 Levy Jening's chart 444  
 Liddle's disease 20  
 Ligand binding domain 657  
 Limiting amino acid 534  
 Limits of compensation 405, 405*t*  
 Lineweaver-Burk  
   equation 58  
   plot 57, 57*f*
- Linkage  
   analysis 628  
   of heme with globin 284*f*  
 Linoleic acid 186, 187, 187*f*  
 Lipid  
   accumulating 193, 347  
   peroxidation 186, 437  
   storage diseases 92, 193*t*, 194, 194*f*  
 Lipogenesis 321  
 Lipolysis 165, 323  
 Lipolytic enzymes in intestines 148  
 Lipoprotein 173  
   cascade pathway 176  
   glomerulopathy 175  
   lipase 161, 176  
   metabolism 180*f*, 335*f*  
 Liposomes 90  
 Lipoxin 190, 191*f*  
 Lithium 524  
 Liver 101  
   adipose tissue axis 162  
   and gastric function tests 346  
   cells 307  
   cirrhosis 384  
   diseases 305, 353  
   function tests 346, 348, 349, 355*t*  
   glycogen 123  
   metastases 354  
   mitochondria 163  
   regeneration 355  
 Lobry de Bruyn-van Ekenstein  
   transformation 73*f*  
 Location  
   in human chromosome 710  
   of gout attack 567*f*  
 Lohmann's reaction 211, 212*f*, 222  
 Long  
   chain  
     fatty acids 184, 185  
     saturated fatty acids 339, 341  
   QT syndrome 20, 415  
 Lovastatin 61  
 Low  
   blood sugar causes glucagon  
     secretion 322*f*  
   carbohydrate ketogenic diet 330  
   density lipoproteins 173, 177, 436



- HDL cholesterol 336  
phenylalanine 237
- Lower  
blood glucose 313  
surface tension 147
- Lowering of activation energy 51, 51*f*
- Lowry's method 44
- L-phosphatidic acid 89*f*
- Luminiscence 455
- Lundh test 359
- Lung  
maturity 423  
surfactants 91
- Lymph node enlargement in  
porta hepatis 349
- Lymphoma 281, 375
- Lynch syndrome 585
- Lynen's spiral 156
- Lysine 26, 27, 29, 216, 223, 226, 451  
vasopressin 659
- Lysinuric protein intolerance 199
- Lysolecithin 90
- Lysosome 11, 12, 14, 199
- M**
- Macroamylasemia 358
- Macrocytic anemia 490
- Macrophage 687  
colony stimulating factor 696  
inflammatory proteins 696  
migration inhibition factor 696
- Maillard reaction 328
- Main functions of kidney tubules 362*t*
- Maintaining blood sugar 311
- Maintenance of nitrogen balance 533
- Major catabolic pathway of  
tryptophan 240
- Malabsorption 359, 512
- Malaria 307
- Malate  
aspartate shuttle 117, 118, 118*f*,  
226, 260  
dehydrogenase 118*f*, 248, 257  
shuttle 260
- Malic enzyme 159
- Malignant  
hypertension 370  
hyperthermia 121, 726  
melanoma 234  
transformation 711
- Maltose 77, 77*f*
- Mammalian  
DNA polymerases 580  
RNA polymerases 589  
system 590
- Mammary glands 132
- Management of  
diabetes mellitus 330  
hypercalcemia 508  
ketoacidosis 166  
ketosis 327  
metabolic syndrome 325  
sickle cell disease 292
- Mancini's technique 45
- Manifestations of  
deficiency 475  
liver dysfunction 348  
mutations 614
- Maple syrup urine disease  
208, 230, 431
- Marasmus 535
- Marfan syndrome 222
- Markers of  
bone  
diseases 510  
formation 511  
resorption 510  
glomerular  
filtration rate 366  
permeability 371  
hepatic dysfunction 349  
myocardial infarction 302*t*  
obstructive liver disease 353
- Mass spectrometry 458, 458*f*
- Massive blood transfusions 512
- Master lipid regulator in liver 160
- Maternal serum alpha fetoprotein 425
- Matrix  
assisted laser desorption  
ionization 458  
metalloproteinases 742
- McArdle's disease 144
- Measurement of  
alpha fetoprotein 423  
bilirubin 349  
glomerular filtration rate 366  
osmolality 373  
pancreatic enzymes 358
- Mechanism of  
absorption of calcium 503  
action of  
hormones and signaling  
molecules 649  
insulin 319  
nitric oxide 228  
PTH 506  
steroid hormones 667  
thyroid hormone 674  
HCl secretion 356  
insulin secretion 319*f*  
regulation of pH 393
- Medium chain fatty acids 184
- Medullary  
carcinoma of thyroid 508  
thyroid carcinoma 716
- Megadose of vitamin C 499
- Megaloblastic anemia 494
- Meister cycle 199*f*
- Melanin synthesis pathway 234*f*
- Melanocyte stimulating hormone 234
- Melatonin 239, 241, 242
- Melting of DNA 576
- Membranes of organelle 16
- Memory aid for essential  
amino acids 27
- Menke's  
disease 355, 521  
kinky hair syndrome 521
- Mental retardation 139, 143, 145,  
221, 244, 245
- Mercury poisoning 552
- Meselson-Stahl experiment 579*f*
- Messenger RNA 587, 588
- Metabolic  
acidosis 166, 398, 399, 402, 416  
alkalosis 398, 402, 403, 403*t*, 405  
alterations in  
brain 100*f*  
cancer cells 712

- derangements in
  - diabetes mellitus 327*f*
- fate 228
  - of amino acids 245*f*
  - of pyruvate 115
- functions of
  - cysteine 217
  - serine 214
- junction point 117*f*
- pathways of carbohydrates 137
- profile of organs 99
- syndrome 324, 325, 333, 536
- traffic circle 252
- Metabolism of
  - adipose tissue 161
  - alcohol 140
  - amino
    - acids 197*f*, 200
    - sugars 142
  - arginine and ornithine 227*f*
  - ascorbic acid 496
  - aspartic acid 225*f*
  - catecholamines 235*f*
  - chylomicrons 176*f*
  - histamine 243*f*
  - histidine 243*f*
  - ketone bodies 163
  - sulfur 219
  - thyroid hormones 673*f*
  - tryptophan 239*f*
  - vitamin E 473
- Metachromatic leukodystrophy 193
- Metallo-enzymes 50
- Metallopeptidase inhibitor 745
- Metastatic
  - breast cancer 641
  - carcinoma of bone 508
  - and hyperparathyroidism 354
- Met-hemoglobin 218, 289
  - reductase system 289*f*
- Met-hemoglobinemias 134, 289
- Methionine 24, 26, 27,
  - 210, 216, 450, 451
  - adenosyl transferase 216, 229*f*
- Methotrexate 60, 61, 571, 620, 716
- Methyl
  - cobalamin 492
- Folate trap 493
- malonic
  - acid 494
  - aciduria 155, 431, 493
- malonyl CoA isomerase 493
- mercury 552
- transfer 216
  - reactions 217
- transferase 489*f*
- Methylenetetrahydrofolate
  - reductase 498
- Methylmalonic aciduria 208, 429
- Metyrapone test 667
- Micellar formation 89
- Michaelis
  - constant 57
  - Menten theory 53, 67
- Microalbuminuria 372
- Microarray technique 635
- Microcytic
  - hypochromic anemia 519
  - normochromic anemia 521
- Microsomal
  - cytochrome 12, 258
  - ethanol oxidizing system 140
  - heme oxygenase system 277
  - system 186
- Microsome 11, 155
- Microtubules 726
- Microvilli 16
- Miester cycle 198
- Migraine 236
- Milk alkali syndrome 404, 512
- Millon's test 31
- Minamata disease 552
- Mineral content of milk 421*t*
- Mineralization of bone 509
- Minor
  - pathways of deamination 202
  - purine bases 560
- Mitochondria 11, 13, 13*f*, 14, 248
- Mitochondrial
  - cytochrome 258
  - DNA and RNA 605
  - encephalopathy lactic acidosis 606
  - membrane permeabilization 268
  - permeability transition
    - pore 268, 616
  - system 268
  - transport systems 267
- Mitogen activated protein kinase 743
- Mitomycin C 717
- Mixed
  - micelle formation 149
  - triglycerides 87
- Mode of action of enzymes 51
- Modifications of amino acids 603
- Molecular structure of antigens 693
- Molecule of polyunsaturated
  - fatty acid 180
- Molybdenum 51, 523, 565
- Mono sodium glutamate 556
- Monoamine oxidase 236, 241
- Monoamino
  - dicarboxylic acids 24
  - monocarboxylic acids 24
- Monoclonal
  - antibody 717
  - band 690
- Mono-oxygenase 232, 258
- Monosaccharides 69
- Monounsaturated fatty acids 86,
  - 185, 532
- Movement of sperms 726
- Mucopolysaccharidoses 80, 82, 145
- Mucoproteins 81
- Mucosal block theory 515
- Multidrug resistance protein 278
- Multienzyme complex 66,
  - 210, 248, 570
- Multifactorial disorders 611
- Multiple
  - endocrine neoplasia 245, 357, 711
  - myeloma 375, 382, 401,
    - 508, 690, 715
  - sclerosis 16, 194, 422
- Multispecific organic
  - anion transporter 278
- Multistep progression 707
- Muscle 504
  - cramps 508
  - diseases 308
  - lacks glucose-6-phosphatase 125
  - proteins 724
  - weakness 511

Muscular dystrophies 212, 303, 324  
 Mutagens 614, 705  
 Mutation detection techniques 641  
 Mutual supplementation 534  
   of cereals and pulses 539  
   of proteins 534  
 Myasthenia gravis 495  
*Mycobacterium tuberculosis* 629  
 Myelin sheath 16, 495  
 Myeloperoxidase 133*f*, 304, 434  
 Myocardial infarction 169,  
   179, 202, 212, 302-305,  
   308, 335, 354, 436, 483  
 Myoclonic epilepsy 268, 606  
 Myoglobin 294, 304  
   chain 294*f*  
   in urine and blood 295  
 Myoglobinuria 295  
 Myosin 724  
   kinase 504  
 Myotonic dystrophy 324

## N

N-acetyl  
   glucosamine 82  
   glutamate 205  
   muramic acid 82  
   neuraminic acid 194*f*, 712  
 Naphthoquinone 474  
 Natural  
   amino acids 29  
   course of disease 700  
 Needle shaped crystals 74  
 Negative acute phase proteins 385  
 Neonatal  
   hypoglycemia 138  
   mortality 315  
   tyrosinemia 239  
 Neostigmine 61  
 Nephelometry 45  
 Nephron loss proteinuria 372  
 Nephrosis 370, 518, 519  
 Nephrotic syndrome 336, 344,  
   372, 412, 508  
 Nerve  
   cell 632*f*  
   conduction 504  
 Neural tube defects 352  
 Neurotoxins 551  
 Neutral  
   amino acids 198  
   fats 87, 531  
   sulfur 514  
 Nezelof's syndrome 692  
 Niacin 477, 480, 486  
   deficiency 240, 241, 481, 481*f*, 482  
 Nickel ions 306  
 Nicotinamide 50, 216  
   adenine dinucleotide phosphate 480  
   deficiency 240  
 Nicotinic acid 240, 340  
   pathway of tryptophan 240  
 Niemann-Pick disease 192, 193, 428,  
   430  
 Night blindness 467  
 Ninhydrin test 430  
 Nitric  
   acid 279  
   oxide 223, 224, 227, 290, 434  
   synthase 227, 270, 434  
 Nitrogen balance 533  
 Nitrogenous substances 218  
 N-methyl  
   D-aspartate 228  
   transferase 235  
 Nocturia 373  
 Node of Ranvier 16  
 Nomenclature of carbon atoms 87  
 Non-alcoholic  
   fatty liver disease 163  
   steatohepatitis 163, 305, 325, 351,  
   353, 354  
 Non-carbohydrate reducing  
   compounds 317  
 Non-competitive inhibition 61*f*  
 Non-esterified fatty acids 181, 538  
 Non-HDL cholesterol 338  
 Non-Hodgkin's lymphoma 641  
 Non-insulin dependent diabetes  
   mellitus 324, 333  
 Non-isotopic immunoassays 453  
 Non-ketotic hyperglycinemia  
   208, 213, 245  
 Non-oxidative deaminations 202  
 Non-phosphorylated lipids 92  
 Non-protein nitrogen 365  
 Non-steroidal anti-inflammatory  
   drugs 189, 195  
 Norepinephrine 216, 235  
 Normal  
   anion gap 404  
   metabolic acidosis 400, 401  
   composition of amniotic fluid 422*t*  
   constituents of cells 709  
   hydrochloric acid secretion 357*t*  
   iron kinetics 515*f*  
   oxygen atom 433*f*  
   pH 393  
   RBCs 291*f*  
   serum  
     electrolyte 404, 405  
     level of magnesium 512  
 Normoglycemia 313  
 Normotonic hyponatremia 413  
 Nuclear receptors 657  
 Nucleated RBC 294*f*  
 Nucleic acid 559, 560  
   of virus 708  
   research 735  
   testing 701  
 Nucleoside 560-562  
   diphosphate 562  
   monophosphate 562  
   triphosphate 562, 562*t*  
 Nucleotide 561  
   excision repair 583, 584, 584*f*  
   phosphatase 305, 306, 308, 354  
 Number of hydrogen atoms 279  
 Numbering of amino  
   acids in proteins 35  
 Nutritional  
   deficiency of iron 518  
   importance of lipids 531  
 Nyctalopia 467  
 Nystagmus 238

## O

Oasthouse syndrome 199, 220  
 Obermeyer test 242  
 Obesity 163, 336, 339, 536  
   index 536

- Obstruction of  
  bile duct 150  
  urinary tract 416
- Obstructive  
  jaundice 280, 281, 336, 350, 354  
  liver disease 354  
  stage of viral hepatitis 281
- Oculocerebrorenal syndrome 729
- Oculocutaneous tyrosinemia 239
- Okazaki fragments 581
- Oligomycin 264, 265
- Oligosaccharides 69
- Omega  
  3 fatty acids 163, 339  
  oxidation 155
- Oncogenes 709, 710
- Oncogenic viruses 351, 707, 713*f*
- Optic  
  neuritis 553  
  neuropathy 631
- Oral  
  cavity 498  
  contraceptives 412, 484  
  glucose tolerance test 314,  
  315*f*, 333  
  rehydration fluid 106
- Organ  
  perfusion 97  
  slices 97
- Organic  
  acid 208  
  disorders 208  
  acidosis 400  
  acidurias 154, 400, 428  
  mercury 552
- Organization of  
  electron transport chain 260  
  proteins 34
- Organophosphorus 553  
  compounds 553  
  insecticides 307
- Ornithine 31, 227, 450  
  decarboxylase 62, 229*f*  
  transcarbamoylase 204, 209
- Orotic aciduria 430, 570
- Osazone formation 74
- Oseltamiver 61, 621
- Osmolal gap 401
- Osmolality of  
  extracellular fluid 408  
  plasma 408, 408*t*
- Osmotic diuresis 166, 373
- Osteitis deformans 354
- Osteoblastoma 354
- Osteoblasts 305, 505
- Osteocalcin 475, 509, 511, 743
- Osteoclasts 506
- Osteoid 498, 509
- Osteomalacia 354, 471, 472, 510
- Osteonectin 743
- Osteopetrosis 510
- Osteopontin 743
- Osteoporosis 510
- Osteoprotegerin 743
- Ovarian  
  cancers 714  
  hormones 669
- Oxalic acid 515
- Oxaloacetate 248  
  junction point 249
- Oxidation 285  
  of acetyl CoA 165  
  of fat carbohydrate 252*f*  
  of fatty acids 87  
  of homogentisic acid 237*f*  
  of iodine 672  
  of odd chain fatty acids 154  
  of sugars 74  
  products of glucose 74*f*
- Oxidative  
  deamination of glutamate 202  
  decarboxylation 248  
  phosphorylation 111, 256, 263
- Oxidized fatty acids 336
- Oxoprolinuria 199
- Oxygen dissociation curve 284, 285
- P**
- Paget's disease 508, 510
- Palmitic acid 15, 85, 153, 156
- Pancreatic  
  digestion of proteins 197  
  elastase 358  
  enzymes 358  
  function tests 358, 359*t*  
  lipase 148
- Pancreozymin 197
- Pantothenic acid 477, 484, 486
- Paper chromatography 449, 449*f*
- Para amino benzoic acid 477, 488
- Paracetamol 189
- Paradoxic acidosis 402
- Paralysis of respiratory 404
- Paraproteinemia 401, 690
- Parathyroid  
  function tests 508  
  hormone 505, 509
- Paraventricular nucleus 660
- Parenchymal diseases 353
- Parent cell 579*f*
- Paresthesia 508
- Parkinson's disease 245, 552, 606
- Paroxysmal nocturnal  
  hemoglobinuria 16, 144
- Partial  
  gastrectomy 357  
  hydrolysis 40  
  reversal of glycolysis 118
- Pathogenesis of  
  ascites 347*f*  
  Prion diseases 728
- Pathology of maple syrup  
  urine disease 231*f*
- Pathways of glucose 105, 123
- Pauly's test 32
- Pellagra 242, 481, 483
- Penicillin 61
- Pentagastrin stimulation test 357
- Pentose  
  phosphate 130  
  pathway 129, 159  
  sugar 559
- Pentosuria 317
- Penultimate carbon atom 70*f*
- Pepsin 197, 308, 357
- Peptide bond  
  formation 31, 31*f*, 34*f*, 601  
  partial double bond 34*f*
- Peptidyl transferase 592, 601, 602



- Peripheral  
 blood  
 picture 490  
 smear 519  
 neuritis 483  
 neuropathy 495  
 proteins 15  
 smear 494
- Pernicious anemia 357
- Peroxidase 13, 258, 435*f*
- Peroxidation of polyunsaturated fatty acids 438*f*
- Peroxisomal  
 biogenesis disorders 185  
 defects 430  
 deficiency diseases 13  
 oxidation 185
- Peroxisomes 13
- Peroxy nitrite 228, 434
- Pertussis toxin 653
- Phagocytosis 22, 497
- Phagosomes 22
- Phenylalanine 26, 27, 29, 31, 232, 233, 245, 450, 451  
 catabolism 232*f*  
 hydroxylase 232, 232*f*, 236, 258  
 load test 237
- Phenylketonuria 236, 246, 431  
 carrier state 237
- Philadelphia chromosome 708
- Phosphate 19*f*, 142  
 buffer system 394  
 infusion 508  
 mechanism in tubules 396*f*
- Phosphatidates 89
- Phosphatidic acid 89
- Phosphatidyl  
 ethanolamine 191*f*  
 inositol 495  
 bisphosphate 655*f*  
 serine 191*f*
- Phosphatidylcholine 90
- Phosphatidylethanolamine 91, 91*f*
- Phosphatidylglycerol 91
- Phosphatidylinositol 91, 91*f*
- Phosphodiester bonds 574
- Phosphoenolpyruvate 258  
 carboxykinase 118, 118*f*, 320
- Phosphofructokinase 63, 109, 113, 121, 320
- Phosphoglucomutase 124, 124*f*
- Phosphogluconate oxidative pathway 129
- Phosphoglyceromutase 111
- Phospholipase 90, 189
- Phospholipid 89, 495  
 synthesis 495
- Phosphoproteins 214
- Phosphoribosyl pyrophosphate 240*f*, 563, 563*f*
- Phosphoric acid 89, 92, 561
- Phosphorus 507, 511, 551, 735
- Phosphorylase  
 enzyme 483  
 kinase 127, 504
- Phosphorylation 603, 652
- Phosphosphingosides 91, 92
- Photoelectric colorimeter 455, 455*f*
- Photophobia 238
- Phytanic acid 155
- Phytic acid 515
- Pineal gland 242
- Pinocytosis 21
- Pituitary adenoma 668
- Plasma  
 ACTH 667, 668  
 ammonium 428  
 bicarbonate 405  
 bile acids 355  
 bilirubin 278  
 cells 686  
 cortisol 668  
 lactate 428  
 lipids 173  
 membrane 14  
 osmolality 373  
 proteins 378  
 TSH 675, 676
- Plasmacytoma 690
- Plasmalogens 91, 192
- Plasmid liposome complex 631
- Plasminogen 179
- Plasmodium*  
*falciparum* 145  
 infection 134
- Platelet aggregation 190
- Plummer-Wilson syndrome 519
- Pneumocystis carinii* 704
- Pneumonia 404
- Polarity of DNA molecule 575
- Polyacrylamide gel electrophoresis 447, 447*f*
- Polyamine synthesis 229*f*
- Polycystic ovarian syndrome 680
- Polycythemia vera 737
- Polydipsia 326
- Polymerase chain reaction 638, 638*f*, 645
- Polyneuritis 478
- Polynucleotide 575*f*
- Polyol pathway of glucose 135, 135*f*
- Polypeptide 693
- Polyphagia 326
- Polyphenols 435
- Polyribosomes 602, 603*f*
- Polysaccharides 70, 78
- Polyunsaturated fatty acids 13, 85, 86*f*, 180, 186, 339, 437, 531, 532
- Polyuria 326
- Pompe disease 129, 144, 428, 429
- Porphobilinogen synthase  
 deficiency 275
- Porphyria 274  
 cutanea tarda 275*f*
- Porphyrin ring 271*f*
- Portal  
 hypertension 348  
 lymphadenopathy 351  
 vein thrombosis 348
- Porter-Silber reaction 666
- Positron emission  
 tomography scan 736
- Post-hepatic jaundice 350
- Post-prandial  
 blood sugar 313  
 hypoglycemia 331

- Poststreptococcal  
   glomerulonephritis 375
- Post-translational processing of  
   collagen 722
- Potassium 363, 413  
   chromate 550  
   excretion 414  
   ion 19*f*
- Powerhouse of cell 13
- Prader-Willi syndrome 324
- Pre-eclampsia of pregnancy 221
- Pre-hepatic jaundice 350
- Preparation of  
   specific human gene 626
- Preventable blindness 468
- Prevention of  
   atherosclerosis 339  
   met-hemoglobinemia 133
- Primary  
   biliary cirrhosis 351  
   deficit of carbonic acid 403  
   excess of  
     bicarbonate 402  
     carbonic acid 403  
   familial hypercholesterolemia 342  
   hemosiderosis 520  
   hepatoma 281  
   hyperoxaluria 213  
   hyperthyroidism 676  
   hypothyroidism 676  
   structure of  
     human insulin 35*f*  
     insulin 35
- Principles of  
   anti-sense therapy 593*f*  
   heredity 608  
   radioimmunoassay 452, 452*f*  
   thermodynamics 7
- Processing of  
   rRNA 598  
   tRNA 597
- Production of  
   bilirubin diglucuronide 278*f*  
   genomic library 630*f*  
   homogentisic acid 233  
   hybridoma 640
- niacin 483
- Progression of atherosclerosis 335
- Prokaryotes 570
- Prokaryotic cell 5
- Prolactin stimulation test 663
- Proline amino peptidase 198
- Prolonged in liver disease 355
- Promoters of cancer 706
- Promotes  
   glycogenolysis 313  
   glycolysis 313
- Properties of  
   amino acids 27  
   fatty acids 86
- Propionic aciduria 208, 429
- Propionyl CoA  
   carboxylase deficiency 155
- Prostacyclin 188, 190, 190*r*
- Prostaglandins 188
- Prostate cancer 306, 308
- Protease inhibitors 52, 554
- Protein 422, 534  
   biosynthesis 596  
   bound calcium 381, 505  
   buffer system 394  
   calorie malnutrition 163  
   catabolism 674  
   deficiency 533  
   energy malnutrition 534  
   kinase 653, 653*t*, 655*f*  
   misfolding diseases 729  
   phosphatase 127  
   phosphorylation 64  
   selectivity index 372  
   targeting 603  
   truncation test 642
- Proteinuria 371
- Proteoglycan 81, 142, 143
- Proteolytic digestion of myosin 725*f*
- Prothrombin 385, 475, 476  
   time 352, 385
- Proton  
   motive force 264  
   pump 263
- Proto-oncogenes are  
   regulatory genes 709
- Protoporphyrin 351
- Proximal  
   convoluted tubule 361, 362, 395  
   histidine 283
- Pseudocholinesterase 307
- Pseudohyperkalemia 413, 415, 416
- Pseudohypoparathyroidism 508, 509
- Pseudouridine arm of tRNA 597
- Pteric acid 488
- Pulmonary hypertension 228
- Pulsed field gel electrophoresis 448
- Purine  
   nucleoside phosphorylase 566*f*  
   synthesis 563*t*, 564*f*
- Puromycin 605
- Purulent meningitis 422
- Putrefaction of tryptophan 242
- Pyranose ring 72*f*
- Pyridoxal phosphate 50, 124, 201,  
   215, 224, 271, 482
- Pyridoxamine 482
- Pyridoxine 477, 482, 486
- Pyrimethamine 61, 491
- Pyrimidine 477  
   ring 226  
   synthesis 571
- Pyrrole ring 271*f*
- Pyrrolidine 26
- Pyrrolysine 31
- Pyruvate  
   carboxylase 63, 120, 428, 486, 504  
   deficiency 121  
   reaction 117  
   dehydrogenase 115, 117, 247, 257,  
     320, 477, 504  
   complex 115  
   kinase 111, 113, 117, 256, 320, 504  
   transporter 115
- Q**
- Quantitation of proteinuria 372
- Quantitative  
   PCR 639  
   preparation of biomolecules 624  
   real-time PCR 639

Quarter staggered arrangement 721  
 Quinolinate phosphoribosyl  
   transferase 240, 240*f*

## R

Radial immunodiffusion 45, 45*f*  
 Radiation protection 738  
 Radioactive iodine 453, 675  
 Radioimmunoassay 452, 735  
 Radium needles 737  
 Rancidity of fat 88  
 Random blood sugar 313  
 Rapaport Leubering cycle 115  
 Raynaud's disease 375  
 Reabsorption of  
   bicarbonate 395  
   calcium 506  
   solutes in tubules 362  
   water 363  
 Reaction  
   in liver 465*f*  
   lungs 288*f*  
   amide group 30  
   amino acids 29  
   CoA derivatives 485*f*  
   cycle preparatory steps 247  
   glycogen phosphorylase 124*f*  
   lactate dehydrogenase 50*f*  
   monosaccharides 73  
   oxaloacetate 250*f*  
 Receptor mediated endocytosis 21  
 Reciprocal regulation of  
   glycogenolysis 126*f*  
 Recommended daily allowance  
   of thiamine 479  
 Red depicts blood 465*f*  
 Reduce dietary cholesterol 339  
 Reduced  
   DNA synthesis 490  
   excretion rate 567  
 Reflectance spectrophotometry 457  
 Refsum's disease 155  
 Regeneration of  
   glucose-6-phosphate 131  
   oxaloacetate 248

Regulation of  
   acid secretion 357  
   ATP synthesis 265  
   beta oxidation 154  
   blood  
     glucose 311  
     sugar 313*f*  
   calcitriol formation 471  
   cholesterol synthesis 172*f*  
   citric acid cycle 253  
   color of skin 234  
   deoxyribonucleotide formation 569*t*  
   fatty acid synthesis 159  
   gene expression 616  
   gluconeogenesis 120  
   glycogen metabolism 126  
   glycolysis 112  
   glycosis 113*f*  
   heme synthesis 273  
   HMG CoA reductase 172*f*  
   HMP shunt pathway 131  
   ovarian hormones 669  
   purine synthesis 565  
   pyrimidine synthesis 570  
   secretion of HCl 356*f*  
   sodium and water balance 409  
   synthesis 189  
   urea cycle 204  
 Relative capacity of  
   buffer systems 394  
 Renal  
   acid excretion 397  
   artery stenosis 415  
   blood flow 362  
   disease 370, 512  
   failure 400, 404, 508, 511  
   function tests 361  
   glucosuria 316, 317  
   impairment 417, 512  
   insufficiency 220  
   osteodystrophy 510  
   plasma flow 371  
   regulation of pH 395  
   rickets 472  
   tubular acidosis 401, 404, 412,  
     415, 417, 508, 511, 512

Renin angiotensin  
   aldosterone 410*f*  
   system 409  
 Reperfusion injury 436, 436*f*  
 Replication  
   bubble 580, 581*f*  
   of DNA 578  
   of HIV 701  
 Requirement of  
   biotin 486  
   iron 514  
   pantothenic acid 485  
   vitamin  
     B<sub>12</sub> 494  
     C 498  
     D 473  
     zinc 522  
 Residual renal function 371  
 Respiratory  
   acidosis 398, 403, 405  
   alkalosis 398, 403, 405, 512  
   burst 22, 434  
   chain 255, 479  
   diseases 436  
   distress syndrome 91, 436  
   tract 190  
 Restriction  
   endonucleases 309, 586, 625  
   fragment length polymorphism 637  
   map 625  
   sites 625  
 Retention jaundice 350  
 Reticulocytosis 490  
 Retina 20  
 Retinal  
   degeneration 244  
   isomerase 466  
 Retinitis pigmentosa 185  
 Retinoblastoma  
   oncosuppressor protein 615  
   protein 744  
 Retinoic acid receptors 467  
 Retinol  
   binding protein 372, 464  
   palmitate 464  
 Retrolental fibroplasia 436

- Retroviruses 629, 630  
Reverse transcriptase PCR 639  
Reversible oxidation-reduction 496  
Rheumatoid arthritis 144, 375, 436, 641  
Rhodopsin 465  
RIA and ELISA tests 45  
Ribavirin 621  
Riboflavin 477, 479, 486  
  deficiency 479  
  structure 479*f*  
Ribonucleic acid 559, 587  
Ribonucleoside 561  
  phosphates 562  
Ribonucleotide 561  
  reductase 571*f*  
  complex 571  
Ribosomal RNA 587, 598  
Ribozymes 65, 592  
Ricketts 471, 354, 510  
Right handed double helix 575  
Rituximab 717, 718  
RNA  
  synthesis 621*f*  
  viruses 629  
Role of  
  amylase 309  
  antioxidants 438  
  carnitine 151  
  cyclic GMP 655  
  liver in fat metabolism 162  
Romberg's sign 494  
Rosenheim reaction 32  
Rothera's test 166, 326, 365, 429  
Rotor syndrome 280
- S**
- S-adenosyl methionine 216, 217, 222, 229*f*, 235, 258, 548  
Sakaguchi's test 32  
Salicylate 318, 400  
Salivary alpha-amylase 105  
Salvaging of iodine 674  
Sandhoff's disease 193  
Saponification 88*f*  
Sarcoidosis 508  
Sarcoplasmic reticulum 725  
Saturated  
  and transfatty acids 188  
  fatty acid 85, 86, 532  
Schilling test 359, 494  
Schlesinger's  
  reaction 279  
  test 279, 365  
Schwann's cells 16  
Scleroderma 375  
Scurvy 497  
Second law of thermodynamics 7  
Secondary  
  hyperthyroidism 676  
  hyperuricemia 567  
  hypothyroidism 676  
  immunodeficiency 692  
  structure of proteins 36  
Secretin cholecystokinin test 358  
Secretion of  
  adrenal hormones 665  
  hormones 504  
  insulin 318  
Segment of nephron 362  
Selective serotonin  
  reuptake inhibitors 240  
Selenocysteine 31, 32, 214, 599  
Self-monitoring of blood glucose 458  
Seliwanoff's test 317  
Sensitive gel electrophoresis 642*f*  
Sephadex chromatography 451*f*  
Sequelae of protein calorie  
  malnutrition 536  
Sequence of amino acids in proteins 34  
Serine 26, 29, 207, 210, 216, 450  
  metabolism 215*f*  
  proteases 52  
Serotonin 239, 240  
  and melatonin synthesis 241*f*  
Sertoli cells 670  
Serum  
  bilirubin 355  
  electrophoresis 352  
  ferroxidase 520  
  globulins 352  
  glutamate  
    dehydrogenase 141  
    oxaloacetate transaminase 305  
    pyruvate transaminase 305  
  proteins 507  
  triglyceride 338  
Severe hepatocellular disease 355  
Sex  
  hormone binding globulin 669  
  linked recessive inheritance 610, 610*f*  
  steroids 509  
Sheehan's syndrome 676  
Short  
  chain fatty acids 195  
  hairpin RNA 594  
Shunt bilirubin 274, 274*f*  
Sickle  
  cell 291*f*  
  anemia 636  
  disease 291  
  hemoglobin 291  
  trait 291, 292, 292*f*  
  syndromes 291  
Sickling test 292  
Sideroblastic anemia 275  
Signal molecule 653, 740  
Significance of  
  cholesterol 334  
  gluconeogenesis 118  
  glycolysis pathway 108  
  heat coagulation 42  
  HMP shunt pathway 131  
  isoelectric pH 41  
  lactate production 112  
  PUFA 86, 186  
  transamination 201  
Sildenafil citrate 228, 656  
Simple amino acids 25*f*  
Single  
  nucleotide polymorphism 4, 637  
  strand conformation  
    polymorphism 641  
Site directed mutagenesis 614  
Sjögren's syndrome 12, 375  
Skeletal muscle 100, 101, 107, 176



- Skin diseases 436
- Small  
 and medium chain fatty acids 185  
 chain fatty acids 184  
 nuclear RNAs 592  
 RNA 588
- Smell of acetone 166
- Sodium  
 channels 20  
 cyclamate 81  
 dodecyl sulfate 447  
 fluoride 442  
 hydroxide 550  
 ion 19<sup>f</sup>  
 potassium pump 19<sup>f</sup>  
 pump 20, 21, 23, 106, 411  
 restriction 412
- Softening of cornea 467
- Soluble matrix 259
- Somatic  
 mutation 584  
 recombination of DNA 693
- Sorensen's formal titration 29
- Sources of  
 biotin 486  
 C and N atoms of pyrimidine 569<sup>f</sup>  
 calcium 502  
 carbohydrates 530<sup>t</sup>  
 folic acid 490  
 iron 514  
 lead poison 551  
 pantothenic acid 485  
 PUFA 532<sup>t</sup>  
 vitamin  
 D 473  
 E 474  
 K 476
- Southern blot technique 634, 634<sup>f</sup>
- Spectrophotometer 456, 456<sup>f</sup>
- Spermidine synthase 229<sup>f</sup>
- Spermine synthase 229<sup>f</sup>
- Sphingolipidoses 193, 194
- Sphingolipids 91
- Sphingomyelin 92, 92<sup>f</sup>, 192
- Sphingosine 91, 91<sup>f</sup>
- Spiranolactone 363
- Split gene 693
- Spontaneous  
 decarboxylation 164  
 mutations 610, 713<sup>f</sup>
- Stages of  
 compensation 399<sup>t</sup>  
 oxidation of foodstuffs 255
- Standard  
 deviation index 445  
 urea clearance 370
- Staphylococcus aureus* 692
- Starch tolerance test 359
- Starling hypothesis 381<sup>f</sup>
- Starvation 163, 165  
 ketosis 332
- Stearic acid 85
- Stem cells 631, 632<sup>f</sup>
- Stereoisomers 70, 70<sup>f</sup>
- Steroid hormone 169, 664, 669<sup>t</sup>  
 enters nucleus 656<sup>f</sup>
- Stimulation test 667
- Storage of  
 iron 517  
 vitamin B<sub>12</sub> 492<sup>f</sup>
- Streptococcus thermophilus* 66
- Streptomycin 605
- Structure of  
 ADH and oxytocin 659<sup>f</sup>  
 alpha helix 37<sup>f</sup>  
 ATP 51<sup>f</sup>  
 beta-pleated sheet 37<sup>f</sup>  
 biotin 485, 485<sup>f</sup>  
 cholesterol 170<sup>f</sup>  
 chylomicrons 175<sup>f</sup>  
 co-enzyme 484<sup>f</sup>  
 collagen 720  
 DNA 574  
 folic acid 488<sup>f</sup>  
 heme 270, 271<sup>f</sup>  
 hemoglobin 283  
 HIV 701<sup>f</sup>  
 immunoglobulins 687  
 insulin 318  
 lipoic acid 115<sup>f</sup>
- mitochondrion 259  
 niacin 480<sup>f</sup>  
 pantothenic acid 484<sup>f</sup>  
 primary bile acids 181<sup>f</sup>  
 proteins 34  
 purines 560<sup>f</sup>  
 riboflavin 479  
 starch 78  
 sucrose 76<sup>f</sup>  
 T-cell receptor 694<sup>f</sup>  
 thiamine 477  
 pyrophosphate 478<sup>f</sup>  
 tRNA molecule 596  
 vitamin  
 A 464<sup>f</sup>  
 B<sub>12</sub> 491<sup>f</sup>
- Subacute combined degeneration 494
- Subarachnoid hemorrhage 422
- Subcellular  
 movements 726  
 organelle 10, 11
- Subclassification of  
 metabolic alkalosis 402
- Subluxation of lens 221
- Substrate  
 concentration 56, 56<sup>f</sup>  
 level phosphorylation 110, 111,  
 248, 256  
 saturation curve 56<sup>f</sup>  
 strain 52
- Succinate  
 dehydrogenase 248, 254, 257  
 Q-reductase 261  
 thiokinase 248, 256
- Succinylcholine 307, 495
- Sucrose 77, 530
- Sugars of nucleic acids 76<sup>f</sup>
- Suicide inhibition 62, 568
- Sulfate conjugation 547
- Sulfonamide 60, 61, 491
- Sulfur containing amino acids  
 24, 25<sup>f</sup>, 220<sup>t</sup>, 483
- Sulfuric acid 550
- Superoxide dismutase  
 13, 133<sup>f</sup>, 434, 435, 435<sup>f</sup>

- Surgical removal of gallbladder 360
- Synthesis of
- catecholamines 234
  - ceramide 192, 192*f*
  - cerebrosides 192, 193*f*
  - cholecalciferol 469*f*
  - CoA 484*f*
  - collagen 721
  - compound lipids 191
  - deoxythymine nucleotides 571
  - ferritin and transferrin receptor 516
  - gangliosides 193, 193*f*
  - glutathione 212
  - glycerophosphatides 191
  - glycosphingolipids 192
  - heme 212
  - leukotrienes 191*f*
  - melanin 233
  - mineralocorticoids 665*f*
  - nitric oxide 227
  - non-essential amino acids 30, 201
  - phosphatidylcholine 191, 191*f*
  - phosphatidylinositol 191
  - pregnenolone 664*f*
  - purines 212
  - pyrimidine nucleotides 570*f*
  - secretory proteins 605*f*
  - sex hormones 666*f*
  - sphingolipids 192
  - sphingomyelin 192
  - steroid hormones 664
  - structural and functional
    - proteins 196
  - sulfatides 193
  - thymidylic acid 208*f*
  - thyroid hormones 236
  - triacylglycerols 160
  - triphosphates 569
- Systemic lupus erythomatosus 375
- T**
- Tamoxifen 670
- Tandem mass spectrometry 458, 458*f*
- Tangier disease 342
- Tartaric acid 306
- Tartrate resistant acid phosphatase 510
- Tarui's disease 144
- Tata-binding protein 590
- Tau protein 728, 729, 745
- Tay-Sach's disease 193, 194, 430
- Tendinous xanthomata 342
- Testicular hormones 670
- Testosterone 669, 670
- Tetracycline 412, 605
  - resistance gene 627
- Tetrahydrobiopterine 227*f*, 232
- Tetrahydrofolic acid 207*f*, 501, 572*f*
- Thalassemia 290, 293, 294*f*, 518
  - syndromes 294
- Therapeutic
  - potential of arginine 227
  - use of
    - enzymes 308*t*
    - niacin 482
    - vitamin A 469
    - vitamin C 499
- Thermogenesis 162, 674
- Thiamine 115, 230, 477, 486, 560
  - deficiency 134
  - pyrophosphate 50, 115, 130, 477
- Thiazide 363
- Thin layer chromatography 449, 450*f*
- Thioredoxin reductase 214, 571*f*
- Threonine 26, 27, 210, 450, 451
- Thrombin 385
- Thrombopoietin 745
- Thrombosis 221, 335
- Thromboxane 188, 190, 190*t*
- Thymine 477, 560
- Thyroid
  - cancer 716, 737
  - function tests 674
  - hormones 528, 672, 674
  - scanning 736
  - stimulating hormone 662
- Thyrotoxicosis 508, 512
- Thyroxine synthesis 673*f*
- Tissue
  - of origin 303, 669
  - polypeptide antigen 715
- Titration curve of glycine 28*f*
- Total
  - iron binding capacity 516, 519, 524, 525
  - parenteral nutrition 541
- Toxic
  - exposure 354
  - hepatitis 349
- Toxicity of
  - folic acid 491
  - niacin 482
  - vitamin
    - B<sub>6</sub> 484
    - C 499
- Trait of disease 609
- Transamination 30, 201, 483
  - of alanine 119*f*
  - reaction 29*f*
- Transfatty acids 15, 86, 341, 532
- Transfer RNA 588, 596
  - carrying serine 597*f*
  - general structure 597*f*
- Transferrin receptor protein 525
- Transformation of cells in
  - tissue culture 712*f*
- Transforming growth factor 745
- Transient glucosuria 317
- Transketolase reaction 130
- Transmembrane proteins 16
- Transmethylation 30
  - reactions 489*f*
- Transmissible spongiform
  - encephalopathies 728
- Transport
  - chain 255
  - of amino acids 219
  - of carbon dioxide 287
  - of cholesterol 335*f*
  - of glucose 320
  - of thyroid hormones 674
  - proteins 39, 382
- Transportation of ammonia 203
- Trapping of ammonia 203
- Treatment of
  - adenocarcinoma of
    - colon and breast 716
  - hemosiderosis 520

- hyocalcemia 509
  - hyperkalemia 416
  - hypokalemia 415
  - iron deficiency 519
  - lead poisoning 552
  - metabolic acidosis 402
  - obesity 536
  - protein-energy malnutrition 535
  - Triacylglycerol synthesis 160
  - Tricarboxylic acid cycle 249*f*
  - Triglyceride 87*f*
  - Tripeptidases 198
  - Triple
    - stranded collagen fiber 721*f*
    - stranded helix 721
  - Tropical splenomegaly syndrome 375
  - Trousseau's sign 508, 509, 524
  - Tryptophan 26, 27, 29, 207, 232, 239, 450, 451
    - hydroxylase 240, 258
    - metabolism 497
    - pyrrolase 64, 240, 258, 270
  - Tubeless gastric analysis 357
  - Tuberculosis 326, 508, 700
  - Tuberculous meningitis 422
  - Tuberous xanthomata 342
  - Tubular
    - dysfunction 374
    - maximum 362, 374
    - proteinuria 372
    - reabsorption of phosphate test 508
  - Tubules handle substances
    - differently 366*f*
  - Tumor
    - cell destruction 686
    - index substances 713
    - marker 306, 308, 506, 713, 715
    - metastasis 722
    - necrosis factor 695
      - alpha 696
      - beta 696
    - receptor 746
    - of bile duct 349
    - of bladder 370
    - Turner syndrome 324
    - Types of
      - acid-base disturbances 398*t*
      - bilirubin 349
      - bond 547
      - calcium channels 503*f*
      - jaundice 349
      - lactic acidosis 400
      - metabolic pathways 99
      - radiation 734
      - rickets 472
      - transport
        - mechanisms 21*t*
        - systems 21*f*
      - tumor produced 708
    - Tyrosinase 234, 238
    - Tyrosine 26, 29, 232, 233, 450, 451
      - hydroxylase 234, 258
    - Tyrosinemia 239
- U**
- Unconjugated bilirubin 139, 280, 350
  - Uncouplers of oxidative phosphorylation 265
  - Uniport system 21, 106
  - Units of chondroitin sulfate 80*f*
  - Unsaturated fatty acids 85
  - Upper part of jejunum 488
  - Urea
    - clearance test 369
    - cycle 196, 203, 226
    - disorders 206*t*, 428
    - enzyme 571
  - Uremic syndrome 370
  - Uric acid 363, 565, 566, 567
  - Uridine diphosphate 142
  - Urinary
    - acidification 373
    - bilirubin 349
    - buffer 396
    - calculi 468
    - excretion 366
      - of porphyrins 276*t*
    - free cortisol 668
    - hydroxyproline excretion 510
    - osmolality 373
    - steroids 666, 667
    - urobilinogen 350
  - Urine
    - appearance 364*t*
    - bile salts 350
    - collection 442
    - excretion 366
      - of alkaptonuria 238*f*
  - Urobilinogen 349, 350, 365
  - Urocanic aciduria 244
  - Urogenic proteinuria 372
  - Uronic acid 74
  - Use of radioisotope tracers 98
  - Utilization of glucose 210, 321
- V**
- Valinomycin 19, 23, 265
  - Van Den Bergh
    - direct test 350
    - indirect test 350
    - reaction 349
    - test 279
  - Van Der Waals forces 6
  - Vanillyl Mandelic acid 236, 246
  - Vascular
    - cell adhesion molecule 746
    - diseases 328
    - endothelial growth factor 746
    - occlusion in sickle cell anemia 291*f*
  - Ventromedial nucleus 660
  - Verner-Morrison syndrome 681
  - Very
    - long chain fatty acids 184, 186
    - low density lipoproteins 173, 176
  - Vibrio cholerae 653
  - Vinyl phenols 553

- Viral  
  hepatitis 349, 351  
  infection 422
- Virus 144, 620, 708  
  carrying gene 710
- Visualization of  
  chromatography 449  
  protein bands 447
- Vitamin  
  A 464, 465*f*, 507, 707, 758  
  deficiency 468  
  B<sub>12</sub> 217, 488, 491  
  B<sub>6</sub> deficiency 240  
  C 317, 438, 495, 497, 509, 519, 707  
  deficiency 244  
  D 469, 505, 507  
  and absorption of calcium  
    471, 505  
  and bone 505  
  and innate immunity 472  
  and metabolic syndrome 473  
  and renal tubules 505  
  deficiency 471, 472, 512  
  resistant rickets 21  
  E 163, 438, 340, 473, 707  
  K 474, 474*f*  
  cycle 475*f*  
  deficiency 352  
  dependent carboxylase 475  
  reductase 475*f*
- Volatile acids 393
- Voltage dependent anion channel 268
- Vomiting 412
- Von Gierke's disease 128, 136, 144,  
  331, 365, 430, 567
- **W**
- Wald's visual cycle 465*f*
- Waldenstrom's macroglobulinemia  
  375, 690
- Warburg's hypothesis 114, 712
- Water soluble vitamins 463
- Watson-Crick model of  
  DNA structure 575
- Weak and strong acids 391
- Wernick's disease 141
- Westergard multirule chart 444
- Western blot 700  
  analysis for proteins 634
- Wet beriberi 478
- Whipple's disease 242
- White adipose tissue 162
- WHO classification of  
  malnutrition 535*t*
- Williams-Beuren syndrome 723
- Wilson's  
  disease 353, 355, 384, 430, 521  
  hepatolenticular degeneration 352
- Wobbling phenomenon 599
- Wolman's disease 344
- **X**
- Xanthaslasma 342
- Xanthine 560  
  oxidase 434, 436  
  deficiency 569
- Xanthomas 342
- Xanthoproteic test 31
- Xanthosine monophosphate 564
- Xanthurenic  
  acid 240  
  aciduria 483
- Xeroderma pigmentosum 584, 585
- Xerophthalmia 467
- X-linked  
  adrenoleukodystrophy 23  
  recessive 133
- Xylitol dehydrogenase 135
- **Y**
- Y-linked inheritance 610
- **Z**
- Zanamavir 621
- Zellweger syndrome 13, 156, 185,  
  186, 603
- Zidovudine 621
- Zimmerman reaction 666
- Zinc 51, 522  
  chloride 550  
  deficiency manifestations 522  
  toxicity 522
- Zollinger-Ellison  
  syndrome 357, 681



