

**PERSPECTIVES IN MATHEMATICS, Vol. 7**

J. Coates and S. Helgason, editors

# **/Lectures on Buildings/**

Mark Ronan

*Department of Mathematics  
The University of Illinois at Chicago  
Chicago, Illinois*



ACADEMIC PRESS, INC.  
*Harcourt Brace Jovanovich, Publishers*

Boston San Diego New York  
Berkeley London Sydney  
Tokyo Toronto

Copyright © 1989 by Academic Press, Inc.

All rights reserved.

No part of this publication may be reproduced or transmitted in any form or by any means, electronic or mechanical, including photocopy, recording, or any information storage and retrieval system, without permission in writing from the publisher.

ACADEMIC PRESS, INC.

1250 Sixth Avenue, San Diego, CA 92101

*United Kingdom Edition published by*

ACADEMIC PRESS INC. (LONDON) LTD.

24-28 Oval Road, London NW1 7DX

Library of Congress Cataloging-in-Publication Data

Ronan, Mark.

Lectures on buildings.

(Perspectives in mathematics; vol. 7)

Bibliography: p.

1. Finite groups. 2. Finite geometries. I. Title.

II. Series.

QA171.R635 1989 512'.22 88-35137

ISBN 0-12-594750-X

Printed in the United States of America

89 90 91 92 9 8 7 6 5 4 3 2 1

*To  
Piers and Tamsin*



## CONTENTS

Introduction	xi
Leitfaden	xiii
Chapter 1 - CHAMBER SYSTEMS AND EXAMPLES	
1. Chamber Systems	1
2. Two Examples of Buildings	4
Exercises	7
Chapter 2 - COXETER COMPLEXES	
1. Coxeter Groups and Complexes	9
2. Words and Galleries	12
3. Reduced Words and Homotopy	17
4. Finite Coxeter Complexes	19
5. Self-Homotopy	22
Exercises	24
Chapter 3 - BUILDINGS	
1. A Definition of Buildings	27
2. Generalised $m$ -gons - the rank 2 case	28
3. Residues and Apartments	30
Exercises	35
Chapter 4 - LOCAL PROPERTIES AND COVERINGS	
1. Chamber Systems of Type $M$	39
2. Coverings and the Fundamental Group	41
3. The Universal Cover	44
4. Examples	47
Exercises	51
Chapter 5 - BN - PAIRS	
1. Tits Systems and Buildings	55
2. Parabolic Subgroups	59
Exercises	61

## Chapter 6 - BUILDINGS OF SPHERICAL TYPE AND ROOT GROUPS

1. Some Basic Lemmas	63
2. Root Groups and the Moufang Property	66
3. Commutator Relations	68
4. Moufang Buildings - the general case	73
Exercises	80

## Chapter 7 - A CONSTRUCTION OF BUILDINGS

1. Blueprints	83
2. Natural Labellings of Moufang Buildings	86
3. Foundations	89
Exercises	91

## Chapter 8 - THE CLASSIFICATION OF SPHERICAL BUILDINGS

1. $A_3$ Blueprints and Foundations	92
2. Diagrams with Single Bonds	95
3. $C_3$ Foundations	97
4. $C_n$ Buildings for $n \geq 4$	98
5. Tits Diagrams and $F_4$ Buildings	100
6. Finite Buildings	106
Exercises	108

## Chapter 9 - AFFINE BUILDINGS I

1. Affine Coxeter Complexes and Sectors	110
2. The Affine Building $\tilde{A}_{n-1}(K, v)$	114
3. The Spherical Building at Infinity	120
4. The Proof of (9.5)	124
Exercises	127

## Chapter 10 - AFFINE BUILDINGS II

1. Apartment Systems, Trees and Projective Valuations	129
2. Trees associated to Walls and Panels at Infinity	133
3. Root Groups with a Valuation	138
4. Construction of an Affine BN-Pair	144
5. The Classification	152
6. An Application	157
Exercises	160

Appendix 1 - MOUFANG POLYGONS	
1. The $m$ -function	162
2. The Natural Labelling for a Moufang Plane	166
3. The Non-existence Theorem	169
Appendix 2 - DIAGRAMS FOR MOUFANG POLYGONS	175
Appendix 3 - NON-DISCRETE BUILDINGS	180
Appendix 4 - TOPOLOGY AND THE STEINBERG REPRESENTATION	184
Appendix 5 - FINITE COXETER GROUPS	190
Appendix 6 - FINITE BUILDINGS AND GROUPS OF LIE TYPE	191
BIBLIOGRAPHY	194
INDEX OF NOTATION	198
INDEX	199





## INTRODUCTION

The genesis of this book was a set of notes taken by students who attended a course of fifteen 2 hour lectures in the University of London at Queen Mary College in 1986/87. After rewriting these notes, I used them in Chicago at the University of Illinois in 1987/88, in a slightly longer course comprising twenty 2 hour lectures. The subsequent expansion and revision of the notes is what appears here, though the appendices largely contain material not covered in the courses. As to the overall structure, the first five chapters deal with the general theory, while Chapters 6-10 cover important special cases. Chapters 2 and 3 are essential to most of what follows, but after that one can be a little more selective. For example a reader wishing to learn about affine buildings and their groups could omit most of Chapters 4, 7 and 8. The Leitfaden which follows gives some idea of the interdependence of the chapters.

A historical account of the origin of buildings is contained in the introduction to the book on spherical buildings by Tits [1974], and I quote, "The origin of the notions of buildings and BN-Pairs lies in an attempt to give a systematic procedure for the geometric interpretation of the semi-simple Lie groups and, in particular, the exceptional groups." Not only has this attempt succeeded, but the theory has been developed far beyond that point, largely by Tits. The term "building", incidentally, is due to Bourbaki.

The buildings for semi-simple Lie groups, and their analogues over arbitrary fields, are of spherical type. Work of Iwahori and Matsumoto [1965] on  $p$ -adic groups then led to affine buildings, and the general theory of such buildings, and their groups, has been developed by Bruhat and Tits [1972] and [1984]. Later, Moody and Teo [1972] used Kac-Moody Lie algebras to produce a new class of groups having a BN-Pair, and therefore provided new buildings, of "Kac-Moody type". There is now a class of "Moufang buildings" (Tits [1986], and Chapter 6 section 4) which includes

all spherical buildings (having rank  $\geq 3$  and a connected diagram), and all buildings of “Kac-Moody type”; these include some, but not all, affine buildings (e.g. not the  $p$ -adic ones). Moreover these buildings can be constructed independently of the groups (Ronan-Tits [1987], and Chapter 7). There may yet be further interesting classes of buildings, with interesting groups, waiting to be discovered, but certainly the theory has now moved a long way beyond the study of spherical buildings. In fact, affine buildings have been particularly important; they are used for example by Macdonald [1971] in the study of spherical functions on  $p$ -adic groups, by Borel-Serre [1976] and Serre [1977/80] in studying arithmetic groups, and by Quillen (see Grayson [1982]) to prove that the  $K$ -groups of a curve are finitely generated - see Ronan [1989] for further references.

Finally my thanks are due to all who helped bring this project to fruition: to W.M. Kantor for his excellent lectures on the subject 12 years ago, and his helpful comments on this text; to P. Johnson and S. Yoshiara for very helpful and detailed comments; to J. Tits for some important remarks and suggestions; to Mrs. Ann Cook for typing the first version, and to Ms. Shirley Roper for typesetting the final version. Needless to say the project would never have got underway without the interest of those who attended my lectures in London, and in Chicago: my thanks to all of them and in particular L. Halpenny, M. Iano, M. Mowbray, C. Murgatroyd and M. Whelan who originally took notes in London.

Chicago, September 1988

# LEITFADEN

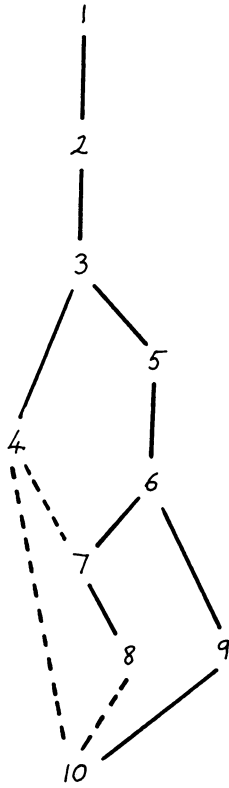



## Chapter 1

### CHAMBER SYSTEMS AND EXAMPLES

This chapter introduces chamber systems, and a “geometric realisation” which exists in the finite rank case. The examples include two different families of buildings.

#### 1. Chamber Systems.

A set  $C$  is a *chamber system* over a set  $I$  if each element  $i$  of  $I$  determines a partition of  $C$ , two elements in the same part being called  *$i$ -adjacent*. The elements of  $C$  are called *chambers*, and if two chambers  $x$  and  $y$  are  $i$ -adjacent we shall often write  $x \underset{i}{\sim} y$ . If  $I$  is a finite set having  $n$  elements (as in most of the cases we consider) then, as explained below,  $C$  has a “geometric realisation” in which chambers are simplexes of dimension  $n - 1$ , and are adjacent if they share a face of dimension  $n - 2$ .

**Example 1.** Let  $G$  be a group,  $B$  a subgroup, and for each  $i \in I$  let there be a subgroup  $P_i$  with  $B < P_i < G$ . Take as chambers the left cosets of  $B$ , and set

$$gB \underset{i}{\sim} hB \text{ if and only if } gP_i = hP_i.$$

The fundamental nature of this example is exhibited in Exercise 2.

**Example 2.** In the example above let  $G$  be given by generators and relations as  $\langle r_i | r_i^2 = (r_i r_j)^{m_{ij}} = 1, \forall i, j \in I \rangle$ . Set  $B = 1, P_i = \langle r_i \rangle$ . This is a *Coxeter system* and  $G$  is called a *Coxeter group*; the next chapter is devoted to the study of such systems.

**Further Notation.** A *gallery* is a finite sequence of chambers  $(c_0, \dots, c_k)$  such that  $c_{j-1}$  is adjacent to  $c_j$  for each  $1 \leq j \leq k$ ; and we shall always assume  $c_{j-1} \neq c_j$ . The gallery is said to have *type*  $i_1 i_2 \dots i_k$  (a word in the

free monoid on  $I$ ) if  $c_{j-1}$  is  $i_j$ -adjacent to  $c_j$  (there may in general be more than one possible type, though this is not the case for buildings). If each  $i_j$  belongs to some given subset  $J$  of  $I$ , then we call it a  $J$ -gallery.

We call  $C$  *connected* (or  $J$ -*connected*) if any two chambers can be joined by a gallery (or  $J$ -gallery). The  $J$ -connected components are called *residues of type  $J$* , or simply  $J$ -*residues*.

In Example 1, for which chambers are left cosets  $gB$ , the  $J$ -residues correspond to left cosets  $gP_J$  where  $P_J = \langle P_j | j \in J \rangle$ .

Notice that every  $J$ -residue is a connected chamber system over the set  $J$ . The *rank* of a chamber system over  $I$  is the cardinality of  $I$ ; the residues of rank 1 are called *panels*, or  $i$ -*panels* if of type  $\{i\}$ , and those of rank 0 (type  $\emptyset$ ) are simply the chambers.

A *morphism*  $\phi : C \rightarrow D$  between two chamber systems over the same indexing set  $I$  will mean a map defined on the chambers and preserving  $i$ -adjacency for each  $i \in I$  (thus if  $x, y \in C$  are  $i$ -adjacent then  $\phi(x)$  and  $\phi(y)$  are too); the terms *isomorphism* and *automorphism* have the obvious meaning. In Example 1 the group  $G$  acts by left multiplication as a group of automorphisms.

Given chamber systems  $C_1, \dots, C_k$  over  $I_1, \dots, I_k$ , their *direct product*  $C_1 \times \dots \times C_k$  is a chamber system over the disjoint union  $I_1 \cup \dots \cup I_k$ . Its *chambers* are all  $k$ -tuples  $(c_1, \dots, c_k)$  where  $c_i \in C_i$ , and  $(c_1, \dots, c_k)$  is  $i$ -*adjacent* to  $(d_1, \dots, d_k)$  for  $i \in I_i$  if  $c_j = d_j$  for  $j \neq i$  and  $c_i \sim_i d_i$  in  $C_i$ .

### The Geometric Realisation.

Given residues  $R$  and  $S$  of types  $J$  and  $K$  respectively we say  $S$  is a *face* of  $R$  if  $S \supset R$  and  $K \supset J$ . If we let *cotype  $J$*  mean type  $I - J$ , then given any residue  $R$  of cotype  $J$  the following two observations are immediate:

- (i) for each  $K \subset J$ ,  $R$  has a unique face of cotype  $K$ .
- (ii) If  $S_1, S_2$  are faces of  $R$  of cotypes  $K_1$  and  $K_2$  then  $S_1$  and  $S_2$  have the same face of cotype  $K_1 \cap K_2$ .

We now recall the standard notion of a *simplex*: a 0-simplex is a point, a 1-simplex is a line segment, a 2-simplex is a triangle with interior, etc. More generally an  $n$ -simplex is a convex portion of  $\mathbf{R}^n$  spanned by  $n + 1$  vertices, and each subset of these vertices spans a *face* of the simplex. The observations above suggest that if  $I$  is finite then to each residue  $R$  of cotype  $J$  we could associate a simplex (having  $|J|$  vertices) and its faces, and then glue these simplexes together to form a topological space. We do

this as follows.

Associate to each residue of corank 1 (cotype  $\{i\}$  for some  $i \in I$ ) a vertex; then associate to each residue  $R$  of cotype  $\{i, j\}$  an edge (1-simplex), identifying its boundary with the vertices corresponding to the faces of  $R$ . Continue inductively, associating to each residue  $R$  of cotype  $\{i_1, \dots, i_r\}$  a simplex  $\sigma$  of dimension  $r - 1$  ( $r$  vertices), and identifying the faces of  $\sigma$  with the simplexes already associated to the faces of  $R$ . The resulting structure, in which each simplex is assigned the type of the corresponding residue, will be called the *geometric realisation* (or the *cell complex*) of  $C$ .

If  $\sigma$  is a simplex, we let  $St(\sigma)$  ( $St$  for "star") denote the corresponding residue. If each simplex is uniquely determined by its set of vertices one has a simplicial complex, but as Example 3 shows that is not necessarily the case. For buildings however, the geometric realisation is always a simplicial complex (Exercise 11 of Chapter 3). Notice that a chamber system of finite rank can be recovered immediately from its geometric realisation, by taking the chambers to be simplexes of maximal dimension, and  $i$ -adjacency to be sharing a face of type  $i$ .

**Example 3.** Let  $C = \{x, y\}$ ,  $I = \{1, 2, 3\}$ , and suppose  $x$  and  $y$  are 1, 2 and 3-adjacent. Then both  $x$  and  $y$  become 2-simplexes, and they share all three of their edges. Topologically speaking this is a 2-sphere; see Figure 1.1.

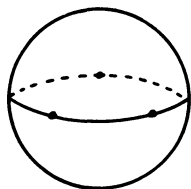

Figure 1.1

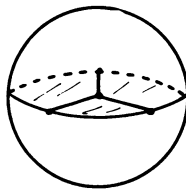

Figure 1.2

If in this example we introduce 4-adjacency, with  $x$  and  $y$  not 4-adjacent, then  $x$  and  $y$  become 3-simplexes sharing three common triangular faces, and topologically speaking we have a 3-ball, as in Figure 1.2.



## 2. Two Examples of Buildings.

Buildings will be defined in Chapter 3. Here we just give two families of examples.

**Example 4.** The  $A_n(k)$  building  $\Delta$ .

Let  $V$  be an  $n+1$  dimensional vector space over a field  $k$ , not necessarily commutative. The *chambers* of  $\Delta$  are the maximal nested sequences of subspaces

$$V_1 \subset V_2 \subset \dots \subset V_n$$

where  $V_i$  denotes a subspace of dimension  $i$ . Two chambers  $V_1 \subset \dots \subset V_n$  and  $V'_1 \subset \dots \subset V'_n$  are  *$i$ -adjacent* if  $V_j = V'_j$  for all  $j \neq i$ . This gives a chamber system over  $I = \{1, \dots, n\}$ . Notice that a residue of type  $i$  corresponds to the set of 1-spaces in a 2-space  $V_{i+1}/V_{i-1}$ , or in other words to the points of the projective line over  $k$ .

We now consider the geometric realisation of  $\Delta$ . If  $J = \{i_1, \dots, i_r\} \subset I$ , the reader should check that a residue of *cotype*  $J$  (not *type*  $J$ ) corresponds to a nested sequence of subspaces (usually called a *flag*)

$$V_{i_1} \subset \dots \subset V_{i_r}. \quad (*)$$

Its chambers are those maximal flags  $V'_1 \subset \dots \subset V'_n$  where  $V'_j = V_j$  for  $j \in J$ . In particular the residues of cotype  $i$  correspond to the  $i$ -dimensional subspaces of  $V$ ; these are the vertices of the geometric realisation. The simplexes of dimension  $(r-1)$  are those flags such as (\*) above; in particular two simplexes are the same if and only if they have the same set of vertices (so we have a simplicial complex, unlike Example 3 above). Figure 1.3 shows the geometric realisation of the  $A_2(k)$  building when  $k$  is the field of two elements.

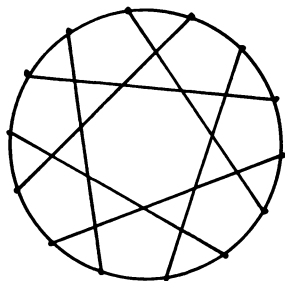
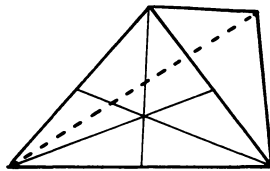

Figure 1.3

**$A_n$  Apartments.** An important subcomplex of this building, called an *apartment*, is obtained as follows. Fix a basis  $v_1, \dots, v_{n+1}$  of  $V$ , and take every subspace spanned by a proper subset of this basis, and all nested sequences of such subspaces. The chambers of the apartment are thus all

$$\langle v_{\sigma(1)} \rangle \subset \langle v_{\sigma(1)}, v_{\sigma(2)} \rangle \subset \dots \subset \langle v_{\sigma(1)}, \dots, v_{\sigma(n)} \rangle$$

where  $\sigma$  ranges through all permutations of  $1, \dots, n+1$ . Evidently the symmetric group  $S_{n+1}$  acts simple-transitively on the set of  $(n+1)!$  chambers of this apartment. The reader should note that every panel of this apartment is a face of exactly two chambers of the apartment. If  $n=2$  an apartment contains six chambers arranged in a circuit; in Figure 1.3 there are 28 apartments. In Figure 1.4 we show an  $A_3$  apartment; it has 24 chambers, 6 on each face of the tetrahedron. For any  $n$  the  $A_n$  apartment is the barycentric subdivision of the boundary of an  $n$ -simplex (in particular it is a triangulation of an  $(n-1)$ -sphere).



24 chambers - 6 on each face of the tetrahedron.

Figure 1.4

**Example 5.**  $C_n(k)$ .

Let  $V$  be a  $2n$ -dimensional vector space over a commutative field  $k$ , endowed with a symplectic form (i.e. a non-degenerate, alternating, bilinear form). Such a form can be defined on a basis  $x_1, \dots, x_n, y_1, \dots, y_n$  via:

$$(x_i, y_j) = \delta_{ij} = -(y_j, x_i)$$

$$(x_i, x_j) = 0 = (y_i, y_j).$$

A subspace  $S$  is called *totally isotropic* (t.i.) if  $(v, w) = 0$  for all  $v, w \in S$ ; for example  $\langle x_1, y_2, y_3 \rangle$ . Notice that all 1-spaces are t.i., and

that all maximal t.i. subspaces have dimension  $n$  (see Exercise 5). Let  $I = \{1, \dots, n\}$  and for each  $i \in I$  let  $S_i$  denote a t.i. subspace of dimension  $i$ .

A maximal nested sequence

$$S_1 \subset S_2 \subset \dots \subset S_n$$

of t.i. subspaces is called a *chamber*. As in the previous Example, two chambers  $S_1 \subset \dots \subset S_n$  and  $S'_1 \subset \dots \subset S'_n$  are said to be *i-adjacent* if  $S_j = S'_j$  for all  $j \neq i$ . This is the building  $C_n(k)$  as a chamber system. As in Example 4, its geometric realisation is obtained by taking the t.i. subspaces as vertices, and taking all t.i. flags as simplexes.

Given the basis  $x_1, \dots, x_n, y_1, \dots, y_n$  above, we obtain an *apartment* by taking every t.i. subspace spanned by a subset of this basis, and all nested sequences of such subspaces. The chambers of this apartment are thus all

$$\langle v_{\sigma(1)} \rangle \subset \langle v_{\sigma(1)}, v_{\sigma(2)} \rangle \subset \dots \subset \langle v_{\sigma(1)}, \dots, v_{\sigma(n)} \rangle$$

where  $v_j$  is either  $x_j$  or  $y_j$ , and  $\sigma$  ranges through all permutations of  $1, \dots, n$ . Its automorphism group is the semi-direct product  $2^n S_n$  which acts simple-transitively on the set of  $2^n n!$  chambers. Its geometric realisation is isomorphic to the barycentric subdivision of the boundary of a cross-polytope (i.e. the convex polytope whose vertices are precisely the  $2n$  unit vectors on the coordinate axes of Euclidean  $n$ -space); for  $n = 3$  the cross-polytope is the octahedron (Figure 1.5).

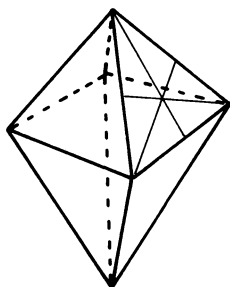

$n = 3$   
48 chambers - six on each  
face of the octahedron.

Figure 1.5

**Notes.** Chamber systems were introduced by Tits [1981] in “A Local Approach to Buildings”, a paper whose main results will be dealt with in Chapter 4. Although Examples 4 and 5 are usually thought of as simplicial complexes, it is not always desirable or appropriate to think of a building in that way (cf. Appendix 4) and for this reason, and also for the results of Chapter 4, the chamber system formalism seems to be a good way of doing things.

### Exercises to Chapter 1

1. Show that the chamber system of Example 1 is connected if and only if  $G = \langle P_i | i \in I \rangle$ .
2. Let  $C$  be a chamber system admitting  $G$  as a group of automorphisms (i.e. preserving  $i$ -adjacency for each  $i \in I$ ) acting transitively on the set of chambers. Given some chamber  $c \in C$ , let  $B$  denote its stabilizer in  $G$ , and let  $P_i$  denote the stabilizer of the  $i$ -panel on  $c$ . Show that  $C$  is the chamber system given by cosets of  $B$  and the  $P_i$  as in Example 1.
3. Let  $C$  be the direct product  $C_1 \times \dots \times C_k$  where  $C_i$  is a chamber system over  $I_i$ . Let  $x$  and  $y$  be  $i$ -adjacent chambers of  $C$ , and let  $X$  and  $Y$  be the  $I_i$ -residues containing  $x$  and  $y$ , where  $i \notin I_i$ . Show that each chamber of  $X$  is  $i$ -adjacent to a unique chamber of  $Y$ , and  $i$ -adjacency gives an isomorphism between  $X$  and  $Y$ .
4. In Example 4, the group  $GL_{n+1}(k)$  acts on  $V$  and hence on the building  $A_n(k)$ ; check that this action preserves  $i$ -adjacency for each  $i$ .
  - (i) Show that the stabilizer of a chamber is the subgroup of upper triangular matrices using a suitable ordered basis.
  - (ii) Show that any two chambers lie in a common apartment.
  - (iii) Show that the subgroup fixing all the chambers of an apartment is the group of diagonal matrices corresponding to a suitable basis.
5. Let  $V$  be the  $2n$  dimensional vector space of Example 5 having a non-degenerate, alternating, bilinear form. For any subspace  $W$ , let  $W^\perp = \{v \in V | (v, w) = 0 \ \forall w \in W\}$ . Show that

$$\dim W + \dim W^\perp = 2n$$

and conclude that all maximal t.i. subspaces have dimension  $n$ .

6. Let  $G = S_3$ ,  $B = 1$ , and  $P_1, P_2, P_3$  the three subgroups of order 2; this defines a chamber system as in Example 1. Its geometric realisation  $C$  has three vertices (one of each type) on each of which the six chambers (2-simplexes) are arranged in a circuit. Thus  $C$  is a 2-manifold; its Euler characteristic is  $3 - 9 + 6 = 0$  (there being three panels of each type), and so  $C$  is either a torus or a Klein bottle. Which is it?

## Chapter 2

### COXETER COMPLEXES

In this chapter we shall study Coxeter complexes and Coxeter groups. The material here is essential to everything that follows, though only the first three sections will be used in Chapter 3.

#### 1. Coxeter Groups and Complexes.

Let  $I$  be a set, and for any  $i, j \in I$  let  $m_{ij} \in \mathbf{Z} \cup \{\infty\}$  with  $m_{ij} = m_{ji} \geq 2$  if  $i \neq j$ , and  $m_{ii} = 1$ . The set of such  $m_{ij}$  will be denoted by the symbol  $M$ . We shall represent  $M$  by its *diagram*: the nodes of the diagram are the elements of  $I$  (sometimes labelled as such), and between two nodes there is a bond according to the following rule.

$$\begin{array}{ccc}
 i & & j \\
 \circ & & \circ \text{ no bond if } m_{ij} = 2 \\
 \\ 
 \circ \text{-----} \circ & \text{if } m_{ij} = 3 \\
 \\ 
 \circ \text{=====} \circ & \text{if } m_{ij} = 4 \\
 \\ 
 \circ \text{-----}^m \circ & \text{if } m_{ij} = m \geq 5
 \end{array}$$

For example the diagram

$$\begin{array}{ccc}
 1 & & 2 & & 3 \\
 \circ \text{-----} \circ \text{=====} \circ
 \end{array}$$

means that  $m_{12} = 3$ ,  $m_{13} = 2$ ,  $m_{23} = 4$ .

The *Coxeter group* of type  $M$  is the group  $W$  given by generators and relations as:

$$W = \langle r_i \mid r_i^2 = (r_i r_j)^{m_{ij}} = 1 \text{ for all } i, j \in I \rangle.$$

For any subset  $J$  of  $I$  we let  $W_J$  denote the subgroup of  $W$  generated by all  $r_j$  for  $j \in J$ .

(2.1) LEMMA. (i) The element  $r_i r_j$  in  $W$  has order  $m_{ij}$ .

(ii) If  $r_i \in W_J$ , then  $i \in J$ .

PROOF: (i) Take a real vector space  $V$  having basis  $\{e_i | i \in I\}$  indexed by  $I$ , and define a symmetric bilinear form on  $V$  via

$$(e_i, e_j) = -\cos \frac{\pi}{m_{ij}}$$

In particular  $(e_i, e_i) = 1$ , and if  $m_{ij} = \infty$ , then  $(e_i, e_j) = -1$ . Now for each  $i \in I$ , let  $s_i$  be the linear transformation defined by

$$s_i(v) = v - 2(v, e_i)e_i, \text{ for all } v \in V;$$

and let  $G$  be the subgroup of  $GL(V)$  generated by the  $s_i$ . Let  $V_{ij}$  denote the subspace of  $V$  spanned by  $e_i$  and  $e_j$ , and let  $V_{ij}^\perp$  denote its orthogonal complement. It is straightforward to check that on  $V_{ij}$  the element  $s_i s_j$  has order  $m_{ij}$  (see Exercise 1), and on  $V_{ij}^\perp$  it is the identity. If  $m_{ij} = \infty$ , this shows  $s_i s_j$  has infinite order on  $V$ . If  $m_{ij} \neq \infty$ , then  $V = V_{ij} + V_{ij}^\perp$  (Exercise 1), so  $s_i s_j$  has order  $m_{ij}$  on  $V$ . This shows that the map  $r_i \rightarrow s_i$  extends to a homomorphism of  $W$  onto  $G$ , and therefore  $r_i r_j$  has order  $m_{ij}$  in  $W$ .

(ii) As  $j$  ranges over  $J$ , let  $V_J$  denote the subspace spanned by the  $e_j$ , and let  $G_J$  denote the subgroup of  $G$  spanned by the  $s_j$ . If  $r_i \in W_J$ , then  $s_i \in G_J$ , and hence  $s_i(v) \in v + V_J$ , for all  $v \in V$ . In particular  $-e_i = s_i(e_i) \in e_i + V_J$ , so  $e_i \in V_J$ , and therefore  $i \in J$ .  $\square$

**The Coxeter Complex.** Take the elements of  $W$  as chambers and for each  $i \in I$ , define  $i$ -adjacency by

$$w \underset{i}{\sim} wr_i.$$

This gives a chamber system over  $I$  (it is Example 2 in Chapter 1, section 1) and its cell complex is called the *Coxeter complex of type  $M$* ; since the  $r_i$  generate  $W$  it is connected. Notice that each rank 1 residue has exactly two chambers and, by Lemma (2.1), each  $\{i, j\}$ -residue has  $2m_{ij}$  chambers because  $r_i$  and  $r_j$  generate a dihedral group of that order. The cell complex of a rank 2 residue is thus a polygonal graph; one sometimes thinks of an  $\{i, j\}$ -residue as being the set of incident point-line pairs of an  $m_{ij}$ -gon, two such being  $i$ -adjacent (or  $j$ -adjacent) if they share a common point (or line) - indeed the dihedral group  $D_{2m}$  acts simple-transitively on the set of incident point-line pairs of a regular  $m$ -gon.

**Examples.** For the diagrams  $A_3(\circ\text{---}\circ\text{---}\circ)$  and  $C_3(\circ\text{---}\circ\text{---}\circ)$  the cell complex is a triangulation of the 2-sphere, illustrated in Chapter 1 (Figures 1.4 and 1.5). Here are two further examples: the chambers are triangles, and the three types of adjacency are illustrated by the different types of edges.

**Diagram  $\tilde{A}_2$ .**

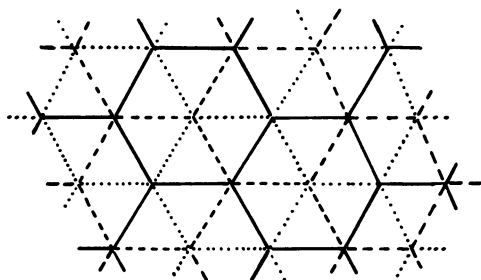

Figure 2.1

**Diagram  $\tilde{C}_2$ .**  $\circ\text{---}\circ\text{---}\circ$

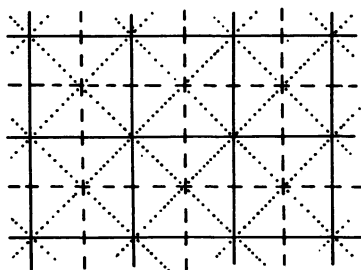

Figure 2.2

Throughout these notes we shall use  $W$  to denote both the Coxeter group, and the Coxeter complex. As in Chapter 1, an *automorphism* of a chamber system is a bijective map on the set of chambers preserving  $i$ -adjacency for each  $i$ . A group action on a set  $X$  is called *simple-transitive* if it is transitive and the stabilizer of  $x \in X$  is the identity.



(2.2) LEMMA. *The automorphism group of the Coxeter Complex is the Coxeter group, and it acts simple-transitively on the set of chambers.*

PROOF: Clearly the action of  $W$  on itself by left multiplication preserves  $i$ -adjacency. On the other hand if we fix one chamber we fix all chambers adjacent to it because each rank 1 residue has exactly two chambers. By connectivity we therefore fix all chambers, and simple-transitivity follows.  $\square$

## 2. Words and Galleries.

Given a word  $f = i_1 \dots i_k$  in the free monoid on  $I$ , we set  $r_f = r_{i_1} \dots r_{i_k} \in W$ ; if  $\emptyset$  denotes the null word,  $r_\emptyset = 1$ . Given  $x, y \in W$ , notice that there is a gallery of type  $f$  from  $x$  to  $y$  if and only if  $y$  can be written as  $xr_f$  (the gallery being  $(x, xr_{i_1}, xr_{i_1}r_{i_2}, \dots)$ ), or equivalently  $x^{-1}y = r_f$ . For distinct  $i, j \in I$  with  $m_{ij}$  finite, we write  $p(i, j)$  to mean  $\dots ijij$  ( $m_{ij}$  factors); e.g. if  $m_{ij} = 3$  then  $p(i, j) = jij$ .

An *elementary homotopy* is an alteration from a word of the form  $f_1p(i, j)f_2$  to the word  $f_1p(j, i)f_2$ . Two words are called *homotopic* if one can be transformed into the other by a sequence of elementary homotopies, and we write  $f \simeq g$  to mean  $f$  and  $g$  are homotopic. Notice that two homotopic words necessarily have the same length.

An *elementary contraction* (or *expansion*) is an alteration from a word of the form  $f_1iif_2$  to the word  $f_1f_2$  (or from  $f_1f_2$  to  $f_1iif_2$ ).

We now define two words to be *equivalent* if one can be transformed into the other by a sequence of elementary homotopies, expansions and contractions.

(2.3) LEMMA. *Two words  $f$  and  $g$  are equivalent if and only if  $r_f = r_g$ .*

PROOF: Since  $r_i^2 = 1$ , the relation  $(r_i r_j)^{m_{ij}} = 1$  is equivalent to the relation  $r_{p(i, j)} = r_{p(j, i)}$ , and so the result is immediate from the presentation of  $W$  in terms of generators and relations.  $\square$

A word is called *reduced* if it is not homotopic to a word of the form  $f_1iif_2$ . Notice that each equivalence class contains a reduced word. We will show later (2.11), that *if two reduced words are equivalent then they are homotopic*.

**Example.** Consider the diagram  $\tilde{A}_2$  (i.e.,  $m_{12} = m_{13} = m_{23} = 3$ ), as in the Examples above. Using the theorem (2.11) just alluded to, it

follows that the Coxeter group is infinite, because a word of the form  $1\ 2\ 3\ 1\ 2\ 3\ 1\ 2\ 3\ \dots$  is reduced, and such a word may be arbitrarily long.

A gallery  $(x = x_0, x_1, \dots, x_k = y)$  is said to have *length*  $k$ , and the *distance*  $d(x, y)$  between  $x$  and  $y$  is the least such  $k$ ; a gallery from  $x$  to  $y$  is called *minimal* if its length is  $d(x, y)$ . Given  $w \in W$  we define the *length* of  $w$  to be  $\ell(w) = d(1, w)$ , the length of a minimal gallery from  $1$  to  $w$ ; notice that  $d(x, y) = d(1, x^{-1}y) = \ell(x^{-1}y)$ .

(2.4) LEMMA. *If  $y'$  is adjacent to, and distinct from,  $y$ , then  $d(x, y') = d(x, y) \pm 1$ .*

PROOF: If  $f$  and  $g$  are the types of two galleries from  $x$  to some chamber  $z$ , then  $r_f = x^{-1}z = r_g$ , so by (2.3)  $f$  and  $g$  are equivalent, and hence both galleries have even length or both have odd length. Since a gallery of length  $k$  from  $x$  to  $y$  extends to one of length  $k + 1$  from  $x$  to  $y'$ , we see that  $d(x, y)$  and  $d(x, y')$  cannot both be even or both be odd. Therefore  $d(x, y) \neq d(x, y')$ , and the result follows.  $\square$

**Reflections and Walls.** A *reflection*  $r$  is by definition a conjugate of some  $r_i$ ; its *wall*  $M_r$  consists of all simplexes (of the Coxeter complex) fixed by  $r$  (acting on the left of course). A panel lies in  $M_r$  if and only if its two chambers are interchanged by  $r$ , and since the reflection  $r = wr_iw^{-1}$  interchanges the  $i$ -adjacent chambers  $w$  and  $wr_i$ ,  $M_r$  is a subcomplex of codimension 1.

Notice that if  $\pi$  is any  $i$ -panel and  $x$  is one of the two chambers on  $\pi$ , then  $xr_i$  is the other chamber on  $\pi$ , and  $r = xr_ix^{-1}$  is the unique reflection interchanging  $x$  and  $xr_i$ . Thus each panel lies on a unique wall, and there is a bijective correspondence between the set of walls and the set of reflections.

We shall say that a gallery  $(c_0, \dots, c_k)$  *crosses*  $M_r$  whenever  $r$  interchanges  $c_{i-1}$  with  $c_i$ , for some  $i$ ,  $1 \leq i \leq k$ . We will show that  $M_r$  splits  $W$  into two parts interchanged by  $r$ .

(2.5) LEMMA. (i) *A minimal gallery cannot cross a given wall twice.*  
(ii) *Given chambers  $x$  and  $y$ , the number of times mod 2 that a gallery from  $x$  to  $y$  crosses a given wall is independent of the gallery (i.e., it is either even for each gallery, or odd for each gallery).*

PROOF: (i) If a minimal gallery  $\gamma = (c_0, \dots, c_k)$  crosses  $M_r$  twice, at  $(i - 1, i)$  and  $(j - 1, j)$ , then the reflection  $r$  sends the subgallery  $(c_i, \dots, c_{j-1})$  to

a gallery of the same length from  $c_{i-1}$  to  $c_j$ . This contradicts the minimality of  $\gamma$ .

(ii) Given  $r_f = x^{-1}y$ , let  $n(f)$  be the number of times the gallery of type  $f$  from  $x$  to  $y$  crosses the wall  $M_r$ . If  $r_f = r_g$ , then by (2.3)  $f$  and  $g$  are equivalent. If they are equivalent via an elementary homotopy then  $n(f) = n(g)$ . Indeed an elementary homotopy takes place in a rank 2 residue  $R$ , so if the wall  $M_r$  contains a panel of  $R$  then it actually meets  $R$  in two opposite panels (because a reflection fixes two opposite panels in a polygon), in which case both galleries cross  $M_r$  exactly once in  $R$ . If  $g$  is equivalent to  $f$  via an elementary expansion or contraction then  $n(g) = n(f)$  or  $n(f) \pm 2$ .  $\square$

Let us temporarily call a gallery *even* or *odd* depending on whether it crosses the wall  $M_r$  an even or odd number of times. The preceding Lemma (2.5) implies that a given chamber  $c$  partitions  $W$  into two parts according to the parity of a gallery from  $c$ . Given another chamber  $c'$ , the same partition is achieved, as the reader may readily verify, although there is a switch of parity if a gallery from  $c$  to  $c'$  is odd. These two parts of  $W$  are called the *roots* (or *half-apartments*) determined by the wall  $M_r$ . They form complementary subsets of  $W$ , and are said to be *opposite* one another; if one is denoted  $\alpha$ , the other is denoted  $-\alpha$ , and if  $r$  is the reflection we let  $\pm\alpha_r$  denote the two roots.

Before stating the next proposition we define a set  $X$  of chambers to be *convex* if any minimal gallery between two chambers of  $X$  lies entirely in  $X$ .

(2.6) PROPOSITION. (i) *Roots are convex.*

(ii) *If  $\alpha$  is a root, and  $x, y$  adjacent chambers with  $x \in \alpha$  and  $y \in -\alpha$ , then*

$$\alpha = \{c \mid d(x, c) < d(y, c)\}.$$

(iii) *There are bijective correspondences between the set of reflections, the set of walls, and the set of pairs of opposite roots.*

PROOF: (i) If  $c, c' \in \alpha_r$  then by (2.5) a minimal gallery from  $c$  to  $c'$  does not cross  $M_r$ . Thus every chamber on this gallery lies in  $\alpha_r$ .

(ii) If  $c \in \alpha = \alpha_r$ , then by (2.5) a minimal gallery from  $x$  to  $c$  cannot cross  $M_r$ , and hence cannot go via  $y$ , so by (2.4)  $d(x, c) < d(y, c)$ . Conversely, if  $d(x, c) < d(y, c)$ , then since  $x$  and  $y$  are adjacent there is a minimal gallery from  $y$  to  $c$  via  $x$ , and this crosses  $M_r$ , so  $c \notin -\alpha$ .

(iii) A reflection determines a wall, and since a given panel is fixed by only one reflection, the wall determines the reflection. Moreover a wall  $M$  determines two opposite roots  $\pm\alpha$  as above, and if  $x \in \alpha$  and  $y \in -\alpha$  share a panel  $\pi$ , then by (2.5) and the definition of  $\pm\alpha$ , the minimal gallery  $(x, y)$  crosses  $M$ , so  $\pi \in M$ . Since  $\pi$  determines  $M$ , this shows that two opposite roots are associated to a unique wall.  $\square$

**Foldings.** Let  $\alpha$  be any root, and  $r$  the corresponding reflection; using (2.6)(ii) one sees that  $r$  switches  $\alpha$  and  $-\alpha$ . Thus one has a map

$$\rho_\alpha : W \rightarrow \alpha$$

defined by  $\rho_\alpha(x) = x$  if  $x \in \alpha$ , and  $\rho_\alpha(x) = r(x)$  if  $x \notin \alpha$ . It is a morphism (i.e. preserves  $i$ -adjacency for each  $i$ ), because if  $x \in \alpha$  is adjacent to  $y \notin \alpha$ , then clearly  $\rho_\alpha(y) = \rho_\alpha(x) = x$ . This  $\rho_\alpha$  is called the *folding* of  $W$  onto  $\alpha$ .

The wall  $M_r$  determined by  $\alpha$  will be denoted  $\partial\alpha$  because it is the boundary of  $\alpha$  in the usual sense (see Exercise 6). Since any gallery  $\gamma$  from a chamber  $c \in \alpha$  to  $d \in -\alpha$  crosses the wall  $\partial\alpha$ , its image  $\rho_\alpha(\gamma)$  contains at least one repeated chamber, and hence there is a shorter gallery from  $c$  to  $\rho_\alpha(d)$ ; this fact will be used later.

(2.7) PROPOSITION. *Let  $x$  and  $y$  be chambers, and  $(x = x_0, x_1, \dots, x_k = y)$  any minimal gallery from  $x$  to  $y$ . For  $i = 1, \dots, k$  let  $\beta_i$  denote the root containing  $x_{i-1}$  but not  $x_i$ ; these  $\beta_i$  are mutually distinct and are precisely all roots containing  $x$  but not  $y$ . In particular  $d(x, y)$  equals the number of roots containing  $x$  but not  $y$ .*

PROOF: If a root  $\beta$  contains  $x$  but not  $y$ , then any minimal gallery from  $x$  to  $y$  goes from  $\beta$  to  $-\beta$  at some point, and hence  $\beta$  is one of the  $\beta_i$ . By convexity (2.6) a minimal gallery cannot enter and exit from a given root, so  $x \in \beta_i$ ,  $y \notin \beta_i$  and the  $\beta_i$  are distinct.  $\square$

**Example.** Figure 2.3 shows three minimal galleries from  $x$  to  $y$  in the  $\tilde{A}_2$  Coxeter complex. Each of these galleries determines an ordering of the roots containing  $x$  but not  $y$ ; these are:

$\beta_1\beta_2\beta_3\beta_4\beta_5$ ,  $\beta_1\beta_2\beta_5\beta_4\beta_3$  and  $\beta_5\beta_2\beta_1\beta_4\beta_3$ .

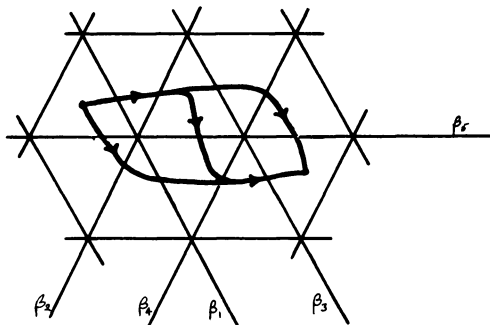

Figure 2.3

(2.8) PROPOSITION. *Given chambers  $x$  and  $y$ , a chamber lies on a minimal gallery from  $x$  to  $y$  if and only if it lies in every root containing  $x$  and  $y$ .*

PROOF: By convexity (2.6) any chamber lying on a minimal gallery from  $x$  to  $y$  lies in every root containing  $x$  and  $y$ . Conversely suppose  $z$  is contained in every such root. If  $\alpha$  is a root containing  $x$  but not  $z$ , then by hypothesis  $y$  is not in  $\alpha$ ; and if  $\beta$  is a root containing  $z$  but not  $y$  then again by hypothesis  $\beta$  contains  $x$ . Any root containing  $x$  but not  $y$  is one of the  $\alpha$  or  $\beta$ , hence by (2.7)  $d(x, z) + d(z, y) = d(x, y)$ , so  $z$  lies on a minimal gallery from  $x$  to  $y$ .  $\square$

**Remark.** If in the preceding proposition there are no roots containing both  $x$  and  $y$ , then every chamber lies on a minimal gallery from  $x$  to  $y$ . In this case (2.7) implies that  $W$  has only finitely many roots, and its diameter is finite. This implies (Exercise 5) that  $W$  is finite.

(2.9) THEOREM. *Given any  $w \in W$  and any residue  $R$ , there is a unique chamber of  $R$  nearest  $w$  (call it  $\text{proj}_R w$ ), and for any chamber  $x \in R$ , there is a minimal gallery from  $w$  to  $x$  via  $\text{proj}_R w$ .*

PROOF: If  $b, c$  are distinct chambers of  $R$  at minimal distance from  $w$ , take a root containing one but not the other. Without loss of generality this gives a root  $\alpha$  with  $w, c \in \alpha$ ,  $b \notin \alpha$ . If  $\gamma$  is a minimal gallery from  $w$  to  $b$ , then it crosses from  $\alpha$  to  $-\alpha$ , and hence  $\rho_\alpha(\gamma)$  gives a shorter gallery from  $w$  to  $\rho_\alpha(b) = b'$ . However  $\rho_\alpha(c) = c$  implies  $\rho_\alpha(R) \subset R$ , so  $b' \in R$ . This contradicts the minimality of  $d(w, b)$ , proving that  $\text{proj}_R w$  exists.

To prove the last statement of the theorem it suffices, by (2.8), to show that if  $\alpha$  is any root containing  $w$  and  $x$ , then  $\alpha$  contains  $\text{proj}_R w$ . Since  $x \in \alpha$  one has  $\rho_\alpha(R) \subset R$ , and if  $\text{proj}_R w \notin \alpha$ , then  $\rho_\alpha(\text{proj}_R w) \in R$  is nearer  $w$  than  $\text{proj}_R w$  is, a contradiction.  $\square$

(2.10) LEMMA. *If  $x$  and  $y$  are chambers in a common  $J$ -residue, then any minimal gallery from  $x$  to  $y$  is a  $J$ -gallery. In particular, residues are convex.*

PROOF: Let  $R$  be the  $J$ -residue concerned, and suppose  $z$  lies on a minimal gallery from  $x$  to  $y$ . If  $z \notin R$ , set  $z' = \text{proj}_R z$ ; by (2.9)  $d(x, z') < d(x, z)$  and  $d(z', y) < d(z, y)$ , contradicting the minimality of a gallery from  $x$  to  $y$  via  $z$ . Thus  $z \in R$ . Hence any minimal gallery from  $x$  to  $y$  lies in  $R$ , and it remains to show that if  $x, x' \in R$  are  $i$ -adjacent, then  $i \in J$ , but this follows from (2.1)(ii).  $\square$

### 3. Reduced Words and Homotopy.

We observed earlier, following Lemma (2.1), that the  $\{i, j\}$ -residues of a Coxeter complex have  $2m_{ij}$  chambers arranged in a circuit. If  $x$  and  $y$  are chambers in such an  $\{i, j\}$ -residue joined by a gallery of type  $p(i, j)$ , then they are also joined by a gallery of type  $p(j, i)$ . Thus an elementary homotopy of words  $f = f_1 p(i, j) f_2 \simeq f_1 p(j, i) f_2 = f'$  can be realized at the gallery level by making an alteration in some  $\{i, j\}$ -residue. Recall that a word  $f$  is reduced if it is not homotopic to a word of the form  $f_1 i i f_2$ . As promised earlier we now prove:

(2.11) THEOREM. *A gallery of type  $f$  is minimal if and only if  $f$  is reduced. Moreover any two reduced words  $f$  and  $g$  which are equivalent (i.e.  $r_f = r_g$ ) must be homotopic.*

PROOF: The proof consists of two main steps.

**Step 1.** If  $f_1$  and  $f_2$  are the types of two minimal galleries from  $x$  to  $y$ , then  $f_1 \simeq f_2$ .

Let  $f_1$  end in  $i$ , and  $f_2$  in  $j$ . If  $i = j$ , then  $f_1 = f'_1 i$  and  $f_2 = f'_2 i$ , so  $f'_1$  and  $f'_2$  are the types of two minimal galleries with the same extremities. Induction on the length of the gallery shows  $f'_1 \simeq f'_2$ , hence  $f_1 \simeq f_2$ . Now suppose  $i \neq j$ ; let  $R$  be the  $\{i, j\}$ -residue containing  $y$ , let  $z = \text{proj}_R x$ , and let  $y_1$  and  $y_2$  be the chambers respectively  $i$ - and  $j$ -adjacent to  $y$ . By (2.9) there are minimal galleries from  $x$  via  $z$  to  $y_1$  and  $y_2$  respectively, and

these extend (by one chamber) to galleries from  $x$  via  $z$  to  $y$  - see Figure 2.4.

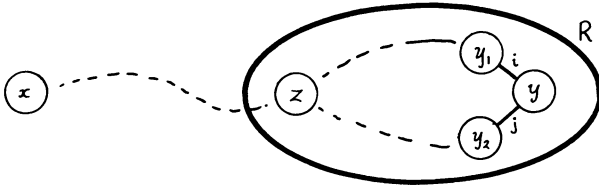

Figure 2.4

By (2.10) the subgalleries from  $z$  to  $y$  are  $\{i, j\}$ -galleries, and since  $R$  is a  $2m_{ij}$ -gon, by (2.1), these sub-galleries have types  $p(j, i)$  and  $p(i, j)$  respectively. Thus if  $f_0$  is the type of some minimal gallery from  $x$  to  $z$ , then there exist galleries of types  $f_0 p(j, i)$  and  $f_0 p(i, j)$  from  $x$  to  $y$ . By induction, as above,  $f_1 \simeq f_0 p(j, i) \simeq f_0 p(i, j) \simeq f_2$ .

**Step 2.** If  $f$  is a reduced word then any gallery of type  $f$  is minimal.

Again by induction we assume this to be true if the length of  $f$  is less than  $k$  (for  $k = 0$  the result is trivial). Now let  $f = gij$  ( $i, j \in I$ ) be reduced, and  $\gamma = (x_0, \dots, x_k)$  a gallery of type  $f$ . By induction  $\gamma_1 = (x_0, \dots, x_{k-1})$  is minimal. If  $\gamma$  is not minimal, then  $d(x_0, x_k) = k - 2$ , so there exists a minimal gallery  $\gamma_2$  from  $x_0$  to  $x_{k-1}$  via  $x_k$  - see Figure 2.5.

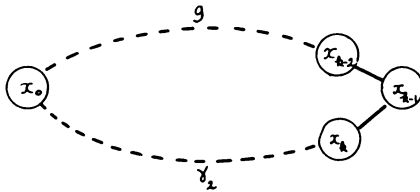

Figure 2.5

Since  $\gamma_1$  has type  $gi$  and  $\gamma_2$  has type  $hj$ , for some word  $h$ , we apply Step 1 to see that  $f = gij \simeq hjj$  is not reduced. This contradiction shows  $\gamma$  is minimal, as required.

To conclude the proof of the theorem, notice that a minimal gallery must have reduced type otherwise we could replace it by a gallery in which a repeated chamber occurs; the converse is given in Step 2. Now any two reduced words  $f$  and  $g$  which are equivalent give minimal galleries from 1 to  $w = r_f = r_g$ , and hence by Step 1,  $f$  and  $g$  are homotopic.  $\square$

(2.12) COROLLARY. *If  $f_1$  and  $f_2$  are reduced words and  $f_1 f \simeq f_2 f$  (or  $f f_1 \simeq f f_2$ ), then  $f_1 \simeq f_2$ .*

PROOF: Indeed  $r_{f_1} r_f = r_{f_1 f} = r_{f_2 f} = r_{f_2} r_f$ , so  $r_{f_1} = r_{f_2}$  and the result is immediate from (2.11).  $\square$

(2.13) COROLLARY. *If  $f$  is reduced and  $fj$  (or  $jf$ ) is not reduced, then  $f$  is homotopic to some word ending (or beginning) with  $j$ .*

PROOF: Let  $g$  be a reduced word such that  $r_g = r_{fj}$ . If  $f$  has length  $k$ , then  $g$  has length  $k - 1$  by (2.4); and if  $gj$  is not reduced then  $r_f = r_{gj}$  has length  $k - 2$ , a contradiction. Therefore  $gj$  is reduced and  $f \simeq gj$  by (2.11). The  $jf$  case follows by symmetry.  $\square$

If  $J$  is a subset of  $I$  we let  $M_J$  denote  $(m_{ij})$  for  $i, j \in J$ .

(2.14) COROLLARY. *The subgroup  $W_J = \langle r_j | j \in J \rangle$  of  $W$  is the Coxeter group of type  $M_J$ .*

PROOF: It suffices to show that an equivalence between two words  $f$  and  $g$  (i.e.,  $r_f = r_g$ ) in the free monoid on  $J$  can be realized using only elements of  $J$  (i.e.,  $W_J$  inherits no further relations from  $W$ ).

From our definition of a reduced word,  $f$  and  $g$  can be turned into reduced words  $f'$  and  $g'$  by means only of elementary homotopies and contractions (i.e. without using any elementary expansions), and therefore without using elements outside  $J$ . Moreover by (2.1)  $f'$  and  $g'$  are homotopic, so  $f$  and  $g$  are equivalent via a sequence of elementary equivalences involving only elements in  $J$ .  $\square$

#### 4. Finite Coxeter Complexes.

If  $W$  is a finite Coxeter complex, let  $\text{diam}(W)$  denote its *diameter*, the maximum distance between two chambers, and define two chambers to be *opposite* if the distance between them is  $\text{diam}(W)$ . Notice that  $W$  necessarily has finite rank (cf. Exercise 5).



(2.15) THEOREM. *If  $W$  is finite, then:*

- (i)  $\text{diam}(W) = \frac{1}{2}$  (no. of roots of  $W$ ).
- (ii) Two chambers are opposite if and only if they lie in no common root.
- (iii) Every chamber has a unique opposite.
- (iv) If  $x$  and  $y$  are opposite chambers, then every chamber lies on a minimal gallery from  $x$  to  $y$ .

PROOF: We first claim that if  $x$  and  $y$  lie in a common root then they cannot be opposite. Indeed if  $\alpha$  is a root containing  $x$  and  $y$ , set  $y' = \rho_{-\alpha}(y)$ . Then  $d(x, y') > d(x, y)$  because a minimal gallery  $\gamma$  from  $x$  to  $y'$  must cross the wall  $\partial\alpha$ , so  $\rho_\alpha(\gamma)$  contains a repeated chamber and hence gives a shorter gallery from  $x$  to  $y$ . Thus  $x$  and  $y$  are not opposite.

To prove (i) notice first that  $\text{diam}(W) \leq \frac{1}{2}$  (no. of roots of  $W$ ) by (2.7). On the other hand if  $x$  and  $y$  are opposite in  $W$ , then by the above, no root containing  $x$  can contain  $y$ , and therefore  $\text{diam}(W) = d(x, y) \geq \frac{1}{2}$  (no. of roots of  $W$ ), again by (2.7). This proves (i).

To prove (ii) it remains to show that if  $x$  and  $y$  lie in no common root then they are opposite; but in this case (2.7) implies  $d(x, y) \geq \frac{1}{2}$  (no. of roots of  $W$ ) so the result follows from (i).

To prove (iii), suppose  $y$  and  $z$  are distinct chambers opposite  $x$ . Take a root  $\alpha$  containing one but not the other; either  $\alpha$  or  $-\alpha$  contains  $x$ , so without loss of generality  $x$  and  $y$  lie in a common root, contradicting (ii). By definition at least one chamber has an opposite in  $W$  and hence by transitivity of the group they all do.

(iv) We have shown  $x$  and  $y$  lie in no common root, so this is immediate from (2.8).  $\square$

**Sphericity.** A Coxeter complex which is finite is often called *spherical*, or of *spherical type* because the geometric realisation of a finite Coxeter complex of rank  $n$  is a triangulation of the  $(n-1)$ -sphere. The most useful way of seeing this is to use the real vector space  $V$  defined in the proof of (2.1); for more details of the following facts see Tits [1968] and Bourbaki [1968/81]. The Coxeter group  $W$  acts faithfully on  $V$ , and the fixed points for each reflection of  $W$  form a hyperplane of  $V$ . When  $W$  is finite it obviously acts discretely on  $V$ , and these hyperplanes partition  $V$  into open sets called *Weyl chambers*, each of which is a fundamental domain for  $W$ . The reflection hyperplanes intersect a sphere  $S^{n-1}$  centred at the origin of  $V$  to give a triangulation of  $V$ , which may be identified with

the Coxeter complex. Each reflection hyperplane  $H$  meets  $S^{n-1}$  in a wall  $M$  of this Coxeter complex, and the two half-spaces on either side of  $H$  correspond to the roots having boundary  $M$ . Finiteness of  $W$  corresponds to the case of the symmetric bilinear form  $(e_i, e_j) = -2 \cos(\pi/m_{ij})$  being positive definite, so finite Coxeter groups can be classified by considering these forms. An alternative mode of classification is given in Exercises 9-12.

**Observation.** Writing  $\ell(wr_i) < \ell(w)$  is another way of stating that there is a minimal gallery, whose type ends in  $i$ , from  $1$  to  $w$ .

(2.16) **THEOREM.** Suppose  $\ell(wr_j) < \ell(w)$  for all  $j \in J$ . Let  $R$  be the  $J$ -residue containing  $w$ , and let  $z = \text{proj}_R 1$  be the unique chamber of  $R$  nearest  $1$ . Then  $R$  is finite and  $z$  is opposite  $w$  in  $R$ .

**PROOF:** It suffices to show that every chamber of  $R$  lies on a minimal gallery from  $z$  to  $w$ . Indeed in this case (2.8) implies that  $z$  and  $w$  lie in no common root of  $R$ , hence by (2.7)  $R$  has finitely many roots and hence finite diameter; therefore  $R$  itself is finite by Exercise 5, and by (2.15) (ii)  $z$  and  $w$  are opposite. Consider first the case  $|J| = 2$ . In this case the two chambers of  $R$  adjacent to  $w$  are closer to  $1$ , and hence closer to  $z$ , than  $w$  is. Therefore  $z$  and  $w$  are opposite in the  $2m_{ij}$ -gon  $R$ , and every chamber of  $R$  lies on a minimal gallery from  $z$  to  $w$  (a fact we shall use below).

For the general case, assume that every chamber of  $R$  at distance  $< k$  from  $w$  lies on a minimal gallery from  $z$  to  $w$ ; this is true by hypothesis if  $k = 2$ . Now let  $v \in R$  be at distance  $k \geq 2$  from  $w$  in  $R$  on a minimal gallery  $(w, \dots, v'', v', v)$  of type  $\dots ij$ , where  $i, j \in J$  - see Figure 2.6).

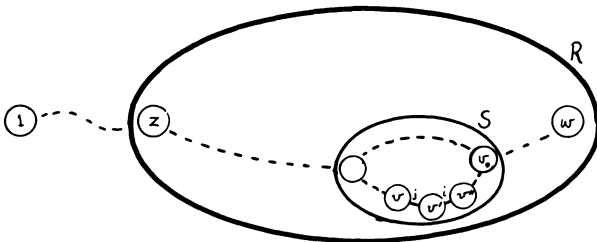

Figure 2.6

Let  $S$  be the  $\{i, j\}$ -residue containing  $v$ , and  $v_0 = \text{proj}_S w$ , so  $d(w, v_0) \leq d(w, v'') = k - 2$ . The two chambers which are  $i$ - and  $j$ -adjacent to  $v_0$  are at distance at most  $k - 1$  from  $w$ , hence by induction lie on minimal galleries from  $z$  to  $w$ ; in particular they are both closer to  $z$  than  $v_0$  is. We may therefore apply the case  $|J| = 2$ , in which  $S$  takes the place of  $R$ ,  $v_0$  takes the place of  $w$ , and  $z$  takes the place of 1. Thus  $v_0$  is opposite  $\text{proj}_S z$  in  $S$ , and so  $v$  lies on a minimal gallery from  $\text{proj}_S z$  to  $v_0 = \text{proj}_S w$ , hence from  $z$  to  $w$  as required.  $\square$

### 5. Self-Homotopy.

The purpose of this last section of Chapter 2 is to prove a theorem which will be applied in Chapters 4 and 7; the details could be omitted at a first reading. For notational convenience we now let  $\simeq$  mean only *elementary homotopy*.

A *self-homotopy* is a sequence of elementary homotopies beginning and ending with the same word. Given a word  $f$  we let  $H(f)$  denote the graph whose vertices are words homotopic to  $f$ , and whose edges are elementary homotopies. A self-homotopy is then a circuit in this graph.

Let us call a self-homotopy *inessential* if it is of the form

$$f = f_0 \simeq f_1 \simeq \dots \simeq f_{k-1} \simeq f_k \simeq f_{k-1} \dots \simeq f_1 \simeq f_0 = f$$

i.e., “do then undo” - a degenerate circuit in  $H(f)$ ; or if it is of the form

$$\begin{aligned} f_1 p(i, j) f_2 p(k, l) f_3 &\simeq f_1 p(j, i) f_2 p(k, l) f_3 \\ &\simeq \\ f_1 p(i, j) f_2 p(l, k) f_3 &\simeq f_1 p(j, i) f_2 p(l, k) f_3 \end{aligned}$$

“do then undo in reverse order”.

We shall say that a circuit  $\pi$  in a graph *decomposes* into two circuits  $\pi_1 \pi_2$  and  $\pi_2^{-1} \pi_3$  if  $\pi = \pi_1 \pi_3$  (here  $\pi^{-1}$  means  $\pi$  in reverse order). This definition extends to the decomposition of a circuit into finitely many circuits, or a self-homotopy into finitely many self-homotopies.

(2.17) THEOREM. *Every self-homotopy decomposes into self-homotopies each of which is inessential or lies in a rank 3 residue of spherical type (i.e. type  $J$  with  $W_J$  finite).*

PROOF: By induction on the length of the word  $f$ , we may assume it is true for words of shorter length than  $f$ .

We shall show that a sequence of elementary homotopies of the form

$$fi \simeq \dots j \simeq \dots j \simeq \dots \dots \simeq \dots j \simeq gk \tag{*}$$

can be replaced by one of the form

$$fi \simeq \dots i \simeq \dots \dots \simeq \dots i \simeq \dots k \simeq \dots \dots k \simeq gk \tag{**}$$

by decomposing into circuits which are either inessential or else lie in the  $\{i, j, k\}$ -residue  $R$  containing  $w = r_{fi} = r_{gk}$ .

Note first that by (2.16)  $R$  is of spherical type, and  $w = w_1 w_2$  where  $w = \text{proj}_R 1$  is the unique element of  $R$  of shortest length, and  $w_2$  is the longest element of  $W_{\{i, j, k\}}$ . Let us write  $w_1 = r_h$  for some reduced word  $h$ , and  $w_2 = r_{h'}$  where  $h'$  may be chosen to end in  $i, j$ , or  $k$ . Applying (2.16) to the  $\{i, j\}$ -residue  $S$  of  $R$  containing  $w$ , we see that  $h'$  is homotopic to  $h_k p(i, j)$ , where  $h_k$  is some reduced word such that  $r_{h_k} = \text{proj}_S 1$ . Similarly  $h'$  is homotopic to  $h_i p(j, k)$  and  $h_j p(k, i)$ , with  $h_i$  and  $h_j$  suitably defined. By (2.12) a homotopy between  $\dots l$  and  $\dots l$  can be done using only words ending in  $l$ , so we may alter the original sequence (\*) as follows:

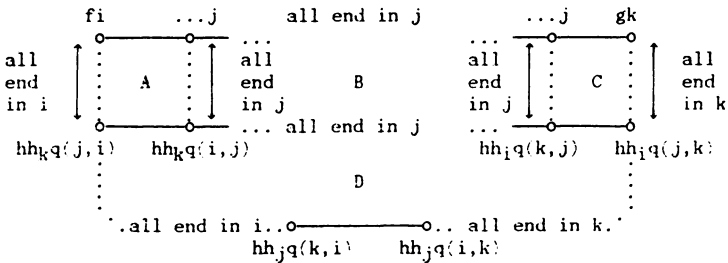

Now, circuits  $A$  and  $C$  decompose into inessential circuits;  $B$  decomposes as required because all terms end in  $j$  and we may apply the induction hypothesis; and  $D$  involves only self-homotopies in the rank 3 residue  $R$  of spherical type. Note that if  $i = k$ , then  $hh_k p(j, i) = hh_i p(j, k)$  and the bottom path reduces to a point.

Finally by using alterations as above from (\*) to (\*\*) we may decompose any circuit to one all of whose terms end in  $i$ , and then the result follows by induction. □

**Notes.** Coxeter groups were first studied in complete generality by Tits [1968], and many of the results on Coxeter complexes in this chapter are taken from Tits [1974], though the material in section 5 is from Tits [1981]. Those which act discretely on Euclidean space, namely the finite ones (of spherical type) and those of affine type (Chapter 9) were classified by Coxeter [1934]; see also the elegant paper by Witt [1941]. This classification also appears in the book on Regular Polytopes by Coxeter [1947] which contains a wealth of historical detail and an extensive bibliography; for example, Coxeter remarks that polyhedra of types  $E_6$ ,  $E_7$  and  $E_8$  were constructed in 1897 by Thorold Gosset, a lawyer practising in London - see [loc. cit.] pp. 202 and 164. All finite Coxeter groups satisfying the crystallographic condition (i.e. all  $m_{ij} = 2, 3, 4$  or  $6$ ) appear as Weyl groups of semisimple Lie algebras. For more details on this, see Bourbaki [1968/81], particularly the historical sketch on pages 234-240; this book also contains an excellent account of Coxeter groups in the general case.

### Exercises to Chapter 2

- Using the notation of Lemma (2.1) show that  $s_i s_j$  has order  $m_{ij}$  on  $V_{ij}$  and is the identity on  $V_{ij}^\perp$ . If  $m_{ij}$  is finite show that  $V_{ij} + V_{ij}^\perp = V$  and show that this can fail for  $m_{ij} = \infty$ . [HINT: if  $m_{ij} < \infty$  identify  $V_{ij}$  with  $\mathbb{R}^2$  (having the usual dot product) in such a way that  $e_i$  and  $e_j$  are unit vectors and  $\pi - \pi/m_{ij}$  is the angle between them].
- Show that a gallery is minimal if and only if it crosses no wall twice.
- Show that  $W_J$  (see (2.14)) is the stabilizer of the  $J$ -residue (of the Coxeter complex) containing 1, and that  $W_J \cap W_K = W_{J \cap K}$ , and  $\langle W_J, W_K \rangle = W_{J \cup K}$ . In particular, when  $I$  is finite, the geometric realisation of  $W$  is a simplicial complex, because a simplex  $wW_J$  is uniquely determined by its vertices, namely the  $wW_K$ , where  $J \subset K$  and  $K = I - \{i\}$  for some  $i$ .
- (*The Exchange Property*) Let  $f = i_1 \dots i_n$  and suppose  $\ell(r_f) > \ell(r_{f_i})$ . Prove that  $r_{f_j} = r_g$  where  $g = i_1 \dots \hat{i}_j \dots i_n$  ( $i_j$  removed for some  $j$ ). [HINT: Let  $\alpha$  be the root containing  $r_{f_i}$  but not  $r_f$ , and let  $\gamma$  be the gallery of type  $f$  from 1 to  $r_f$ ; consider the gallery obtained by applying the folding  $\rho_\alpha$  to  $\gamma$ ].

5. If the diameter of  $W$  is finite show that  $I$  is finite, and then show  $W$  is finite.
6. Let  $\alpha$  be a root, and  $r$  the reflection switching  $\alpha$  with its opposite  $-\alpha$ . Treating  $\alpha$  as a subcomplex of the geometric realisation, by including all faces of chambers in  $\alpha$ , show that its boundary  $\partial\alpha$  is the wall  $M_r$  fixed by  $r$ , and that  $\partial\alpha = \alpha \cap (-\alpha)$ .
7. Let  $M_1, \dots, M_k$  be the connected components of the diagram  $M$ , and let  $I_t$  denote the nodes of  $M_t$  (so  $I$  is the disjoint union  $I_1 \cup \dots \cup I_k$ ). Writing  $W_t = W_{I_t}$ , show that  $W$  is isomorphic to  $W_1 \times \dots \times W_k$  both as a group and as a chamber system. (The  $W_t$  are called the *irreducible components* of  $W$ .)
8. Give all possible reduced words  $f$  such that  $r_f$  is the longest word for the  $A_3$  diagram  $\circ \text{---} \circ \text{---} \circ$  (there are 16 of them), and exhibit an inessential self-homotopy (cf. Chapter 8, section 1).
9. If  $W$  is finite show that its diagram cannot contain a circuit. [HINT: For a circuit diagram write down a word of arbitrary length which is unique in its homotopy class].
10. If  $W$  is finite show that its diagram cannot contain any of the following subdiagrams. [HINT: Apply the previous hint to the first case, and generalize this technique to the other cases].

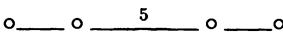
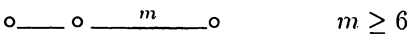
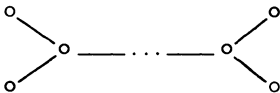
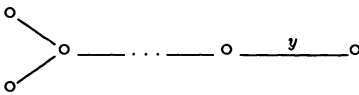
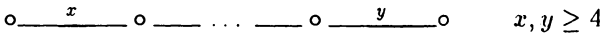

11. (More difficult). If  $W$  is finite, then show that its diagram cannot contain any of the following subdiagrams:

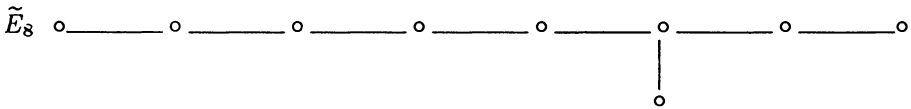
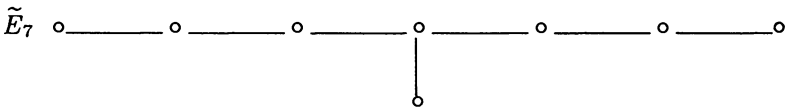
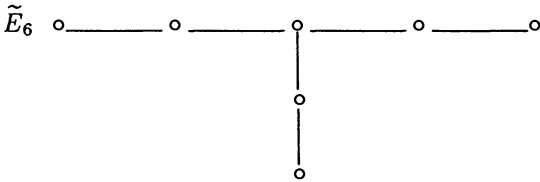
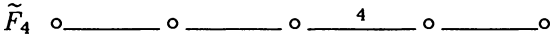
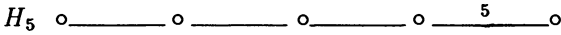

12. Using the results of Exercises 9, 10, and 11 show that if  $W$  is finite then its diagram must be the union of connected components, each of which is one of those given in Appendix 5.

## Chapter 3 BUILDINGS

This chapter introduces buildings and proves two important properties: the existence of apartments, and the fact that for any chamber  $c$  and any residue  $R$ , there is a unique chamber of  $R$  nearest  $c$ . There is also a section on generalized  $m$ -gons, which are the same thing as rank 2 buildings.

### 1. A Definition of Buildings.

We use the notation  $W, M, I$  of the previous chapter, and recall that if  $f = i_1 \dots i_k$ , then  $r_f$  means  $r_{i_1} \dots r_{i_k} \in W$ . We can now define a *building of type  $M$* . It is a chamber system  $\Delta$  over  $I$  such that each panel lies on at least two chambers, and having a  *$W$ -distance function*

$$\delta : \Delta \times \Delta \rightarrow W,$$

such that if  $f$  is a reduced word, then  $\delta(x, y) = r_f$  if and only if  $x$  and  $y$  can be joined by a gallery of type  $f$ . In particular any two chambers can be joined by a gallery of reduced type. The  $W$ -distance  $\delta(x, y)$  should not be confused with the distance  $d(x, y)$  which is the length of a minimal gallery from  $x$  to  $y$ ; in fact  $d(x, y)$  is the length of  $\delta(x, y)$  as an element of  $W$ . Of course to any building there is an associated cell complex, as in Chapter 1; we shall make no formal distinction between these, and refer to the cells (or simplexes) of a building without further ado.

**Example.** Coxeter complexes are buildings; simply set  $\delta(x, y) = x^{-1}y$ .

**Remark.** If  $\gamma = (a, b, c)$  is a gallery of type  $ii$ , then either  $a = c$  (as for a Coxeter complex) in which case we can replace  $\gamma$  by a null gallery, or else  $a \neq c$  in which case we can replace  $\gamma$  by the gallery  $(a, c)$  of type  $i$ . Thus a



gallery of type  $f_1 i f_2$  cannot generally be replaced by one of type  $f_1 f_2$ . In particular if  $f$  is not reduced, the existence of a gallery of type  $f$  from  $x$  to  $y$  does not imply that  $\delta(x, y) = r_f$ , but on the other hand if  $\delta(x, y) = r_f$  then there is a gallery of type  $f$  from  $x$  to  $y$  (Exercise 1).

(3.1). Here are some elementary consequences of the definition:

- (o)  $\Delta$  is connected,  $\delta$  maps onto  $W$ , and  $\delta(x, y) = \delta(y, x)^{-1}$ .
- (i)  $\delta(x, y) = r_i \Leftrightarrow x$  and  $y$  are distinct and  $i$ -adjacent.
- (ii)  $i$ - and  $j$ -adjacency are mutually exclusive for  $i \neq j$ .
- (iii) If there is a gallery of type  $f$  (not necessarily reduced) from  $x$  to  $y$ , and if  $f$  is homotopic to  $g$ , then there is also a gallery of type  $g$  from  $x$  to  $y$ .
- (iv) A gallery of type  $f$  is minimal  $\Leftrightarrow f$  is reduced.
- (v) If  $f$  is reduced, a gallery of type  $f$  from  $x$  to  $y$  is unique.

PROOF: (o), (i) and (ii) are easy exercises, and (iii) follows from the fact that if there is a gallery of type  $p(i, j)$  from  $x$  to  $y$ , then there is also a gallery of type  $p(j, i)$ , since both these words are reduced and give the same element of  $W$ .

(iv) Let  $\gamma$  be a gallery of type  $f$  from  $x$  to  $y$ . If  $f$  is not reduced, then by (iii) we can replace it by a gallery of type  $f_1 i f_2$ , and hence a gallery of shorter length, so  $\gamma$  is not minimal. Conversely suppose  $\gamma$  is not minimal, and let  $g$  be the type of some minimal gallery. We have shown  $g$  is reduced, so if  $f$  is also reduced then  $r_f = \delta(x, y) = r_g$ ; therefore  $f \simeq g$  by (2.11), contradicting the fact that  $g$  is shorter than  $f$ .

(v) Let  $(x, \dots, y_1, y)$  and  $(x, \dots, y_2, y)$  be galleries of reduced type  $f_i$  ( $i \in I$ ) from  $x$  to  $y$ . Then  $y_2$  is  $i$ -adjacent to  $y_1$ , because both are  $i$ -adjacent to  $y$ . Therefore if  $y_1 \neq y_2$  we have galleries of reduced types  $f$  and  $f_i$  from  $x$  to  $y_2$ , a contradiction since  $r_f \neq r_{f_i}$ . Thus  $y_1 = y_2$ , and a simple induction on the length of the gallery completes the proof.  $\square$

## 2. Generalised $m$ -gons - the rank 2 case.

For any integer  $m \geq 2$ , or for  $m = \infty$ , a *generalized  $m$ -gon* is a connected, bipartite graph of diameter  $m$  and girth  $2m$ , in which each vertex lies on at least two edges. (A graph is *bipartite* if its set of vertices can be partitioned into two disjoint subsets such that no two vertices in the same subset lie on a common edge; the *diameter* is the maximum distance between two vertices, and the *girth* is the length of a shortest circuit.) If  $m = \infty$  this is simply a tree with no end points (Exercise 12).

(3.2) PROPOSITION. A rank 2 building of type  $\circ\text{---}^m\text{---}\circ$  is a generalized  $m$ -gon, and vice versa.

PROOF: We leave the details to the reader after making two elementary observations. In a Coxeter group of type  $\circ\text{---}^m\text{---}\circ$  the reduced words are precisely the finite alternating sequences  $iji\dots$  of length  $\leq m_{ij}$ ; they give distinct group elements except for equality between  $iji\dots$  and  $jij\dots$  when both have  $m_{ij}$  terms. A generalized  $m$ -gon is then considered as a building by taking the edges as chambers, and adjacency to mean having a common vertex, of one of the two appropriate types.  $\square$

**Example.** A generalized 3-gon was illustrated in Figure 1.3 of Chapter 1.

We now define a building to be *thick* if every panel is a face of at least three chambers (i.e. each  $i$ -adjacency class has size  $\geq 3$ ). It is called *thin* if every panel is a face of exactly two chambers; thin buildings are nothing other than Coxeter complexes, as the reader may immediately verify. The *valency* of a panel will denote the number of chambers having it as a face.

(3.3) PROPOSITION. In a thick generalized  $m$ -gon, vertices of the same type have the same valency, and if  $m$  is odd, then all vertices have the same valency.

PROOF: Define two vertices  $x$  and  $y$  to be opposite if the distance  $d(x, y)$  between them is  $m$ ; they will be of the same or different type according to whether  $m$  is even or odd.

**Step 1.** Two opposite vertices have the same valency. Given opposite vertices  $x$  and  $y$ , let  $e$  be any edge on  $x$ , and let  $x'$  be its other vertex. Since  $x$  and  $x'$  have different types,  $d(x', y) < d(x, y)$ , and so there is a path from  $x$  to  $y$  starting with  $e$ , and ending with  $f$ , say. The girth assumption implies that  $f$  is uniquely determined by  $e$ , and  $e$  by  $f$ ; this gives a canonical bijection between the set of edges on  $x$  and those on  $y$ .

**Step 2.** If  $x, y$  are two vertices both joined to a common vertex  $z$ , then there exists a vertex opposite both  $x$  and  $y$ . Indeed since  $z$  has valency  $\geq 3$  we take an edge on  $z$  different from  $zx$  and  $zy$ , and continue this to a path of length  $m - 1$  ending at a vertex  $v$ . Then  $d(x, v) = d(y, v) = m$ .

Now if  $x$  and  $y$  are vertices of the same type we take a path from  $x$  to  $y$ , and use Steps 1 and 2 to see that  $x$  and  $y$  have the same valency. If  $m$  is odd then opposite vertices have different types, so by Step 1 all vertices have the same valency.  $\square$

A generalized  $m$ -gon is said to have *parameters*  $(s, t)$ , where  $s$  and  $t$  are (possibly infinite) cardinals, if the two valencies are  $s + 1$  and  $t + 1$ . Before leaving the subject of generalized  $m$ -gons, we mention that a generalized 2-gon is simply a complete bipartite graph, and a generalized 3-gon is nothing other than (the flag-graph of) a projective plane. This and other information and examples are contained in the exercises at the end of this chapter. Later on we shall deal with generalized  $m$ -gons admitting a large group of automorphisms (the Moufang  $m$ -gons); for these important examples  $m = 3, 4, 6$  or  $8$ . However there is no such restriction on  $m$  in general, as Exercise 21 shows, unless the generalized  $m$ -gon is finite. We remark in passing that in this case W. Feit and G. Higman [1964] proved the following theorem using character theory. We shall not prove it, but simply refer the reader to [loc. cit.], and also to D. Higman [1975].

(3.4) THEOREM. (*W. Feit - G. Higman*): *A finite thick generalized  $m$ -gon exists only if  $m = 2, 3, 4, 6$  or  $8$ . Moreover if the parameters are  $(s, t)$  then there are restrictions on  $s$  and  $t$  such as:*

$$\begin{aligned} \text{for } m = 4 & \quad \frac{st(st+1)}{s+t} \in \mathbf{Z} \\ \text{for } m = 6 & \quad st \text{ is a perfect square} \\ \text{for } m = 8 & \quad 2st \text{ is a perfect square} \end{aligned}$$

Moreover, D. Higman [1975] proves that for  $m = 4$  or  $8$ ,  $s \leq t^2$  and  $t \leq s^2$  (see also Exercise 19); and W. Haemers [1979] proves that for  $m = 6$ ,  $s \leq t^3$  and  $t \leq s^3$ .

### 3. Residues and Apartments.

We now continue with further basic results on buildings. If  $J$  is a subset of  $I$ , then as in Chapter 2,  $M_J$  is the subdiagram spanned by the elements of  $J$  (i.e., all  $m_{ij}$ , for  $i, j \in J$ ), and  $W_J$  the appropriate Coxeter group (cf.(2.14)). For the rest of this chapter  $\Delta$  will denote a building of type  $M$ .

(3.5) THEOREM. *Every  $J$ -residue of  $\Delta$  is a building of type  $M_J$ .*

PROOF: It suffices to show that if  $x$  and  $y$  are any two chambers in a common  $J$ -residue then  $\delta(x, y) \in W_J$ , so let  $\gamma$  be a shortest  $J$ -gallery joining them. If its type  $f$  is not reduced, then by (3.1)(iii) there is a  $J$ -gallery of type  $f_1 i i f_2$  from  $x$  to  $y$ , and hence a shorter  $J$ -gallery. Thus  $f$  is reduced, and  $\delta(x, y) = r_f \in W_J$ .  $\square$

Given any subset  $X \subset W$  we define a map  $\alpha : X \rightarrow \Delta$  to be an *isometry* if it preserves the  $W$ -distance  $\delta$ . In other words, using  $\delta_W$  for distance in  $W$ , and  $\delta_\Delta$  for distance in  $\Delta$ , we require

$$\delta_\Delta(\alpha(x), \alpha(y)) = \delta_W(x, y)$$

for all  $x, y \in X$ ; recall that  $\delta_W(x, y) = x^{-1}y$ .

An *apartment* will mean an isometric image  $\alpha(W)$  of  $W$  in  $\Delta$ . A *root* or *wall* of  $\Delta$  will mean a root or wall in an apartment of  $\Delta$ ; notice that if  $X$  is a root (or wall) in an apartment  $A$ , then the same is true for any apartment containing  $X$ . Moreover by the following theorem an isometric image of a root of  $W$  is a root of  $\Delta$ .

(3.6) THEOREM. *Any isometry of a subset  $X \subset W$  into  $\Delta$  extends to an isometry of  $W$  into  $\Delta$ .*

PROOF: Let  $\alpha : X \rightarrow \Delta$  denote the isometry, and assume  $X \neq W$ . By Zorn's lemma it suffices to extend the domain of  $\alpha$  to a strictly larger subset of  $W$ . If  $X = \emptyset$  this is a triviality, so suppose  $X$  is non-empty, in which case we can find  $x_o \in X$  and  $i \in I$  such that  $x_o r_i \notin X$ . Modifying  $X$  and  $\alpha$  by  $x_o^{-1} \in W$ , we may assume  $x_o = 1 \in X$  and  $r_i \notin X$ . We extend  $\alpha$  by defining  $\alpha(r_i)$ .

**Case 1.**  $\ell(r_i x) > \ell(x)$  for all  $x \in X$  (Figure 3.1)

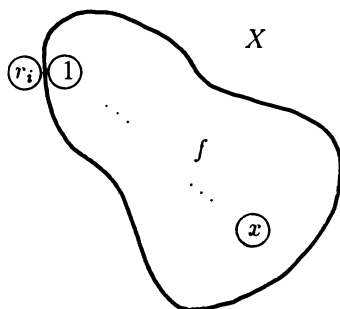

Figure 3.1

In this case let  $\alpha(r_i)$  be any chamber distinct from and  $i$ -adjacent to  $\alpha(1)$ . We need to show that  $\delta(\alpha(r_i), \alpha(x)) = r_i x$  for all  $x \in X$ , so let  $x = r_g$  with  $g$  reduced. Then there is a gallery of type  $ig$  from  $\alpha(r_i)$  to  $\alpha(x)$ , and since  $\ell(r_i x) > \ell(x)$  we know  $ig$  to be reduced. Thus  $\delta(\alpha(r_i), \alpha(x)) = r_i g = r_i r_g = r_i x$ , as required.

**Case 2.**  $\ell(r_i x_1) < \ell(x_1)$  for some  $x_1 \in X$ . In this case there is, in  $W$ , a minimal gallery from 1 to  $x_1$  via  $r_i$  of reduced type  $f$ . Let  $y$  be the second term in the unique gallery of type  $f$  from  $\alpha(1)$  to  $\alpha(x_1)$ , and define  $\alpha(r_i) = y$ . Again we need to show that  $\delta(y, \alpha(x)) = r_i x$  for all  $x \in X$ , so define  $\beta(x) = r_i \delta(y, \alpha(x))$ . Since  $y$  is  $i$ -adjacent to  $\alpha(1)$ , we see that  $\delta(y, \alpha(x)) = r_i x$  or  $x$ , and therefore

$$\beta(x) = x \text{ or } r_i x.$$

Now, as a map from  $X$  to  $W$ ,  $\beta$  is a composite of three maps:  $\alpha$ ,  $\delta(y, \cdot)$  and  $r_i$  (left multiplication). The first and last of these preserve distances, and the middle one does not increase distances, because it preserves adjacency. Therefore  $\beta$  does not increase distances, and moreover  $\beta(1) = 1$  and  $\beta(x_1) = x_1$ . Now if  $\alpha_i$  is the root of  $W$  containing 1 but not  $r_i$  (see Chapter 2), then  $x_1 \in -\alpha_i$ . Therefore  $\beta(x) \neq r_i x$  otherwise  $\beta$  increases either the distance from 1 to  $x$  (if  $x \in \alpha_i$ ) or the distance from  $x_1$  to  $x$  (if  $x \in -\alpha_i$ ) because in each case  $r_i x$  lies in the opposite root. This contradiction shows that  $\beta : X \rightarrow W$  is the inclusion map, and hence  $\delta(y, \alpha(x)) = r_i x$ .  $\square$

(3.7) COROLLARY. *Any two chambers lie in a common apartment.*  $\square$

Notice that an isometry  $\alpha : W \rightarrow \Delta$  is uniquely determined by its image  $A = \alpha(W)$  together with the chamber  $c = \alpha(1)$ , because if  $\alpha'$  is another such isometry, then  $\alpha^{-1}\alpha'$  is an isometry of  $W$  fixing the element  $1 \in W$ , and is therefore the identity map. Now fix any apartment  $A$  and chamber  $c \in A$ . We define a map

$$\rho_{c,A} : \Delta \rightarrow A$$

called the *retraction of  $\Delta$  onto  $A$  with centre  $c$* . Let  $A = \alpha(W)$  with  $\alpha(1) = c$ , and set

$$\rho_{c,A}(x) = \alpha(\delta(c, x)).$$

It is straightforward to see that for  $x \in A$ ,  $\rho_{c,A}(x) = x$ ; and indeed as a map of simplicial complexes  $\rho_{c,A}$  is a retraction in the usual topological sense.

If  $\sigma$  and  $\tau$  are simplexes, a gallery *from  $\sigma$  to  $\tau$*  means a gallery  $(c, \dots, d)$  where  $\sigma$  is a face of  $c$ , and  $\tau$  a face of  $d$ ; of course if  $\sigma$  is a chamber then  $c = \sigma$ .

(3.8) THEOREM. *Let  $A$  be an apartment containing a chamber  $c$  and a simplex  $\sigma$ . Then every minimal gallery from  $c$  to  $\sigma$  lies in  $A$ ; in particular apartments are convex.*

PROOF: Let  $\gamma = (c = c_0, c_1, \dots, c_k)$  be a minimal gallery from  $c$  to  $\sigma$ . If  $\gamma \not\subset A$  then for some  $t$ ,  $c_{t-1} \in A$  and  $c_t \notin A$ . Let  $b \neq c_{t-1}$  be the other chamber of  $A$  adjacent to  $c_{t-1}$  and  $c_t$ , so  $\rho_{b,A}(c_{t-1}) = \rho_{b,A}(c_t)$ . Hence  $\rho_{b,A}(\gamma)$  contains a repetition and therefore gives a shorter gallery from  $c$  to  $\sigma$ , contradicting the minimality of  $\gamma$ .  $\square$

(3.9) COROLLARY. *If  $\sigma$  is any simplex of  $\Delta$  (i.e.,  $St(\sigma)$  is any residue), and  $c$  is any chamber, then there is a unique chamber nearest  $c$  having  $\sigma$  as a face (i.e., belonging to  $St(\sigma)$ ).*

PROOF: By (3.7)  $c$  and  $\sigma$  (in fact  $c$  and any chamber having  $\sigma$  as a face) lie in a common apartment  $A$ . By (3.8) any chamber having  $\sigma$  as a face and at minimal distance from  $c$  lies in  $A$ . The result now follows from the same result for  $W$ , namely (2.9).  $\square$

The chamber of  $St(\sigma)$  nearest  $c$  in (3.9) will be called  $\text{proj}_\sigma c$ , or  $\text{proj}_R c$  if  $R = St(\sigma)$ .

**Direct Products and Disconnected Diagrams.** Let  $M = M_1 \cup \dots \cup M_k$  be the decomposition of the diagram into connected components, where  $M_t$  is over the set  $I_t$ . In particular  $I$  is the disjoint union  $I_1 \cup \dots \cup I_k$ , and  $m_{ij} = 2$  if  $i$  and  $j$  belong to different components. Fix some chamber  $c$  of a building  $\Delta$  of type  $M$ , and let  $\Delta_t$  denote the  $I_t$ -residue containing  $c$ .

(3.10) THEOREM. *With the notation above,  $\Delta$  is isomorphic to the direct product  $\Delta_1 \times \dots \times \Delta_k$ .*

PROOF: Setting  $W_t = W_{I_t}$  (the Coxeter group of type  $M_t$ ), we have  $W = W_1 \times \dots \times W_k$  by Exercise 7 of Chapter 2, and so any  $w \in W$  can be written  $w_1 \dots w_k$  where  $w_t \in W_t$ , and for each  $t$  we may write  $w = w_t w'_t$ , where  $w'_t = w_1 \dots \hat{w}_t \dots w_k$  ( $w_t$  removed).

Now let  $d \in \Delta$  be any chamber, let  $w = \delta(c, d)$ , and let  $d_t$  denote the unique chamber at distance  $w_t$  from  $c$  on a minimal gallery from  $c$  to  $d$ , characterised by

$$\delta(c, d_t) = w_t \text{ and } \delta(d_t, d) = w'_t.$$

We define a map  $\varphi : \Delta \rightarrow \Delta_1 \times \dots \times \Delta_k$  via

$$\varphi(d) = (d_1, \dots, d_k)$$

and show it to be an isomorphism. If  $R$  is an  $I_t$ -residue, then  $\varphi$  followed by projection to  $\Delta_t$  maps  $R$  isomorphically onto  $\Delta_t$  (indeed if  $\gamma_0$  is a gallery of reduced type  $f_0$  from  $c$  to  $\text{proj}_R c$ , and  $\gamma$  a gallery of reduced type  $f$  in  $R$  from  $\text{proj}_R c$  to  $d$ , then there is a unique gallery  $\gamma'\gamma'_0$  of type  $ff_0$  from  $c$  to  $d$ , and  $\varphi(\gamma) = \gamma'$ ). This shows  $\varphi$  is a surjective morphism. To show injectivity, suppose  $\varphi(d) = \varphi(d')$ , so in particular  $\delta(c, d) = \delta(c, d') = w = w_1 \dots w_k$ . Take galleries  $\gamma = \gamma_1 \dots \gamma_k$  and  $\gamma' = \gamma'_1 \dots \gamma'_k$  from  $c$  to  $d$  and from  $c$  to  $d'$  respectively, where  $\gamma_i$  and  $\gamma'_i$  are  $I_i$ -galleries. Obviously  $\gamma_1$  and  $\gamma'_1$  have the same end chamber  $d_1$ , and so  $\gamma_2$  and  $\gamma'_2$  are galleries in the same  $I_2$ -residue. Since  $\varphi(\gamma_2)$  and  $\varphi(\gamma'_2)$  have the same end chamber  $d_2$ , so do  $\gamma_2$  and  $\gamma'_2$ . An obvious induction shows  $d = d'$ .  $\square$

**An Alternative Definition.** The definition given at the beginning of this chapter is of recent vintage. Earlier definitions presupposed the existence of apartments in some form or other, and we now give a formulation of this sort. It can be used to check that a given chamber system is a building, without needing to define a  $W$ -distance having the required properties (cf. Exercise 8).

(3.11) **THEOREM.** *Let  $C$  be a chamber system containing subsystems (called apartments) isomorphic to a given Coxeter complex (over the same indexing set  $I$ ), and such that any two chambers lie in a common apartment. Then  $C$  is a building if, given two apartments  $A$  and  $A'$  containing a common chamber  $x$  and chamber or panel  $y$ ,  $A$  and  $A'$  are isomorphic via an isomorphism fixing  $x$  and  $y$ .*

**PROOF:** Given chambers  $x$  and  $y$  we define  $\delta(x, y)$  to be the  $W$ -distance in any apartment containing  $x$  and  $y$ ; by hypothesis this is well-defined. Furthermore if  $f$  is a reduced word and  $\delta(x, y) = r_f$ , then there is a gallery of type  $f$  from  $x$  to  $y$  in any such apartment. Conversely assume there is a gallery  $(x, \dots, y', y)$  of reduced type  $f = gi$  ( $i \in I$ ) from  $x$  to  $y$ ; then we must show that  $\delta(x, y) = r_f$ . Let  $A$  be an apartment containing  $x$  and  $y$ , and let  $\pi$  be the panel (of type  $i$ ) common to  $y$  and  $y'$ . By induction on the length of  $f$ , we know that  $\delta(x, y') = r_g$ , and therefore there is a gallery  $\gamma$  of type  $g$  in an apartment  $A'$ , from  $x$  to  $y'$ . Let  $\varphi: A' \rightarrow A$  be an isomorphism fixing  $x$  and  $\pi$ . Then  $(\varphi(\gamma), y)$  is a gallery of type  $gi = f$  in  $A$  from  $x$  to  $y$ , so  $\delta(x, y) = r_f$ , as required.  $\square$

**Notes.** The definition of a building at the beginning of this chapter is given in Tits [1986b]. It is equivalent to the definition given by Tits [1974]

which is much closer to that furnished by Theorem (3.11). The proof of Theorem (3.6) is taken from Tits [1981], where chamber systems were first introduced.

### Exercises to Chapter 3

1. If  $\delta(x, y) = r_f$  with  $f$  not necessarily reduced, show there is a gallery of type  $f$  from  $x$  to  $y$ .
2. If  $A$  is any apartment and  $\sigma$  a simplex in  $A$ , show that  $A \cap St(\sigma)$  is an apartment of  $St(\sigma)$ .
3. Let  $\alpha$  be a root, and  $\pi$  a panel in  $\partial\alpha$ . If  $x, y \notin \alpha$  are chambers in  $St(\pi)$ , show that  $\alpha \cup \{x\}$  is isometric to  $\alpha \cup \{y\}$ . Conclude that  $\alpha \cup \{x\}$  lies in an apartment, and show that  $\alpha$  is the intersection of all apartments containing it.
4. Given any two chambers  $x$  and  $y$  in a thick building, show that the set of all chambers on minimal galleries from  $x$  to  $y$  is the same as the intersection of all apartments containing both  $x$  and  $y$ . [HINT: Use (3.8), (2.8) and Exercise 3].
5. Let  $W$  be finite, and define two chambers  $x$  and  $y$  to be *opposite* if they are opposite in some apartment  $A$  containing both. Show that  $A$  is the only apartment containing both  $x$  and  $y$ . [HINT: Use (2.5) (iv) and Exercise 4].
6. Let  $A$  and  $A'$  be apartments having a chamber in common. Show that  $A \cap A'$  is a convex set of chambers (together with their faces), and that there is an isomorphism from  $A$  to  $A'$  fixing  $A \cap A'$ . [HINT: Use (3.6)].
7. Let  $A$  and  $A'$  be apartments containing simplexes  $\sigma$  and  $\tau$ . Show there is an isomorphism from  $A$  to  $A'$  fixing  $\sigma$  and  $\tau$ . [HINT: Take chambers  $c \in St(\sigma) \cap A$  and  $d \in St(\tau) \cap A'$ , and let  $A''$  be an apartment containing  $c$  and  $d$ ].
8. Show that Example 4 of Chapter 1 is a building. [HINT: Use (3.11)].
9. In Example 4 of Chapter 1, let  $c = (V_1 \subset V_2 \subset \dots \subset V_n)$  be any chamber, and let  $\sigma = W_n$  be any subspace of dimension  $n$ . Find the unique chamber nearest  $c$  having  $\sigma$  as a face, as in (3.9).
10. Let  $\Delta$  be a building and let  $\Delta'$  be a sub-chamber system which is a union of apartments such that any two chambers of  $\Delta'$  lie in one of these apartments. Show that  $\Delta'$  is a building (having the same type as  $\Delta$ , of course).



11. If  $R_1, \dots, R_t$  are residues of types  $J_1, \dots, J_t$  in a building  $\Delta$ , show that  $R_1 \cap \dots \cap R_t$  is a residue of type  $J_1 \cap \dots \cap J_t$ , and hence if  $\Delta$  has finite rank its geometric realisation (in the sense of Chapter 1 section 1) is a simplicial complex. [HINT: Use (2.1)(ii)].
12. Show that a generalized  $\infty$ -gon (i.e.,  $W$  infinite dihedral) is the same thing as a tree with no end point (i.e. no vertex on only a single edge).
13. Show that a generalized 2-gon is a complete bipartite graph (i.e., two sets of vertices  $X$  and  $Y$  with edges being all pairs  $\{x, y\}$  with  $x \in X$ ,  $y \in Y$ ).
14. Given a generalized  $m$ -gon  $\Delta$  with  $m \geq 3$ , call the two types of vertices *points* and *lines* and define a point to be *on* a line if they are the vertices of a common edge of  $\Delta$ . Using this interpretation, show that thick generalized 3-gons are the same thing as projective planes (i.e., any two distinct points lie on a unique common line, any two lines have a point in common, and there exists a non-degenerate quadrangle.)
15. Given parameters  $(s, t)$  for a generalized  $m$ -gon with  $m$  finite, show that the number of chambers (edges) opposite a given chamber is  $(st)^{m/2}$  if  $m$  is even, and  $s^{\frac{m+1}{2}} t^{\frac{m-1}{2}}$  if  $m$  is odd; for  $m$  odd, reversing the roles of  $s$  and  $t$  gives an alternative proof that  $s = t$ . If  $m$  is even show that the total number of chambers is  $(s+1)(t+1)(1+st+\dots+(st)^{\frac{m}{2}-1})$ .
16. Let  $\Delta$  be a generalized  $2m$ -gon having vertices of types 1 and 2, and suppose each vertex of type 1 has valency 2 (i.e. lies on exactly 2 edges). Show that  $\Delta$  is obtained from a generalized  $m$ -gon  $\Delta_0$  by introducing a new vertex (of type 1 in  $\Delta$ ) in the middle of each edge of  $\Delta_0$  and taking the vertices of  $\Delta_0$  to be the type 2 vertices of  $\Delta$ . If  $\Delta$  has parameters  $(1, t)$  with  $t \neq 1$ , conclude that  $\Delta_0$  has parameters  $(t, t)$ , and hence by the Feit-Higman Theorem (3.4) that  $m = 2, 3, 4$  or 6 only.
17. A *polarity* of a generalized  $m$ -gon is an (outer) automorphism of order 2 interchanging the two types of vertices. Show that the chambers fixed by a polarity are mutually opposite, and if there are no fixed chambers then every chamber is carried to an opposite one.
18. Show that generalized 4-gons (quadrangles) are those point-line geometries, in the sense of Exercise 14, satisfying:
  - (i) two points lie on at most one line;
  - (ii) there exists a non-degenerate quadrangle;

(iii) for any line  $L$  and point  $p$  not on  $L$ , there is a unique point of  $L$  collinear with  $p$ .

19. Let  $V$  be a 4-dimensional vector space over  $k$  with basis  $\{x_1, x_2, y_1, y_2\}$  and alternating bilinear form

$$(x_i, x_j) = (y_i, y_j) = 0$$

and

$$(x_i, y_j) = -(y_j, x_i) = \delta_{ij}.$$

Let *points* be 1-spaces and *lines* be totally isotropic 2-spaces  $S$  (i.e.,  $(s, t) = 0 \forall s, t \in S$ ). Show that this is a generalized quadrangle in the sense of Exercise 18. If  $k = F_q$ , it has parameters  $(q, q)$ .

20. Let  $Q$  denote the geometry of Exercise 19, and let  $p$  be any point (1-space) of  $Q$ . Define a new geometry  $Q'$  as follows:  
 points of  $Q'$  are points of  $Q$  not collinear with  $p$ ;  
 lines of  $Q'$  are all lines of  $Q$  not on  $p$ , and all non-isotropic 2-spaces containing  $p$ .

Show that, with the obvious incidence (containment) relation,  $Q'$  is a generalized quadrangle. If  $k = F_q$  it has parameters  $(q - 1, q + 1)$ .

21. Let  $G$  be any bipartite graph of finite diameter and girth  $2m$  containing a circuit. Adjoin new vertices and edges to get a larger graph  $G'$  as follows: if  $x$  and  $y$  are vertices of  $G$  with  $d(x, y) = m + 1$ , introduce  $m - 1$  new edges and  $m - 2$  new vertices forming a chain of length  $m - 1$  joining  $x$  to  $y$ . Then  $G'$  has girth  $2m$ , finite diameter, and contains a circuit. Moreover if  $x, y \in G$  and  $d_G(x, y) = d > m$ , then  $d_{G'}(x, y) < d$ . Repeating this procedure ad infinitum, show that one obtains a generalized  $m$ -gon  $\overline{G}$ . What modification is necessary to ensure that  $\overline{G}$  is thick?
22. (P.J.Cameron) Consider a generalized quadrangle with parameters  $(s, t)$ . For any point  $x$ , let  $x^\perp$  denote the set of points collinear with  $x$ . Two points  $x$  and  $y$  which are not collinear are called *opposite*; in this case  $|x^\perp \cap y^\perp| = t + 1$ . Now let  $\{z_1, \dots, z_n\}$  be the set of points opposite both  $x$  and  $y$ , and for each  $z_i$  let  $a_i = |x^\perp \cap y^\perp \cap z_i^\perp|$ .

(i) Show that  $n = s^2t - st - s + t$ .

(ii) Show that  $\Sigma a_i = (t + 1)(t - 1)s$  and  $\Sigma a_i(a_i - 1) = (t + 1)t(t - 1)$ .

[HINT: Count pairs  $(v, z_i)$  and triples  $(v, w, z_i)$  where  $v, w \in x^\perp \cap y^\perp \cap z_i^\perp$ ].

- (iii) Using the inequality  $(\sum a_i)^2 \leq n \sum a_i^2$ , derive the inequality  $(s - 1)(s^2 - t) \geq 0$ .
- (iv) Conclude that for a thick generalized quadrangle,  $t \leq s^2$  and (dually)  $s \leq t^2$ .
- (v) If  $t = s^2$  what does this say about the number of points collinear with three mutually opposite points?

## Chapter 4

### LOCAL PROPERTIES AND COVERINGS

This chapter deals mainly with coverings of chamber systems (defined in section 2), particularly those chamber systems whose rank 2 residues are buildings. Most of the chapter is independent of the rest of this book; in particular there is no connection with Chapters 5 and 6, and only section 1 will be used in Chapter 7.

#### 1. Chamber Systems of Type $M$ .

In Theorem 3.5 we saw that every residue of a building is a building; in particular by (3.2), the  $\{i, j\}$ -residues are generalised  $m_{ij}$ -gons. We now define a *chamber system of type  $M$*  to be a chamber system over  $I$  for which each  $\{i, j\}$ -residue is a generalised  $m_{ij}$ -gon. Although such a chamber system is not necessarily a building, we shall show that its universal cover (section 3) is a building, provided the same is true for all  $J$ -residues whenever  $|J| = 3$  and  $W_J$  is finite.

In a chamber system of type  $M$ , we define a *strict elementary homotopy* of galleries to be an alteration from a gallery of the form  $\gamma_1\gamma_0\gamma_2$  to one of the form  $\gamma_1\gamma'_0\gamma_2$  where  $\gamma_0$  has type  $p(i, j)$  and  $\gamma'_0$  has type  $p(j, i)$ . Two galleries are then called *strictly homotopic* if one can be transformed into the other via a sequence of strict elementary homotopies.

Notice that if  $\gamma$  and  $\gamma'$  are strictly homotopic galleries of types  $f$  and  $f'$ , then  $f$  and  $f'$  are homotopic as words and hence  $r_f = r_{f'}$ ; thus each strict homotopy class of galleries determines an element of  $W$ .

(4.1) LEMMA. *Let  $C$  be a chamber system of type  $M$ . Given a gallery  $\gamma$  in  $C$  of reduced type  $f$  from  $x$  to  $y$ , and a homotopy  $f \simeq g$  of words, there*

exists a gallery  $\gamma'$  of type  $g$  from  $x$  to  $y$  which is strictly homotopic to  $\gamma$ . Moreover a minimal gallery must have reduced type.

PROOF: In a generalised  $m_{i,j}$ -gon a gallery of type  $p(i, j)$  is certainly strictly homotopic to one of type  $p(j, i)$  so a homotopy of words may be realised at the gallery level, proving the first statement. To prove the second statement, let  $\gamma$  be a minimal gallery of type  $f$  from  $x$  to  $y$ . If  $f$  is not reduced it is homotopic to a word of the form  $f_1 i i f_2$ , and hence there is a shorter gallery, of type  $f_1 i f_2$  or  $f_1 f_2$ , from  $x$  to  $y$ .  $\square$

We now give a characterization of buildings as connected chamber systems of type  $M$  satisfying the following condition for one single chamber.

$(P_x)$ . If two reduced words  $f, f'$  are the types of two galleries from  $x$  to some common chamber, then  $r_f = r_{f'}$ .

If  $(P_x)$  is satisfied, then there is a well-defined distance  $\delta(x, y) = r_f$  from  $x$  to any other chamber  $y$ , where  $f$  is a reduced word which is the type of a gallery from  $x$  to  $y$  (such a gallery exists and is obviously minimal, cf. 4.1). Moreover if  $r_f = r_g$  ( $g$  reduced), then  $f \simeq g$  by (2.11), and by (4.1) there is also a gallery of type  $g$  from  $x$  to  $y$ . Thus if  $(P_x)$  is satisfied,  $\delta(x, y) = r_f$  ( $f$  reduced) if and only if there is a gallery of type  $f$  from  $x$  to  $y$ .

(4.2) THEOREM. A connected chamber system  $C$  of type  $M$  is a building if and only if  $(P_c)$  holds for some chamber  $c \in C$ .

PROOF: By definition  $(P_c)$  holds for all chambers in a building. Conversely the preceding discussion shows that  $C$  is a building if  $(P_x)$  holds for all  $x$ . By connectivity it therefore suffices to prove that  $(P_c) \Rightarrow (P_{c'})$  whenever  $c'$  is adjacent to  $c$ .

We suppose  $c'$  is  $j$ -adjacent to  $c$ , and  $c' \neq c$ . Given two galleries  $\gamma, \gamma'$  from  $c'$  to  $d$ , having reduced types  $f, f'$  we must show that  $r_f = r_{f'}$ .

Case 1. Suppose both  $jf$  and  $jf'$  are reduced.

By applying  $(P_c)$  to the galleries  $(c, \gamma)$  and  $(c, \gamma')$  one has  $r_{jf} = r_{jf'}$ , and hence  $r_f = r_{f'}$ .

Case 2. Neither  $jf$  nor  $jf'$  is reduced.

By (2.13)  $f \simeq jg$  and  $f' \simeq jg'$  where both  $jg$  and  $jg'$  are reduced. By (4.1) we therefore have galleries  $(c', \gamma_1) = (c', c_1, \dots, d)$  and  $(c', \gamma'_1) = (c', c'_1, \dots, d)$  of types  $jg$  and  $jg'$  respectively. Clearly  $c, c', c_1$  and  $c'_1$  are all mutually  $j$ -adjacent.

If  $c_1 = c = c'_1$  we apply  $(P_c)$  to  $\gamma_1$  and  $\gamma'_1$  to conclude that  $r_g = r_{g'}$  and hence  $r_f = r_{f'}$ .

If  $c_1 \neq c \neq c'$  we apply  $(P_c)$  to  $(c, \gamma_1)$  and  $(c, \gamma'_1)$  to conclude that  $r_{jg} = r_{jg'}$ , and hence  $r_f = r_{f'}$ .

If  $c_1 = c \neq c'_1$  we apply  $(P_c)$  to  $(\gamma_1)$  and  $(c, \gamma'_1)$  to conclude that  $r_g = r_{jg'}$ . This implies  $g \simeq jg'$ , contradicting the fact that  $fg$  is reduced. A similar contradiction eliminates the possibility  $c_1 \neq c = c'_1$ , completing the proof of Case 2.

**Case 3.** Exactly one of  $jf$  or  $jf'$  is reduced.

We show this cannot happen. Without loss of generality  $jf$  is reduced and  $jf'$  is not, so by (2.13)  $f' \simeq jg$ . As in Case 2 we have a gallery  $(c', \gamma_1) = (c', c_1, \dots, d)$  of type  $fg$ , and  $c, c'$  and  $c_1$  are mutually  $j$ -adjacent.

If  $c = c_1$  we apply  $(P_c)$  to  $\gamma_1$  and  $(c, \gamma)$  to conclude that  $r_g = r_{jf}$ , hence  $g \simeq jf$ , so  $f' \simeq jg$  is not reduced, a contradiction.

If  $c \neq c_1$  we apply  $(P_c)$  to  $(c, \gamma_1)$  and  $(c, \gamma)$  to conclude that  $r_{jg} = r_{jf}$ , and hence  $g \simeq f$ . Therefore by (4.1) there is a gallery  $\gamma'$  of type  $f$  from  $c_1$  to  $d$ . The galleries  $(c, \gamma)$  and  $(c, \gamma')$  both have reduced type  $jf$ ; this implies, using  $(P_c)$ , that they must be the same gallery (the proof of (3.1)(v) goes through unchanged), and hence  $c' = c_1$ , a contradiction.  $\square$

## 2. Coverings and the Fundamental Group.

A morphism  $\varphi : C \rightarrow D$  of chamber systems is called a *covering* if it maps each rank 2 residue of  $C$  isomorphically onto a rank 2 residue of  $D$  of the same type (the term *2-covering* is also used). We say also that  $C$  *covers*  $D$ .

**Remark on Topology.** Any chamber system  $C$  of finite rank  $n$  has a geometric realization as a  $CW$ -complex  $\Delta$  of dimension  $n - 1$ , built from simplexes, as explained in Chapter 1, section 1. If  $\varphi_\Delta : \tilde{\Delta} \rightarrow \Delta$  is a covering of topological spaces, then  $\tilde{\Delta}$  inherits a cellular decomposition from  $\Delta$ , and can be viewed as the geometric realization of a chamber system  $\tilde{C}$  (chambers being faces of dimension  $n - 1$ , panels being faces of dimension  $n - 2$ ). Since  $\varphi_\Delta$  is a homeomorphism in the neighborhood of each point, it induces a map  $\varphi : \tilde{C} \rightarrow C$  which is an isomorphism on each residue of rank  $< n$ . We shall call such coverings *topological*; if  $n \geq 3$  every topological covering is a covering in the sense defined above, and for  $n = 3$  the two concepts coincide. Of course for  $n > 3$  our coverings need not be

isomorphisms on rank 3 residues; in topological terms they are “branched” (or “ramified”) over a subcomplex of codimension  $\geq 3$ .

To investigate coverings of topological spaces one uses the “fundamental group” whose elements are homotopy classes of paths beginning and ending at some given vertex. There is an analogous notion for chamber systems, which we now discuss.

In any chamber system an *elementary homotopy* of galleries is an alteration from a gallery of the form  $\gamma\omega\delta$  to  $\gamma\omega'\delta$  where  $\omega$  and  $\omega'$  are galleries (with the same extremities) in a rank 2 residue. We then say that two galleries are *homotopic* if one can be transformed to the other by a sequence of elementary homotopies. Notice that in a chamber system of type  $M$  two galleries which are strictly homotopic are obviously homotopic.

If  $c$  is a chamber in a connected chamber system  $C$ , a *closed gallery based at  $c$*  will mean a gallery starting and ending at  $c$ . The *fundamental group*  $\pi(C, c)$  is the set of homotopy classes  $[\gamma]$  of closed galleries  $\gamma$  based at  $c$ , together with the binary operation  $[\gamma] \cdot [\gamma'] = [\gamma\gamma']$  where  $\gamma\gamma'$  means  $\gamma$  followed by  $\gamma'$ ; using  $\gamma^{-1}$  to denote the reversal of  $\gamma$ , one has  $[\gamma]^{-1} = [\gamma^{-1}]$ .

Notice that if  $c'$  is any other chamber, and  $\delta$  is a gallery from  $c$  to  $c'$ , then  $[\gamma] \rightarrow [\delta^{-1}\gamma\delta]$  gives an isomorphism from  $\pi(C, c)$  to  $\pi(C, c')$ . We call  $C$  *simply-connected* if it is connected and  $\pi(C, c) = 1$ . Given a morphism  $\varphi : C \rightarrow D$  with  $\varphi(c) = d$  (sometimes written  $\varphi : (C, c) \rightarrow (D, d)$ ), one defines a map

$$\varphi_* : \pi(C, c) \rightarrow \pi(D, d)$$

via  $[\gamma] \rightarrow [\varphi(\gamma)]$ ; this is obviously a group homomorphism, and if  $\varphi$  is a covering it is injective (Exercise 1).

(4.3) THEOREM. *Buildings are simply-connected.*

PROOF: Let  $\gamma$  be any closed gallery based at  $c$  which is minimal in its homotopy class. If  $\gamma \neq (c)$  then its type  $f$  is not reduced, otherwise  $\delta(c, c) = r_f$ ; therefore there is a sequence of elementary homotopies from  $f$  to a word of the form  $f_1 i i f_2$ . By (4.1)  $\gamma$  is strictly homotopic to a gallery of this type and therefore homotopic to a shorter gallery, of type  $f_1 i f_2$  or  $f_1 f_2$ , a contradiction. Thus the fundamental group is trivial.  $\square$

(4.4) LEMMA. *Let  $\varphi : C \rightarrow D$  be a covering. Given a gallery  $\gamma$  in  $D$  starting at some chamber  $x$ , and given  $\tilde{x} \in \varphi^{-1}(x)$ , there is a unique gallery  $\tilde{\gamma}$  in  $C$  starting at  $\tilde{x}$  and with  $\varphi(\tilde{\gamma}) = \gamma$ .*

PROOF: Exercise.  $\square$

(4.5) LEMMA. Given coverings  $\varphi : (C, c) \rightarrow (D, d)$  and  $\psi : (E, e) \rightarrow (D, d)$  with  $C$  and  $E$  connected, there exists a covering  $\alpha : (C, c) \rightarrow (E, e)$  with  $\psi\alpha = \varphi$  if and only if  $\varphi_*\pi(C, c) \leq \psi_*\pi(E, e)$ .

$$\begin{array}{ccc} C & \xrightarrow{\alpha} & E \\ \varphi \searrow & & \swarrow \psi \\ & D & \end{array}$$

PROOF: If  $\alpha$  exists, then for any  $[\gamma] \in \pi(C, c)$  we have

$$\varphi_*[\gamma] = (\psi\alpha)_*[\gamma] = [\psi\alpha(\gamma)] = \psi_*[\alpha(\gamma)] \in \psi_*\pi(E, e).$$

Conversely, to define  $\alpha$ , take any chamber  $x$  of  $C$ , and let  $\gamma$  be a gallery in  $C$  from  $c$  to  $x$ . By (4.4) the gallery  $\varphi(\gamma)$  in  $D$  has a unique lifting to a gallery  $\epsilon$  in  $E$  starting at  $e$ . The final chamber of  $\epsilon$  is defined to be  $\alpha(x)$ , (see Figure 4.1); obviously  $\psi\alpha(x)$  is the final chamber of  $\varphi(\gamma)$ , namely  $\varphi(x)$ , and hence  $\psi\alpha = \varphi$ . We must show  $\alpha$  is well-defined; it will then follow that  $\alpha$  is a morphism, and hence a covering since  $\psi$  and  $\varphi$  are.

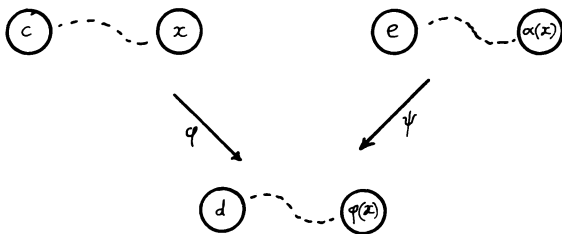

Figure 4.1

Thus let  $\gamma'$  be another gallery from  $c$  to  $x$ , and let  $\epsilon'$  be the lifting of  $\varphi(\gamma')$  starting at  $e$ . By hypothesis  $\varphi(\gamma'\gamma^{-1})$  is homotopic to  $\psi(\delta)$  for some closed gallery  $\delta$  in  $E$  based at  $e$ . Any sequence of elementary homotopies from  $\psi(\delta)$  to  $\varphi(\gamma'\gamma^{-1})$  lifts to  $E$  giving a homotopy from  $\delta$  to a closed gallery  $\theta$  with  $\psi(\theta) = \varphi(\gamma'\gamma^{-1})$ . By the uniqueness of liftings (4.4) one has  $\theta = \epsilon'\epsilon^{-1}$ ; thus  $\epsilon'$  has the same end chamber as  $\epsilon$ , and  $\alpha$  is well-defined.  $\square$



**Remark.** If  $g$  is an automorphism of  $C$ , then  $g \circ \varphi : (\tilde{C}, \tilde{c}) \rightarrow (C, c)$  is a covering, and using (4.5) one finds that  $g$  lifts to an automorphism  $\tilde{g}$  of  $\tilde{C}$  sending  $\tilde{c}$  to  $\tilde{g}(\tilde{c}) \in \varphi^{-1}(g(c))$  if and only if  $g_* \varphi_* \pi(\tilde{C}, \tilde{c}) = \varphi_* \pi(\tilde{C}, \tilde{g}(\tilde{c}))$  (Exercise 5).

$$\begin{array}{ccc}
 (\tilde{C}, \tilde{c}) & \xrightarrow{g} & (\tilde{C}, \tilde{g}(\tilde{c})) \\
 g \circ \varphi \searrow & & \swarrow \varphi \\
 & & (C, g(c))
 \end{array}$$

Since  $g_*$  is an automorphism of  $\pi(C, c)$ , this will certainly be the case whenever  $\varphi_* \pi(\tilde{C}, \tilde{c})$  is a characteristic subgroup of  $\pi(C, c)$ ; in particular whenever  $\pi(\tilde{C}, \tilde{c}) = 1$  (see Exercises 6-8).

### 3. The Universal Cover.

We assume from here on that all our chamber systems are connected.

**Definition.** A covering  $\varphi : (\tilde{C}, \tilde{c}) \rightarrow (C, c)$  is called *universal* if whenever  $\psi : (\bar{C}, \bar{c}) \rightarrow (C, c)$  is a covering there exists some covering  $\alpha : (\tilde{C}, \tilde{c}) \rightarrow (\bar{C}, \bar{c})$  such that  $\psi \alpha = \varphi$ .

(4.6) **PROPOSITION.** *Universal coverings always exist and are unique up to isomorphism. Moreover a covering  $\varphi : (\tilde{C}, \tilde{c}) \rightarrow (C, c)$  is universal if and only if  $\tilde{C}$  is simply-connected (i.e.,  $\pi(\tilde{C}, \tilde{c}) = 1$ ).*

**PROOF:** Uniqueness up to isomorphism follows from the universal property as usual. Moreover if  $\pi(\tilde{C}, \tilde{c}) = 1$ , then (4.5) implies that  $\tilde{C}$  is universal. To prove the converse it suffices to construct a simply-connected covering  $\tilde{C}$ , as follows.

The chambers of  $\tilde{C}$  are homotopy classes of galleries in  $C$  starting at  $c$ , and we let  $\tilde{c}$  denote the class of the trivial gallery  $[c]$ . Define  $i$ -adjacency by  $[c_0, \dots, c_{k-1}, c_k] \underset{i}{\sim} [c_0, \dots, c_{k-1}, c'_k]$  and  $[c_0, \dots, c_{k-1}] \underset{i}{\sim} [c_0, \dots, c_{k-1}, c_k]$ , and define  $\varphi$  by  $\varphi[c, \dots, d] = d$ . In a rank 2 residue two galleries are homotopic if and only if they have the same end chambers, so  $\varphi$  is an isomorphism when restricted to rank 2 residues. To see that  $\pi(\tilde{C}, \tilde{c}) = 1$  let  $\tilde{\gamma}$  be a closed gallery in  $\tilde{C}$  based at  $\tilde{c}$ . The definition of  $\tilde{C}$  implies that when we lift a gallery  $\delta$  of  $C$  starting at  $c$ , to a gallery  $\tilde{\delta}$  of  $\tilde{C}$  starting at  $\tilde{c}$ , the end chamber of  $\tilde{\delta}$  is the homotopy class of  $\delta$ . Since  $\tilde{\gamma}$  has end chamber  $\tilde{c}$ , the homotopy class of  $\varphi(\tilde{\gamma})$  is that of the null gallery  $(c)$ . Moreover, since  $\varphi$  is an isomorphism when restricted to rank 2 residues, each elementary homotopy in  $C$  can be lifted to  $\tilde{C}$ , and therefore a homotopy in  $C$  from

$\varphi(\tilde{\gamma})$  to  $(c)$  lifts to a homotopy in  $\tilde{C}$  from  $\tilde{\gamma}$  to the null gallery  $(\tilde{c})$ , showing  $\pi(\tilde{C}, \tilde{c}) = 1$ .  $\square$

(4.7) PROPOSITION. *Let  $\varphi : (\tilde{C}, \tilde{c}) \rightarrow (C, c)$  be a universal covering of a chamber system of type  $M$ . Then  $\tilde{C}$  is a building if and only if whenever two galleries in  $C$  starting at  $c$ , and of reduced type, are homotopic they are strictly homotopic.*

PROOF: Suppose homotopic implies strictly homotopic; to show  $\tilde{C}$  is a building it suffices, by (4.2), to verify  $P_{\tilde{c}}$ . So let  $\gamma, \gamma'$  be two galleries in  $\tilde{C}$  from  $\tilde{c}$  to some common chamber and of reduced types  $f, f'$  respectively. Since  $\tilde{C}$  is simply-connected  $\gamma$  and  $\gamma'$  are homotopic. Therefore  $\varphi(\gamma)$  and  $\varphi(\gamma')$  are also homotopic, so by hypothesis there is a sequence of strict elementary homotopies from  $\varphi(\gamma)$  to  $\varphi(\gamma')$ , and these pull back under  $\varphi^{-1}$  to show that  $\gamma$  and  $\gamma'$  are strictly homotopic. Therefore  $f \simeq f'$ , and  $r_f = r_{f'}$  as required.

Now suppose  $\tilde{C}$  is a building and let  $\gamma_1, \gamma_2$  be galleries in  $C$  of reduced types  $f_1, f_2$  starting at  $c$ , and which are homotopic. The unique liftings (see 4.4) to galleries  $\tilde{\gamma}_1, \tilde{\gamma}_2$  in  $\tilde{C}$  starting at  $\tilde{c}$  therefore have the same end chamber. Since  $f_1$  and  $f_2$  are reduced we have  $f_1 \simeq f_2$  and therefore by (4.1)  $\tilde{\gamma}_1$  is strictly homotopic to a gallery of type  $f_2$  and by uniqueness (3.1)(v) this is  $\tilde{\gamma}_2$ . The appropriate sequence of strict elementary homotopies is mapped by  $\varphi$  to a sequence of strict elementary homotopies from  $\gamma_1$  to  $\gamma_2$ , showing  $\gamma_1$  and  $\gamma_2$  are strictly homotopic as required.  $\square$

(4.8) PROPOSITION. *The universal cover of a chamber system  $C$  of type  $M$  is a building if and only if  $(R_c)$  holds for some  $c \in C$ .*

$(R_c)$ . *Any two galleries from  $c$  to a common chamber which are strictly homotopic and of the same reduced type must be equal.*

PROOF: Let  $\varphi : (\tilde{C}, \tilde{c}) \rightarrow (C, c)$  be a universal cover. If  $\gamma_1, \gamma_2$  are galleries in  $C$  of reduced type  $f$  starting at  $c$ , and which are strictly homotopic, then their liftings  $\tilde{\gamma}_1, \tilde{\gamma}_2$  to galleries in  $\tilde{C}$  starting at  $\tilde{c}$  have the same end chambers and the same type  $f$ . By (3.1)(v),  $\tilde{\gamma}_1 = \tilde{\gamma}_2$ , hence  $\gamma_1 = \gamma_2$ , and  $(R_c)$  holds.

Conversely suppose  $(R_c)$  is satisfied. We shall show that homotopy implies strict homotopy, in the sense of (4.7), and hence  $\tilde{C}$  is a building. Recall first that, as in (4.5), the chambers of  $\tilde{C}$  correspond to homotopy classes of galleries in  $C$  starting at  $c$ , and  $\varphi[c, \dots, d] = d$ . Similarly we define  $\bar{C}$  by taking its chambers to be strict homotopy classes of galleries of

reduced type in  $C$  starting at  $c$ . We let  $[\gamma]_s$  denote the strict homotopy class of  $\gamma$ , and let  $\bar{c} = [c]_s$ , (the class of the null-gallery). Adjacency is defined as in (4.5) for  $\tilde{C}$ , by setting  $[c_0, \dots, c_{k-1}, c_k]_s$   $i$ -adjacent to  $[c_0, \dots, c_{k-1}, c'_k]_s$  and  $[c_0, \dots, c_{k-1}]_s$  if  $c'_k \underset{i}{\sim} c_k$ . There is an obvious morphism  $\alpha : \bar{C} \rightarrow \tilde{C}$  sending a strict homotopy class to the homotopy class containing it. Using  $\psi : (\bar{C}, \bar{c}) \rightarrow (C, c)$  for the obvious projection  $\psi[c, \dots, d]_s = d$  we have  $\varphi\alpha = \psi$

$$\begin{array}{ccc}
 (\bar{C}, \bar{c}) & \xrightarrow{\alpha} & (\tilde{C}, \bar{c}) \\
 \psi \searrow & & \swarrow \varphi \\
 & & (C, c)
 \end{array}$$

It suffices to show that  $\psi$  is a covering, for then the universality of  $\tilde{C}$  shows  $\alpha$  is an isomorphism, so homotopic implies strictly homotopic, and (4.7) does the rest. Thus let  $R$  be a rank 2 residue, of type  $J$ , in  $\bar{C}$ ; we shall use  $(R_c)$  to define a special chamber  $z \in R$ , and use  $z$  to show  $\psi|_R$  is an isomorphism. Let  $x \in R$  be any chamber; it is a strict homotopy class of galleries in  $C$  starting at  $c$ , and determines a unique element  $w(x) \in W$  (namely  $r_f$  where  $f$  is the type of such a gallery). Let  $w(x) = w'w''$  where  $w'$  is the shortest word in the  $J$ -residue of  $W$  containing  $w$ , and  $w'' \in W_J$  (this factorization is uniquely determined by  $J$ ), and let  $f'$  and  $f''$  be reduced words with  $r_{f'} = w'$ ,  $r_{f''} = w''$ . In the class  $x$  there is a gallery  $\gamma = \gamma'\gamma''$  where  $\gamma'$  has type  $f'$ , and  $\gamma''$  has type  $f''$ . We define  $z$  to be  $[\gamma']_s$ . If instead of  $f', f''$  we use  $g', g''$ , there is a gallery  $\delta = \delta'\delta''$  in the class of  $x$ , where  $\delta'$  has type  $g'$  and  $\delta''$  type  $g''$ , and we claim  $[\delta']_s = [\gamma']_s$ . Indeed  $\delta'$  and  $\delta''$  are strictly homotopic to galleries  $\delta'_1$  and  $\delta''_1$  respectively of types  $f'$  and  $f''$ , and by  $(R_c)$ ,  $\gamma'\gamma'' = \delta'_1\delta''_1$ . Therefore  $\gamma'$  is strictly homotopic to  $\delta'$ , and  $z$  is well-defined. Moreover, had we started with a chamber  $y \underset{i}{\sim} x$ , then  $\gamma'$  would be unaffected (only  $\gamma''$  would change), and so  $z$  is uniquely determined by any chamber of  $R$  (it is actually  $\text{proj}_R \bar{c}$ ).

If  $S$  is the  $J$ -residue containing  $\psi(R)$  we can now show that  $\psi|_R$  is an isomorphism onto  $S$ , as required. The existence of  $z$  shows that if  $x$  is any chamber of  $R$ , then  $x = [\gamma'\gamma'']_s$ , where  $[\gamma']_s = z$  and  $\gamma''$  is a  $J$ -gallery of reduced type in  $S$  from  $\psi(z)$  to  $\psi(x)$ . Since every chamber  $s \in S$  lies at the end of such a gallery  $\gamma''$  (because  $S$  is a rank 2 building), we see that  $\psi$  is surjective, and since  $s$  determines  $\gamma''$  uniquely up to strict homotopy ( $\gamma''$  is in fact unique unless  $s$  is opposite  $\psi(z)$  in  $S$ ),  $\psi$  is injective.  $\square$

We conclude this section with a beautiful result which is the principal

goal of Tits' paper "A Local Approach to Buildings" [1981]. Recall that "spherical type" means  $W$  is finite, so a  $J$ -residue is of spherical type if  $W_J$  is finite.

(4.9) THEOREM. *Let  $\tilde{C}$  be the universal cover of a chamber system  $C$  of type  $M$ . Then  $\tilde{C}$  is a building if and only if all residues of  $C$  of rank 3 and spherical type are covered by buildings.*

PROOF: If  $\tilde{C}$  is a building, then by (3.5) so are its residues, and since these cover the appropriate residues of  $C$ , the "only if" part is clear.

To prove the converse we verify that the condition  $(R_c)$  of (4.8) is satisfied, so consider a strict homotopy between two galleries of the same reduced type  $f$ . This gives a self-homotopy of words, and by (2.17) this decomposes into self-homotopies each of which is either non-essential or lies in a rank 3 residue of spherical type. The former type give an equality of galleries because after a sequence of type  $f_1 p(i, j) f_2 \simeq f_1 p(j, i) f_2 \simeq f_1 p(i, j) f_2$  the gallery is left unchanged; and the latter type give an equality of galleries because  $(R_c)$  is satisfied in any rank 3 residue of spherical type, by (4.8) and the hypothesis. Therefore the two galleries are equal, and so  $(R_c)$  is satisfied.  $\square$

(4.10) COROLLARY. *Let  $C$  be a chamber system of type  $M$  and finite rank  $\geq 4$ , and suppose all residues of  $C$  are buildings. If the geometric realization of  $C$  is simply-connected in the topological sense, then  $C$  is a building.*

PROOF: Since each residue is simply-connected, by (4.3), Exercise 9 shows that  $C$  is its own universal cover, and hence a building.  $\square$

#### 4. Examples.

In this section we shall look at two examples: a family of chamber systems of type  $\tilde{A}_2$ , and an exceptional chamber system of type  $C_3$ .

**Example 1.**  $\tilde{A}_2$  is the rank 3 diagram below for which each  $m_{ij} = 3$ .



In other words, each of the three types of rank 2 residues is a projective plane (generalised 3-gon), in fact a plane of order 2 in our examples.

First we construct a projective plane of order 2 as follows. Let  $\text{Frob}(21)$  denote the Frobenius group of order 21; it has a normal  $Z_7$ -subgroup with

$Z_3$  acting non-trivially by conjugation. If  $P_1$  and  $P_2$  are two of its  $Z_3$ -subgroups, then using the notation of Example 1 in Chapter 1, the chamber system  $(\text{Frob}(21) : B = 1, P_1, P_2)$  is a projective plane (generalized 3-gon) having 21 chambers and 7 panels of each type. This can be verified directly, or indirectly as in Exercise 10, using the fact that  $\text{Frob}(21)$  is a subgroup of  $SL_3(2)$  acting simple-transitively on the 21 chambers of the building for  $SL_3(2)$ .

Now let  $A, B$  and  $C$  be  $\text{Frob}(21)$  groups, and take distinct  $Z_3$ -subgroups  $A_1, A_2 < A; B_2, B_3 < B; C_3, C_1 < C$ . We wish to construct a group  $G$  by amalgamating  $A, B$  and  $C$  so that  $A_2$  becomes identified with  $B_2, B_3$  with  $C_3$ , and  $C_1$  with  $A_1$  (see Tits [1986b] regarding amalgams). First notice that if  $s$  has order 7, and  $x$  has order 3 in  $\text{Frob}(21)$ , then  $xsx^{-1} = s^2$  or  $s^4$ . Indeed the two non-identity elements of a  $Z_3$ -subgroup of  $\text{Frob}(21)$  play different roles: conjugation by one sends each 7-element to its square, conjugation by the other sends it to its fourth power. When we identify  $A_2$  with  $B_2$ , etc., we either prescribe a "straight" identification (i.e., the two squaring elements are identified), or a "twisted" one (i.e., each squaring element is identified with the inverse of the other). This distinction yields, up to a reordering of  $A, B$  and  $C$ , four different amalgamations, which we indicate by the following diagrams:

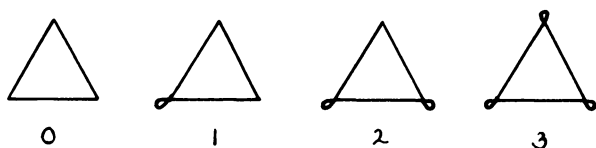

where the corner is straight or twisted in accordance with the identification of the corresponding  $Z_3$ -subgroups.

Let  $\tilde{G}_n$  ( $n = 0, 1, 2$  or  $3$ ), denote the amalgamation of  $A, B$  and  $C$  in each of the four cases above; it is shown in Tits [1986b] Theorem 1 that this amalgam does not collapse, but contains  $A, B$  and  $C$  as subgroups (in Cases 0, 1 and 3 this also follows by our construction of quotients of  $\tilde{G}_n$ ). Now let  $P_1, P_2$  and  $P_3$  denote the  $Z_3$ -subgroups of  $\tilde{G}_n$  corresponding to  $A_1 = C_1, A_2 = B_2$  and  $B_3 = C_3$  respectively. Then

$$\tilde{C}_n = (\tilde{G}_n : B = 1, P_1, P_2, P_3)$$

is a chamber system of type  $\tilde{A}_2$ .

Notice that if  $G$  is any group generated by three  $Z_3$ -subgroups  $P_1, P_2, P_3$  such that  $\langle P_i, P_j \rangle \cong \text{Frob}(21)$ , then  $C = (G : B = 1, P_1, P_2, P_3)$  is a chamber system of type  $\tilde{A}_2$ . Moreover  $G$  must be a quotient of  $\tilde{G}_n$  for  $n = 0, 1, 2$  or  $3$ , and therefore  $\tilde{C}_n$  covers  $C$ . In fact  $\tilde{C}_n$  must be the universal cover (see Exercise 8), and by (4.9),  $\tilde{C}_n$  is a building.

In Cases 0 and 3, Köhler, Meixner and Wester [1984] and [1985] give matrices generating  $\tilde{G}_n$ :

Case 0.

$$x = \begin{pmatrix} 1 & 0 & 0 \\ 0 & 0 & 1 \\ 0 & 1 & 1 \end{pmatrix} \quad \tau = \begin{pmatrix} 0 & 1 & t \\ 0 & 1+t & 1 \\ t^{-1} + 1 + t & t & 1+t \end{pmatrix}$$

$x, \tau \in GL_3(\mathbf{F}_2(t))$ .

Case 3.

$$x = \begin{pmatrix} 1 & 0 & -\lambda - 1 \\ 0 & 0 & -1 \\ 0 & 1 & -1 \end{pmatrix} \quad \tau = \begin{pmatrix} 0 & 1 & 0 \\ 0 & 0 & 1 \\ \frac{-\lambda-2}{2} & 0 & 0 \end{pmatrix}$$

where  $\lambda^2 + \lambda + 2 = 0$  and  $x, \tau \in GL_3(\mathbf{Q}(\sqrt{-7}))$ . In either case set  $y = x^r$  and  $z = y^r$ ; then let  $P_1 = \langle x \rangle$ ,  $P_2 = \langle y \rangle$  and  $P_3 = \langle z \rangle$ .

They also show that the group  $\tilde{G}$  generated by  $x$  and  $\tau$  acts transitively on the chambers of the affine building of type  $\tilde{A}_2$  over  $\mathbf{F}_2(t)$ , or  $\mathbf{Q}(\sqrt{-7})$  with the 2-adic valuation (such buildings are dealt with in Chapters 9 and 10), and hence  $\tilde{G}$  is one of the  $\tilde{G}_n$  above. In Case 3 it is natural to try reducing  $\tilde{G}$  modulo a prime  $p$ , and this is shown to give:

$$\begin{aligned} &SL_3(\mathbf{F}_p) \text{ if } p = 1, 2 \text{ or } 4 \pmod{7} \\ &SU_3(\mathbf{F}_{p^2}) \text{ if } p = 3, 5 \text{ or } 6 \pmod{7} \\ &7^2SL_2(\mathbf{F}_7) \text{ if } p = 7 \end{aligned}$$

Thus each of these groups acts on a finite chamber system of type  $\tilde{A}_2$ , and in each case the universal cover is  $\tilde{C}_3$  (notation above).

In Case 0 one can reduce modulo a prime ideal in  $\mathbf{F}_2[t, t^{-1}, (1+t)^{-1}]$ . If  $f$  is an irreducible polynomial of degree  $n$ , reduction mod  $(f)$  gives a subgroup of  $PGL_3(2^n)$ . A result of Köhler-Meixner-Wester [1984], modified by Kantor [1986], is that when  $n \geq 10$  this procedure yields more than  $2^{n/4}$  different (pairwise non-isomorphic) finite chamber systems of type  $\tilde{A}_2$ , each with a group acting simple-transitively on the set of chambers, of course.

In Case 1 a finite example is given in Exercise 12. In Case 2 I do not know of any finite example.

**Example 2.** This example shows that the rank 3 restriction in Theorem 4.9 is essential. We exhibit a chamber system  $C$  of type  $C_3$

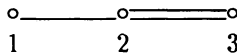

which is simply-connected, but not a building. Infinite examples of such objects were discovered years ago by J. Tits. This finite example was first discovered by A. Neumaier, and later independently by M. Aschbacher; it appears as a residue in some higher rank cases (see Exercise 18 for an example).

Take a set of seven elements  $1, \dots, 7$  and call them *points*, and define a *line* to be any subset of three points. Using these points there are exactly 30 ways of choosing seven lines to form a projective plane of order 2, such as the one in Figure 4.2.

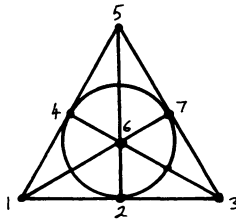

Figure 4.2

This set of planes splits into two orbits under the alternating group  $A_7$ : 15 *x*-planes and 15 *y*-planes. Two planes are in the same orbit if and only if they have exactly one line in common (Exercise 14).

To define  $C$  let its *chambers* be triples  $(p, L, X)$  where  $p$  is a point on a line  $L$  in an  $x$ -plane  $X$ ; two chambers are 1-, 2- or 3-*adjacent* if they differ in at most one point, line or  $x$ -plane respectively. Obviously  $\{1, 2\}$ -residues are projective planes (generalised 3-gons),  $\{1, 3\}$ -residues are generalised 2-gons and, as shown in Exercise 15,  $\{2, 3\}$ -residues are generalised 4-gons, hence the  $C_3$  diagram.

To show  $C$  is not a building, count the number of chambers; it is 315. Yet in a  $C_3$  building having 3 chambers per panel, there are  $2^9$  chambers opposite a given chamber  $c$  (9 being the length of the longest word): to see this, count the number of galleries of a given type  $i_1 \dots i_9$  from  $c$  to an opposite chamber. Alternatively one could, in the spirit of this chapter,

exhibit galleries of types 2132 and 321323 having the same extremities; these words are both reduced, but not homotopic.

To show  $C$  is simply-connected, it suffices to show that any closed path in the geometric realization  $\Delta$  is null-homotopic (see the remark at the beginning of section 2). It is a simple matter (Exercise 17) to reduce to considering paths of the form  $(p, M, p', M', p)$  where  $M$  and  $M'$  are lines on both  $p$  and  $p'$ , and Figure 4.3 shows that such a path (with  $p = 1$ ,  $p' = 2$ ,  $M = 123$ ,  $M' = 127$ ) is null-homotopic. In this picture points, lines and planes are represented as vertices, edges and triangles (it is an exercise to check the planes are  $x$ -planes). After making the obvious identifications the illustration shows an octahedron with a slit in one edge, and this is homeomorphic to a disc with the closed path  $(p, M, p', M', p)$  as boundary.

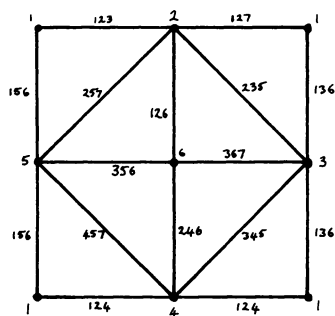

Figure 4.3

**Notes.** The main results of this chapter are taken from Tits [1981]. In that paper, Tits develops some earlier ideas he had on buildings, which became particularly relevant with the discovery in 1978 of a  $\tilde{G}_2$  geometry (chamber system) for the Lyons sporadic simple group. It was only later that the examples in section 4 were discovered. The paper on amalgams, Tits [1986b], mentioned in Example 1, is similar in spirit to this chapter and is recommended as further reading.

#### Exercises to Chapter 4

1. Prove Lemma (4.4), and show that if  $\varphi : C \rightarrow D$  is a covering, and two galleries  $\gamma_1, \gamma_2$  in  $D$  starting at  $d$  are homotopic, then their liftings



- $\tilde{\gamma}_2, \tilde{\gamma}'_2$  to galleries in  $C$  starting at  $c \in \varphi^{-1}(d)$  must have the same end chamber. Show also that if  $\gamma, \gamma'$  are homotopic galleries of  $C$ , then  $\varphi(\gamma), \varphi(\gamma')$  are homotopic, thus verifying injectivity of  $\varphi_*$ .
- Show that any closed gallery in a building can be reduced to the trivial gallery by a sequence of operations each of which is either a strict elementary homotopy, or an alteration in a rank 1 residue (i.e.,  $(c, c', c'') \mapsto (c, c'')$  where  $c \underset{i}{\sim} c' \underset{i}{\sim} c''$ ).
  - (Peter M. Johnson). Show that  $(P_x)$  is equivalent to  $(P'_x)$ : The only gallery of reduced type from  $x$  to  $x$  is the null-gallery. [HINT: With  $f$  and  $f'$  as in  $(P_x)$  use induction on  $\min(\ell(f), \ell(f'))$ ;  $(P'_x)$  allows the induction to start].
  - Show that the universal cover of a chamber system of type  $M$  is a building if and only if the only closed gallery of reduced type which is null-homotopic is the null-gallery.

In Exercises 5-9,  $C$  is any chamber system, not necessarily of type  $M$ .

- Let  $g$  be an automorphism of  $C$ , and let  $\varphi : (\tilde{C}, \tilde{c}) \rightarrow (C, c)$  be a covering. Show that  $g$  lifts to an automorphism  $\tilde{g}$  of  $\tilde{C}$  (i.e.,  $\varphi \circ \tilde{g} = g \circ \varphi$ ) sending  $\tilde{c}$  to  $\tilde{g}(\tilde{c})$  for some  $\tilde{g}(\tilde{c}) \in \varphi^{-1}(g(c))$  if and only if  $(g \circ \varphi)_* \pi(\tilde{C}, \tilde{c}) = \varphi_* \pi(\tilde{C}, \tilde{g}(\tilde{c}))$ . [HINT: Use (4.5)].
- Let  $\varphi : \tilde{C} \rightarrow C$  be a universal covering, and let  $\Pi$  denote the group of automorphisms  $\tilde{g}$  of  $\tilde{C}$  which are liftings of the identity (i.e.,  $\varphi \circ \tilde{g} = \varphi$ ). Show that  $\Pi$  acts simple-transitively on  $\varphi^{-1}(c)$  for any chamber  $c \in C$ . [HINT: Use Exercise 5 for transitivity].
- Show that the group  $\Pi$  of Exercise 6 is isomorphic to  $\pi(C, c)$ . [HINT: Chambers of  $\varphi^{-1}(c)$  correspond to homotopy classes of closed galleries based at  $c$ ].
- If  $\tilde{C}$  is a universal cover of  $C$ , show that any group  $G$  of automorphisms of  $C$  lifts to a group  $\tilde{G}$  of automorphisms of  $\tilde{C}$  such that  $\tilde{G}/\Pi \cong G$ , where  $\Pi$  is the fundamental group of  $C$ . Moreover if  $\tilde{R}$  is a residue of  $\tilde{C}$  such that  $\varphi$  maps  $\tilde{R}$  isomorphically onto a residue  $R$  of  $C$ , then  $\text{Stab}_{\tilde{G}} \tilde{R} \cong \text{Stab}_G R$ .
- Let  $C$  have finite rank  $n \geq 3$ , and suppose (the geometric realization of) each residue of rank  $k$ , for  $3 \leq k < n$ , is simply-connected in the topological sense. Show that every covering of  $C$  is a topological covering. [HINT: A covering restricts to a covering on each residue; use induction on  $n$ ].

10. Show that the group  $SL_3(2)$  has a Frobenius subgroup of order 21 acting simple-transitively on the flags of the projective plane (i.e.,  $V_1 \subset V_2$  where  $\dim V_i = i$  in the 3-space on which  $SL_3(2)$  acts). Use this to verify the assertion in Example 1 that each  $\{i, j\}$ -residue is a projective plane.
11. Let  $P_1, P_2$  and  $P_3$  be any three distinct  $Z_3$ -subgroups of  $\text{Frob}(21)$ . Show that  $(\text{Frob}(21) : B = 1, P_1, P_2, P_3)$  is a chamber system of type  $\tilde{A}_2$ , belonging to Case 0 of Example 1.
12. Let  $P_1 = \langle x_1 \rangle$ ,  $P_2 = \langle x_2 \rangle$  and  $P_3 = \langle x_3 \rangle$  be  $Z_3$ -subgroups of the alternating group  $A_7$ , where  $x_1 = (123)(456)$ ,  $x_2 = (124)(375)$  and  $x_3 = (153)(276)$ . Show that  $(A_7 : B = 1, P_1, P_2, P_3)$  is a chamber system of type  $\tilde{A}_2$ , belonging to Case 1 of Example 1.
13. What is the universal cover of the rank 3 chamber system derived from  $S_3$  in Exercise 6 of Chapter 1?
14. Verify that, as claimed in Example 2, there are exactly 30 ways of choosing 7 lines to form a projective plane. Show that  $A_7$  has two orbits of size 15 on this set of planes, and that any two distinct planes are in the same orbit if and only if they have exactly one line in common.
15. Define a bipartite graph whose vertices are the *duads*  $(ab)$  and *synthemes*  $(ab)(cd)(ef)$  of a set  $\{a, \dots, f\}$  of six symbols, with incidence being given in the obvious way [ $(ab)(cd)(ef)$  incident with  $(ab)$ ,  $(cd)$  and  $(ef)$ ]. Show that this is a generalized 4-gon, and corresponds in a natural way to the  $\{2, 3\}$ -residue of Example 2.
16. Treating a generalized 4-gon as a point-line geometry as in Exercise 10 of Chapter 3, show that there is a unique one with parameters  $(2, 2)$ , which is therefore self-dual (i.e., isomorphic to the one obtained by interchanging the roles of points and lines). Conclude, using the preceding exercise, that the symmetric group  $S_6$  admits an outer automorphism interchanging involutions of type  $(ab)$  with those of type  $(ab)(cd)(ef)$  [it is the only symmetric group admitting an outer automorphism].
17. Let  $\Delta$  be the geometric realization of the  $C_3$  chamber system of Example 2. Show that if every path in  $\Delta$  of the form  $(p, M, p', M', p)$ , where  $M$  and  $M'$  are lines on points  $p$  and  $p'$ , is null-homotopic then any closed path in  $\Delta$  can be deformed to a point. [HINT: first deform a closed path to a path consisting of edges of  $\Delta$  whose vertices are points and lines; any closed path of this form lying in a plane is null-homotopic].

18. In Example 2, let  $B$  denote the stabilizer of a chamber  $c$ , and let  $P_1, P_2$  and  $P_3$  be the stabilizers of the panels of  $c$  (indexed by the diagram, so  $P_3$  stabilizes  $(p, L)$ , where  $p$  is a point on a line  $L$ ). Show that if  $\sigma \in S_7$ , then  $P_2^\sigma$  is conjugate to  $P_2$  in  $A_7$ , and similarly for  $P_3$ , but not for  $P_1$  unless  $\sigma \in A_7$ . Thus  $S_7$  preserves 2-adjacency and 3-adjacency but not 1-adjacency. Define 1'-adjacency between chambers of  $C$  by  $c \sim_{1'} d$  if  $\sigma(c) \sim_1 \sigma(d)$  for  $\sigma \in S_7 - A_7$ . Show that this gives a rank 4 chamber system  $\hat{C}$  with diagram

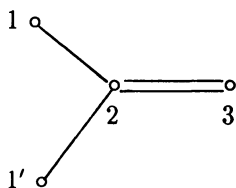

If  $\sigma$  normalizes  $B$ , then  $P_1^\sigma$  is the stabilizer of the 1'-panel of  $c$ , and  $\hat{C} = (A_7 : B, P_1, P_1^\sigma, P_2, P_3)$ . (The  $\{1, 2, 1'\}$ -residue is the building, of type  $A_3$ , for  $SL_4(2) \cong A_8$ , which admits  $A_7$  as a chamber-transitive automorphism group.)

## Chapter 5

### BN - PAIRS

This chapter deals with the relation between groups having a Tits system (also called a BN-Pair) and buildings. Parabolic subgroups are defined, and characterised as being those subgroups containing a chamber stabilizer  $B$ .

#### 1. Tits Systems and Buildings.

A *Tits System*, or *BN-Pair*, in a group  $G$  is a pair of subgroups  $B, N$  satisfying:

$$\text{BN0. } \langle B, N \rangle = G$$

**BN1.**  $H = B \cap N \triangleleft N$  and  $N/H = W$  is a Coxeter group with distinguished generators  $s_1, \dots, s_n$ .

**BN2.**  $BsBwB \subset BwB \cup BswB$  whenever  $w \in W$ , and  $s = s_i$ .

**BN3.**  $sBs \neq B$  for  $s = s_i$ .

**Note 1.** If  $n, n' \in N$  have the same image  $w \in W$ , then  $nB = n'B$ , so  $wB$  is well defined (cf. BN2).

**Note 2.** BN0 and BN2 imply that  $G = BNB$ .

**Note 3.** Taking inverses in (BN2) and replacing  $w$  by  $w^{-1}$  gives  $BwBsB \subset BwB \cup BwsB$ .

(5.1) **LEMMA.** (i) If  $BwB = Bw'B$  then  $w = w'$ , and hence  $G$  is the disjoint union  $\cup BwB$  (called the Bruhat decomposition).

(ii) If  $\ell(sw) > \ell(w)$  then  $BsBwB = BswB$ .

PROOF: (i) Without loss of generality  $\ell(w) \leq \ell(w')$ . Let  $w = sw_1$  where  $\ell(w_1) < \ell(w)$ . By assumption  $sw_1B \subset Bw'B$ . Therefore

$$w_1B \subset sBw'B \subset Bw'B \cup Bsw'B,$$

and so  $Bw_1B = Bw'B$  or  $Bsw'B$ . By induction on  $\ell(w)$  (the result obviously being true for  $\ell(w) = 0$  - i.e.,  $w = 1$ ), we have  $w_1 = w'$  or  $sw'$ . However  $w_1 \neq w'$  because  $\ell(w_1) < \ell(w')$ , so  $w_1 = sw'$ , and hence  $w = w'$ .

(ii) Again using induction on the length of  $w$ , we may assume that if  $\ell(v) < \ell(w)$ ,  $\ell(sv)$ ,  $\ell(vs')$ , then  $BsBvB = BsvB$  and  $BvBs'B = Bvs'B$  (cf. Note 3). Since  $w = vs'$  for some  $v$  and  $s'$ , with  $\ell(v) < \ell(w)$ , we have

$$\begin{aligned} BsBwB &= BsBvs'B = BsBvBs'B \\ &= BsvBs'B \\ &\subset BsvB \cup BswB. \end{aligned}$$

Moreover

$$BsBwB \subset BwB \cup BswB.$$

Now  $sv \neq w$ , otherwise  $v = sw$ , and since  $\ell(sw) > \ell(w)$  by hypothesis, this contradicts  $\ell(v) < \ell(w)$ ; hence  $BsvB \neq BwB$  by (i), and the result follows.  $\square$

If  $\Delta$  is a building, a group  $G$  of automorphisms of  $\Delta$  will be called *strongly transitive* if the following two conditions are satisfied:

- (i) for each  $w \in W$ ,  $G$  is transitive on ordered pairs of chambers  $(x, y)$  where  $\delta(x, y) = w$ .
- (ii) there is some apartment  $\Sigma$  whose stabilizer in  $G$  is transitive on the chambers of  $\Sigma$  (and hence induces the Coxeter group  $W$  on  $\Sigma$ ).

In the spherical case, strong transitivity is equivalent to transitivity on the set of all pairs  $(x, A)$  where  $x$  is a chamber in an apartment  $A$  (Exercise 4). In general, however, strong transitivity is a weaker condition; a strongly transitive group need not be transitive on the set of all apartments - an example will appear in Chapter 9 section 2.

The following two theorems explain the connection between strong transitivity and Tits systems. Before stating them we note that if  $\Delta$  is any chamber system and  $G$  a group of automorphisms of  $\Delta$  acting transitively

on the set of chambers, then the chambers of  $\Delta$  correspond to the left cosets  $gB$  where  $B$  is the stabilizer of a given chamber (we are taking group action on the left). Thus a double coset  $BwB$  consists of those chambers in the same suborbit as  $wB$  under the action of  $B$ . With this interpretation, axiom BN2 says that  $s$  sends a chamber in this suborbit to one either in the same suborbit or in the suborbit containing  $swB$ .

(5.2) THEOREM. *Let  $\Delta$  be a thick building admitting a strongly transitive group  $G$  of automorphisms, let  $\Sigma$  be as in the definition of strong transitivity, and let  $W$  be the corresponding Coxeter group. Let  $c$  be a given chamber of  $\Sigma$ , and let  $B = \text{stab}_G c$ ,  $N = \text{stab}_G N$ .*

*Then  $(B, N)$  is a Tits system, and*

$$\delta(c, d) = w \Leftrightarrow d \subset BwB$$

*where we are taking  $d$  to be a left coset of  $B$ .*

PROOF: Given  $g \in G$  let  $w = \delta(c, g(c))$ . By strong-transitivity there exists  $n \in N$  such that  $\delta(c, n(c)) = w$ , and  $b \in B$  such that  $g(c) = bn(c)$ , so  $g \in bnB \subset BwB$ ; this proves BN0. Conversely if  $g \in BwB$ , then  $g(c) = bn(c)$  for some  $b \in B$ , and hence  $\delta(c, g(c)) = \delta(c, bn(c)) = \delta(c, n(c)) = w$ . Thus we have shown

$$\delta(c, d) = w \Leftrightarrow d = gB \subset BwB.$$

**BN1.** By (2.2)  $B \cap N$  is the kernel of the action of  $N$  on  $\Sigma$ , so  $B \cap N \triangleleft N$ , and by strong transitivity  $N/B \cap N \cong W$ .

**BN2.** Let  $d = gB \subset BwB$  and suppose  $s \in N$  projects to  $s_i$ . We need to prove that  $\delta(c, s(d)) = w$  or  $sw$ . Since  $\delta(c, d) = w$ , we have  $\delta(s(c), s(d)) = w$ . Now let  $c'$  be the unique chamber nearest to  $s(d)$  in the  $i$ -residue containing  $c$  and  $s(c)$  (i.e.,  $c' = \text{proj}_\pi s(d)$  where  $\pi$  is the panel common to  $c$  and  $s(c)$ ). There are three cases:

- 1)  $c' \neq c$ ,  $s(c)$ : therefore  $\delta(c, s(d)) = \delta(s(c), s(d)) = w$  (and  $\ell(sw) < \ell(w)$ )
- 2)  $c' = s(c)$ : therefore  $\delta(c, s(d)) = s\delta(s(c), s(d)) = sw$  (and  $\ell(sw) > \ell(w)$ )
- 3)  $c' = c$ : therefore  $\delta(c, s(d)) = sw$  (and  $\ell(sw) < \ell(w)$ )

**BN3.** Using the thickness hypothesis, there is a third chamber  $d$  adjacent to both  $c$  and  $s(c)$ ; note that  $s(d) \neq c$  because  $s^2(c) = c$ . Now by strong transitivity there exists  $b \in B$  sending  $s(c)$  to  $d$ . Therefore

$$sbs(c) = s(d) \neq c.$$

Therefore  $sbs \notin B$ . □

(5.3) THEOREM. *Every Tits system  $(B, N)$  in a group  $G$  defines a building, the chambers being left cosets of  $B$ , with  $i$ -adjacency given by*

$$gB \underset{i}{\sim} hB \Leftrightarrow g^{-1}h \in B\langle s_i \rangle B.$$

Moreover  $\delta(B, gB) = w \Leftrightarrow gB \subset BwB$  where  $\delta$  is the distance function on this building,  $N$  stabilizes an apartment, and the action of  $G$  is strongly transitive.

PROOF: Define  $\delta(gB, hB) = w \Leftrightarrow g^{-1}h \in BwB$ . We must show there is a gallery of reduced type  $f$  from  $gB$  to  $hB$  if and only if  $\delta(gB, hB) = r_f$ . Since  $\delta$  is invariant under group action we restrict attention to  $\delta(c, d)$  where  $c = B$ .

Suppose  $\delta(c, d) = w = r_f$  with  $f$  reduced. Let  $f = jf'$  be reduced, with  $j \in I$ , and so  $w = sw'$  where  $s = s_j$  and  $w' = r_{f'}$ . Without loss of generality  $d = wB$ , so  $s(d) = swB = w'B$ . By induction on  $\ell(w)$  there is a gallery  $\gamma'$  of type  $f'$  from  $c$  to  $s(d)$ , and hence  $\gamma = (s(c), \gamma')$  has type  $jf' = f$  from  $s(c)$  to  $s(d)$ . Thus  $s^{-1}(\gamma)$  is a gallery of type  $f$  from  $c$  to  $d$ .

Conversely suppose there is a gallery  $\gamma = (c, c_1, \dots, d)$  of reduced type  $f = jf'$  from  $c$  to  $d$ ; once again set  $w = r_f$ ,  $w' = r_{f'}$  and  $s = s_j$ . Without loss of generality  $c_1 = s(c)$ , so  $s(\gamma) = (s(c), c, \dots, s(d))$ . Thus there is a gallery of type  $f'$  from  $c$  to  $s(d)$ , and by induction on  $\ell(w)$ ,  $s(d) \subset Bw'B$ . Therefore  $d \subset s^{-1}Bw'B = sBw'B \subset Bsw'B$  by (5.1). Therefore  $\delta(c, d) = sw' = w = r_f$ .

Finally let  $\Sigma$  be the set of  $n(c)$  for  $n \in N$ ; by (BN1) this is the set of  $wB$  as  $w$  ranges over  $W$ . By definition  $\delta(wB, w'B) = w^{-1}w'$ , so  $\Sigma$  is isometric to  $W$  and is hence an apartment, and  $N$  induces  $W$  on  $\Sigma$ . Furthermore if  $\delta(B, gB) = w$ , then  $gB = bwB$  for some  $b \in B$ , so  $b$  sends the pair  $(B, wB)$  to  $(B, gB)$  showing  $G$  is strongly transitive.  $\square$

### Remarks.

1. The thickness assumption of (5.1) was only used to prove (BN3), and (BN3) was not used in (5.2); so one sees that thickness is equivalent to (BN3).
2. A building  $\Delta$  with a strongly transitive automorphism group determines a Tits system by (5.2), and by (5.3) this in turn determines a building, which is obviously isomorphic to  $\Delta$ . On the other hand, given a Tits system in a group  $G$  we obtain a building  $\Delta$ , but  $G$  is not uniquely determined by  $\Delta$ . For example  $G$  might be  $SL_n(k)$ : its centre

acts trivially on  $\Delta$  and therefore does not appear in  $\text{Aut } \Delta$  (the automorphism group of  $\Delta$ ). Moreover  $\text{Aut } \Delta$  contains more than  $PSL_n(k)$ ; it is generated by  $PGL_n(k)$  together with field automorphisms.

3. Even in a given group there can be more than one Tits system giving the same building. The subgroup  $B$  is uniquely determined because it has to be a chamber stabilizer, but  $N$  can often be replaced by one of its subgroups (see Exercise 1).

**Example.** For  $G = GL_{n+1}(k)$  take:

$$B = \text{upper triangular matrices } \begin{bmatrix} * & & * \\ & \ddots & \\ 0 & & * \end{bmatrix}$$

$N =$  matrices with one non-zero entry in each row and column (permutation matrix  $\times$  diagonal matrix)

$$B \cap N = \text{diagonal matrices}$$

Here  $W \cong S_{n+1}$  with distinguished generators  $s_1, \dots, s_n$ , where  $s_i$  is the image of those permutation matrices which are zero off the diagonal except in positions  $(i, i+1)$  and  $(i+1, i)$ . The building in this case is that of Example 4 in Chapter 1 (where the chambers are the maximal flags of projective  $n$ -space).

## 2. Parabolic Subgroups.

For any subset  $J \subset I$ , recall from Chapter 2 that  $W_J = \langle s_j | j \in J \rangle$  (see (2.14)). We now let  $P_J = BW_JB$  denote the union of the double cosets  $BwB$  over all  $w \in W_J$ ; by BN2,  $P_J$  is a subgroup of  $G$ . A *parabolic subgroup* is a conjugate of one of the  $P_J$ ; the conjugates of  $B = P_\emptyset$  are also called *Borel subgroups*.

- (5.4) THEOREM. (i) The subgroups containing  $B$  are precisely the  $P_J$ .  
(ii)  $P_J \cap P_K = P_{J \cap K}$ , and  $\langle P_J, P_K \rangle = P_{J \cup K}$ .  
(iii)  $N_G(P_J) = P_J$ , and  $P_J$  is the stabilizer of the  $J$ -residue containing  $c$ .  
(iv) There is a bijection of double coset spaces  $W_J \backslash W / W_K \rightarrow P_J \backslash G / P_K$  defined by  $W_J w W_K \mapsto P_J w P_K$ .

PROOF: (i) Let  $P$  be a subgroup containing  $B$ , and let  $J = \{j \in I | Bs_jB \subset P\}$ ; we claim  $P_J = P$ . Since  $P_J$  is generated by the  $Bs_jB$  for  $j \in J$  (immediate from (5.1)(ii)), we have  $P_J \subset P$ . Conversely suppose  $BwB \subset P$  and let  $w = sw'$  where  $\ell(w') < \ell(w)$ . Since  $BwB = BsBw'B$  it suffices, by



induction on  $\ell(w)$ , to show  $BsB \subset P$ ; to do this let  $d$  be a third chamber in the rank 1 residue containing  $c$  and  $s(c)$  (this uses (BN3)) - see Figure 5.1.

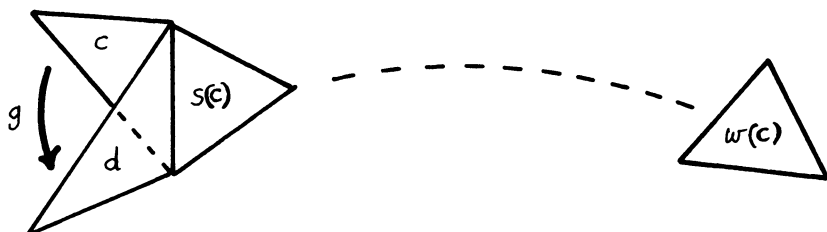

Figure 5.1

The stabilizer of  $w(c)$ , namely  $wBw^{-1}$ , is transitive on chambers at some given distance from  $w(c)$ , and since  $\delta(c, w(c)) = w = \delta(d, w(c))$ , there exists  $g \in wBw^{-1} \subset P$  sending  $c$  to  $d$ . Since  $\delta(c, d) = s$  we have  $g \in BsB$ , hence  $BsB \subset P$ , completing the proof.

(ii) The fact that  $P_J \cap P_K = P_{J \cap K}$  follows immediately from  $W_J \cap W_K = W_{J \cap K}$  (Exercise 3 of Chapter 2). To see that  $\langle P_J, P_K \rangle = P_{J \cup K}$  we note that by (i),  $\langle P_J, P_K \rangle = P_L$  for some  $L$  containing  $J$  and  $K$ ; but  $P_J, P_K \subset P_{J \cup K}$ , so  $L \subset J \cup K$ , and hence  $L = J \cup K$ .

(iii) Let  $R$  be the  $J$ -residue containing  $c$ ; its chambers are all  $x$  for which  $\delta(c, x) \in W_J$ , and so for  $g \in G$ , we have

$$g(R) = R \Leftrightarrow \delta(c, g(c)) \in W_J \Leftrightarrow g \in P_J.$$

To show these  $P_J$  are self-normalizing, note that by (i)  $N_G(P_J) = P_K$  for some  $K \supset J$ . If  $i \in K$  then  $s_i B s_i = s_i B s_i^{-1} \subset P_J$ . Moreover by BN2 and BN3,  $s_i B s_i \cap B s_i B \neq \emptyset$  and therefore  $P_J$  must contain the double coset  $B s_i B$ , showing  $i \in J$  and so  $J = K$ .

(iv) Using (5.1)(ii) it is a straightforward exercise to see that  $P_J w P_K = B W_J w W_K B$ , and hence the map  $W_J w W_K \mapsto P_J w P_K$  is well-defined. Moreover by (5.1)(i) it is both injective and surjective.  $\square$

**Example.** In the example of  $GL_{n+1}(k)$  above, let  $J = \{t, t+1, \dots, t+m-1\} \subset \{1, \dots, n\} = I$ . Then  $P_J$  has  $GL_{m+1}(k)$  as a quotient group, and consists of all matrices, as shown below, which are zero below the diagonal

except in the  $m \times m$  block whose top left corner occupies the diagonal position  $(t, t)$ .

$$\left[ \begin{array}{cccc} * & & & * \\ & \ddots & & \\ & & \boxed{GL_m(k)} & \\ & & & \ddots \\ 0 & & & * \end{array} \right]$$

**Notes.** The axioms for a BN-Pair were given by Tits [1962]; for the genesis of these ideas see Tits [1974] page IX, where work of Curtis [1964] is also mentioned. The subgroups  $B$  and  $N$  appear in a natural way in the theory of linear algebraic groups:  $B$  is a maximal, connected, solvable subgroup (called a Borel subgroup, after A. Borel), and  $N$  is the normalizer of a torus.

### Exercises to Chapter 5

1. In the  $GL_{n+1}(k)$  example of this chapter, let  $N_0$  be the group of permutation matrices. Show that  $(B, N_0)$  is also a BN-pair for  $G$  determining the same building as  $(B, N)$ ; notice that  $B \cap N_0 = 1$ , and  $N_0 \cong W$ .
2. Set  $H_1 = \bigcap_{n \in N} nBn^{-1}$ . A BN-Pair  $(B, N)$  is called *saturated* if  $H_1 = B \cap N$ . If  $\Sigma$  is the apartment stabilized by  $N$ , show that  $\text{Stab}_G \Sigma = N$  if and only if  $(B, N)$  is saturated. In general show that  $(B, NH_1)$  is saturated, and determines the same building as  $(B, N)$ .
3. Let  $K$  be the kernel of the action of  $G$  on the building determined by a Tits system  $(B, N)$ . Show that  $K$  is the largest normal subgroup of  $G$  contained in  $B$ .
4. Show that for buildings of spherical type, strong transitivity is equivalent to transitivity on pairs  $(x, A)$  where  $x$  is a chamber in an apartment  $A$ .
5. If  $P_J$  is conjugate to  $P_K$  show that  $J = K$ .
6. If  $\nu: N \rightarrow W$  is the natural projection, let  $N_J = \nu^{-1}(W_J)$ . Show that  $N_J = N \cap P_J$  and that  $(B, N_J)$  is a BN-pair for  $P_J$ .
7. Let  $K$  be a normal subgroup of  $G$ . If  $BK = P_J$  then show that for  $i \in I - J$  and  $j \in J$  one has  $m_{ij} = 2$  (i.e.,  $s_i$  and  $s_j$  commute). In

particular if the diagram is connected then either  $K < B$  or  $BK = G$ . [HINT: Show  $Bs_j \cap K \neq \emptyset$ , hence  $s_i^{-1}Bs_js_i \cap P_J \neq \emptyset$ , and therefore  $Bs_js_i \cap s_iBwB \neq \emptyset$  for some  $w \in W_J$ ; apply (5.1)].

8. Suppose  $G$  has a Tits system  $(B, N)$  with a connected diagram, and suppose  $B$  is solvable and  $G$  perfect. Show that any normal subgroup of  $G$  lies in  $B$ ; moreover if  $G$  acts faithfully on the building determined by  $(B, N)$  then  $G$  is simple.
9. Let  $\Delta$  be the building for  $GL_3(k)$ , i.e. vertices are 1- and 2-spaces of a 3-dimensional vector space  $V$  over  $k$  (and edges are given by containment); here  $W \cong D_6$ . Then let  $\Delta'$  denote the barycentric subdivision of  $\Delta$  (i.e., obtained by interposing an additional vertex in the middle of each edge of  $\Delta$ );  $\Delta'$  is a non-thick building with  $W \cong D_{12}$ . Let  $\sigma$  be an isomorphism switching  $V$  with its dual; obviously  $\sigma$  acts on  $\Delta$  switching 1-spaces with 2-spaces. Let  $G$  be the group generated by  $\sigma$  and  $GL_3(k)$ . Show that  $G$  acts strongly transitively on  $\Delta'$  and use this to verify that  $G$  has a "weak Tits system", i.e., satisfying BN0, BN1, BN2, but not BN3.

## Chapter 6

### BUILDINGS OF SPHERICAL TYPE AND ROOT GROUPS

A building of *spherical type* is one for which  $W$  is finite (so each apartment is a triangulation of a sphere - see Chapter 2 section 4). A powerful theorem in Chapter 4 of Tits [1974], repeated here without proof as (6.6), shows that a spherical building admits non-trivial automorphisms when the rank is at least three. Moreover if each connected component of the diagram has rank at least 3, this implies (6.7) that a thick spherical building necessarily admits “root groups”, and these generate a group with a BN-pair. All buildings in this chapter will be thick, and also spherical, except in section 4 when we discuss a generalization of “root groups” to non-spherical buildings.

#### 1. Some Basic Lemmas.

An important fact about finite Coxeter complexes  $W$  is that every chamber has a unique opposite, and  $W$  is the convex hull of any two opposite chambers (see Theorem (2.15)). In a spherical building two chambers are called *opposite* if they are opposite in some apartment containing them, in which case this apartment is unique as it is the convex hull of  $x$  and  $y$  (cf. Exercise 5 in Chapter 3). Notice that if  $d = \text{diam}(W)$ , then  $x$  and  $y$  are opposite if and only if  $d(x, y) = d$ .

One of the first things we want to do is to extend the idea of opposites to all simplexes of a spherical building; we first deal with panels.

(6.1) LEMMA. *Let  $\pi$  be a panel (of type  $i$ ) on chambers  $x$  and  $x'$  in an apartment  $A$ . If  $y$  and  $y'$  denote the chambers of  $A$  opposite  $x$  and  $x'$  respectively, then  $y$  and  $y'$  are adjacent. Moreover if  $\pi'$  is the panel (of*

type  $i'$ ) common to  $y$  and  $y'$ , then  $\pi$  and  $\pi'$  determine the same wall of  $A$ , and  $r_{i'} = w_o^{-1}r_i w_o$  where  $w_o$  is the longest word of  $W$ .

PROOF: Since  $x'$  is opposite  $y'$  and adjacent to  $x$ , we have  $d(x, y') = d - 1$ . Moreover by (2.15) (iv)  $y'$  lies on a minimal gallery from  $x$  to  $y$ , so

$$d(y', y) = d(x, y) - d(x, y') = 1$$

showing  $y$  and  $y'$  are adjacent. Now if  $\alpha$  is the root of  $A$  containing  $x$  but not  $x'$ , then  $y \in -\alpha$  and  $y' \in \alpha$  so the wall  $\partial\alpha$  contains both  $\pi'$  and  $\pi$ .

For the final statement, treat  $A$  as the Coxeter complex  $W$ , in which case  $x' = xr_i$ ,  $y = xw_o$ ,  $y' = x'w_o$  and  $y' = yr_{i'}$ . Thus  $xw_or_{i'} = xr_iw_o$ , so  $r_{i'} = w_o^{-1}r_iw_o$ .  $\square$

For an apartment  $A$ , let  $\text{op}_A : A \rightarrow A$  denote the map sending each chamber of  $A$  to its opposite; we call it the *opposition involution*. Although  $\text{op}_A$  is not necessarily an automorphism, Lemma (6.1) shows that it sends  $i$ -adjacency to  $i'$ -adjacency where  $r_iw_o = w_or_{i'}$ . It is an automorphism if and only if  $i' = i$  for all  $i \in I$ , in which case  $\text{op}_W = w_o \in W$ . Notice that the opposition involution induces a symmetry of the diagram, and so  $\text{op}_W = w_o$  whenever the diagram exhibits no non-trivial symmetry (e.g.,  $C_n$  for  $n \geq 3$ ). For types  $A_n$  and  $E_6$  it reverses the diagram (Exercise 1), and for  $D_n$  it induces a non-trivial symmetry precisely when  $n$  is odd (Exercise 2). Finally, as mentioned in Chapter 2 section 4, a finite Coxeter group  $W$  preserves a dot product on  $\mathbf{R}^n$ , and the Coxeter complex can be taken as a triangulation of the  $(n - 1)$ -sphere  $S^{n-1}$ ;  $\text{op}_W$  is then simply the antipodal map, sending  $v$  to  $-v$  for all  $v \in \mathbf{R}^n$ .

We now define two simplexes of  $W$  to be *opposite* if they are interchanged by  $\text{op}_W$ . More generally, two simplexes of a spherical building are *opposite* if they are opposite in some apartment containing them (hence in every such apartment, by Exercise 7 of Chapter 3).

(6.2) LEMMA. *Given opposite panels  $\pi$  and  $\pi'$  in a spherical building, and chambers  $x \in St(\pi)$  and  $y \in St(\pi')$  one has  $d(x, y) = d$  unless  $x = \text{proj}_\pi y$  in which case  $d(x, y) = d - 1$ . In particular  $\text{proj}_\pi | St(\pi')$  is inverse to  $\text{proj}_{\pi'} | St(\pi)$ . (Recall that  $\text{proj}_\pi x$  is the unique chamber of  $St(\pi)$  nearest  $x$ ).*

PROOF: It suffices to show that  $x$  is opposite some (hence all but one) chamber on  $\pi'$ , but of course if  $A$  is any apartment containing  $x$  and  $\pi'$ , then  $x$  is opposite  $\text{op}_A(x)$  which has  $\pi' = \text{op}_A(\pi)$  as a panel.  $\square$

Recall that a *root* of a building is a root in an apartment of that building (i.e., a half-apartment).

(6.3) LEMMA. *Let  $\alpha$  be a root in a spherical building, and  $x$  a chamber having a panel  $\pi$  in  $\partial\alpha$ . Then there is a unique root containing  $x$  and  $\partial\alpha$ , and if  $x \notin \alpha$  there is a unique apartment containing  $x$  and  $\alpha$ .*

PROOF: By (6.1)  $\partial\alpha$  contains a panel  $\pi'$  opposite  $\pi$ . Let  $y' = \text{proj}_{\pi'} x$ , and let  $y$  denote the chamber of  $\alpha$  on  $\pi'$ , so  $x' = \text{proj}_{\pi} y$  is the chamber of  $\alpha$  on  $\pi$  - see Figure 6.1.

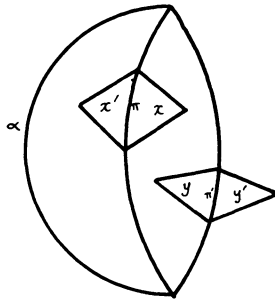

Figure 6.1

By (6.2)  $d(x, y') = d - 1 = d(x', y)$ , so by Exercise 5 the convex hull of  $x$  and  $y'$  is a root we call  $\beta$ , and similarly  $\alpha$  is the convex hull of  $x'$  and  $y$ . If  $x \notin \alpha$ , then by (6.2)  $x$  is opposite  $y$ , and we let  $A$  be the unique apartment containing  $x$  and  $y$ . Since  $A$  contains  $x'$  it contains  $\alpha$ , completing the proof.  $\square$

Before stating our next proposition we introduce the notation  $E_1(c)$  to mean the set of chambers adjacent to  $c$ .

(6.4) PROPOSITION. *Let  $c$  and  $b$  be opposite chambers of a spherical building (assumed to be thick of course), and suppose  $\varphi$  is an automorphism fixing  $b$  and all chambers of  $E_1(c)$ . Then  $\varphi$  is the identity.*

PROOF: By connectivity (and induction along a gallery from  $b$ ) it suffices to show that if  $b' \sim b$ , then  $\varphi$  fixes  $b'$  and all chambers of  $E_1(c')$  for some  $c'$  opposite  $b'$ . Let  $\pi$  be the common panel of  $b$  and  $b'$ , and let  $\sigma$  be the panel of  $c$  opposite  $\pi$ . By (6.2)  $b' = \text{proj}_{\pi} x$  for some  $x \in St(\sigma)$ , hence  $\varphi$  fixes  $b'$ ;

and since  $b'$  may be chosen arbitrarily  $\varphi$  fixes all chambers of  $E_1(b)$ . If  $b'$  is opposite  $c$  we are done, so suppose not. Using the thickness assumption there exists a chamber  $c'$  of  $St(\sigma)$  opposite both  $b$  and  $b'$  (namely any  $c' \in St(\sigma)$  with  $c' \neq \text{proj}_\sigma b$  or  $\text{proj}_\sigma b'$ ). Since  $\varphi$  fixes  $c'$  and  $E_1(b)$ , the argument above shows it fixes  $E_1(c')$ , concluding the proof.  $\square$

**Remark.** Without the thickness assumption (always valid in this Chapter) the above Proposition is false; see Exercise 18.

## 2. Root Groups and the Moufang Property.

For any root  $\alpha$  (i.e., half-apartment) in a spherical building, let

$$U_\alpha = \{g \in \text{Aut } \Delta \mid g \text{ fixes every chamber having a panel in } \alpha - \partial\alpha\}.$$

This will be called a *root group* if the diagram has no isolated nodes. In fact given this condition on the diagram there is a chamber  $c \in \alpha$  such that no panel of  $c$  is in  $\partial\alpha$  (see Exercise 7), or equivalently such that every chamber of  $E_1(c)$  has a panel in  $\alpha - \partial\alpha$ . Since any apartment  $A$  containing  $\alpha$  contains a chamber opposite  $c$ , it is immediate from (6.4) that only the identity of  $U_\alpha$  fixes  $A$ . If for each root  $\alpha$ ,  $U_\alpha$  is transitive, and hence simple-transitive, on the set of apartments containing  $\alpha$ , we call the building *Moufang*. In fact it suffices to assume this condition for the roots  $\alpha$  in a given apartment  $\Sigma$ . Indeed if  $g$  sends  $\alpha$  to  $\beta$ , then  $gU_\alpha g^{-1} = U_\beta$ , and it is not difficult to show that for those  $\alpha$  in  $\Sigma$  the  $U_\alpha$  generate a group having a BN-Pair (see 6.16); in the spherical case such a group is transitive on the set of apartments, hence on the set of roots, so each  $U_\beta$  acts in the required manner. Notice that by (6.3) the set of apartments containing  $\alpha$  corresponds bijectively to the set of chambers  $x \notin \alpha$  on some given panel  $\pi$  of  $\partial\alpha$ ; if the chambers of  $St(\pi)$  correspond to the points of a projective line, as they do in many cases, then  $U_\alpha$  is the translation group of this line, isomorphic to the additive group of the field (cf. Example 1 below).

(6.5) LEMMA. *If  $\alpha$  contains a chamber  $c$  having no panel in  $\partial\alpha$ , and if  $U_\alpha$  is transitive on apartments containing  $\alpha$  (e.g. as in the Moufang case), then*

$$U_\alpha = \{g \in \text{Aut } \Delta \mid g \text{ fixes } \alpha \text{ and every chamber of } E_1(c)\}.$$

PROOF: Exercise.  $\square$

**Example 1.** Let  $\Delta$  be the building of Example 4 in Chapter 1, where the chambers are the maximal flags  $V_1 \subset \dots \subset V_n$  of an  $(n + 1)$ -dimensional vector space  $V$  over  $k$ . As explained in Chapter 1, a basis  $e_1, \dots, e_{n+1}$  of  $V$  determines an apartment  $A$  of  $\Delta$ , whose chambers are all maximal flags  $\langle e_{\sigma(1)} \rangle \subset \dots \subset \langle e_{\sigma(1)}, \dots, e_{\sigma(n)} \rangle$  as  $\sigma$  ranges over  $S_{n+1}$ . The reflection  $r$  switching  $e_i$  with  $e_j$  determines two opposite roots of  $A$ , which we call  $\alpha$  and  $-\alpha$ . Writing matrices with respect to the basis  $e_1, \dots, e_{n+1}$ , the root groups  $U_\alpha$  and  $U_{-\alpha}$  are (after possibly interchanging  $\alpha$  and  $-\alpha$ ) the groups of matrices having 1 in each diagonal position and 0 in every other position except the  $(i, j)$  position for  $U_\alpha$ , and the  $(j, i)$  position for  $U_{-\alpha}$  (see Exercise 11). Notice that  $U_\alpha$  and  $U_{-\alpha}$  are isomorphic to the additive group of the field  $k$ .  $\square$

Extending the  $E_1(c)$  notation, we let  $E_2(c)$  denote the set of chambers lying in one of the rank 2 residues containing  $c$  - i.e. having a face of codimension 2 in common with  $c$ . If  $\Delta$  has rank 2, then of course  $E_2(c) = \Delta$ . The following very strong theorem is (4.16) of Tits [1974], and we shall not prove it here.

(6.6) **THEOREM.** *Let  $A$  and  $A'$  be apartments containing chambers  $c$  and  $c'$ , in spherical buildings  $\Delta$  and  $\Delta'$  respectively. Then any isomorphism from  $E_2(c) \cup A$  to  $E_2(c') \cup A'$  extends to an isomorphism from  $\Delta$  to  $\Delta'$ .*  $\square$

(6.7) **COROLLARY.** *If  $\Delta$  is a spherical building such that each connected component of the diagram has rank  $\geq 3$ , then  $\Delta$  is Moufang.*

**PROOF:** The condition on the diagram ensures that any root  $\alpha$  contains a chamber  $c$  none of whose faces of codimension 1 or 2 lies in  $\partial\alpha$  (see Exercise 8), in which case  $E_2(c) \cap A \subset \alpha$  for any apartment  $A$  containing  $\alpha$ . Therefore if  $A$  and  $A'$  are apartments containing  $\alpha$ , then the isomorphism from  $A$  to  $A'$  fixing  $\alpha$  must also fix  $E_2(c) \cap A$ , and hence can be extended by the identity to an automorphism from  $E_2(c) \cup A$  to  $E_2(c') \cup A'$ . By Theorem 6.6 this extends to an automorphism  $g$  of  $\Delta$  fixing  $\alpha$  and all chambers of  $E_2(c)$ , and sending  $A$  to  $A'$ . It remains to show that  $g$  fixes all chambers having a panel  $\pi$  in  $\alpha - \partial\alpha$ ; this is Exercise 9.  $\square$

Not all rank 2 spherical buildings are Moufang; for example many non-Moufang projective planes are known, and the generalized quadrangle constructed in Exercise 20 of Chapter 3 is not Moufang if  $k$  is a field with at least 4 elements. Moreover Exercise 21 of Chapter 3 constructed “free” generalized  $m$ -gons and these have zero probability of being Moufang. However



the following theorem eliminates non-Moufang  $m$ -gons from consideration as residues in higher rank cases.

(6.8) THEOREM. *If  $\Delta$  is Moufang, so is every residue whose residual subdiagram does not contain isolated nodes (so that the term Moufang applies).*

PROOF: Let  $R$  be such a residue;  $\alpha_o$  a root of  $R$ , and  $\pi \in \partial\alpha_o$  a panel of the chamber  $c \in \alpha_o$ ; we must show  $U_{\alpha_o}$  is transitive on  $St(\pi) - \{c\}$ . By (3.6),  $\alpha_o$  lies in an apartment  $A$  of  $\Delta$  (if  $R$  has type  $J$ ,  $\alpha_o$  is isometric to a subset of  $W_J$ , hence also of  $W$ ), and if  $\alpha$  denotes the root of  $A$  such that  $c \in \alpha$  and  $\pi \in \partial\alpha$ , then  $\alpha_o \subset \alpha$ , and  $U_\alpha \subset U_{\alpha_o}$ . Now since  $\Delta$  is Moufang,  $U_\alpha$  is transitive on  $St(\pi) - \{c\}$  (and in fact  $U_\alpha = U_{\alpha_o}$ ), completing the proof.  $\square$

The following remarkable theorem was proved by Tits [1976/79] and Weiss [1979] (see Appendix 1 for more details).

(6.9) THEOREM. (Tits-Weiss): *Moufang generalized  $m$ -gons can exist only for  $m = 3, 4, 6$  and  $8$ .*

PROOF: Given in Appendix 1.  $\square$

**Remark.** There do indeed exist Moufang  $m$ -gons for  $m = 3, 4, 6$  and  $8$  (see Appendix 2 for more details).

(6.10) COROLLARY. *There is no (thick) building whose diagram has an  $H_3$  (i.e.  $\circ \text{---} \circ \text{---}^5 \circ$ ) subdiagram.*

PROOF: By (6.7) an  $H_3$  residue is Moufang, and by (6.8) it contains Moufang 5-gons, which do not exist.  $\square$

### 3. Commutator Relations.

In this section we consider the commutator  $[U_\alpha, U_\beta]$  of two root groups, but first we prove a lemma in the rank 2 case. Let  $\Sigma$  be an apartment of a Moufang  $m$ -gon (i.e.,  $\Sigma$  is a  $2m$ -gon), let  $\Lambda$  be a gallery of  $\Sigma$  having at least three chambers, and let  $c$  be an interior chamber of  $\Lambda$ . If  $\Lambda$  is contained in a root, let  $U_1, \dots, U_k$  be the root groups in a natural cyclic order for those roots of  $\Sigma$  containing  $\Lambda$ .

(6.11) LEMMA. *The group  $X$  fixing  $\Lambda$  and all chambers of  $E_1(c)$  is the product  $U_1 \dots U_k$ , unless  $\Lambda$  lies in no root in which case  $X$  is the identity.*

PROOF: If  $\Lambda$  lies in no root then  $\Sigma$  is the only apartment containing it; in this case  $X$  fixes  $E_1(c)$  and a chamber opposite  $c$ , and is therefore the

identity by (6.4). Now suppose  $\Lambda$  lies in a root  $\alpha$ ; then  $U_\alpha$  fixes  $\Lambda$  and  $E_1(c)$ , so  $U_1 \dots U_k \subset X$ . Conversely let  $g \in X$ . If  $v$  is an end vertex of  $\Lambda$ , and  $w \notin \Lambda$  the next vertex in  $\Sigma$  (see Figure 6.2), then there exists  $u \in U_1$  (or  $U_k$ , but without loss of generality we take it to be  $U_1$ ) such that  $u(w) = g(w)$ .

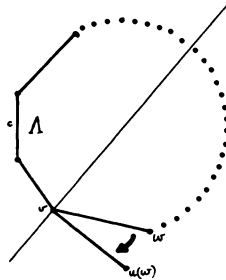

Figure 6.2

Letting  $\Lambda'$  denote  $\Lambda$  plus the edge  $vw$ , we see that  $u^{-1}g$  fixes  $\Lambda'$  and all chambers of  $E_1(c)$ ; by a simple induction  $u^{-1}g \in U_2 \dots U_k$  and hence  $X \subset U_1 \dots U_k$ . □

Now let  $\Sigma$  be an apartment in a spherical building, and let  $\Phi$  denote the set of roots of  $\Sigma$ . For roots  $\alpha, \beta \in \Phi$  such that  $\alpha \neq \pm\beta$ , we set

$$[\alpha, \beta] = \{\gamma \in \Phi \mid \alpha \cap \beta \subset \gamma\}.$$

Regarding  $\Sigma$  as a sphere (see the remarks on sphericity in Chapter 2 section 4), its roots are hemispheres and the condition  $\alpha \neq \pm\beta$  implies that the walls  $\partial\alpha$  and  $\partial\beta$  intersect (transversely), and hence  $\partial\alpha \cap \partial\beta$  has codimension 2. If  $\sigma$  is any codimension 2 simplex in  $\partial\alpha \cap \partial\beta$ , then its opposite  $\sigma'$  also lies in  $\partial\alpha \cap \partial\beta$ , and if  $\gamma \in [\alpha, \beta]$  then  $\sigma$  and  $\sigma'$  lie in the wall  $\partial\gamma$  (see Exercise 4). Thus  $\gamma \cap St(\sigma)$  is a root in the rank 2 apartment  $\Sigma \cap St(\sigma)$ . Moreover  $\gamma$  is the unique root of  $\Sigma$  containing  $\gamma \cap St(\sigma)$  and with  $\sigma \in \partial\gamma$ , so there is no loss in considering  $[\alpha, \beta]$  in the rank 2 residue  $St(\sigma)$  (more precisely  $[\alpha, \beta] \cap St(\sigma) = [\alpha \cap St(\sigma), \beta \cap St(\sigma)]$ ). See Figure 6.3 for an illustration

in the rank 3 case:

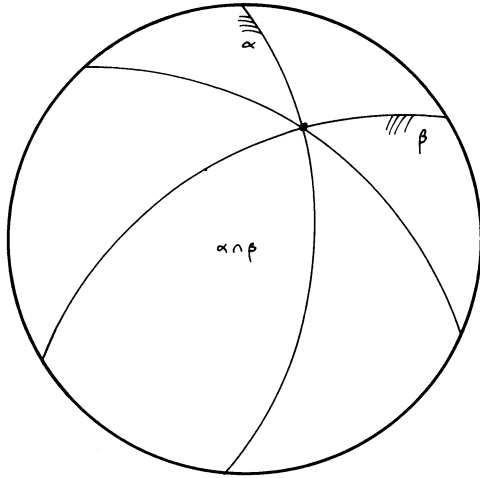

Figure 6.3

If the rank of  $\Sigma$  is greater than 3, then  $\partial\alpha \cap \partial\beta$  is connected and there are several choices for  $\sigma$  and  $\sigma'$ .

We next observe that since the elements of  $U_\gamma$  are uniquely determined by their action on the chambers of  $St(\pi)$  for any panel  $\pi \in \partial\gamma$ , we may take  $\pi \in St(\sigma)$ , in which case it is clear that  $U_\gamma$  is identical to the root group  $U_{\gamma \cap St(\sigma)}$  defined on the rank 2 residue  $St(\sigma)$ . Furthermore if  $g \in \langle U_\gamma \mid \gamma \in [\alpha, \beta] \rangle$  is the identity on  $St(\sigma)$ , then it is the identity on  $\Delta$  (because each  $U_\gamma$  fixes the simplex of  $\Sigma$  opposite  $\sigma$ , so by Exercise 6,  $g$  fixes  $\Sigma$ , and by (6.4)  $g$  is the identity). In particular when we consider the commutator  $[U_\alpha, U_\beta]$  we may restrict our attention to a single rank 2 residue.

Finally we set  $(\alpha, \beta) = [\alpha, \beta] - \{\alpha, \beta\}$ , and for any set  $\Psi$  of roots we write  $U_\Psi = \langle U_\alpha \mid \alpha \in \Psi \rangle$ .

(6.12) THEOREM. *In a Moufang building of spherical type, one has:*

(i) for roots  $\alpha, \beta \in \Phi$  with  $\alpha \neq \pm\beta$

$$[U_\alpha, U_\beta] \leq U_{(\alpha, \beta)}$$

(ii) Let  $\{\beta_1, \dots, \beta_k\} = [\beta_1, \beta_k]$  in the natural cyclic order. Then the commutator relation above implies that

$$U_{[\beta_1, \beta_k]} = U_{\beta_1} \dots U_{\beta_k}$$

In particular  $U_{\beta_1} \dots U_{\beta_k} = U_{\beta_k} \dots U_{\beta_1}$ .

PROOF: (i) As observed above it suffices to work in the rank 2 case (i.e. in an apartment of  $St(\sigma)$  for some  $\sigma$  in  $\partial\alpha \cap \partial\beta$ ). In this rank 2 apartment  $\Sigma$ , let  $x$  and  $y$  be the end vertices of  $\alpha \cap \beta$  with  $x$  in the interior of  $\alpha$  - see Figure 6.4.

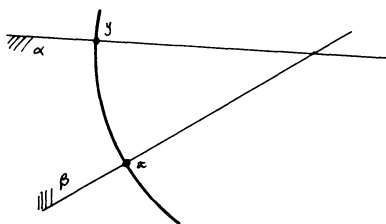

Figure 6.4

If  $e$  is a chamber on  $x$ , then  $U_\alpha$  fixes  $e$ ; hence  $[U_\alpha, U_\beta]$  fixes  $e$ , and similarly any chamber on  $y$ . Now let  $\Lambda$  denote  $\alpha \cap \beta$  plus the other chamber in  $\Sigma$  on  $x$ , and that on  $y$ . Certainly  $\Lambda$  contains at least one interior chamber  $c$ , and  $[U_\alpha, U_\beta]$  fixes all of  $E_1(c)$  and  $\Lambda$ . Since  $(\alpha, \beta)$  is the set of roots containing  $\Lambda$ , (6.11) implies  $[U_\alpha, U_\beta] \leq U_{(\alpha, \beta)}$ .

(ii) By induction on  $k$ , it suffices to show that if  $u_i \in U_{\beta_i}$  for  $i = 1, \dots, k$ , then  $u_k u_1 \dots u_{k-1} \in U_{\beta_1} \dots U_{\beta_k}$ . By part (i)  $u_k u_1 \dots u_{k-1} = u_1 u_k v u_2 \dots u_{k-1}$  where  $v \in U_{\beta_2} \dots U_{\beta_{k-1}}$ , and the induction hypothesis shows  $v u_2 \dots u_{k-1} = v_2 \dots v_{k-1}$  where  $v_i \in U_{\beta_i}$ . Repeating this procedure on  $u_k v_2 \dots v_{k-1}$ , an obvious induction completes the proof.  $\square$

Our next proposition shows that if  $\alpha$  and  $\beta$  are roots containing a chamber  $c$  with a panel in  $\partial\alpha$  and a panel in  $\partial\beta$ , then  $[U_\alpha, U_\beta]$  is non-trivial, unless the walls  $\partial\alpha$  and  $\partial\beta$  are perpendicular. More precisely consider a rank 2 apartment  $\Sigma$  having  $2m$  chambers, with  $m \geq 3$ , and let  $c$  be a chamber of  $\Sigma$ . If  $\beta_1, \dots, \beta_m$  denote the roots of  $\Sigma$  containing  $c$ , in one of two natural cyclic orders, then for  $x \in U_{\beta_1}$  and  $y \in U_{\beta_m}$ , (6.12) yields

$$[x, y] = z_2 \dots z_{m-1}$$

where  $z_i \in U_{\beta_i}$ . We shall write  $[x, y]_t$  for  $z_t$ .

(6.13) PROPOSITION. Let  $m \geq 3$  and let  $x \in U_{\beta_1} - \{1\}$ . Then with the notation above,  $y \mapsto [x, y]_2$  is an isomorphism from  $U_{\beta_m}$  to  $U_{\beta_2}$ . Furthermore if  $m = 3$  then the root groups are abelian.

PROOF: Let  $d, e$  be the chambers of  $\beta_2 - \beta_1, \beta_3 - \beta_2$  respectively, and let  $\pi$  be the panel common to  $d$  and  $e$  - see Figure 6.5; we also define  $d' = x^{-1}(d)$  and  $\pi' = x^{-1}(\pi)$ .

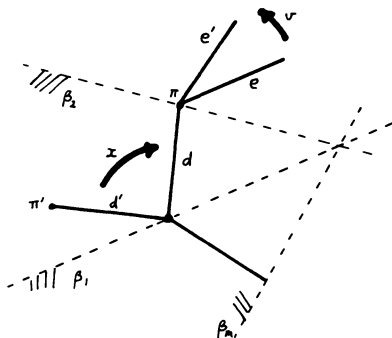

Figure 6.5

We claim first that  $U_{\beta_m}$  acts simple-transitively on  $St(\pi') - \{d'\}$ . Indeed if  $g \in U_{\beta_{m+1}}$  sends  $d'$  to  $c$ , then  $gU_{\beta_m}g^{-1} = U_{\beta_m}$  by (6.12), and hence  $U_{\beta_m}$  acts the same way on  $St(\pi') - \{d'\}$  as it does on  $St(g(\pi')) - \{c\}$ , namely simple-transitively.

Now let  $v \in U_{\beta_2}$  be any element, and set  $e' = v(e)$ . We shall find  $y \in U_{\beta_m}$  such that  $[x, y]_2$  sends  $e$  to  $e'$ , hence  $[x, y]_2 = v$ . First notice that for  $t > 2$ ,  $e \in \beta_t$  and so  $U_{\beta_t}$  fixes  $e$ , and we have  $[x, y]_2(e) = [x, y](e) = xyx^{-1}(e)$ . Now since  $U_{\beta_m}$  is simple-transitive on  $St(\pi') - \{d'\}$ ,  $xU_{\beta_m}x^{-1}$  is simple-transitive on  $St(\pi) - \{d\}$ , so there is a unique  $y \in U_{\beta_m}$  with  $[x, y]_2 = v$ , and  $y \mapsto [x, y]_2$  is an isomorphism from  $U_{\beta_m}$  to  $U_{\beta_2}$ .

Finally let  $m = 3$ , and let  $u, v \in U_{\beta_2}$ . Then  $v = [x, y]$  for suitable  $x \in U_{\beta_1}$ ,  $y \in U_{\beta_3}$ , and since  $U_{\beta_2}$  commutes with  $U_{\beta_1}$  and  $U_{\beta_3}$ , we have  $[u, v] = [u, [x, y]] = 1$ .  $\square$

**Remark 1.** Let  $\alpha$  be any root in a Moufang building (of spherical type), and let  $\pi$  be a panel of type  $i$  in the wall  $\partial\alpha$ . If the  $i$ -node of the diagram lies on a single bond and so  $m_{ij} = 3$  for some  $j \in I$ , then  $\pi$  has a face  $\sigma$  of type  $\{i, j\}$ , and by (6.13) the root group  $U_\alpha$  is abelian. This is the case

whenever each connected component of the diagram has rank at least 3 and is not of type  $C_n$  (see Appendix 5 for diagrams); for example  $F_4$  buildings have two conjugacy classes of root groups both of which are abelian (see Exercise 13). In the  $C_n$  case there are two types of roots in one of which all panels in the boundary wall  $\partial\alpha$  have type  $n$ , where  $n$  is the end node on the double bond of the diagram; in this case  $U_\alpha$  is not necessarily abelian.

**Remark 2.** For the case  $m = 3$ , (6.12) and (6.13) give complete information on the commutator  $[U_\alpha, U_\beta]$  when  $\beta \neq -\alpha$ . For  $m = 4, 6$  or  $8$  see Tits [1976a] and [1983] for further details.

**4. Moufang Buildings - the general case.**

In this section we consider subgroups generated by root groups, and define an analogue of the Moufang condition for thick buildings which are not necessarily of spherical type. Let  $\Phi$  be the set of roots in a given apartment  $\Sigma$  (not necessarily of spherical type!). Following Tits [1987] we call a pair of roots  $\alpha, \beta \in \Phi$  *prenilpotent* if both  $\alpha \cap \beta$  and  $(-\alpha) \cap (-\beta)$  are non-empty sets of chambers. In the spherical case this is equivalent to saying  $\alpha \neq -\beta$ , and in the general case it means that either the walls  $\partial\alpha$  and  $\partial\beta$  intersect and are distinct, or else  $\alpha \subset \beta$  or  $\beta \subset \alpha$  (Exercise 14). Given such a pair  $\alpha, \beta$  we write

$$[\alpha, \beta] = \{ \gamma \in \Phi \mid \alpha \cap \beta \subset \gamma \text{ and } (-\alpha) \cap (-\beta) \subset -\gamma \}.$$

This set  $[\alpha, \beta]$  is finite (Exercise 15), and in Figure 6.6 we illustrate the generic rank 3 case with  $\beta \subset \alpha$ , in which roots are half-spaces of the hyperbolic plane (a rank 3 Coxeter complex, containing no  $\circ\text{---}\infty\text{---}\circ$  subdiagram, and which is not spherical or affine (see Chapter 9) is a triangulation of the hyperbolic plane).

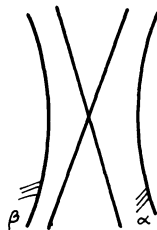

Figure 6.6

In the spherical case the condition  $\alpha \cap \beta \subset \gamma$  implies  $(-\alpha) \cap (-\beta) \subset -\gamma$

(see Figure 6.3), so  $[\alpha, \beta]$  agrees with the definition given earlier in this case. As before we set  $(\alpha, \beta) = [\alpha, \beta] - \{\alpha, \beta\}$ .

We now define  $\Delta$  to be *Moufang* if there is a set of groups  $(U_\alpha)_{\alpha \in \Phi}$  satisfying the following conditions, in which case the  $U_\alpha$  are called *root groups*.

- (M1) If  $\pi$  is a panel of  $\partial\alpha$ , and  $c$  is the chamber of  $St(\pi)$  in  $\alpha$ , then  $U_\alpha$  fixes all the chambers of  $\alpha$  and acts simple-transitively on  $St(\pi) - \{c\}$ .
- (M2) If  $\{\alpha, \beta\}$  is a prenilpotent pair of distinct roots, then  $[U_\alpha, U_\beta] \leq U_{(\alpha, \beta)}$ .
- (M3) For each  $u \in U_\alpha - \{1\}$  there exists  $m(u) \in U_{-\alpha} u U_{-\alpha}$  stabilizing  $\Sigma$  (i.e. interchanging  $\alpha$  with  $-\alpha$ ).
- (M4) If  $n = m(u)$  then for any root  $\beta$ ,  $nU_\beta n^{-1} = U_{n\beta}$ .

This definition of a Moufang building is given by Tits [1987] p.563. As shown below, it agrees with the earlier definition of a Moufang building when the diagram is of spherical type having no isolated nodes. In general however  $\alpha$  will not uniquely determine  $U_\alpha$  - there can be many choices for systems  $(U_\alpha)_{\alpha \in \Phi}$  satisfying (M1) - (M4); see Chapter 9 section 2. Notice however that given  $u \in U_\alpha - \{1\}$  there is a unique  $m(u) = vu'v'$  where  $v, v' \in U_{-\alpha}$  as in (M3); this follows from the simple-transitivity of  $U_\alpha$  and  $U_{-\alpha}$ .

**Examples.** Not all buildings admit a system  $(U_\alpha)_{\alpha \in \Phi}$ , even if they admit a group with a BN-Pair; a good example is the affine building for  $SL_n(Q_p)$  where  $n \geq 3$  and  $Q_p$  is the  $p$ -adic numbers (described in Chapter 9 section 2). Examples of Moufang buildings which are not of spherical type come from Kac-Moody groups (see Tits [1987]); in the affine case they arise from algebraic groups over function fields, such as  $SL_n(k(t))$  (again see Chapter 9 section 2).

(6.14) PROPOSITION. *A root group  $U_\alpha$  fixes every chamber having a panel in  $\alpha - \partial\alpha$ . In particular in the spherical case the  $U_\alpha$  are root groups in the earlier sense, and moreover satisfy (M1) - (M4).*

PROOF: Let  $x \notin \alpha$  be a chamber having a panel  $\pi$  in  $\alpha - \partial\alpha$ , and let  $u \in U_\alpha$  be any element. The wall of  $\Sigma$  containing  $\pi$  determines two opposite roots; let  $\beta$  be the one whose opposite  $-\beta$  has non-empty intersection with  $-\alpha$ , so  $\{\alpha, \beta\}$  is a prenilpotent pair - see Figure 6.7.

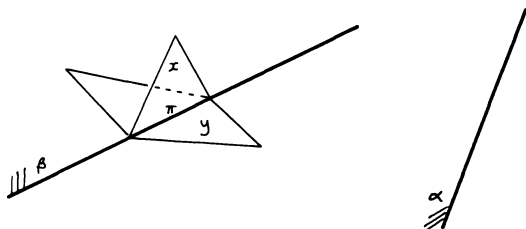

Figure 6.7

If  $y$  is the unique chamber of  $St(\pi) \cap (-\beta)$ , then  $y = v(x)$  for some  $v \in U_\beta$ . For  $\gamma \in [\alpha, \beta]$ , with  $\gamma \neq \beta$ , we have  $y \in \gamma$ , so  $U_\gamma$  fixes  $y$ , and by (M2)

$$v(x) = y = [v, u](y) = vuv^{-1}(y) = vu(x).$$

Therefore  $u(x) = x$ , proving the first statement.

For the last statement, let the  $U_\alpha$  be root groups in a Moufang building of spherical type. Then (M1) follows from the definition, as explained at the beginning of section 2, (M2) is (6.12) (i), and (M4) follows from the fact that  $\alpha$  uniquely determines  $U_\alpha$ . To prove (M3), let  $\pi$  be a panel of  $\partial\alpha$ , and let  $c, c'$  be the chambers of  $St(\pi)$  in  $\alpha, -\alpha$  respectively. Given  $u \in U_\alpha - \{1\}$ , let  $v \in U_{-\alpha}$  send  $u(c')$  to  $c$ , and let  $v' \in U_{-\alpha}$  send  $c$  to  $u^{-1}(c')$ . Then  $vvv'$  switches  $c$  and  $c'$ , and fixes the wall  $\partial\alpha$ , so by (6.3) it interchanges  $\alpha$  with  $-\alpha$ .  $\square$

**Definition of  $U_w$ .** Let  $c \in \Sigma$  be some fixed chamber, and identify  $W$  with the automorphism group of  $\Sigma$ . Given  $w \in W$  take some reduced expression

$$w = r_{i_1} \dots r_{i_\ell}, \text{ and set } w_o = 1, \quad w_t = r_{i_1} \dots r_{i_t}.$$

If  $\beta_j \in \Phi$  denotes the unique root of  $\Sigma$  containing  $w_{j-1}(c)$  but not  $w_j(c)$ , then by (2.7) the  $\beta_j$  are precisely the roots containing  $c$  but not  $w(c)$ . We set

$$U_w = U_{\beta_1} \dots U_{\beta_\ell}.$$

Recall that, by (2.11), any reduced expression for  $w$  can be transformed to any other by a sequence of elementary homotopies, replacing  $r_i r_j \dots$  ( $m_{ij}$  times)



by  $r_j r_i \dots (m_{ij} \text{ times})$ . In the sequence  $\beta_1, \dots, \beta_\ell$  this replaces a subsequence  $\gamma_1, \dots, \gamma_m$  in an  $\{i, j\}$ -residue by  $\gamma_m, \dots, \gamma_1$  (where  $m = m_{ij}$ ), and so  $U_w$  will be well-defined if  $U_{\gamma_1} \dots U_{\gamma_m} = U_{\gamma_m} \dots U_{\gamma_1}$ , and this follows from the commutator relation (M2), as in (6.12)(ii). Moreover  $U_w$  is a group; this can be seen by applying (M2) again and using the fact that any pair of the roots  $\beta_1, \dots, \beta_\ell$  is prenilpotent, and for  $s < t$ ,  $[\beta_s, \beta_t]$  is a subset of  $\beta_s, \dots, \beta_t$  (Exercise 15). Furthermore the factorization of  $u \in U_w = U_{\beta_1} \dots U_{\beta_\ell}$  as  $u_1 \dots u_\ell$ , where  $u_i \in U_{\beta_i}$ , is unique: indeed if  $u = u'_1 \dots u'_\ell$  with  $u'_i \in U_{\beta_i}$ , then  $u_2 \dots u_\ell = u_1^{-1} u'_1 \dots u'_\ell$  fixes the chamber of  $-\beta_1$  adjacent to  $c$ ; this implies  $u_1^{-1} u'_1 = 1$ , and an obvious induction does the rest.

(6.15) THEOREM. *If  $\Delta$  is a Moufang building, then  $U_w$  acts simple-transitively on the set of chambers  $d$  such that  $\delta(c, d) = w$ . In particular if  $(B, N)$  is a Tits system on  $\Delta$ , with  $B$  stabilizing  $c$  and  $N$  stabilizing  $\Sigma$ , then every such chamber can be written uniquely as a coset  $uwB$  where  $u \in U_w$ .*

PROOF: Let  $w = w'$ s be reduced (i.e.,  $\ell(w') < \ell(w)$ ) and let  $\beta$  be the unique root of  $\Sigma$  containing  $d' = w'(c)$  but not  $d = w(c)$ . If  $x$  is any chamber with  $\delta(c, x) = w$ , let  $x'$  be the unique chamber adjacent to  $x$  with  $\delta(c, x') = w'$ . By induction on  $\ell(w)$  there is a unique element  $u \in U_{w'}$  sending  $d'$  to  $x'$ . Moreover there is a unique element  $v \in U_\beta$  sending  $d$  to  $u^{-1}(x)$ . Clearly  $uv \in U_w$  sends  $d = w(c)$  to  $x$ , so  $U_w$  is transitive on  $\{x \mid \delta(c, x) = w\}$ , and simple-transitivity follows from the uniqueness of  $u$  and  $v$ .  $\square$

Given a Moufang building with a system of root groups  $(U_\alpha)_{\alpha \in \Phi}$ , let  $G$  be the group generated by the  $U_\alpha$ . Then take  $N$  to be the subgroup generated by the  $m(u)$  for  $u \in U_\alpha$ , as  $\alpha$  ranges over  $\Phi$ , and let  $H$  denote the subgroup of  $N$  fixing all chambers of  $\Sigma$ . Given some chamber  $c \in \Sigma$ , let  $\Phi^+$  denote the set of roots of  $\Sigma$  containing  $c$ , called the *positive roots*, and define

$$B = \langle H, U_\alpha \mid \alpha \in \Phi^+ \rangle.$$

(6.16) PROPOSITION. *With the notation above  $(B, N)$  is a Tits system for  $G$ , and  $B \cap N = H$ .*

PROOF: First notice that  $G = \langle B, N \rangle$ . Indeed if  $\alpha$  is any root then either  $\alpha \in \Phi^+$  in which case  $U_\alpha \subset B$ , or  $-\alpha \in \Phi^+$  in which case for  $u \in U_\alpha - \{1\}$ ,  $U_\alpha = m(u)U_{-\alpha}m(u)^{-1} \subset \langle B, N \rangle$ . Now using (5.2) it suffices to check

strong transitivity. This follows from the fact that  $U_w \subset B$  is transitive on chambers at distance  $w$  from  $c$ , and that by (M3)  $N$  is transitive on the chambers of  $\Sigma$ .  $\square$

We now set

$$U = \langle U_\alpha \mid \alpha \in \Phi^+ \rangle.$$

By (M4)  $H$  normalizes each  $U_\alpha$ , so  $B = UH$  where  $U$  is normal in  $B$ . In the spherical case  $U = U_w$  where  $w$  is the longest word of  $W$  (Exercise 16), so by (6.15)  $U$  acts simple-transitively on the chambers opposite  $c$ .

(6.17) THEOREM. *For any Moufang building of spherical type, let  $B$  be a group of automorphisms containing  $U$  and fixing  $c$ , and let  $H$  be the subgroup of  $B$  fixing  $\Sigma$  pointwise. Then  $B$  is the semi-direct product  $U \rtimes H$ .*

PROOF: Since  $\alpha$  determines  $U_\alpha$  uniquely,  $H$  normalizes  $U_\alpha$  for all  $\alpha \in \Phi$ , so  $U$  is normal in  $B$ . Moreover if  $c'$  is the chamber of  $\Sigma$  opposite  $c$ , then for any  $g \in B$  there is a unique  $u \in U$  such that  $g(c') = u(c')$ . Since  $u^{-1}g$  fixes  $c$  and  $c'$  it fixes  $\Sigma$ ; thus  $u^{-1}g \in H$ , and the uniqueness of  $u$  implies  $B = U \rtimes H$ .  $\square$

**Example.**  $GL_n(k)$ . In Chapter 5 we saw that the stabilizer  $B$  of a chamber is the group of upper triangular matrices. In this case  $H$  is the group of diagonal matrices, and  $U$  is the subgroup of  $B$  consisting of unipotent matrices (eigenvalues all equal to 1)

$$U = \begin{bmatrix} 1 & & * \\ & \ddots & \\ 0 & & 1 \end{bmatrix}.$$

Notice that the group generated by the  $U_\alpha$  (for  $\alpha \in \Phi$ ) is  $SL_n(k)$ , not  $GL_n(k)$ .

**Notation.** Recall from Chapter 5 that  $P_J$  is the parabolic subgroup which is the stabilizer of the face of  $c$  of type  $J$ , call it  $\sigma_J$ . We shall write  $\Sigma_J = \Sigma \cap St(\sigma_J)$  (an apartment of  $St(\sigma_J)$ ), and  $\Phi_J = \{\alpha \in \Phi \mid \sigma_J \in \partial\alpha\}$

- see Figure 6.8, where the shaded area denotes  $\Sigma_J$ .

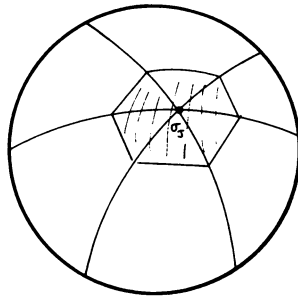

Figure 6.8

We now set

$$U_J = \langle U_\alpha \mid \Sigma_J \subset \alpha \in \Phi \rangle$$

$$L_J = \langle H, U_\alpha \mid \alpha \in \Phi_J \rangle.$$

Notice that the roots containing  $\Sigma_J$  are all positive, so  $U_J$  is a subgroup of  $U$ . Moreover the sets of roots for  $U_J$  and  $L_J$  are disjoint.

(6.18) THEOREM. For a Moufang building of spherical type

$$P_J = U_J \rtimes L_J.$$

Moreover if  $\sigma'$  is the simplex of  $\Sigma$  opposite  $\sigma_J$ , then  $L_J$  is the subgroup fixing  $\sigma_J$  and  $\sigma'$ .

PROOF: Every positive root either contains  $\Sigma_J$  or lies in  $\Phi_J$ , so  $B = UH \leq \langle U_J, L_J \rangle$ . Therefore  $\langle U_J, L_J \rangle$  is a parabolic subgroup  $P_K$ . Moreover  $U_J$  and  $L_J$  stabilize  $\sigma_J$ , so  $K \subset J$ ; but  $L_J$  does not stabilize  $\sigma_K$  for  $K \subsetneq J$ , hence  $K = J$ , and  $\langle U_J, L_J \rangle = P_J$ .

We now show that  $L_J$  normalizes  $U_J$ , so let  $\alpha$  be a root containing  $\Sigma_J$ . If  $\beta \in \Phi_J$  then  $\alpha \neq \pm\beta$ , and all roots of  $[\alpha, \beta]$ , except  $\beta$  itself, contain  $\Sigma_J$ . By (6.12)  $[U_\alpha, U_\beta] \leq U_{(\alpha, \beta)}$ , and hence for  $g \in U_\beta$  one has  $gU_\alpha g^{-1} \subset U_\alpha U_{(\alpha, \beta)} \subset U_J$ . Moreover  $H$  normalizes each  $U_\alpha$ , and therefore  $L_J$  normalizes  $U_J$ , and  $P_J = U_J L_J$ .

Finally let  $\sigma'$  be the simplex of  $\Sigma$  opposite  $\sigma_J$ . Since  $\sigma' \in \partial\beta$  for each  $\beta \in \Phi_J$  (by Exercise 4), we see that  $L_J$  fixes  $\sigma'$ . Moreover by Exercise

17,  $U_J$  acts simple-transitively on the set of simplexes opposite  $\sigma_J$ , and therefore  $U_J \cap L_J = 1$ , and  $P_J = U_J \rtimes L_J$ . Moreover if  $g \in P_J$ , then  $g = uh$  where  $u \in U_J$ ,  $h \in L_J$ , and so if  $g$  fixes  $\sigma'$  then  $u = 1$  and  $g \in L_J$ .  $\square$

**Example  $GL_n(k)$ .** In Chapter 5 we gave an example of a parabolic subgroup of  $GL_n(k)$  which had a  $GL_m(k)$  block on the diagonal.

$$P_J = \begin{bmatrix} * & & & & * \\ & \ddots & & & \\ & & \boxed{GL_m(k)} & & \\ & & & \ddots & \\ 0 & & & & * \end{bmatrix}$$

In this case

$$U_J = \begin{bmatrix} 1 & & & & * \\ & \ddots & & & \\ & & \boxed{I_m} & & \\ & & & \ddots & \\ 0 & & & & 1 \end{bmatrix}$$

$$L_J = \begin{bmatrix} * & & & & 0 \\ & \ddots & & & \\ & & \boxed{GL_m(k)} & & \\ & & & \ddots & \\ 0 & & & & * \end{bmatrix}$$

Here  $L_J \cong GL_m(k) \times k^\times \times \dots \times k^\times$ , where there are  $(n - m)$  copies of  $k^\times$ .

**Notes.** Much of this chapter can be found in Tits [1974]: everything in section 1 is in his Chapters 2 and 3, and the important theorem (6.6) is proved in Chapter 4; the definition of root groups and the Moufang condition for spherical buildings appears in the Addenda on pages 274-276, where the non-existence of (thick)  $H_3$  buildings (6.10) is stated. The proof

of that result appeared later in Tits [1977]. The concept of root groups and a Moufang condition in the general case is very recent and appears in work of Tits [1987] on Kac-Moody groups (for an introduction to the theory of these groups, and further references, see Tits [1985]).

### Exercises to Chapter 6

1. Show that the opposition involution induces a reversal of the diagram in the cases of  $A_n$  and  $E_6$ . [HINT: For  $A_n$  you may use the fact that  $W \cong S_{n+1}$  has a trivial centre; for  $E_6$  you may use the well-known fact that there are exactly 27 vertices corresponding to each of the two end nodes].
2. Show that  $\text{op}_W$  induces a non-trivial diagram symmetry for  $D_n$  if and only if  $n$  is odd. [HINT: Show that the vertices of  $W$  can be regarded as all  $n$ -tuples whose entries are  $+$ ,  $-$  or  $0$ , except those with a single zero:  $\text{op}_W$  switches  $+$  and  $-$ ].
3. Show that if  $\sigma$  and  $\sigma'$  are opposite simplexes, then  $St(\sigma)$  and  $St(\sigma')$  are isomorphic as simplicial complexes (though as chamber systems they may be defined over different subsets  $J$  and  $J'$  of  $I$ ).
4. Let  $\sigma$  and  $\sigma'$  be opposite simplexes of an apartment  $\Sigma$ . If  $\sigma$  lies in a wall  $M$  of  $\Sigma$ , show that  $\sigma'$  does too, and if  $\sigma, \sigma'$  both lie in a root  $\gamma$ , then  $\sigma, \sigma' \in \partial\gamma$ .
5. Given chambers  $x$  and  $y$ , in a spherical building, such that  $d(x, y) = d - 1$  ( $d = \text{diam}(W)$ ), show that the convex hull of  $x$  and  $y$  is a root. [HINT: In an apartment containing  $x$  and  $y$ , use (2.7) and (2.15) to count the roots containing both, then apply (2.8) and (3.8)].
6. Let  $\Sigma$  be an apartment of a spherical building, and let  $\sigma, \sigma'$  be opposite simplexes of  $\Sigma$ . Show that  $\Sigma$  is the only apartment containing  $\Sigma \cap St(\sigma)$  and  $\sigma'$ .
7. For any root  $\alpha$ , let  $d \in \alpha$  be a chamber having an  $i$ -panel in  $\partial\alpha$ , and let  $c \in \alpha$  be  $j$ -adjacent to  $d$ , where  $i$  and  $j$  are connected in the diagram. Show that  $c$  has no panel in  $\partial\alpha$ .
8. If each connected component of a spherical diagram has rank  $\geq 3$ , show that any root  $\alpha$  contains a chamber  $c$  none of whose faces of codimension 1 or 2 lie in  $\partial\alpha$ . [HINT: Reduce to considering only  $A_3, C_3$  and  $H_3$  because in a higher rank case  $\partial\alpha$  must contain a face of one of these types].

9. Given  $\alpha$  and  $c$  as in Exercise 8, show that an automorphism fixing  $\alpha$  and  $E_2(c)$  must fix every chamber having a panel in  $\alpha - \partial\alpha$ . [HINT: Reduce to the rank 3 case].
10. Recall (from Exercise 14 of Chapter 3) that a generalized 3-gon  $\Delta$  is a projective plane. A plane is called *Moufang* if for each flag  $(p, L)$  the group  $U_{(p,L)}$  stabilizing each line on  $p$ , and each point on  $L$ , is transitive on the points  $\neq p$  of a line  $M \neq L$  on  $p$  (or equivalently the lines  $\neq L$  on a point  $q \neq p$  of  $L$ ). Show that the Moufang condition for  $\Delta$  means the same whether we treat  $\Delta$  as a plane or a generalized 3-gon.
11. In Example 1 show that:
- (i)  $U_\alpha$  is isomorphic to the additive group of  $k$ .
  - (ii)  $U_\alpha$  and  $U_{-\alpha}$  generate  $SL_2(k)$ .
  - (iii) The chambers of  $\alpha$  are (after possibly interchanging  $\alpha$  and  $-\alpha$ ) the maximal flags

$$\langle e_{\sigma(1)} \rangle \subset \langle e_{\sigma(1)}, e_{\sigma(2)} \rangle \subset \dots \subset \langle e_{\sigma(1)}, \dots, e_{\sigma(n)} \rangle$$

where  $\sigma(i) < \sigma(j)$ .

- (iv)  $U_\alpha$  is indeed the root group for the root  $\alpha$ .
12. In Example 1 let  $c$  be a chamber of  $\alpha$  having no panel in  $\partial\alpha$ , so  $U_\alpha$  is the group fixing  $\alpha$  and all chambers of  $St(\pi)$  for each of the  $n$  panels  $\pi$  of  $c$  (see (6.5)). Show that the group fixing  $\alpha$  and all chambers of  $St(\pi)$ , for only  $m$  of the panels  $\pi$  of  $c$ , is isomorphic to  $U_\alpha \times k^\times \times \dots \times k^\times$  ( $n - m$  copies of  $k^\times$ ).
13. Consider a spherical Coxeter complex with a connected diagram. Show that for the cases  $A_n$ ,  $D_n$ ,  $E_6$ ,  $E_7$ ,  $E_8$ ,  $H_3$ ,  $H_4$ , and  $I_2(m)$  with  $m$  odd (see Appendix 5)  $W$  is transitive on the set of roots, and in the other cases there are two orbits. Conclude that in a Moufang building of spherical type there is only one conjugacy class of root groups in the single bond case, and two classes otherwise.
14. Let  $\alpha$  and  $\beta$  be roots in an arbitrary Coxeter complex. Show that:
- (i)  $\alpha \not\subset \pm\beta$  and  $\beta \not\subset \pm\alpha \Leftrightarrow \partial\alpha \cap \partial\beta$  has codimension 2.
  - (ii) In the spherical case  $\alpha \not\subset \pm\beta \Leftrightarrow \alpha \neq \pm\beta$ .
  - (iii)  $\{\alpha, \beta\}$  is prenilpotent  $\Leftrightarrow \alpha \subset \beta$ , or  $\beta \subset \alpha$ , or  $\partial\alpha \cap \partial\beta$  has codimension 2.

15. If  $\{\alpha, \beta\}$  is a prenilpotent pair of roots in a Coxeter complex, show that  $[\alpha, \beta]$  is finite. Moreover let  $(c_0, c_1, \dots, c_\ell)$  be a minimal gallery, and let  $\beta_t$  denote the unique root containing  $c_t$  but not  $c_{t-1}$ . Then for  $1 \leq i \leq j \leq \ell$ ,  $\{\beta_i, \beta_j\}$  is prenilpotent, and  $[\beta_i, \beta_j] \subset \{\beta_t \mid i \leq t \leq j\}$ .
16. Show that  $B$  is the normalizer of  $U$ , and in the spherical case show that  $U = U_w$  where  $w$  is the longest word of  $W$ .
17. With the notation of this chapter, prove that  $U_J$  acts simple-transitively on the simplexes opposite  $\sigma_J$  (compare (5.4)(iv)). If  $\tau$  is any such simplex what is the stabilizer of  $\sigma_J$  and  $\tau$ ? What is the normalizer of  $L_J$  in  $P_J$ ?
18. Let  $\Delta$  be the barycentric subdivision of the  $Sp_4(k)$  quadrangle of Exercise 19 in Chapter 3. It is not a thick building, and has parameters  $(1, t)$  where  $t = \text{card } k$ . If  $c$  and  $b$  are opposite chambers show that the subgroup fixing  $E_1(c)$  and  $b$  is not the identity (cf. (6.4)).

## Chapter 7

### A CONSTRUCTION OF BUILDINGS

In this chapter we construct buildings which conform to a blueprint; this is the case for all Moufang buildings.

#### 1. Blueprints.

In this section we shall introduce blueprints, and construct buildings which conform to a blueprint. We use  $I$  and  $M$  as before.

A *parameter system* will mean a collection of disjoint *parameter sets*  $(S_i)$   $i \in I$ , each having a distinguished element  $\infty_i \in S_i$ . We shall write  $S'_i = S_i - \{\infty_i\}$ .

A *labelling* of a building  $\Delta$  over  $I$ , based at  $c \in \Delta$ , assigns to each  $i$ -residue  $R$  a bijection

$$\phi_R : S_i \rightarrow R$$

such that  $\phi_R(\infty_i) = \text{proj}_{Rc}$ . For  $x \in R$ ,  $\phi_R^{-1}(x)$  is called its *i-label*.

**Example.** Let  $S$  be a generalized  $m$ -gon over  $\{i, j\}$ , with a labelling based at  $s \in S$  using the parameter system  $(S_i, S_j)$ . Given any chamber  $x \in S$  at distance  $d$  from  $s$  one has a gallery  $(s = x_0, x_1, \dots, x_d = x)$ . If  $d < m$  this is unique, and if  $d = m$  there are two such galleries, of types  $p(i, j)$  and  $p(j, i)$ . Now let  $u_t$  be the label attached to  $x_t$  in the rank 1 residue containing  $x_{t-1}$  and  $x_t$ . The gallery thus determines the sequence  $(u_1, \dots, u_d)$  where the  $u_t$  lie alternately in  $S'_i$  and  $S'_j$ , and any such sequence obviously determines a unique gallery, and hence a unique chamber at the end of this gallery. If  $d = m$  exactly two sequences determine the same chamber; we call these sequences *equivalent*. These equivalences, one for each chamber opposite  $s$ , give complete data for reconstructing  $S$ .  $\square$

A *blueprint* is a parameter system  $(S_i)$  together with, for each distinct  $i, j \in I$ , a generalized  $m_{ij}$ -gon  $S_{ij}$  having a labelling by  $(S_i, S_j)$  based at



some chamber  $\infty_{ij} \in S_{ij}$ . (In particular, in the rank 2 case a blueprint is simply a labelling of a rank 2 building).

A building  $\Delta$  of type  $M$  will be said to *conform* to a blueprint if it admits a labelling by the  $(S_i)$  such that for every  $\{i, j\}$ -residue  $R$  there is an isomorphism  $\phi_R : S_{ij} \rightarrow R$  with the property that  $x$  and  $\phi_R(x)$  have the same  $i$  and  $j$ -labels for each  $x \in S_{ij}$ .

Now let  $\Delta$  be a building having a labelling based at  $c$ , using the parameter system  $(S_i)_{i \in I}$ . For any chamber  $x \in \Delta$  take a gallery  $\gamma = (c = c_0, c_1, \dots, c_\ell = x)$  of reduced type  $f = i_1 \dots i_\ell$  from  $c$  to  $x$  (where  $r_f = \delta(c, x)$  of course). Then  $\gamma$  determines a sequence  $(u_1, \dots, u_\ell)$ , where  $u_i \in S'_{i_i}$  is the  $i_i$ -label of  $c_i$ . Conversely such a sequence determines a gallery  $\gamma$  starting at  $c$ , and hence a chamber  $x$  at the end of this gallery.

Now suppose  $\Delta$  conforms to a blueprint  $(S_i, S_{ij})_{i, j \in I}$ . If  $f'$  is elementary homotopic to  $f$ , then we have a gallery  $\gamma' = \gamma_1 \omega' \gamma_2$  of type  $f'$  from  $c$  to  $x$ , where  $\gamma = \gamma_1 \omega \gamma_2$  and  $\omega, \omega'$  are galleries in an  $\{i, j\}$ -residue, corresponding to sequences which are equivalent in  $S_{ij}$ . Thus using the blueprint, and concatenating elementary homotopies, we can transform one sequence  $(u_1, \dots, u_\ell)$  to another. The chambers of  $\Delta$  could then be defined as equivalence classes of such sequences, but there is a problem. Transforming  $(u_1, \dots, u_\ell)$  to another sequence of the same type  $f$  should give the same sequence; this means we must consider what happens to  $(u_1, \dots, u_\ell)$  when we apply a self-homotopy of  $f$ . By (2.17) self-homotopies are generated in rank 3 spherical residues, and so this leads to the following theorem, in which we call a blueprint *realisable* if there is a building which conforms to it.

(7.1) THEOREM. *A blueprint is realisable if its restriction to each spherical rank 3 subdiagram is realisable. In this case there is a unique building which conforms to it.*

**The Construction.** Given a blueprint we first construct a chamber system  $S$  as follows. The chambers of  $S$  are sequences

$$\bar{u} = (u_1, \dots, u_\ell)$$

where  $u_i \in S'_{i_i}$  and  $f = i_1 \dots i_\ell$  is reduced. We call  $f$  the *type* of  $\bar{u}$ . We define  $i$ -adjacency via

$$(u_1, \dots, u_\ell) \underset{i}{\sim} (u_1, \dots, u_\ell, u_{\ell+1}) \underset{i}{\sim} (u_1, \dots, u_\ell, u'_{\ell+1}),$$

if  $u_{\ell+1}, u'_{\ell+1} \in S_i$ ; this is evidently an equivalence relation, so  $S$  is a chamber system.

We define an *elementary equivalence* to be an alteration from a sequence  $\bar{u}_1 \bar{u} \bar{u}_2$  of type  $f_1 p(i, j) f_2$  to  $\bar{u}_1 \bar{u}' \bar{u}_2$  of type  $f_1 p(j, i) f_2$  where  $\bar{u}$  and  $\bar{u}'$  are equivalent in  $S_{ij}$ . Two sequences  $\bar{u}$  and  $\bar{v}$  are called *equivalent*, written  $\bar{u} \simeq \bar{v}$ , if one can be transformed to the other by a sequence of elementary equivalences.

The chamber system we want is  $S$ /equivalence; we call it  $C$ . Its chambers are equivalence classes of sequences  $\bar{u} = (u_1, \dots, u_\ell)$ , denoted  $[\bar{u}]$  or  $[u_1, \dots, u_\ell]$ . Notice that  $[\bar{u}]$  determines a unique element  $r_f \in W$  where  $f$  is the type of  $\bar{u}$ ; we call this  $\rho[\bar{u}]$ . We now define  $i$ -adjacency in  $C$  by  $x \underset{i}{\sim} y$  if  $x = [\bar{u}]$ ,  $y = [\bar{v}]$  with  $\bar{u} \underset{i}{\sim} \bar{v}$ ; in Step 2 of the proof below we shall see that this is in fact an equivalence relation.

**PROOF OF THEOREM (7.1):** We show that  $C$  is a building conforming to the given blueprint.

**Step 1.** If  $\bar{u} \simeq \bar{v}$ , and  $\bar{u}, \bar{v}$  both have type  $f$ , then  $\bar{u} = \bar{v}$ .

Certainly the equivalence  $\bar{u} \simeq \bar{v}$  induces a self-homotopy of  $f$ , and by (2.17) we need only consider equivalences  $\bar{w} \simeq \bar{w}'$  giving self-homotopies which are either inessential or lie in rank 3 spherical residues. The former case is easily seen to imply  $\bar{w} = \bar{w}'$ , and the latter case does too because of our rank 3 hypothesis.

**Step 2.**  $i$ -adjacency is an equivalence relation.

Let  $x \underset{i}{\sim} y \underset{i}{\sim} z$ . If  $\rho(x)$ ,  $\rho(y)$  and  $\rho(z)$  are not  $i$ -reduced on the right, then we have  $x = [\bar{u}, u']$ ,  $y = [\bar{u}, u] = [\bar{v}, v]$ ,  $z = [\bar{v}, v']$ , where  $\bar{u}, \bar{v}$  have types  $f, g$  respectively, and  $u', u, v, v' \in S'_i$ . Evidently  $fi \simeq gi$ , so  $f \simeq g$ , and  $\bar{u} \simeq \bar{v}_o$  for some  $\bar{v}_o$  of type  $g$ . Therefore  $(\bar{u}, u) \simeq (\bar{v}_o, u)$  of type  $gi$ , so by Step 1  $\bar{v}_o = \bar{v}$  and  $u = v$ . Therefore  $x = [\bar{v}, u'] \underset{i}{\sim} [\bar{v}, v'] = z$  as required. A similar proof works if one of  $\rho(x)$ ,  $\rho(y)$ ,  $\rho(z)$  is  $i$ -reduced on the right; one simply deletes  $u', u, v, v'$  as appropriate.

**Step 3.**  $C$  is a chamber system satisfying  $(P_c)$  where  $c = [\emptyset]$  [Recall  $(P_c)$ : Given two galleries starting at  $c$  and ending at the same chamber, of reduced types  $f$  and  $f'$ , one has  $r_f = r_{f'}$ ].

$C$  is a chamber system by Step 2, and it is straightforward to see, by induction on the length of  $f$ , that a gallery  $(c = c_1, c_2, \dots, c_\ell = d)$  of reduced type  $f$  corresponds to a sequence  $\bar{u}$  of type  $f$  such that  $[\bar{u}] = d$ . Now if  $\bar{u}'$  has type  $f'$  and  $\bar{u} \simeq \bar{u}'$ , then  $f \simeq f'$ , so  $r_f = r_{f'}$ .

**Step 4.**  $C$  is a chamber system of type  $M$ .

Let  $R$  be any  $\{i, j\}$ -residue, and  $x = [\bar{u}, \bar{v}]$  any chamber of  $R$ , where the type of  $\bar{u}$  is  $\{i, j\}$ -reduced on the right, and the type of  $\bar{v}$  involves only  $i$  and  $j$ . If  $x \underset{i}{\sim} y$ , then  $y = [\bar{u}, \bar{v}']$  where  $\bar{v}' \underset{i}{\sim} \bar{v}$ , so by  $\{i, j\}$ -connectivity of  $R$  each of its chambers has the form  $[\bar{u}, \bar{w}]$  where the type of  $\bar{w}$  involves only  $i$  and  $j$ . Moreover any such chamber lies in  $R$ , so the map  $[\bar{u}, \bar{w}] \rightarrow [\bar{w}]$  from  $R$  to  $S_{ij}$  is surjective, and by Step 1 it is an isomorphism. Thus  $R \cong S_{ij}$ , as required.

Finally from Steps 3 and 4 it follows, by (4.2), that  $C$  is a building. Moreover  $C$  obviously acquires a labelling conforming to the blueprint, and its uniqueness is an immediate consequence of this.  $\square$

**Remark.** We could have defined  $i$ -adjacency as the equivalence relation generated by the  $i$ -adjacency we in fact defined. In this case Step 2 would have to be rephrased by saying that if  $x \underset{i}{\sim} y$  then we can write  $x = [\bar{u}, u]$ ,  $y = [\bar{u}, v]$  where  $u, v$  are either non-existent or contained in  $S'_i$ .

Before leaving this section we state a theorem which follows immediately from the proof of (7.1).

(7.2) THEOREM. *A blueprint is realisable if and only if for any two sequences  $\bar{u}, \bar{v}$  of the same reduced type,  $\bar{u} \simeq \bar{v}$  implies  $\bar{u} = \bar{v}$ .*

PROOF: The hypothesis is Step 1 of the proof of (7.1), so the remainder of the proof of (7.1) goes through unchanged. The “only if” part follows from the fact that a sequence  $\bar{u}$  of type  $f$  corresponds to a gallery of type  $f$  from  $c = [\emptyset]$  to  $[\bar{u}]$ , and such galleries are unique (3.1)(v).  $\square$

## 2. Natural Labellings of Moufang Buildings.

In Chapter 6 section 4 we defined Moufang buildings. If  $\Delta$  is Moufang, and  $\Phi$  is the set of roots in an apartment  $\Sigma$ , then there is a set of root groups  $U_\alpha$ , one for each  $\alpha \in \Phi$ , having certain properties (M1) - (M4). All spherical buildings are Moufang if the diagram has no connected component of rank  $\leq 2$ . In this section we show that a Moufang building conforms to a blueprint, in fact a “natural” blueprint defined using root group elements.

Choose a chamber  $c \in \Sigma$ , let  $\pi_i$  be its panel of type  $i$ , and define  $\alpha_i \in \Phi$  to be the root containing  $c$  and with  $\pi_i \in \partial\alpha_i$ . We let  $r_i$  denote the reflection interchanging  $\alpha_i$  and  $-\alpha_i$  and write  $U_i = U_{\alpha_i}$ . Now for each  $i \in I$  select some element  $e_i \in U_i - \{1\}$ . Recall from Chapter 6 that for each  $u \in U_\alpha - \{1\}$  there is a unique element  $m(u) \in U_{-\alpha}uU_{-\alpha} \cap N$  interchanging  $\alpha$  and  $-\alpha$ .

(7.3) LEMMA. *Setting  $n_i = m(e_i)$  one has*

$$n_i n_j \dots = n_j n_i \dots \text{ (} m_{ij} \text{ terms alternating } n_i \text{ and } n_j \text{ on each side).}$$

*Consequently for any  $w \in W$ , there is a unique  $n(w) \in N$ , where*

$$n(w) = n_{i_1} \dots n_{i_\ell} \quad \text{for } w = r_{i_1} \dots r_{i_\ell} \text{ (reduced).}$$

PROOF: The first statement is proved in Appendix 1, and the second statement is an immediate consequence of the first, using (2.11).  $\square$

In Chapter 6 section 4 we defined a group  $U_w$  for each  $w \in W$ . It acts simple-transitively on the set of chambers  $d$  such that  $\delta(c, d) = w$ , and if  $B$  denotes the stabilizer of  $c$ , then by (6.15) every such  $d$  can be represented in a unique way as a coset  $uwB$ , where  $u \in U_w$ . Since  $wB = n(w)B$ , we have a bijection between chambers of  $\Delta$  and elements  $un(w)$ , where  $u \in U_w$ . The fact that we are able to omit  $B$  (which is in general a complicated group) means that the structure of the building is remarkably simple; in fact it conforms to a blueprint.

(7.4) LEMMA. *If  $w = r_f$  for some reduced word  $f = i_1 \dots i_k$ , then for  $u \in U_w$ ,*

$$un(w) = u_1 n_{i_1} \dots u_k n_{i_k}$$

*where  $u_t \in U_{i_t}$ , and this factorisation is unique.*

PROOF: Let  $w' = r_g$  where  $g = i_2 \dots i_k$ , so  $w = r_{i_1} w'$ . If  $\beta_1, \dots, \beta_k$  are the roots separating  $c$  from  $w(c)$  in  $\Sigma$ , their order determined by the gallery of type  $f$  from 1 to  $w$ , then  $u = v_1 \dots v_k$  where  $v_t \in U_{\beta_t}$  (see 6.15). Therefore

$$\begin{aligned} un(w) &= v_1 \dots v_k n(w) \\ &= v_1 n_{i_1} n_{i_1}^{-1} v_2 \dots v_k n_{i_1} n(w') \\ &= v_1 n_{i_1} v n(w') \end{aligned}$$

where  $v \in U_{w'}$ , because  $n_{i_1}$  switches  $\beta_2, \dots, \beta_k$  with the roots separating  $c$  from  $w'(c)$ , their order determined by the gallery of type  $g$  from 1 to  $w'$ . The factorisation now follows by induction on the length of  $w$ , and its uniqueness follows from the uniqueness of the decomposition  $u = v_1 \dots v_k$  which is a consequence of (6.15).  $\square$

**The Natural Labelling given by the  $(e_i)_{i \in I}$ .** The lemma above implies that each chamber of  $\Delta$  can be written as an equivalence class  $un(w)$  of elements of the form  $u_i n_{i_1} \dots u_k n_{i_k}$  having type  $f = i_1 \dots i_k$  where  $r_f = w$ . It is this which gives what we call a *natural labelling* of the building  $\Delta$ . More precisely let  $R$  be any  $i$ -residue of  $\Delta$ , and let  $\text{proj}_R c = d$  and  $w = \delta(c, d)$ . As cosets of  $B$  the chambers of  $R$  may be written  $un(w)B$  (this is  $d$ ), and  $un(w)vn_i B$  where  $u \in U_w$  and  $v \in U_i$ . We assign them the  $i$ -labels  $\infty_i$  and  $v$ , using  $S_i = U_i \cup \{\infty_i\}$ . If we let  $S_{ij}$  be the  $\{i, j\}$ -residue containing  $c$ , then  $S_{ij}$  acquires a labelling and we have a blueprint given by the  $(e_i)_{i \in I}$ .

(7.5) PROPOSITION. *The natural labelling of  $\Delta$  above conforms to the blueprint given by its restriction to  $E_2(c)$ . In particular a Moufang building conforms to a blueprint.*

PROOF: If  $A$  is any  $\{i, j\}$ -residue, let  $w = \delta(c, \text{proj}_A c)$ . As a coset of  $B$ ,  $\text{proj}_A c$  is  $un(w)B$  for some  $u \in U_w$ , and left multiplication by  $un(w)$  gives an isomorphism from the  $\{i, j\}$ -residue containing  $c$  to  $A$ , preserving  $i$  and  $j$ -labels.  $\square$

(7.6) LEMMA. *A Moufang plane has a unique natural labelling in the sense that any natural labelling can be transformed to any other by an automorphism of the plane fixing the base chamber.*

PROOF: We shall not prove this here: a proof is given in Ronan-Tits [1987] Lemma 2.  $\square$

We now extend the concept of a natural labelling to generalized 2-gons, by defining a labelling using  $(S_1, S_2)$  to be *natural* if  $(u_1, u_2)$  is equivalent to  $(u_2, u_1)$  for any  $u_1 \in S'_1, u_2 \in S'_2$ . If  $\Delta$  is a Moufang building with a natural labelling given by  $e_i \in U_i - \{1\}$  then any  $A_1 \times A_1$  residue acquires a natural labelling in this sense (because the appropriate root groups commute - see Exercise 1).

Finally we remark that if  $\Delta$  is a direct product  $\Delta_1 \times \dots \times \Delta_r$ , then labellings of the  $\Delta_j$  generate a labelling of  $\Delta$  in an obvious way: if  $\Delta_j$  is over  $I_j$  (so  $\Delta$  is over  $\cup I_j$ ), and if  $i \in I_j$  then the chamber  $(c_1, \dots, c_r)$  of  $\Delta_1 \times \dots \times \Delta_r$  has the same  $i$ -label as  $c_j$  in  $\Delta_j$ . If  $\Delta = \Delta_1 \times \Delta_2$  is an  $A_1 \times A_1$  building, this gives what we have called a natural labelling.

### 3. Foundations.

Take a parameter system  $(S_i)_{i \in I}$ , and for each  $i, j \in I$  a generalized  $m_{ij}$ -gon  $S_{ij}$  (not labelled) with a base chamber  $\infty_{ij}$ . Let

$$\phi_{ij} : S_i \rightarrow S_{ij}$$

be a bijection onto the  $i$ -residue of  $S_{ij}$  containing  $\infty_{ij}$ , and sending  $\infty_i$  to  $\infty_{ij}$ . A *foundation* of type  $M$  is the amalgamated sum of the  $S_{ij}$  with respect to the  $\phi_{ij}$ ; in other words the union of the  $S_{ij}$  with the identifications  $\phi_{ij}(s_i) = \phi_{ik}(s_i)$  for all  $s_i \in S_i$ , and for all  $i, j, k \in I$ . It is a chamber system  $E$  over  $I$  having a base chamber  $c$  identified with all  $\infty_i$  and  $\infty_{ij}$ , and is the union of the rank 2 residues containing  $c$ . We say  $E$  *supports* a building  $\Delta$  if it is isomorphic to the union of the rank 2 residues of  $\Delta$  containing some given chamber  $c$  of  $\Delta$  (i.e.  $E_2(c)$ ).

A *labelling* of  $E$  is defined in the obvious way: if  $\pi$  is the  $i$ -panel of  $c$ , then  $St(\pi) = S_i$ , and if  $\pi$  is any other  $i$ -panel one takes a bijection  $S_i \leftrightarrow St(\pi)$  such that  $\infty_i$  corresponds to the chamber of  $St(\pi)$  nearest the base chamber  $c$ . Notice that a labelling of a foundation is nothing other than a blueprint.

(7.7) LEMMA. *Let  $E$  be a rank 3 foundation of reducible type (i.e. disconnected diagram). Then  $E$  supports a building  $\Delta$  which is uniquely determined up to isomorphism, and  $\Delta$  conforms to any labelling of  $E$  whose restriction to  $A_1 \times A_1$  residues is natural.*

PROOF: Let  $I = \{1, 2, 3\}$  with  $m_{12} = m_{13} = 2$ . By (3.10) any such building is a direct product  $\Delta_1 \times \Delta_{23}$ , so  $\Delta$  must be  $S_1 \times S_{23}$  with the labelling generated as above.  $\square$

(7.8) PROPOSITION. *Let  $E$  be an  $A_3$  or  $C_3$  foundation which supports a building  $\Delta$ . Then  $\Delta$  conforms to any labelling of  $E$  whose restriction to the rank 2 residues is natural, and  $\Delta$  is uniquely determined up to isomorphism by  $E$ .*  $\square$

PROOF: Let  $I = \{1, 2, 3\}$  with  $m_{12} = 3$  and  $m_{13} = 2$ , and let  $\mathcal{L}$  be a labelling of  $E$  whose restrictions  $\mathcal{L}_{ij}$  to  $S_{ij}$  are natural. By (6.7)  $\Delta$  is Moufang, and hence conforms to a natural labelling  $\mathcal{L}'$  of  $E$  extending  $\mathcal{L}_{23}$  (given  $e_2, e_3$  choose any  $e_1$ ). By (7.6) there is an automorphism  $\theta$  of  $S_{12}$  fixing  $S_2$  and carrying  $\mathcal{L}'_{12}$  to  $\mathcal{L}_{12}$ , and we extend  $\theta$  to an automorphism of  $E$  which is the identity on  $S_{23}$  (and hence fixes  $\mathcal{L}_{23}$ ). Since  $\mathcal{L}_{13}$  is uniquely determined by its restrictions to  $S_1$  and  $S_3$ , we see that  $\theta$  sends  $\mathcal{L}'_{13}$  to  $\mathcal{L}_{13}$ ,

and hence sends  $\mathcal{L}'$  to  $\mathcal{L}$ . Thus  $\Delta$  conforms to  $\mathcal{L}$ , as required. Moreover, if  $\Delta$  is any other building supported by  $E$ , it too conforms to the given labelling of  $E$ , and is therefore isomorphic to  $\Delta$ .  $\square$

(7.9) THEOREM. *Let  $E$  be a foundation with no residue of type  $H_3$ . If each residue of type  $A_3$  or  $C_3$  supports a building, then  $E$  supports a building. If  $E$  is of spherical type this building is uniquely determined up to isomorphism.*

PROOF: Choose a natural labelling for each  $S_{ij}$  whenever  $\{i, j\}$  is in an  $A_3$  or  $C_3$  residue, or is of type  $A_1 \times A_1$  in a spherical triple. Choose other labellings arbitrarily. This gives a blueprint which by (7.7) and (7.8) is realisable for rank 3 spherical residues, and hence by (7.1) there is a building  $\Delta$  which conforms to it.

To prove uniqueness it suffices to consider the case of a connected diagram, since  $\Delta$  is a direct product of buildings for the connected components of the diagram. In this case we may assume a diagram of rank  $\geq 3$ , and since  $E$  is of spherical type,  $\Delta$  is Moufang and the diagram has at most one double bond. We apply the technique in the proof of (7.8): let  $\mathcal{L}$  be a labelling of  $E$  whose restrictions  $\mathcal{L}_{ij}$  to  $S_{ij}$  are natural. If  $x, y \in I$  are the nodes of the double bond (or any two nodes if no double bond exists), then  $\Delta$  conforms to a natural labelling  $\mathcal{L}'$  extending  $\mathcal{L}_{xy}$  (given  $e_x, e_y$  choose the other  $e_i$  arbitrarily). As in the proof of (7.8), (7.6) allows us to define an isomorphism of  $E$  sending  $\mathcal{L}'$  to  $\mathcal{L}$ . Thus  $\Delta$  conforms to  $\mathcal{L}$ , and is therefore unique up to isomorphism.  $\square$

**Remark.** In the next chapter we shall deal with the case of  $A_3$  and  $C_3$  blueprints ( $A_3$  in detail, but  $C_3$  only by using Tits' classification [1974]). When we have done so it will be quite clear that buildings exist for all possible diagrams which have no  $H_3$  subdiagram. However, the reader certainly has enough information at the moment to deal with many cases (see Exercises 3 and 4).

**Notes.** Everything in this chapter appears in Ronan-Tits [1987], except that "BN-Pairs with a splitting" appear there in place of Moufang buildings. These BN-Pairs have root groups  $U_\alpha$  for  $\alpha \in \Phi$ , which satisfy conditions similar to (M1) - (M4) of Chapter 6, although (M2) is weakened.

## Exercises to Chapter 7

1. Let  $U_1$  and  $U_2$  be the fundamental root groups in an  $A_1 \times A_1$  residue of a Moufang building. Given  $u_1, v_1 \in U_1$  and  $u_2, v_2 \in U_2$  with  $u_1 n_1 u_2 n_2 = v_2 n_2 v_1 n_1$ , show that  $u_1 = v_1$  and  $u_2 = v_2$ . [HINT:  $[U_1, U_2] = 1$  by (M2), and for  $x \in U_1$  (or  $U_2$ ),  $m(x)$  commutes with  $U_2$  (or  $U_1$ ); use (7.3)].
2. If  $\Delta = \Delta_1 \times \dots \times \Delta_r$  and each  $\Delta_j$  has a labelling conforming to a blueprint, show that the labelling generated on  $\Delta$  conforms to a blueprint.
3. Using the existence of buildings of type  $A_n(\circ \text{---} \circ \text{---} \dots \text{---} \circ)$  and of generalized  $m$ -gons for all  $m$  (see Exercise 17 of Chapter 3), prove the existence of buildings of type  $\circ \text{---} \dots \text{---} \circ \text{---} \overset{m}{\text{---}} \circ$  for any  $m > 5$ .
4. Try Exercise 3 for some other diagrams, and find some diagram for which existence of a suitable foundation cannot be inferred using the results of this chapter.



## Chapter 8

### THE CLASSIFICATION OF SPHERICAL BUILDINGS

This chapter deals with the classification and existence of buildings of spherical type for which each connected component of the diagram has rank at least three. According to Theorem (7.9) of the preceding chapter the buildings of spherical type  $M$  are uniquely determined by foundations of type  $M$  (this is also a consequence of Theorem (6.6) in Chapter 6), and such foundations support buildings when their  $A_3$  and  $C_3$  residues do. Therefore the first thing we shall do here is to examine  $A_3$  foundations.

#### 1. $A_3$ Blueprints and Foundations.

Since an  $A_3$  building is Moufang, we know by (7.7) that it conforms to a blueprint whose rank 2 restrictions are natural. We therefore need to know what the natural labelling of a Moufang plane looks like. The details are given in Appendix 1, and the main points are as follows.

The three positive root groups  $U_1, U_{12}$  and  $U_2$  (in a natural order) are abelian (by (6.13)) and may be identified with an abelian group  $A$  written additively. Moreover, a natural labelling is determined by non-identity elements  $e_1 \in U_1$  and  $e_2 \in U_2$ , and the identification can be done in such a way that  $e_1, e_2$ , and  $e_{12} = [e_1, e_2]$  are identified with a common element  $e \in A$ . Using subscripts to denote membership of  $U_1, U_{12}$  or  $U_2$  one has a multiplicative structure on  $A$  defined via  $(xy)_{12} = [x_1, y_2]$  (again see Appendix 1 for details). With this addition and multiplication  $A$  becomes an alternative division algebra in which  $e$  plays the role of multiplicative identity. We mention in passing that such an algebra is either a field (not necessarily commutative), in which case the plane is Desarguesian; or, by the Bruck-Kleinfeld theorem [1951], it is a Cayley-Dickson algebra, 8-dimensional over its centre, in which case the plane is sometimes called a *Cayley plane*.

For the purposes of this section, we need the fact that the natural labelling is given by setting the following two sequences equivalent:

sequence	type
$x \ y \ z$	1 2 1
$z \ y' \ x$	2 1 2

where  $y + y' = -(xz)_1$ .

The subscript is needed because if we interchange the roles of 1 and 2, then we obtain the opposite algebra structure (see Appendix 1 section 2, or use the uniqueness of the natural labelling); thus

$$(xz)_1 = (zx)_2.$$

In fact we shall think of  $(xz)_1$  as referring to the algebra structure induced on  $U_1$ , so in other words  $U_1$  with its algebra structure is identified with the opposite of  $U_2$ .

We now return to the subject of  $A_3$  blueprints. For an  $A_3$  blueprint to be realizable it is necessary and sufficient, by (7.2), that an equivalence between two sequences of reduced type  $f$  is an equality. If the corresponding self-homotopy of  $f$  is inessential then one certainly gets equality. Moreover the only essential self-homotopy is obtained from the longest word, by working around an apartment as shown below.

sequence						type					
$a$	$b$	$c$	$d$	$e$	$f$	1	2	3	1	2	1
$a$	$b$	$d$	$c$	$e$	$f$	1	2	1	3	2	1
$d$	$b'$	$a$	$c$	$e$	$f$	2	1	2	3	2	1
$d$	$b'$	$e$	$c'$	$a$	$f$	2	1	3	2	3	1
$d$	$e$	$b'$	$c'$	$f$	$a$	2	3	1	2	1	3
$d$	$e$	$f$	$c''$	$b'$	$a$	2	3	2	1	2	3
$f$	$e'$	$d$	$c''$	$b'$	$a$	3	2	3	1	2	3
$f$	$e'$	$c''$	$d$	$b'$	$a$	3	2	1	3	2	3
$f$	$e'$	$c''$	$a$	$b''$	$d$	3	2	1	2	3	2
$f$	$a$	$c'''$	$e'$	$b''$	$d$	3	1	2	1	3	2
$a$	$f$	$c'''$	$b''$	$e'$	$d$	1	3	2	3	1	2
$a$	$b''$	$c''''$	$f$	$e'$	$d$	1	2	3	2	1	2
$a$	$b''$	$c''''$	$d$	$e''$	$f$	1	2	3	1	2	1

This self-homotopy is an equality if and only if  $b'' = b$ ,  $c'''' = c$ , and  $e'' = e$ . We now compute using the multiplication  $(xy)_1$  or  $(xy)_3$ , but not  $(xy)_2$  as

it may (and in fact does) depend on which  $A_2$  residue it is induced from. One has

$$b + b' = -(ad)_1, \text{ and } b' + b'' = -(da)_3,$$

so  $b'' = b$  if and only if

$$(xy)_1 = (yx)_3. \quad (1)$$

Given this equality we find that  $e = e''$ . Similarly:

$$\begin{aligned} c + c' &= -(ea)_3 = -(ae)_1, \\ c' + c'' &= -(b'f)_1, \\ c'' + c''' &= -(ae')_1, \\ c''' + c'''' &= -(fb)_3 = -(bf)_1. \end{aligned}$$

Using  $e' = -(fd)_3 - e = -(df)_1 - e$ , and deleting the subscript 1, one obtains:

$$c - c'''' = a(df) - (ad)f.$$

So  $c = c''''$  if and only if

$$x(yz) = (xy)z. \quad (2)$$

Thus we find that our blueprint is realizable if and only if equations (1) and (2) are satisfied. Equation (2) gives the well-known result that the coordinate ring is a field, so each plane is Desarguesian. Moreover since the ring structure induced (after one has chosen a unit element) on  $U_2$  from the  $\{1, 2\}$ -plane is opposite that induced on  $U_1$  (see above), and similarly with 1 replaced by 3, we see from equation (1) that the blueprint is realizable if and only if the two planes induce opposite field structures on  $U_2$ .

We rephrase this as a theorem.

(8.1) THEOREM. *An  $A_3$  foundation  $E$  supports a building if and only if the two planes are Desarguesian and induce opposite field structures on their common punctured rank 1 residue (i.e. with the base chamber removed).*

PROOF: If  $E$  supports a building then by (7.8) this building conforms to a labelling of  $E$  of the type investigated above. On the other hand such a blueprint is realizable by (7.2).  $\square$

## 2. Diagrams with Single Bonds.

The connected spherical diagrams with single bonds are  $A_n, D_n, E_6, E_7, E_8$ .

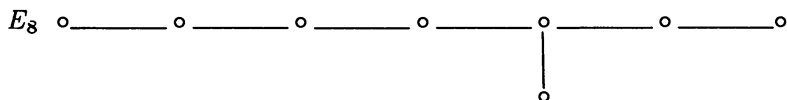
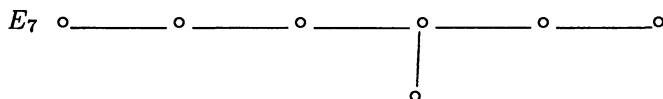
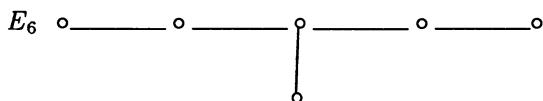
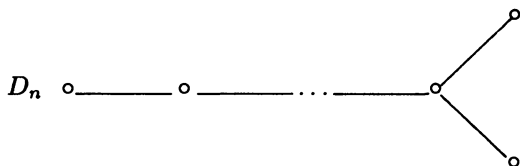
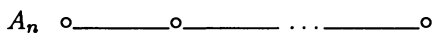

Using the results above, we have the following classification.

**Type  $A_n$ .** By the  $A_3$  result the fundamental root groups  $U_1, \dots, U_n$  acquire field structures, and for  $i = 2, \dots, n-1$  the structure induced on  $U_i$  by the  $\{i-1, i\}$ -residue is opposite that induced by the  $\{i, i+1\}$ -residue. For each field  $k$  (not necessarily commutative) there is a unique foundation (up to isomorphism) and therefore by (7.9) a unique  $A_n$  building, and vice versa. This  $A_n(k)$  building is the flag complex of projective space, exhibited in Example 4 of Chapter 1.

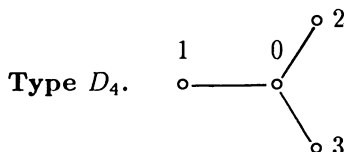

Here the field structures induced on  $U_0$  by the three types of residual planes are mutually opposite. Therefore the field is commutative (an alternative proof of this fact is given by Tits [1974] (6.12), and see also Exercise 9).

**Types  $D_n, E_6, E_7, E_8$ .** By the  $A_3$  result and the  $D_4$  result above, each root group acquires the structure of a commutative field, and these are mutually isomorphic. Therefore for each commutative field  $k$  there is a unique such foundation (up to isomorphism) giving a unique building, and vice versa.

**The  $D_n(k)$  Building.** In the  $D_n$  case the building can be obtained as follows. Take a  $2n$ -dimensional vector space over  $k$  with basis  $x_1, \dots, x_n, y_1, \dots, y_n$ . Define the quadratic form  $Q(v) = \Sigma a_i b_i$  where  $v = \Sigma a_i x_i + \Sigma b_i y_i$ . There are totally singular subspaces  $S$  (i.e.  $Q(s) = 0 \forall s \in S$ ) of dimensions 1 up to  $n$ , those of dimension  $n-1$  being contained in exactly two of dimension  $n$  (Exercise 1). For this reason the totally singular subspaces do not give a thick  $C_n$  building. However, the following construction gives a thick  $D_n$  building (see Exercises 2-4).

The chambers of the building are nested sequences of totally singular subspaces of the form

$$S_1 \subset S_2 \subset \dots \subset S_{n-2} \quad \begin{array}{l} \curvearrowright S_n \\ \curvearrowright S'_n \end{array}$$

where those of dimension  $n-1$  have been omitted, and  $\dim(S_n \cap S'_n) = n-1$ . Such sequences are called *oriflammes* in [loc. cit.] (7.12); two are adjacent if they differ in at most one term. Considering the building as a simplicial complex its vertices are all totally singular subspaces of dimension  $\neq n-1$ ; two vertices are joined by an edge if and only if, as subspaces, one contains the other, or they both have dimension  $n$  and intersect in dimension  $n-1$ .

If  $k$  is an algebraically closed field, the appropriate group is the orthogonal group  $O_{2n}(k)$ . If  $k$  is a finite field  $F_q$  this is usually written  $O_{2n}^+(q)$  to distinguish it from the other orthogonal group  $O_{2n}^-(q)$ , also known as  ${}^2D_n(q)$ , whose building has type  $C_{n-1}$ .

### 3. $C_3$ Foundations.

Since a  $C_3$  building is Moufang, its  $A_2$  and  $C_2$  residues are Moufang (see (6.8)), and, as mentioned earlier, a Moufang plane is either Desarguesian, or is a Cayley plane. We shall treat these two cases separately.

**The Case of Desarguesian planes.** In this case the quadrangle has to be of classical type (cf. Exercise 8). This means it arises, as in section 4, from a hermitian or a pseudo-quadratic form of Witt index 2 on a vector space  $V$  over a field  $K$  (not necessarily commutative). The vertices (points and lines) of the quadrangle are the totally isotropic (or singular) 1- and 2-spaces of  $V$  respectively. The residues for the 2-spaces will be called line-residues because their chambers correspond to the points of a projective line (1-spaces in a 2-space) over  $K$ .

In fact the quadrangle induces a field structure  $K$  on its punctured line-residues, and in the spirit of (8.1) we can now state the following consequence of the classification in [loc. cit.] Chapter 8.

(8.2) **THEOREM.** *A  $C_3$  foundation whose plane is Desarguesian supports a building if and only if the plane and the quadrangle induce opposite field structures on their common punctured rank 1 residue.*  $\square$

#### Remarks.

1. It can happen that both types of residues in the quadrangle can be taken as line-residues, namely when the dual (interchanging roles of points and lines) also arises from the 1 and 2-spaces of a vector space; these cases are shown in section 5 when we deal with the Tits diagram for a simple algebraic group.
2. In one of these special cases where both residues can be taken as line residues (the  $D_4/A_1^2$  case), one residue acquires a canonical pair of opposite quaternion structures. In all other cases the field structure is canonical (again see section 5).

**The Case of Cayley planes.** A non-Desarguesian, Moufang plane induces a Cayley algebra  $K$  (8 dimensional over a commutative field  $k$ ) on its punctured rank 1 residues. The quadrangle then has to arise from a 12-dimensional vector space  $K \oplus k^4$  with quadratic form  $n_K(x_0) - x_1x_3 + x_2x_4$ , where  $n_K$  is the norm form of the Cayley algebra. Moreover it is the point-residue (as opposed to the line-residue) which the quadrangle has in common with the plane (a diagrammatic illustration for this is given in section 5).

(8.3) THEOREM. A  $C_3$  foundation whose plane is a Cayley plane supports a building if and only if the quadrangle arises from a 12-space as above, and the plane and the quadrangle induce the same proportionality class of 8-dimensional anisotropic forms on their common punctured residue (one form from the Cayley algebra, the other from the quadratic form on  $W^\perp/W$  where  $W$  is a totally singular 2-space of the 12-space).  $\square$

4.  $C_n$  Buildings for  $n \geq 4$ .



Given a  $C_n$  diagram with  $n \geq 4$ , as shown, there is an  $A_3$  subdiagram, and by (8.1) this forces the planes to be Desarguesian. In fact these  $C_n$  buildings are classified by their  $C_3$  residues, as the following theorem makes clear.

(8.4) THEOREM. A  $C_3$  foundation whose plane is Desarguesian and which supports a building, extends to a unique  $C_n$  foundation supporting a unique building, and for  $n \geq 4$  every  $C_n$  building arises in this way.

PROOF: This is an immediate consequence of Theorems (7.9) and (8.1).  $\square$

As is shown in [loc. cit.] Chapter 8, all such  $C_n$  buildings can be obtained using a vector space endowed with a hermitian or pseudo-quadratic form of Witt index  $n$ . Here I shall simply explain the terminology, details being available in [loc. cit.].

Let  $K$  be a field (not necessarily commutative),  $\sigma$  an anti-automorphism of  $K$  with  $\sigma^2 = \text{id.}$ , and let  $\epsilon = \pm 1$ . Define

$$K_{\sigma, \epsilon} = \{t - \epsilon t^\sigma \mid t \in K\}.$$

Now let  $V$  be a right vector space over  $K$  (not necessarily finite dimensional), and let  $f : V \times V \rightarrow K$  satisfy:

- (0)  $f(xa, yb) = a^\sigma f(x, y)b$  for all  $x, y \in V$  and  $a, b \in K$ .
- (1)  $f(y, x) = \epsilon f(x, y)^\sigma$ .
- (2)  $f(x, x) = 0$  if  $\sigma = \text{id.}$  and  $\epsilon = -1$ , in which case  $f$  is called a *symplectic* (or *alternating*) form.

Condition (0) means  $f$  is a *sesquilinear* (“ $1\frac{1}{2}$ -linear”) form relative to  $\sigma$ , and condition (1) implies in particular that the relationship  $x \perp y$  (meaning  $f(x, y) = 0$ ) is symmetric. Such a form will generally be called *hermitian*,

or more precisely  $(\sigma, \epsilon)$ -hermitian. If  $\sigma = \text{id.}$  and  $\epsilon = 1$  it is often called a *symmetric bilinear form*.

We now define  $q : V \rightarrow K/K_{\sigma, \epsilon}$  to be a *pseudo-quadratic form* associated to  $f$  if:

$$(3) \quad q(xa) = a^\sigma q(x)a \text{ for all } x \in V \text{ and } a \in K.$$

$$(4) \quad q(x + y) = q(x) + q(y) + f(x, y) + K_{\sigma, \epsilon} \text{ for } x, y \in V.$$

When  $\sigma = \text{id.}$  and  $\epsilon = 1$  one has  $K_{\sigma, \epsilon} = 0$  and  $q$  is called a *quadratic form*.

Notice that a non-zero sesquilinear form must map *onto*  $K$ , so  $q$  determines  $f$  except when  $K = K_{\sigma, \epsilon}$ . In fact  $K = K_{\sigma, \epsilon}$  if and only if  $\sigma = \text{id.}$  and  $\epsilon \neq 1$  (Exercise 5), in which case  $\text{char } K \neq 2$  (because  $\epsilon \neq 1$ ) and  $f$  is a symplectic form.

Notice also that  $q$  is uniquely determined by its associated sesquilinear form  $f$  when  $\text{char } K \neq 2$ , because  $q(x) = \frac{1}{2}f(x, x) + K_{\sigma, \epsilon}$ . More generally if there is an element  $\lambda$  in the centre of  $K$  such that  $\lambda + \lambda^\sigma = 1$ , then  $q(x) = \lambda f(x, x) + K_{\sigma, \epsilon}$  (see Exercise 6); this occurs for  $\text{char } K = 2$  when the restriction of  $\sigma$  to the centre of  $K$  is not the identity (the  ${}^2A_n$  case). A necessary and sufficient condition for  $f$  to determine  $q$  is given in [loc. cit.] 8.2.4.

A subspace  $W$  of  $V$  is called *totally isotropic* for  $f$  if  $f(x, y) = 0$  for all  $x, y \in W$ , and *totally singular* for  $q$  if  $q(x) = 0$  for all  $x \in W$ . All maximal totally isotropic (or totally singular) subspaces have the same dimension, called the *Witt index* (see e.g. Artin [1957] 3.10). Notice that the subspace  $V^\perp = \{x \in V \mid f(x, V) = 0\}$  is totally isotropic; we call  $f$  *non-degenerate* if  $V^\perp = 0$ . A pseudo-quadratic form  $q$  is called *non-degenerate* if  $V^\perp$  (for the associated  $f$ ) has no non-zero singular vectors (i.e.,  $V^\perp \cap q^{-1}(0) = 0$ ).

We say  $f$  is *trace-valued* if

$$f(x, x) = a + \epsilon a^\sigma \text{ for some } a \in K.$$

When there are totally isotropic subspaces not contained in  $V^\perp$ , the property of being trace-valued is equivalent to the property that the totally isotropic subspaces span  $V$  ([loc. cit.] 8.1.6). If  $f$  arises from a pseudo-quadratic form, then it must be trace-valued (see Exercise 7 for a proof). Moreover if  $f$  is trace-valued and is not a symplectic form in odd characteristic, then it must arise from a pseudo-quadratic form.

**The Building.** If  $f$  is non-degenerate and trace-valued, or if  $q$  is a non-degenerate pseudo-quadratic form, of Witt index  $n$ , then the totally isotropic



(t.i.), or totally singular (t.s.), subspaces determine a building of type  $C_n$ . The chambers are all maximal nested sequences

$$S_1 \subset \dots \subset S_n$$

of t.i., or t.s., subspaces, and the other simplexes are subsequences of these (see Example 5 in Chapter 1). In particular the vertices are the t.i., or t.s., subspaces themselves. This building is thick providing the form is not the one mentioned in section 2 giving a  $D_n$  building; in that special case each t.s.  $(n-1)$ -space lies in exactly two t.s.  $n$ -spaces.

Theorem (8.2) is a consequence of the following theorem [loc. cit.] (8.22).

(8.5) THEOREM. *Every  $C_3$  building whose planes are Desarguesian, and every  $C_n$  building for  $n \geq 4$  arises from a non-degenerate pseudo-quadratic form, or a non-degenerate hermitian form of Witt index  $n$ .*  $\square$

We emphasize that this vector space could be infinite dimensional; indeed its dimension might not even be countable. For example let  $Z$  be any set and let  $X$  be the disjoint union of  $Z$  and  $\{x_1, \dots, x_n, y_1, \dots, y_n\}$ . We let  $V$  denote the real vector space with basis  $X$ , whose vectors are all  $v = a_1x_1 + \dots + a_nx_n + b_1y_1 + \dots + b_ny_n + \sum_{i=1}^m c_i z_i$  where  $z_i \in Z$  and  $a_i, b_i, c_i \in \mathbf{R}$ . We define  $q(v) = a_1b_1 + \dots + a_nb_n + \sum_{i=1}^m c_i^2$ . This quadratic form has Witt index  $n$ , and if  $Z$  is non-empty we obtain a thick  $C_n$  building.

## 5. Tits Diagrams and $F_4$ Buildings.

To classify  $F_4$  buildings one needs to know which Moufang quadrangles have the property that they and their duals arise from a form (of Witt index 2) on some vector space. It is then a straightforward matter to use (7.9), (8.1), (8.2) and (8.3) to obtain a classification. In order to distinguish the various cases it is helpful to use *Tits diagrams* for reductive algebraic groups over an arbitrary field. Indeed these diagrams also help to explain and illustrate Theorem (8.3) and Remarks 1 and 2 in section 3. Our discussion of these things will necessarily be rather sketchy because we shall avoid using algebraic groups!

First we consider quadratic forms. Let  $\Delta$  be the building obtained using the totally singular subspaces of a quadratic form  $q$  of Witt index  $r$  on a vector space of dimension  $N$  over a commutative field  $K$ . When taken

over a suitable extension  $L$  of  $K$  (for example if  $L$  is the algebraic closure of  $K$ ) this form has Witt index  $n = (N - 1)/2$  if  $N$  is odd, or  $n = N/2$  if  $N$  is even. The corresponding building  $\Delta_L$  is therefore of type  $C_n (= B_n)$  if  $N$  is odd, and type  $D_n$  if  $N$  is even.

The building  $\Delta$  is a subcomplex of  $\Delta_L$  and its vertices belong only to the first  $r$  nodes of the  $\Delta_L$  diagram; the Tits diagram for  $\Delta$  is obtained by circling these nodes, so it is one of the following:

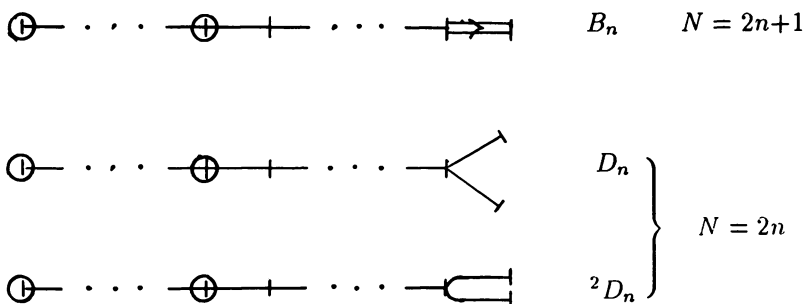

The distinction between  $D_n$  and  ${}^2D_n$  depends on the discriminant. If  $r = 0$  the form is called *anisotropic* in which case  $\Delta$  is vacuous, and there are no circled nodes. For example if  $K = \mathbf{R}$ , the dot product is anisotropic; furthermore for  $K = \mathbf{R}$  and  $N = 2n$  one has the  $D_n$  case when  $n - r$  is even, and  ${}^2D_n$  when  $n - r$  is odd. We shall be particularly interested in

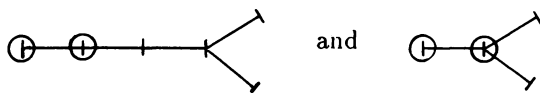



which represent quadratic forms of Witt index 2 on vector spaces of dimensions 12 and 8 respectively, over a commutative field.

Now let  $K$  be a non-commutative field having finite dimension over its centre  $k$ . If  $L$  is a maximal commutative subfield of  $K$  containing  $k$ , then  $\dim_k L = \dim_L K = d$ , so  $\dim_k K = d^2$  ( $d$  is called the *degree* of  $K$  over its centre, and in fact  $L$  is a splitting field for  $K$  in the sense that  $K \otimes_k L$  is a  $d \times d$  matrix algebra over  $L$ ). For example if  $K$  is the quaternions, then  $k = \mathbf{R}$  and  $L = \mathbf{C}$ .

Consider the  $A_r(K)$  building. Its vertices are subspaces of a vector space  $V$  of dimension  $r + 1$  over  $K$ . They become certain subspaces of dimension  $d, 2d, \dots, rd$  when we take  $V$  as a  $d(r + 1)$ -dimensional vector space over  $L$ . Thus the  $A_r(K)$  building is a subcomplex of the  $A_{d(r+1)-1}(L)$

building, whose vertices have only those types circled in the following diagram:

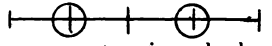

We shall be particularly interested in the diagram  which represents a projective plane ( $A_2$  building) over a quaternion algebra (i.e.,  $d = 2$ ). The subdiagram  represents a projective line over a quaternion algebra.

In general, given a pseudo-quadratic or sesquilinear form of Witt index  $r$  on a finite dimensional vector space over a field, where the field has finite degree  $d$  over its centre  $k$ , the diagram is  $B_n, C_n, D_n, {}^2D_n$  or  ${}^2A_n$  (see Appendix 2) in which nodes  $d, 2d, \dots, rd$  are circled. These are the cases which arise from algebraic groups, the finite-dimensional over  $k$ .

**Non-Desarguesian Moufang Planes (Cayley Planes).** As mentioned earlier, a non-Desarguesian, Moufang plane is coordinatised by a Cayley division algebra  $K$ , 8-dimensional over its centre  $k$ . We let  $K_0$  denote a maximal commutative subfield of  $K$ ; it has dimension 2 over  $k$ . For example if  $K$  is the Cayley numbers, then  $k = \mathbf{R}$  and  $K_0 = \mathbf{C}$ . The points and lines of this Cayley plane can be taken as certain vertices in an  $E_6(K_0)$  building (see [loc. cit.] (5.12), and earlier references cited there for more details); the two types of vertices are circled in the following diagram.



Each rank 1 residue is represented by a subdiagram of shape

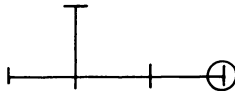

In particular if  $L$  is a line, its points correspond to the totally singular subspaces of a quadratic form  $q$  of Witt index 1 on a 10-dimensional vector space  $W$  over  $k$ . If  $p$  is a point of  $L$ , and  $\langle w \rangle$  the corresponding t.s. 1-space of  $W$ , then  $\langle w \rangle^\perp / \langle w \rangle$  is an 8-space on which  $q$  is anisotropic, and the root group fixing all points of  $L$  and all lines on  $p$  is the additive group of this 8-space. This space also acquires a multiplicative structure (Appendix 1 section 2) making it a Cayley algebra, and the anisotropic form induced by  $q$  is nothing other than the norm form of the Cayley algebra.

**$C_3$  Buildings having Cayley Planes.** We now explain Theorem 8.3 using diagrams. We have seen that a rank 1 residue of a Cayley plane has diagram

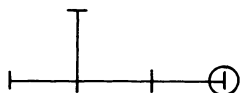

The only Moufang quadrangle having such a rank 1 residue is that with diagram

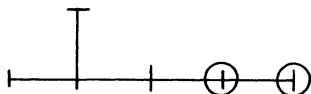

This quadrangle arises from a quadratic form  $q$  of Witt index 2 on a 12-dimensional vector space  $V$ , and if  $U$  is the 2-space corresponding to a line of the quadrangle, then  $q$  induces an anisotropic quadratic form on the 8-space  $U^\perp/U$ . After multiplication by a scalar, this is the norm form of the Cayley algebra for the plane. The diagram for the  $C_3$  building is obtained by glueing the plane and quadrangle diagrams along their common residue to obtain the following form of  $E_7$ .

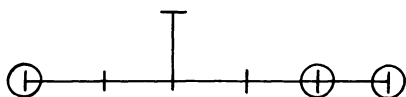

**$F_4$  Buildings.** Recall the  $F_4$  diagram



Both residues of the quadrangle are also residues of Moufang planes. If one of these is a Cayley plane, then the quadrangle is that given above, and the two  $C_3$  subdiagrams are forced to be

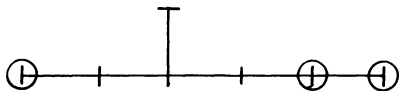

and

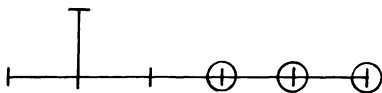

Identifying the common rank 2 (quadrangle) residue gives a form of  $E_8$

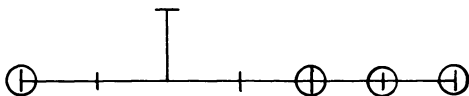

This is the diagram for an  $F_4$  building having a Cayley plane.

Now suppose both planes are Desarguesian. In this case the quadrangle must have the property that both types of vertices can be thought of as points, represented by totally singular (or isotropic) 1-spaces under a suitable form (see Remark 1 in section 3). This reduces us to four possible cases (see [loc. cit.] (10.10), and compare with the list of diagrams in Appendix 2). These are:

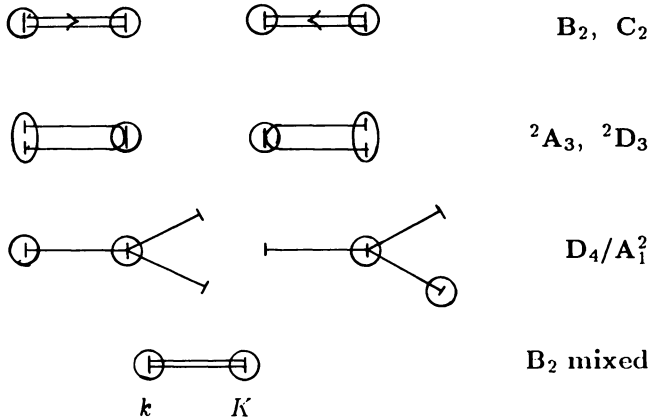

The diagrams on the left are those arising from the quadratic form  $n_K(x_0) - x_1x_3 + x_2x_4$  on  $K \oplus k^4$  with  $x_0 \in K$ , and  $x_1, \dots, x_4 \in k$ , where  $k$  is commutative and  $K$  is one of:

- (1)  $k$  itself, and  $n_K(x_0) = x_0^2$   $B_2$
- (2) a separable quadratic extension of  $k$ , with norm  $n_K$   ${}^2A_3$
- (3) a quaternion algebra over  $k$ , with norm  $n_K$   $D_4/A_1^2$

Those on the right arise from a form  $f$  on a 4-dimensional vector space over  $K$ , where one of the following holds:

- (1')  $K$  is commutative, and  $f$  is alternating  $C_2$
- (2')  $K$  is commutative, and  $f$  is  $(\sigma, 1)$ -hermitian with  $[K : K^\sigma] = 2$   ${}^2D_3$
- (3')  $K$  is a quaternion algebra with centre  $k$ , and  $f$  is psuedo-quadratic (equivalently  $(\sigma, -1)$ -hermitian if  $\text{char } k \neq 2$  and  $\text{tr}_{K/k}(x) = x + \sigma(x)$ )  $D_4/A_1^2$

The final diagram represents the  $B_2$  quadrangles of "mixed type" where  $K \supset k \supset K^2$ , and the quadratic form is  $x_0^2 + x_1x_3 + x_2x_4$  where  $x_0 \in K$  and  $x_1, \dots, x_4 \in k$ .

**Digression.** We now briefly explain Remark 2 of section 3. In each quadrangle diagram of classical type, the line-residue has diagram



This represents a 2-dimensional vector space  $U$  over  $K$ , and the reversal of the diagram represents the dual vector space  $U^*$ . In every case except  $D_4/A_1^2$  this subdiagram is connected at one end to the rest of the quadrangle diagram, and so this gives a preferred choice between  $U$  and  $U^*$ . However in the  $D_4/A_1^2$  case

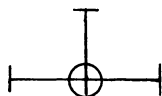

the residual diagram  $\text{---} \oplus \text{---}$  has no preferred direction, so there is no distinction between  $U$  and its dual, and consequently no distinction between  $K$  and its opposite. In this special case  $K$  has degree 2 over its centre, or in other words is a quaternion algebra.

**The  $F_4$  Classification.** Using the quadrangle diagrams above we are now able to write down the full classification of  $F_4$  buildings, which the reader should check (Exercise 10). For completeness we include the diagram involving a Cayley plane, obtained earlier.

The full list of diagrams for  $F_4$  buildings is

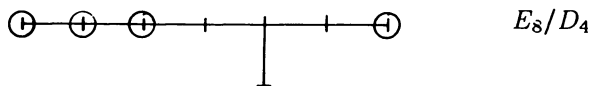

$E_8/D_4$

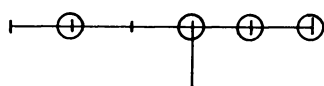

$E_7/A_1^3$

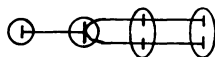

${}^2E_6$

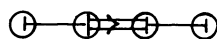

$F_4$

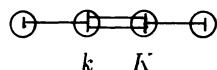

$F_4$  mixed

The last diagram is for char  $k = 2$  and  $K \supset k \supset K^2$ ; if  $k = K$  this is the usual  $F_4$  diagram.

## 6. Finite Buildings.

A finite building is always of spherical type because its apartments are finite Coxeter complexes. Assuming a connected diagram, the classification for rank  $\geq 3$  corresponds to the cases in sections 3-5 where the field is finite; and for rank 2, the classification of finite Moufang  $m$ -gons was done group theoretically by Fong and Seitz [1973] and [1974]. The groups concerned are called *finite groups of Lie type*, and are tabulated in Appendix 6 (this includes the rank 1 case for which the building is just a finite set of points). Our purpose here is to understand the effect of finiteness on the classification, and to remark on the order of the group and the fact that the subgroup  $U$  (of Chapter 6 section 4) is a Sylow- $p$ -subgroup.

The fact that a finite field is commutative makes an immediate simplification; it implies for example that there is no  $F_4$  building of type  $E_7/A_1^3$  as this requires a quaternion algebra. Furthermore there is no finite Cayley division algebra, so this eliminates  $C_3$  buildings having Cayley planes, and hence  $F_4$  buildings of type  $E_8/D_4$ . The  $F_4$  buildings of mixed type cannot occur either because finite fields are perfect; thus the  $F_4$  classification reduces to two cases:  ${}^2E_6(q)$  and  $F_4(q)$ , one for each ground field  $\mathbf{F}_q$ .

As to  $C_n$  buildings, the classification of non-degenerate  $(\sigma, \epsilon)$ -hermitian forms on a vector space of dimension  $N$  over a finite field is well-known. If  $N$  is odd the Witt index is  $(N - 1)/2$  and the form can be taken to be unitary ( $\sigma \neq \text{id.}$ ) or orthogonal ( $\sigma = \text{id.}$ ). If  $N$  is even, either the index is  $\frac{N}{2}$  and the form is symplectic, unitary or orthogonal (group  $O_N^{\pm}$ ), or the index is  $\frac{N}{2} - 1$  and the form is orthogonal (group  $O_{\bar{N}}$ ). Given Witt index  $n$  and an arbitrary finite field  $\mathbf{F}_q$  there is in each case a unique class of forms for which  $\mathbf{F}_q$  is the fixed field of  $\sigma$ . Each of them gives a (thick)  $C_n$  building, except  $O_{2n}^+$  which gives a  $D_n$  building. The finite simple groups are usually denoted respectively:  $U_{2n+1}(q)$ ,  $O_{2n+1}(q)$ ,  $Sp_{2n}(q)$ ,  $U_{2n}(q)$ ,  $O_{2n}^+(q)$ ,  $O_{2n+2}^-(q)$  - see Appendix 6.

To conclude this discussion we state a theorem.

(8.6) THEOREM. *The finite buildings having a connected diagram and rank  $\geq 3$  are those (of rank  $\geq 3$ ) listed in Appendix 6.  $\square$*

Now let  $\Delta$  be such a building (or a finite Moufang  $m$ -gon) and let  $p$  be the characteristic of the field. Let  $G = \text{Aut } \Delta$ , and let  $B$  be the

stabilizer of a chamber  $c \in \Delta$ . From Chapter 6 section 4,  $B = UH$  where  $U$  is generated by a set of positive root groups and acts simple-transitively on the set of apartments containing  $c$ , and  $H$  is the pointwise stabilizer of such an apartment  $\Sigma$ . We shall demonstrate that  $U$  is a  $p$ -group and that  $p \nmid |G : U|$ . Thus  $U$  is a Sylow- $p$ -subgroup of  $G$ , and  $B$  is a Sylow- $p$ -normalizer (Exercise 16 of Chapter 6).

As a first step let  $w = r_{i_1} \dots r_{i_\ell}$  be a reduced expression for  $w \in W$ . Then the number of chambers  $d$  such that  $\delta(c, d) = w$  is the same as the number of galleries of type  $i_1 \dots i_\ell$  starting at  $c$ , and this in turn equals the product  $q_{i_1} \dots q_{i_\ell}$  where  $1 + q_{i_j}$  is the number of chambers in a residue of type  $i_j$ . In all but one case the chambers of such a residue correspond to the points of a projective line, or of a quadric, so  $q_i$  is a power of  $p$  (the exception is for  ${}^2F_4$  where one type of residue is a Suzuki oval, but  $q_i$  is still a power of  $p$ ). Thus the number of chambers  $d$  with  $\delta(c, d) = w$  is a power of  $p$ . In particular this is true of chambers opposite  $p$  (equivalently apartments containing  $c$ ), and so by (6.15)  $U$  is a  $p$ -group.

To continue our argument notice that for a panel  $\pi$ , any  $p$ -element fixing two chambers of  $St(\pi)$  must fix a third (because  $St(\pi)$  has  $1 \pmod{p}$  chambers), and hence acts trivially on  $St(\pi)$ . Therefore by (6.4) any  $p$ -element fixing  $c$  and the apartment  $\Sigma$  acts trivially on  $\Delta$ , so  $p \nmid |H|$ . Thus  $p \nmid |B : U|$  and it remains to show that  $p \nmid |G : B|$ . In fact  $|G : B|$  is the number of chambers and this is  $1 \pmod{p}$  because, as shown above, the number of chambers at distance  $w$  from  $c$  is a power of  $p$  (greater than 1 if  $w \neq 1$ ). We therefore have the following theorem.

(8.7) **THEOREM.**  *$U$  is a Sylow- $p$ -subgroup of the full automorphism group, and  $B$  is a Sylow- $p$ -normalizer.*  $\square$

**Remarks.** Notice that if  $G$  is any group of automorphisms of  $\Delta$ , containing  $U$ , the subgroup  $B$  stabilizing a chamber is a Sylow- $p$  normalizer. As to  $H$ , it could contain  $p$ -elements, but only acting trivially on  $\Delta$  of course. Notice also that we almost have a formula for the order of  $G$ . In the "untwisted" case where each rank 1 residue can be regarded as a projective line over the same field  $\mathbf{F}_q$ , the number of chambers opposite  $c$  is  $q^N$  where  $N$  is the length of the longest word. Furthermore the total number of chambers is  $\sum_{w \in W} q^{\ell(w)}$ . Thus

$$|G : H| = q^N \sum_{w \in W} q^{\ell(w)}$$

and the only imponderable is the order of  $H$ . If  $G = GL_n(q)$  then  $H$  is



the group of diagonal matrices, isomorphic to  $\mathbf{F}_q^\times \times \dots \times \mathbf{F}_q^\times$  ( $n$  copies); it contains the kernel of the action of  $G$  on  $\Delta$ , namely the group of scalar matrices, isomorphic to  $\mathbf{F}_q^\times$ . In  $PGL_n(q)$ ,  $H$  is the product of  $n - 1$  copies of  $\mathbf{F}_q^\times$ , one for each panel  $\pi$  of the chamber  $c$  (cf. Exercise 12 of Chapter 6). This is the usual form of  $H$  - for example in  $E_8(q)$ ,  $H$  is isomorphic to a direct product of 8 copies of  $\mathbf{F}_q^\times$ . Finally we remark that the expression  $\Sigma q^{l(w)}$  can be written as a product  $\prod_{i=1}^n \frac{q^{d_i-1}}{q-1}$  where  $n$  is the rank. For this and for further details on these finite groups the standard reference is the book by Carter [1972].

**Notes.** The classification of spherical buildings (having a connected diagram of rank  $\geq 3$ ) is one of the principal objectives of Tits [1974], where the complete solution is given. The main difficulty concerned  $C_n$  buildings, described as polar spaces in Chapter 7, and classified in Chapters 8 and 9 of [loc. cit.]. The reduction to the  $C_3$  case (8.4) was proved earlier by Veldkamp [1959] who determined all such polar spaces, except the ones involving Cayley planes, and those over non-commutative fields of characteristic 2, where the concept of a pseudo-quadratic form is needed; these forms were introduced by Tits [1974] Chapter 8. A very simple characterization of polar spaces is given by Buekenhout and Shult [1974]; the idea is that they are "point-line geometries" in which for each point  $p$  and line  $L$ ,  $p$  is collinear with one or all points of  $L$  (though see their paper for other conditions on non-degeneracy and finite rank). The use of Tits diagrams for the classification of  $F_4$  buildings appears in Chapter 10 of Tits [1974], and the diagrams themselves are introduced in Tits [1966]. Finally, in the case of single bond diagrams, Tits [1974] Chapter 5 uses the existence of algebraic groups of types  $E_6$ ,  $E_7$  and  $E_8$  to obtain buildings of these types, and it was only recently (Ronan-Tits [1987]) that the buildings could be obtained independently (section 2 of this chapter). In fact Theorem (6.6) (proved in Chapter 4 of Tits [1974]) can now be used to obtain the groups from the buildings.

### Exercises to Chapter 8

1. Given a  $2n$ -dimensional vector space with the quadratic form for a  $D_n$  building as in section 2, verify that every totally singular  $(n - 1)$ -space is contained in exactly two t.s.  $n$ -spaces. [HINT: The orthogonal group

is transitive on t.s.  $(n - 1)$ -spaces, by Witt's theorem - see e.g. Artin [1957] Theorem 3.9].

2. With the hypotheses of Exercise 1, let  $X, Y, X'$  be t.s.  $n$ -spaces such that  $X \cap Y$  has dimension  $n - 1$ , and  $X \cap X' = X \cap Y \cap X'$  has dimension  $n - 2$ . Show that  $X' \cap Y$  has dimension  $n - 1$ .
3. Using Exercise 2, show that the graph whose vertices are t.s.  $n$ -spaces containing a fixed  $(n - 2)$ -space, and whose edges are pairs  $X, Y$  where  $\dim(X \cap Y) = n - 1$ , is a complete bipartite graph.
4. Verify that the chamber system in section 2 obtained using the t.s. subspaces of dimension  $\neq n - 1$  is indeed a chamber system of type  $D_n$  in the sense of Chapter 4. Show it is simply-connected, and hence a building. [HINT: For simple-connectivity use (4.10); any path is homotopic (in the topological sense) to one of points (1-spaces) and lines (2-spaces), and such paths are easily decomposed into triangles each of which lies in the residue of a 3-space].
5. With the notation of section 4, show that  $K = K_{\sigma, \epsilon}$  if and only if  $\sigma = \text{id.}$  and  $\epsilon \neq 1$ .
6. Let  $K$  be a field with centre  $k$ , and let  $q, f$  be as in section 4. Given an element  $\lambda \in k$  with  $\lambda + \lambda^\sigma = 1$ , show that  $q(x) = \lambda f(x, x) + K_{\sigma, \epsilon}$ . Show such a  $\lambda$  exists if  $\sigma|_k \neq \text{id.}$  [HINT: Expand  $q(x(1 + \lambda))$  in two different ways].
7. If a sesquilinear form  $f$  arises from a pseudo-quadratic form  $q$ , show that  $f$  is trace-valued. In fact  $f(x, x) = a + \epsilon a^\sigma$  where  $a = q(x)$ . [HINT: For  $x \in V, t \in K$  expand  $q(x(1 + t))$  in two different ways, and use  $t^\sigma q(x) \equiv \epsilon q(x)^\sigma t \pmod{K_{\sigma, \epsilon}}$  to derive  $(f(x, x) - q(x) - \epsilon q(x)^\sigma)t \in K_{\sigma, \epsilon}$  for all  $t \in K$ ].
8. Observe that none of the exceptional Moufang quadrangles in Appendix 2 has a rank 1 residue which is the same as a rank 1 residue of a Moufang plane (and for this reason cannot form part of a  $C_3$  building).
9. Consider the Tits diagram for a Desarguesian plane over a non-commutative field (i.e.,  $d \neq 1$ ). Show it is impossible to have three such diagrams sharing a common rank 1 diagram (this is a diagrammatic way of seeing that there is no  $D_4$  building over a non-commutative field).
10. Verify that the list of diagrams for  $F_4$  buildings is complete. In the  $E_7/A_1^3$  case let  $k$  and  $K$  be the fields for the residual planes; what is the relationship between  $k$  and  $K$ ?

## Chapter 9 AFFINE BUILDINGS I

In this chapter we shall define affine buildings, and show that every affine building gives rise to a spherical building “at infinity”. This building at infinity is a generalization of the “celestial” sphere at infinity of Euclidean space, whose points may either be taken as parallel classes of half-lines, or half-lines emanating from some fixed point.

### 1. Affine Coxeter Complexes and Sectors.

A building is called *affine* (or *of affine type*) if for each connected component of the diagram, the corresponding Coxeter complex can be realized as a triangulation of Euclidean space in which all chambers are isomorphic. Since any building is a direct product of buildings, one for each connected component of the diagram, nothing is lost by restricting attention to connected diagrams, and we shall do this. We remark however that for non-connected diagrams, the Coxeter complex can be regarded as a tessellation of Euclidean space in which each chamber is a product of simplexes (e.g. in the  $\tilde{A}_1 \times \tilde{A}_2$  case a chamber is a prism); in such cases the building can be described as a “polysimplicial complex” - Bruhat-Tits [1972].

The various classes of connected affine diagrams are listed below; the number of nodes is  $n+1$  for type  $\tilde{X}_n (X = A, \dots, G)$ , and the nodes marked by an  $s$  are the possible types of “special vertices” (explained later).

DIAGRAM

TYPE

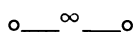

$\tilde{A}_1$

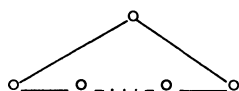

$\tilde{A}_n, n \geq 2$

DIAGRAM	TYPE
	$\tilde{B}_n, n \geq 3$
	$\tilde{C}_n, n \geq 2$
	$\tilde{D}_n, n \geq 4$
	$\tilde{E}_6$
	$\tilde{E}_7$
	$\tilde{E}_8$
	$\tilde{F}_4$
	$\tilde{G}_2$

In the  $\tilde{A}_1$  case the Coxeter complex is nothing other than a doubly infinite sequence of chambers  $\cdots c_{-1}, c_0, c_1, c_2, \cdots$  each of which is adjacent to its two neighbors, and this can obviously be realized as the Real line with integer points as panels and unit intervals as chambers. For the other diagrams, which have at least three nodes, each chamber can be taken as a Euclidean simplex such that for each  $i, j \in I$  the angle between the  $i$ -face and the  $j$ -face is  $\pi/m_{ij}$ . For example, if  $I = \{1, 2, 3\}$  then since the sum of

the angles of a Euclidean triangle is  $\pi$ , one has:

$$\frac{1}{m_{12}} + \frac{1}{m_{13}} + \frac{1}{m_{23}} = 1,$$

giving the diagrams  $\tilde{A}_2$ ,  $\tilde{C}_2$  and  $\tilde{G}_2$ .

More generally consider an  $n$ -dimensional Euclidean simplex  $c$  in  $\mathbf{R}^n$ , whose codimension 1 faces are labelled by elements of an  $(n + 1)$ -set  $I$ , such that the angle between the  $i$ -face and  $j$ -face is  $\pi/m_{ij}$  for some integer  $m_{ij}$ . The group generated by reflections in the codimension 1 faces of  $c$  is the Coxeter group  $W$  of type  $M = (m_{ij})$ . Indeed if  $s_i$  is the reflection in the  $i$ -face, then  $s_i s_j$  has order  $m_{ij}$  and hence the  $s_i$  certainly generate a quotient of  $W$ . This shows that the Coxeter complex maps onto  $\mathbf{R}^n$ , and once this map is shown to be a homeomorphism in the neighborhood of each point (see Exercise 6), it follows from the simple-connectivity of  $\mathbf{R}^n$  that the map is an isomorphism of simplicial complexes, and the  $s_i$  generate  $W$  itself. This also shows that a connected diagram is affine precisely when there exists a Euclidean simplex whose dihedral angles are  $\pi/m_{ij}$ .

In its action on  $\mathbf{R}^n$ ,  $W$  is a discrete subgroup of the group of affine isometries, of shape  $\mathbf{R}^n \cdot O(n)$ , where  $\mathbf{R}^n$  is the normal subgroup of translations, and  $O(n)$  is the orthogonal group, stabilizing a point. Thus  $W$  has a normal subgroup  $\mathbf{Z}^n$  of translations whose quotient  $W_o$ , being a discrete subgroup of the compact group  $O(n)$ , is finite. Moreover since  $W$  is generated by reflections,  $W_o$  is generated by images of these reflections; but a finite group generated by reflections is a Coxeter group and in this case it is generated by just  $n$  linearly independent reflections (see Bourbaki [1968/81] Ch. V, section 3.9, Prop. 7, p.85). Let  $s_1, \dots, s_n$  be reflections in  $W$ , whose images in  $W_o$  generate  $W_o$ , and let  $M_1, \dots, M_n$  be the walls fixed by  $s_1, \dots, s_n$  respectively. Since the  $M_i$  have codimension 1 and are linearly independent their intersection is a vertex. Such vertices are called *special*.

Notice that any finite subgroup of  $W$  maps (via  $W \rightarrow W/\mathbf{Z}^n$ ) isomorphically into  $W_o$ , because  $\mathbf{Z}^n$  contains no non-identity elements of finite order. Therefore using the orders of finite Coxeter groups in Appendix 5, it is a simple matter to check which vertices are special.

**Sectors.** Let  $s$  denote a special vertex, and  $c$  a chamber having  $s$  as one of its vertices. The panels of  $c$  having  $s$  as a vertex determine roots  $\alpha_1, \dots, \alpha_n$  containing  $c$ , and their intersection  $S = \alpha_1 \cap \alpha_2 \cap \dots \cap \alpha_n$  is called a *sector*

(French: *quartier*) with vertex  $s$  and base chamber  $c$ . In terms of the affine space structure, a sector is a simplicial cone; Figure 9.1 shows an example in the  $\tilde{G}_2$  case.

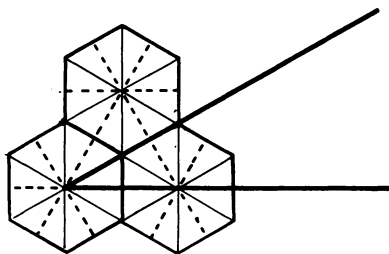

Figure 9.1

That part of a wall bounding a sector (e.g.,  $\partial\alpha_1 \cap \alpha_2 \cap \dots \cap \alpha_n$ ) will be called a *sector-panel* (French: *cloison de quartier*).

(9.1) LEMMA. *If the sector  $S$ , having vertex  $s$ , contains the sector  $T$ , then  $S$  is the convex hull of  $s$  and  $T$ .*

PROOF: Let  $V$  denote the convex hull of  $s$  and  $T$ , which by (2.8) is an intersection of roots. Let  $\alpha$  be any root containing  $s$  and  $T$ , and let  $\alpha' \subset \alpha$  be a root having  $s$  on its boundary. Since the boundary walls  $\partial\alpha$  and  $\partial\alpha'$  must be parallel, the strip  $\alpha - \alpha' = \alpha \cap (-\alpha')$  cannot contain a sector. In particular  $T \not\subset -\alpha'$ , hence  $S \not\subset -\alpha'$ , and therefore  $S$  lies in  $\alpha'$  (it must lie in  $\alpha'$  or  $-\alpha'$ , since  $s \in \partial\alpha'$ ). Therefore  $V$  lies in  $\alpha'$ , and is hence an intersection of roots whose boundary walls contain  $s$ . Thus  $V$  is a simplicial cone, and since  $S$  is a minimal simplicial cone (having only one base chamber) we conclude that  $V = S$ .  $\square$

(9.2) LEMMA. *Given sectors  $S$  and  $S'$  in an affine Coxeter complex,  $S'$  is a translate of  $S$  if and only if  $S \cap S'$  contains a sector, in which case  $S \cap S'$  is a sector. In particular if  $S$  contains subsectors  $S_1$  and  $S_2$ , then  $S_1 \cap S_2$  is a sector.*

PROOF: If  $S'$  is a translate of  $S$ , then it is a straightforward exercise to show that  $S \cap S'$  is a sector (Exercise 2). To prove the converse it suffices to show that if a sector  $S$  contains a sector  $T$ , then  $S$  is a translate of  $T$ .

Indeed let  $g$  be a translation for which  $g(T)$  has the same vertex as  $S$ . Then  $g(T) \cap T$  is a sector lying in both  $g(T)$  and  $S$ , and since these have the same vertex, (9.1) implies  $g(T) = S$ . To prove the final statement notice that  $S_1$  and  $S_2$  are both translates of  $S$ , hence  $S_2$  is a translate of  $S_1$ , so  $S_1 \cap S_2$  is a sector.  $\square$

## 2. The Affine Building $\tilde{A}_{n-1}(K, v)$ .

**The Discrete Valuation.** Let  $K$  be a field (not necessarily commutative) with a *discrete valuation*  $v$ ; after multiplying  $v$  by a suitable positive real number this means that we have a surjective map  $v : K^\times \rightarrow \mathbf{Z}$  satisfying

$$\begin{aligned} v(ab) &= v(a) + v(b) \\ v(a + b) &\geq \min(v(a), v(b)) \end{aligned}$$

for all  $a, b \in K$ , with the convention that  $v(0) = +\infty$ . Let  $\mathcal{O}$  denote the *valuation ring* of  $K$  with respect to  $v$ :

$$\mathcal{O} = \{a \in K \mid v(a) \geq 0\}.$$

This ring has a unique maximal ideal  $\mathfrak{m}$ :

$$\mathfrak{m} = \{a \in K \mid v(a) \geq 1\}.$$

We let  $\pi \in K^\times$  be a *uniformiser*, i.e.,  $v(\pi) = 1$ . For each  $a \in K^\times$  one has

$$a\mathcal{O} = \mathcal{O}a = \pi^{v(a)}\mathcal{O} = \{x \in K \mid v(x) \geq v(a)\}.$$

In particular the ideals of  $\mathcal{O}$  are the  $\mathfrak{m}^\ell$  where  $\ell = 1, 2, \dots$ . We let  $k$  denote the *residue field*  $\mathcal{O}/\mathfrak{m} = \mathcal{O}/\pi\mathcal{O}$ . For details on fields having a discrete valuation, see for example the book *Local Fields* by Serre [1962/79].

**Exercise.** If  $v(a) < v(b)$ , show that  $v(a + b) = v(a)$ .

**Example 1.** Let  $K = \mathbf{Q}$  (the rational numbers), and let  $p$  be a prime. Every rational can be written as  $p^n a/b$  where  $a$  and  $b$  are integers not divisible by  $p$ . We set  $v(p^n a/b) = n$ . The valuation ring is the ring  $\mathbf{Z}_{(p)}$  of integers localised at the prime ideal  $(p)$ , and the residue field is the finite field  $\mathbf{Z}/(p)$  of integers modulo  $p$ . Every discrete valuation of  $\mathbf{Q}$  is obtained in this way for some prime  $p$ .

**Example 2.** Let  $k$  be a commutative field and let  $K = k(t)$ , the field of rational functions in one variable. If  $f$  and  $g$  are polynomials then  $v_\infty\left(\frac{f}{g}\right) = \deg g - \deg f$  is a discrete valuation. Moreover one obtains discrete valuations  $v_a$  for each element  $a \in k$ , as follows. Any rational function can be written  $(t-a)^n \frac{f}{g}$  where  $f$  and  $g$  are polynomials not divisible by  $(t-a)$ ; set  $v_a\left((t-a)^n \frac{f}{g}\right) = n$ . If  $k$  is algebraically closed, every discrete valuation which is trivial on  $k$  is  $v_\infty$  or  $v_a$  for some  $a \in k$ .

**Lattices.** Let  $V$  be an  $n$ -dimensional vector space over  $K$ . A  $v$ -lattice (or simply a lattice) of  $V$  will mean any finitely generated  $\mathcal{O}$ -submodule of  $V$  which generates the  $K$ -vector space  $V$ ; such a module is free of rank  $n$ . If  $L$  is a lattice, and  $a \in K^\times$ , then since  $a\mathcal{O} = \mathcal{O}a$ , we see that  $aL$  is also a lattice. We shall call two lattices *equivalent* if one is a multiple of the other in this way; this is clearly an equivalence relation, and we let  $[L]$  denote the equivalence class of the lattice  $L$ .

We now define the building  $\Delta$  as a simplicial complex as follows. Its vertices are the classes  $[L]$  of lattices. Its edges are the unordered pairs of vertices  $x$  and  $y$  such that if  $L$  is in the class of  $x$ , there is an  $L'$  in the class of  $y$  for which  $\pi L \subset L' \subset L$ ; the existence of such an  $L'$  is independent of the lattice  $L$  chosen to represent  $x$ . The simplexes are given by sets of vertices any two of which lie on a common edge. Such sets of vertices can be written as  $[L_1], [L_2], \dots, [L_t]$  where

$$L_1 \supset L_2 \supset \dots \supset L_t \supset \pi L_1. \quad (\dagger)$$

Since  $L_i/\pi L_1$  is a subspace of the  $n$ -dimensional  $k$ -vector space  $L_1/\pi L_1$  ( $k$  is the residue field  $\mathcal{O}/\pi\mathcal{O}$ ), one sees that maximal simplexes have  $n$  vertices - these are the *chambers*.

We shall show (below) that there are  $n$  different types of vertices, and chambers have one of each. We therefore define two chambers to be  *$i$ -adjacent* if they differ in at most a vertex of type  $i$ . By  $(\dagger)$  above the residue of a vertex ( $[L_1]$  in that case) is isomorphic to the  $A_{n-1}(k)$  building, whose simplexes are the flags of an  $n$ -dimensional  $k$ -vector space ( $L_1/\pi L_1$  in that case). Therefore  $\Delta$  is a chamber system of type  $\tilde{A}_{n-1}$ , and by (4.10) it will be a building once it is shown to be simply-connected as a simplicial complex. This is done in Exercise 10, using apartments. A thorough discussion of the  $n = 2$  case (where  $\Delta$  is a tree) is given in Serre's book on *Trees* [1977/80] Chapter II section 1.



**Some Subgroups of  $GL(V)$ .** The group  $GL(V)$  (i.e.,  $GL_2(K)$ ) acts transitively on the set of all  $\mathcal{O}$ -lattices, and preserves equivalence between lattices. Its subgroup  $SL(V)$  can be defined in one of the following equivalent ways (see e.g., Artin [1957] Chapter 4).

- (i) It is the subgroup of  $GL(V)$  generated by root groups (unipotent elements).
- (ii) It is the commutator subgroup  $[GL(V), GL(V)]$ .
- (iii) It is the kernel of the *Dieudonné determinant*

$$\det : GL(V) \rightarrow K^\times / [K^\times, K^\times].$$

Since the valuation  $v$  is trivial on  $[K^\times, K^\times]$ , one has for each  $g \in GL(V)$  a well-defined integer  $v(\det(g))$ . We shall write:

$$GL(V)^\circ = \{g \in GL(V) | v(\det(g)) = 0\}$$

$$GL(V)^{\circ(n)} = \{g \in GL(V) | v(\det(g)) \equiv 0 \pmod{n}\}.$$

Obviously:

$$SL(V) \subset GL(V)^\circ \subset GL(V)^{\circ(n)} \subset GL(V).$$

Consider now the stabilizer of a vertex  $x = [L]$ . If  $g \cdot x = g$ , then  $gL = cL$  for some  $c \in K^\times$ , so  $v(\det(g)) = n \cdot v(c) \equiv 0 \pmod{n}$ . If  $g \in GL(V)^\circ$ , then  $v(c) = 0$ , so  $c$  is a unit in  $\mathcal{O}$ , and  $L = cL$ . Thus, using  $G_a$  to denote the stabilizer of  $a$ , we have:

$$\text{If } G \text{ is a subgroup of } GL(V)^\circ, \text{ then } G_x = G_L \quad (*)$$

**Types.** We define the *type* of a vertex as an integer mod  $n$ . Start with some lattice  $L$  and assign type 0 to  $[L]$ . If  $L'$  is any lattice, then  $L' = gL$  for some  $g \in GL(V)$ , and we define  $[L']$  to have *type*  $v(\det(g)) \pmod{n}$ . By the discussion above this is well-defined mod  $n$ , and  $GL(V)^{\circ(n)}$  preserves types.

Consider a chamber, represented by  $L_1 \supset \dots \supset L_n \supset \pi L_1$ ; regarding  $L_i/\pi L_1$  as a subspace of  $L_1/\pi L_1$ , we immediately find a basis  $e_1, \dots, e_n$  for  $V$  such that:

$$L_1 = \langle e_1, \dots, e_n \rangle_{\mathcal{O}}$$

$$L_2 = \langle \pi e_1, e_2, \dots, e_n \rangle_{\mathcal{O}}$$

$$\vdots$$

$$L_n = \langle \pi e_1, \dots, \pi e_{n-1}, e_n \rangle_{\mathcal{O}}$$

If  $gL_1 = L_i$  then  $v(\det(g)) = i - 1$ , so the  $n$  vertices of a chamber have  $n$  different types. As explained above this allows us to regard  $\Delta$  as a chamber system.

**Exercise.** Show that  $SL(V)$  is transitive on the set of vertices of a given type.

**Bounded Subgroups.** Given a basis for  $V$ , every element  $g \in GL(V)$  can be written as a non-singular  $n \times n$  matrix  $(g_{ij})$ . A subgroup  $G$  of  $GL(V)$  will be called *bounded* if there is an integer  $d$  such that  $v(g_{ij}) \geq d$  for all  $(g_{ij}) = g \in G$  (obviously  $d \leq 0$  because  $v(1) = 0$ ). This definition is independent of the choice of basis (though  $d$  itself is, of course, not independent of the basis). The  $\geq$  sign is due to the fact that each element  $c \in K$  has a "norm"  $|c| = e^{-v(c)}$ , so  $v(c)$  is bounded below if and only if  $|c|$  is bounded above.

(9.3) THEOREM. A subgroup  $G$  of  $GL(V)^\circ$  is bounded if and only if it stabilizes a vertex of  $\Delta$ . Furthermore the vertices of  $\Delta$  are in bijective correspondence with the maximal bounded subgroups of  $GL(V)^\circ$ .

PROOF: If  $x = [L]$  is any vertex, take an  $\mathcal{O}$ -basis for  $L$ ; using this as a basis for  $V$ , we have  $G_L \leq GL_n(\mathcal{O})$ , which is bounded (using  $d = 0$ ). Thus by (\*) above  $G_x = G_L$  is bounded. Conversely if  $G$  is a bounded subgroup of  $GL(V)^\circ$ , take any lattice  $L$  and set

$$L_0 = \sum_{g \in G} gL.$$

Since  $G$  is bounded,  $L_0$  is also a lattice, and is stabilized by  $G$ .

For the final statement of the theorem it suffices to show that if  $G = GL(V)^\circ$ , then  $G_L$  fixes no vertices apart from  $x = [L]$ . Since  $G_L \cong GL_n(\mathcal{O})$  acts as  $GL_n(k)$  on  $St(x)$  (recall  $k$  is the residue field  $\mathcal{O}/\pi\mathcal{O}$ ), it fixes nothing in  $St(x)$ , and hence by Exercise 12 fixes no other vertex.  $\square$

**Apartments.** Take a basis  $e_1, \dots, e_n$  of  $V$ , and let  $A$  be the subcomplex of  $\Delta$  whose vertices are all  $[L]$ , where  $L = \langle \pi^{r_1}e_1, \dots, \pi^{r_n}e_n \rangle_{\mathcal{O}}$  is the  $\mathcal{O}$ -lattice spanned by  $\pi^{r_1}e_1, \dots, \pi^{r_n}e_n$ . Without loss of generality we may scale  $e_1, \dots, e_n$  so that  $\langle e_1, \dots, e_n \rangle_{\mathcal{O}}$  has type 0, in which case  $L$  has type  $r \pmod n$ , where  $r = r_1 + \dots + r_n$ .

Notice that  $[L]$  is equivalent to the set of  $n$ -tuples  $(r_1 + t, \dots, r_n + t)$  for  $t \in \mathbf{Z}$ , and hence is equivalent to the single  $n$ -tuple  $(x_1, \dots, x_n)$  where  $x_i = r_i - \frac{r}{n}$ . Thus the vertices of  $A$  correspond to certain points of  $\mathbf{R}^n$

lying in the hyperplane  $x_1 + \dots + x_n = 0$ . To see that these are the vertices of the Coxeter complex of type  $\tilde{A}_{n-1}$ , it suffices to check that the following involutions  $s_1, \dots, s_n$  preserve this structure and satisfy the relations required by a Coxeter group of type  $\tilde{A}_{n-1}$ :  $s_i$  switches  $x_i$  with  $x_{i+1}$  if  $i = 1, \dots, n-1$ , and  $s_n$  replaces  $x_n$  by  $x_1 + 1$ , and  $x_1$  by  $x_n - 1$ .

**Exercise.** After a suitable rescaling and reordering of the basis  $e_1, \dots, e_n$  show that the vertices in a sector are those  $[L]$  for which  $L = \langle e_1, \pi^{r_2} e_2, \dots, \pi^{r_n} e_n \rangle_{\mathcal{O}}$  where  $0 \leq r_2 \leq \dots \leq r_n$ .

**The Affine Tits System.** After choosing a suitable basis for  $V$ , a chamber stabilizer  $B$  in  $GL(V)^{\mathcal{O}(n)}$  is the inverse image of the group of upper triangular matrices under the projection from  $\mathcal{O}$  to  $\mathcal{O}/\pi\mathcal{O} = k$ . Thus

$$B = \begin{bmatrix} \mathcal{O} & & \mathcal{O} \\ & \ddots & \\ \pi\mathcal{O} & & \mathcal{O} \end{bmatrix}$$

The stabilizer  $N$  of an apartment is almost the same as that for the spherical building  $A_{n-1}(K)$ , namely permutation matrices times diagonal matrices, except that we must ensure  $N$  is a subgroup of  $GL(V)^{\mathcal{O}(n)}$  otherwise it will not preserve types. The panel stabilizers (minimal parabolics) are:

$$P_0 = \begin{bmatrix} \mathcal{O} & & \pi^{-1}\mathcal{O} \\ & \ddots & \\ \pi\mathcal{O} & & \mathcal{O} \end{bmatrix}$$

$$P_i = \begin{bmatrix} \mathcal{O} & & & \mathcal{O} \\ & \ddots & & \\ & & \boxed{\begin{matrix} \mathcal{O} & \mathcal{O} \\ \mathcal{O} & \mathcal{O} \end{matrix}} & \\ \pi\mathcal{O} & & & \mathcal{O} \end{bmatrix}$$

where  $P_0$  differs from  $B$  only in the  $(1, n)$  entry, and for  $i = 1, \dots, n-1$ ,  $P_i$  differs only in the  $(i+1, i)$  entry, and has a  $GL_2(\mathcal{O})$  block on the diagonal as shown. Obviously  $\langle P_1, \dots, P_{n-1} \rangle = GL_n(\mathcal{O})$  stabilizes a vertex.

**Root Groups in an Affine Moufang Building.** In Chapter 6 section 4 we introduced Moufang buildings, and we can now give an example of affine type. Suppose  $K$  contains its residue field  $k$  as a subfield; e.g.,  $K = k(t)$  as in Example 2, with valuation  $v = v_0$  determined by  $v(t) = 1$ . Consider the  $\tilde{A}_2(K, v)$  building, and take “root groups” of the form

$$U_\alpha = \begin{bmatrix} 1 & at^r & 0 \\ 0 & 1 & 0 \\ 0 & 0 & 1 \end{bmatrix}$$

where  $r$  is fixed, and  $a$  ranges over the residue field  $k$ ; obviously  $U_\alpha$  is isomorphic to the additive group of  $k$ . The root groups  $U_i = U_{\alpha_i}$  for the “fundamental roots”  $\alpha_i$  (see Chapter 7 section 2) are the following, where  $a, b, c$  range over the residue field  $k$ :

$$\begin{aligned} U_1 &= \begin{bmatrix} 1 & a & 0 \\ 0 & 1 & 0 \\ 0 & 0 & 1 \end{bmatrix} & U_{-1} &= \begin{bmatrix} 1 & 0 & 0 \\ a & 1 & 0 \\ 0 & 0 & 1 \end{bmatrix} \\ U_2 &= \begin{bmatrix} 1 & 0 & 0 \\ 0 & 1 & b \\ 0 & 0 & 1 \end{bmatrix} & U_{-2} &= \begin{bmatrix} 1 & 0 & 0 \\ 0 & 1 & 0 \\ 0 & b & 1 \end{bmatrix} \\ U_3 &= \begin{bmatrix} 1 & 0 & 0 \\ 0 & 1 & 0 \\ ct & 0 & 1 \end{bmatrix} & U_{-3} &= \begin{bmatrix} 1 & 0 & ct^{-1} \\ 0 & 1 & 0 \\ 0 & 0 & 1 \end{bmatrix} \end{aligned}$$

We may let  $B$  be the same as before, but must restrict  $N$  to permutation matrices times diagonal matrices of the form

$$\begin{pmatrix} at^{r_1} & 0 & 0 \\ 0 & bt^{r_2} & 0 \\ 0 & 0 & ct^{r_3} \end{pmatrix}$$

where  $a, b, c \in k^\times$ , and of course  $r_1 + r_2 + r_3 \equiv 0 \pmod{3}$  in order that  $N$  be type preserving. It is left to the reader to check that the  $U_\alpha$  and  $N$  satisfy (M1) - (M4) of Chapter 6 section 4. Before leaving this example, notice that the  $U_\alpha$  are not unique. We could equally well have chosen some other rational function  $f$ , with  $v(f) = 1$ , in place of  $t$ .

**Exercise.** Given  $e_i \in U_i - \{1\}$ , and  $n_i = m(e_i) \in U_{-i}e_iU_{-i} \cap N$ , in this example, show that  $n_1n_2n_1 = n_2n_1n_2$ ,  $n_1n_3n_1 = n_3n_1n_3$ , and  $n_2n_3n_2 = n_3n_2n_3$  (cf. (7.3) and Appendix 1 (A.5)).

**Completion.** Let  $\widehat{K}$  be the completion of  $K$  with respect to  $v$ ; it is the quotient field of its valuation ring  $\widehat{\mathcal{O}} = \varprojlim \mathcal{O}/\pi^n \mathcal{O}$ . (Completing  $K$  to  $\widehat{K}$  is the same as adjoining all limits of Cauchy sequences, where the distance between two elements  $x$  and  $y$  is  $|x-y| = e^{-v(x-y)}$  - in particular  $|x-y| \rightarrow 0$  when  $v(x-y) \rightarrow \infty$ ). For example if  $K = \mathbf{Q}$  with the  $p$ -adic valuation, as in Example 1 above, then  $\widehat{K} \cong \mathbf{Q}_p$  with valuation ring  $\mathbf{Z}_p$  (the  $p$ -adic integers); if  $K$  is a function field of degree 1, for example  $k(t)$  as in Example 2, then  $\widehat{K} \cong k((t))$  with valuation ring  $k[[t]]$  (the ring of formal power series).

We set  $\widehat{V} = V \otimes_K \widehat{K}$ , and associate to each lattice  $L$  of  $V$  the lattice  $\widehat{L} = L \otimes_{\mathcal{O}} \widehat{\mathcal{O}}$  of  $\widehat{V}$ . This gives a bijection of the set of  $\mathcal{O}$ -lattices of  $V$  onto the set of  $\widehat{\mathcal{O}}$ -lattices of  $\widehat{V}$ , showing that the affine building  $\Delta$  of  $V$  is isomorphic to that of  $\widehat{V}$ . This fact can also be seen geometrically because the building obtained from  $V$  obviously embeds in that obtained from  $\widehat{V}$ , yet their residues are isomorphic (because the residue field is the same in both cases), so the embedding is an equality.

There is however an important difference which will be made precise in the next chapter when we deal with apartment systems. Each basis of  $\widehat{V}$  gives an apartment of  $\Delta$ , as explained earlier, and in fact all apartments of  $\Delta$  (i.e., isometric images of the  $\widetilde{A}_{n-1}$  Coxeter complex) arise in this way - see Exercise 2 of Chapter 10. The bases of  $V$  do not give all possible apartments, only those in a particular "apartment system"  $\mathcal{A}$ . Using all apartments of  $\Delta$  we shall, in the next section, obtain a "building at infinity"  $\Delta^\infty$ , isomorphic to the spherical building  $A_{n-1}(\widehat{K})$ . Using only those apartments in  $\mathcal{A}$ , one obtains a smaller "building at infinity"  $(\Delta, \mathcal{A})^\infty$ , isomorphic to the spherical building  $A_{n-1}(K)$ .

### 3. The Spherical Building at Infinity.

A sector has been defined in an affine Coxeter complex or apartment; we now define a *sector* of an affine building to mean a sector in some apartment of the building. Of course if  $S$  is a sector in some apartment then it is a sector in any apartment containing it, since the two apartments are isometric via an isometry fixing their intersection (Exercise 6 of Chapter 3).

(9.4) LEMMA. *Given any chamber  $c$ , and any sector  $S$ , there exists a sector  $S_1 \subset S$  such that  $S_1$  and  $c$  lie in a common apartment.*

PROOF: Let  $A$  be an apartment containing  $S$ , and assume  $c \notin A$ . By induction along a gallery from  $c$  to  $A$  it suffices to prove the lemma when

$c$  has a panel  $\pi$  in  $A$ . Of the two roots of  $A$  whose boundary contains  $\pi$ , let  $\alpha$  be the one containing a sector  $S_1 \subset S$  (see Figure 9.2).

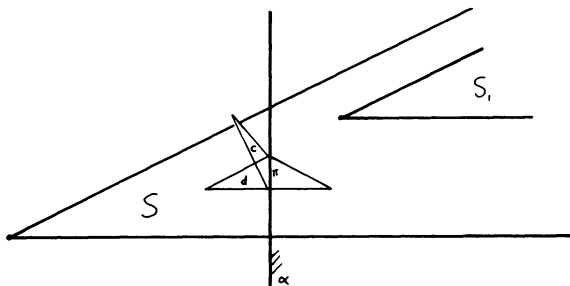

Figure 9.2

If  $d$  is the chamber of  $A - \alpha$  on  $\pi$ , then clearly  $\{c\} \cup \alpha$  is isometric to  $\{d\} \cup \alpha$ , and hence by (3.6)  $c$  and  $\alpha$  lie in a common apartment.  $\square$

**The retraction  $\rho_{S,A}$ .** Now let  $c$ ,  $S$  and  $S_1$  be as in the preceding lemma, and let  $A$  be any apartment containing  $S$ . The fact that  $\{c\} \cup S_1$  is isometric to a subset of  $W$ , shows that for any chambers  $x, y \in S_1$ , one has  $\rho_{x,A}(c) = \rho_{y,A}(c)$ . We let  $\rho_{S,A}(c)$  denote this common chamber of  $A$ ; it is independent of  $S_1$  because any two subsectors of  $S$  intersect non-trivially. (If we treat  $\Delta$  as a simplicial complex then  $\rho_{S,A}$  is a retraction of  $\Delta$  onto  $A$ ).

(9.5) PROPOSITION. Any two sectors  $S$  and  $T$  contain subsectors  $S_1$  and  $T_1$  lying in a common apartment.

PROOF: The proof is deferred to section 4.  $\square$

We now define a *sector-face* to mean a face of a sector treated as a simplicial cone; thus sector-faces are themselves simplicial cones, and those of codimension 1 are the sector-panels. Two sector-faces, or walls, are said to be *parallel* if the distance between them is bounded (i.e., if the distance from any point of one to the nearest point of the other is bounded).

Obviously parallelism is an equivalence relation, and in a given apartment two walls, or sector-faces, are parallel if one is a translate of the other. As a matter of notation we let  $X^\infty$  denote the parallel class of  $X$ , and sometimes call it the *direction* of  $X$ , or the *trace of  $X$  at infinity*.

Using (9.2) and (9.5) it is straightforward to see that two sectors are parallel if and only if their intersection contains a sector (Exercise 3). In

Figure 9.3 the sectors  $S$  and  $T$  are parallel and intersect in the cross-shaded area; the sector-panels  $p_1$  and  $q_1$  of  $S$  and  $T$  are parallel, as are  $p_2$  and  $q_2$ . In this example  $p_2$  and  $q_2$  contain a sector-panel in common, but  $p_1$  and  $q_1$  do not; this distinction will be important in Chapter 10 when we define two sector-panels to be asymptotic if their intersection contains a sector-panel (a refinement of parallelism).

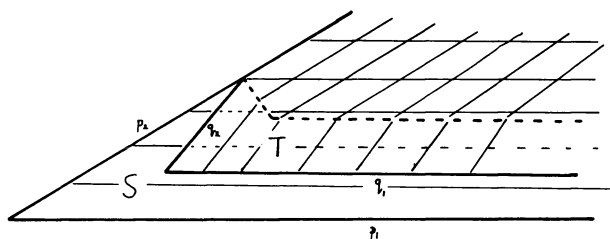

Figure 9.3

We now define the building at infinity,  $\Delta^\infty$ , as a chamber system over  $I_o$  where  $I_o = I - \{o\}$ ,  $o$  being some fixed type of special vertices. The chambers of  $\Delta^\infty$  are defined to be parallel classes of sectors of  $\Delta$ , and two chambers  $c$  and  $d$  are *adjacent* if there are representative sectors  $S$  and  $T$  (i.e.,  $c = S^\infty$ ,  $d = T^\infty$ ) having sector-panels  $D$  and  $E$  which are parallel; this is independent of the choice of  $S$  and  $T$ , because if  $c = (S')^\infty$  then  $S'$  has a sector-panel parallel to  $D$ , and hence to  $E$ . Evidently the panels of  $\Delta^\infty$  are parallel classes of sector-panels, and we determine the type  $i \in I_o$  of a panel as follows. In each parallel class take a sector-panel having a vertex of type  $o$ ; its base panel, the one on the vertex, must have some type  $i \in I_o$ : we take this to be the *type* of the parallel class. To check that this is well-defined it suffices, by (9.5), to check it in a single apartment, so consider two parallel sector-panels in a common apartment. They are translates of one another, and if they both have vertices of the same type ( $o$  in our case), then the translation may be done by an element of  $W$ , and hence their base panels have the same type.

To show  $\Delta^\infty$  is a building we use apartments as in (3.11). Given an apartment  $A$  of  $\Delta$ , let  $A^\infty = \{S^\infty | S \text{ a sector in } A\}$ . Then  $A^\infty$  is a Coxeter complex of type  $W_o$  because if  $s$  is a vertex of  $A$  of type  $o$ , every

parallel class of sectors in  $A$  contains a unique sector having vertex  $s$ , and so  $A^\infty$  is isomorphic to  $St(s)$ . By (9.5) any two chambers of  $\Delta^\infty$  lie in a common  $A^\infty$ . Moreover let  $x$  be a chamber and  $y$  a chamber or panel of  $\Delta^\infty$  contained in  $A_1^\infty$  and  $A_2^\infty$ ; then again by (9.5)  $x = X^\infty$  and  $y = Y^\infty$  where  $X$  and  $Y$  lie in  $A_1 \cap A_2$ . Now by Exercise 6 of Chapter 3 there is an isomorphism from  $A_1$  to  $A_2$  fixing  $A_1 \cap A_2$ , and hence an isomorphism from  $A_1^\infty$  to  $A_2^\infty$  fixing  $x$  and  $y$ . Thus by (3.11)  $\Delta^\infty$  is a building.

(9.6) THEOREM. *With the above notation  $\Delta^\infty$  is a building of spherical type  $M_o$ . Moreover the apartments of  $\Delta^\infty$  are in bijective correspondence with the apartments of  $\Delta$ , via  $A \rightarrow A^\infty$ . The faces of  $\Delta^\infty$ , considered as a simplicial complex, are the parallel classes of faces of  $\Delta$ , and the walls of  $\Delta^\infty$  are parallel classes of walls of  $\Delta$ .*

PROOF: The first statement has already been proved. To prove the second, let  $X$  be an apartment of the spherical building  $\Delta^\infty$ , and let  $c$  and  $d$  be opposite chambers of  $X$ . Then by (9.5) we can find sectors  $S$  and  $T$  in the directions  $c$  and  $d$ , and lying in a common apartment  $A$ . Thus  $c$  and  $d$  lie in  $A^\infty$ , but being opposite they lie in a unique apartment (see (2.15)(iv) or Exercise 5 of Chapter 3), so  $A^\infty = X$ . Moreover if  $(A')^\infty = X$  then after possibly replacing  $S$  and  $T$  by subsectors we may assume they lie in  $A'$  also. Since  $A \cap A'$  is convex (see (3.8)), either  $A = A'$  or  $A \cap A'$  is an intersection of half-apartments, by (2.8); but  $S$  and  $T$  do not lie in a common half-apartment, so  $A = A'$ . The third statement is left as an exercise.  $\square$

Having defined  $\Delta^\infty$  by using parallel classes of sectors, and their faces, we shall now show that it could equally well be obtained by choosing a special vertex  $s$  and using those sectors, and their faces, having vertex  $s$ .

(9.7) LEMMA. *If  $s$  is a special vertex, then each parallel class of sectors contains a unique sector having vertex  $s$ .*

PROOF: If  $S$  is any sector in the given class, then by (9.4) it contains a subsector  $S_1$  lying in a common apartment  $A$  with  $s$ . The translate of  $S_1$  in  $A$  having vertex  $s$  is then parallel to  $S$  by (9.2). It remains to show that if two parallel sectors  $S$  and  $T$  have the same vertex  $s$ , then they are equal. This follows from (9.1) because  $S$  and  $T$  are both equal to the convex hull of  $s$  and some sector  $R$  contained in  $S \cap T$ .  $\square$

Let us now suppose that our special vertex  $s$  has type  $o$  and, as before, define a sector-panel with vertex  $s$  to have *type  $i$*  if its base panel (the one



on  $s$ ) has type  $i$ . Two sectors having vertex  $s$  will be called  *$i$ -adjacent* if they share such a sector-panel.

(9.8) THEOREM. *The sectors having vertex  $s$ , together with the adjacencies just defined, form a chamber system isomorphic to  $\Delta^\infty$ .*

PROOF: Obviously if two sectors  $S$  and  $T$  having vertex  $s$  are  $i$ -adjacent then  $S^\infty$  and  $T^\infty$  are  $i$ -adjacent in  $\Delta^\infty$ . Therefore in view of (9.7) it suffices to prove that for sectors  $S$  and  $T$  having vertex  $s$ , if  $S^\infty$  and  $T^\infty$  are  $i$ -adjacent in  $\Delta^\infty$ , then  $S$  is  $i$ -adjacent to  $T$ .

Let  $A_1$  be any apartment containing a subsector  $S_1 \subset S$ ; if  $\alpha$  is a half-apartment of  $A_1$ , minimal with respect to containing  $S_1$ , then  $\alpha$  and  $s$  lie in a common apartment. Now by (9.5) choose  $A_1$  to contain subsectors  $S_1 \subset S$  and  $T_1 \subset T$ , and then take  $\alpha$  to be a root containing them both (this is possible since  $S_1^\infty$  and  $T_1^\infty$  are adjacent in  $\Delta^\infty$ ). Hence there is an apartment  $A$  containing  $S_1, T_1$  and  $s$ . By (9.1)  $S$  is the convex hull of  $s$  and  $S_1$ , and  $T$  is the convex hull of  $s$  and  $T_1$ , so  $S$  and  $T$  are sectors in  $A$  having a common vertex. Since  $S^\infty$  and  $T^\infty$  are adjacent in  $\Delta^\infty$  they have sector-panels which are parallel, but these sector-panels lie in  $A$  and have the same vertex; hence they are equal, and  $S$  is adjacent to  $T$ .  $\square$

#### 4. The Proof of (9.5).

To prove (9.5) we use "sector directions" which we now define. Let  $c$  be a chamber in an apartment  $A$ , which we treat as Euclidean space. If  $S$  is any sector of  $A$ , and  $s$  its vertex, take an  $\epsilon$ -neighborhood of  $s$  in  $S$ , translate it to the barycentre of  $c$ , and call it  $S(c)$ . Here  $\epsilon$  should be small enough so that a ball of radius  $\epsilon$  lies entirely inside  $c$ . We call  $S(c)$  the *sector direction* of  $S$  at  $c$ . It is independent of  $A$ , because if  $A'$  is any other apartment containing  $c$  and  $S$ , then  $\rho_{c,A}$  maps  $A'$  to  $A$ , preserving the Euclidean space structure and fixing  $c$  and  $S$ . Notice that the set of sector directions at  $c$  is in bijective correspondence with the set of chambers on a special vertex, and hence corresponds to the elements of the finite Coxeter group  $W_o$ . If  $M$  is a wall dividing the apartment  $A$  into two roots  $\pm\alpha$ , then a sector direction will be said to be *on the  $+\alpha$  (or  $-\alpha$ ) side* of  $M$  if, after translating its vertex to a point of  $M$ , it lies in  $+\alpha$  (or  $-\alpha$ ).

Before proving (9.5) we obtain a subsidiary result.

(9.9) LEMMA. *If  $S$  is a sector in an apartment  $A$ , and if  $T$  is any sector, then  $T$  contains a subsector  $T_1$  such that  $\rho_{S,A}|_{T_1}$  is an isometry.*

PROOF: Write  $\rho = \rho_{S,A}$ . Since  $\rho$  preserves adjacency of chambers it is

a question of finding a subsector  $T_1$  such that for any two distinct and adjacent chambers  $x, y \in T_1$ ,  $\rho(x) \neq \rho(y)$ . Indeed since  $T_1$  is convex, any two chambers  $z, z' \in T_1$  are joined by a gallery in  $T_1$  of reduced type  $f$ , and  $\rho$  sends this to another gallery of type  $f$ , hence  $\delta(\rho(z), \rho(z')) = \delta(z, z')$ . Now let  $\pi$  be the panel common to  $x$  and  $y$ , and take  $x$  to be nearer the base chamber of  $T$ . We set  $x' = \rho(x)$ ,  $y' = \rho(y)$ ,  $\pi' = \rho(\pi)$ , and let  $\alpha$  be the root of  $A$  containing  $x'$  but not  $y'$  - see Figure 9.4.

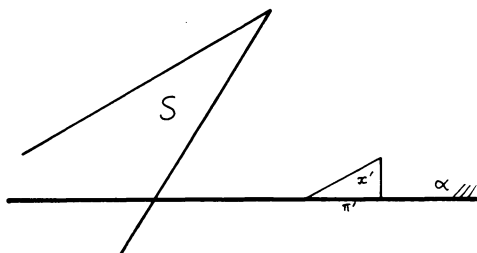

Figure 9.4

For any chamber  $z \in T$ , consider the two sector directions

$$S(\rho(z)) \text{ and } \rho(T(z)).$$

Without loss of generality let  $S(\rho(z))$  correspond to  $1 \in W_o$ , and let  $w(z) \in W_o$  denote  $\rho(T(z))$ .

**Step 1.** If  $x' \neq y'$  then  $w(x) = w(y)$ .

Indeed if  $x' \neq y'$  then  $\rho$  restricted to  $\{x, y\}$  is an isomorphism.

**Step 2.** If  $x' = y'$  then  $w(y) = rw(x)$  where  $r$  is the reflection of  $W_o$  determined by the wall  $M$  of  $A$ .

This follows from Step 1 since  $\rho|_{\{x, y\}}$  may be taken as an isomorphism followed by a folding across  $M$ .

**Step 3.** If  $x' = y'$  then  $S$  contains no subsector in  $\alpha$ .

Suppose  $S$  contains a subsector in  $\alpha$ . By (9.2) any two subsectors of  $S$  intersect non-trivially, so there is a chamber  $c \in \alpha \cap S$  such that  $\rho_{c,A}$

agrees with  $\rho$  on  $\{x, y\}$ . Since  $c \in \alpha$ , we have  $x' = y' = \text{proj}_{\pi'} c$ ; however  $\rho(c) = c$ , and for  $z \in \text{St}(\pi)$  if  $\rho(z) = \text{proj}_{\pi'} c$ , then  $z = \text{proj}_{\pi} c$ . Therefore  $x = \text{proj}_{\pi} c = y$ , a contradiction.

**Step 4.** If  $x' = y'$ , then  $\ell(w(y)) > \ell(w(x))$ .

Since  $x$  is nearer the vertex of  $T$  than  $y$  is, the sector direction  $T(x)$  points towards  $\pi$  rather than away from it. Thus  $\rho(T(x))$  is on the  $-\alpha$  side of  $M$ , and by Step 3 this is true of  $S(\rho(x))$  also (see Figure 9.4). In other words the elements  $w(x)$  and 1 of  $W_o$  lie on one side of a wall, and by Step 2  $w(y) = rw(x)$  lies on the opposite side of the wall, hence  $\ell(w(y)) > \ell(w(x))$ .

We now define  $T_1$  to be any subsector of  $T$  with base chamber  $x_o$  such that  $w(x_o)$  has maximal length in  $W_o$ . Using Step 4 we see that if  $x$  and  $y$  are adjacent and distinct chambers of  $T_1$ , then  $\rho(x) \neq \rho(y)$ , completing the proof.  $\square$

**Proof of (9.5).** We have two sectors  $S$  and  $T$ , and wish to find subsectors  $S_1 \subset S$  and  $T_1 \subset T$  lying in a common apartment.

Let  $A$  be an apartment containing  $S$ , set  $\rho = \rho_{S,A}$  and let  $T_1 \subset T$  be a subsector as in (9.9), having base chamber  $x_o$ , and such that  $\rho|_{T_1}$  is an isometry. If  $S'$  denotes the translate of  $S$  in  $A$  having the same vertex as  $\rho(T_1)$ , then we let  $S_1 \subset S \cap S'$  be a subsector lying in a common apartment with  $x_o$ . It suffices to show that for all chambers  $c \in S_1$ ,  $\rho_{c,A}|_{T_1} = \rho|_{T_1}$ .

Given  $c \in S_1$  and  $y \in T_1$  we work by induction along a minimal gallery from  $x_o$  to  $y$ . Since  $S_1$  and  $x_o$  lie in a common apartment, the induction can start. Now as in the proof of (9.9) let  $x, y \in T_1$  be distinct chambers on a common panel  $\pi$ , and with  $x$  closer to  $x_o$ ; again write  $x' = \rho(x)$ ,  $y' = \rho(y)$ ,  $\pi' = \rho(\pi)$ , and let  $\alpha$  be the root of  $A$  containing  $x'$  but not  $y'$ . By induction  $\rho_{c,A}(x) = x'$ , and we must show  $\rho_{c,A}(y) = y'$ .

If  $c \in \alpha$ , then  $x' = \text{proj}_{\pi'} c$ , and so  $x = \text{proj}_{\pi} c$  is the unique chamber of  $\text{St}(\pi)$  mapped onto  $x'$  by  $\rho_{c,A}$ ; therefore  $\rho_{c,A}(y) \neq x'$ , and hence  $\rho_{c,A}(y) = y'$  as required.

If  $c \in -\alpha$ , then  $y' = \text{proj}_{\pi'} c$ , and it suffices to show that  $y = \text{proj}_{\pi} c$ . We first claim that  $\rho|_{\text{St}(\pi)} = \rho_{e,A}|_{\text{St}(\pi)}$  for some chamber  $e \in -\alpha$ . Indeed  $S_1$  contains a subsector lying entirely in  $-\alpha$  (because it lies in a sector having vertex  $\rho(T_1) \in \alpha$ , and has a chamber  $c \in -\alpha$ ), hence contains a chamber  $e$  as required. Thus  $\rho_{e,A}(\text{proj}_{\pi} c) = \rho(\text{proj}_{\pi} c) = \text{proj}_{\pi'} c = y' = \rho_{e,A}(y)$ . Since  $y' = \text{proj}_{\pi'} e$  its inverse image under  $\rho_{e,A}$  is  $\text{proj}_{\pi} e$ , so we have  $\text{proj}_{\pi} c = \text{proj}_{\pi} e = y$ , as required.  $\square$

**Notes.** Tits systems  $(B, N)$  of affine type were introduced by Iwahori and Matsumoto [1965], and in the literature the terms “Iwahori subgroup” for  $B$ , and “parahoric subgroups” for the  $P_J$ , are often used. The general theory of affine buildings, and the construction of the building at infinity, is developed by Bruhat and Tits [1972]; their work includes a description of the building as a metric space - see also Brown [1979] Ch. VI, and “non-discrete buildings” obtained from non-discrete valuations - see Appendix 3. The proof of (9.5) is taken from [loc. cit.] 2.9.5 (pages 58-60).

### Exercises to Chapter 9

1. In a given affine Coxeter complex, let  $\alpha_1, \dots, \alpha_t$  be roots whose walls are linearly independent, and for each  $i = 1, \dots, t$  let  $\beta_i$  be a translate of  $\alpha_i$ . Prove that there is a translation  $g$  (not necessarily in  $W$ ) such that  $\beta_i = g(\alpha_i)$  for all  $i = 1, \dots, t$ .
2. If  $S'$  is a translate of a sector  $S$  in an affine Coxeter complex, show that  $S \cap S'$  is a sector. [HINT: Use Exercise 1].
3. Show that two sectors are parallel if and only if their intersection contains a sector.
4. Given a chamber  $c$ , and a half-apartment (root)  $\alpha$ , is there necessarily a half-apartment  $\beta \subset \alpha$  such that  $c$  and  $\beta$  lie in a common apartment? (cf. 9.4).
5. Describe the triangulations of  $\mathbf{R}^3$  determined by the Coxeter complexes of types  $\tilde{C}_3$ ,  $\tilde{B}_3$  and  $\tilde{A}_3$ .
6. Show that the map, in the early part of section 1, from the Coxeter complex  $W$  onto  $\mathbf{R}^n$  is a local homeomorphism. [Hint: For each simplex  $\sigma$  consider this map restricted to  $St(\sigma)$ , and work by induction on the codimension of  $\sigma$ ].
7. Show that if a sector-face contains two sector-faces of the same dimension, then their intersection is also a sector-face of that dimension. (cf. 9.2 for sectors).
8. Show that in an affine Coxeter complex a convex set of chambers is closed and convex in the Euclidean sense. [HINT: A convex set of chambers is either the whole Coxeter complex, or is an intersection of roots, by (2.8)].

9. Show that the intersection of two apartments is closed and convex in both. [HINT: If  $p$  and  $q$  are points of  $A$  and  $A'$ , let  $x \in A$  and  $y \in A'$  be chambers containing  $p$  and  $q$  respectively, and let  $A''$  be an apartment containing  $x$  and  $y$ : cf. Exercise 6 in Chapter 3].

Exercises 10-12 deal with the  $\tilde{A}_{n-1}$  example of section 2.

10. If  $L$  and  $L'$  are  $\mathcal{O}$ -lattices show there is a basis  $e_1, \dots, e_n$  for  $L$  such that  $L'$  is spanned by  $\pi^{r_1}e_1, \dots, \pi^{r_n}e_n$ . Conclude that any two vertices lie in an apartment determined by a basis of  $V$ .
11. Define a circuit of vertices and edges to be *minimal* if it contains a path of shortest length joining any two of its vertices. Show that a minimal circuit lies in an apartment determined by a basis of  $V$ . Use this to show  $\Delta$  is simply-connected in the topological sense.
12. Show that if a group of automorphisms fixes two vertices  $x$  and  $y$ , then it fixes something in  $St(x)$ . [HINT: Consider an apartment containing  $x$  and  $y$ ].

## Chapter 10

### AFFINE BUILDINGS II

This chapter deals with the relationship between an affine building  $\Delta$  having a system of apartments  $\mathcal{A}$ , and its spherical building at infinity denoted  $(\Delta, \mathcal{A})^\infty$ . When this building at infinity is Moufang (e.g. whenever  $\Delta$  has rank at least 4), one obtains root groups with a valuation (section 3), which are then used in section 4 to recover  $(\Delta, \mathcal{A})$ , and assist in the classification (section 5). An application to finite group theory is given in section 6.

As a matter of notation the term *root* will be reserved for spherical buildings such as  $(\Delta, \mathcal{A})^\infty$ , and we use Latin letters  $a, b, c, \dots$  for such roots. A root of an affine building will be called a *half-apartment* or *affine root*, and we use Greek letters  $\alpha, \beta, \gamma, \dots$  for these.

#### 1. Apartment Systems, Trees and Projective Valuations.

Given an affine building  $\Delta$ , an *apartment system* for  $\Delta$  (or more precisely a *discrete* apartment system - cf. Appendix 3) will mean that a set  $\mathcal{A}$  of apartments of  $\Delta$  is given, satisfying (i) and (ii) below. This data will be referred to as  $(\Delta, \mathcal{A})$ , and a *sector-face*, or a *wall*, of  $(\Delta, \mathcal{A})$  will mean a sector-face, or a wall, in some apartment of  $\mathcal{A}$ . The conditions are:

- (i) every chamber lies in some apartment of  $\mathcal{A}$ .
- (ii) any two sectors of  $(\Delta, \mathcal{A})$  contain subsectors lying in a common apartment of  $\mathcal{A}$ .

For example if  $\mathcal{A}$  is the set of all apartments of  $\Delta$ , then by (3.6) and (9.5) both (i) and (ii) hold, and in this case  $\mathcal{A}$  is called *complete*.

**The Building at Infinity.** For any apartment system  $\mathcal{A}$ , the parallel classes of sector-faces are the simplexes of a *building at infinity*, which we denote  $(\Delta, \mathcal{A})^\infty$ . To see this notice that  $(\Delta, \mathcal{A})^\infty$  is a subcomplex of the

$\Delta^\infty$  of Chapter 9, and by condition (ii) any two chambers of  $(\Delta, \mathcal{A})^\infty$  lie in a common apartment  $A^\infty$  where  $A \in \mathcal{A}$ . Therefore by (3.11), or Exercise 10 of Chapter 3,  $(\Delta, \mathcal{A})^\infty$  is a sub-building of  $\Delta^\infty$ , and its apartments are the  $A^\infty$  for  $A \in \mathcal{A}$ . If  $X$  is a sector-face or wall of  $(\Delta, \mathcal{A})$ , then as before we let  $x = X^\infty$  be the simplex or wall it determines "at infinity" in  $(\Delta, \mathcal{A})^\infty$ , and we say  $X$  has *direction*  $x$ .

**Example 1.** As in Chapter 9 section 2, let  $K$  be a field with a discrete valuation  $v$ , and  $\hat{K}$  its completion with respect to  $v$ . Let  $V$  be an  $n$ -dimensional vector space over  $K$ , let  $\hat{V} = V \otimes_K \hat{K}$ , and let  $\mathcal{O}$  and  $\hat{\mathcal{O}}$  be the valuation rings of  $K$  and  $\hat{K}$ . The building  $\tilde{A}_{n-1}(K, v)$  (or  $\tilde{A}_{n-1}(\hat{K}, v)$ ) has as its vertices the equivalence classes  $[L]$  of  $\mathcal{O}$ -lattices (or  $\hat{\mathcal{O}}$ -lattices) in  $V$  (or  $\hat{V}$ ), under the equivalence relation  $[L] = [L'] \Leftrightarrow L = aL'$  for some  $a \in K$  (or  $\hat{K}$ ); these buildings are isomorphic as chamber systems. Let  $\Delta$  denote this common building; it acquires a system of apartments  $\mathcal{A}(K)$  or  $\mathcal{A}(\hat{K})$  (as in Chapter 9 section 2), by taking decompositions of  $V$  or  $\hat{V}$  respectively into 1-spaces  $\langle e_1 \rangle \oplus \dots \oplus \langle e_n \rangle$ . In fact  $\mathcal{A}(\hat{K})$  is the complete system of apartments - see Exercises 1 and 2. Thus the building at infinity  $\Delta^\infty$  of Chapter 9, obtained by using all possible apartments, is the  $A_{n-1}(\hat{K})$  building, whereas  $(\Delta, \mathcal{A}(K))^\infty$  is the  $A_{n-1}(K)$  building.

**Trees with sap - the rank 2 case.** An affine building of rank 2 is a tree with no end points (Exercise 12 of Chapter 3), and if an apartment system is specified, we shall call it a *tree with sap*. Its *ends* are the parallel classes of sectors; there are no sector-panels, and  $(\Delta, \mathcal{A})^\infty$  is just the set of ends - a rank 1 building of spherical type.

**Example 2.**  $SL_2(K)$ . Let  $n = 2$  in Example 1; the building  $\tilde{A}_1(K, v)$  is a tree with sap, whose ends are the 1-spaces  $\langle v \rangle \subset V$ . Sectors (i.e. half-apartments) having  $\langle v \rangle$  as an end are given by sequences of lattices:

$$L_n = \pi^n L_o + (L_o \cap \langle v \rangle)$$

where  $\pi$  is a uniformizer (i.e.,  $\pi$  generates the maximal ideal of  $\mathcal{O}$ ).  $\square$

By definition two distinct ends  $a$  and  $b$  of a tree with sap lie in a common apartment of  $\mathcal{A}$ , which is obviously unique; we denote it  $[a, b]$ . Moreover three distinct ends  $a, b, c$  determine a unique *junction*  $\kappa(a, b, c)$  (French: *carrefour*), the vertex common to  $[a, b]$ ,  $[b, c]$  and  $[c, a]$ .

We assume our trees with sap are endowed with a metric, in other words a distance between any two vertices  $x$  and  $y$ , equal to the sum of

the distances between adjacent vertices on the path from  $x$  to  $y$ . The trees in section 2, which are obtained from affine buildings of higher rank, will come equipped with a metric induced from a metric on Euclidean space, and for this case the distance between any pair of adjacent vertices is a constant.

Now given four distinct ends  $a, b, c, d$  we let  $\omega(a, b; c, d)$  denote the distance from  $\kappa(a, b, c)$  to  $\kappa(a, b, d)$ , in the direction from  $a$  to  $b$  (i.e., with a  $+$  or  $-$  sign according to whether  $\kappa(a, b, c)$  precedes or follows  $\kappa(a, b, d)$  in the line from  $a$  to  $b$ ) - see Figure 10.1.

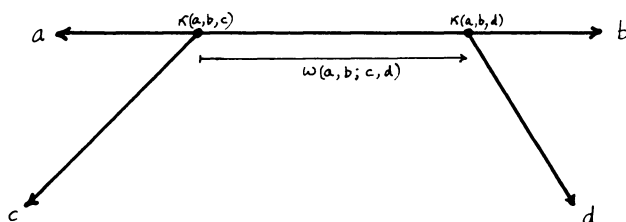

Figure 10.1

(10.1) LEMMA. The function  $\omega$  satisfies:

- ( $\omega 1$ )  $\omega(a, b; c, d) = \omega(c, d; b, a) = -\omega(a, b; d, c)$ ,
- ( $\omega 2$ ) if  $\omega(a, b; c, d) = k > 0$ , then  $\omega(a, d; c, b) = k$  and  $\omega(a, c; b, d) = 0$ ,
- ( $\omega 3$ )  $\omega(a, b; c, d) + \omega(a, b; d, e) = \omega(a, b; c, e)$ .

PROOF: Exercise. □

Any function  $\omega$  taking values in  $\mathbf{R}$  and satisfying ( $\omega 1$ ), ( $\omega 2$ ) and ( $\omega 3$ ) is called a *projective valuation*. If it takes values in a discrete subset of  $\mathbf{R}$  we call it *discrete*.

(10.2) THEOREM. Let  $(T, \mathcal{A})$  be a tree with sap in which each vertex lies on at least three edges, and let  $\omega$  be the projective valuation on  $(T, \mathcal{A})^\infty$ . Then  $\omega$  determines  $(T, \mathcal{A})$  up to unique isomorphism.

PROOF: Exercise. □

Notice that if we did not require each vertex to have valency at least three, we could subdivide  $T$ , for instance by inserting a vertex in the middle of each edge, to obtain the same  $(T, \mathcal{A})^\infty$  and  $\omega$ . However, using a more general notion of “tree” as a union of copies of  $\mathbf{R}$ , vertices no longer exist as such, and (10.2) can be greatly strengthened (see (A.16) in Appendix



3) to say that if  $\omega$  is a projective valuation on a set having more than two elements, then it arises from such a “tree” which is determined up to unique isomorphism.

**Example 3.** Let  $K$  be a field, and  $\omega$  a projective valuation on the set  $K \cup \{\infty\}$ , invariant under the affine group  $\{x \mapsto ax + b \mid a \in K^\times, b \in K\}$ . Define  $v : K \rightarrow \mathbf{R} \cup \{\infty\}$  by:

$$v(x) = \omega(\infty, 0; 1, x) \text{ for } x \neq 0, 1$$

$$v(0) = \infty$$

$$v(1) = 0$$

We will show that  $v$  is a (rank 1) valuation in the usual sense, namely that

$$v(ab) = v(a) + v(b)$$

and

$$v(a + b) \geq \min(v(a), v(b)).$$

We first observe that invariance under the affine group implies:

$$\omega(\infty, b; c, d) = \omega(\infty, 0; (c - b), (d - b)) = v((c - b)^{-1}(d - b)).$$

Thus

$$\begin{aligned} v(ab) &= \omega(\infty, 0; 1, ab) \\ &= \omega(\infty, 0; a^{-1}, b) \\ &= \omega(\infty, 0; a^{-1}, 1) + \omega(\infty, 0; 1, b) \\ &= v(a) + v(b) \end{aligned}$$

Now suppose, by way of contradiction, that  $v(a + b) < v(a), v(b)$ . Since

$$\begin{aligned} v(a + b) &= \omega(\infty, 0; 1, a + b) \\ &= \omega(\infty, 0; 1, a) + \omega(\infty, 0; a, a + b) \\ &= v(a) + \omega(\infty, -a; 0, b), \end{aligned}$$

we have  $\omega(\infty, -a; 0, b) < 0$ , hence  $\omega(\infty, -a; b, 0) > 0$ . By  $(\omega 3)$  this implies  $\omega(\infty, 0; b, -a) > 0$ , and hence  $v(-b^{-1}a) > 0$ . Similarly, interchanging  $a$  and  $b$ , we have  $v(-a^{-1}b) > 0$ . Thus  $v(1) > 0$ , a contradiction; hence  $v(a + b) \geq \min(v(a), v(b))$  as required.

Finally we remark that by using  $(\omega 2)$  it is straightforward to show that:

$$\omega(a, b; c, d) = v((d-1)^{-1}(c-a)(c-b)^{-1}(d-b)),$$

and it follows from this that the invariance of  $\omega$  under the affine group implies its invariance under the projective group - see Exercise 3.

## 2. Trees associated to Walls and Panels at Infinity.

Given a wall  $m$  of the building at infinity  $(\Delta, \mathcal{A})^\infty$ , we shall define a tree with sap  $T(m)$  whose ends are the roots of  $(\Delta, \mathcal{A})^\infty$  containing  $m$ ; this set of roots will be denoted  $St(m)$ . Similarly, given a panel  $\pi$  of  $(\Delta, \mathcal{A})^\infty$  we shall define  $T(\pi)$ , a tree with sap, whose ends are the chambers containing  $\pi$ , this set of chambers being denoted as usual by  $St(\pi)$ . If  $\pi$  is contained in  $m$ , there is a canonical isomorphism from  $T(\pi)$  to  $T(m)$ . This induces a bijection from  $St(\pi)$  to  $St(m)$  which associates to each chamber  $x$  of  $St(\pi)$  the unique root having wall  $m$  and containing  $x$  - see (6.3).

**The tree  $T(m)$  with sap.** For a given wall  $m$  of  $(\Delta, \mathcal{A})^\infty$ , the vertices of  $T(m)$  are walls  $M$  of  $(\Delta, \mathcal{A})$  such that  $M^\infty = m$ , and two vertices are joined by an edge if they are walls of a common apartment with no wall in between. The apartments of  $T(m)$  are taken to consist of those vertices, and edges joining them, which are walls of some common apartment in  $\mathcal{A}$ . The half-apartments (i.e. sectors) of  $T(m)$  then correspond in an obvious way to those half-apartments of  $(\Delta, \mathcal{A})$  whose boundary wall has direction  $m$ . Thus the ends of  $T(m)$  are simply the roots of  $(\Delta, \mathcal{A})^\infty$  having boundary wall  $m$ .

Given two distinct roots of a spherical building  $((\Delta, \mathcal{A})^\infty$  in our case) having a common boundary wall, there is a unique apartment containing them both - cf. (6.3). Thus each pair of ends of  $T(m)$  determines an apartment of  $(\Delta, \mathcal{A})^\infty$ , hence an apartment of  $(\Delta, \mathcal{A})$ , and hence an apartment of  $T(m)$  itself. We have therefore proved:

(10.3) LEMMA.  $T(m)$  is a tree with sap whose ends correspond to the roots of  $(\Delta, \mathcal{A})^\infty$  having boundary wall  $m$  (i.e., to  $St(m)$ ).  $\square$

Before dealing with  $T(\pi)$ , we define two sector-panels to be *asymptotic* if their intersection contains a sector-panel. By Exercise 5 this is an equivalence relation which is finer than the relation of being parallel. The equivalence classes will be called *asymptote classes*, and the asymptote class of  $D$  will be denoted  $\hat{D}$ .

**The tree  $T(\pi)$  with sap.** For a given panel  $\pi$  of  $(\Delta, \mathcal{A})^\infty$  the vertices of  $T(\pi)$  are the asymptote classes of sector-panels  $D$  for which  $D^\infty = \pi$ , and two vertices are joined by an edge if there are sector-panels from the two classes, lying in the same sector, and with no sector-panel in between. Before defining the apartments of  $T(\pi)$  we observe that if  $D^\infty = \pi$ , and  $S$  is any sector of  $(\Delta, \mathcal{A})$  having  $D$  as a sector-panel, then the other sector panels parallel to  $D$  and contained in  $S$  form a half-line in  $T(\pi)$  - see Figure 10.2.

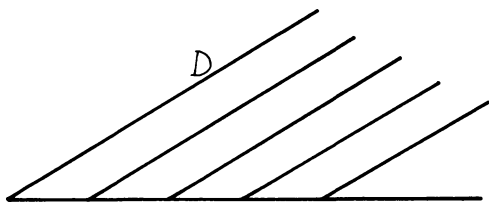

**Figure 10.2**

We define the apartments of  $T(\pi)$  by requiring these half-lines to be the half-apartments (i.e., sectors) of  $T(\pi)$ . Thus if two sectors  $S$  and  $T$  lie in a common apartment and intersect in the sector-panel  $D$ , then the sector-panels of  $S \cup T$  parallel to  $D$  form an apartment of  $T(\pi)$ . Since any two sectors of  $(\Delta, \mathcal{A})$  contain subsectors lying in a common apartment, the same is true for half-apartments of  $T(\pi)$ , and we have a tree with sap. Moreover two half-apartments of  $T(\pi)$  have the same end if and only if the corresponding sectors  $S$  and  $S'$  contain a common sector (i.e.,  $S$  and  $S'$  give the same chamber  $S^\infty = (S')^\infty$  of  $(\Delta, \mathcal{A})^\infty$ ). Thus the ends of  $T(\pi)$  correspond to the chambers of  $St(\pi)$ , and we have proved:

(10.4) LEMMA.  $T(\pi)$  is a tree with sap whose ends correspond to the chambers of  $(\Delta, \mathcal{A})^\infty$  having  $\pi$  as a panel (i.e., chambers of  $St(\pi)$ ).  $\square$

The idea is now to use section 1, applied to  $T(m)$  and  $T(\pi)$ , to obtain projective valuations  $\omega_m$  and  $\omega_\pi$  on  $St(m)$  and  $St(\pi)$  respectively. This requires a metric on  $T(m)$  and  $T(\pi)$  which we define as follows. The affine Coxeter complex, regarded as Euclidean space, can be given a metric (unique up to multiplication by a positive real number). This gives a metric on each apartment, and hence on  $(\Delta, \mathcal{A})$ , so we have a distance between any two parallel walls or sector-panels, which in turn defines a metric on  $T(m)$  and  $T(\pi)$ .

**Remark.** The distance between adjacent vertices of  $T(m)$  or  $T(\pi)$  cannot be 1 in all cases. In fact if the Coxeter group has two orbits on the set of walls, then the ratio of the distances between adjacent walls in the two orbits is  $\sqrt{2}$  (in the  $\tilde{B}_n$ ,  $\tilde{C}_n$  and  $\tilde{F}_4$  cases) or  $\sqrt{3}$  (in the  $\tilde{G}_2$  case). For example Figure 10.3 shows the  $\tilde{C}_2$  case.

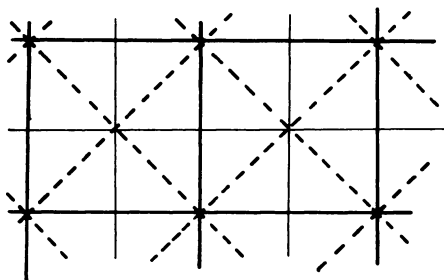

Figure 10.3

We now choose a fixed Euclidean metric, and let  $\omega_m$  and  $\omega_\pi$  be the projective valuations induced on  $St(m)$  and  $St(\pi)$ .

The following theorem is proved by Tits [1986a] section 18, but in a more general setting in which the “building” may not be discrete - see Appendix 3. We shall not prove it here.

(10.5) THE UNIQUENESS THEOREM. *If  $(\Delta, \mathcal{A})^\infty$  is thick, then  $(\Delta, \mathcal{A})$  is determined up to unique isomorphism by the  $\omega_\pi$  (or the  $\omega_m$ ) for all panels  $\pi$  (or walls  $m$ ) of  $(\Delta, \mathcal{A})^\infty$ .*  $\square$

The data  $\omega_\pi$  for all panels  $\pi$  can in fact be inferred from knowing just one or two of the  $\omega_\pi$ , namely one in each of the one or two types of walls of  $(\Delta, \mathcal{A})^\infty$ . The idea is that one can transfer the data  $\omega_\pi$  to the data  $\omega_{\pi'}$  whenever  $\pi$  and  $\pi'$  lie in a common wall. The following proposition makes this precise.

(10.6) PROPOSITION. *If  $\pi$  is a panel in a wall  $m$ , then for each asymptote class  $\hat{D}$  of sector-panels in the direction  $\pi$ , there is a unique wall  $M$  in the direction  $m$  containing a representative of  $\hat{D}$ . The map  $\hat{D} \mapsto M$  is an isomorphism from  $T(\pi)$  to  $T(m)$  and induces on the set of ends a map  $\iota_{\pi m}$  sending a chamber of  $St(\pi)$  to the unique root of  $St(m)$  containing it. Moreover  $\omega_\pi = \omega_m \circ \iota_{\pi m}$ .*



If  $\pi$  and  $\pi'$  are two panels of  $m$ , then  $\iota_{\pi',m}^{-1} \circ \iota_{\pi m}$  is a bijection from  $St(\pi)$  to  $St(\pi')$ ; any combination of such bijections is called a *projectivity*, and we let  $GP(\pi)$  denote the group of projectivities from  $St(\pi)$  to itself. By (10.6) any projectivity from  $\pi$  to  $\pi'$  sends  $\omega_\pi$  to  $\omega_{\pi'}$ ; in particular  $\omega_\pi$  is invariant under the group  $GP(\pi)$ .

In a spherical Coxeter complex (with a connected diagram) there are at most two types of walls (this was discussed earlier in Chapter 6 section 4). Moreover in a thick building of spherical type, given two panels  $\pi_1$  and  $\pi_2$  of the same type, there is a third panel  $\pi'$  opposite both of them (it is an exercise to verify this - cf. (3.3) Step 2). Hence  $\pi_1$  lies in a common wall with  $\pi'$  which in turn lies in a common wall with  $\pi_2$ . Therefore in  $(\Delta, \mathcal{A})^\infty$  there are at most two “projectivity classes” of panels, and we have the following.

(10.7) COROLLARY TO THE UNIQUENESS THEOREM. *If  $\Delta$  is thick, then  $(\Delta, \mathcal{A})$  is determined up to unique isomorphism by  $\omega_\pi$  for a single panel  $\pi$  in one of at most two “projectivity classes”.*

**Application - the classification of  $\tilde{A}_n$  buildings for  $n \geq 3$ .** Let  $\Delta$  be an affine building of type  $\tilde{A}_n$  for  $n \geq 3$ , and let  $\mathcal{A}$  be a system of apartments for  $\Delta$ . Then  $(\Delta, \mathcal{A})^\infty$  is a spherical building of type  $A_n$ , and since  $n \geq 3$  it is the  $A_n(K)$  building for some field  $K$  (not necessarily commutative). If  $\pi$  is a panel of  $(\Delta, \mathcal{A})^\infty$ , then  $St(\pi)$  can be identified with the projective line  $K \cup \{\infty\}$ , and  $GP(\pi) \cong PGL_2(K)$ . It therefore follows from Example 3 in section 1 that  $\omega_\pi$  is equivalent to a discrete valuation  $v$  of  $K$ . The same building at infinity with the same  $\omega_\pi$  could be obtained by using the  $\tilde{A}_n(K, v)$  building of Chapter 9 section 2, and so (10.7) implies that  $(\Delta, \mathcal{A}) \cong \tilde{A}_n(K, v)$ . (The isomorphism is uniquely determined by the isomorphism of the buildings at infinity).

This argument applies to other types of affine buildings, namely those of types  $\tilde{D}_n$ ,  $\tilde{E}_6$ ,  $\tilde{E}_7$ ,  $\tilde{E}_8$ , where there is only one “projectivity class” of panels, and  $St(\pi)$  is a projective line; it shows that every such building is associated to a field  $K$  with a discrete valuation  $v$ . However we have not yet constructed these affine buildings, and do not therefore yet have a classification. In the next section we study “root groups with a valuation” which we use in section 4 to construct affine buildings. In section 5 we then use  $K$  and  $v$  to obtain a system of “root groups with valuation” to conclude the classification of these cases.

**3. Root Groups with a valuation.**

In this section we assume  $(\Delta, \mathcal{A})^\infty$  to be Moufang. By (6.7) this is always the case when  $(\Delta, \mathcal{A})^\infty$  has rank at least 3 (recall we assume a connected diagram for  $(\Delta, \mathcal{A})$ , and hence also for  $(\Delta, \mathcal{A})^\infty$ ). Now fix some apartment  $A \in \mathcal{A}$ , and let  $\Phi$  be the set of roots of  $A^\infty$ . For each  $a \in \Phi$  let  $U_a$  denote the corresponding root group.

(10.8) PROPOSITION. *If  $G$  is the group generated by the  $U_a$ , the action of  $G$  on  $(\Delta, \mathcal{A})^\infty$  extends to an action on  $(\Delta, \mathcal{A})$ .*

PROOF: If  $U_a$  is any root group we must show that its action extends to  $(\Delta, \mathcal{A})$ . By (10.7) it suffices to check that  $U_a$  preserves  $\omega_\pi$  for  $\pi$  in one or two possible classes. In either case  $\pi$  may be taken to lie in  $a - \partial a$ , so  $U_a$  acts trivially on  $St(\pi)$ , and hence on  $\omega_\pi$ . □

We now fix a point  $s \in A$  (not necessarily a vertex). Each root  $a \in \Phi$  corresponds to a half-space  $a_s$  of  $A$ , having  $s$  on its boundary (if we treat  $A$  as a vector space  $V_s$  with origin  $s$ , each  $a_s$  is a half-space of  $V_s$ , as in Chapter 2 section 4). Now given  $u \in U_a - \{1\}$ ,  $A \cap uA$  is a half-apartment of  $A$ , and its boundary wall  $M_u$  is parallel to  $\partial a_s$ . We define  $\varphi_a(u)$  to be the distance from  $\partial a_s$  to  $M_u$  in the Euclidean space  $A$ , measured in the  $+a_s$  to  $-a_s$  direction (i.e. with a  $+$  sign if  $\partial a_s \subset uA$ , and a  $-$  sign otherwise) - see Figure 10.5 where  $\varphi_a(u)$  is negative.

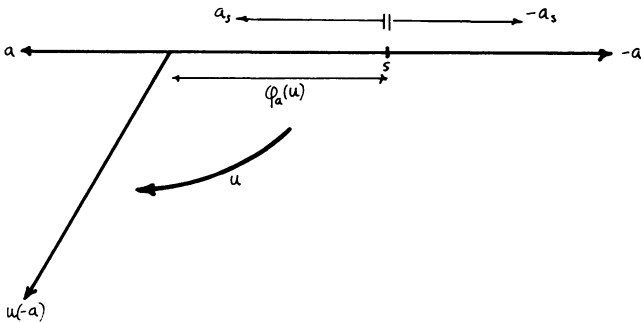

Figure 10.5

As mentioned in section 2 we do not have a metric defined on  $A$  *a priori*; it is only unique up to a multiplicative constant. After fixing this

metric on  $A$ , each root  $a \in \Phi$  determines  $\varphi_a$  up to an additive constant depending on the choice of the point  $s$ .

Since  $(\Delta, \mathcal{A})^\infty$  is Moufang,  $U_a$  acts simple-transitively on the set of apartments of  $(\Delta, \mathcal{A})^\infty$  containing  $a$ , and so for  $m = \partial a$ ,  $U_a$  corresponds to the set of roots of  $St(m)$  different from  $a$  (see (6.3)). Thus  $St(m)$  consists of  $a$  and  $u(-a)$  as  $u$  ranges over  $U_a$ .

(10.9) LEMMA.  $\omega_m(a, u(-a); u'(-a), u''(-a)) = \varphi_a(u^{-1}u'') - \varphi_a(u^{-1}u')$ .

PROOF: By (10.8)  $u^{-1}$  fixes  $\omega_m$ , so the left hand side equals  $\omega_m(a, -a; u^{-1}u'(-a), u^{-1}u''(-a))$ . The result follows immediately from the definitions of  $\varphi_a$  and  $\omega_m$ . □

**Root Data with Valuation.** (Données radicielles valuées).

As in Chapter 6 let  $\Phi$  be the set of roots in an apartment  $\Sigma$  of a (thick) Moufang building of spherical type, with a connected diagram, and for each  $a \in \Phi$  let  $U_a$  denote the corresponding root group. As mentioned in Chapter 2 section 4 we may regard roots as half-spaces, and walls  $\partial a$  as hyperplanes, in a real vector space  $V$  (the Coxeter group  $W$  acts on  $V$  preserving a dot product). We let  $1_a$  denote the vector of length 1 perpendicular to  $\partial a$  and contained in  $a$ , and let  $r_a$  denote the reflection in the wall  $\partial a$ , switching  $a$  and  $-a$ .

A collection  $\psi = (\psi_a)_{a \in \Phi}$  of maps  $\psi_a : U_a \rightarrow \mathbf{R}$  will be called a *valuation* of the  $U_a$  if they satisfy the following.

- (V0)  $\text{Card } \psi_a(U_a) \geq 3$
- (V1)  $U_{a,t} := \psi_a^{-1}[t, \infty)$  is a group, and  $U_{a,\infty} = \{1\}$ .
- (V2) Given  $b \neq \pm a$ , the commutator

$$[U_{a,k}, U_{b,t}] \leq \langle U_{c,pk+qt} \mid c \in (a, b) \rangle$$

where  $1_c = p 1_a + q 1_b$  (recall from Chapter 6 section 3 that  $(a, b)$  is the set of roots  $c$  with  $a \cap b \subset c \neq a, b$ ).

- (V3) Given  $a, b \in \Phi$ , and  $u \in U_a - \{1\}$ , there exists  $t \in \mathbf{R}$  (depending on  $b$  and  $u$ ) such that for all  $x \in U_b$

$$\psi_{r_a(b)}(m(u)xm(u)^{-1}) = \psi_b(x) + t.$$

Moreover if  $a = b$ , then  $t = -2\psi_a(u)$ , or in other words

$$\psi_{-a}(m(u)xm(u)^{-1}) = \psi_a(x) - 2\psi_a(u).$$

The element  $m(u)$  was defined in Chapter 6 section 4; it stabilizes  $\Sigma$ , switching  $a$  with  $-a$ . It is the unique element  $vuv' \in U_{-a}uU_{-a} \cap N$ .



(10.10) EXERCISE. Given  $m(u) = vv'$  then  $m(v) = m(u) = m(v')$  by (A.1) in Appendix 1. Use this to prove:

(a)  $\psi_{-a}(v) = \psi_{-a}(v')$

(b)  $\psi_a(u) = -\psi_{-a}(v)$ .

[HINT: (a) is immediate from  $m(v) = m(v')$  and (V3); for (b) let  $m(v) = u_1vu$ ,  $m(u_1) = v_1u_1v$ , so  $m(u_1)um(u_1)^{-1} = v_1$  - now use (a).]

**Remark.** We have not assumed that  $\psi_a(U_a - \{1\})$  is a discrete subset of  $\mathbf{R}$ ; if it is we call the valuation *discrete*. These are the valuations that arise from affine buildings, and in section 4 we shall use such valuations to construct an affine BN-Pair. However, even in the non-discrete case it is possible to construct a geometry having “at infinity” the Moufang building for the root groups  $U_a$ ; these “non-discrete buildings” are discussed in Appendix 3.

**Example 4.** Let  $\Phi = \{\pm a, \pm b, \pm c\}$  be the roots in an  $A_2$  apartment in such a way that  $l_c = l_a + l_b$ , as shown.

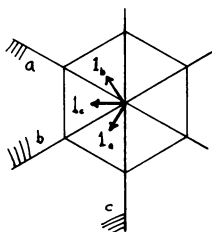

Let  $K$  be a field with a valuation  $v$  satisfying the conditions of Chapter 9 section 2, though  $v$  need not be discrete. Then  $v$  determines a valuation of the root groups in  $SL_3(K)$  as follows. After choosing a suitable basis we may write

$$U_{a,k} : \begin{pmatrix} 1 & x & 0 \\ 0 & 1 & 0 \\ 0 & 0 & 1 \end{pmatrix} \quad \text{where } v(x) \geq k$$

$$U_{b,\ell} : \begin{pmatrix} 1 & 0 & 0 \\ 0 & 1 & y \\ 0 & 0 & 1 \end{pmatrix} \quad \text{where } v(y) \geq \ell$$

$$U_{c,m} : \begin{pmatrix} 1 & 0 & z \\ 0 & 1 & 0 \\ 0 & 0 & 1 \end{pmatrix} \quad \text{where } v(z) \geq m$$

If  $g = \begin{pmatrix} 1 & x & 0 \\ 0 & 1 & 0 \\ 0 & 0 & 1 \end{pmatrix}$  and  $h = \begin{pmatrix} 1 & 0 & 0 \\ 0 & 1 & y \\ 0 & 0 & 1 \end{pmatrix}$  then  $[g, h] = \begin{pmatrix} 1 & 0 & xy \\ 0 & 1 & 0 \\ 0 & 0 & 1 \end{pmatrix}$ . Since  $v(xy) = v(x) + v(y)$ , this gives  $[U_{a,k}, U_{b,\ell}] = U_{c,m}$  where  $m = k + \ell$  (a case where  $p = q = 1$ ). □

(10.11) THEOREM. The  $(\varphi_a)$  defined earlier, using a point  $s$  in the affine apartment  $A$ , are a valuation of the root groups  $(U_a)$ .

PROOF: Since  $(\Delta, A)$  is thick,  $\varphi_a$  takes infinitely many values, so (V0) is clear.

(V1): Notice first that  $uA \cap A = u^{-1}A \cap A$ , hence  $\varphi_a(u) = \varphi_a(u^{-1})$ , and so  $U_{a,t}$  contains the inverse of each of its elements. Furthermore for  $u, u' \in U_a$  the part of  $A$  fixed by  $u$  and  $u'$  is certainly fixed by  $uu'$ , so  $uA \cap u'A \cap A \subset uu'A \cap A$ ; hence  $\varphi_a(uu') \geq \min(\varphi_a(u), \varphi_a(u'))$ , and  $U_{a,t}$  is a group. Moreover if  $u \in U_{a,\infty}$ , then  $u$  fixes  $A$  and hence  $u = 1$ .

(V2): Let  $K$  and  $L$  be the walls parallel to, and at distance  $k$  and  $\ell$  from,  $\partial a_s$  and  $\partial b_s$ , respectively - see Figure 10.6.

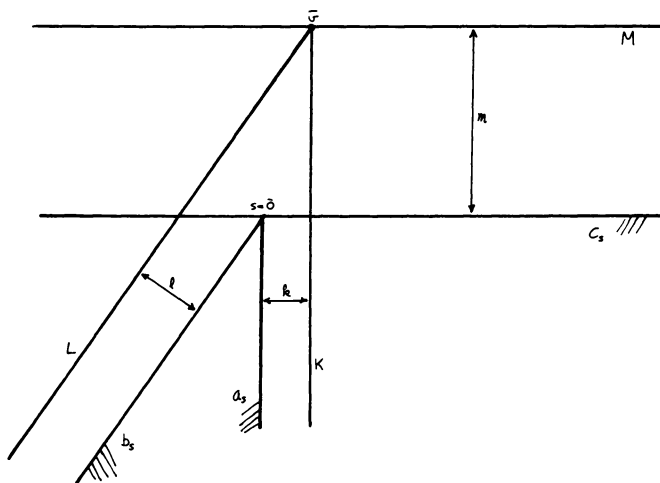

Figure 10.6

We now consider the underlying affine space  $A$  as a vector space with origin  $s$ , and let  $\bar{v}$  denote the point of intersection of  $L$  and  $K$  in the 2-space spanned by  $1_a$  and  $1_b$ . By (6.12)  $[U_a, U_b] \leq \langle U_c \mid c \in (a, b) \rangle$ . If  $u \in U_c$

is a factor in such a commutator then  $u$  must fix  $\bar{v}$ , and hence  $u \in U_{c,m}$  where  $m$  is the (signed) distance from  $\partial c_s$  to  $\bar{v}$  (see Figure 10.6). We let  $M$  denote the wall through  $\bar{v}$  parallel to  $\partial c_s$ , so  $m$  is the distance from  $\partial c_s$  to  $M$ . To evaluate  $m$ , notice that the equations for points  $\bar{x}$  on the walls  $K, L$  and  $M$  are respectively:

$$\begin{aligned} \bar{x} \cdot 1_a &= -k \\ \bar{x} \cdot 1_b &= -\ell \\ \bar{x} \cdot 1_c &= -m \end{aligned}$$

As  $\bar{v}$  lies on  $K, L$  and  $M$  this gives

$$m = -\bar{v} \cdot 1_c = -p\bar{v} \cdot 1_a - q\bar{v} \cdot 1_b = pk + q\ell$$

where  $1_c = p1_a + q1_b$ .

(V3) Given  $a, b \in \Phi$  write  $b' = r_a(b)$ . For  $u \in U_a - \{1\}$ ,  $M_u$  is the wall fixed by  $m(u)$ , and we let  $t$  be the distance from  $M_u \cap \partial b_s$  to  $\partial b'_s$  (in the  $b'_s$  to  $-b'_s$  direction) - see Figure 10.7.

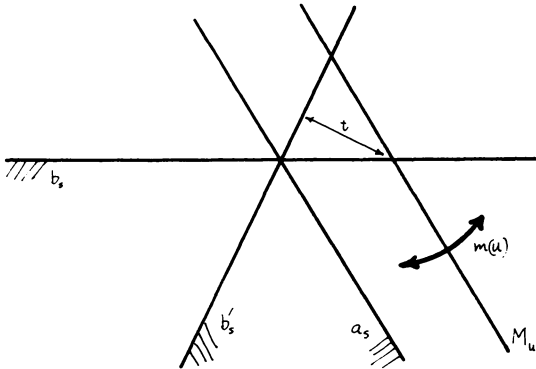

Figure 10.7

Then using signed distances as usual,  $m(u)$  sends a wall at distance  $k$  from  $\partial b_s$  to a wall at distance  $k+t$  from  $\partial b'_s$ . Thus  $\varphi_{b'}(m(u)xm(u)^{-1}) = \varphi_b(x)+t$  for all  $x \in U_b$ , as required.

Finally if  $a = b$ , then  $b_s = -b'_s$ , and we let  $h$  be the distance from  $\partial b'_s$  to  $M_u$  (+ if  $M_u \subset b'_s$ , and - if  $M_u \subset b_s$ ) - see Figure 10.8.

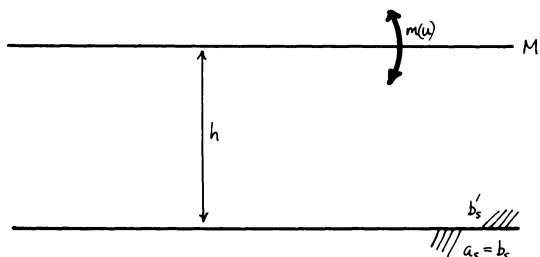

Figure 10.8

Then  $m(u)$  sends a wall at distance  $k$  from  $\partial a_s$  to a wall at distance  $k + 2h$  from  $\partial a_s$ , so  $t = 2h = -2\varphi_a(u)$  in this case. □

**Equivalence and equipollence.** To conclude this section, replace the point  $s$  by  $s'$ , and keep the same metric on  $A$ . If  $v$  is the vector  $s' - s$ , and  $\varphi'$  the valuation obtained using  $s'$ , then

$$\varphi'_a(u) = \varphi_a(u) + v \cdot 1_a$$

- see Figure 10.9.

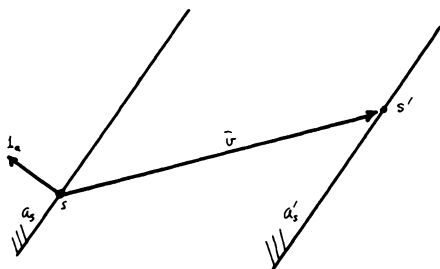

Figure 10.9

Two valuations related in this way are called *equipollent*, and we write

$$\varphi' = \varphi + v.$$

Altering the metric on  $A$  turns  $\varphi_a(u)$  into  $\lambda\varphi_a(u)$  for some positive real number  $\lambda$ , and if we alter both the metric and the point  $s$  then in place of  $\varphi$  we obtain  $\lambda\varphi + v$ , for some  $\lambda > 0$  and  $v \in V$ , where

$$(\lambda\varphi + v)_a(u) = \lambda\varphi_a(u) + v \cdot 1_a.$$

We call  $\varphi$  and  $\lambda\varphi + v$  *equivalent*. If  $\psi$  is any valuation (satisfying (V0) - (V3)), then so is  $\lambda\psi + v$  (Exercise 7).

#### 4. Construction of an Affine BN-Pair.

In this section we start with a discrete valuation  $\psi = (\psi_a)$  of the root groups  $(U_a)_{a \in \Phi}$  as defined in section 3, and construct an affine BN-Pair. We let  $N$  be the subgroup generated by the  $m(u)$ , and show that it acts as an affine Coxeter group  $W^{\text{aff}}$  on the affine space whose points are valuations equipollent to one another. The finite Coxeter group acting on  $\Phi$  will be denoted  $W(\Phi)$ .

Recall again from Chapter 2 section 4 that  $W(\Phi)$  acts on a real vector space  $V$  preserving a dot product. The roots  $a \in \Phi$  correspond to half-spaces of  $V$  and the walls  $\partial a$  to hyperplanes of  $V$ . As in section 3 we let  $1_a$  denote the unit vector perpendicular to  $\partial a$  and lying in the half-space  $a$ .

For  $n \in N$  with image  $w \in W(\Phi)$  we define an action on the set of valuations, as follows:

$$(n \cdot \psi)_a(u) = \psi_{w^{-1}(a)}(n^{-1}un).$$

In fact  $n \cdot \psi$  is a valuation equipollent to  $\psi$ , by (10.11) below, but first notice that since  $v \cdot 1_{w^{-1}(a)} = w(v) \cdot 1_a$  one has

$$n \cdot (\lambda\psi + v) = \lambda(n \cdot \psi) + w(v).$$

(10.12) LEMMA. Given  $u \in U_a - \{1\}$ , then for  $m = m(u)$  one has

$$m \cdot \psi = \psi - 2k1_a$$

where  $k = \psi_a(u)$ .

PROOF: For  $b \in \Phi$  and  $x \in U_b$  with  $\psi_b(x) = \ell$  we shall evaluate  $(m \cdot \psi)_b(x)$ . Assume first that  $b \neq \pm a$ , and let  $\Psi$  be the set of roots  $c \in \Phi$  such that

$1_c = p1_a + q1_b$  with  $q > 0$  (see Figure 10.10 in which  $\Psi = \{b, c, d\}$ ).

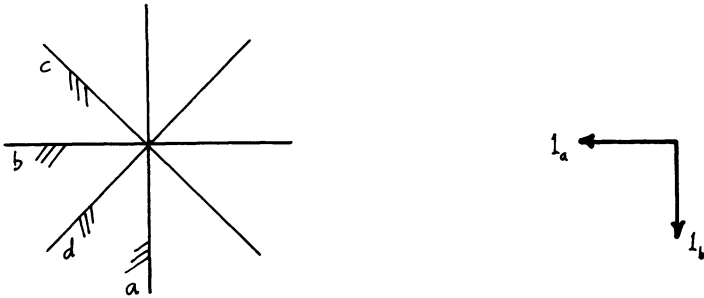

Figure 10.10

Notice that both  $\Psi \cup \{a\}$ , and  $\Psi \cup \{-a\}$  are a full set of positive roots. Also, the reflection  $r$ , switching  $a$  and  $-a$ , stabilizes  $\Psi$ . Now for  $c \in \Psi$ , set

$$h(c) = pk + q\ell;$$

in particular  $h(b) = \ell$ . By (V2) the product

$$\prod_{c \in \Psi} U_{c, n(c)} = U'$$

is a group, and one has

$$U_b \cap U' = U_{b, \ell}$$

and

$$U_{r(b)} \cap U' = U_{r(b), h(r(b))}.$$

Since  $1_{r(b)} = 1_b - 2(1_a \cdot 1_b)1_a$ , we have  $h(r(b)) = \ell - 2(1_a \cdot 1_b)k$ . Furthermore if we write  $m = vuv'$  where  $v, v' \in U_{-a}$ , then by (10.10)  $\psi_a(u) = k$  implies  $\psi_{-a}(v) = \psi_{-a}(v') = -k$ . Using (V2) again we see  $U'$  is normalized by  $v$ ,  $u$ , and  $v'$ , and hence by  $m$ . Therefore

$$m^{-1}U_{b, \ell}m = m^{-1}U_b m \cap U' = U_{r(b)} \cap U' = U_{r(b), h(r(b))}.$$

Hence

$$(m \cdot \psi)_b(x) = \psi_{r(b)}(m^{-1}xm) = \ell' \geq h(r(b)) = \ell - 2(1_a \cdot 1_b)k.$$

Similarly  $\ell \geq \ell' - 2(1_a \cdot 1_{r(b)})k = \ell' + 2(1_a \cdot 1_b)k$ , and therefore  $\ell' = \ell - 2(1_a \cdot 1_b)k$ . Thus  $(m \cdot \psi)_b(x) = \psi_b(x) - 2k1_a \cdot 1_b$ , as required (for  $b \neq \pm a$ ).

For  $b = a$ ,  $1_a \cdot 1_b = 1$ , and (V3) immediately gives

$$(m \cdot \psi)_b(x) = \psi_{-b}(m^{-1}xm) = \psi_b(x) - 2k1_a \cdot 1_b.$$

For  $b = -a$ , then using (V3) and the fact (see (A.1) in Appendix 1) that  $m = m(v)$  for the second equality, and  $\psi_b(v) = -k$  and  $1_a \cdot 1_b = -1$  for the third, one has

$$(m \cdot \psi)_b(x) = \psi_{-b}(m^{-1}xm) = \psi_b(x) - 2\psi_b(v) = \psi_b(x) - 2k1_a \cdot 1_b.$$

This completes the proof that  $m \cdot \psi = \psi - 2k1_a$ .  $\square$

We now take some given valuation  $\psi$  of the root groups, and let  $A$  denote the set of valuations equipollent to  $\psi$ , namely all  $\psi + v$  with  $v \in V$ . It has the structure of an affine space by taking the distance between  $\psi + v$  and  $\psi + w$  to be the length of the vector  $v - w$ . We know that each root  $a \in \Phi$  corresponds to a half-space of  $V$ , and hence to a half-space of  $A$ , namely  $(a, 0) = \{\psi + v \mid v \cdot 1_a \geq 0\}$ . More generally set  $\Gamma_a = \psi_a(U_a - \{1\})$  and for each  $k \in \Gamma_a$  define the *affine root*  $(a, k)$  as

$$(a, k) = \{\psi + v \mid v \cdot 1_a \geq -k\}$$

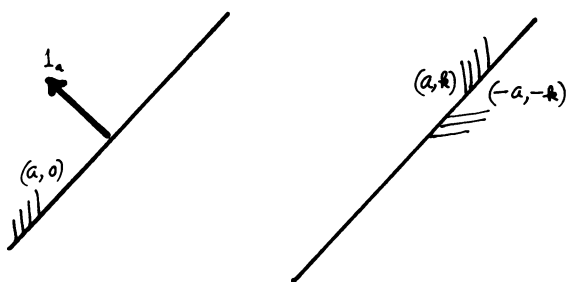

Figure 10.11

In Figure 10.11  $k > 0$ . Let  $\Phi^{\text{aff}}$  be the set of affine roots, which we denote by Greek letters  $\alpha, \beta, \dots$ ; their boundaries  $\partial\alpha$  are called the *walls* of  $A$ . If  $\alpha$  is the affine root  $(a, k)$  we let  $U_\alpha$  denote  $U_{a,k}$ . For  $n \in N$ ,  $n \cdot \alpha$  means the set of  $n \cdot \psi$  for  $\psi \in \alpha$ , and we have:

(10.13) LEMMA.  $nU_\alpha n^{-1} = U_{n \cdot \alpha}$ .

PROOF: Let  $\alpha = (a, k)$ , and let  $n$  induce  $w \in W(\Phi)$ . One has

$$\begin{aligned} nU_\alpha n^{-1} &= \{u \mid n^{-1}un \in U_\alpha \text{ and } \psi_a(n^{-1}un) \geq k\} \\ &= \{u \in U_{w(a)} \mid (n \cdot \psi)_{w(a)}(u) \geq k\} \end{aligned}$$

Let  $v = n \cdot \psi - \psi \in V$ , so  $k \leq (n \cdot \psi)_{w(a)}(u) = \psi_{w(a)}(u) + v \cdot 1_{w(a)}$ . Thus  $nU_\alpha n^{-1} = U_\beta$  where  $\beta = (w(a), k - v \cdot 1_{w(a)})$ , and we must show  $\beta = n \cdot \alpha$ . This can be seen as follows:

$$\begin{aligned} \beta &= \{\varphi \in A \mid (\varphi - \psi) \cdot 1_{w(a)} \geq -(k - v \cdot 1_{w(a)})\} \\ &= \{\varphi \in A \mid (\varphi - \psi - v) \cdot 1_{w(a)} \geq -k\} \\ &= \{\varphi \in A \mid (\varphi - n \cdot \psi) \cdot 1_{w(a)} \geq -k\} \\ &= \{\varphi \in A \mid (n^{-1} \cdot \varphi - \psi) \cdot 1_a \geq -k\} \\ &= \{\varphi \in A \mid n^{-1} \cdot \varphi \in \alpha\} \\ &= n \cdot \alpha \end{aligned}$$

□

(10.14) COROLLARY.  $N$  acts on  $A$  as an affine Coxeter group, and the walls subdivide  $A$  into a Coxeter complex.

PROOF: If  $\alpha = (a, k)$  then the reflection across the wall  $\partial\alpha$  sends  $v$  to  $r(v) - 2k1_a$ , where  $r \in W(\Phi)$  is the reflection switching  $a$  and  $-a$ . Now if  $m \in M_{a,k} = \{m(u) \mid \psi_a(u) = k\}$  then  $m$  induces  $r \in W(\Phi)$ ; and using (10.12) we have

$$m \cdot (\psi + v) = m \cdot \psi + r(v) = \psi - 2k1_a + r(v).$$

Thus  $m$  acts on  $A$  as the reflection across the wall  $\partial\alpha$ . It therefore only remains to show that  $N$  sends walls to walls. This follows from the preceding lemma because if  $\alpha = (a, k)$  is an affine root, then  $nU_\alpha n^{-1} = U_\beta$  for some affine root  $\beta$ , and we have  $n \cdot \alpha = \beta$ . □

We let  $W(\Phi^{\text{aff}})$ , or simply  $W^{\text{aff}}$ , denote this affine Coxeter group, and let  $H$  be the kernel of the action of  $N$  on  $A$ . Thus  $N/H \cong W^{\text{aff}}$ .

We can now define the subgroup  $B$  of our affine Tits system. Take a chamber  $c$  of  $A$  (regarded as a Coxeter complex) and let  $\Phi^{\text{aff}}(c)$  denote the affine roots containing  $c$ . Then  $B$  is the group generated by  $H$  and the  $U_\alpha$  for  $\alpha \in \Phi^{\text{aff}}(c)$ . Before proving  $(B, N)$  is an affine Tits system, we need some technical lemmas.



(10.15) LEMMA. Let  $u \in U_a$  and  $v \in U_{-a}$  with  $\psi_a(u) + \psi_{-a}(v) > 0$ . Then  $uv = v_1hu_1$  where  $u_1 \in U_a$ ,  $v_1 \in U_{-a}$  and  $h \in H$ . Furthermore  $\psi_a(u_1) = \psi_a(u)$  and  $\psi_{-a}(v_1) = \psi_{-a}(v)$ .

PROOF: If we set  $L_a = \langle U_a, U_{-a}, H \rangle$  and  $M_a = \langle H, m(u) \mid u \in U_a \rangle$ , then it is an exercise having nothing to do with valuations (see Bruhat-Tits [1972] page 108 (6.1.2) (7)) that

$$L_a = M_a U_a \cup U_{-a} H U_a.$$

Moreover  $uv \notin M_a U_a$ , otherwise for some  $u' \in U_a$  we would have  $uvu' \in N$ , so  $m(v) = uvu'$ , hence by (10.10)  $\psi_a(u) = -\psi_{-a}(v)$ , contradicting our hypothesis. Thus  $uv = v_1hu_1$ , where  $v_1 \in U_{-a}$ ,  $u_1 \in U_a$  and  $h \in H$ .

For the final statement we may suppose  $u, v \neq 1$ . Therefore  $v_1 \neq 1$  and writing  $m = m(v_1)$  we have  $v_1 = u_2mu_3$  where  $u_2, u_3 \in U_a$ , and by (10.10)

$$\psi_a(u_2) = -\psi_{-a}(v_1)$$

This gives  $v = u^{-1}u_2mu_3hu_1 = u^{-1}u_2mhu_3^h u_1 \in U_a N U_a$ . Again (10.10) implies

$$\psi_{-a}(v) = -\psi_a(u^{-1}u_2).$$

Therefore  $\psi_a(u^{-1}u_2) < \psi_a(u)$ , and hence, using (V1)

$$\psi_a(u^{-1}u_2) = \psi_a(u_2).$$

Therefore  $\psi_{-a}(v) = -\psi_a(u_2) = \psi_{-a}(v_1)$ , and similarly  $\psi_a(u) = \psi_a(u_1)$ .  $\square$

If we select some chamber  $x$  of the spherical Coxeter complex  $W(\Phi)$  then  $\Phi = \Phi^+ \cup \Phi^-$  where the *positive roots*  $\Phi^+$  (or *negative roots*  $\Phi^-$ ) are those containing (or not containing)  $x$  - see Chapter 6 section 4. We now define:

$$\begin{aligned} U(c) &= \langle U_{a,k} \mid c \in (a, k) \rangle \\ U^+(c) &= \langle U_{a,k} \mid a \in \Phi^+ \text{ and } c \in (a, k) \rangle \\ U^-(c) &= \langle U_{a,k} \mid a \in \Phi^- \text{ and } c \in (a, k) \rangle \end{aligned}$$

Since  $H$  normalizes each  $U_{a,k}$ ,  $U(c)$  is normal in  $B$ , and  $B = U(c) \cdot H$ . Furthermore we can describe the structure of  $U(c)$  as follows.

(10.16) LEMMA. (i)  $U(c) = U^+(c)U^-(c)(N \cap U(c))$ , and  $N \cap U(c) \subset H$ .  
 (ii) For any  $a \in \Phi$ ,  $U_a \cap U(c) = U_\alpha$  where  $\alpha$  is minimal with respect to containing  $c$ .

PROOF: Set  $X_a = U_\alpha$  where  $\alpha$  is minimal with respect to containing  $c$ , as in (ii); thus  $U(c)$  is the group generated by the  $X_a$  for  $a \in \Phi$ . We set  $H(c) = H \cap U(c)$  and first show that  $U^+(c)U^-(c)H(c) = U(c)$ . Since this product is contained in  $U(c)$  it suffices to show it remains stable under left multiplication by  $X_a$  for each  $a \in \Phi$ . Certainly this is true if  $a \in \Phi^+$ , so we need only show that the product is the same regardless of the decomposition of  $\Phi$  into positive and negative roots.

If  $\Sigma$  denotes the apartment of which  $\Phi$  is the set of roots, then  $\Phi^+$  is the set of roots containing some chamber  $x \in \Sigma$ , so it suffices to show the product is unchanged when we replace  $x$  by an adjacent chamber  $y \in \Sigma$ . If  $a \in \Phi$  is the root containing  $x$  but not  $y$ , then  $y$  gives positive roots  $\Phi^{+'} = \{-a\} \cup \Phi^+ - \{a\}$ , and negative roots  $\Phi^{-'} = \{a\} \cup \Phi^- - \{-a\}$ . We let  $X'_a$  (or  $X'_{-a}$ ) be the group generated by the  $X_b$  for  $b \in \Phi^+$  and  $b \neq a$  (or  $b \in \Phi^-$  and  $b \neq -a$ ). Then with an obvious notation  $U^{+'}(c) = X'_a X_{-a}$  and  $U^{-'}(c) = X'_{-a} X_a$ .

Notice that  $X_a$  and  $X_{-a}$  normalize both  $X'_a$  and  $X'_{-a}$ , and moreover by (10.15)  $X_a X_{-a} H(c) = X_{-a} X_a H(c)$ . Therefore:

$$\begin{aligned} U^+(c)U^-(c)H(c) &= X'_a X_a X_{-a} X'_{-a} H(c) \\ &= X'_a X'_{-a} X_a X_{-a} H(c) \\ &= X'_a X'_{-a} X_{-a} X_a H(c) \\ &= X'_a X_{-a} X'_{-a} X_a H(c) \\ &= U^{+'}(c)U^{-'}(c)H(c). \end{aligned}$$

As explained above, this shows that  $U(c) = U^+(c)U^-(c)H(c)$ .

We now show  $H(c) = N \cap U(c)$ , so take  $n \in N \cap U(c)$  and write  $n = u^+ u^- h$  with an obvious notation. Then  $u^- h$  fixes the chamber  $x'$  of  $\Sigma$  opposite  $x$ , and  $u^+$  sends it to a chamber opposite  $x$ ; but  $n(x') \in \Sigma$ , hence  $n(x') = x'$ , and so  $n$  acts trivially on  $\Sigma$ . This shows  $n \in H$ , and completes the proof of (i).

To prove (ii) let  $u \in U_a \cap U(c)$  where without loss of generality  $a \in \Phi^+$ . By (i)  $u = u^+ u^- h$  with the notation above, and  $u^- h$  fixes  $x'$ , so  $u(x') = u^+(x')$ . Since  $U^+ = \langle U_a \mid a \in \Phi^+ \rangle$  acts simple-transitively on chambers  $x'$  opposite  $x$  (see Chapter 6 Exercise 16 and (6.15)) we have  $u = u^+$ . Again

using (6.15), after suitably ordering the roots of  $\Phi^+$  (according to a gallery determined by the longest word in  $W(\Phi)$ ), the map  $\prod_{a \in \Phi^+} U_a \rightarrow U^+$  is a bijection. By (V2) this holds equally for  $\prod_{a \in \Phi^+} X_a \rightarrow U^+(c)$ , and therefore  $u \in X_a$ , completing the proof.  $\square$

In the next lemma, which is needed to prove (BN2),  $\alpha = (a, k)$  is any affine root, and  $-\alpha^+ = (-a, \ell)$  where  $\ell$  is minimal satisfying  $k + \ell > 0$ . Thus  $\alpha$  and  $-\alpha^+$  have parallel walls with no wall between - see Figure 10.12.

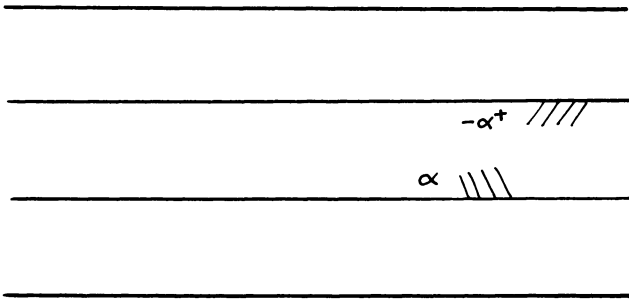

Figure 10.12

(10.17) LEMMA. If  $m \in M_{a,k}$ , and  $L_\alpha$  denotes the group generated by  $H, U_\alpha$  and  $U_{-\alpha}$ , then  $L_\alpha = (U_\alpha m H U_\alpha) \cup (U_\beta H U_\alpha)$ , where  $\beta = -\alpha^+$ .

PROOF: Let  $X_1 = U_\alpha m H U_\alpha$  and  $X_2 = U_\beta H U_\alpha$ . Since  $m \in U_\alpha U_{-\alpha} U_\alpha$  and  $U_\beta \subset U_{-\alpha}$  we see that  $X_1 \cup X_2 \subset L_\alpha$ .

Conversely let  $X = X_1 \cup X_2$ . Since  $m U_\alpha m^{-1} = U_{-\alpha}$  we have  $L_\alpha = \langle H, U_\alpha, m \rangle$ , and so it suffices to show that  $H X \subset X$ ,  $U_\alpha X \subset X$  and  $m X \subset X$ . The first is immediate because  $H$  normalizes  $U_\alpha$  and  $U_\beta$ , and  $m$  normalizes  $H$ . As to the second,  $U_\alpha X_1 = X_1$  is clear, and  $U_\alpha X_2 \subset X_2$  follows from (10.15).

Finally we show  $m X \subset X$ . First notice that

$$m X_2 = m U_\beta H U_\alpha \subset m U_{-\alpha} H U_\alpha \subset U_\alpha m H U_\alpha = X_1.$$

Moreover since  $m^2 \in H$  we have

$$m X_1 = m U_\alpha m H U_\alpha = U_{-\alpha} H U_\alpha,$$

so it suffices to show that  $U_{-\alpha}HU_{\alpha} \subset X$ . To see this let  $u \in U_{-\alpha} - U_{\beta}$ , so  $\psi_{-\alpha}(u) = -k$  and there exist  $v, v' \in U_{\alpha}$  with  $vvv' \in M_{\alpha, k} \subset mH$ . Therefore  $u \in U_{\alpha}mHU_{\alpha}$ , and hence

$$U_{-\alpha} \subset U_{\beta} \cup U_{\alpha}mHU_{\alpha}.$$

Therefore  $U_{-\alpha}HU_{\alpha} \subset X_2 \cup X_1 = X$ , completing the proof.  $\square$

We are now ready to prove the main theorem of this section.

(10.18) THEOREM. *If  $G$  denotes the group generated by the  $U_{\alpha}$ , then  $(B, N)$  is an affine Tits system for  $G$ .*

PROOF: We verify axioms (BN0) - (BN3); recall that  $c$  is a chamber of  $A$ , and  $B$  is generated by  $H$  and  $U(c)$ .

(BN0) Certainly  $B$  and  $N$  are subgroups of  $G$ , and for any  $u \in U_{\alpha}$  with  $\psi_{\alpha}(u) = k$ , either  $c \in (a, k)$  in which case  $u \in B$ , or  $c \in (-a, -k)$  in which case  $m(u)um(u) \in B$  and  $u \in \langle B, N \rangle$ . Thus  $G = \langle B, N \rangle$ .

(BN1) From the action of  $N$  on  $A$  we know  $N/H \cong W^{\text{aff}}$ ; moreover  $H \subset B \cap N$ , so we need only show  $B \cap N \subset H$ . As mentioned earlier  $H$  normalizes  $U(c)$ , so  $B = U(c)H$  and since  $N \cap U(c) \subset H$  by (10.16)(i) we have  $N \cap B \subset H$ .

(BN2) Let  $s$  be a reflection in some wall  $\partial\alpha$  containing a panel of  $c$ ; we must show  $BsBwB \subset BswB \cup BwB$  for any  $w \in W^{\text{aff}}$ . Let  $c \in \alpha$ , and set  $\Psi = \Phi^{\text{aff}}(c) - \{\alpha\}$ . If  $U'$  denotes the group generated by the  $U_{\beta}$  for  $\beta \in \Psi$ , then from (10.16)(i) we have

$$B = U'HU_{\alpha}.$$

Moreover  $s$  stabilizes  $\Psi$ , and hence normalizes  $U'$ , so this gives

$$sB \subset BsU_{\alpha}. \tag{*}$$

Recall that  $L_{\alpha}$  is a group containing  $s$  (or rather its inverse image in  $N$ ), and therefore  $L_{\alpha}wB = L_{\alpha}swB$ . Replacing  $w$  by  $sw$  if necessary we may assume  $w^{-1}(\alpha)$  contains  $c$ , in which case  $w^{-1}U_{\alpha}w \subset B$ . Now letting  $\beta$  denote the translate of  $-\alpha$  which is minimal with respect to containing  $c$ , (10.17) gives

$$L_{\alpha}wB = U_{\alpha}sHU_{\alpha}wB \cup U_{\beta}HU_{\alpha}wB \subset BswB \cup BwB$$

Using (\*) this implies

$$BsBwB \subset BsU_\alpha wB \subset BL_\alpha wB \subset BswB \cup BwB$$

as required.

(BN3) With the notation above,  $sU_\alpha s = U_{-\alpha}$ , and by (10.16)(ii)  $U_{-\alpha} \not\subset B$ . Therefore  $sBs \neq B$ .  $\square$

If we let  $\Delta$  denote the affine building determined by  $B$  and  $N$ , then we obtain an apartment system  $\mathcal{A}$  as follows. Treat chambers of  $\Delta$  as left cosets  $gB$  as in Chapter 5, and let  $\Sigma$  be the apartment whose chambers are all  $nB$ , for  $n \in N$ . The images of  $\Sigma$  under  $G$  are the apartments of  $\mathcal{A}$ ; they correspond to the apartments of the spherical building for  $(U_a)_{a \in \Phi}$  (because both correspond to the conjugates of the set  $(U_a)_{a \in \Phi}$ ), and hence  $(\Delta, \mathcal{A})^\infty$  is this spherical building.

Moreover there is a canonical isomorphism between  $\Sigma$  and the simplicial complex of  $A$ , given by  $nB \leftrightarrow w(c)$  where  $w = nH \in W^{\text{aff}}$ . Let  $s$  be the point of  $\Sigma$  corresponding to  $\psi \in A$ . If we take the metric on  $\Sigma$  induced by  $A$ , and let  $\varphi$  be the valuation determined by  $\Sigma$  and  $s$ , as in section 3, then  $\varphi = \psi$ . Indeed if  $u \in U_a$  with  $\psi_a(u) = k$ , then  $m(u) \in N$  fixes a wall of  $A$  at distance  $k$  from  $\psi$  (in the  $+a$  to  $-a$  direction), and therefore a wall of  $\Sigma$ , similarly at distance  $k$  from  $s$ . This must be the boundary wall of  $\Sigma \cap u\Sigma$ , and therefore  $\varphi_a(u) = k$ . We have therefore proved:

(10.19) COROLLARY. *Any set of root data with a discrete valuation arises from an apartment system in an affine building.*  $\square$

## 5. The Classification.

This section deals mainly with the classification of affine buildings  $(\Delta, \mathcal{A})$  having rank  $\geq 4$  (and a connected diagram). In this case  $(\Delta, \mathcal{A})^\infty$  has rank  $\geq 3$ , so we can apply the classification of spherical buildings in Chapter 8.

The first step (10.20) is to show that when  $(\Delta, \mathcal{A})^\infty$  is Moufang (in particular when its rank is at least 3), the problem reduces to classifying root data with valuation. If  $(\Delta, \mathcal{A})^\infty$  has rank 2, then it is a generalised  $m$ -gon which might not be Moufang, and a classification is not possible, as we shall explain.

(10.20) THEOREM. *The  $(\Delta, \mathcal{A})$  for which  $(\Delta, \mathcal{A})^\infty$  is Moufang correspond to equivalence classes of root data with valuation.*

PROOF: By (10.19) every set of root data with valuation arises from a suitable affine system  $(\Delta, \mathcal{A})$ , uniquely determined by (10.5). Conversely

we saw in section 3 how a given  $(\Delta, \mathcal{A})$  gives rise to a set of root data with valuation when  $(\Delta, \mathcal{A})^\infty$  is Moufang. That involved choosing a point  $s$  in an apartment  $A$  and assigning a Euclidean metric to  $A$ . The choice of apartment is irrelevant because if  $A'$  is any other apartment there is an automorphism of  $(\Delta, \mathcal{A})$  inducing an isometry from  $A$  to  $A'$ ; and the choice of metric and point  $s$  gives an equivalent evaluation, as explained at the end of section 3.  $\square$

We now show that a valuation  $\psi = (\psi_a)$  is determined up to equipollence by a single  $\psi_a$ .

(10.21) THEOREM. *If  $\varphi$  and  $\psi$  are valuations of the same root groups, then  $\varphi_a = \psi_a$  for some  $a \in \Phi$  if and only if  $\varphi = \psi + v$  for some  $v \in V$  perpendicular to  $1_a$ .*

PROOF: Given any root  $b \in \Phi$ , let  $c = r_b(a)$  where  $r_b$  is the reflection interchanging  $b$  and  $-b$ , and let  $m = m(x)$  for some  $x \in U_b - \{1\}$ . Given  $y \in U_c - \{1\}$ , recall that  $(m \cdot \psi)_c(y) = \psi_a(m^{-1}ym)$  by definition, and therefore by (10.12) we have

$$\begin{aligned} \psi_a(m^{-1}ym) &= (\psi - 2\psi_b(x)1_b)_c(y) \\ &= \psi_c(y) - 2\psi_b(x)1_b \cdot 1_c \\ &= \psi_c(y) + 2\psi_b(x)1_a \cdot 1_b \end{aligned}$$

We rewrite this as:

$$2(1_a \cdot 1_b)\psi_b(x) = \psi_a(m^{-1}ym) - \psi_c(y).$$

If  $1_a \cdot 1_b \neq 0$ , this shows that  $\psi_a$  determines  $\psi_b$  up to an additive constant. Moreover, if  $\psi_a$  and  $\psi_b$  are known, so is  $\psi_c$ , and therefore  $\psi$  is uniquely determined by its components at a set of fundamental roots  $a_1, \dots, a_\ell$ ; we choose these so that  $a_1 = a$ .

Let  $\varphi_{a_i} = \psi_{a_i} + k_i$  where  $k_i \in \mathbf{R}$  is a constant (and of course  $k_1 = 0$ ), and let  $v \in V$  be the unique vector such that  $v \cdot 1_{a_i} = k_i$ . Then the valuation  $\psi' = \psi + v$  has the property that  $\psi'_{a_i} = \psi_{a_i} + k_i$ , and hence  $\psi' = \varphi$ . Thus  $\varphi_a = \psi_a$  implies  $\varphi = \psi + v$  where  $v \cdot 1_a = 0$ , and the converse is a triviality.  $\square$

**Single Bond Diagrams of Rank  $\geq 4$ .** The single bond cases of rank  $\geq 4$  are  $\tilde{X}_n = \tilde{A}_n$  ( $n \geq 3$ ),  $\tilde{D}_n$  ( $n \geq 4$ ) or  $\tilde{E}_n$  ( $n = 6, 7$  or  $8$ ), and the classification of spherical buildings (Chapter 8) shows that  $(\Delta, \mathcal{A})^\infty$  must

be the  $X_n(K)$  building for some field  $K$  (necessarily commutative except in the  $A_n$  case). Furthermore if  $\pi$  is any panel in a wall  $m$  of  $(\Delta, \mathcal{A})^\infty$ , then  $St(\pi)$  and  $St(m)$  both correspond to the projective line  $K \cup \{\infty\}$ .

Now let  $\Phi$  denote the roots in some given apartment of  $(\Delta, \mathcal{A})^\infty$ , and let  $a \in \Phi$ , and  $m = \partial a$ . Without loss of generality we identify  $St(m)$  with  $K \cup \{\infty\}$  so that  $a$  corresponds to  $\infty$ , and  $-a$  to  $0 \in K$ . The root group  $U_a$  is the group of affine translations, and we label its elements by subscripts belonging to  $K$ , so that  $u_0 = id.$ , and  $u_x(-a) \in St(m)$  corresponds to the point  $x \in K$  of the affine line. By Example 3 in section 2,  $\omega_m(a, -a; u_1(-a), u_x(-a)) = v(x)$  for some discrete valuation  $v$  of  $K$ .

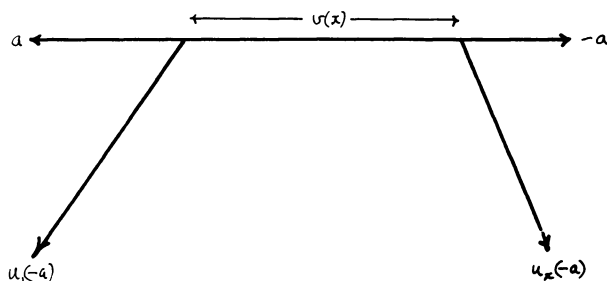

Figure 10.13

It is clear from Figure 10.13 that if  $\varphi_a(u_1) = t \in \mathbf{R}$ , then  $\varphi_a(u_x) = t + v(x)$ ; in particular after identifying  $K$  with  $U_a$ ,  $v$  determines  $\varphi_a$  up to an additive constant. Recall that after multiplying  $v$  by a suitable positive real number, we have  $v(K^\times) = \mathbf{Z}$ , in which case  $v$  is called *normalized*.

(10.22) THEOREM. *There is a bijective correspondence between thick affine systems  $(\Delta, \mathcal{A})$  of type  $\tilde{X}_n = \tilde{A}_n, \tilde{D}_n, \tilde{E}_6, \tilde{E}_7$  or  $\tilde{E}_8$ , and pairs  $(K, v)$  where  $K$  is a field (necessarily commutative except for  $\tilde{A}_n$ ) with a discrete, normalized valuation  $v$ .*

PROOF: As mentioned above,  $(\Delta, \mathcal{A})^\infty$  is the  $X_n(K)$  building, and by (10.20),  $(\Delta, \mathcal{A})$  corresponds to an equivalence class of  $X_n(K)$  root data. By the discussion above, this gives a discrete, normalized valuation  $v$  of  $K$ , and although  $v$  only determines  $\varphi_a$  up to an additive constant, (10.21) shows that it determines the root data up to equipollence. It therefore only remains to show that *any*  $v$  gives a set of root data with valuation.

To see this, let  $G$  be the group generated by the  $U_a$ , and take a non-trivial representation of  $G$  over the field  $K$ . Each  $U_a$  is then represented as

a group of unipotent matrices with a single non-zero entry off the diagonal. If  $u \in U_a$  let  $e_u$  denote this non-zero element, and set

$$\varphi_a(u) = v(e_u).$$

It remains to check that the  $(\varphi_a)$  satisfy (V0) - (V3) of section 3. In fact (V0) and (V1) are immediate, and to check (V2) and (V3) we first note that if  $a \neq \pm b$  then  $a$  and  $b$  span either an  $A_2$  or an  $A_1 \times A_1$  subsystem, because each rank 2 residue is of this type. Thus it suffices to check (V2) and (V3) in an  $A_1 \times A_1$  or  $A_2$  system, and this is completely straightforward; we leave it to the reader, and refer to Example 4 of section 3.  $\square$

**Double Bond Diagrams of Rank  $\geq 4$ .** These cases are  $\tilde{F}_4$ ,  $\tilde{B}_n$  and  $\tilde{C}_n$  for  $n \geq 3$ . In all such cases  $(\Delta, \mathcal{A})^\infty$  has two types of walls  $m$ , and for at least one type  $St(m)$  is a projective line over a field  $K$  (not necessarily commutative). Indeed the classification of Chapter 8 shows that a  $C_2$  residue of  $(\Delta, \mathcal{A})^\infty$  must be a Moufang quadrangle of classical type; that is to say, it arises from those 1-spaces and 2-spaces in a vector space over  $K$ , which are totally singular or isotropic under a suitable form of Witt index 2. This implies there are panels  $\pi$  for which  $St(\pi)$  corresponds to the 1-spaces in a 2-space over  $K$ , hence our assertion above about  $St(m)$ . The discussion in the single bond case then gives:

(10.13) PROPOSITION. *Each system  $(\Delta, \mathcal{A})$  of type  $\tilde{F}_4$ ,  $\tilde{B}_n$  or  $\tilde{C}_n$ , for  $n \geq 3$ , gives rise to a field  $K$  having a discrete valuation  $v$ .*  $\square$

**Remark.** In general  $K$  is not uniquely determined, because the quadrangle ( $C_2$  residue) and its dual may both arise from a form of Witt index 2 as above, but over different fields (see Chapter 8 section 5). However if  $(\Delta, \mathcal{A})$  has type  $\tilde{B}_n$  or  $\tilde{C}_n$ , then  $(\Delta, \mathcal{A})^\infty$  has type  $C_n$  and there is a canonical choice for  $K$ : if the  $A_2$  residues are Desarguesian (which is always the case for  $n \geq 4$ ), let  $K$  be the associated field, and in the  $C_3$  Cayley plane case there is only one choice for  $K$  anyway (corresponding to the end node of the double bond - see Chapter 8 section 5).

We come now to the following question. Given a field  $K$  with a discrete valuation  $v$ , and given a  $C_n$  or  $F_4$  building associated to  $K$  as above, does there exist an appropriate affine system  $(\Delta, \mathcal{A})$ ? In other words can one find a valuation  $(\varphi_a)$  of the root data inducing the valuation  $v$  on  $K$ ? In general the answer is no, because a  $C_2$  residue (or indeed the whole building, except in the  $F_4$  or  $C_3$  Cayley plane cases) arises from a  $(\sigma, \epsilon)$ -hermitian



form and  $v$  must certainly be invariant under  $\sigma$ . However, assuming this to be the case, the answer is yes when  $K$  is complete with respect to  $v$  (at least in the  $C_n$  or  $F_4$  case considered here) - see Tits [1986a] p.173.

In general let  $G(K)$  be the group generated by the root groups of the  $C_n$  or  $F_4$  building, and let  $G(\widehat{K})$  be obtained by completing the field with respect to  $v$  (considering  $G(K)$  as a group of matrices over  $K$ , satisfying certain polynomial conditions,  $G(\widehat{K})$  is obtained under the same conditions but by extending the field from  $K$  to  $\widehat{K}$ ). Then assuming  $v$  is invariant under  $\sigma$  as above, one has:

*A valuation ( $\varphi_a$ ) of the root data inducing  $v$  on  $K$  exists if and only if  $G(K)$  and  $G(\widehat{K})$  have the same rank.*

In fact if  $S_K$  and  $S_{\widehat{K}}$  are the (spherical) buildings for  $G(K)$  and  $G(\widehat{K})$ , then by the remarks in the preceding paragraph,  $S_{\widehat{K}} = \Delta^\infty$  for some affine building  $\Delta$ . If  $G(K)$  and  $G(\widehat{K})$  have the same rank then  $S_K$  is a sub-building of  $S_{\widehat{K}}$  of the same type and is therefore the union of apartments in some subset  $\mathcal{A}$  of all apartments for  $S_{\widehat{K}}$ ; thus  $S_K = (\Delta, \mathcal{A})^\infty$ . Conversely if  $S_K = (\Delta, \mathcal{A})^\infty$ , then  $G(K)$  is generated by the root groups of  $(\Delta, \mathcal{A})^\infty$ , and so  $G(\widehat{K})$  is generated by the root groups of  $\Delta^\infty$ ; thus  $G(K)$  and  $G(\widehat{K})$  have the same rank.

If  $G(K)$  is a classical group arising from a  $(\sigma, \epsilon)$ -hermitian form, then to say that  $G(\widehat{K})$  has the same rank as  $G(K)$  means that the Witt index of this form does not increase when we extend the scalars from  $K$  to  $\widehat{K}$ . In the non-classical case we have either a  $C_3$  building with Cayley planes, or an  $F_4$  building, and in the  $F_4$  case the rank can only increase if the building involves Cayley planes or quaternion planes (see the diagrams in Chapter 8 section 5). To say that the rank remains the same amounts to saying that the appropriate Cayley or quaternion division algebra does not split when we pass from  $K$  to  $\widehat{K}$  (if it does, then  $S_{\widehat{K}}$  has type  $E_7, E_8$  or  $E_7$  respectively in the three cases). We conclude this discussion with a theorem.

(10.24) THEOREM. *Suppose we have a  $C_n$  or  $F_4$  building  $S$  over a field  $K$  having a discrete valuation  $v$ , invariant under  $\sigma$ , as explained earlier. Then  $v$  determines an affine system  $(\Delta, \mathcal{A})$  with  $(\Delta, \mathcal{A})^\infty = S$  if and only if one of the following holds:*

- (i)  $S$  is "classical", arising from a  $(\sigma, \epsilon)$ -hermitian form whose Witt index remains the same over  $\widehat{K}$ .

(ii)  $S$  is of type  $C_3$  having Cayley planes, or of type  $F_4$  having Cayley planes or quaternion planes, and the relevant Cayley or quaternion division algebra over  $K$  does not split when  $K$  is extended to  $\hat{K}$ .  $\square$

**Example.** Let  $K = \mathbf{Q}$  (the rational numbers). If  $S$  involves Cayley planes, then no discrete valuation  $v$  gives an affine system  $(\Delta, \mathcal{A})$ , because there is no Cayley division algebra over the  $p$ -adics  $\mathbf{Q}_p$ . The same is true if  $S$  arises from a quadratic form of Witt index  $n$  in at least  $2n + 5$  variables, because there is no such form over  $\mathbf{Q}_p$  (any quadratic form in 5 variables over  $\mathbf{Q}_p$  has non-trivial singular vectors).

Finally we state a corollary of the results above, made possible by the fact that if  $K$  is complete and has a finite residue field  $k$  then  $K$  is either a  $p$ -adic field (finite algebraic extension of  $\mathbf{Q}_p$ ) or a power series field  $k((t))$ ; in each such case the discrete valuation is unique up to multiplication by a positive real number.

(10.25) COROLLARY. *The thick locally finite affine buildings of rank  $n \geq 4$  (with a connected diagram) are the affine buildings of simple algebraic groups of rank  $(n - 1)$  over a  $p$ -adic field or a power series field.*  $\square$

**The Rank 3 Case.** If  $(\Delta, \mathcal{A})$  has rank 3 then  $(\Delta, \mathcal{A})^\infty$  is a generalized  $m$ -gon, for  $m = 3, 4$  or  $6$ . A classification is impossible because of a general construction (Ronan [1986]) in which one starts with a single chamber and builds outwards: for each rank 2 residue there is complete freedom of choice amongst all rank 2 buildings having the appropriate type and parameters (number of chambers per panel). The building at infinity, however, can not be chosen arbitrarily; for example it cannot be finite! In the  $\tilde{A}_2$  case, Van Maldeghem [1987] and [1988] shows that the projective plane at infinity is coordinatized by a ternary ring having a discrete valuation (in a sense made precise in those papers), and any such plane arises as a building at infinity of an  $\tilde{A}_2$  building.

## 6. An Application.

In this section we apply the classification of affine buildings, and the results of Chapter 4, to obtain a result in finite group theory, following recent work of Kantor, Liebler and Tits [1987]. To simplify the exposition we deal with only one case of their work, namely  $\tilde{D}_4$ , though a similar argument works for other affine diagrams of rank at least 4.

Consider a finite group  $G$  acting transitively on a chamber system  $C$

of type  $\tilde{D}_4$ :

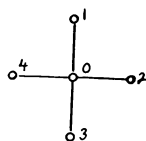

We assume the  $D_4$  residues are buildings (though in view of transitivity one can assume less, such as  $A_2$  residues being Desarguesian planes); in particular these residues are  $D_4(k)$  buildings where  $k = \mathbf{F}_q$  is a finite field of characteristic  $p$ .

(10.26) THEOREM. *Except for the  $q = 2$  case, no such group  $G$  can exist.*

**Remark.** When  $q = 2$  a family of examples was constructed by Kantor [1985]; see also Tits [1986b] (3.2).

**PROOF:** By Theorem 4.9 the universal cover  $\tilde{C}$  is a building of type  $\tilde{D}_4$ , and hence by the classification of section 5 it is the  $D_4(K, v)$  building, where  $K$  is a commutative field with a discrete valuation  $v$  and residue field  $k$ . Without loss of generality we may take  $K$  to be complete in which case it is either a finite extension of  $\mathbf{Q}_p$  (when  $\text{char } K = 0$ ), or the power series field  $k((t))$  (when  $\text{char } K = p$ ).

Now consider the group  $G$ . By Chapter 4 Exercise 8,  $G$  lifts to a group  $\tilde{G}$  acting transitively on  $\tilde{C}$ ; moreover the stabilizer in  $\tilde{G}$  of a vertex of  $\tilde{C}$  is isomorphic to the stabilizer in  $G$  of its image in  $C$ . In particular vertex stabilizers in  $\tilde{G}$  are finite, and in fact this is the starting point for the Kantor-Liebler-Tits paper [loc. cit.].

The argument is now roughly as follows (see below for more details): if  $x$  is a vertex of type  $i = 1, 2, 3$  or  $4$  then the finite simple orthogonal group  $O_8^+(q)$  acts on  $St(x)$ , and acquires a non-trivial projective representation in the 8-dimensional  $K$ -vector space  $V$ , for  $D_4(K)$ . If  $\text{char } K = 0$  this forces  $q = 2$  (by a result in representation theory which we shall simply “pull out of a hat”). On the other hand if  $\text{char } K = p$  then this is the natural representation, but we can play off the actions of four separate  $O_8^+(q)$  (for vertices of types 1, 2, 3 and 4) to show their representations cannot coexist in  $V$ .

To fill in the details of this argument, a theorem of Seitz [1973] shows that, since the stabilizer  $\tilde{G}_x$  is transitive on  $St(x)$ , it contains a subgroup inducing the simple orthogonal group  $O_8^+(q)$  on  $St(x)$ ; let  $\Gamma_i$  be the smallest such subgroup. Since the full automorphism group of  $\tilde{C}$  contains an orthogonal group  $O_8(K)$  as a normal subgroup with a solvable quotient,

the simplicity of  $O_8^+(q)$  implies that  $\Gamma_i$  lies in  $O_8(K)$ . Thus  $\Gamma_i$  has a non-trivial projective representation in 8-dimensions over  $K$ . We now consider separately the cases where the characteristic of  $K$  is 0 or  $p$ .

**Case 1.**  $\text{char } K = 0$ . In this case the smallest dimension for a non-trivial projective representation of  $O_8^+(q)$  is known (see Landazuri-Seitz [1974]), and it is greater than 8 in all cases except  $q = 2$  for which an 8-dimensional representation exists. Furthermore a theorem of Feit and Tits [1978] then implies that  $\Gamma_i$  itself can have no characteristic zero, projective representation in dimension  $\leq 8$  if  $q \neq 2$ . Thus if  $\text{char } K = 0$ , then  $q = 2$ . We shall now complete the proof by showing  $\text{char } K = p$  is impossible.

**Case 2.**  $\text{char } K = p$ . By Exercise 9, regardless of the characteristic, the stabilizer of the vertex  $x$  in  $O_8(K)$  is  $O_8(\mathcal{O})$  where  $\mathcal{O}$  is the valuation ring of  $K$ . The elements of  $O_8(\mathcal{O})$  congruent to the identity modulo the maximal ideal of  $\mathcal{O}$  form a normal subgroup which is a pro- $p$ -group, and its quotient is an 8-dimensional orthogonal group over  $k$ . Thus the finite subgroup  $\Gamma_i$  has a normal  $p$ -subgroup  $U_i$  whose quotient  $G_i$  is an 8-dimensional orthogonal group with  $G_i/Z(G_i) = O_8^+(q)$ . We shall argue that  $U_i = 1$ .

Since we are in the characteristic  $p$  case,  $U_i$  is a unipotent subgroup (i.e. can be put in upper triangular form with diagonal entries all 1), and hence acts trivially on a totally singular 1-space  $V_1$ . However  $\Gamma_i$  cannot fix  $V_1$  otherwise it would fix a sector-face having vertex  $x$  and direction  $V_1$  in the building at infinity, contradicting the fact that it acts transitively on  $St(x)$ . Therefore under the action of  $\Gamma_i$ ,  $V_1$  generates a non-trivial module  $V_0$  for the orthogonal group  $G_i$ . No such module exists in dimension  $< 8$ ; so  $V_0 = V$ , and since  $U_i$  acts trivially on  $V_0$ , we have  $U_i = 1$ .

We can now complete the argument by comparing the actions of  $\Gamma_1, \dots, \Gamma_4$  on  $V$ , to obtain a contradiction. We have established that  $\Gamma_i$  is an orthogonal group; and  $V$  is a natural module for  $\Gamma_i$ , when  $i = 1, 2, 3$  or 4. Let  $B$  be the stabilizer in  $\tilde{G}$  of a chamber  $c$ , and let  $P_j$  be the stabilizer of the  $j$ -panel of  $c$  (e.g.  $\Gamma_1 = \langle P_0, P_2, P_3, P_4 \rangle$ ). Let  $U$  be the normal Sylow- $p$ -subgroup of  $B$ ; it fixes a 1-space  $X \subset V$ , and under the action of  $P_j$  generates either a 1-space or a 2-space. In fact considering  $V$  as a natural  $\Gamma_1$ -module,  $X$  is a totally singular 1-space, and its stabilizer is, without loss of generality,  $\langle P_0, P_2, P_3 \rangle$ ; also it lies in a t.s. 2-space whose stabilizer is  $\langle P_2, P_3, P_4 \rangle$ . Thus under  $P_4$ ,  $X$  generates a 2-space, and under  $P_0, P_2, P_3$  a 1-space.

A similar situation holds for  $\Gamma_2, \Gamma_3$  and  $\Gamma_4$ , so each node  $j$  of the

diagram must be assigned a 1 or a 2, such that in *each*  $D_4$  subdiagram exactly one end node has a 2, and the others have a 1.

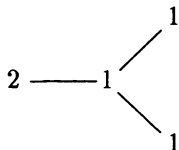

This is plainly impossible. Therefore these representations cannot coexist in  $V$ , and the characteristic  $p$  case cannot occur.  $\square$

**Remark.** In the preceding theorem we have dealt with the generic case. When  $q = 2$ , Kantor, Liebler and Tits are able to show that  $\Delta$  has to be over  $\mathbf{Q}_2$  (rather than an extension thereof) and that there is essentially only one possibility for the group  $\tilde{G}$  acting on  $\Delta$ .

**Notes.** Sections 1, 2, 3 and 5 of this chapter are adapted from Tits [1986a], where the non-discrete case is also dealt with (see Appendix 3), and Section 4 is extracted from Chapter 6 of Bruhat-Tits [1972]. For the classification of locally finite affine buildings (10.25), see Tits [1979].

### Exercises to Chapter 10

In all these exercises  $K$  is a field with a discrete valuation  $v$ , and  $k$  denotes its residue field.

1. Let  $T$  be the tree  $\tilde{A}_1(K, v)$  of Example 2. Show that  $\mathcal{A}(K)$  (Example 1) is the set of all possible apartments if and only if  $K$  is complete with respect to  $v$ . [HINT: Let  $z$  be any end of  $T$ , and let  $x, y_1, y_2, \dots$  be ends of apartments in  $\mathcal{A}(K)$  such that  $[x, y_i] \cap [x, z] \subsetneq [x, y_{i+1}] \cap [x, z]$ . With a suitable choice of basis, an element of  $SL_2(K)$  sending  $[x, y_1]$  to  $[x, y_i]$  has the form  $\begin{pmatrix} 1 & a_i \\ 0 & 1 \end{pmatrix}$  - consider the sequence  $a_1, a_2, \dots$ ].
2. Consider the building  $\tilde{A}_n(K, v)$  and show  $\mathcal{A}(K)$  is the set of all possible apartments if and only if  $K$  is complete with respect to  $v$ . [HINT: Use Exercise 1 and the trees  $T(\pi)$  in section 2].
3. If  $K$  is a field, identify the projective line  $K \cup \{\infty\}$  with the 1-spaces in a 2-space, by setting  $x \mapsto \begin{pmatrix} x \\ 1 \end{pmatrix}$  and  $\infty \mapsto \begin{pmatrix} 1 \\ 0 \end{pmatrix}$ . The affine transformation  $x \mapsto ax + b$  can then be represented by the matrix  $\begin{pmatrix} a & b \\ 0 & 1 \end{pmatrix}$ . If the projective valuation  $\omega$  of section 1 is invariant under the affine group

(Example 3), show it is invariant under the projective group. [HINT: It suffices to consider invariance under  $\begin{pmatrix} 0 & 1 \\ -1 & 0 \end{pmatrix}$ , which for  $a, b, c, d \in K^\times$  means  $\omega(a, b; c, d) = \omega(-a^{-1}, -b^{-1}; -c^{-1}, -d^{-1})$ ].

4. Let  $T$  be a (discrete) tree, and  $v$  some fixed vertex. For any vertex  $x \neq v$ , let  $n = n(v, x)$  denote the number of edges from  $v$  to  $x$ , and define  $d(v, x) = 1 - 2^{-n}$ . This distance  $d$  determines a metric on  $T$ , such that the projective valuation on  $T^\infty$  is not discrete.
5. If a sector-face  $X$  contains a sector-face  $X_1$  of the same dimension, show that  $X_1$  is a translate of  $X$  (in any apartment containing  $X$ ), and therefore parallel to  $X$ . Conclude that for sector-panels the property of being asymptotic is an equivalence relation, finer than that of being parallel.
6. Let  $A_1, A_2, A_3$  be apartments of an affine building, such that  $A_i \cap A_j$  is a half-apartment, for each  $i, j \in \{1, 2, 3\}$ . Show that  $A_1 \cap A_2 \cap A_3$  is non-empty (though it might not contain any chambers). [HINT: First consider trees, then use  $T(m)$ ].
7. If  $\psi$  is a valuation of root groups (satisfying (V0) - (V3)), show that  $\lambda\psi + v$  is too.
8. A valuation of root groups is called *special* if  $0 \in \Gamma_a$  for each  $a \in \Phi$  [recall  $\Gamma_a = \varphi_a(U_a - \{1\})$ ]. Show that the special valuations obtained from an affine building, using a point  $s \in A$  as in section 3, are precisely those for which  $s$  is a special vertex.
9. Let  $\Delta$  be the affine building with a single bond diagram  $\tilde{X}_n$  as in section 5, obtained using a field  $K$  with discrete valuation  $v$ , and let  $G$  be generated by the root groups. Regarding  $G$  as a matrix group, as in section 5, show that the subgroup stabilizing a special vertex is obtained by taking all those matrices with entries in the valuation ring  $\mathcal{O}$  (given a suitable choice of basis, of course).
10. Let  $X$  be an  $\tilde{A}_1$  building (a tree). For a vertex  $x$  and chamber  $c$  on  $x$ , let  $U_{x,c}$  be the set of ends  $e = S^\infty$  where  $S$  has vertex  $x$  and base chamber  $c$ ; call this a *basic open set*.
  - (i) Show that the intersection of two basic open sets is a union of basic open sets.
  - (ii) The  $U_{x,c}$  are a basis for a Hausdorff topology on  $X^\infty$ ; if each vertex has valency  $\leq s$  for some finite number  $s$ , show that this topology makes  $X^\infty$  compact.
  - (iii) Show that  $(X, \mathcal{A})^\infty$  is not compact if  $\mathcal{A}$  is not complete (assuming  $X^\infty$  is an infinite set).

## APPENDIX 1

### Moufang Polygons

This appendix has three sections. The first deals with the function  $u \rightarrow m(u)$  introduced in Chapter 6, and proves the first statement of Lemma (7.3). The second section deals with Moufang planes, and derives the formula for the natural blueprint, used in Chapter 8. The third section proves the theorem (6.9) due to J. Tits and R. Weiss, that for a Moufang (generalised)  $d$ -gon,  $d = 3, 4, 6$  or  $8$ .

#### 1. The $m$ -function.

We recall from Chapter 6 that for any Moufang polygon (or indeed any Moufang building, given a root  $\alpha$  in the apartment  $\Sigma$ , and given any  $u \in U_\alpha - \{1\}$  there are unique elements  $v, v' \in U_{-\alpha}$  such that

$$m(u) = vuv' \in N.$$

Abusing notation slightly, we let  $m$  denote the function sending  $u \in U_\alpha - \{1\}$  to  $m(u) \in N$ , and let  $v, v'$  denote the functions interchanging  $U_\alpha$  with  $U_{-\alpha}$ , where  $v(u) = v$  and  $v'(u) = v'$  above.

If  $c, c'$  denote respectively chambers of  $\alpha, -\alpha$  which are adjacent (i.e. share a panel of  $\partial\alpha$ ), then  $v$  is uniquely determined by sending  $u(c')$  to  $c$ , and  $v'$  by sending  $c$  to  $u^{-1}(c)$  - see Figure 1; remember that group action

is on the left.

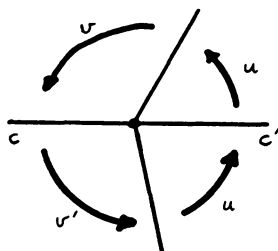

Figure 1

(A.1) LEMMA. (i)  $m(u) = m(v) = m(v')$ , where  $v = v(u)$ ,  $v' = v'(u)$ ,  
 (ii)  $v(v'(u)) = v'(v(u)) = u$ .

PROOF: Since  $vu$  sends  $c'$  to  $c$  we have

$$(vu)U_{-\alpha}(vu)^{-1} = U_{\alpha}$$

and hence

$$x = vuv'(vu)^{-1} \in U_{\alpha}.$$

Thus  $xvu = vuv' \in N$ , and therefore  $m(v) = xv u = m(u)$ , and  $v'(v(u)) = u$ .

Similarly:

$$y = (uv')^{-1}v(uv') \in U_{\alpha}.$$

Therefore  $uv'y = vuv' \in N$ , hence  $m(v') = m(u)$ , and  $v(v'(u)) = u$ . □

**Notation.** To avoid cumbersome notation we shall write  ${}^g x$  to mean  $gxg^{-1}$ , and (occasionally)  $x^g$  to mean  $g^{-1}xg$ .

(A.2) LEMMA.  $m(u^{-1}) = m(u)^{-1}$  and  $m({}^n u) = {}^n m(u)$  for  $n \in N$ .

PROOF: Both these equations are immediate consequences of the fact that  $U_{-\alpha}uU_{-\alpha} \cap N$  is a single element, namely  $m(u)$ ; for instance both  $m(u^{-1})$  and  $m(u)^{-1}$  lie in  $U_{-\alpha}u^{-1}U_{-\alpha} \cap N$ . □

Now consider a generalised  $d$ -gon ( $d$  for diameter). Let  $U_r$ ,  $r(\bmod 2d)$ , be the root groups in a natural cyclic order for the roots in a fixed apartment; in particular  $U_{-r} = U_{r+d}$ . As before, the commutator  $[x, y] = xyx^{-1}y^{-1}$ .



Given  $e_1 \in U_1 - \{1\}$  and  $e_d \in U_d - \{1\}$  we know by (6.12) that we may write

$$[e_1^{-1}, e_d] = e_2 \dots e_{d-1}$$

where  $e_r \in U_r$ . Now define

$$e_{r+d} = v'(e_r) \in U_{r+d}$$

so the  $e_r$  are defined for all  $r$ . We also set

$$n_r = m(e_r).$$

(A.3) LEMMA.  $e_{r+1} = n_r^{-1} e_{d+r-1} n_r$ .

PROOF: Set  $v = v(e_1) \in U_{d+1}$ .

Then

$$\begin{aligned} e_{d+1} n_1^{-1} v &= e_{d+1} v'(e_1)^{-1} e_1^{-1} \\ &= v'(e_1) v'(e_1)^{-1} e_1^{-1} && \text{(definition of } e_{d+1}) \\ &= e_1^{-1}. && (*) \end{aligned}$$

Therefore

$$\begin{aligned} e_2 \dots e_{d-1} e_d &= [e_1^{-1}, e_d] e_d && \text{(by definition)} \\ &= [e_{d+1} n_1^{-1} v, e_d] e_d, && \text{by } (*) \\ &= [e_{d+1} n_1^{-1}, e_d] e_d, && \text{since } [U_{d+1}, U_d] = 1 \\ &= e_{d+1} n_1^{-1} e_d n_1 e_{d+1}^{-1} \\ &= e_{d+1} x e_{d+1}^{-1}, && \text{where } x = n_1^{-1} e_d n_1 \in U_2 \\ &= x [x^{-1}, e_{d+1}]. \end{aligned}$$

Since  $x \in U_2$ ,  $[x^{-1}, e_{d+1}] \in U_{[3,d]}$  by (6.12). Therefore by the uniqueness of the decomposition of the product  $U_2 \dots U_d$ , we have

$$e_2 = x = n_1^{-1} e_d n_1$$

which is the  $r = 1$  case of the lemma. Moreover this shows that

$$e_3 \dots e_d = [e_2^{-1}, e_{d+1}].$$

Therefore we can proceed as above with all indices increased by 1, obtaining  $e_3 = n_2^{-1} e_{d+1} n_2$ , and  $[e_3^{-1}, e_{d+2}] = e_4 \dots e_{d+1}$ , and proceed inductively, completing the proof.  $\square$

(A.4) LEMMA. (i)  $n_{r+d} = n_r$ .

(ii)  $n_r n_{r+1} = n_{r-1} n_r$ .

PROOF: (i) Using (A.1)(i) for the middle equality, one has

$$n_{r+d} = m(v'(e_r)) = m(e_r) = n_r.$$

(ii) Using (A.2) and (A.3) for the first equality, and (i) for the second, one has

$$n_{r+1} = n_r^{-1} n_{d+r-1} n_r = n_r^{-1} n_{r-1} n_r.$$

□

We can now prove (7.3), namely that  $n_i n_j \dots = n_j n_i \dots$  ( $d = m_{ij}$  factors). Here  $n_i = n_1$ , and  $n_j = n_d$ .

(A.5) PROPOSITION.  $n_1 n_d \dots = n_d n_1 \dots$  where each side has  $m$  factors alternating between  $n_1$  and  $n_d$ .

PROOF: By (A.4)(i)  $n_d = n_o$ . Therefore the left hand side equals  $n_1 n_o n_1 \dots = n_1 n_2 \dots n_d$  by repeated use of (A.4)(ii). Similarly the right hand side equals  $n_o n_1 n_o \dots = n_1 n_2 \dots n_d$ . □

## 2. The Natural Labelling for a Moufang Plane.

Let  $\alpha_1, \alpha_{12}, \alpha_2$  be the positive roots, and  $U_1, U_{12}, U_2$  the corresponding root groups in a natural cyclic order in the apartment  $\Sigma$  - see Figure 2.

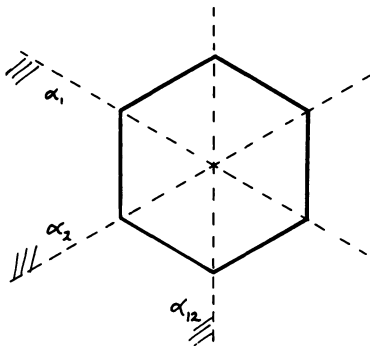

Figure 2

These roots groups are abelian (by (6.12)), and conjugate to one another (e.g.,  $n_1$  conjugates  $U_2$  to  $U_{12}$ ). We shall identify them with a common abelian group  $A$  written additively, and use subscripts to indicate

membership of  $U_1$ ,  $U_{12}$  or  $U_2$ . Moreover  $A$  will be given a multiplicative structure, making it an alternative division ring. This will be done via the identification of  $A$  with  $U_{12}$ , and in such a way that specified non-identity elements  $e_1 \in U_1$  and  $e_2 \in U_2$  become the unity of  $A$ .

Given  $e_1$  and  $e_2$  we write  $n_1 = m(e_1)$ ,  $n_2 = m(e_2)$ , and set

$$e_{12} = [e_1, e_2].$$

(A.6) LEMMA.  $e_{12} = n_2 e_1^{-1} n_2^{-1} = n_1 e_2 n_1^{-1}$ .

PROOF: We apply (A.3) for  $m = 3$ , with  $e_1^{-1}$  in place of  $e_1$ , and hence  $n_1^{-1}$  in place of  $n_1$  by (A.2) (the  $e_1, \dots, e_6$  of (A.3) become  $e_1, e_{12}, e_2, \dots$ ). Setting  $r = 0$  in (A.3) gives  $e_1^{-1} = n_2^{-1} e_{12} n_2$ , and setting  $r = 1$  in (A.3) gives  $e_{12} = n_1 e_2 n_1^{-1}$ .  $\square$

In view of (A.6) we identify  $U_1$  and  $U_2$  with  $U_{12}$  by conjugation, as follows:

$$x_{12} = n_2 x_1^{-1} n_2^{-1} = n_1 x_2 n_1^{-1} \quad (*)$$

Addition on  $A$  is multiplication in a root group; since root groups are abelian this is well-defined, and commutative. Multiplication in  $A$  is defined via identification with  $U_{12}$  as:

$$x * y = [x_1, y_2].$$

In particular  $e * e = e$ . Before describing the natural blueprint we need the following lemma.

(A.7) LEMMA. (i)  $[x_1, y_2^{-1}] = [x_1, y_2]^{-1} = [x_1^{-1}, y_2]$ .

(ii)  $n_2 x_{12} n_2^{-1} = x_1$  and  $n_1 x_{12} n_1^{-1} = x_2^{-1}$ .

(iii)  $n_1^2 x_2 n_1^{-2} = x_2^{-1}$  and  $n_2^2 x_1 n_2^{-2} = x_1^{-1}$ .

PROOF: (i) This is a straightforward exercise; it suffices to check the image of the chamber  $e$  in Figure 2.

(ii) By (i) if we replace all elements of  $U_1$  and  $U_2$  by their inverses (so, by A.2,  $n_1$  becomes  $n_1^{-1}$ , and  $n_2$  becomes  $n_2^{-1}$ ), the elements of  $U_{12}$  remain unchanged ( $[x_1^{-1}, y_2^{-1}] = [x_1, y_2]$ ). The result follows from (\*).

(iii) Immediate from (ii).  $\square$

Now suppose the sequences  $(a_1, b_2, c_1)$  and  $(x_2, y_1, z_2)$  are equivalent in the natural blueprint. In other words, following Chapter 7,

$$a_1 n_1 b_2 n_2 c_1 n_1 = x_2 n_2 y_1 n_1 z_2 n_2.$$

Using (\*) and (A.7) we can write the left hand side as

$$a_1 b_{12} n_1 c_{12}^{-1} n_2 n_1 = a_1 b_{12} c_2 n_1 n_2 n_1$$

and the right hand side as

$$x_2 y_{12}^{-1} n_2 z_1 n_1 n_2 = x_2 y_{12}^{-1} z_1 n_2 n_1 n_2.$$

Using (A.5) and the fact that  $U_{12}$  commutes with  $U_1$  and  $U_2$ , we have

$$a_1 b_{12} c_2 = x_2 y_{12}^{-1} z_1 = y_{12}^{-1} x_2 z_1 = y_{12}^{-1} [x_2, z_1] z_1 x_2 = z_1 y_{12}^{-1} [x_2, z_1] x_2.$$

By uniqueness of the factorization  $U = U_1 U_{12} U_2$  we have

$$a_1 = z_1, \quad c_2 = x_2, \quad b_{12} = y_{12}^{-1} [x_2, z_1] = y_{12}^{-1} [z_1, x_2]^{-1}.$$

Therefore as elements of  $A$ ,

$$a = z, \quad c = x, \quad \text{and } y + b = -z * x = -a * c.$$

Interchanging the roles of  $U_1$  and  $U_2$  gives a different multiplication  $x *' y = [x_2, y_1^{-1}]$  for which  $e *' e = e$ . By (A.7)(i)  $x *' y = [y_1, x_2] = y * x$ . In Chapter 8 we write  $(xy)_1$  for  $x * y$ , and  $(xy)_2$  for  $x *' y$ ; with this notation the equivalence of sequences of types 121 and 212 in the natural blueprint may be written:

sequence	type
$x \ y \ z$	1 2 1
$z \ y' \ x$	2 1 2

where  $y + y' = (xz)_1 = (zx)_2$ .

**Exercise.** In  $SL_3(k)$  identify  $k$  with the root groups  $U_1$ ,  $U_{12}$  and  $U_2$  as follows:

$$x_1 = \begin{pmatrix} 1 & x & 0 \\ 0 & 1 & 0 \\ 0 & 0 & 1 \end{pmatrix} \quad x_{12} = \begin{pmatrix} 1 & 0 & x \\ 0 & 1 & 0 \\ 0 & 0 & 1 \end{pmatrix} \quad x_2 = \begin{pmatrix} 1 & 0 & 0 \\ 0 & 1 & x \\ 0 & 0 & 1 \end{pmatrix}.$$

Thus

$$e_1 = \begin{pmatrix} 1 & 1 & 0 \\ 0 & 1 & 0 \\ 0 & 0 & 1 \end{pmatrix}, \quad n_1 = \begin{pmatrix} 0 & 1 & 0 \\ -1 & 0 & 0 \\ 0 & 0 & 1 \end{pmatrix}, \text{ etc.}$$

Show that

$$a_1 n_1 b_2 n_2 c_1 n_1 = \begin{pmatrix} ac + b & -a & 1 \\ c & -1 & 0 \\ 1 & 0 & 0 \end{pmatrix}$$

and

$$x_2 n_2 y_1 n_1 z_2 n_2 = \begin{pmatrix} -y & -z & 1 \\ x & -1 & 0 \\ 1 & 0 & 0 \end{pmatrix}.$$

**Remark.** By (6.12)  $[x, U_2] = U_{12}$  for  $x \in U_1 - \{1\}$ , hence every non-zero element of  $A$  has a multiplicative inverse. Moreover for  $x, y \in U_1$  and  $z \in U_2$  one has

$$[x, z] \cdot [y, z] = y[x, z]zy^{-1}z^{-1} = yxzx^{-1}y^{-1}z^{-1} = [yx, z],$$

so  $A$  satisfies the distributive law, and is therefore a division ring. Moreover it can be shown that  $A$  satisfies the alternative laws:  $x^2y = x(xy)$ , and  $xy^2 = (xy)y$ . By the Bruck-Kleinfeld theorem [1951] an alternative division ring is either a field (not necessarily commutative) or a Cayley-Dickson algebra. Thus a Moufang plane is either Desarguesian or is a Cayley plane.

### 3. The Non-existence Theorem.

The purpose of this section is to prove that there are no Moufang (generalized)  $d$ -gons except for  $d = 3, 4, 6$  or  $8$ .

This theorem was originally proved by Tits, and the proof appeared in two parts [1976] and [1979]. While part II was in press, a much simpler proof was given by Weiss, using ideas from part I of Tits [1976]. Tits then gave a different, very simple proof using some of Weiss's ideas, and this is what appeared in part II, simultaneously with the paper of Weiss [1979].

The proof given here is based on part II of Tits' paper, with extracts from part I. The main idea is to show first that  $1 \neq Z(U) \subset U_i$  where  $i = \frac{d+1}{2}$  for  $d$  odd, and  $i = \frac{d}{2} - 1$  or  $\frac{d}{2}$  for  $d$  even. One then uses elements  $u \in Z(U)$  to obtain inequalities showing that: if  $d$  is odd, then  $d \leq 3$ ; if  $d$  is  $2 \pmod{4}$ , then  $d \leq 6$ ; and if  $d$  is  $0 \pmod{4}$ , then  $d \leq 12$ . The case  $d = 12$  requires further work before a contradiction is reached.

Before going further, we recall that  $U = U_1 \dots U_d$  with uniqueness of decomposition. In particular if  $1 \leq i, j \leq d$ , then  $U_{[1,j]} \cap U_{[i,d]} = U_{[i,j]}$  if  $i \leq j$ , and  $1$  otherwise. All indices are written mod  $2d$ , and we shall frequently have occasion to shift our indices, so that, for example, a general relationship between  $U_j$  and  $U_k$  can be proved by considering  $U_{i+j}$  and

$U_{i+k}$ , or  $U_{-j}$  and  $U_{-k}$ . Notice that if  $u \in U_k$ , then  $m(u)$ , acting by conjugation, switches  $U_j$  with  $U_{2k+d-j}$ . In particular if  $d$  is odd, all root groups  $U_1, \dots, U_{2d}$  are conjugate, and if  $d$  is even, there are two conjugacy classes: those with even indices, and those with odd indices. To avoid cumbersome notation we shall set  $d' = \frac{d}{2}$  for  $d$  even, and  $\frac{d-1}{2}$  for  $d$  odd.

(A.8) LEMMA. *If for some  $1 \leq k \leq d$ ,  $u \in U_{[k,d]}$ ,  $y \in U_{[1,d]}$  and  ${}^y u \in U_{[1,k-1]}$ , then  $u = 1$ .*

PROOF: Set  $y = x^{-1}z$  where  $x \in U_{[1,k-1]}$  and  $z \in U_{[k,d]}$ . Then  ${}^z u \in U_{[k,d]}$ , but on the other hand  ${}^z u = {}^x({}^y u) \in U_{[1,k-1]}$ , proving that  ${}^z u = 1$ .  $\square$

(A.9) LEMMA. *Let  $u \in U_i$ ,  $v \in U_j$  where  $d' + i < j < d + i$ , and let  $x \in U_{[i,j-1]}$ . If  $[vx, u] = 1$ , then  $u = 1$  or  $v = 1$ .*

PROOF: Without loss of generality we take  $j = d$ , to simplify notation. Suppose  $v \neq 1$ , and let  $m = m(v) = wvw'$ , where  $w, w' \in U_o$ .

$$\text{Set } y = {}^m(w'^{-1}x) \in {}^mU_{[o,d-1]} = U_{[1,d]}.$$

Since  $ym = mw'^{-1}x = wvx$ , we have

$${}^y({}^m u) = {}^{wvx} u = {}^w u = [w, u]u \in U_{[1,i]}.$$

Moreover  ${}^m u \in U_{d-i} \subset U_{[i+1,d]}$ , because  $d' + i < j = d$  implies  $i \leq \frac{d-1}{2}$ , and hence  $i + 1 \leq d - i$ . Therefore by the previous lemma  ${}^m u = 1$ , and so  $u = 1$ .  $\square$

(A.10) COROLLARY. *Let  $i < j < i + d$ , and suppose  $u \in U_i$  commutes with  $y \in U_{[i,j]}$ . Then  $j \leq i + d'$ .*  $\square$

(A.11) COROLLARY. *Let  $u \in U_1 - \{1\}$ ,  $v \in U_d - \{1\}$ . Then, using  $C$  to mean centralizer,*

$$C_U\{u, v\} = \begin{cases} U_{d'+1} & \text{if } d \text{ is odd} \\ U_{d'}U_{d'+1} & \text{if } d \text{ is even.} \end{cases}$$

PROOF: By the previous Corollary,  $C_U(u) \subset U_{[1,d'+1]}$ , and  $C_U(v) \subset U_{[d-d',d]}$ . For  $d$  odd,  $d - d' = d' + 1$ , and for  $d$  even  $d - d' = d'$ , so the result follows.  $\square$

(A.12) LEMMA.  $Z(U) \neq 1$ .

PROOF: We first show  $Z(U_{[a,b]}) \neq 1$  for some interval  $[a, b]$ . If  $U$  is abelian, there is nothing to prove, so assume non-abelian and let  $j < k$  with  $k - j$

minimal subject to  $[U_j, U_k] \neq 1$  (so  $k \geq j + 2$ ). By this minimality assumption  $U_j$  and  $U_k$  centralize  $U_{[j+1, k-1]}$ , hence  $1 \neq [U_j, U_k] \subset Z(U_{[j+1, k-1]})$  as required.

Now by induction it suffices to show that if  $1 \leq s < t < d$  with  $Z(U_{[s, t]}) \neq 1$ , then  $Z(U_{[s, t+1]}) \neq 1$ . To prove this write  $x \in U$  as  $x_1 \dots x_d$  where  $x_i \in U_i$ , and define  $\lambda(x) =$  least  $i$  such that  $x_i \neq 1$ , and set  $\lambda(1) = \infty$ . Now let  $X = \{x \in Z(U_{[s, t]}) \mid x \neq 1, \lambda(x) \text{ maximal}\}$ ; we shall show that  $X \subset Z(U_{[s, t+1]})$ . To prove this, notice first that  $U_{t+1}$  normalizes  $U_{[s, t]}$ , hence normalizes  $Z(U_{[s, t]})$ . Thus for  $x \in X$ ,  $[x, U_{t+1}] \subset Z(U_{[s, t]})$ . However for  $u \in U_{t+1}$ ,  $\lambda([x, u]) > \lambda(x)$ , and therefore  $[x, u] = 1$ , proving that  $x \in Z(U_{[s, t+1]})$ , as required.  $\square$

(A.13) THEOREM. For  $d$  odd,  $1 \neq Z(U) \subset U_{d'+1}$ , where  $d' = \frac{d-1}{2}$ . For  $d$  even,  $1 \neq Z(U) \subset U_{d'}$  or  $U_{d'+1}$ , where  $d' = \frac{d}{2}$ .

PROOF: By the previous lemma  $Z(U) \neq 1$ , and for  $d$  odd the result is immediate from (A.11). To deal with the case of  $d$  even, suppose the result is false. Then by (A.11) we can find

$$x = uv \in U_o U_1 \cap Z(U_{[1-d', d']}) \text{ where } 1 \neq u \in U_o, 1 \neq v \in U_1$$

and

$$x' \in U_{d'} U_{d'+1} \cap Z(U), x' \notin U_{d'}.$$

Set

$$y = [x, x'] = [u, x'] \in U_{[1, d']}.$$

The fact that the group  $U_{[1, d-1]}$  centralizes  $x'$ , and is normalized by  $U_o$ , implies, by an elementary argument, that it centralizes  $y = [u, x']$ , and therefore also centralizes  $[U_o, y]$  and  $[U_o, [U_o, y]] \subset U_{[1, d'-2]}$ . However by (A.10) the only subgroup of  $U_{[1, d'-2]}$  centralized by  $U_{d-1}$  is the identity. Therefore  $[U_o, [U_o, y]] = 1$ .

Thus both  $U_o$  and  $U_{[1, d-1]}$  centralize  $[U_o, y]$ , and hence  $U_{[o, d-1]}$  centralizes  $[U_o, y] \subset U_{[1, d'-1]}$ . However  $Z(U_{[o, d-1]}) \subset U_{d'-1} U_{d'}$ , and we have assumed by way of contradiction that  $Z(U_{[o, d-1]}) \not\subset U_{d'-1}$ . Therefore  $[U_o, y] = 1$ .

This, together with the fact (above) that  $U_{[1, d-1]}$  centralizes  $y$ , shows that

$$y \in Z(U_{[o, d-1]}) \subset U_{d'-1} U_{d'}.$$

Interchanging the roles of  $x$  and  $x'$  in the argument above gives

$$y^{-1} = [x', x] \in U_1 U_2.$$

Consequently  $d' = 2$ , and  $d = 4$ . In this case  $y$  is central in  $U_{[0,3]}$ , and  $y = y_1 y_2$  with  $y_i \in U_i$ . Since  $y$  and  $y_2$  centralize  $U_1$  and  $U_3$ , so does  $y_1$ ; but  $y_1 \in U_1$  centralizes  $U_o$  and  $U_2$ , so  $y_1 \in Z(U_{[0,3]})$ . This contradicts our original assumption, and completes the proof.  $\square$

The following lemma will be crucial in obtaining bounds on  $d$ .

(A.14) LEMMA. *Let  $u \in U_i - \{1\}$ , and suppose*

$$[u, U_{i-p}] = 1 = [u, U_{i+p}]$$

where  $0 < p < \frac{d}{2}$ , and  $p$  is even, or  $p$  and  $d$  are both odd. Then  $3p \leq d$ .

PROOF: Without loss of generality take  $i = 0$ . Write  $m = m(u) = vuv' = u'vu$  where  $v, v' \in U_d$  and  $u' \in U_o$ . Let  $x \in U_p$ , so  ${}^v x = {}^{vu} x = ({}^m x)^{u'}$ . Now  ${}^m x \in U_{d-p}$ , so  ${}^v x = ({}^m x)^{u'} = [u', {}^m x]({}^m x)^{-1} \in U_{[1, d-p]}$ . Therefore  $[x, v] \in U_{[1, d-p]}$ , but on the other hand  $[U_p, v] \subset U_{[p+1, d-1]}$ , so we have

$$[U_p, v] \subset U_{[p+1, d-1]} \tag{1}$$

Similarly:

$$[U_{-p}, v] \subset U_{[-d+p, -p-1]} \tag{2}$$

Now let  $M_k$  be the set of elements of  $N$  inducing the reflection  $\alpha_j \leftrightarrow \alpha_{2k+d-j}$  on our given apartment (e.g. for  $z \in U_k$ ,  $m(z) \in M_k$ ). For  $p$  even, let  $g \in M_{p/2}$ , so  ${}^g U_j = U_{p+d-j}$ . For  $p$  and  $d$  odd, let  $g \in M_{(d+p)/2} M_o$ , so  ${}^g U_j = U_{p+d+j}$ . In both cases  ${}^g v \in U_p$ . If  $p$  is even apply  $g$  to (1), and if  $p$  is odd apply  $g$  to (2) to obtain:

$$[U_d, {}^g v] \subset U_{[2p, d-1]} \tag{3}$$

Combining (1) and (3) gives:

$$[{}^g v, v] \in U_{[p+1, d-p]} \cap U_{[2p, d-1]}.$$

Moreover  $[{}^g v, v] \neq 1$  by (A.10) because  ${}^g v \in U_p$ ,  $v \in U_d$ , and  $d - p > d/2$ . Therefore  $2p \leq d - p$ .  $\square$

Remark. The case where  $p$  is even did not use (2), and therefore only the condition  $[u, U_{i+p}] = 1$  was needed.

We are now in a position to prove the main theorem of this section.



(A.15) THEOREM. For a Moufang  $d$ -gon,  $d = 3, 4, 6$  or  $8$ .

PROOF: By (A.13) there exists  $u \in Z(U) \subset U_i$  with  $u \neq 1$ .

- (i) If  $d$  is odd, then  $i = \frac{d+1}{2}$ , and  $[u, U_{i\pm p}] = 1$  for  $p = \frac{d-1}{2}$ . Therefore by (A.14)  $3p \leq d$ . Thus  $3d - 3 \leq 2d$ , so  $d \leq 3$  (and  $d = 3$  in this case).
- (ii) If  $d$  is even, then  $i = \frac{d}{2}$  or  $\frac{d}{2} + 1$ , so  $[u, U_{i\pm p}] = 1$  for  $p \leq \frac{d}{2} - 1$ .  
 If  $d = 2 \pmod{4}$ , then  $p = \frac{d}{2} - 1$  is even, and hence by (A.14)  $3(\frac{d}{2} - 1) \leq d$ . Thus  $3(d - 2) \leq 2d$ , so  $d \leq 6$  (and  $d = 6$  in this case).  
 If  $d = 0 \pmod{4}$ , then  $p = \frac{d}{2} - 2$  is even, and hence by (A.14)  $3(\frac{d}{2} - 2) \leq d$ . Thus  $3(d - 4) \leq 2d$ , so  $d \leq 12$  (and  $d = 4, 8$  or  $12$  in this case).

It remains to deal with the  $d = 12$  case.

- (iii)  $d = 12$  is impossible.

Without loss of generality we may assume  $Z(U) \subset U_6$ . Since for each  $2k$ ,  $U_{2k}$  is conjugate to  $U_6$  by some element of  $N$ , the set

$$U_{2k}^\dagger = Z(U_{[2k-5, 2k+6]}) - \{1\} \subset U_{2k}$$

is non-empty. With the notation above,  $u \in U_6$ . We set  $m = m(u) = uvv' = u'vu$ , where  $v, v' \in U_{18}$  and  $u' \in U_6$ . Given  $w \in U_{11} - \{1\}$ , it suffices to show that  $v$  and  $w$  commute, because this contradicts (A.10). The proof that  $[w, v] = 1$  will be achieved in two steps, but at one point in the second step we shall need to know that  $v \in U_{18}^\dagger$ ; this fact will be proved in Step 3.

Notice first that  $[w, v] \in U_{[12, 17]}$ .

**Step 1.**  $[w, v] \in U_{[12, 13]}$ .

Since  $u$  commutes with  $w$ , we have

$${}^v w = {}^{vu} w = ({}^m w)^{u'}$$

Therefore

$${}^v w = [u, {}^m w]. {}^m w \in U_{[7, 13]} \text{ since } {}^m w \in U_{13}.$$

Hence

$$[w, v] \in U_{[7, 13]}, \text{ and so } [w, v] \in U_{[12, 13]}.$$

**Step 2.**  $[w, v] \in U_{[16, 17]}$ .

Let  $n = twt' \in M_{11}$ , where  $t, t' \in U_{23}$ . By Step 3,  $v \in U_{18}^\dagger$  and hence  $v$  commutes with  $t'$ , so we have

$${}^w v = {}^{wt'} v = ({}^n v)^t.$$

Therefore

$${}^w v = [t, {}^n v]. \quad {}^n v \in U_{[16,22]} \text{ since } {}^n v \in U_{16}.$$

Hence

$$[w, v] \in U_{[16,17]}.$$

Steps 1 and 2 show  $[w, v] = 1$  contradicting (A.10) as required. It remains to prove:

**Step 3.**  $v \in U_{18}^\dagger$ .

To prove this take  $x \in U_{14}^\dagger$ ; it suffices to show that  $v$  is conjugate to  $x$  by an element of  $N$ .

**Step 3A.**  $[u, x] = {}^m x$ . (A)

Notice first that  ${}^m x \in U_{10}$ . Since  $x$  commutes with  $v' \in U_{18}$ , we have

$$({}^m x)^v = {}^{uv'} x = {}^u x.$$

Therefore  $[u, x] = ({}^m x)^v x^{-1} = {}^m x [{}^m x^{-1}, v] x^{-1} \in {}^m x U_{[11,17]}$ . Moreover  $[u, x] \in U_{[7,13]}$ , hence  $[u, x] \in {}^m x U_{[11,13]} \subset U_{[10,13]}$ . And interchanging the roles of  $x$  and  $u$  shows  $[u, x] \in U_{[7,10]}$ . Thus  $[u, x] \in U_{[7,10]} \cap {}^m x U_{[11,13]}$ , so  $[u, x] = {}^m x$ .

**Step 3B.** Let  $y = {}^m x \in U_{10}$ . Then  $[y^{-1}, v] = x^{-1}$ . (B)

Indeed using Step 3A for the fourth equality,

$$y = {}^{uv'} x = {}^v u x = {}^v ([u, x] x) = {}^v (y x) = {}^v y x = y [y^{-1}, v] x; \text{ hence } [y^{-1}, v] x = 1.$$

**Step 3C.**  $[y^{-1}, {}^{m(y)} x^{-1}] = x^{-1}$ . (C)

By (A.2),  $m^{-1} = m(u^{-1})$ , so  $x = {}^{m(u^{-1})} y$ , and formula (A) can be rewritten as:

$$[u, {}^{m(u^{-1})} y] = y \text{ where } u \in U_6^\dagger, y \in U_{10}^\dagger.$$

In this formula replace  $y \in U_{10}$  by  $x^{-1} \in U_{14}^\dagger$ , and  $u \in U_6^\dagger$  by  $y^{-1} \in U$  to obtain

$$[y^{-1}, {}^{m(y)} x^{-1}] = x^{-1}, \text{ as required.}^*$$

Combining (B) and (C) shows  $[y^{-1}, {}^{m(y)} x v] = 1$ , and since  ${}^{m(y)} x, v \in U_{18}$ , and the only element of  $U_{18}$  commuting with  $y^{-1} \in U_{10}$  is the identity, we have  $v = {}^{m(y)} x^{-1}$ .

Thus  $v \in U_{18}^\dagger$  since it is conjugate, via  $m(y) \in N$ , to an element of  $U_{14}^\dagger$ . This concludes the proof.  $\square$

According to the preceding theorem, Moufang  $d$ -gons only exist if  $d = 3, 4, 6$  or  $8$ . There are examples in all these cases, and in fact an almost complete classification. For  $d = 3$  the classification is well-known (a Moufang plane is coordinatised by a (skew) field or a Cayley division algebra), and was dealt with in Section 2 of this appendix. For  $d = 6$  an explicit classification, using Jordan algebras, was given by Tits [1976a], though his proof was not included in that paper. Subsequently, Faulkner [1977] gave a very detailed proof, though he starts with an ostensibly stronger assumption than the Moufang condition; however it can be shown, using the commutator relation  $[U_1, U_4] = 1$  from Tits [1976a], that all Moufang 6-gons satisfy this condition. For  $d = 8$  all examples arise from groups of type  ${}^2F_4$ , and a complete proof of this fact and an analysis of these groups was given by Tits [1983]. Finally, for  $d = 4$  only very partial results are available (Faulkner [1977] and Tits [1976b]), except in the finite case where a complete proof was given by Fong and Seitz [1973] and [1974]; much more complete results have, however, been obtained, though not published, by Tits. A list of Moufang  $d$ -gons, given in terms of diagrams, can be found in Appendix 2, which is based on Tits [1966] and [1976a].

## APPENDIX 2

### Diagrams for Moufang Polygons

#### Moufang Planes.

$$\text{---} \cdots \text{---} \oplus \text{---} \cdots \text{---} \oplus \text{---} \cdots \text{---} \quad A_{3d-1}/A_{d-1}^3$$

As explained in Chapter 8 section 5, this is the diagram for a Desarguesian plane over a field  $K$  of finite degree  $d$  (dimension  $d^2$ ) over its centre  $k$ ; if  $d = 1$  this is  $\oplus \text{---} \oplus$  □

$$\begin{array}{c} | \\ \oplus \text{---} | \text{---} | \text{---} | \text{---} \oplus \\ | \end{array} \quad E_6/D_4$$

This is the diagram for a Cayley plane, over a division Cayley algebra  $K$ . The anisotropic part of the diagram (that obtained by deleting the circled nodes) represents an anisotropic quadratic form (no singular subspaces), namely the reduced norm of  $K$ .

#### Moufang Quadrangles - the Classical Cases.

The "classical" Moufang quadrangles all arise from a  $(\sigma, \epsilon)$ -hermitian or pseudo-quadratic form of Witt index 2 on some vector space. For these diagrams it is assumed the vector space has finite dimension  $N$  over a field  $K$ , which in turn has finite degree  $d$  (dimension  $d^2$ ) over its center  $k$ . In all cases except  ${}^2A_n$ ,  $\sigma$  fixes  $k$  and so  $\sigma$  is the identity when  $K$  is commutative.

$$\oplus \text{---} \oplus \cdots \text{---} \text{---} \text{---} \text{---} \text{---} \quad B_n$$

In this case  $K = k$ ,  $\epsilon = 1$ , and we have a quadratic form (of Witt index 2)

in dimension  $N = 2n + 1$ . If  $k$  is a finite field  $n = 2$ ; if  $k$  is  $p$ -adic  $n = 2$  or 3; if  $k = \mathbf{R}$  there is a unique example for each  $n$ ; and for number fields there is no restriction of  $n$ .

If char.  $k = 2$  and  $K$  is a commutative field such that  $K \supset k \supset K^2$  (so  $k$  is not perfect) then the fundamental root groups  $(U_1, U_2)$  can be associated to  $(k, K)$  to provide an exotic form of "mixed type" - see Tits [1976a] (2.5). We assign this the diagram

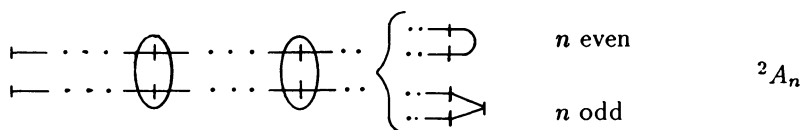

One has  $d \mid n + 1$ , and if  $n + 1 = 4d$  the diagram is Here  $[k : k^\sigma] = 2$ ,  $N = \frac{n+1}{d}$ , and the form is  $(\sigma, 1)$ -hermitian. If  $k$  is finite  $d = 1$  and  $n = 3$  or 4; if  $k$  is  $p$ -adic  $d = 1$  and  $n = 3, 4$ , or 5; if  $k^\sigma = \mathbf{R}$ ,  $d = 1$ ; and if  $k$  is a number field there is no special restriction on  $d$  or  $n$ . □

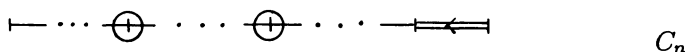

Here  $d = 2^s \mid 2n$ , and  $N = \frac{2n}{d}$ . The form is  $(\sigma, -1)$ -hermitian, and if  $d = 1$ , then  $n = 2$  and the form is symplectic; in this case the diagram is which is the dual of the  $B_2$  case. If  $k$  is finite  $d = 1$ ; if  $k$  is  $p$ -adic  $d = 1$ , or  $d = 2$  and  $n = 4$  or 5; if  $k = \mathbf{R}$  or a number field  $d = 1$  or 2. □

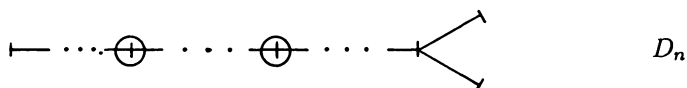

For  $n = 2d$  this is and the case  $n = 4, d = 2$  is the dual of  $n = 4, d = 1$  .

Here  $d = 2^s \mid 2n$ ,  $n \neq 2d + 1$  and  $N = \frac{2n}{d}$ . The form is pseudo-

quadratic. For  $k$  finite there is no (rank 2) case; if  $k$  is  $p$ -adic either  $n = 4$  (and  $d = 1$  or  $2$  - see diagrams), or  $n = 7$  and  $d = 2$ ; if  $k = \mathbf{R}$  then  $d = 1$  and  $n$  is even, or  $n = 4$  and  $d = 2$ ; if  $k$  is a number field either  $n$  is even and  $d = 1$  or  $2$ , or  $n = 7$  and  $d = 2$ .  $\square$

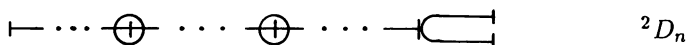

If  $n = 2d + 1$  then  $d = 2$  or  $1$  and we have or the latter being the dual of  ${}^2A_3$ .

Here again,  $d = 2^s \mid 2n$ ,  $N = \frac{2n}{d}$ , and the form is pseudo-quadratic; for a given  $n$ , the distinction between  $D_n$  and  ${}^2D_n$  depends on the discriminant of the form. If  $k$  is finite  $d = 1$  and  $n = 3$ ; if  $k$  is  $p$ -adic either  $d = 1$  and  $n = 3$ , or  $d = 2$  and  $n = 5$  or  $6$ ; if  $k = \mathbf{R}$  either  $d = 1$  and  $n$  is odd, or  $d = 2$  and  $n = 5$ ; if  $k$  is a number field  $d = 1$  or  $2$ .  $\square$

**Moufang Quadrangles - the Exceptional Cases.**



This does not exist over finite fields or  $p$ -adic fields, but does exist over the reals and over number fields. The root group dimensions are 6 and 9.  $\square$

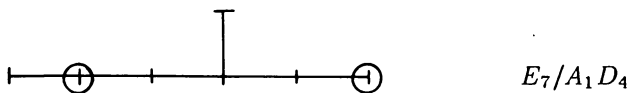

This does not exist over finite fields,  $p$ -adic fields or the reals but does exist over some number fields. The root group dimensions are 17 and 8.  $\square$

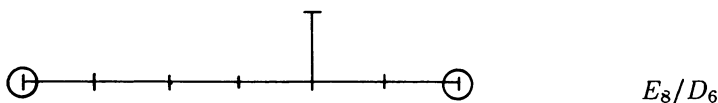

This does not exist over finite,  $p$ -adic or number fields, nor the reals. The root group dimensions are 12 and 33.

## Moufang Hexagons.

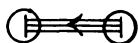
 $G_2$ 

This arises from a split Cayley algebra, and exists for all fields  $k$ ; if char.  $k = 3$  and  $K \supset k \supset K^3$  then the fundamental root groups  $(U_1, U_2)$  can be associated to  $(k, K)$  to provide an exotic form of "mixed type" - see Tits [1976a] (2.5). We assign it the diagram

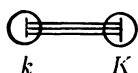
 $G_2$  mixed

□

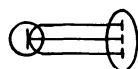
 ${}^3D_4$  and  ${}^6D_4$ 

These arise from a building of type  $D_4$ , taking the chambers fixed under a triality automorphism involving a field automorphism (if there is no field automorphism one gets  $G_2$ ). The fundamental root groups  $(U_1, U_2)$  can be associated to  $(k, K)$  where  $K$  is a separable cubic extension of  $k$  with Galois group  $Z_3$  or  $S_3$ . These cases exist for any field  $k$  having the appropriate Galois extension. □

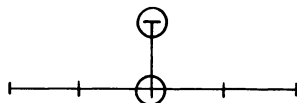
 $E_6/A_2^2$ 

Here  $(U_1, U_2)$  can be associated to  $(k, K)$  where  $K$  is a skew field of degree 3 over its centre  $k$ . They exist for all such skew fields (e.g. for  $k$  any  $p$ -adic field). □

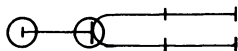
 ${}^2E_6/A_2^2$ 

Here  $(U_1, U_2)$  can be associated to  $(k, K)$  where  $k$  is a commutative field having a quadratic extension  $k'$  over which there is a central division algebra

$D$  of degree 3 admitting an involutory automorphism  $\sigma$  such that  $k = k'^{\sigma}$  and  $K = D^{\sigma}$  has dimension 9 over  $k$ . They exist for all such situations.  $\square$



$E_8/E_6$

Here  $(U_1, U_2)$  can be associated to  $(k, J)$  where  $J$  is a 27-dimensional exceptional Jordan division algebra over the commutative field  $k$ . They exist for all such Jordan algebras.  $\square$

**Remark.** The existence of these Moufang hexagons is a consequence of an explicit construction given by Tits [1976a].

**Moufang Octagons.**

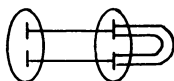

${}^2F_4$

These arise over any commutative field  $K$  of characteristic 2 admitting an automorphism  $\sigma$  whose square is the Frobenius (i.e.  $\sigma^2 : x \rightarrow x^2$ ). The root groups  $U_1$  and  $U_2$  are isomorphic to  $K^+$ , and to the set  $K \times K$  with group structure  $(t, u).(t', u') = (t + t', u + u' + t't^{\sigma})$ .

**Note.** With the exception of  ${}^2F_4$  and the  $B_2$  and  $G_2$  of mixed type, these are the Tits diagrams for simple algebraic groups of relative rank 2 over the field  $k$ . They all appear in the general classification given by Tits [1966].



### APPENDIX 3

#### Non-Discrete Buildings

In Chapters 9 and 10 we examined affine buildings and showed how they arise from a group, such as  $SL_n(K)$ , over a field  $K$  having a discrete valuation  $v$ . More generally one can consider non-discrete valuations  $v : K^\times \rightarrow \mathbf{R}$ , where  $v(ab) = v(a) + v(b)$ , and  $v(a + b) \geq \min\{v(a), v(b)\}$ , in which case Bruhat and Tits [1972] (Chapter 7) define a “non-discrete building” whose “apartments” are affine spaces; it is a topological space, but cannot be regarded as a simplicial complex or chamber system, unless  $v(K^\times)$  is discrete. In this brief appendix we shall do little more than give a definition, and discuss the classification of these objects, which will be called *affine apartment systems*. Further details can be obtained from the paper of Tits [1986a], which has already been used extensively in Chapter 10.

First we need some notation. Let  $\overline{W}$  be a finite Coxeter group, let  $V$  be the vector space of (2.1) on which  $\overline{W}$  acts, and let  $\mathbf{A}$  be the affine space associated to  $V$ . We define  $W$  to be the group of affine isometries of  $\mathbf{A}$  whose vector part is  $\overline{W}$ ; in other words  $\mathbf{R}^n \cdot \overline{W}$  where  $\mathbf{R}^n$  is the translation group of  $\mathbf{A}$ . This notation is exactly that used in [loc. cit.], but notice that  $W$  is *not* a Coxeter group; it is different from the  $W$  in Chapter 10.

A *wall* of  $\mathbf{A}$  means a hyperplane fixed by a reflection of  $W$  (in other words a translate of a wall of  $V$ ); it divides  $\mathbf{A}$  into two *half-apartments*. Again this is different from Chapters 9 and 10 because these walls are everywhere dense in  $\mathbf{A}$ . Similarly one defines *sectors*, *sector-panels* and *sector-faces* of  $\mathbf{A}$  by taking all translates of those in  $V$ .

**Remark.** In Chapters 9 and 10 an affine Coxeter group belonged to an affine diagram, and both  $\tilde{B}_n$  and  $\tilde{C}_n$  give rise to the same  $\overline{W}$ , of type  $C_n$ . The distinction between these cases relies on the distance between adjacent

walls in a parallel class. Here however such walls are everywhere dense and there is no affine diagram, only the spherical diagram for  $\overline{W}$ .

The idea is now to define an object  $(\Delta, \mathcal{F})$  which is a set  $\Delta$  together with a collection  $\mathcal{F}$  of injections of  $\mathbf{A}$  into  $\Delta$  satisfying axioms (A1), ..., (A5) below. For  $f \in \mathcal{F}$ , the subset  $f(\mathbf{A}) \subset \Delta$  will be called an *apartment* of  $(\Delta, \mathcal{F})$ , and a *wall*, *sector*, etc. of  $(\Delta, \mathcal{F})$  will mean the image of a wall, sector, etc. of  $\mathbf{A}$  under some  $f \in \mathcal{F}$ . The conditions are:

- (A1) If  $w \in W$  and  $f \in \mathcal{F}$ , then  $f \circ w \in \mathcal{F}$ .
- (A2) If  $f, f' \in \mathcal{F}$ , then  $X = f^{-1}(f'(\mathbf{A}))$  is closed and convex in  $\mathbf{A}$ , and  $f|_X = f' \circ w|_X$  for some  $w \in W$ .
- (A3) Any two points of  $\Delta$  lie in a common apartment.
- (A4) Any two sectors contain subsectors lying in a common apartment.
- (A5) If  $A_1, A_2, A_3$  are three apartments such that each of  $A_1 \cap A_2$ ,  $A_1 \cap A_3$  and  $A_2 \cap A_3$  is a half-apartment then  $A_1 \cap A_2 \cap A_3 \neq \emptyset$ .

**Remarks.** 1. (A2) and (A3) allow one to define a metric  $d$ : given two points  $p$  and  $q$  of  $\Delta$ , take  $d(p, q)$  to be the Euclidean distance between  $p$  and  $q$  in any apartment containing both.

2. An alternative to (A5) is:

(A5') Given  $f \in \mathcal{F}$  and a point  $p \in f(\mathbf{A})$  there is a retraction  $\rho : \Delta \rightarrow f(\mathbf{A})$  such that  $\rho^{-1}(p) = \{p\}$  and the restriction to each apartment diminishes distances.

Both (A5) and (A5') were suggested by Tits as replacements for the (A5) given in Tits [1986a] which, as pointed out by K. Brown, cannot be used in Proposition 17.1 of that paper. In fact the (A5) above was given by Tits in the original lectures on which [loc. cit.] was based; it can be shown to be a consequence of (A5').

**Example 1.** Take an affine building  $\Delta$  with a system of apartments  $\mathcal{A}$ . Treat  $\Delta$  as a topological space via its simplicial structure, and let  $\mathbf{A}$  be the Coxeter complex treated as an affine space. For each  $A \in \mathcal{A}$  take an isometry  $f$  from  $\mathbf{A}$  to  $A$ , and let  $\mathcal{F}$  denote the set of all  $f \circ w$  for  $w \in W$  ( $W$  being as above, not the Coxeter group). Then  $(\Delta, \mathcal{F})$  satisfies (A1) - (A5): in fact (A1) is immediate from the definition of  $\mathcal{F}$ ; (A2) is Exercise 9 of Chapter 9; (A3) and (A4) are immediate from conditions (i) and (ii) for  $(\Delta, \mathcal{A})$  at the beginning of Chapter 10; and finally (A5) is Exercise 6 in Chapter 10.

**Example 2.**  $\mathbf{A} = \mathbf{R}$  (i.e.  $n = 1$ ,  $\overline{W} \cong Z_2$ ). Following [loc. cit.] we shall simply call  $T = (\Delta, \mathcal{F})$  a *tree* (it is also sometimes called an  $\mathbf{R}$ -tree). Each

apartment is a copy of the real line, and two apartments intersect either in the empty set or a closed line segment; in particular between any two points  $p$  and  $q$  there is a unique line segment of length  $d(p, q)$ .

As in Chapter 10 section 1, a tree  $T$  determines a projective valuation  $\omega_T$  on its set  $T^\infty$  of ends. Conversely the following proposition (combining Propositions 2 and 3 of [loc. cit.]) provides a generalization of 10.2.

(A.16) PROPOSITION. *For any set  $E$  having at least 3 elements and a projective valuation  $\omega$  (in the sense of Chapter 10 section 1), one can identify  $E$  with the ends of a tree  $T$  such that  $\omega = \omega_T$ ; moreover  $E$  and  $\omega$  determine  $T$  up to unique isomorphism.  $\square$*

The proof of uniqueness is given in [loc. cit.] section 16, using a method which can be adapted to prove the existence of  $T$ , given  $\omega$ . The idea is that for each pair  $a, b \in E$  one takes a model  $A(a, b)$  of the real line, whose points are functions  $x$  from  $E - \{a, b\}$  to  $\mathbb{R}$  satisfying  $x(d) - x(c) = \omega(a, b; c, d)$ . The tree is then obtained as the disjoint union of all sets  $A(a, b)$ , factored out by an equivalence relation.

### The Building at Infinity.

As in Chapter 9, one defines two sector-faces to be *parallel* if they are at bounded distance, and it is then straightforward to verify, as in Chapters 9 and 10, that the parallel classes of sector-faces of  $(\Delta, \mathcal{F})$  are the simplexes of a spherical building  $(\Delta, \mathcal{F})^\infty$  "at infinity". Although  $(\Delta, \mathcal{F})$  may be non-discrete,  $(\Delta, \mathcal{F})^\infty$  is a building in the usual sense of being a chamber system: its chambers are parallel classes of sectors, and its panels are parallel classes of sector-panels.

Much of the work in Chapter 10 carries through with very little change. As in section 2 of that Chapter, for each wall  $m$  of  $(\Delta, \mathcal{F})^\infty$ , there is a tree  $T(m)$  (in the sense of this appendix); its points are the walls  $M$  of  $(\Delta, \mathcal{F})$  in the direction  $m$ , and its ends correspond to the roots of  $(\Delta, \mathcal{F})^\infty$  having wall  $m$ . Letting  $St(m)$  denote this set of roots,  $T(m)$  provides a projective valuation  $\omega_m$  of  $St(m)$ . Similarly for a panel  $\pi$  of  $(\Delta, \mathcal{F})^\infty$  one obtains a projective valuation  $\omega_\pi$  on  $St(\pi)$ . The analogue of (10.5) holds, namely that  $(\Delta, \mathcal{F})^\infty$  together with the  $\omega_m$  or  $\omega_\pi$  determines  $(\Delta, \mathcal{F})$  up to unique isomorphism.

Also, as in Chapter 10 section 3, if  $(\Delta, \mathcal{F})^\infty$  is Moufang, then one obtains a set of root data with valuation  $(\varphi_a)$ . Moreover each equivalence class of root data with valuation gives rise to an affine apartment system  $(\Delta, \mathcal{F})$ , but here the work of Chapter 10 is not sufficient. In the discrete

case, section 4 of that Chapter gave an explicit construction of an affine BN-Pair, but in general  $(\Delta, \mathcal{F})$  cannot be realized as a chamber system so there is no such BN-Pair. However the construction of  $(\Delta, \mathcal{F})$  is given in Chapter 7 of Bruhat-Tits [1972].

If  $(\Delta, \mathcal{F})$  has dimension  $\geq 3$ , and the diagram (of  $\overline{W}$ ) is connected, then  $(\Delta, \mathcal{F})^\infty$  has rank  $\geq 3$  (and the same diagram) and is therefore Moufang. As in the discrete case we obtain the following theorem.

(A.17) THEOREM. *Every affine apartment system of dimension  $n \geq 3$ , having a connected diagram, arises from a spherical building of rank  $n$  over a field  $K$  with a valuation  $v : K^\times \rightarrow \mathbf{R}$ . Furthermore these apartment systems are classified by equivalence classes of root data with valuation.  $\square$*

In fact root data with valuation can be classified, at least in the case of rank  $\geq 3$  considered here, and a necessary and sufficient condition can be given for a spherical building over  $K$  with valuation  $v$  to lead to an affine apartment system. More details are available in Chapter 10, and also of course in Tits [1986a].

## APPENDIX 4

### Topology and the Steinberg Representation

In Chapter 3 Buildings were defined in terms of chamber systems, and in the finite rank case they can also be regarded as simplicial complexes, and hence acquire a topological structure. In the spherical case each apartment becomes a triangulation of a sphere, and the building has the homotopy type of a bouquet of spheres. In the affine case with a connected diagram each apartment becomes a triangulation of Euclidean space and the building is contractible - see the Theorems below.

However in general the simplicial structure is not necessarily appropriate. For example in the affine case with a non-connected diagram it is better to regard the Coxeter complex as a product of Euclidean spaces (one for each component of the diagram) in which a chamber is a direct product of simplexes. For example the Coxeter complex of type  $\tilde{A}_1 \times \tilde{A}_1 \times \tilde{A}_1$  would be the tessellation of  $\mathbf{R}^3$  by cubes. A cube has, of course, six faces; these correspond to the six panels of a chamber, opposite faces corresponding to the same  $\tilde{A}_1$  subdiagram. The building in this case would have dimension 3 (though if we treat each chamber as a simplex the dimension is 5); in the terminology of Bruhat-Tits [1972] it is a *polysimplicial complex*. We shall not discuss the general case but refer to Davis [1983], which contains a discussion of topological spaces associated to Coxeter groups, and uses them to construct some interesting aspherical manifolds. For the remainder of this appendix we stick to the spherical and affine case.

#### Homotopy Type.

If  $X$  is a metric space and  $x$  is a point of  $X$  such that for every point  $y$  there is a unique geodesic joining  $x$  and  $y$  then  $X$  is contractible in a very simple way. At time  $t$  ( $0 \leq t \leq 1$ ) send  $y$  to  $y_t$ , where  $y_t$  is the point on the unique geodesic from  $x$  to  $y$  such that  $d(x, y_t) = t \cdot d(x, y)$ . When this is the case we shall call  $X$  *geodesically contractible*.

(A.18) THEOREM. *An affine building  $\Delta$  is contractible.*

PROOF: Let  $x$  be some given point of  $\Delta$ . If  $y$  is any point, the apartments containing  $x$  and  $y$  intersect in a convex set (Exercise 8 of Chapter 9), and hence there is a unique geodesic from  $x$  to  $y$ , as this is true in each such apartment. Thus  $\Delta$  is geodesically contractible.  $\square$

**Remark.** This theorem and its proof apply equally well to the affine apartment systems of Appendix 3.

(A.19) THEOREM. *A spherical building  $\Delta$  of rank  $n$  is homotopic to a bouquet of  $(n - 1)$ -spheres, and the number of spheres equals the number of chambers opposite a given chamber.*

PROOF: Fix a chamber  $c$  and let  $x$  be its barycentre. Each apartment  $A$  containing  $c$  is a sphere; it has a unique chamber  $c'$  opposite  $c$ , and  $A - \{c'\}$  is geodesically contractible to  $x$ . Now remove from  $\Delta$  all chambers opposite  $c$ , and call the remaining complex  $\Delta'$ . Since the intersection of two apartments is convex,  $\Delta'$  is geodesically contractible to  $x$ . Therefore  $\Delta$  is homotopic to the set of chambers opposite  $c$  with their boundaries identified to  $x$ . After this identification each chamber becomes a sphere, and the result follows.  $\square$

**Homology and the Steinberg Representation.**

It follows from Theorem (A.19) that if  $\Delta$  is a building of spherical type and rank  $n$ , then its integral homology is:

$$H_i(\Delta, \mathbf{Z}) = \begin{cases} \mathbf{Z} & \text{if } i = 0 \\ 0 & \text{if } i \neq 0, n - 1 \\ \mathbf{Z} \oplus \dots \oplus \mathbf{Z} & \text{if } i = n - 1, \text{ where the number of copies of } \mathbf{Z} \text{ equals the number of apartments containing a given chamber} \end{cases}$$

Now let  $G$  be a finite group of Lie type having rank  $n$  and characteristic  $p$ , and let  $\Delta$  be its building (see Chapter 8 section 6). Then  $H_{n-1}(\Delta)$  provides a representation for  $G$ , called the *Steinberg representation*. It was originally discovered in a different form by Steinberg [1956] and [1957], and the interpretation via homology is due to work of Curtis [1966] and Tits and Solomon [1969]. For some applications of this representation, and an extensive list of references, see Humphreys [1987].

To study the action of  $G$  on  $\Delta$ , we regard  $\Delta$  as a simplicial complex, and let

$$C_{n-1} \xrightarrow{\partial_{n-1}} \dots \longrightarrow C_1 \xrightarrow{\partial_1} C_0$$

be the associated chain complex. As usual we write  $Z_r = \text{Ker } \partial_r$ ,  $B_r = \text{Im } \partial_{r+1}$ ,  $B_n = Z_0 = 0$ , and  $H_r = Z_r/B_r$ . We then let  $\gamma_r, \zeta_r, \beta_r$  and  $\eta_r$  be the characters of  $G$  on  $C_r, Z_r, B_r$  and  $H_r$  respectively. Since  $H_r = Z_r/B_r$  we have

$$\eta_r = \zeta_r - \beta_r$$

and since  $C_r/\text{Ker } \partial_r \cong \text{Im } \partial_r$  we have

$$\gamma_r - \zeta_r = \beta_{r-1}.$$

(A.20) PROPOSITION (HOPF TRACE FORMULA).

$$\sum_{r=0}^{n-1} (-1)^r \gamma_r = \sum_{r=0}^{n-1} (-1)^r \eta_r.$$

PROOF: Indeed  $\Sigma(-1)^r(\gamma_r - \eta_r) = \Sigma(-1)^r(\beta_{r-1} + \beta_r) = \beta_{-1} + \beta_n = 0$ .  $\square$

If  $G$  is a group and  $H$  a subgroup, the permutation character of  $G$  on cosets of  $H$  is denoted  $1_H^G$ . Notice that  $\gamma_r$  is the sum of permutation characters  $1_{P_J}^G$  for which  $P_J$  corresponds to a face of dimension  $r$  (in which case  $|J| = n - 1 - r$ ). Therefore

$$\sum_{r=0}^{n-1} (-1)^r \gamma_r = (-1)^{n-1} \sum_{J \subsetneq I} (-1)^{|J|} 1_{P_J}^G.$$

Moreover knowing  $H_i(\Delta, \mathbf{Z})$  we have  $\eta_0 = 1$ ,  $\eta_i = 0$  for  $i \neq 0, n - 1$ , and  $\eta_{n-1} = St$ , the Steinberg character. Therefore by (A.20):

$$1 + (-1)^{n-1} St = (-1)^{n-1} \sum_{J \subsetneq I} (-1)^{|J|} 1_{P_J}^G$$

Since  $P_I = G$ , we have  $1_{P_I}^G = 1$ , hence

$$St = \sum_{J \subsetneq I} (-1)^{|J|} 1_{P_J}^G.$$

This formula for the Steinberg character was discovered by Curtis [1966], using Steinberg's original definition of the representation.

(A.21) THEOREM. *The Steinberg representation is irreducible, and if  $K$  is a field of characteristic  $p$ , then  $H_{n-1}(\Delta, K)$  is a projective module for  $G$ .*

PROOF: First consider the Coxeter group  $W$  acting on the Coxeter complex which we think of as an  $(n - 1)$ -sphere  $S$ . Clearly  $H_{n-1}(S)$  provides a 1-dimensional (hence irreducible) representation of  $W$ ; let  $\epsilon$  denote its character - this is the “reflection character” defined by  $\epsilon(r_i) = -1$  for each  $i \in I$ . As in the case of  $St$  above, we have the formula:

$$\epsilon = \sum_{J \subseteq I} (-1)^{|J|} 1_{W_J}^W$$

Furthermore, using  $(\ , \ )$  for the inner product of characters, we have

$$(1_{P_J}^G, 1_{P_K}^G) = (1_{W_J}^W, 1_{W_K}^W).$$

This is because the inner product of two permutation characters  $1_{H_1}^G$  and  $1_{H_2}^G$  counts the number of double cosets  $H_1 \backslash G / H_2$ , and from (5.4) (iv) we have a bijection between  $P_J \backslash G / P_K$  and  $W_J \backslash W / W_K$ . Therefore  $(St, St) = (\epsilon, \epsilon)$ , and since  $\epsilon$  is irreducible we have  $(\epsilon, \epsilon) = 1$ , showing that  $St$  is irreducible.

To show that  $M = H_{n-1}(\Delta, K)$  is a projective  $G$ -module, we first consider it as a  $U$ -module  $M_U$ . By (6.15)  $U$  acts simple-transitively on the set of chambers opposite the chamber  $c$  stabilized by  $U$ , and hence also on the set of apartments containing  $c$ . These apartments form a basis for  $M$ , so  $M_U$  is a free  $U$ -module. Therefore the induced module  $M_U^G$  is a free  $G$ -module, and it suffices to prove  $M$  is a direct summand of  $M_U^G$  (this is a standard result in representation theory but we give a direct proof). Let  $1 = x_1, \dots, x_r$  be a set of coset representatives for  $U$  in  $G$ . The projection  $\theta : M_U^G \rightarrow M_U$  sending  $\Sigma x_i \otimes m_i$  to  $m_1$  is a  $U$ -module homomorphism, and its kernel provides a complement to  $M_U$  as a submodule of  $M_U^G$ . Since  $|G : U| \neq 0$  in  $K$  we can define  $\tilde{\theta} = \frac{1}{|G : U|} \sum_i x_i \theta x_i^{-1}$ ; it is a  $G$ -module homomorphism from  $M_U^G$  to  $M$ , and its kernel provides a  $G$ -module complement for  $M$  in  $M_U^G$ . □

**Cohomology with Compact Support.** By (A.18) an affine building  $\Delta$  is contractible, so its cohomology  $H^i(\Delta)$  is zero for  $i > 0$ . However  $\Delta$  is not compact, and the cohomology  $H_c^i(\Delta)$  with compact support is not zero. In the locally finite case,  $\Delta$  is locally compact and it can be compactified by adjoining the building  $\Delta^\infty$  at infinity, but one must be careful about



the topology. Let  $S$  be a sector and let  $S_1, S_2, \dots$  be sectors having a sector-panel in common with  $S$ , and such that the intersections  $S \cap S_1, S \cap S_2, \dots$  become increasingly large, and  $\lim_{n \rightarrow \infty} S_n = S$ .

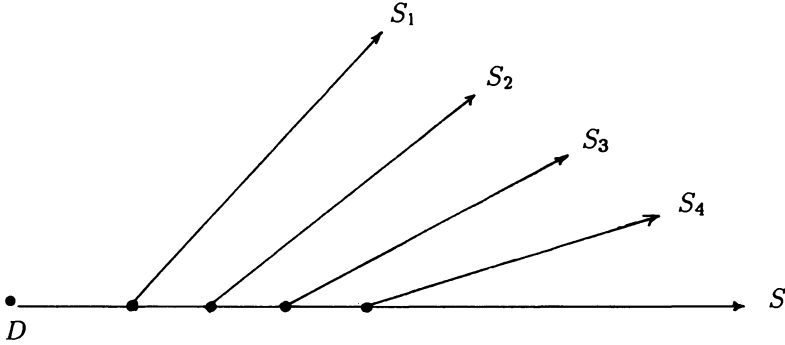

When we compactify  $\Delta$  by adjoining  $\Delta^\infty$ , we need a topology in which the sequence of chambers  $S_1^\infty, S_2^\infty, \dots$  gets closer and closer to  $S^\infty$ . Such a topology was given in the  $\tilde{A}_1$  case (i.e. when  $\Delta$  is a tree) in Exercise 10 of Chapter 10, and it can be extended to cases of higher rank. When  $\Delta$  is locally finite (more precisely if  $\text{card } St(\pi) \leq$  some finite number  $s$ , for all panels  $\pi$  of  $\Delta$ ), this topology makes  $\Delta^\infty$  compact.

The locally finite case arises from algebraic groups over a local field  $K$ , namely  $\mathbf{F}_q((t))$  or a  $p$ -adic field - see (10.25). This is the case treated by Borel and Serre [1976] who show in their Theorem 5.4 that for  $\bar{\Delta} = \Delta \cup \Delta^\infty$  there is a unique topology having the desired properties. The space  $\bar{\Delta}$  is compact and contractible; its boundary  $\partial\bar{\Delta}$  is  $\Delta^\infty$  with the topology discussed in the paragraph above.

For cohomology with compact support one has a long exact sequence

$$\dots \rightarrow H_c^i(\bar{\Delta} - \partial\bar{\Delta}) \rightarrow \tilde{H}^i(\bar{\Delta}) \rightarrow \tilde{H}^i(\partial\bar{\Delta}) \rightarrow H_c^{i+1}(\bar{\Delta} - \partial\bar{\Delta}) \rightarrow \dots$$

where  $\tilde{H}^i = H^i$  for  $i \neq 0$  is "reduced cohomology". The fact that  $\bar{\Delta} - \partial\bar{\Delta} = \Delta$ , and  $\bar{\Delta}$  is contractible (so  $\tilde{H}^i(\bar{\Delta}) = 0$ ) gives:

$$H_c^{i+1}(\Delta) \cong \tilde{H}^i(\partial\bar{\Delta})$$

Borel and Serre [loc. cit.] 2.6 also prove that

$$\tilde{H}^i(\partial\bar{\Delta}) = \begin{cases} C_c^\infty(U; \mathbf{Z}) & \text{if } i = n - 1 \\ 0 & \text{otherwise} \end{cases}$$

where  $C_c^\infty$  means  $C^\infty$ -functions with compact support. Here  $U$  can be thought of as a set of points in bijective correspondence with the set of chambers of  $\Delta^\infty$  opposite a given chamber; it inherits a topology from the topology of  $\partial\overline{\Delta}$ . Alternatively, think of  $U$  as a group, as in Chapter 6 section 4, in which case it acquires a topology as a group of matrices over the locally compact field  $K$ . To summarize, we have

$$H_c^i(\Delta) = \begin{cases} C_c^\infty(U; \mathbf{Z}) & \text{if } i = n \\ 0 & \text{otherwise} \end{cases}$$

where  $\Delta$  is an affine building of dimension  $n$  over a local field.

## APPENDIX 5

### Finite Coxeter Groups (i.e. of spherical type)

Diagram	$ W $	Shape of Group (Atlas Notation)
$A_n$ $\circ \text{---} \circ \text{---} \dots \text{---} \circ \text{---} \circ$	$(n + 1)!$	$S_{n+1}$
$C_n$ $\circ \text{---} \circ \text{---} \dots \text{---} \circ \text{=} \circ$	$2^n n!$	$2^n S_n$
$D_n$ $\circ \text{---} \circ \text{---} \dots \text{---} \circ \begin{array}{l} / \circ \\ \backslash \circ \end{array}$	$2^{n-1} n!$	$2^{n-1} S_n$
$E_6$ $\circ \text{---} \circ \text{---} \circ \begin{array}{l}   \circ \\   \circ \end{array} \text{---} \circ \text{---} \circ$	$2^7 3^4 5$	$0_6^-(2).2$
$E_7$ $\circ \text{---} \circ \text{---} \circ \text{---} \circ \begin{array}{l}   \circ \\   \circ \end{array} \text{---} \circ \text{---} \circ$	$2^{10} 3^4 5.7$	$2 \times 0_7(2)$
$E_8$ $\circ \text{---} \circ \text{---} \circ \text{---} \circ \begin{array}{l}   \circ \\   \circ \end{array} \text{---} \circ \text{---} \circ \text{---} \circ$	$2^{14} 3^5 5^2 7$	$2.0_8^+(2).2$
$F_4$ $\circ \text{---} \circ \text{=} \circ \text{---} \circ$	1152	$2^3 : S_4 : S_3$
$H_3$ $\circ \text{---} \circ \text{---} \overset{5}{\circ}$	120	$2 \times A_5$
$H_4$ $\circ \text{---} \circ \text{---} \circ \text{---} \overset{5}{\circ}$	$(120)^2$	$2A_5 : (2 \times A_5)$
$G_2(m)$ $\circ \text{---} \overset{m}{\circ} \text{---} \circ$	$2m$	$D_{2m}$

## APPENDIX 6

### Finite Buildings and Groups of Lie Type

Type of Building	Type of Group	Simple Group (Atlas notation, where different)	Parameters
$A_n$	$A_n(q)$	$L_{n+1}(q)$	$\frac{q^n - 1}{q - 1}$ $\circ \text{ --- } \dots \quad \dots \text{ --- } \circ$ $q \qquad \qquad \qquad q$
$C_n$	$B_n(q)$	$O_{2n+1}(q)$	$\frac{q^{2n} - 1}{q - 1} \qquad \qquad \qquad (q+1)(q^2+1) \dots (q^n+1)$ $\circ \text{ --- } \dots \quad \dots \text{ --- } \circ = \circ$ $q \qquad \qquad \qquad q \qquad q$
$C_n$	$C_n(q)$	$S_{2n}(q)$	$\frac{q^{2n} - 1}{q - 1} \qquad \qquad \qquad (q+1)(q^2+1) \dots (q^n+1)$ $\circ \text{ --- } \dots \quad \dots \text{ --- } \circ = \circ$ $q \qquad \qquad \qquad q \qquad q$
$C_n$	${}^2A_{2n-1}(q)$	$U_{2n}(q)$	$\frac{(q^{2n-1}+1)(q^{2n}-1)}{q^2-1} \qquad \qquad \qquad (q+1)(q^3+1) \dots (q^{2n-1}+1)$ $\circ \text{ --- } \dots \quad \dots \text{ --- } \circ = \circ$ $q^2 \qquad \qquad \qquad q^2 \qquad q$
$C_n$	${}^2A_{2n}(q)$	$U_{2n+1}(q)$	$\frac{(q^{2n+1}+1)(q^{2n}-1)}{q-1} \qquad \qquad \qquad (q^3+1)(q^5+1) \dots (q^{2n+1}+1)$ $\circ \text{ --- } \dots \quad \dots \text{ --- } \circ = \circ$ $q^2 \qquad \qquad \qquad q^2 \qquad q^3$

Type of Building	Type of Group	Simple Group (Atlas notation, where different)	Parameters
$C_n$	${}^2D_{n+1}(q)$	$O_{2n+2}^-(q)$	$\frac{(q^{n+1}+1)(q^n-1)}{q-1} \quad \dots \quad \dots \quad \frac{(q^{n+1}+1)(q^{2n}-1)}{q^2-1}$
$D_n$	$D_n(q)$	$O_{2n}^+(q)$	$\frac{(q^{n-1}+1)(q^n-1)}{q-1} \quad \dots \quad \dots \quad \frac{(q+1)(q^2+1)\dots(q^{n-1}+1)}{q-1}$
$E_6$	$E_6(q)$		$\frac{(q^9-1)(q^8+q^4+1)}{q-1}$
$E_7$	$E_7(q)$		$\frac{(q^5+1)(q^9+1)(q^{14}-1)}{q-1} \quad \dots \quad \dots \quad \frac{(q^8+q^4+1)(q^{12}+q^6+1)(q^{14}-1)}{q-1}$
$E_8$	$E_8(q)$		$\frac{(q^6+1)(q^{12}+1)(q^{10}+1)(q^{30}-1)}{q-1}$

Type of Building	Type of Group	Simple Group (Atlas notation, where different)	Parameters
$F_4$	$F_4(q)$		$\frac{(q^4+1)(q^{12}-1)}{q-1}$ $\circ \text{---} \circ \text{=} \circ \text{---} \circ$ $q \quad q \quad q \quad q$
$F_4$	${}^2E_6(q)$		$\frac{(q^4+1)(q^6-q^3+1)(q^{12}-1)}{q-1}$ $\frac{(q^5+1)(q^9+1)(q^{12}-1)}{q^2-1}$ $\circ \text{---} \circ \text{=} \circ \text{---} \circ$ $q \quad q \quad q^2 \quad q^2$
$G_2$	$G_2(q)$		$\frac{(q+1)(q^4+q^2+1)}{6}$ $\circ \text{-----} \circ$ $q \quad q$
$G_2$	${}^3D_4(q)$		$\frac{(q^3+1)(q^8+q^4+1)}{q^3}$ $\frac{(q+1)(q^8+q^4+1)}{q}$ $\circ \text{-----} \circ$ $q^3 \quad q$
$I_2(8)$	${}^2F_4(q)$		$\frac{(q+1)(q^3+1)(q^6+1)}{q}$ $\frac{(q^2+1)(q^3+1)(q^6+1)}{q^2}$ $\circ \text{-----} \circ \quad q = 2^{\text{odd}}$ $q \quad q^2$
$A_1$	${}^2B_2(q)$	$Sz(q)$	$q^2+1 \text{ points} \quad q = 2^{\text{odd}}$
$A_1$	${}^2G_2(q)$	$Ree(q)$	$q^3+1 \text{ points} \quad q = 3^{\text{odd}}$

The number of chambers per panel is  $s+1$ , where  $s$  is shown below the node of the appropriate type, or if nothing is shown,  $s = q$ . The number above a node is the number of vertices of the appropriate cotytle.

## Bibliography

- E. ARTIN, Geometric Algebra, Interscience, New York 1957.
- A. BOREL AND J.-P. SERRE, Cohomologie d'immeubles et de groupes  $S$ -arithmétiques, *Topology*, **15**(1976), 211-232.
- N. BOURBAKI, Groupes et Algèbres de Lie, Ch.4, 5 et 6. Hermann, Paris 1968, Masson, Paris 1981.
- K.S. BROWN, Buildings, Springer-Verlag 1989.
- R.H. BRUCK AND E. KLEINFELD, The Structure of Alternative Division Rings, *Proc. Amer. Math. Soc.*, **2**(1951), 878-890.
- F. BRUHAT AND J. TITS, Groupes réductifs sur un corps local, I. Données radicielles valuées, *Publ. Math. I.H.E.S.*, **41**(1972). 5-252; II Schémas en groupes, Existence d'une donnée radicielle valuée, *Publ. Math. I.H.E.S.* **60**(1984), 5-184.
- F. BUEKENHOUT AND E.E. SHULT, On the Foundations of Polar Geometry, *Geometriae Dedicata*, **3**(1974), 155-170.
- R.W. CARTER, Simple Groups of Lie Type, Wiley-Interscience 1962.
- H.S.M. COXETER, [1934] Discrete Groups generated by Reflections, *Ann. of Math.*, **35**(1934), 588-621.
- H.S.M. COXETER, [1947] Regular Polytopes, 1947, 3rd edition - Dover Publications 1973.
- C.W. CURTIS, [1964] Groups with a Bruhat decomposition, *Bull. Amer. Math. Soc.*, **70**(1964), 357-360.
- C.W. CURTIS, [1966] The Steinberg character of a finite group with a  $(B, N)$ -Pair, *J. Algebra*, **4**(1966), 433-441.
- M.W. DAVIS, Groups generated by reflections and aspherical manifolds not covered by Euclidean space, *Annals of Math.*, **117**(1983), 293-324.
- J.R. FAULKNER, Steinberg Relations and Coordinatization of Polygonal Geometries, *Memoirs Am. Math. Soc.*, vol.10, no.185, 1977.

W. FEIT AND G. HIGMAN, The nonexistence of certain generalized polygons, *J. Algebra*, **1**(1964), 114-131.

W. FEIT AND J. TITS, Projective representations of minimum degree of group extensions, *Canad. J. Math.*, **30**(1978), 1092-1102.

P. FONG AND G. SEITZ, Groups with a (B,N)-Pair of Rank 2, I, II, *Inventiones Math.* **21**(1973), 1-57, and **24**(1974), 191-239.

D. GRAYSON, Finite generation of  $K$ -groups of a curve over a finite field, in *Algebraic K-Theory I* (Conference Proc., Oberwolfach 1980), Springer Lecture Notes **966**, (1982), 69-90

W. HAEMERS, Eigenvalue Techniques in Design and Graph Theory, Proefschrift, *Mathematisch Centrum*, Amsterdam 1979.

D. HIGMAN, Invariant Relations, Coherent Configurations and Generalized Polygons, pp.247-263 in *Combinatorics* part 3 (ed.M.Hall and J.Van Lint), Reidel, Dordrecht 1975.

J.E. HUMPHREYS, The Steinberg Representation, *Bull. Amer. Math. Soc.*, **16**(1987), 247-263.

N. IWAHORI AND H. MATSUMOTO, On some Bruhat decomposition and the structure of the Hecke ring of a  $p$ -adic Chevalley group, *Publ. I.H.E.S.*, **25**(1965), 5-48.

W.M. KANTOR, [1985] Some exceptional 2-adic buildings, *J. Algebra*, **92**(1985), 208-223.

W.M. KANTOR, [1986] Generalized Polygons, SCABs and GABs, in *Lecture Notes in Mathematics*, **1181** (Buildings and the Geometry of Diagrams, Como 1984), Springer-Verlag 1986, 79-158.

W.M. KANTOR, R. LIEBLER, AND J. TITS, On discrete chamber-transitive automorphism groups of affine buildings, *Bull. Amer. Math. Soc.*, **16**(1987), 129-133.

P. KÖHLER, TH. MEIXNER AND M. WESTER, [1984] The affine building of type  $\tilde{A}_2$  over a local field of characteristic 2, *Archiv Math.*, **42**(1984), 400-407.

P. KÖHLER, TH. MEIXNER AND M. WESTER, [1985] The 2-adic building of type  $\tilde{A}_2$  and its finite projections, *J. Comb. Th. A.*, **38**(1985), 203-209.

V. LANDAZURI AND G. SEITZ, On the minimal degrees of projective representations of the finite Chevalley groups, *J. Algebra*, **32**(1974), 418-443.

I.G. MACDONALD, Spherical Functions on a Group of  $p$ -adic type, Ramanujan Inst. Publications, **2** (University of Madras), 1971.

R. MOODY AND K. TEO, Tits systems with crystallographic Weyl groups, *J. Algebra*, **21**(1972), 178-190.



- M.A. RONAN, [1986] A Construction of Buildings with no Rank 3 Residues of Spherical Type, in *Lecture Notes in Mathematics*, **1181** (Buildings and the Geometry of Diagrams, Como 1984), Springer-Verlag, 1986, 159-190.
- M.A. RONAN, [1989] Buildings: Main Ideas and Applications, to appear in *Bull. London Maths. Soc.*
- M.A. RONAN AND J. TITS, Building Buildings, *Math. Annalen*, **278** (1987), 291-306.
- J.-P. SERRE, [1971] Cohomologie des groupes discrets, Prospects in Mathematics, *Ann. of Math. Studies*, **70**, Princeton Univ. Press, Princeton 1971.
- J.-P. SERRE, [1962/79] Corps Locaux, Hermann, Paris 1962. English translation: Local Fields, Springer-Verlag, 1979.
- J.-P. SERRE, [1977/80] Arbres, Amalgames, *SL<sub>2</sub>: Astérisque*, **46**(1977). English translation: Trees, Springer-Verlag, 1980.
- L. SOLOMON, The Steinberg character of a finite group with a *BN*-Pair, in Theory of Groups (ed. Brauer and Sah), Benjamin, New York 1969, 213-221.
- R. STEINBERG, Prime power representations of finite linear groups I; II, *Can. J. Math.*, **8**(1956), 580-581; **9**(1957), 347-351.
- J. TITS, [1962] Théorème de Bruhat et sous-groupes paraboliques, *C.R. Acad. Sci., Paris Ser. A*, **254**(1962), 2910-2912.
- J. TITS, [1966] Classification of algebraic semi-simple groups, in *Proc. Symp. Pure Math.* vol. 9 (Algebraic Groups and Discontinuous Subgroups, Boulder 1965) *Am. Math. Soc.* 1966, 33-62.
- J. TITS, [1968] Le Problème des mots dans les groupes de Coxeter. *Ist. Naz. Alta Mat., Symposia Math.*, **1**(1968), 175-185.
- J. TITS, [1974] Buildings of Spherical Type and Finite *BN*-Pairs, *Lecture Notes in Mathematics*, **386**, Springer-Verlag (1974).
- J. TITS, [1976a] Classification of Buildings of Spherical Type and Moufang Polygons: A survey, in *Atti. Coll. Intern. Teorie Combinatorie*, Accad. Naz. Lincei, Rome, 1973 vol.1 (1976), 229-246.
- J. TITS, [1976b] Quadrangles de Moufang, I. Preprint, Paris, 1976.
- J. TITS, [1976/79] Non-existence de certains polygones généralisés, I, II. *Inventiones Math.* **36** (1976), 275-284; **51**(1979), 267-269.
- J. TITS, [1977] Endliche Spiegelungsgruppen, die als Weylgruppen auftreten, *Inventiones Math.*, **45**(1977), 283-295.
- J. TITS, [1979] Reductive Groups over Local Fields, in *Proc. Symp. Pure Math.* vol. 33 part 1 (Automorphic Forms, Representations and *L*-Functions, Corvallis 1977) *Am. Math. Soc.*, 1979, 29-69.

- J. TITS, [1981] A Local Approach to Buildings, in *The Geometric Vein* (Coxeter Festschrift), Springer-Verlag, 1981, 317-322.
- J. TITS, [1983] Moufang Octagons and the Ree Groups of Type  ${}^2F_4$ , *Amer. J. of Math.*, **105** (1983), 539-594.
- J. TITS, [1985] Groups and Group Functors attached to Kac-Moody data, *Lecture Notes in Mathematics*, **1111** (Arbeitstagung, Bonn 1984), Springer-Verlag, 1985, 193-223.
- J. TITS, [1986a] Immeubles de type affine, in *Lecture Notes in Mathematics*, **1181**, (Buildings and the Geometry of Diagrams, Como 1984), Springer-Verlag, 1986, 159-190.
- J. TITS, [1986b] Buildings and Group Amalgamations, *London Maths. Soc. Lecture Notes*, **121** (Proceedings of Groups - St. Andrews 1985), Cambridge Univ. Press, 1986, 110-127.
- J. TITS, [1987] Uniqueness and Presentation of Kac-Moody Groups over Fields, *J. Algebra*, **105**(1987), 542-573.
- H. VAN MALDEGHEM, [1987] Non-classical Triangle Buildings, *Geo. Ded.*, **24**(1987), 123-206.
- H. VAN MALDEGHEM, [1988] Valuations on PTR's induced by Triangle Buildings, *Geo. Ded.*, **26**(1988), 29-84.
- R. WEISS, The Nonexistence of certain Moufang Polygons, *Inventiones Math.*, **51**(1979), 261-266.
- E. WITT, Spiegelungsgruppen und Aufzählung halbeinfacher Liescher Ringe, *Hamburger Abhandlungen*, **14**(1941), 289-322.

## INDEX OF NOTATION

$I$	1	$U_\alpha$	66,74,146	$\kappa(a, b, c)$	130
$\tilde{i}$	1	$E_2(c)$	67	$\omega(a, b; c, d)$	131
$J$	2	$[U_\alpha, U_\beta]$	68	$(\omega 1) - (\omega 3)$	131
$St(\sigma)$	3	$[\alpha, \beta]$	69,73	$St(m)$	133
$r_i$	9	$(\alpha, \beta)$	70,74	$T(m)$	133
$m_{ij}$	9	$U_\Psi$	70	$T(\pi)$	134
$M$	9	$\Phi$	73	$\omega_m, \omega_\pi$	134
$W$	9	(M1)-(M4)	74	$\iota_{\pi m}$	135
$p(i, j)$	12	$m(u)$	74	$GP(\pi)$	137
$r_f$	12	$U_w$	75	$U_a$	138
$\simeq$	12	$\Phi^+$	76	$M_u$	138
$d(, )$	13	$U$	77	$\varphi_a$	138
$\ell(w)$	13	$\sigma_J$	77	$1_a$	139
$M_r$	13	$\Phi_J$	77	$U_{a,t}$	139
$\alpha$	14	$U_J$	78	(V0) - (V3)	139
$\partial\alpha$	15	$L_J$	78	$W^{\text{aff}}$	144
$\rho_\alpha$	15	$S_i, S_{ij}$	83	$W(\Phi)$	144
proj	16,33	$e_i$	86	$\Gamma_a$	146
$M_J$	19	$n_i$	87	$\alpha$	146
$W_J$	19	$n(w)$	87	$\Phi^{\text{aff}}$	146
$\delta(, )$	27	$O_{2n}^\pm(q)$	96,106	$\Phi^{\text{aff}}(c)$	147
$\rho_{c,A}$	32	$K_{\sigma,\epsilon}$	98	$M_{a,k}$	147
$(P_x)$	40	$Sp_{2n}(q)$	106	$\Phi^\pm$	148
$\pi(C, c)$	42	$U_n(q)$	106	$U(c), U^\pm(c)$	148
$(R_c)$	45	$\mathcal{O}$	114	$-\alpha^+$	150
$B, N$	55	$\widehat{\mathcal{O}}, \widehat{K}$	120	$L_\alpha$	150
$H$	55	$\rho_{S,A}$	121	$\overline{W}$	180
(BN0) - (BN3)	55	$X^\infty$	121	$(\Delta, \mathcal{F})$	181
$P_J$	59	$\Delta^\infty$	122	(A1)-(A5)	181
$op_A$	64	$(\Delta, \mathcal{A})$	129	$(\Delta, \mathcal{F})^\infty$	182
$E_1(c)$	65	$(\Delta, \mathcal{A})^\infty$	129		

## INDEX

- $A_n$  apartment 5
- $A_n$  building 4,95
- $\tilde{A}_n$  building 114
- adjacent 1
- Affine
  - apartment system 129,180
  - BN-Pair 144
  - building 110
  - classification 152
  - Coxeter complex 110
  - diagram 110
  - root 129,146
- anisotropic 101
- apartment 5,6,31,34,129,181
- asymptote class 133
- asymptotic 133
- automorphism 2,11
- BN-Pair 55
- bipartite graph 28
- Blueprint 83
  - conform to 84
  - realisable 84
- Borel subgroup 59
- bounded subgroup 117
- Bruhat decomposition 55
- Building 27
  - at infinity 120,122,129,182
  - affine 110
  - Moufang 66,74
  - spherical 63
- $C_n$  apartment 6
- $C_n$  building 5,98
- carrefour 130
- Cayley plane 92,97
- cell complex 3
- chamber 1
- chamber system 1
  - of type  $M$  39
- cloison de quartier 113
- commutator relations 68
- connected 2
- contractible 185
- convex 14
- cotype 2
- cover 41
- covering 41
  - topological 41
  - universal 44
- Coxeter
  - complex 9,10
  - group 1,9
  - of spherical type 20
  - of affine type 110
  - of hyperbolic type 73
  - system 1
- cross polytope 6
- $D_n$  building 96
- Desarguesian plane 92
- diagram 9
- diameter 19,28
- Dieudonné determinant 116
- direct product 2,33
- direction 121,130
- distance 13
- $E_n$  building 96
- Elementary
  - contraction 12
  - equivalence 85
  - expansion 12
  - homotopy 12

- homotopy of galleries 42
- homotopy, strict 39
- end 130
- equipollent valuations 143
- equivalent valuations 144
- exchange property 24
- $F_4$  building 103
- face 2
- Finite
  - Coxeter complex 19
  - Coxeter group 20
  - building 106
- flag 4
- folding 15
- Form
  - alternating 5,98
  - hermitian 98
  - pseudo-quadratic 99
  - quadratic 99
  - sesquilinear 98
  - symmetric bilinear 99
  - symplectic 5,98
  - trace-valued 99
- foundation 89
- free generalised  $m$ -gon 67
- fundamental group 42
- Gallery 1,12
  - closed 42
  - $J$ - 2
  - length of 13
  - minimal 13
- generalised  $m$ -gon 28,68
- generalised quadrangle 36
- geometric realisation 3
- girth 28
- group of Lie type 106
- half-apartment 14,129,180
- homology 185
- Homotopy
  - of galleries 42
  - of words 12,17
  - strict 39
  - type 184
- irreducible components 25
- isometry 31
- isomorphism 2
- isotropic 5
- Iwahori subgroup 126
- junction 130
- Kac-Moody group 74,80
- label 83
- Labelling 83
  - natural 88
  - of a foundation 89
- lattice 115
- length 13
- $m$ -function 162
- morphism 2
- Moufang 66,74
  - hexagons 178
  - plane 81,97,102,165,175
  - polygons 163,175
  - octagons 179
  - quadrangles 175
- opposite 14,19,35,63,64
- opposition involution 64
- oriflamme 96
- $p$ -adics 74,120,157
- parabolic subgroup 59
- parahoric subgroup 126
- parallel 121,182
- parameter set 83
- parameter system 83
- parameters 30
- polarity 36
- polyhedra 24
- polysimplicial complex 110,184
- positive roots 76,148
- prenilpotent 73
- proj 16,32
- projective module 187
- projective plane 35
- projective valuation 131
- projectivity 137

- quartier 113
- R**-tree 182
- reduced word 12,17
- reflection 13
- residue 30
- residue field 114
- retraction 32
- root 14,31
- root data with valuation 139
- root group 66,74,119
- sap 130
- Sector 112,120,180
  - base chamber of 113
  - vertex of 113
  - direction 124
  - face 121,129,180
  - panel 113,180
- self-homotopy 22
- simple-transitive 11
- simplex 2
- simply-connected 42
- spherical type 20,63
- special vertex 112
- Steinberg representation 185
- strict homotopy 39
- strong transitivity 56
- supports 89
- thick 29
- thin 29
- Tits diagram 100,175
- Tits system 55
- topology 161,184
- totally isotropic 5,99
- totally singular 99
- trace at infinity 121
- tree 36,130,181
  - with sap 130
- type 1,2
- type  $M$  9,10,27,39
- uniformizer 114
- universal cover 44
- valency 29
- Valuation
  - discrete 114,131,140
  - normalized 154
  - of root groups 138
  - ring 114
  - special 161
- $W$ -distance 27
- wall 13,31,129,146,181
- Weyl chambers 20
- Witt index 99
- word 1,12

## **Perspectives in Mathematics**

- Vol. 1 J.S. Milne, *Arithmetic Duality Theory*
- Vol. 2 A. Borel et al., *Algebraic D-Modules*
- Vol. 3 Ehud de Shalit, *Iwasawa Theory of Elliptic Curves with Complex Multiplication*
- Vol. 4 M. Rapoport, N. Schappacher, P. Schneider, editors, *Beilinson's Conjectures on Special Values of L-Functions*
- Vol. 5 Paul Günther, *Huygens' Principle and Hyperbolic Equations*
- Vol. 6 Stephen Gelbart and Freydoon Shahidi, *Analytic Properties of Automorphic L-Functions*
- Vol. 7 Mark Ronan, *Lectures on Buildings*