

# Cities in the Global Economy

Dr. Anita Maček; Dr. Vito Bobek; Patricija Jankovič



Dr. Vito Bobek, Dr. Anita Maček & Patricija Jankovič

# Cities in the Global Economy



Cities in the Global Economy

1<sup>st</sup> edition

© 2015 Dr. Vito Bobek , Dr. Anita Maček & Patricija Jankovič & [bookboon.com](http://bookboon.com)

ISBN 978-87-403-0971-3

# Contents

<b>1</b>	<b>Introduction: Addressing globalization locally</b>	<b>8</b>
<b>2</b>	<b>Concept of urban competitiveness</b>	<b>14</b>
2.1	Chapter Overview	14
2.2	Introduction	15
2.3	The Concept of Urban Competitiveness	16
2.4	Determinants of Urban Competitiveness	19
2.5	Urban Assets	20
2.6	Conclusion	25
2.7	References, links and Further Reading	27
<b>3</b>	<b>Strategic management of cities</b>	<b>30</b>
3.1	Chapter Overview	30
3.2	Introduction	32
3.3	Different types of capital and assets in a city	32

## Free eBook on Learning & Development

By the Chief Learning Officer of McKinsey

**Download Now**

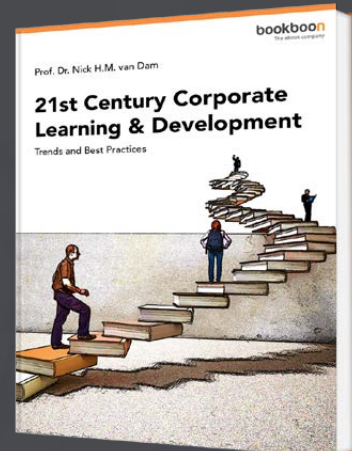

**Click on the ad to read more**

3.4	Economic outputs	37
3.5	The 'Five Pillar' approach	38
3.6	References	44
<b>4</b>	<b>City partnerships and networks</b>	<b>46</b>
4.1	Chapter Overview	46
4.2	Introduction	47
4.3	Terminology	47
4.4	The Origins and Historical Importance of City Partnerships	52
4.5	Status Quo and Trends of City Partnerships	55
4.6	City Partnerships – Towards a Classification	58
4.7	External Institutions Interested into City Partnerships	65
4.8	Findings Regarding City Partnerships in the Literature	67
4.9	References	73
<b>5</b>	<b>System of indicators for measuring performance development of cities</b>	<b>76</b>
5.1	Chapter Overview	76
5.2	Introduction	77
5.3	Theoretical background and applied practice	77
5.4	Selection of cities	79

**YOU THINK.  
YOU CAN WORK  
AT RMB**

**RAND  
MERCHANT  
BANK**  
A Division of FirstRand Bank Limited  
Traditional values. Innovative ideas.

Rand Merchant Bank uses good business to create a better world, which is one of the reasons that the country's top talent chooses to work at RMB. For more information visit us at [www.rmb.co.za](http://www.rmb.co.za)

Thinking that can change your world

Rand Merchant Bank is an Authorised Financial Services Provider



Click on the ad to read more

5.5	Selection of indicators	79
5.6	Data structure and categorization	82
5.7	Multi-attribute decision – making using program DEXi	83
5.8	Results and their interpretation	91
5.9	Conclusion	94
5.10	References	94
<b>6</b>	<b>Foreign direct investment and cities</b>	<b>98</b>
6.1	Chapter Overview	98
6.2	FDI definition	99
6.3	Development of FDI	100
6.4	Why do companies invest in the foreign market?	102
6.5	Effects of FDI	102
6.6	Factors influencing FDI flows	107
6.7	A City strategy for attracting FDI	108
6.8	Conclusion	114
6.9	References	114



Discover the truth at [www.deloitte.ca/careers](http://www.deloitte.ca/careers)

**Deloitte.**

© Deloitte & Touche LLP and affiliated entities.



Click on the ad to read more

7	<b>Innovations for sustainability</b>	<b>119</b>
7.1	Chapter overview	119
7.2	Sustainability – A concept or just a fashion?	119
7.3	What are innovations?	126
7.4	Financing innovations in public services	138
7.5	Public private Partnership	139
7.6	Smart municipalities	154
7.7	References	158

[bookboon.com](http://bookboon.com)

# Corporate eLibrary

See our Business Solutions for employee learning

[Click here](#)



# 1 Introduction: Addressing globalization locally

Cities represent the driving force of development in economic, social and cultural life and reflect the spatial organization of human society. Today's global cities have new challenges ahead; they are no longer self-sufficient, but embedded in broader, global developments. Furthermore, the city or strategic urban regions are becoming increasingly important players in the global economy, as the impact of national states decreases while the impact of cities and urban regions is increasing. The process of globalization is reflected in the tendency for gaining competitiveness and efficiencies of global trends.

Spatial and organizational effects of globalization show the concentration of financial and other specialized services in cities, deindustrialization, land use change and the importance of information and communication technologies. The last two hundred years of civilization defines an extensive variety of city visions. Our relationship with the city extends towards the environment, as well as the economy and quality of life. Technology, globalization and the growing complexity of life set cities in the centre of economic development and social progress. Cities are becoming centers of innovation, globalization, urbanization, scientific discoveries and dissemination of information and by the "natural structure" on the other hand also an optimal social unit to implement change and improve people's lives. Although small, because they possess sufficient community cohesion for approval and adoption of new programs, yet large enough to display demonstration effects; they represent messengers of the future in terms of "change cities, change the world".

In a large number of countries, and especially in the EU itself, there is growing interest in the economic contribution cities can make to the GNP. Of course, cities remain enormously diverse. There is not a single model of an urban development and the challenges are not the same in every city. Important differences shape the challenges that cities face: social composition, their economic structure and functions, geographical location and size. Simultaneously, national differences in cultures and traditions, institutional arrangements, economic performance, and government policy have an important impact upon cities, too. The problems of global cities like New York or Berlin or Brussels are far from those in medium-sized cities. Declining large industrial cities with less skilled work force, substantial immigrant communities and exhausted manufacturing economies, face very different dilemmas from fast growing cities based upon high-tech industries. Cities in the periphery face different social, economic and environmental challenges than those in the core.



Nevertheless, despite the differences between them, cities are affected by many common trends and face common challenges. In particular, the key challenge they face is to develop new models of decision-making which will increase their economic competitiveness, but at the same time reduce social exclusion. The size of a city does not matter here. Cities face this dilemma whether they are at the core or periphery, growing or declining economically, large or small. And the challenge confronts decision-makers at all government levels – supra-national, national, regional and local – and in all three sectors – private sector, government and civil society.

Despite the challenges presented by globalisation, institutional change and economic restructuring, many cities have substantial social, economic and cultural assets – and potential. Many of the factors which attract investment, people and events to particular places – education and training, the cultural, residential and physical environment, the quality of labour, the communication and transportation infrastructure, the planning and fiscal regimes, remain under the influence – if not control – of cities. They can be affected by urban strategic management, city policies, although increasingly in particular with other actors. And there are very many examples of successful responses to the new challenges throughout the world.

Many cities have achieved substantial physical regeneration, especially through the renovation of their city centres, which offer impressive retail, cultural, commercial and residential facilities. Many have concentrations of intellectual resources in knowledge hubs – universities as well as research and innovation institutions which encourage high level of innovation. Many cities play important roles as centres of decision-making, communication and exchange. Many have substantial cultural resources, which are increasingly the source of economic growth and job creation. Cities also have enormous integrative potential with the capacity to encourage community participation and civic identity. And many cities remain social and ethnically diverse and offer vibrant cultural opportunities which attract residents (especially creative class) and visitors.

Contemporary society is characterised by what might be described as “extraordinary global change” (Learning City Network, 1998). Globalisation – the “economic and cultural linking of diverse societies across large distances” (UNCHS 2001) – is occurring now with greater scale, scope, speed and level of complexity than ever before. A worldwide mobility of labour, the growth of the knowledge-based economy and information society, and the pervasion of information and communication technologies throughout all aspects of life mean that change is not only extent but ongoing.

Linkages at national and international levels are having significant economic, legal, social, technological, cultural and political effects locally and regionally within cities and urban regions. Institutions, organizations and Individuals – indeed, entire communities – need to develop adaptability and resilience if they are to be able to function socially, politically and economically on a continental and/or global stage. Thus “...as the constraints of geographical distance are becoming less important, the specific features of particular locales are becoming *more* important...” and cities are constantly challenged to maintain skills, knowledge and systems that are relevant and competitive. The global phenomenon of the Learning City has evolved in response to this challenge. “A Learning City is any city, town or village which strives to learn how to renew itself in a time of extraordinary global change. Using lifelong learning as an organising principle and social goal, Learning Cities promote collaboration of the civic, private, voluntary and education sectors in the process of achieving agreed upon objectives related to the twin goals of sustainable economic development and social inclusiveness...” (Learning City Network, 1998).

Rapidly changing modern cities are creating a need for strategic development that offers constant renewal of processes, innovation and peoples’ attitudes. It is important that a city’s management are able to see processes and events in a new way. An intelligent city has to be able to see what happens through time. An intelligent city needs to analyse, reach conclusions and define its present reality. They need to develop their strengths and eliminate their weaknesses by using out opportunities and reducing threats. That is how we create visions, ideas, and a strategy. This is how we create and prepare for the future. It is essential that a city management has the power to implement all this. Some city managements stay in the analytical phase and never move on to formulating and implementing their visions and dreams.

Strategic intelligence and social analysis involves learning from the past but, most importantly, understands trends and principles of development in the future. Social intelligence is an area of high importance related to city intelligence, being a substantial part of strategic urban management.

City managements leading a city towards an uncertain future are like the captains of a ship. The passengers and crew comprise their customers, employees and citizens. In this way, navigation is very similar to the management of a large organisation or a city.

City governments are highly complex organisations. They need to manage the allocation of resources between different, competing claims and respond to the demands of several different groups at the same time. To make sure that cities reach their development goals they need to be aware of their starting position. City managements need to ask themselves some important strategic questions, identify their strengths and work towards eliminating weakness. Once cities have identified where they are, they need to decide where they want to be in the future. And to reach the destination, they need to understand the significant trends that will influence the direction in which the future unfolds. On that journey, cities need to manage properly their assets by taking a holistic approach. Each asset depends on the others, that’s why the holistic approach in urban management is so important. The necessity of taking a holistic emerges particularly strongly from the knowledge-based economy.

These issues have been dealt with in this book through six chapters.

Chapter 2 (Concept of urban competitiveness) starts with a general introduction to the concept of competitiveness. After that, the concept of urban competitiveness is examined in more detail by having a closer look at the determinants that have been identified by modern literature to have a major impact on the development of a city's competitiveness potential. At the close of this part, the author points out some of the major challenges when trying to measure the specific competitiveness levels of cities. Improved competitiveness is something that every business, nation, region or city, is trying to achieve. The term is frequently used by politicians, economic experts or commentators on business matters as the ultimate goal for achieving economic prosperity. In reality, competitiveness is a very complex concept that is often poorly understood or misinterpreted, notwithstanding that policy makers are investing remarkable monetary and non-monetary resources in order to improve it.

Chapter 3 (Strategic management of cities) is based on a fact that city governments are highly complex organisations. They need to respond to the demands of many different groups and manage the allocation of resources between different, and often competing, claims. To make sure that cities reach their intended destination they need to be aware of their starting position. This requires them to ask some important strategic questions, identify their strengths and work towards eliminating areas of weakness. Once cities have identified where they are, they need to decide where they want to be in the future. And to do this, they need to understand the significant trends that will influence the direction in which the future unfolds. Managing the six identified capitals (Intellectual and social capital – people and knowledge; Democratic capital – participation and consultation; Cultural capital – values, behaviours and public expressions; Environmental capital – natural resources; Technical capital – man-made capital and infrastructure; and Financial capital – money and assets) effectively means taking a holistic approach, since each of the capitals depends on the others. The necessity of taking a holistic approach is one of the themes to emerge particularly strongly from the knowledge-based economy. Success factors of individual cities differ, however, despite differences, they have a common denominator. All cities have to solve a variety of problems in a variety of environments by identification of five key strategic steps: developing a vision and strategy, building confidence in the city, establishing partnerships, attracting specific factors and implementing key projects. Taking into account the fact that cities are becoming the generator of economic development and a source of growth for the national economy, the need to identify the development stage and the oversight of ranking and positioning of cities and regions (the level of categorization), upon which the preparation of appropriate strategic and development guidelines for cities and urban regions can take place, is emerging.

Chapter 4 (City Partnerships and Networks) starts with the theoretical background regarding the topic of city partnerships is discussed, starting with some general remarks on strategic city management and how city partnerships fit into this concept. Then, the focus is put on the terminology used throughout this paper. Furthermore, the idea of city partnerships is explained in detail including the origins and historical importance of city partnerships and their status quo in Europe and around the globe. A possible classification system for city partnerships is given as well, which is followed by a description of the most important international organizations relevant for cities that are engaged in networking initiatives. Furthermore, key findings in the area of city partnerships are summarized and explained in the end.

Chapter 5 (System of indicators for measuring performance development of cities) is based on recognition that cities are becoming generators of economic development and a source of growth for the national economy. Therefore, there is an increasing urge to identify the stages of development and positioning of cities upon which the adequate preparation of strategic and development guidelines is dependent. Comparison upon the level of their development efficiency calls for indicators, which measure the performance of cities, are representative and comparable between countries. Considering this necessity, at the present many different urban indicators and institutions, seeking compilation and analysis of collected data, can be quoted. Performance measurement systems, developed for internal use in some cities already show a degree of measurement feasibility. The fundamental problem represents their inconsistency and incomparability (over time and between cities), their use therefore cannot be approved in a wider context (benchmark) of situations. Theoretical background and set of indicators, composed by international institutions are usually related to the context of the global cities' comparison, in national framework identified by a large number of people; understandable, expected and reasonable. In the case of medium-sized cities we consequently have to question the applicability of the methodology and indicators used mostly in cases of large, global cities by internationally recognized institutions. With the established set of qualitative indicators and assistance of computer program for multi-parameter decision-making processes this chapter also seeks to compare the performance development of selected European cities.

Chapter 6 (Foreign direct investment and cities) presents the main characteristics of foreign direct investments. Chapter starts with a general description of international capital flows and continues with the presentation of effects of foreign direct investments. International investments bring a lot of different effects to the host economy, which depend mostly on the form of international capital flows and on readiness of the host country to openness. Within positive effects of foreign direct investments the most frequent are the increase of employment, technology and knowledge transfer, better use of infrastructure and local services and additional tax revenue. On the other side, several studies present also risks of foreign direct investments such as crowding-out of domestic companies, adverse competition and pressure on current accounts. Host economies therefore have to attract investments with positive effects which will be easily realized if conditions for investments are favourable. A lot of successful cities have their own tools and strategies for attracting foreign direct investments and maximizing their benefits. In this chapter such strategy is presented.

Chapter 7 (Innovations for sustainability) starts with a general introduction to the term “sustainability”, a phrase which could be found in every political text, in every single project and in every text book for students, dealing with development of companies, cities and states. Through her own definition the author stresses out the importance of understanding the concept of sustainability and the responsible use of the term. The similar problem is manifested by using the term “innovations” without truly understand what they actually are and how shall we managed them. Speaking of urban development by not knowing the significance of innovations cannot and will not lead to progress. Through innovation types, in theory mostly created for companies, the solution for municipalities and public organizations is shown. Choosing the right type of innovation and the most suitable way of financing them community’s development projects almost cannot fail. The chapter is concluded with urgent analogy between big urban centers and smaller towns and municipalities.

**Brain power**

By 2020, wind could provide one-tenth of our planet's electricity needs. Already today, SKF's innovative know-how is crucial to running a large proportion of the world's wind turbines.

Up to 25 % of the generating costs relate to maintenance. These can be reduced dramatically thanks to our systems for on-line condition monitoring and automatic lubrication. We help make it more economical to create cleaner, cheaper energy out of thin air.

By sharing our experience, expertise, and creativity, industries can boost performance beyond expectations. Therefore we need the best employees who can meet this challenge!

The Power of Knowledge Engineering

Plug into The Power of Knowledge Engineering.  
Visit us at [www.skf.com/knowledge](http://www.skf.com/knowledge)

**SKF**

 **Click on the ad to read more**

## 2 Concept of urban competitiveness

*“In today’s globalized, networked world, every place has to compete with every other place for its share of the world’s consumers, tourists, businesses, investment, capital, respect and attention. Cities, the economic and cultural powerhouses of nations, are increasingly the focus of this international competition for funds, talent and fame.” (Anholt, as cited in Branding Your City, 2006)*

### Recommended additional reading:

- Florida, R. 2005. *Cities and the Creative Class*. Oxford: Routledge.
- Glaeser, E.L. (2000). The New Economics of Urban and Regional Growth. In G. Clark, M. Gertler, & M. Feldman, *The Oxford Handbook of Economic Geography* (pp. 83–98). Oxford: Oxford University Press.
- van Winden, W. (2005). *Small and medium-sized cities in the knowledge-based economy: challenges and policy options*. Retrieved from Euricur – European Institute for Comparative Urban Research:  
[http://www.euricur.nl/content\\_assets/Microsoft%20Word%20-%20LezingMagdeburg.pdf](http://www.euricur.nl/content_assets/Microsoft%20Word%20-%20LezingMagdeburg.pdf)

### 2.1 Chapter Overview

This chapter starts with a general introduction to the concept of competitiveness. After that, the concept of urban competitiveness is examined in more detail by having a closer look at the determinants that have been identified by modern literature to have a major impact on the development of a city’s competitiveness potential. At the close of this part, the author points out some of the major challenges when trying to measure the specific competitiveness levels of cities. Improved competitiveness is something that every business, nation, region or city, is trying to achieve. The term is frequently used by politicians, economic experts or commentators on business matters as the ultimate goal for achieving economic prosperity. In reality, competitiveness is a very complex concept that is often poorly understood or misinterpreted; notwithstanding that policy makers are investing remarkable monetary and non-monetary resources in order to improve it.

### Learning outcomes

By the end of this chapter successful students will be able to:

1. Explain the concept of urban competitiveness;
2. Describe determinants of urban competitiveness;
3. Understand urban assets.

## 2.2 Introduction

In the course of the emerging competitiveness hype during the last decade, leading economists debated fiercely whether the term 'competitiveness' can be an attribute of nations, regions and cities, or not. The well-known economist Krugman (1996) states that it makes little sense to apply the concept of competitiveness to territorial units since countries, and by extension regions and cities, cannot go out of business. In contrast to that, very unsuccessful firms are able to do so, which is why the term 'competitiveness' can, if at all, only be applied to companies.

Nevertheless, many other authors disagree with Krugman and those who share his views. For example, Camagni (2002) responds to Krugman's statement that places certainly can suffer from the equivalent since stagnant investment, falling per capita incomes or rising unemployment rates can severely damage their competitive position. In addition, Buck and Gordon (2005, p. 1) point out that over time cities always went through cyclical periods of ebb and flow, and that some faded or even vanished from the face of the earth. Moreover, according to Collins (2007) cities compete with each other since all of them strive for enhanced economic development provided by the attraction of, for example, well-educated human resources or private investments.

Furthermore, Kresl claims that cities are competing when trying to become the host city of Olympic Games. London successfully competed with cities like New York, Madrid, Paris and Moscow, and was selected by the Olympic Committee for staging the Olympic Summer games in 2012. What is more, the same author highlights that Chicago, Dallas and Denver all hoped to become the city of choice for the new headquarter of the aircraft manufacturer Boeing. Chicago won this competition, and the other cities lost the opportunity to decrease unemployment rates (Kresl, 2007, p. 13). Finally, nowadays Frankfurt, London, New York, Paris and Tokyo are all battling for being the number one in terms of the provision of leading business services (Begg, 2004, p. 3).

To sum up, it could be concluded that in a perfect market system, in which instant information adjustment prevail, competitiveness among nations, regions or cities cannot exist. However, since such perfect economic conditions do not exist, and since cities benefit from different sets of existing assets and abundant resources, there is little doubt that, despite Krugman's arguments, there is clearly something taking place between cities that can be called 'competition' (Begg, 1999). According to Kresl (2007, p. 13) in order to win these internal city competitions, each city must actively fight to strengthen its competitiveness, meaning its ability to compete with comparable other cities.

Improved competitiveness is something that every business, nation, region or city, is trying to achieve. The term is frequently used by politicians, economic experts or commentators on business matters as the ultimate goal for achieving economic prosperity (Turok, 2005, p. 25). In reality, competitiveness is a very complex concept that is often poorly understood or misinterpreted, notwithstanding that policy makers are investing remarkable monetary and non-monetary resources in order to improve it (Begg, 2004, p. 1). Even though the term seems to be familiar to everyone, there is very little agreement neither on how to define competitiveness exactly nor on what strategic policies should be applied to improve it (Porter, 1998, p. xii).

### 2.3 The Concept of Urban Competitiveness

After having determined that cities compete with each other for additional, economic development, the concept of urban competitiveness has to be examined in a more detailed way.

Modern literature highlights that one has to distinguish carefully between the concept of urban competitiveness and the concept of firm-based competitiveness due to the fact that the former is sometimes falsely assessed in the same way as the latter, namely by simply comparing a city's economic growth and related indices with those of other cities. Consequently, a competitive city will sometimes be defined as having relatively high growth domestic product (GDP) numbers and employment figures (Turok, 2005, p. 26).

With us you can  
shape the future.  
Every single day.

For more information go to:  
[www.eon-career.com](http://www.eon-career.com)

Your energy shapes the future.

**e-on**





According to Bailey et al. (2004, p. 137), however, equating urban competitiveness with firm-based competitiveness is not an appropriate measurement approach since such economic indices tend to focus more on historical performance than on future economic potential. Besides, when looking at the definitions of the two concepts, it becomes clear that a specific distinction between those two concepts has to be made. In fact, the concepts differ manifestly in their complexity. For example, a White Paper created by the government of the UK defines competitiveness for a company as being “the ability to produce the right goods and services of the right quality, at the right price, and at the right time. It means meeting customers’ needs more efficiently and more effectively than other firms (DTI, 1995, p. 8).

Contrary to that, a definition for urban competitiveness made by the Urban Competitiveness Project characterizes competitiveness as “referring to the degree to which a city, or an urban region, in comparison with other competing cities, is able to provide the jobs, income, cultural recreational amenities, degree of social cohesion, governance and urban environment to which its current and targeted new residents aspire” (Kresl, 2007, p. 17). Additionally, Michael Storper (1997, p. 264) defines urban competitiveness as “the ability of an economy to attract and maintain firms with stable or rising market shares in an activity, while maintaining stable or increasing standards of living for those who participate in it”, meaning that the competitiveness of cities is not just about the income of firms but also about how that income goes to residents.

As can be seen from the definitions, the competitiveness concept for a company is rather simple and one-dimensional. Economic indicators, such as the firm’s performance expressed in sufficient returns on capital, are the only important factors for measuring the competitiveness of a firm (Bailey et al., 2004, p. 135). A thorough review of modern literature, however, discloses pretty clear that for defining and assessing urban competitiveness it is not enough to focus on economic performance indicators only. According to Gardiner et al. (2004) and Lever (1999) the concept of urban competitiveness is rather complex and multi-faceted, which basically means that it involves more than just comparing cities in terms of a single dimension.

For example, the European Commission (2000 & 2001) determines the following ten characteristics as potentially relevant for a competitive city:

- a highly skilled workforce;
- capabilities for advanced RDI (research, development and innovation);
- good internal connectivity together with strategic transport and IT connections to selling markets and;
- nationally and internationally reputable facilities for events;
- a city centre of distinctiveness;
- sophisticated cultural infrastructure and services;
- a capability for effective governance and delivery of efficient services;

- a reputation for environmental excellence and responsibility;
- a wide spectrum of high quality residential choices;
- an inclusive and diverse society.

In this text, the concept of Michael Storper is followed, whereas the competitive city is being defined as the city, being able to attract and maintain companies with rising or at least stable market shares. At the same time, city itself should maintain increasing or at least stable standards of living for those who participate in it. The competitiveness of cities is not just about the performance of companies, but also how that income arrives to residents.

To the above listed characteristics, some others were added which were suggested by our previous research and literature review to be equally important:

- fiscal incentives available to cities;
- vision, leadership and strategic decision-making capacity;
- scope and quality of national governmental policies, especially their strategic and operative support for development of cities within nation. Also powers and resources (autonomy) which is provided to cities, is very important;
- innovation in companies and organisational behaviour in cities.

Kresl (1994, p. 51) stresses the following dimensions as being determinants for a highly competitive urban economy:

- creation of high-skill, high-income jobs,
- production shifts to environmentally benign goods and services,
- production focuses on goods and services with desirable characteristics, such as a high income elasticity of demand,
- appropriate economic growth achieves full employment without generating negative market aspects,
- a city chooses its own future rather than passively accepting its lot by specializing in particular activities, and
- a city improves its position in the urban hierarchy.

As can be surmised from the lists above, experts' opinions about the characteristics of urban competitiveness differ greatly. Although, the list of Kresl portrays a more accurate notion of urban competitiveness than is brought forth by any approach that is focusing on economic output indicators only, it seems to be fixated on too abstract determinants, which tend to put a competitive city on the same level as an ideal, unattainable economy. After having clarified that the concept of urban competitiveness is a multidimensional one, it is, therefore, crucial to examine more specific determinants, which are proven to have a significant influence on an increase or decrease of cities' competitiveness levels.

## 2.4 Determinants of Urban Competitiveness

Broadly speaking, modern literature identifies two types of determinants, namely those that are beyond any direct control of individual cities, and those that are within a city’s touching distance to a greater or lesser extent. To the former belong macroeconomic factors, as e.g. currency exchange rates and interest rates (Begg, 2004, p. 4). To the latter belong the elements that are illustrated as a pyramidal competitiveness model in Figure 1 below, namely urban input or assets, revealed output and targeted outcomes.

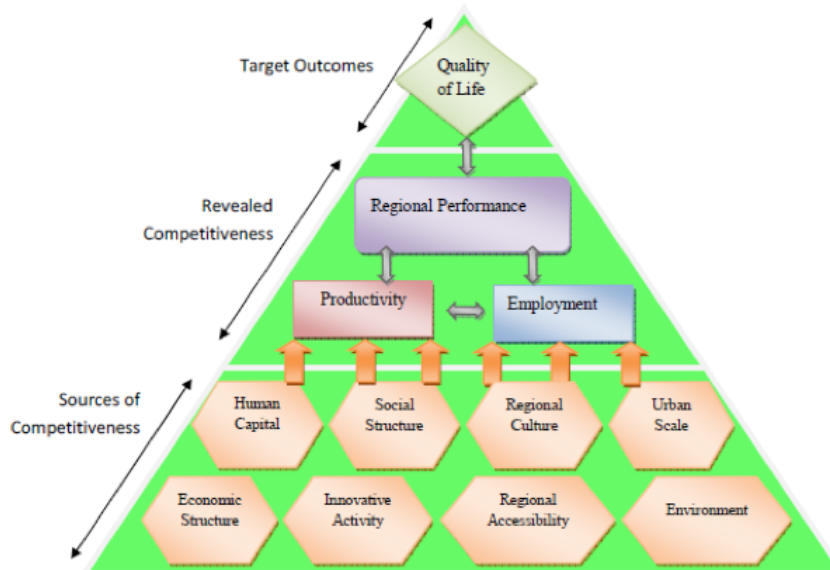

**Figure 1:** Pyramidal Model of Regional Competitiveness

Source: Adapted from Gardiner et al. 2004

First of all, a city’s input or assets stand for their sources of competitiveness from which the city can draw its power to enhance its competitiveness level. Such basic assets can come from manifold foundations or categories, and their proliferation may differ from city to city. Secondly, output refers to easily measurable performance indicators of an urban area that depend on both the productive efficiency of a given workforce as well as the level of employment within a city (Gardiner et al., 2004). However, although such economic measures indicate what can be termed ‘revealed competitiveness’, Lever (1999) clearly claims that economic output discloses little about the underlying urban assets, meaning that such indices do not reveal why a city is more or less competitive.

Consequently, it would be somewhat negligent to assess the competitiveness of a city in terms of economic performance variables only (Gardiner et al., 2004). Last but not least, the further enhancement of the quality of life and of attractive amenity provisions in a city must be regarded as ultimate goal or targeted outcome for policymakers and, therefore, as having an impact on the competitiveness of a city. Here, it has to be highlighted that the better a city can exploit such elements for the establishment of an attractive environment, the more competitive the city can become in the end. The following sub-chapter intends to examine each group in more detail.

## 2.5 Urban Assets

As mentioned above, many different urban assets or foundations, which are more or less intertwined with each other, together form a city's power source, which enables a city to enhance its level of competitiveness. To the most important basic foundations belong according to the modern literature, the following categories:

- knowledge base
- urban diversity
- innovativeness and accessibility
- agglomeration and urban scale
- social cohesion, and
- economic heritage.

### Knowledge Base

The first category, the so-called knowledge base, according to Lever (2002) involves available sources of tacit and codified knowledge, the overall knowledge infrastructure of a city and the general educational level and creativity potential of the people living in the city. Many studies suggest a positive relationship between a city's knowledge base and its economic development. For example, Matthiessen et al. (2002) conclude that a city's knowledge assets have a considerable impact on the overall economy of the city since such assets are of increasing importance with respect to economic change and growth.

© 2013 Accenture. All rights reserved.

be > your degree

Bring your talent and passion to a global organization at the forefront of business, technology and innovation. Discover how great you can be.

Visit [accenture.com/bookboon](http://accenture.com/bookboon)

**Be greater than.**  
consulting | technology | outsourcing

**accenture**  
High performance. Delivered.



According to van den Berg et al. (2007), however, cities often neglect to exploit their knowledge assets in a full way since they are unable to optimize the interaction between universities and business entities. In addition, it is recommended to address the problem of knowledge fragmentation within research institutions as well. In fact, larger cities are typically hindered to perform in an efficient way due to the fact that their various sources of knowledge, e.g. their universities, are acting independently from each other, and therefore often generate knowledge duplications. As a consequence, city governments would do well to align the different sectors of research, education and business in a better way. Additionally, several studies (e.g. Gleaser, Sheinkman and Sheifer, 1995) have identified the positive correlation between relative high amounts of university graduates working in a city and an overall improved economic performance of the city.

Regarding the creativity potential of people, Florida (2005) highlights the economic importance of creative people, the so-called creative class, who hold the information needed to produce all kinds of knowledge-intensive *art*, like software programs, songs, poems or designs. Black and Henderson (1997) and Simon and Nardinelli (1996) approve of the accumulation of well-educated people and the consequential spillovers of tacit knowledge which promote the long-term growth of cities. In order to enhance its competitiveness level a city must, therefore, apply every effort to attract such well-educated knowledge workers (Gleaser et al., 1995 as well as Kimbrough & Murphy, 2005). According to Kresl (2007, p. 14) a city in the twentyfirst century must attract skilled workers, who are scarce, rather than unskilled workers, who are abundant throughout the world.

As mentioned before, Florida (2000, p. 6) believes that instead of simply choosing the job with the highest salary potential, talented people are normally more concerned with place-based characteristics. In addition, van den Berg et al. (2005) argue that knowledge workers are allured by places, where they can enjoy life. Besides, creativity tends to attract other creative knowledge workers, which means that there is a cumulative effect involved (Florida, 2000, p. 15).

Moreover, Glaeser (2000) believes that companies are searching for locations, where they have access to a well-educated labor force rather than access to customers or suppliers, and that they are even willing to follow movements of well-educated knowledge workers to other, more enjoyable cities.

To sum up, the latest research on regional development highlights the importance of shifting the policy focus on people rather than on firms. As a matter of fact, the assets of cities are regarded as unique sources for attracting highly skilled and talented people, who in turn can leverage the competitiveness levels by strengthening the knowledgeintensive economy (Lee, Florida, and Acs, 2004 as well as Turok, 2005, p. 41).

### Urban Diversity

Urban diversity is a city's openness or tolerance towards outsiders. According to Florida (2002, p. 249 ff) and Begg et al. (2004, p. 103) diversity among people living in a city fosters interactions between residents, and, therefore, leads to newly generated knowledge and innovations. In addition, creative knowledge workers are more likely attracted to cities that are associated with a high level of diversity since the social hurdles to enter such a city are relatively low. Again, many internationally recognized studies found the positive correlation between urban diversity and economic growth to be true (e.g. Glaeser et al., 1995).

Urban diversity can be best measured in terms of the number of people, who are born with different national roots. Another indicator is presented by Florida (2002, p. 333), who measures this foundation on the basis of the relative share of homosexual couples living in an urban area. It has to be highlighted, however, that cultural diversity might bring along some social drawbacks as well. According to van den Berg et al. (2007) there are many districts within European cities where badly integrated immigrants live, who cannot contribute to the overall economic development of these cities since they do not possess well-developed, knowledge-intensive skills.

### Innovativeness and Accessibility

As van den Berg et al. (2007) observe, the competitiveness of a city is becoming increasingly reliant on innovation and entrepreneurship. However, it is proven by empirical evidence that regions across the globe unevenly benefit from innovative activities. As a matter of fact, high concentrations of innovation and entrepreneurship can be usually found in agglomerated, urban areas only. For example, Cooke and Simmie (2005, p. 98) state that 67% of all patent exports in Italy are undertaken around Milan and Turin. Furthermore, they argue that 60% of Japanese R&D laboratories in the US are located just around four urban areas, namely Boston, New York, Chicago and Los Angeles/San Francisco. Besides, innovation does not have to be necessarily about breakthroughs in new technologies (Hospers, 2003).

Due to the fact that knowledge is the main factor that fosters the development of an innovative environment, one can come to the conclusion that in order to enhance the overall innovativeness, cities have to ensure that firms are fed with the best sources of knowledge (Cooke & Simmie, 2005, p. 110). Additionally, according to Simmie (2005) face-to-face contacts at infrastructural hubs foster knowledge spillovers that lead to innovation. Consequently, a high level of national and international accessibility facilitated by international airports, high-speed train connections and a well-functioning, local transportation network might be crucial for a city to sustain social and economic development (Parkinson et al., 2004, pp. 58f.). Furthermore, local innovation is promoted variously in different states. For example, while innovation is primarily driven by the private market with only little outside coordination in the UK, in Germany multi-level networks are implemented in order to stimulate innovative thinking between private and public organizations (Parkinson et al., 2004, p. 60).

### Agglomeration and Urban Scale

A noticeable determinant of urban competitiveness is the geographic concentration of economic activities or, in other words, the tendency for companies to cluster around urban areas, which implies that firms benefit from being located near cities (Turok, 2005, p. 35). According to Gordon and McCann (2000), geographical proximity enhances companies' economic opportunities, such as benefiting from economies of scale and scope, and softens the risks to which they are potentially exposed. More than a hundred years ago, Marshall (1890) was already highlighting the mutual gains of different companies, which were geographically clustered. What is more, literature assesses the size of a city as an important determinant for its success. The bigger a city is in size, the more attractive it tends to be for both knowledge workers and companies.

### Social Cohesion

Another fundamental foundation for cities' assets deals with the levels of social equality and poverty in an urban area. As shown before, nations, regions and cities strike different paths in order to sustain further economic growth. For instance, Finland bases its development plan on social equality while the US banks on its *American dream* philosophy, where differences in social classes function as primary motivator (Le Galès, 2007). Generally speaking, however, low levels of poverty and social inequality are favorable both from a societal perspective and from an economic one. As a matter of fact, high levels of societal exclusion and poverty may cause tensions between the upper and lower social classes. Such tensions may result in higher criminal activities or even civil wars, lower safety perceptions of inhabitants and tourists and generally a significantly decreasing quality of life (Hall and Pfeiffer, 2000, p. 21). What is more, low levels of social cohesion may imply that valuable human capital is excluded from economic life, and therefore wasted (van den Berg et al., 2007).

### Economic Heritage

The economic history of a city must also be seen as a factor that influences its competitiveness in times of the knowledge economy. As indicated before, many cities in more developed economies went through a rapid expansion in the 19<sup>th</sup> century as an economic consequence of the industrial revolution. Such cities grew tremendously because of the development of particular industries, e.g. the steel industry or the coal industry, and their economic advantage of having access or being relatively close to important, industrial raw materials (Begg et al., 2004, p. 101). However, over time the economic environment has changed, and what used to be an advantage in the past turned out to be a disadvantage in the modern economy. Indeed, changes in advanced economies have devaluated cities' geographical advantages of the past (van den Berg et al., 2005, p. 10). Traditional smoke-stack industries near cities were replaced by smaller, customized factories (Gleaser, 1998). Knowledge intensive activities displaced the production of tangible goods.

In general, literature assumes that cities which were dominated by traditional manufacturing industries and port activities tend to suffer from a less well-educated labor force, inappropriate levels of air pollution, a tarnished city image and lower standards of living (van den Berg et al., 2005, p. 10). As a consequence, these days such cities struggle to overcome their manufacturing legacies and their outdated social, economic and institutional structures, which hinder them to leverage their competitiveness levels, while others profit from the enhancement of more modern service industries and find themselves on a steady, economic rise (Begg et al., 2004, p. 101ff). A study of the largest US cities revealed that while about one quarter managed to transform a population decline into a growth between the 1980s and 1990s, and another quarter experienced constant growth, about a half of the screened cities faced severely damaging losses (Beauregard, 2004).

### Economic Outputs

As mentioned before, modern literature claims that some researchers are misled to equate productivity levels or per capita income figures with the relative competitiveness of cities (Bailey et al., 2004, p. 136). Nevertheless, economic performance output plays an essential role. According to Turok (2005, p. 26), approaches, which are intended to gain insights into the competitiveness level of a city, need to consider, among other things, the city's ability to sell products and services in competitive, external markets and its efficiency to produce products and services.

"I studied English for 16 years but...  
...I finally learned to speak it in just six lessons"  
Jane, Chinese architect

ENGLISH OUT THERE

Click to hear me talking before and after my unique course download





Variables that are often used for assessing the economic output of a city are, among others, its GDP per capita, change in GDP per capita, GDP per employed resident, the rate of unemployment and the number of newly formed companies (Bailey et al., 2004, p. 136ff). GDP per capita, which is frequently utilized by the DTI to evaluate regions' competitiveness levels (e.g. DTI, 2000), measures the capacity of a city's resident to generate economic wealth. In general, the major advantage of indicators determining GDP figures is that they are related to residents' income levels and consequently their living standards in a positive way. Major drawbacks of GDP per capita are, however, that this indicator reacts very slow to change and highlights historic data only (Bailey et al., 2004, p. 137). Besides, a city's economic productivity might be best evaluated by utilizing its figures for GDP per employed resident. In addition, from the level of unemployment one can infer a city's labor utilization and how equal income is distributed among residents. Indeed, the higher the unemployment rate, the smaller the numbers of residents that benefit directly from newly generated income (Bailey et al., 2004, p. 137). Last but not least, the number of newly founded companies is frequently believed to be positive related to a city's competitiveness level since it ought to be obvious that newly set up firms bring along innovation and entrepreneurial spirit (Bailey et al., 2004, p. 147). However, the rate of newly established firms is only valuable when taking the number of companies' failures into consideration at the same time.

### Quality of Life and Urban Amenities

As indicated before, in order to gain from additional economic development opportunities, modern literature identifies a city's quality of life as indicator of utmost importance due to the fact that a high quality usually tends to attract well-educated people and, consequently, investments of companies. In addition, Florida (2000, 2003, 2005) identifies in his comprehensive studies about the creative class cultural and recreational amenities as significant drivers for the competitiveness of a city. Attributes, which are associated with a high quality of life and a diverse, urban amenity offering in a beneficial way, are, among others, high-quality housing, recreation facilities, a public health care system, an attractive built environment, nice and clean city parks, lack of pollution, low crime levels, lifestyle opportunities, international schools, attractive natural surroundings, commercial space and political involvement (Rogerson, 1999 as well as van Winden, 2005).

## 2.6 Conclusion

Nowadays, city leaders of important cities in Europe, such as Barcelona or Amsterdam, argue, however, that the economic vitality of major cities shall never be marked down as unimportant for the overall economic well-being of their countries (Kresl, 2007, p. 14). In addition, along with political interest, literature on urban significance is growing rapidly, (Gardiner et al., 2004) and there is extensive evidence that cities are increasingly recognized as places to live and areas of potential opportunities rather than places of liabilities (The World Bank, 2000, pp. 1f. As well as Parkinson et al., 2004, p. 52). Consequently, policymakers are supposed to shift their focus from a national strategic level to a sub-national, urban one.

Also, European cities are extremely diverse with respect to their economic structure, their social composition, their physical size and their geographical location (Parkinson et al., 2004, p. 13). Indeed, following Begg, Moore and Altunbas (2004, p. 102) each city has a distinguishing urban identity, which may provide both opportunities as well as threats concerning their individual economic development. As a result, European cities stand at different starting points, face diverse challenges and strategic policies to leverage urban competitiveness (Bailey, Docherty, & Turok, 2004, p. 156). As a matter of fact, London may suffer from different problems than Vienna, and what works well in Munich might not be successful in Helsinki at all. According to Kresl (2007, p 18) this will be reinforced by the fact that societal preferences with respect to economic prosperity differ among nations.

However, despite their differences cities are influenced by macroeconomic commonalities, as well. For example, due to collapsing trade hurdles, falling transport costs, rising exports, imports and foreign investments, arising transnational corporations, and the triumphal advent of new information and communication technologies (ICTs), in short, an increasingly globalized environment, the world's economies are more than ever connected with each other (Turok, 2005, pp. 26f.).

Hence, traditional patterns of trade and production in modern economies have changed in a radical way (Hospers, 2003). Indeed, trade in intangible services is about to challenge trade in tangible goods. In addition, multinational companies try to exploit the concept of international division of labor by shifting their manufacturing facilities to countries, where poor working conditions, low health and safety regulations and, therefore, low costs of human resources, prevail (Lever W.F., 2004, p. 11). Also, this trend does not stop at manufacturing companies. Enterprises engaged in service activities, e.g. tourism companies, software developers or call centers, make usage of lower wages in less developed countries as well (Howland, 1996).

As a consequence of that, globalization, being today's major economic driver, forces all kinds of economic players, including nations, regions and, especially, cities, in more developed countries to reconsider their competitive advantages, strengths and opportunities in order to sustain their present levels of welfare (Hospers, 2003). Typically, the transition towards the knowledge economy is believed to be modern economies' greatest opportunity in the 21st century (van Winden, 2005). Indeed, the vast majority of modern literature on regional development concludes that nations, regions and cities need to rearrange their knowledge assets in order to exploit market opportunities, satisfy customers, enhance society's general environment and compete successfully within the global race for economic development (DTI, 1998, p. 6).

## 2.7 References, links and Further Reading

1. Anholt, S. (2006). *Branding Your City*. CEOs for Cities.
2. Bailey, N., Docherty, I., & Turok, I. (2004). Dimensions of city competitiveness: Edinburgh and Glasgow in a UK context. In I. Begg, *Urban Competitiveness: Policies for dynamic cities* (pp. 135–159). Bristol: The Policy Press.
3. Beauregard, R.A. (2004). *The Resilience of US Cities: Decline and Resurgence in the 20th Century*. Paper presented to the Leverhulme International Symposium on The Resurgent City (London: London School of Economics). Available from: [www.lse.ac.uk/collections/resurgentCity/Papers/Openingplenary/robertabeauregard.pdf](http://www.lse.ac.uk/collections/resurgentCity/Papers/Openingplenary/robertabeauregard.pdf).
4. Begg, I. (2004). *Urban Competitiveness: Policies for dynamic cities*. Bristol: The Policy Press.
5. Begg, I. (1999). Cities and Competitiveness. *Urban Studies*, pp. 795–809.
6. Begg, I., Moore, B., & Altunbas, Y. (2004). Long-run trends in the competitiveness of British cities. In I. Begg, *Urban Competitiveness: Policies for dynamic cities* (pp. 101–133). Bristol: The Policy Press.
7. Black, D., & Henderson, V. (1997). *Urban growth*. Cambridge, MA: National Bureau of Economic Growth.
8. Buck, N., & Gordon, I. (2005). Introduction: Cities in the New Conventional Wisdom. In N. Buck, I. Gordon, A. Harding, & I. Turok, *Changing Cities: Rethinking Urban Competitiveness, Cohesion and Governance* (pp. 1–21). New York: Palgrave Macmillian.

**DUKE**  
THE FUQUA  
SCHOOL  
OF BUSINESS

**BUSINESS HAPPENS**

**HERE.**

[www.fuqua.duke.edu/globalmba](http://www.fuqua.duke.edu/globalmba)

**Learn More >**



9. Camagni, R. (2002). On the Concept of Territorial Competitiveness: Sound or Misleading? *Urban Studies* (39), pp. 2395–2411.
10. Collins, A. (2007). Making Truly Competitive Cities – On the Appropriate Role for Local Government. *Economic Affairs* (27), pp. 75–80.
11. Cooke, P., & Simmie, J. (2005). Knowledge, Innovation and Competitiveness. In N. Buck, I. Gordon, A. Harding, & I. Turok, *Changing Cities: Rethinking Urban Competitiveness, Cohesion and Governance* (pp. 97–111). New York: Palgrave Macmillan.
12. Gordon, I.R., & McCann, P. (2000). Industrial Clusters: complexes, agglomeration and/or social networks? *Urban Studies* (37), pp. 513–532.
13. DTI. (1995). *Competitiveness: Forging Ahead*. London: HMSO.
14. *European Cities Monitor 2009*. (2009). Retrieved from European Cities Monitor-Website: <http://www.europeancitiesmonitor.eu/>
15. European Commission. (2000). *The Urban Audit – Volume I Overview and comparative section*. Brussels: The European Communities.
16. European Commission. (2001). *The Urban Audit – Volume III – The Manual*. Brussels: The European Communities.
17. Florida, Richard. 2005. *Cities and the Creative Class*. Oxford: Routledge.
18. Florida, Richard. (2000). *The Economic Geography of Talent*. Pittsburgh: Carnegie Mellon University.
19. Florida, R. (2002). Bohemia and Economic Geography. *Journal of Economic Geograpy* (2), pp. 55–71.
20. Gardiner, B., Martin, R., & Tyler, P. (2004). Competitiveness, Productivity and Economic Growth across the European Regions. *Regional Studies* (38), pp. 1045–1067.
21. Glaeser, E.L. (2000). The New Economics of Urban and Regional Growth. In G. Clark, M. Gertler, & M. Feldman, *The Oxford Handbook of Economic Geography* (pp. 83–98). Oxford: Oxford University Press.
22. Gleaser, E.L., Sheinkman, J.A., & Sheifer, A. (1995). Economic Growth in a Cross-section of Cities. *Journal of Monetary Economics* (36), S. 117–143.
23. Hospers, G.-J. (2003). Creative Cities in Europe: Urban Competitiveness in the Knowledge Economy. *Intereconomics* (38), pp. 260–269.
24. Howland, M. (1996). Producer services and competition from offshore: US data entry and banking. In P.W. Daniels, & W.F. Lever, *The global economy in transition* (S. 310–327). Harlow: Addison Wesley Longman.
25. Kimbrough, S.O., & Murphy, F.H. (2005). A Study of the Philadelphia Knowledge Economy. *Interfaces* (35), pp. 248–259.
26. Kresl, P.K. (2007). *Planning cities for the future: urban economic strategies in Europe*. Cheltenham, UK: Edward Elgar Publishing Limited.

27. Kresl, P.K., & Singh, B. (1994). The competitiveness of cities: the United States. In O. a. Australia, *Cities and the new global economy* (pp. 424–446). Canberra: OECD and the Government of Australia.
28. Krugman, P. (1996). Making Sense of the Competitiveness Debate. *Oxford Review of Economic Policy*, pp. 17–25.
29. Lee, S.Y., Florida, R., & Acs, Z.J. (2004). Creativity and Entrepreneurship: A Regional Analysis of New Firm Foundation. *Regional Studies* (38), pp. 879–891.
30. Le Galès, P. (2007). What Policies for Globalising Cities? RETHINKING THE URBAN POLICY AGENDA. Campo de las Naciones, Madrid, Spain 29–30 March 2007. Retrieved from <http://www1.oecd.org/gov/regional-policy/49680222.pdf>
31. Lever, W.F. (2004). The knowledge base and the competitive city. In I. Begg, *Urban Competitiveness: Policies for dynamic cities* (pp. 11–32). Bristol: The Policy Press.
32. Lever, W.F. (1999). Competitive Cities in Europe. *Urban Studies* (36), pp. 1029–1044.
33. Malmberg, A., Sölvell, O., & Zander, I. (1996). Spatial Clustering, Local Accumulation of Knowledge and Firm Competitiveness. *Geografiska Annaler* (78), S. 85–97.
34. Marshall, A. (1890). *Principles of Economics – Volume 1*. London: Macmillan.
35. Matthiessen, C.W., Schwarz, A.W., & Find, S. (2002). The Top Level Global Research System, 1997-1999: Centers, networks and nodality. An Analysis based on bibliometric indicators. *Urban Studies* (39), S. 903–927.
36. Parkinson, M., Hutchins, M., Simmie, J., Clark, G., & Verdonk, H. (2004). *Competitive European Cities: Where do the Core Cities stand?* London: Office of the Deputy Prime Minister Publications.
37. Porter, M.E. (1998). *The competitive advantage of nations*. London: Macmillan.
38. Simon, C.J., & Nardinelli, C. (1996). The talk of the town: human capital, information and the growth of English Cities, 1861 to 1961. *Explorations in Economic History* (33), S. 384–413.
39. Rogerson, R. J. (1999, May). Quality of Life and City Competitiveness. *Urban Studies (Routledge)* (36), pp. 969-985.
40. Storper, M. (1997). *The Regional World: Territorial Development in a Global Economy*. New York: Guilford Press.
41. The World Bank. (2000). *Cities in Transition*. Retrieved from The World Bank-Website: <http://siteresources.worldbank.org/INTINFNETWORK/Resources/urban.pdf>
42. Turok, I. (2005). Cities, Competition and Competitiveness: Identifying New Connections. In N. Buck, I. Gordon, A. Harding, & I. Turok, *Changing Cities* (pp. 25–43). Palgrave Macmillan: New York.
43. van den Berg, L., van Winden, W., & Pol, P. (2007, March). European Cities in the Knowledge Economy: Towards a Typology. *Urban Studies* (44), pp. 525–549.
44. van Winden, W. (2005, October). *Small and medium-sized cities in the knowledge-based economy: challenges and policy options*. Retrieved from Euricur – European Institute for Comparative Urban Research: [http://www.euricur.nl/content\\_assets/Microsoft%20Word%20-%20LezingMagdeburg.pdf](http://www.euricur.nl/content_assets/Microsoft%20Word%20-%20LezingMagdeburg.pdf)

# 3 Strategic management of cities

*Most of us fear change. Even when our minds say change is normal, our stomachs quiver at the prospect. But for strategists and managers today, there is no choice but to change. (Robert Waterman Jr.)*

Recommended additional reading:

- Kresl, P.K. (2007). *Planning cities for the future: urban economic strategies in Europe*. Cheltenham, UK: Edward Elgar Publishing Limited.
- PricewaterhouseCoopers (PWC). (2005). *Cities of the Future: global competition, local leadership*. Retrieved from PricewaterhouseCoopers-Website:  
[http://www.pwc.com/en\\_GX/gx/government-public-sector-research/pdf/cities-final.pdf](http://www.pwc.com/en_GX/gx/government-public-sector-research/pdf/cities-final.pdf)

## 3.1 Chapter Overview

As pointed out in previous chapters, globalization and the economic consequences involved, dramatically changed the environment for cities. This was also true for urban planning strategies that aimed to enhance the economy of a city. Although cities' authorities did much planning prior to the beginnings of globalization and the increased competition between urban areas as well, such planning efforts must be regarded as being rather ordinary and inefficient since they tended to target objects, such as social housing projects or land use projects, which had only marginal impacts on the enhancement of a city's competitiveness (van den Berg et al., 2005, p. 12). In other words, such planning strategies were not components of long-term strategic visions, and therefore did not address a city's specific economic development needs in an effective way.

However, as the world has become more and more global, many city leaders started to realize that it is time to take over new responsibilities, including a long-term oriented, pro-active urban policy development thinking approach. Due to the rapidly changing global environment, the leaders of cities recognized that it is crucial for a city to be prepared for the future. As a consequence, today modern city management approaches comprise a thorough analysis and understanding of the present situation of the city in order to enhance current strengths and eliminate current weaknesses, the identification of future trends which might have an impact on the city and the development of a vision and a promising, long-term strategy in order to exploit future opportunities and tackle potential threats to the city.

In view of the competitive environment cities have to face today, managing a city becomes comparable to managing a large organization. Cities, which want to influence their future development actively, have to be aware of their strategic assets and resources, have to have a vision and have to develop a strategy to reach their long-term goals. City networks, co-operations and partnerships are among many others part of a city's strategic assets and resources and can be therefore used to accomplish a city's vision and to support its strategy (PwC, 2005, pp. 14–16). This discipline of managing a city according to economic concepts is called strategic city management and is introduced to the reader throughout this chapter. First of all, the basic idea of strategic city management is explained. This is followed by a more detailed description of a city's strategic assets and the most common visions and strategic goals, which cities set for themselves.

### Learning outcomes

By the end of this chapter successful students will be able to:

1. Understand managing different types of capital in a city
2. Understand and describe main principles when managing people, property and processes in a city
3. Understand the practical concept of urban management.

## Join American online LIGS University!

Interactive Online programs  
BBA, MBA, MSc, DBA and PhD

### Special Christmas offer:

- ▶ enroll **by December 18th, 2014**
- ▶ **start studying and paying only in 2015**
- ▶ **save up to \$ 1,200** on the tuition!
- ▶ Interactive Online education
- ▶ visit [ligsuniversity.com](http://ligsuniversity.com) to find out more!

Note: LIGS University is not accredited by any nationally recognized accrediting agency listed by the US Secretary of Education. More info [here](#).



### 3.2 Introduction

Globalisation and decentralisation have forced regions and cities to face numerous problems and challenges. Some have managed to solve the problems and became the ‘cities of the future’, others have failed to do so and are called the ‘cities of the past’. To improve the position of the latter, good use of city capital must be ensured to achieve competitive advantages. These competitive advantages today are based on knowledge and information technology.

“Internationalization, change into a society where information and creativity are of importance, and rising weight of network position alter the risk pattern and thereby create new demands for active urban policy of marketing and strategic planning...Only localities that actively fight for their future will have one” (Anderson, Wichmann and Matthiessen, 1995).

According to PwC (2005), managing a city is comparable to managing a large organization. In order to be prepared for the future, cities and companies need to know where they are today (their present situation) and what is necessary to achieve their future goals (vision and strategy). Besides, they have to be aware of the external environment and trends, which might affect their decisions and which might also be drivers for change. Future trends such as globalization, urbanization, migration, changing demographics and others can be both, a threat and an opportunity for cities. However, if the city administration is able to develop its city’s strengths and eliminate its weaknesses, the city is on the best way to reach its goals (PwC, 2005, pp. 14–16).

### 3.3 Different types of capital and assets in a city

There are six different types of capital (PWC 2005) that need to be managed strategically:

- Intellectual and social capital – people and knowledge;
- Democratic capital – participation and consultation;
- Cultural capital – values, behaviours and public expressions;
- Environmental capital – natural resources;
- Technical capital – man-made capital and infrastructure;
- Financial capital – money and assets.

Capital	Examples
Intellectual and Social Capital	People and resources of knowledge
Democratic Capital	Transparency, partnerships and participation
Cultural and Leisure Capital	Values, public expressions and behaviors
Environmental Capital	Natural resources
Technical Capital	Infrastructure, man-made capital
Financial Capital	Assets and money

**Table 1:** Examples for different types of capital



As mentioned above, many different urban assets or foundations, which are more or less intertwined with each other, together form a city's power source, which enables a city to enhance its level of competitiveness. To the most important basic foundations belong according to the modern literature, the following categories:

- a) knowledge base,
- b) urban diversity,
- c) innovativeness and accessibility,
- d) agglomeration and urban scale,
- e) social cohesion, and
- f) economic heritage.

### Knowledge Base

The first category, the so-called knowledge base, according to Lever (2002) involves available sources of tacit and codified knowledge, the overall knowledge infrastructure of a city and the general educational level and creativity potential of the people living in the city. Many studies suggest a positive relationship between a city's knowledge base and its economic development. For example, Matthiessen et al. (2002) conclude that a city's knowledge assets have a considerable impact on the overall economy of the city since such assets are of increasing importance with respect to economic change and growth. According to van den Berg et al. (2007), however, cities often neglect to exploit their knowledge assets in a full way since they are unable to optimize the interaction between universities and business entities. In addition, it is recommended to address the problem of knowledge fragmentation within research institutions as well. In fact, larger cities are typically hindered to perform in an efficient way due to the fact that their various sources of knowledge, e.g. their universities, are acting independently from each other, and therefore often generate knowledge duplications.

As a consequence, city governments would do well to align the different sectors of research, education and business in a better way. Additionally, several studies (e.g. Gleaser, Sheinkman & Sheifer, 1995) have identified the positive correlation between relative high amounts of university graduates working in a city and an overall improved economic performance of the city. Regarding the creativity potential of people, Florida (2005) highlights the economic importance of creative people, the so-called creative class, who hold the information needed to produce all kinds of knowledge-intensive *art*, like software programs, songs, poems or designs. Black and Henderson (1997) and Simon and Nardinelli (1996) approve of the accumulation of well-educated people and the consequential spillovers of tacit knowledge which promote the long-term growth of cities.

In order to enhance its competitiveness level a city must, therefore, apply every effort to attract such well-educated knowledge workers (Glaeser et al., 1995 as well as Kimbrough & Murphy, 2005). According to Kresl (2007, p. 14) a city in the twentyfirst century must attract skilled workers, who are scarce, rather than unskilled workers, who are abundant throughout the world. As mentioned before, Florida (2000, p. 6) believes that instead of simply choosing the job with the highest salary potential, talented people are normally more concerned with place-based characteristics. In addition, van den Berg et al. (2005) argue that knowledge workers are allured by places, where they can enjoy life. Besides, creativity tends to attract other creative knowledge workers, which means that there is a cumulative effect involved (Florida, 2000, p. 15).

Moreover, Glaeser (2000) believes that companies are searching for locations, where they have access to a well-educated labor force rather than access to customers or suppliers, and that they are even willing to follow movements of well-educated knowledge workers to other, more enjoyable cities.

To sum up, the latest research on regional development highlights the importance of shifting the policy focus on people rather than on firms. As a matter of fact, the assets of cities are regarded as unique sources for attracting highly skilled and talented people, who in turn can leverage the competitiveness levels by strengthening the knowledge intensive economy (Lee, Florida, & Acs, 2004 as well as Turok, 2005, p. 41).

**ie** business school

#1 EUROPEAN BUSINESS SCHOOL  
FINANCIAL TIMES 2013

#gobeyond

**MASTER IN MANAGEMENT**

**Because achieving your dreams is your greatest challenge.** IE Business School's Master in Management taught in English, Spanish or bilingually, trains young high performance professionals at the beginning of their career through an innovative and stimulating program that will help them reach their full potential.

- Choose your area of specialization.
- Customize your master through the different options offered.
- Global Immersion Weeks in locations such as Rio de Janeiro, Shanghai or San Francisco.

**Because you change, we change with you.**

www.ie.edu/master-management | mim.admissions@ie.edu | f t in YouTube



### Urban Diversity

Urban diversity is a city's openness or tolerance towards outsiders. According to Florida (2002, p. 249ff) and Begg et al. (2004, p. 103) diversity among people living in a city fosters interactions between residents, and, therefore, leads to newly generated knowledge and innovations. In addition, creative knowledge workers are more likely attracted to cities that are associated with a high level of diversity since the social hurdles to enter such a city are relatively low. Again, many internationally recognized studies found the positive correlation between urban diversity and economic growth to be true (e.g. Glaeser et al., 1995).

Urban diversity can be best measured in terms of the number of people, who are born with different national roots. Another indicator is presented by Florida (2002, p. 333), who measures this foundation on the basis of the relative share of homosexual couples living in an urban area. It has to be highlighted, however, that cultural diversity might bring along some social drawbacks as well. According to van den Berg et al. (2007) there are many districts within European cities where badly integrated immigrants live, who cannot contribute to the overall economic development of these cities since they do not possess well-developed, knowledge-intensive skills.

### Innovativeness and Accessibility

As van den Berg et al. (2007) observe, the competitiveness of a city is becoming increasingly reliant on innovation and entrepreneurship. However, it is proven by empirical evidence that regions across the globe unevenly benefit from innovative activities. As a matter of fact, high concentrations of innovation and entrepreneurship can be usually found in agglomerated, urban areas only. For example, Cooke and Simmie (2005, p. 98) state that 67% of all patent exports in Italy are undertaken around Milan and Turin. Furthermore, they argue that 60% of Japanese R&D laboratories in the US are located just around four urban areas, namely Boston, New York, Chicago and Los Angeles/San Francisco. Besides, innovation does not have to be necessarily about breakthroughs in new technologies. (Hospers, 2003) Indeed, five different kinds of innovation can be identified: a) process innovation, b) product innovation c) input or raw material innovation, d) new markets, and e) new organizational forms (Schumpeter, 1942, pp. 132f.).

Due to the fact that knowledge is the main factor that fosters the development of an innovative environment, one can come to the conclusion that in order to enhance the overall innovativeness, cities have to ensure that firms are fed with the best sources of knowledge (Cooke & Simmie, 2005, p. 110). Additionally, according to Simmie (2002) face-to-face contacts at infrastructural hubs foster knowledge spillovers that lead to innovation. Consequently, a high level of national and international accessibility facilitated by international airports, high-speed train connections and a well-functioning, local transportation network might be crucial for a city to sustain social and economic development (Parkinson et al., 2004, pp. 58f.). Furthermore, local innovation is promoted variously in different states. For example, while innovation is primarily driven by the private market with only little outside coordination in the UK, in Germany multi-level networks are implemented in order to stimulate innovative thinking between private and public organizations (Parkinson et al., 2004, p. 60).

## Agglomeration and Urban Scale

A noticeable determinant of urban competitiveness is the geographic concentration of economic activities or, in other words, the tendency for companies to cluster around urban areas, which implies that firms benefit from being located near cities (Turok, 2005, p. 35). According to Gordon and McCann (2000), geographical proximity enhances companies' economic opportunities, such as benefiting from economies of scale and scope, and softens the risks to which they are potentially exposed. More than a hundred years ago, Marshall (1890) was already highlighting the mutual gains of different companies, which were geographically clustered. What is more, literature assesses the size of a city as an important determinant for its success. The bigger a city is in size, the more attractive it tends to be for both knowledge workers and companies.

In times of the knowledge economy three major economic benefits regarding geographic concentration of companies and the size of cities can be identified (Collins, 2007). Firstly, companies benefit from clustering around larger cities due to the possibility to recruit from a larger pool of specialized human resources and a better access to supplying and supporting components, such as marketing services, communication facilities or venture capital. Moreover, knowledge workers are more likely to move to larger cities since metropolitan areas offer a greater variety of jobs (Turok, 2005, p. 35). Equally, suppliers and distributors gain from being located close to a larger city due to the increasing chance to get in contact with potential buyers (European Cities Monitor, 2009). Secondly, all parties involved gain from greater knowledge spillovers and information flows. As indicated before, the frequent exchange of tacit knowledge stands in direct relationship with economic success. Due to the compact clusters of companies, face-to-face exchange of technological information and knowledge that leads to innovation is more likely to happen (Malmberg et al., 1996). Thirdly, larger sized urban areas usually harbor a broader set of amenities that are, as explained before, so crucial to attract knowledge workers and firms. A large urban size provides, among others, international schools and universities, various cultural institutions, an enlarged transportation network and numerous, entertaining alternatives (van den Berg, 2007).

## Social Cohesion

Another fundamental foundation for cities' assets deals with the levels of social equality and poverty in an urban area. As shown before, nations, regions and cities strike different paths in order to sustain further economic growth. For instance, Finland bases its development plan on social equality while the US banks on its *American dream* philosophy, where differences in social classes function as primary motivator (Le Galès, 2007). Generally speaking, however, low levels of poverty and social inequality are favourable both from a societal perspective and from an economic one. As a matter of fact, high levels of societal exclusion and poverty may cause tensions between the upper and lower social classes. Such tensions may result in higher criminal activities or even civil wars, lower safety perceptions of inhabitants and tourists and generally a significantly decreasing quality of life (Hall & Pfeiffer, 2000, p. 21). What is more, low levels of social cohesion may imply that valuable human capital is excluded from economic life, and therefore wasted (van den Berg et al., 2007).

## Economic Heritage

The economic history of a city must also be seen as a factor that influences its competitiveness in times of the knowledge economy. As indicated before, many cities in more developed economies went through a rapid expansion in the 19th century as an economic consequence of the industrial revolution. Such cities grew tremendously because of the development of particular industries, e.g. the steel industry or the coal industry, and their economic advantage of having access or being relatively close to important, industrial raw materials (Begg et al., 2004, p. 101). However, over time the economic environment has changed, and what used to be an advantage in the past turned out to be a disadvantage in the modern economy. Indeed, changes in advanced economies have devaluated cities' geographical advantages of the past (van den Berg et al., 2005, p. 10). Traditional smoke-stack industries near cities were replaced by smaller, customized factories (Gleaser, 1998). Knowledge intensive activities displaced the production of tangible goods.

In general, literature assumes that cities which were dominated by traditional manufacturing industries and port activities tend to suffer from a less well-educated labour force, inappropriate levels of air pollution, a tarnished city image and lower standards of living (van den Berg et al., 2005, p. 10). As a consequence, these days such cities struggle to overcome their manufacturing legacies and their outdated social, economic and institutional structures, which hinder them to leverage their competitiveness levels, while others profit from the enhancement of more modern service industries and find themselves on a steady, economic rise (Begg et al., 2004, p. 101ff). A study of the largest US cities revealed that while about one quarter managed to transform a population decline into a growth between the 1980s and 1990s, and another quarter experienced constant growth, about a half of the screened cities faced severely damaging losses (Beauregard, 2004).

### 3.4 Economic outputs

As mentioned before, modern literature claims that some researchers are misled to equate productivity levels or per capita income figures with the relative competitiveness of cities (Bailey et al., 2004, p. 136). Nevertheless, economic performance output plays an essential role. According to Turok (2005, p. 26), approaches, which are intended to gain insights into the competitiveness level of a city, need to consider, among other things, the city's ability to sell products and services in competitive, external markets and its efficiency to produce products and services.

Variables that are often used for assessing the economic output of a city are, among others, its GDP per capita, change in GDP per capita, GDP per employed resident, the rate of unemployment and the number of newly formed companies (Bailey et al., 2004, p. 136ff). GDP per capita, which is frequently utilized by the DTI to evaluate regions' competitiveness levels (e.g. DTI, 2000), measures the capacity of a city's resident to generate economic wealth. In general, the major advantage of indicators determining GDP figures is that they are related to residents' income levels and consequently their living standards in a positive way.

Major drawbacks of GDP per capita are, however, that this indicator reacts very slow to change and highlights historic data only (Bailey et al., 2004, p. 137). Besides, a city's economic productivity might be best evaluated by utilizing its figures for GDP per employed resident. In addition, from the level of unemployment one can infer a city's labor utilization and how equal income is distributed among residents. Indeed, the higher the unemployment rate, the smaller the numbers of residents that benefit directly from newly generated income (Bailey et al., 2004, p. 137). Last but not least, the number of newly founded companies is frequently believed to be positive related to a city's competitiveness level since it ought to be obvious that newly set up firms bring along innovation and entrepreneurial spirit (Bailey et al., 2004, p. 147). However, the rate of newly established firms is only valuable when taking the number of companies' failures into consideration at the same time.

### 3.5 The 'Five Pillar' approach

This modern approach of managing a city can also be referred to as 'strategic economic planning' (SEP). As indicated above, SEP is different from ordinary strategic urban planning since it focuses on the efficient utilization of its assets in order to accomplish an objective which enjoys great support for the city's residents and which is supposed to leverage the city's competitiveness level. (Kresl, 2007, pp. 2ff.) According to Kresl (2007, pp. 29ff) an effective SEP effort consists of at least five components. These components are:

**SMS from your computer**  
 ...Sync'd with your Android phone & number

**FREE 30 days trial!**

Go to [BrowserTexting.com](http://BrowserTexting.com)

and start texting from your computer!

**BrowserTexting**



- an objective examination of the urban region’s strengths and weaknesses in relation to other urban competitors,
- involvement of the public and of all major entities in the region in an exercise that will make clear the actual aspirations and concerns of the local residents and entities,
- a design of a strategic economic plan and vision that realizes the previously identified realistic aspirations and concerns,
- a mobilization of local human resources on the context of clear responsibilities and lines of authority and with an understanding of who or which agency is in charge of the process, and
- regular monitoring and evaluation efforts of progress and performance.

Additionally, it is important to emphasize an appropriate marketing and communication of these future-oriented strategic components and the goals involved, since in times of increased urban competition, a city will not be able to stand out from competition, and therefore not be able to leverage its attractiveness for new businesses and highly educated knowledge workers (PWC, 2005).

After identifying a city’s strategic assets and resources, every city should develop a vision statement, its long-term strategic goals and a proper strategy. Although those strategic items are set up individually by every municipality, many cities focus on the same general issues. Having a look on the development goals of cities around the globe, it can be noticed that nearly every city today aims at being a place to live, work, educate, socialize and relax. Through a modern image and a warm atmosphere, people and companies shall be invited to come, to stay and to spend their money in the cities (PwC 2005, p. 8). PwC who analysed vision statements and strategic goals of cities around the globe, has come to the conclusion that for nearly every modern city in the 21<sup>st</sup> century, three different concepts, describing the ideal or competitive city of the future, seem to bear resemblance to the city’s individual vision and strategy. All of those three concepts, which are called the *knowledge city*, the *creative city* and the *intelligent city*, combine the aforementioned aims.

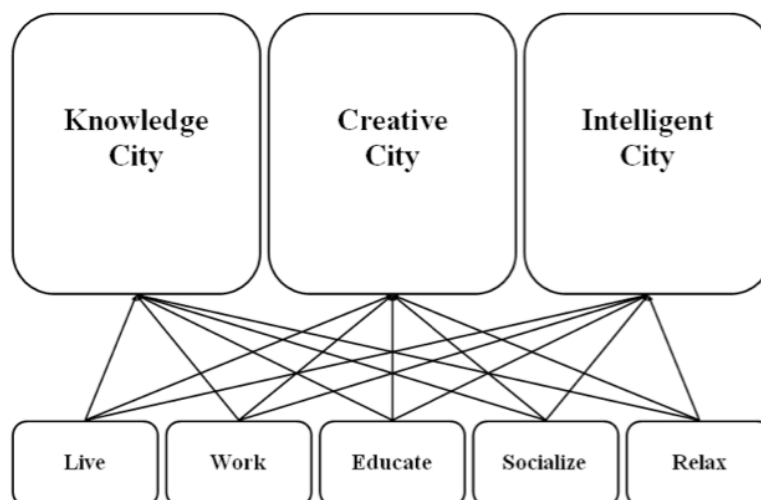
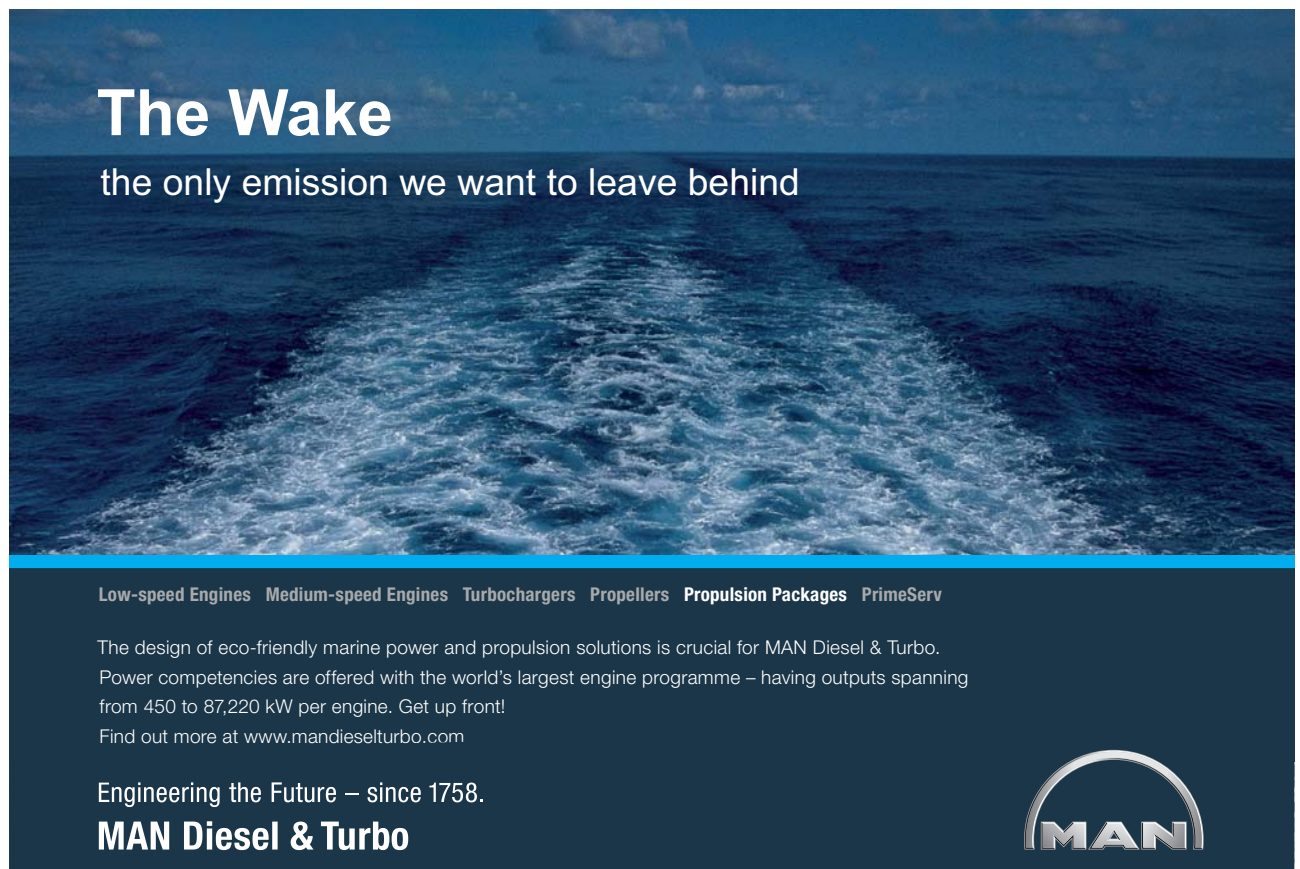

**Figure 2:** The Three Concepts for an Ideal City  
Adapted from PwC, 2005, pp. 8; 20–22

Explaining those concepts shortly, the knowledge city is a city with high quality and density of educational and research facilities and highly knowledge-based economy. The creative city on the other side refers to a diverse and highly experienced group of citizens, who want to have action, experiences in various fields, a dynamic environment and a place for self-realization. Finally, an intelligent city is not only a combination of the aforementioned concepts, but a place for knowledge exchange and generation between citizens and/or people from other cities, and a city which is constantly developing and adapting to future needs (PwC, 2005, pp. 20–22).

By the way, those five cornerstones of a successful city, namely being a place to live, to work, to educate, to socialize and to relax, cannot only be used to develop the ideal city in theory on the one hand but also to compare cities with each other on the other hand. A good example for comparing cities according to those dimensions is the European Smart Cities ranking. This ranking is aimed at finding Europe's smartest medium-sized city according to the following dimensions:

- smart governance,
- smart economy,
- smart living,
- smart mobility,
- smart people and
- smart environment.



**The Wake**  
the only emission we want to leave behind

Low-speed Engines Medium-speed Engines Turbochargers Propellers Propulsion Packages PrimeServ

The design of eco-friendly marine power and propulsion solutions is crucial for MAN Diesel & Turbo. Power competencies are offered with the world's largest engine programme – having outputs spanning from 450 to 87,220 kW per engine. Get up front!  
Find out more at [www.mandieselturbo.com](http://www.mandieselturbo.com)

Engineering the Future – since 1758.  
**MAN Diesel & Turbo**





By using such city rankings, researchers, economists and politicians are able to draw conclusions whether one city can be seen to be better in one area than others (European Smart Cities Ranking, 2011).

#### Developing the Vision and Strategy (VIS) model for strategic management of a city

Strategic development plan is a basis for achieving optimal results through management process. It should be directed towards various goals, but above all towards economic growth and employment (by enhancement of entrepreneurship and innovative activities, use of ICT, modernisation of education) leading towards increased welfare while securing sustainable development.

Methodological approach should be based on definition and evaluation of key indicators of the national and regional development strategy, leading towards developing such a strategy with a focus on economic development, social, public health, cultural, environmental, and ecological policies. In this phase it is essential to achieve the highest possible consensus about the fundamental strategic development policy amongst all stakeholders in the city.

Based on statistical analysis, strategic goals and key indicators are aggregated in five clusters/areas (indicated in Figure 5). Simultaneously, five aggregated key indicators for monitoring purposes should be designed.

On the operational level, the following activities are needed (the entire approach is depicted in Figure 4):

- Analysis of the basic operational strategic programmes
- Establishment of the 'Monitoring Committee' which role will be to monitor and evaluate the development of the Strategic Operational Plan' as well as the Management of Changes Strategy.
- Design of semi-structured survey, organising interviews, focus group meetings reflect back workshops and telephone interviews with stakeholders.

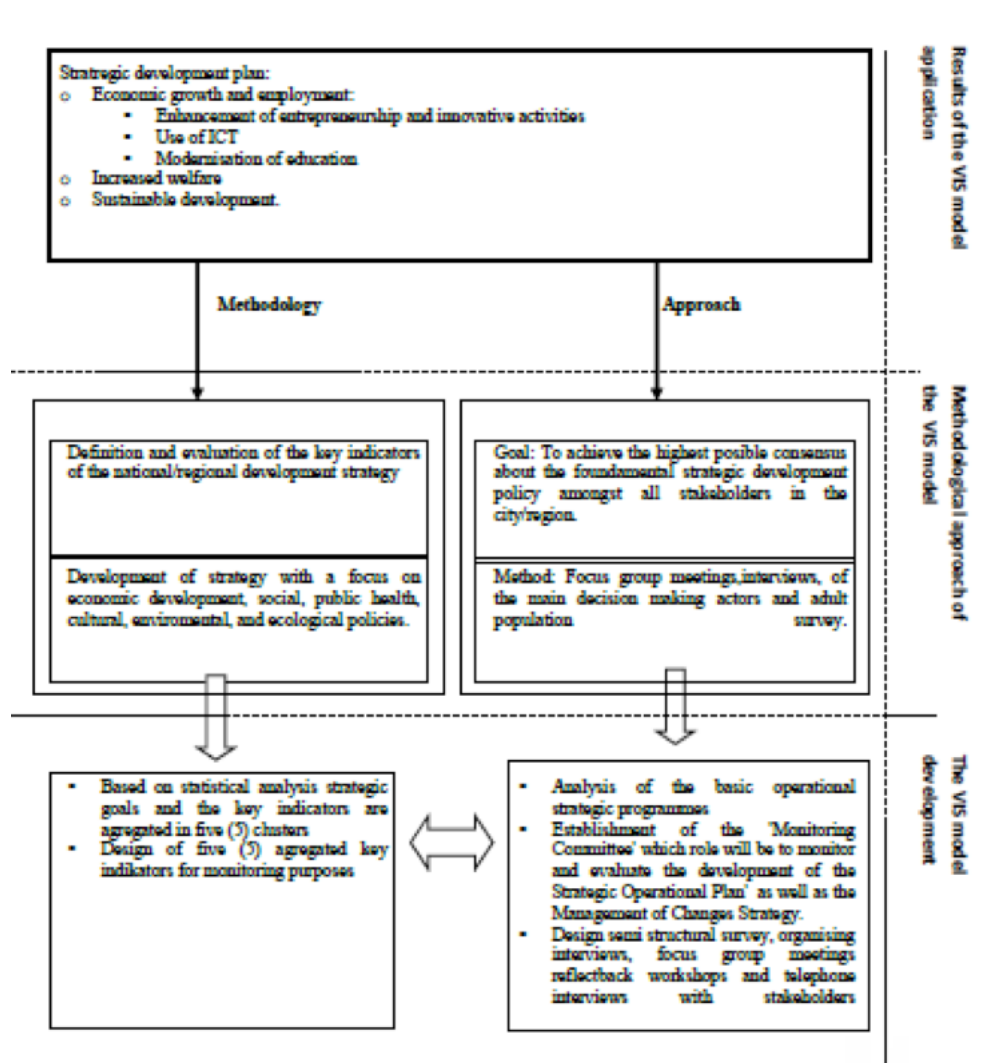
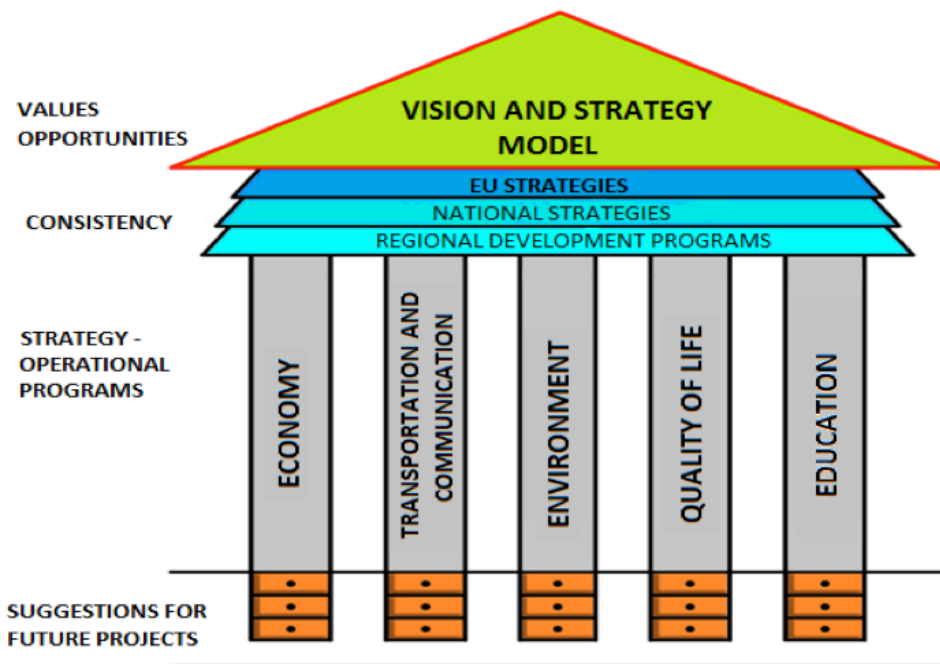

Figure 3: Process of developing the VIS model

With defining and assessing the five pillars/clusters/areas (economy, transportation and communication, education, environment, quality of life) in a ‘Vision and strategy’ (VIS) model, particular attention is paid to balanced approach as an example of what can be done in each of the five areas.

The VIS model for city management is developed through analysis of strategic development documents, design of framework for vision and strategy model, defining five pillar model for strategic planning, defining consistent system of economic indicators and semi-structured in-depth interviews with city representatives and experts on urban competitiveness. The framework of VIS model is shown in Figure 5 below.



**Figure 4:** The Vision and Strategy Model (VIS)

The model enables cities to improve their position with respect to higher productivity, educated labour force, high economic growth, added value per capita and ultimately, to increase quality of welfare.

## TURN TO THE EXPERTS FOR SUBSCRIPTION CONSULTANCY

Subscribe is one of the leading companies in Europe when it comes to innovation and business development within subscription businesses.

We innovate new subscription business models or improve existing ones. We do business reviews of existing subscription businesses and we develop acquisition and retention strategies.

Learn more at [linkedin.com/company/subscribe](https://www.linkedin.com/company/subscribe) or contact Managing Director Morten Suhr Hansen at [mha@subscribe.dk](mailto:mha@subscribe.dk)

**SUBSCRIB**✓**BE** - to the future



### 3.6 References

1. Anderson, H.T., & Wichmann-Matthiessen, C. (1995). Metropolitan Marketing and Strategic Planning: Mega Events. A Copenhagen Perspective. *Danish Journal of Geography*.
2. Bailey, N., Docherty, I., & Turok, I. (2004). Dimensions of city competitiveness: Edinburgh and Glasgow in a UK context. In I. Begg, *Urban Competitiveness: Policies for dynamic cities* (pp. 135–159). Bristol: The Policy Press.
3. Beauregard, R.A. (2004, April). *The Resilience of U.S. Cities: Decline and Resurgence in the 20th Century*. Retrieved from <http://www.lse.ac.uk/collections/resurgentCity/Papers/Opening%20plenary/robertabeauregard.pdf>.
4. Begg, I., Moore, B., & Altunbas, Y. (2004). Long-run trends in the competitiveness of British cities. In I. Begg, *Urban Competitiveness: Policies for dynamic cities* (pp. 101–133). Bristol: The Policy Press.
5. Black, D., & Henderson, V. (1997). *Urban growth*. Cambridge, MA: National Bureau of Economic Growth.
6. Collins, A. (2007, September). Making Truly Competitive Cities – On the Appropriate Role for Local Government. *Economic Affairs* (27), pp. 75–80.
7. DTI. (2000). *Our competitive future: Building the knowledge driven economy*. London: Stationary Office Books.
8. European Smart Cities Ranking. (2011). Retrieved from 'smart-cities.eu' webpage <http://www.smart-cities.eu/ranking.html>
9. Florida, R. (2002). Bohemia and Economic Geography. *Journal of Economic Geograpy* (2), pp. 55–71.
10. Florida, R. (2005). *The Flight of the Creative Class*. New York: HarperCollins Publishers.
11. Gleaser, E.L., Sheinkman, J.A., & Sheifer, A. (1995). Economic Growth in a Cross-section of Cities. *Journal of Monetary Economics* (36), S. 117–143.
12. Gleaser, E.L. (1998). Are cities dying? *Journal of Economic Perspectives* (12), pp. 139–160.
13. Glaeser, E.L. (2000). The New Economics of Urban and Regional Growth. In G. Clark, M. Gertler, & M. Feldman, *The Oxford Handbook of Economic Geography* (pp. 83–98). Oxford: Oxford University Press.
14. Gordon, I.R., & McCann, P. (2000). Industrial Clusters: complexes, agglomeration and/or social networks? *Urban Studies* (37), pp. 513–532.
15. Kimbrough, S.O., & Murphy, F.H. (2005, May/June). A Study of the Philadelphia Knowledge Economy. *Interfaces* (35), pp. 248–259.
16. Kresl, P.K. (2007). *Planning cities for the future: urban economic strategies in Europe*. Cheltenham, UK: Edward Elgar Publishing Limited.
17. Lee, S.Y., Florida, R., & Acs, Z.J. (2004). Creativity and Entrepreneurship: A Regional Analysis of New Firm Foundation. *Regional Studies* (38), pp. 879–891.

18. Matthiessen, C.W., Schwarz, A.W., & Find, S. (2002). The Top Level Global Research System, 1997–1999: Centers, networks and nodality. An Analysis based on bibliometric indicators. *Urban Studies* (39), S. 903–927.
19. PWC – PricewaterhouseCoopers. (2005). *Cities of the Future: global competition, local leadership*. Retrieved from PricewaterhouseCoopers-Website: [http://www.pwc.com/en\\_GX/gx/government-public-sector-research/pdf/cities-final.pdf](http://www.pwc.com/en_GX/gx/government-public-sector-research/pdf/cities-final.pdf)
20. Simon, C.J., & Nardinelli, C. (1996). The talk of the town: human capital, information and the growth of English Cities, 1861 to 1961. *Explorations in Economic History* (33), S. 384–413.
21. Turok, I. (2005). Cities, Competition and Competitiveness: Identifying New Connections. In N. Buck, I. Gordon, A. Harding, & I. Turok, *Changing Cities* (pp. 25–43). Palgrave Macmillan: New York.
22. van den Berg, L., Pol, P.M., van Winden, W., & Woets, P. (2005). *European cities in the knowledge economy: the cases of Amsterdam, Dortmund, Eindhoven, Helsinki, Manchester, Munich, Munster, Rotterdam and Zaragoza*. Aldershot, England: Ashgate Publishing Limited.
23. van den Berg, L., van Winden, W., & Pol, P. (2007, March). European Cities in the Knowledge Economy: Towards a Typology. *Urban Studies* (44), pp. 525–549.

**wethrive.net**

**How to retain your top staff**

**FIND OUT NOW FOR FREE**

**DO YOU WANT TO KNOW:**

- What your staff really want?
- The top issues troubling them?
- How to make staff assessments work for you & them, painlessly?

**Get your free trial**

Because happy staff get more done



# 4 City partnerships and networks

*A radically different order of society based on open access, decentralized creativity, collaborative intelligence, and cheap and easy sharing is ascendant. (David Bollier)*

Recommended additional reading:

- Abrahamsen, R. (2004). The power of partnerships in global governance. *Third World Quarterly*, 25(8), 1453–1467. Retrieved from EBSCO Host database.
- Habitat International (2009). Transnational city-to-city co-operation: Issues arising from theory and practice (Editorial). *Habitat International*, 33, 131–133. Retrieved from Science Direct database.
- De Villiers, J.C. (2006). Achieving the millennium development goals through city-to-city partnerships, origins, history and context of city-to-city partnerships, paper delivered at the 50th Anniversary Conference of Sister Cities International in Washington DC on 13 July 2006.

## 4.1 Chapter Overview

Having a look at current literature regarding city partnerships, it can be observed that lots of cities are linked to another city through partnership agreements (Villiers et al., 2007, p. 1). This chapter intends to give an overview of the concept of city partnerships and of its real importance for urban areas around the globe. Firstly, the terminology regarding city partnerships is introduced. Then, the origins and historical importance of city partnerships are explained and the status quo and trends relevant for this networking form are introduced. This is followed by a possible classification of city partnerships and a short description of important international organizations relevant for partner cities. Last but not least, existing literature on the topic is analyzed and key findings regarding city partnerships are summarized.

### Learning outcomes

By the end of this chapter successful students will be able to:

1. Use appropriate terminology
2. Understand the origins and historical importance of city partnerships
3. Recognize trends of city partnerships
4. Identify current literature on city partnerships.

## 4.2 Introduction

As the competitive environment within the EU becomes more and more intense, it is a major goal of many regions to keep their positions as high quality living and cultural areas, well-known industrial locations and popular centers of education and know-how. This competitiveness among different regions in Europe is especially problematic for cities or urban areas, as they are considered to be the key success factors within this competition. Searching for ways how to improve their so-called urban or regional competitiveness, many government officials have realized that their existing city partnerships might have – among others – the potential to support the achievement of their city's goals.

Having a look at city networking around the globe, it can be observed that nearly every city has closed some kind of international linkage today. Those links are usually made in the form of city partnerships, which are – expressed in simplified terms – an agreement between two or more parties (i.e. city councils or other urban administrations) that have agreed to work together for mutual benefit. However, in most cases, such city partnerships are seen as a mean of expressing friendship and furthering cultural exchange only, whereas their potential to contribute to a city's overall strategy is often neglected.

This chapter starts with a general introduction to strategic city management and city networking. In the beginning, the three most important forms of networking, namely networks, co-operations and partnerships are distinguished from each other. Afterwards, the focus is put on the third networking form, the partnerships solely. The origins and historical importance of city-to-city (C2C) partnerships are explained as they give valuable insights for understanding today's C2C linkages. This is followed by a description of the status quo and trends of city partnerships, which can be expected within the next years. Focus is put on the global dimension of C2C partnerships on the one hand and on insights into C2C links in Europe and between European countries on the other hand. Further sub-chapters hereafter deal with important international organizations, which are relevant for C2C networking partners, and a possible classification of C2C links in more detail. This classification is based on the dimensions geographical scope, co-operation structure, active participants, external support and objectives of C2C links nowadays. To conclude this chapter, existing literature about the topic is analyzed and key findings of other cities engaged in C2C co-operations are introduced.

## 4.3 Terminology

There is no generally accepted definition of city networking and its different forms in current literature. The variety of terms, which are used for this concept, is not simplifying the matter either (Habitat International, 2009, p. 131 as well as Villiers et al., 2007, p. 1). This sub-chapter tries to give an idea of what city networking is and how the different forms of networking can be distinguished from each other. Starting with some remarks on which types of networking can be observed nowadays and what characterizes them, the chapter will later on focus on one specific form of city networking, namely city partnerships, in particular. As the concept of city partnerships is of more relevance for strategic city management, two definitions provided by the United Nations Development Programme (UNDP) and the Council of European Municipalities and Regions (CEMR) will be introduced to the reader in detail.

Generally speaking, every formal agreement between two or more parties (i.e. cities or other urban administrations) that have agreed to work together in the pursuit of common goals can be assigned to the area of city networking. As it is with the parties to decide upon the scope of objectives, duration, membership and alteration of their networking agreement, it is of no wonder that city networking occurs in many different ways (UNDP, 2010), (Devers-Kanoglu, 2009, p. 202), (Hoetjes, 2009, p. 160). In current literature, the concept of cities engaged in networking is called city partnerships, city-to-city (C2C) networks, C2C co-operation, twinning, friendship link, sister cities, municipal partnerships, international co-operation, decentralized co-operation etc., which already demonstrates the wide variety of networking forms. In many cases and in many academic papers, these expressions refer to the same kind of relationship between cities and are used simultaneously without any respect to their difference in meaning. However, in the strict sense, those terms may refer to different kinds of city networking in terms of amount of involvement, commitment, objectives, duration and others. Ewijk and Baud (2009) give a good overview how to distinguish different networking forms from each other. In their opinion, the expression *city networking* is seen as an umbrella term, whereas the terms *networks*, *co-operations* and *partnerships* are different categories of city networking. This relationship between city networking, networks, co-operations and partnerships is illustrated in Figure 5.

**Struggling to get interviews?**

Professional CV consulting & writing assistance from leading job experts in the UK.

Visit site

 Take a short-cut to your next job!  
Improve your interview success rate by 70%.

 **TheCVagency**  
Visit [theagency.co.uk](http://theagency.co.uk) for more info.

 **Click on the ad to read more**



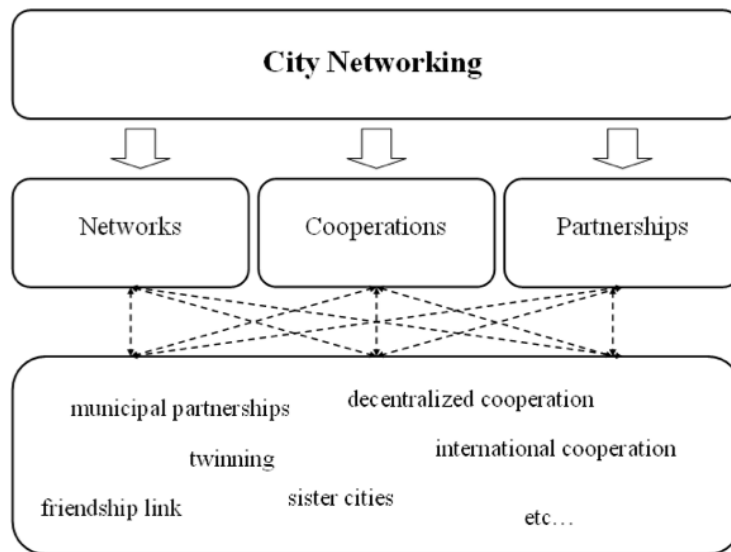

**Figure 5:** The Three Types of City Networking  
 Adapted from Ewijk and Baud, 2009, p. 220

As it can be seen above, city networking can be distinguished into three different forms, namely networks, co-operations and partnerships. Those three types of city networking have many synonyms on their part, which cannot be assigned to one of the three categories of city networking exactly. The difference between networks, co-operations and partnerships according to Ewijk/Baud (2009) are further explained throughout the following paragraphs.

### Networks

Besides C2C co-operations and partnerships, networks are one of the three different forms of city networking. According to Ewijk and Baud (2009), networks or C2C networks, are defined as a relatively loose form of international co-operation with horizontal information exchange, without hierarchy and without long-term commitments. Thus, they can be seen as the simplest form of international co-operation. Being engaged in C2C networks, cities or urban administrations usually benefit from information exchange within the network primarily. Furthermore, networks, which usually have a thematic and/or geographical focus, are oftentimes characterized by members, who contribute a lot to the overall goals, whereas other members only take but do not give. Examples for C2C networks are CITYNET or The Mega-Cities Project (Ewijk and Baud, 2009, p. 220), (Keiner and Kim, 2007, pp. 1370–1393). CITYNET, which is the Regional Network of Local Authorities for the Management of Human Settlements for Asian-Pacific countries, is a network which brings together local authorities in order to support them in effectively managing their urban development processes by exchanging expertise and experience among the members (CITYNET, 2010), (Hosaka, 1993, pp. 136–137), (Tjandradewi and Marcotullio, 2009, pp. 166–167). The Mega-City Project is a network of mega cities and organizations within those cities, which are trying to solve problems faced by such cities in the areas poverty, environment and participation (‘Mega-Cities Project’, 2010).

## Co-operations

Co-operations are seen as an organized interaction for a common end and mutual benefit. The expressions C2C co-operations, international co-operation and decentralized co-operation can be used synonymously. An international co-operation is seen to lay in-between of networks and partnerships and in practice, a line is oftentimes hard to draw (Ewijk and Baud, 2009, pp. 219–221). Especially when it comes to academic articles and scientific papers, the term *co-operation* is oftentimes used for every kind of link between two or more cities, making it nearly impossible to distinguish co-operations according to Ewijk and Baud's classification from other forms of networking activities (Ewijk/Baud, 2009, pp. 219–221), (Villiers, 2009, p. 149). Referring to Villiers et al. (2007), partnering agreements, which are called *co-operations* by the partners themselves, might also be partnerships according to Ewijk and Baud's definition. The concept of partnerships is described hereafter.

## Partnerships

According to Ewijk and Baud (2009), a partnership distinguishes itself from other forms of international linkages in the way that a partnership is a "...highly structured form of co-operation with long-term commitments, concrete activities, a form of contract and participating partners able to operate autonomously". Equality, power and trust between the partners should be the main aspects of every partnership (Ewijk and Baud, 2009, p. 220), (Hewitt, 1999, p. 30). Villiers (2009) argues that partnerships between cities are comparable to alliances between organizations as they are often characterized by shared objectives, focus on long-term strategic goals, joint decision-making, commitment of resources, creating advantages for both parties involved, and driven by the same forces than alliances between organizations such as globalization (Villiers, 2009, p. 150). The terms (town) twinning, friendship links or sister cities have the same meaning as partnership. A partnership is therefore besides networks and co-operations the form of international linkages with the strongest ties between the partners (Ewijk and Baud, 2009, p. 220), (Hewitt, 1999, p. 30).

As this chapter focuses on city partnerships in particular, two further definitions for this kind of international linkage are introduced at this point. The first definition was made by the United Nations Development Programme (UNDP); the second definition is from the Council of European Municipalities (CEMR).

First Definition – United Nations Development Programme (UNDP)

A definition, which might apply to all existing city partnerships, is the following made by the United Nations Development Programme (UNDP). The UNDP (2000) defines a city partnership or linking as “...a long-term partnership between communities in different cities or towns. A link is a relationship signifying mutuality. A link enables partner communities to engage themselves in matters of mutual interest and which they themselves determine. The agenda is open.” In this respect, the term community refers to citizens, the local government administration, community based organizations and other groups in rural or urban areas as well. The mutual interest can cover social, cultural, economic, technological or environmental issues and should lead to a situation, where both parties are able to learn and gain from each other (UNDP, 2000), (UN-Habitat & WACLAC [United Nations Human Settlements Programme & World Association of Cities and Local Authorities Coordination], 2003, p. 8). The most important part which characterizes a partnership is therefore mutuality (UNDP, 2000), (Johnson/Wilson, 2009, p. 216). The mutual interest is defined together by both cities as “generating positive stimuli for the economic development of both cities”. Besides several specific goals, the cities identified the exchange of information, experiences and co-operation in EU projects as the basis for the partnership. Thus, it fulfills all prerequisites for being a C2C link according to UNDP.

**gaiteye**  
Challenge the way we run

**EXPERIENCE THE POWER OF FULL ENGAGEMENT...**

**RUN FASTER.  
RUN LONGER..  
RUN EASIER...**

**READ MORE & PRE-ORDER TODAY  
WWW.GAITEYE.COM**



### Second Definition – Council of European Municipalities (CEMR)

The second definition regarding city partnerships was defined by the Council of European Municipalities and Regions (CEMR). According to CEMR (2008b), partnerships may be based on long-term twinning relationships – as the definition of the UNDP already reveals – but may also be limited to a defined period of time and a series of agreed activities or projects.

Altogether it can be said that the terminology regarding city networking can be really confusing and is not clearly defined in current literature. For this text, the terms C2C (project) partnerships, city/project partnerships, (international) co-operation, town twinning, twinning, twinning initiatives and C2C links are used synonymously to indicate the relationships between partner cities and project partners. Next, the current situation of city partnerships which are the relevant form of international co-operations is explained in more detail, starting with its origins and historical importance.

## 4.4 The Origins and Historical Importance of City Partnerships

Although C2C networks are due to the United Nations Millennium Goals and the increased commitment to problems of developing countries in more demand than ever before, the concept of cities co-operating with each other for mutual gain is nothing new (Keiner and Kim, 2007, p. 1372). Besides city alliances in ancient and medieval times, the present form of C2C linkages appeared after WWII. Constant development, increased professionalism and changes in terms of member countries, goals and motives throughout the decades after the last world war influenced the conclusion of new city partnerships considerably until the present form of C2C partnerships emerged (Hoetjes, 2009), (Buis, 2009, p. 191). The following paragraphs give a short summary about how C2C linkages and partnerships developed after WWII by referring to Hoetjes (2009), who identified six different layers or waves, which describe the changes in C2C networking during those decades.

### First City Partnerships after WWII (First Layer of City Partnerships)

To start with, cities always engaged in some kind of partnership with other cities for mutual gain throughout history – for example the German Hanseatic cities. However, the modern concept of city partnerships evolved after World War II only, when an initiative to overcome the deadlocked conflicts between European countries, the European continent and the US was strongly needed (EC, 2010), (Ewijk and Baud, 2009, p. 218). Building up friendships, promoting peace, cultural and sporting exchange, international understanding and reconciliation of the different nations were the main goals of twinning then (Ewijk and Baud, 2009, p. 218), (Villiers, 2006, pp. 2–3), (Hoetjes, 2009, pp. 157–159). Examples of some of the first links were partnerships closed between cities in the UK and Germany such as Bristol/Hanover or Oxford/Bonn (Villiers, 2006, p. 2). These first attempts of co-operation between war-participating countries had long-lasting consequences. According to the European Commission, “...[these twinning initiatives] were one of the most visible and lasting ways of bringing people from different countries together under the European banner” (EC, 2010a) and can be therefore seen as one of the first steps of European integration (EC, 2010a), (Villiers, 2006, p. 3), (CEMR, 2008a). Even until today, C2C linkages are used within the EU for drawing the different nations and cultures nearer to each other and for other political reasons (EC, 2010a), (Hoetjes, 2009, p. 159). Nonetheless, those first C2C partnerships were oftentimes limited to town halls and to an exclusive circle of politicians only, who met on a regular basis to deepen personal linkages and to facilitate cultural and sporting exchange. Many of the links closed during that period have become inactive over time (UNDP, 2000).

### City Partnerships during the 1960s, 70s, 80s and 90s (Second to Sixth Layer)

During the 1960s, 1970s, 1980s and 1990s, the mechanisms of town twinning became of different importance to the world. Due to changes in economy, culture and politics, twinning between industrialized countries in Europe and North America became less and less popular. The primary reasons for twinning, which led to the conclusion of partnership agreements after WWII, were mainly out of use and many different objectives such as community development, which were not covered by C2C partnerships yet, attracted the attention of cities more and more (CEMR, 2008b), (UNDP, 2000), (Villiers et al., 2007, pp. 1–2). Although the period between the 1960s–2000 was characterized by many different waves of city partnership closings, which resulted from different objectives, but still overlapped in time, five main layers for city partnerships could be observed. Figure 7 illustrates those waves of city partnership closures starting from WWII (CEMR, 2008b), (UNDP, 2000), (Hoetjes, 2009, pp. 158–159).

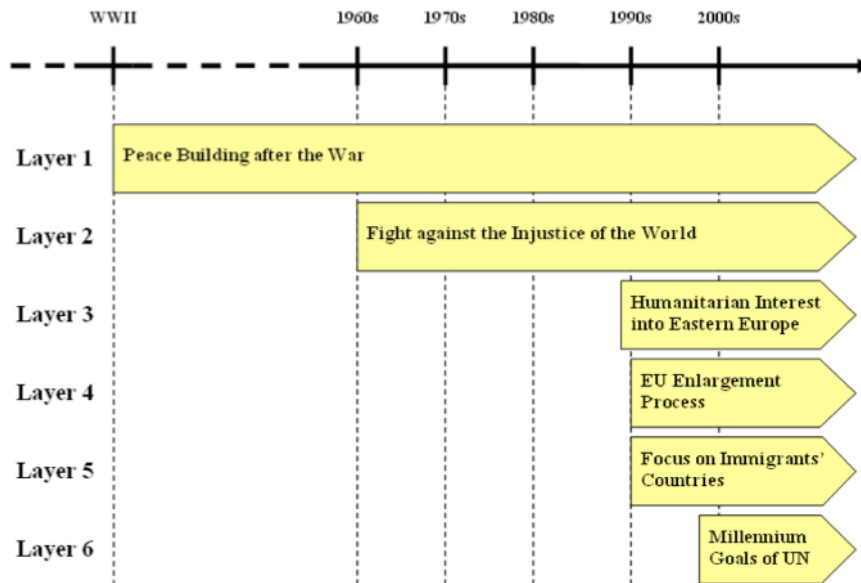

**Figure 6:** The Evolution of City Partnerships since WWII  
 Adapted from Hoetjes, 2009, pp. 158–159

Hoetjes (2009) concluded that after the first layer, which was driven by peace building after WWII, the desire to fight the injustice of the world system in favor of third world countries dominated partnership agendas in the 1960s (second layer). This was followed by a humanitarian interest into Eastern European countries after the fall of the Berlin wall leading to the conclusion of partnership agreements with cities located in that area (third layer). Both of those waves or layers were driven by civil society mainly and not by municipalities. Also in the 1990s, cities interested into C2C networking drew attention on Central and Eastern European countries because of the EU enlargement process (fourth layer). Furthermore, during the same time, cities started to establish contacts with municipalities, where their immigrants originated from (fifth layer) (Hoetjes, 2009, pp. 158–159). Besides the humanitarian and ideological reasons for closing C2C partnerships, it is also due to successful intervention by the UN that more and more city partnerships during the 1990s were not only set up between cities in industrialized countries anymore, but also with cities located in South America, Africa or Asia. These C2C networks are usually called North-South linkages in current literature, which refers to the fact that one sister city is located in one of the well-developed nations on the Northern hemisphere, whereas the other part is situated in developing countries in South America, Africa or Asia (UNDP, 2000), (Villiers, 2006, pp. 3–4), (Ewijk and Baud, 2009, p. 218), (Keiner and Kim, 2007, p. 1372). This trend is reflected in Hoetjes' sixth and last layer or wave, which, in his opinion, was mainly stipulated by the Millennium Campaign for Sustainable Development, which encourages municipalities to engage in C2C networking in order to achieve the UN Millennium Goals (Hoetjes, 2009, pp. 158–159). Buis (2009) summarized the motives for those layers. In his opinion there are three – the idealistic motive of peace and helping the poor, the political motive of supporting liberal movements or building opposition, and the economical motives of business opportunities, trade and investment.

In conclusion, it can be said that these six layers can be seen as the most important reasons why European and North American countries started to rethink their twinning strategies. Based upon those layers, further partnerships were usually closed after careful consideration only and for reasons, which might result into achieving practical results and long-lasting local development (CEMR, 2008b), (UNDP, 2000), (Hoetjes, 2009, p. 162). During the last years, C2C partnerships have become popular once again (Habitat International, 2009, p. 131). The reasons for this and the status quo of C2C links at the time being are described throughout the next chapter.

#### 4.5 Status Quo and Trends of City Partnerships

Today, the concept of partner cities “...[is] a global phenomenon, which encompasses friendship, solidarity, culture, awareness-building, international understanding, humanitarian assistance, sustainable development and...good governance” (UNDP, 2000). This status is a consequence of almost 70 years of twinning initiatives, which were signed because of the aforementioned reasons and which are still valid. Therefore, city partnerships can be seen as a very complex political phenomenon, which has not lost its attractiveness throughout the years. The following chapter focuses on the status quo and trends, which can be observed in connection with town twinning. The global aspects of C2C links are mentioned, and the European twinning situation is examined in more detail as well. After this, the question of what partnership agreements look like nowadays is answered.

This e-book  
is made with  
**SetaPDF**





PDF components for PHP developers

**www.setasign.com**



### The Global Perspective of City Partnerships

To start with, C2C partnerships are a global phenomenon today. According to the United Cities and Local Governments [UCLG], about 70 percent of the world's cities and towns participate in some kind of international C2C co-operation programme, which amounts to about 15,000 to 20,000 towns in total (UCLG, 2010, p. 13), (Villiers et al., 2007, p. 1), (Tjandradewi et al., 2006, p. 358). Especially throughout the last years, C2C links attracted the attention of local, national and supranational policy makers once more, who recognized the potential of C2C co-operations for poverty reduction, institutional strengthening, democracy and peace building, and knowledge exchange. The concept of "global citizenship" and the adoption of the UN Millennium Development Goals contributed to the importance of C2C partnerships as well (Habitat International, 2009, p. 131).

However, the UNDP (2000) highlights that, despite this focus on problems which mainly concern developing countries, C2C co-operations between industrialized and developing countries are still rare – i.e. the majority of existing links is still connecting northern, developed countries. Many European cities are a good example for this paradox, among them is also the City of Graz (Austria). The city has concluded 16 partnership agreements, nine of them with cities located in countries of the EU and another five with cities of other European countries. Only two partnerships include cities outside of Europe, Zababdeh located in the Palestinian National Authority and Montclair in the US (City of Graz, 2010). It can be observed that especially European cities tend to mainly establish links with neighboring or cross-border cities (Hoetjes, 2009, p. 161). For this reason, the following paragraphs give some more information about the current twinning situation within Europe.

### City Partnerships in Europe

Having a closer look on city partnerships in Europe, it can be noticed that only in Europe and between European countries, there have been about 34,000 listed twinning initiatives until now. The following exhibit, which was retrieved from CEMR's official website, shows the number of twinning initiatives per European country. Keeping in mind that CEMR only tracks European twinning initiatives, the numbers in Figure 8 show partnerships among European countries only; i.e. there is at least for each link one partner in another European country. Thus, the total number of twinning links in Europe and among European countries is estimated to be about 17,000 (CEMR, 2008a)



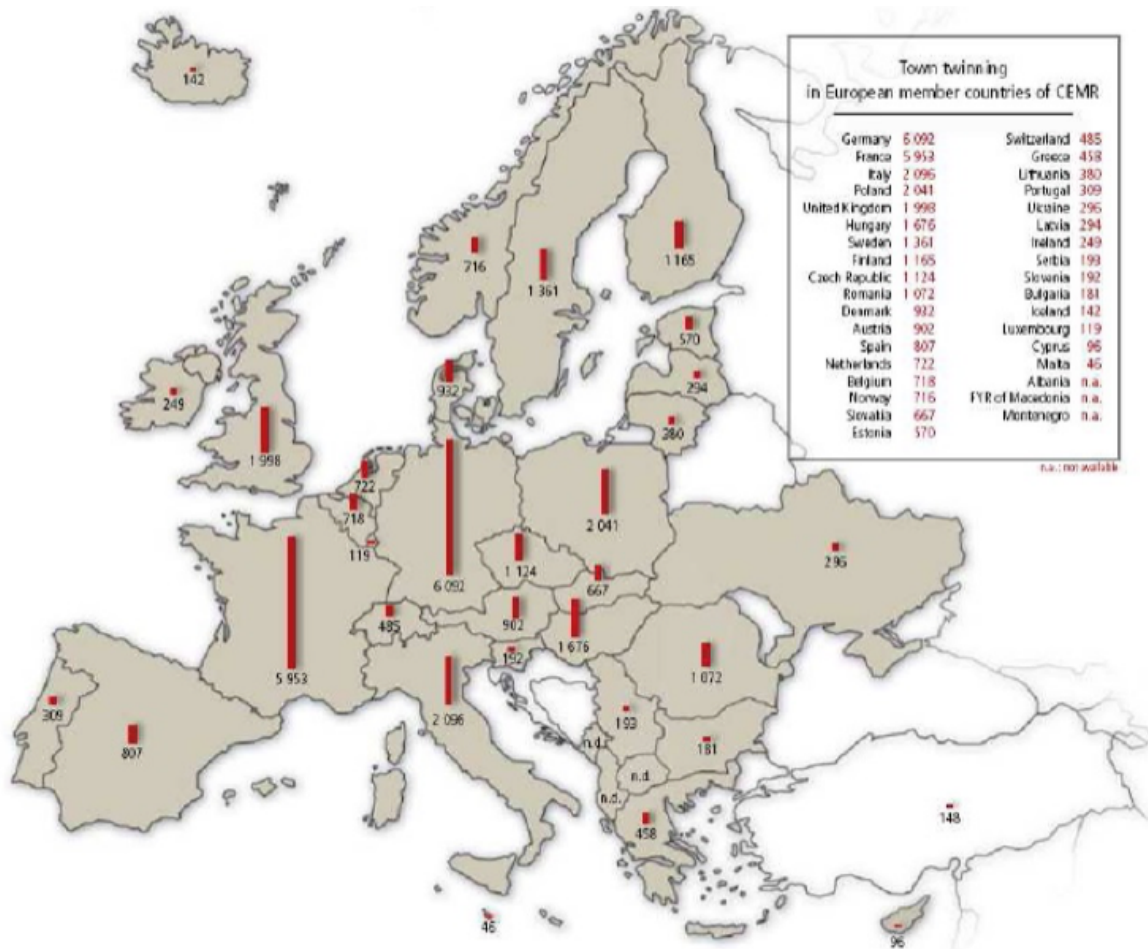

**Figure 7:** Town Twinning in Europe  
 Picture retrieved from CEMR, 2008a

As it can be seen above, Germany and France are the most active town twinningers among European countries. Both of them have around 6,000 twinning initiatives with other European countries and about 2,220 with each other. Other countries with a high number of twinning links are Italy, Poland, the UK, Hungary, Sweden, Finland, the Czech Republic and Romania with about 1,000 to 2,000 twinning partners. Austrian cities have 902 official linkages altogether (CEMR, 2008a).

Although the number of twinning links that currently exist is that high, it seems that no city partnership around the globe is like another. Partnerships vary in terms of participating parties, objectives, resources and many more, leading to the fact that the possible combination out of those factors seems to be unlimited. Nevertheless, there are still lots of similarities between partnership agreements, which can be categorized. The following chapter is focusing on that.

## 4.6 City Partnerships – Towards a Classification

Keeping in mind that city partnerships tend to be unique agreements between one or more parties, C2C links still have similarities with each other. This chapter therefore focuses on the content of C2C agreements and how such partnerships might be classified. In particular, a framework for classifying city partnerships is developed and the different categories of this classification are introduced to the reader.

### Developing the Framework

Thinking about the similarities between city partnership agreements in general, it can be said that all contract partners have to reach an agreement over the same issues, namely *Who are the parties involved? What are the goals and objectives of the partnership? What is the timeframe for the partnership? Who else shall/can participate in the partnership? Who else is supporting the partnership and how?* (UN-Habitat & WACLAC, 2003, p. 11). For facilitating reasons, these questions can be used to form categories for C2C partnerships, which could be used for classifying existing C2C (project) partnership agreements on their part. Table 2 summarizes those questions once again and illustrates how the questions could be transformed into categories.

# Free eBook on Learning & Development

By the Chief Learning Officer of McKinsey

[Download Now](#)

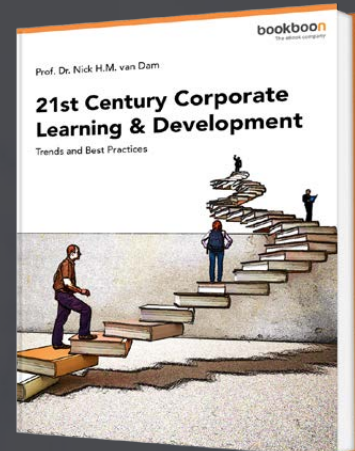

	<b>General Question</b>	<b>Sub-Question</b>	<b>Category</b>	<b>Dimensions within the Category</b>
<b>C2C Agreement</b>	<i>Who are the parties involved?</i>	Where are the partner cities located?	<b>Geographical Scope</b>	<ul style="list-style-type: none"> <li>- North-South</li> <li>- North-North</li> <li>- South-South</li> <li>- West-East</li> <li>- Global</li> </ul>
		How is the partnership structured?/How many cities participate?	<b>Co-operation Structure</b>	<ul style="list-style-type: none"> <li>- One-on-One</li> <li>- Groups</li> </ul>
	<i>What is the timeframe for the partnership?</i>	Is there a timeframe?	<b>Duration</b>	<ul style="list-style-type: none"> <li>- No specified ending (partnership agreement)</li> <li>- Specified ending (project partnership agreement)</li> </ul>
	<i>Who else shall/can participate in the partnership?</i>	Which internal and external participants are involved into the partnership?	<b>Active Participants</b>	<ul style="list-style-type: none"> <li>- Local authorities</li> <li>- NGOs</li> <li>- Private sector</li> <li>- Academic, research</li> <li>- National associations of local authorities</li> </ul>
	<i>Who else is supporting the partnership and how?</i>	Where does the support come from?/In which form does the support come?/Why do the partner cities receive external support?	<b>External Support</b>	<ul style="list-style-type: none"> <li>- Type of external support</li> <li>- Geographic focus</li> <li>- Funding and resources</li> <li>- Facilitating institutions</li> </ul>
	<i>What are the goals and objectives of the partnership?</i>	-	<b>Objectives</b>	<ul style="list-style-type: none"> <li>- social</li> <li>- cultural</li> <li>- economic</li> <li>- technological</li> <li>- environmental issues</li> </ul>

**Table 2:** Classification of C2C Links  
 Adapted from UN-Habitat & WACLAC, 2003, p. 11

As it can be seen above, every C2C link can be classified according to six categories. The categories are the geographical scope of the C2C agreement, the co-operation structure, the duration of the partnership, the objectives, the participants actively involved into the partnership and external supporters. The first category, the geographical scope of a partnership agreement, refers to the geographical location of the partners. It can be either North-South, North-North, South-South, West-East or global. C2C links can have two forms of co-operation structures, namely a one-on-one form or a group structure. Furthermore, active participants involved into the partnership can be local authorities, NGOs, individuals and companies from the private sector, academics, researchers, or national associations of local authorities. Next, external support has got several sub categories, which involve the type of external support, the geographic focus of the support, funding and resources, and the facilitating institutions. Finally, objectives tend to differ widely. The most commonly used are focused on social, cultural, economic, technological or environmental issues (UN-Habitat & WACLAC, 2003, p. 11). The different categories are described throughout the following paragraphs in more detail.

### Geographical Scope

Starting with the geographical scope, links can be categorized by using the city's geographical location. Partnership agreements can be either North-North, North-South, South-South, West-East or global linkages. This classification is used in many academic articles and other publications regarding city partnerships as well. In this case, a North-North linkage means that both partners are located in well-developed countries in the north, e.g. the partnership agreement between Graz (Austria) and Darmstadt (Germany) is a North-North link (UNDP, 2000), (UN-Habitat & WACLAC, 2003, p. 8), (City of Graz, 2010). A North-South linkage refers to the fact that one sister city is located in one of the well-developed nations on the northern hemisphere, whereas the other part is situated in developing countries in South America, Africa or Asia (UNDP, 2000), (UN-Habitat & WACLAC, 2003, p. 8). Hewitt (1999) is evaluating such a North-South link. In his case it is Toronto (Canada) and Sao Paulo (Brazil). Accordingly, a South-South partnership is a partnership between cities located on the southern hemisphere and a West-East link is an agreement between a well-developed city on the western part of the northern hemisphere and a town on the eastern part of the northern hemisphere such as Eastern Europe or the Middle East (UNDP, 2000), (UN-Habitat & WACLAC, 2003, p. 8). Having a look at Graz's partner cities, it can be noticed that most of the agreements can be categorized as North-North linkages while only a few, such as the project partnership agreement with Zababdeh which is located in the Palestinian National Authority, are North-East based (City of Graz, 2010).

### Co-operation Structure

The co-operation structure between the partners is another point, which distinguishes city partnerships from each other. The structure can be either one-on-one or a group structure, meaning that the city partnership or project partnership agreement can involve only two cities or a group of cities. At this point, it has to be noted that city partnerships, which are formed by a group of cities, are not equal to city networks, which were described in sub-chapter 4.3 ‘Terminology’ (UN-Habitat & WACLAC, 2003, p. 8). All of Graz’s partner links, except the one with Darmstadt and Trondheim, are examples for a one-on-one structure, which means that the city has closed agreements with only one city at a time – every link, except with the two cities mentioned before, is verified in an own agreement.

### Active Participants

Furthermore, active participants can also vary from partnership to partnership. Possible actors besides the parties who sign the partnership agreement, can be local authorities, NGOs, people or companies from the private sector, academics and researchers, and/or national associations of local authorities (UNDP, 2000), (UN-Habitat & WACLAC, 2003, p. 8). The City of Graz determined several possible participants in its internationalization strategy (City of Graz 2006). Accordingly, possible partners might be the ‘Internationalisierungszentrum Steiermark (ICS)’, the universities and universities of applied sciences, the province of Styria, as well as the diplomatic missions of the respective countries or regions (City of Graz, 2006, pp. 1–6).

**YOU THINK.  
YOU CAN WORK  
AT RMB**

**RAND  
MERCHANT  
BANK**  
A division of FirstRand Bank Limited  
Traditional values. Innovative ideas.

Rand Merchant Bank uses good business to create a better world, which is one of the reasons that the country’s top talent chooses to work at RMB. For more information visit us at [www.rmb.co.za](http://www.rmb.co.za)

Thinking that can change your world

Rand Merchant Bank is an Authorised Financial Services Provider



Click on the ad to read more

## External Support

Although projects, which are based on a C2C co-operation agreement, are in the sole responsibility of the contract partners, there are several national, international and private organizations which might support the partners in the achievement of their goals. Examples are national/international NGOs such as Sister Cities International, national governments, the World Trade Organization (WTO), the World Bank, the EU, professional organizations and many more. These institutions can support the project partners in different ways without being in the position to influence the (project) partnership agreement itself. Possible supportive measures by those institutions are strategic capital investments, training and human resource development, consulting in various fields etc. Financial support could come in the form of grants, loans or the allocation of individual budgets. Additionally, many organizations have projects with special geographic focus, for example for Latin America or North Africa. The Phare Programme provides a practical example in this context (UNDP, 2000), (UN-Habitat & WACLAC, 2003, p. 8), (EC, 2010b), (Andreasson and Königson, 2009, p. 1–2). According to Bontenbal (2009), external support by such organizations is especially important for small and medium-sized municipalities, which are oftentimes limited in their financial resources, whereas large cities are able to come up with budgets for international co-operations on their own (Hoetjes, 2009, pp. 160–161). Johnson and Wilson (2009) examined the case of two partnerships between cities located in the UK and Uganda, one of them was mainly funded by the World Bank (Johnson and Wilson, 2009, p. 211). At this point, it seems to be necessary to refer to the sub-chapter “External Institutions Interested into City Partnerships”, which also includes some remarks on the aforementioned Phare Programme.

## Objectives

Last but not least, the partnership’s objectives are another important point, which has to be discussed by the partner cities and which might be used for classifying existing partnership agreements. Regarding objectives, it has to be said that according to the partner cities’ location and the period in which the partnership agreement was concluded, objectives tend to differ widely. It seems that many city partnerships, especially among North-North partners, have less stringent objectives like goodwill or friendship, whereas others, usually North-South linkages, are based on very specific goals and timeframes (UNDP, 2000). Focusing on the first group of partnerships, which were mainly set up in the post-war era until the 1980s, it seems that today, those contacts are mainly used for cultural, sportive and educational purposes. Examples could be invitations for festivals, exhibitions and competitions, or exchange programmes for students, certain occupational groups or others. For the latter group, which mainly includes partnerships closed throughout the last decades, the most common objectives are related to community development and the assistance cities can give to each other in various other areas. Those might refer to meeting basic needs, awareness-raising, municipal capacity-building, matters of governance, strengthening local democratic institutions and furthering wider community participation in every aspect of city life (UNDP, 2000), (Hewitt, 1999, pp. 27–28), (Villiers et al., 2007, p. 2), (Buis, 2009, pp. 190–194). As those are some of the most popular objectives used for newly closed C2C co-operations, they shall be described briefly hereafter.

**Meeting Basic Needs.** Firstly, in terms of meeting basic needs, the improvement of living conditions connected with the development of basic urban services such as health care for poor people is one of the most vital aspects tackled in international C2C co-operation – especially in North-South partnerships (Bontenbal and Lindert, 2008, pp. 465–467). However, this objective is seen to be quite controversial as it was observed that large international NGOs are able to cover the same topics in an oftentimes more professional way than it is possible for city administrations (Nitschke et al., 2009, p. 138). Volunteer involvement in international co-operations might be decreased therefore, as it seems to be more efficient to engage professionals for doing the same job (Hoetjes, 2009, p. 162).

**Awareness-Raising.** Next another, oftentimes underestimated factor is awareness-raising. Awareness-raising takes place when people work together closely over a longer period of time. Getting more and more involved with the other parties' problems and way of thinking, urban and private actors involved into the twinning initiative start to build up cultural understanding. Pointing out the fact that many town twinning agreements were closed between cities with constant migration flows, cultural understanding built during town twinning projects can be used to facilitate the integration of these migrants into the own community (Ewijk and Baud, 2009, p. 219), (Hewitt, 1999, p. 30), (Lindert, 2009, pp. 173–174). Lindert (2009) notes that awareness-raising is also linked to fund-raising in many cases and is therefore the aim of many partnerships as well.



Discover the truth at [www.deloitte.ca/careers](http://www.deloitte.ca/careers)

**Deloitte.**

© Deloitte & Touche LLP and affiliated entities.



Click on the ad to read more

**Municipal Capacity-Building, Matters of Governance, Strengthening Local Democratic Institutions and Furthering wider Community Participation.** Lastly, municipal capacity-building, matters of governance, strengthening local democratic institutions and furthering wider community participation in every aspect of city life are strongly interrelated with each other. Municipal capacity-building means building up and developing local urban administrations – a precondition for everyday life in urban areas. This objective is especially popular with countries which had to face a major political swift in recent years, for example former Soviet nations, which transformed from Communist ruling to democracy (Bontenbal, 2009a, pp. 181–182), (Bontenbal, 2009b, pp. 100–101), (Bontenbal and Lindert, 2008, p. 467), (Lindert, 2009, p. 173). According to Abrahamsen (2004), one of the greatest challenges of municipal capacity-building is to avoid exporting (northern) administration structures or plans. It is the task of the more developed partner to assist the less developed city administration in developing their own structure, which shall respond to the city's individual challenges, instead of providing a developed solution. Next, objectives related to matters of governance are mainly popular with North-South linkages and good governance can help to increase the quality of live in urban areas and to decrease poverty (Bontenbal and Lindert, 2008, pp. 465–467), (Bontenbal, 2009b, p. 100–101). Furthermore, furthering wider community participation in every aspect of life is another objective which can be tackled by C2C co-operations. On the one side, the partner, who is in need of more community participation, can be supported in efficiently responding to its citizens' needs and in encouraging them to contribute actively to the city's management. Thus, people learn that everybody can contribute his or her part to improve the society. Furthermore, it can be said that decisions, which influence the people's life a lot, should only be made after the people's opinion is considered as well. On the other side, the partner, who is giving the assistance to the one who is in need of more community participation, gets the chance to involve its citizens actively in the partnership initiative in order to create awareness locally and to foster the idea of global citizenship (Bontenbal, 2009a, p. 182), (Bontenbal and Lindert, 2008, p. 469–470).

To sum it up briefly, although C2C partnerships are unique agreements between two or more parties, it is still possible to identify similarities between such international links. Those can be observed in particular when having a look at the geographical scope of the agreement, the co-operation structure, the duration of the partnership, active participants involved, external support and objectives, as every city partnership agreement usually focuses on those areas. As it was already mentioned before, city partnerships are not only supported by the parties, who signed the agreement, but might also attract the attention of others, mainly supranational organizations. The most important ones are introduced throughout the next chapter.



## 4.7 External Institutions Interested into City Partnerships

According to the UNDP (2000), city partnerships are determined by the partner cities solely. However, there are numerous national and international organizations who support and/or influence partnerships as well. This support can come in the form of financial assistance, training, consulting and others – usually combined with rules and regulations (UN-Habitat & WACLAC, 2003, p. 8). Some of the most important organizations and institutions are for example the UNDP, the European Commission, or People to People International and Sister Cities International. All of them are described briefly at this point.

### UNDP

The United Nations Development Programme (UNDP) is a UN organization responsible for supporting countries in finding solutions for global and national development challenges. Advocating the UN member states, developing strategies and monitoring their progress are the core areas of the organization. The UNDP focuses on the achievement of the UN Millennium Development Goals. Special attention is paid to the areas of local capacity, democratic governance, poverty reduction, crisis prevention and recovery, environment and energy, HIV/AIDS, and the empowerment of women. The UNDP uses networks and connects countries for knowledge, experience and resource exchanges. Town twinning was named by the organization as one important tool in order to achieve those goals and is therefore supported by the organization (UNDP, 2010), (Nitschke et al., 2009, p. 136).

### European Commission

For countries within the EU, town twinning is supported by various EU programmes. Among them are for example the ‘Europe for Citizens programme’, which is part of the union’s Citizens’ Policy, or the Phare programme which is focused on the Union’s enlargement process. Both of those programmes will be described shortly at this point to give an idea how town twinning can be integrated into large scale programmes.

**Europe for Citizens Programme.** To start with, the current Europe for Citizens programme is open for all EU members and Croatia for the period 2007 to 2013, following the programme of period 2004 to 2006. Further potential candidates for this EU initiative include Iceland, Liechtenstein, Norway, Macedonia, Turkey, Albania, Bosnia and Herzegovina, Montenegro, Serbia and Kosovo (EC, 2009, pp. 4–5), (EC, 2009, pp. 19–20). The Europe for Citizens programme seeks to encourage European citizens to be actively involved into the process of European integration, to develop a common sense of European identity and to enhance mutual understanding. Besides participatory citizen’s projects, town twinning is explicitly named as a tool to achieve these goals. Town twinning projects, which show a commitment to European integration, which build friendships and which promote active participation among citizens, are granted with EU funds. In 2003 for example, 1,328 out of 2,136 projects were selected for the programme with most of them taking place in France (347), Germany (338), and Italy (175) (EC, 2010).

**Phare Programme.** On the other side, the Phare programme is focused on the Union’s enlargement process and the preparation of candidate and potential candidate countries for membership in the EU. For the time being, candidate countries are Croatia, Iceland, Macedonia, Montenegro and Turkey. Potential candidate countries are Albania, Bosnia and Herzegovina, Kosovo and Serbia. Projects covered by Phare include institutional and capacity-building in the candidate countries. This shall ensure that the candidate countries can adapt to the Union’s *acquis communautaire* (The *acquis communautaire* is the body of common rights and obligations in the European Union). Twinning initiatives are one of the programme’s main instruments to meet these objectives (EC, 2010b), (European Parliament, 4 December 1998), (Dixelius/Haglund, 2003, pp. 3–4).

People to People International and Sister Cities International

People to People International (PTPI) and Sister Cities International (SCI) are both US non-profit organizations, which want to promote peace through creating and strengthening partnerships between citizens of US and international communities. Going back on Eisenhower’s citizen diplomacy initiative, mutual understanding, peace and co-operation among people and communities are the goals of the two organizations. Whereas PTPI is focused on connecting individuals, SCI is concentrating on cities, counties and states (SCI, 2010), (PTPI, 2011).

[bookboon.com](http://bookboon.com)

# Corporate eLibrary

See our Business Solutions for employee learning

[Click here](#)

Management      Time Management

Problem solving      Self-Confidence      Effectiveness

Project Management      Goal setting      Motivation      Coaching

Click on the ad to read more

These organizations are some of the most prominent supporters of twinning initiatives at the time being. However, there are many more. After this general introduction to city partnerships, its historical evolution, the status quo, city partnership agreements and organizations supporting C2C initiatives, the following chapter summarizes concluding remarks on the topic of city partnerships by focusing on key findings made by cities engaged into city partnerships.

#### 4.8 Findings Regarding City Partnerships in the Literature

Besides many official publications from organizations such as the UN and the EU, which primarily focus on development issues, city networks, projects and financial support, current literature about city partnerships is oftentimes analyzing and evaluating existing partnerships and projects. Some of the most important findings out of those papers are introduced at this point in order to conclude the theoretical introduction to city partnerships. These lessons learned by different European municipalities give an idea of what a city has to take care of when dealing with city partnerships. In particular, the following paragraphs discuss the issues of prerequisites for successful city partnerships, mutuality and equal distribution of power, and selecting objectives and working on projects. Furthermore, a model developed by Villiers (2009) regarding the formation and management of C2C partnerships is introduced.

##### Prerequisites for Successful City Partnerships

According to various authors, the prerequisites for successful C2C partnerships and C2C partnership projects are, on the one hand, enough resources and, on the other hand, dedication of the parties involved.

**Resources.** In the case of city partnerships, current literature implies that necessary resources for networking activities are not only money, but also time, staff and expertise. In terms of money, Nitschke et al. (2009) highlight that municipalities are oftentimes not able to support their partner cities to a full extent as the legal security and the financial support by the government does not allow for it. Furthermore, they say that limited financial resources and structural changes in municipalities diminish the dedication to support other communities (Nitschke et al., 2009, p. 135). This is also supported by Bontenbal (2009b), who notes that especially small and medium-sized municipalities are limited in their efforts. Additionally, she also mentions that “clear political mandate for international co-operation, the human capacity available [...] and the extent of additional external funding” are the key factors for twinning in a northern partner town. For the south, she argues that an international co-operation department has to be in place, which is able to facilitate, promote and sustain international contacts (Bontenbal, 2009b, p. 103). Besides financial aspects, high staff turnover in projects is also a challenge (Tjandradewi et al., 2006, p. 372). Thus, it can be said that more resources might also lead to better outcomes (Wallberg, 2000, p. 27), (Nitschke et al., 2009, p. 137), (Hewitt, 1999, p. 42). Additionally, Ewijk and Baud (2009) mention the importance of the resources’ perceived usefulness in order to increase the potential for mutual learning, co-operation and successful projects (Ewijk/Baud, 2009, p. 220), and Tjandradewi (2009) highlights community-wide participation (Tjandradewi et al., 2006, p. 360), (Tjandradewi/Marcotullio, 2009, p. 168).

**Dedication.** Dedication is another key factor for successful C2C initiatives. Johnson and Wilson (2009) give a good example, which combines the problem of limited financial resources and dedicated project partners. In their article “Learning and mutuality in municipal partnerships and beyond: A focus on northern partners”, they examine amongst others the partnership between Iganga in Uganda and Daventry in the UK. The partnership project between the two cities ended in 2000 because of financial reasons. However, afterwards the “Daventry Friends of Iganga” NGO was founded by engaged officers, politicians and other members of the community in order to work on projects with and for Iganga in their spare time (Johnson/Wilson, 2009, p. 211), (Hoetjes, 2009, p. 161). Dedication is also related to mutual understanding. Parties, who have developed mutual understanding, are able to better understand their counterparts and to partly overcome other inequalities such as cultural differences. Thus, the parties are more willing to invest time and resources into the project and the co-operation is more likely to succeed. This is also supported by Buis (2009), who argues that understanding each other, each other’s circumstances and challenges together with high political commitment on both sides establish the most important prerequisite for success in C2C partnerships. Bontenbal (2009b) concludes that mutual understanding can be oftentimes traced back to the fact that partners had to face the same situations or share other characteristics with each other. Therefore, C2C partnership projects are seen to be more successful in general when the parties have common problems or share other things with each other (Bontenbal, 2009b, p. 105), (Wallberg, 2009, p. 9), (Hewitt, 1999, p. 31), (Hosaka, 1993, p. 135), (Tjandradewi et al., 2006, pp. 361–362). This is also supported by the UNDP, which suggests that mutual understanding and reciprocity are preconditions for successful C2C co-operations (Ewijk/Baud, 2009, p. 220), (Tjandradewi/Marcotullio, 2009, p. 168), (Tjandradewi et al., 2006, p. 360). In this context, Ewijk/Baud (2009) mention that partnerships focusing on migrant countries have advantages over other north-south links. However, although similarities between the partners are good for mutual understanding, differences are important for learning opportunities as well (Johnson/Wilson, 2009, p. 212), (Devers-Kanoglu, 2009, p. 204). Villiers et al. (2007), who tried to validate observed success factors of city partnerships through empirical testing, also came to the conclusion that partner commitment, understanding, cultural sensitivity, positive partner attitude, and similarities of personalities on both sides have a significant positive impact on the success of partnerships (Villiers et al., 2007, pp. 9–10).

### Mutuality and Equal Distribution of Powers

One aspect, which is heavily criticized throughout existing literature, is the fact that C2C partnerships still lack mutuality and equal distribution of powers, especially when it comes to north-south partnerships. The northern partner usually retains the power because of money, expertise and information, whereas the southern partner is oftentimes forced to accept what the northern partner is dictating. Thus, it can be said that the north is usually the donor whereas the south is the recipient in what they call a partnership (Bontenbal, 2009b, p. 105), (Abrahamsen, 2004, p. 1454), (Bontenbal and Lindert, 2008, p. 479), (Ewijk and Baud, 2009, p. 220), (Devers-Kanoglu, 2009, p. 207), (Hewitt, 1999, p. 42). Although there are already tendencies that the less developed partner is heavily integrated into the project development phase, much has to be done yet (Abrahamsen, 2004, p. 1459), (Hosaka, 1993, p. 133). This problem of unequal distribution of powers is that significant because projects, which were developed only by one party, are more likely to fail. According to the World Bank, which was cited in Abrahamsen (2004), this is especially true when it comes to policy and institutional reforms as those should not be imported or imposed, but must be home grown. Therefore, Johnson and Wilson (2009) suggest that this inequality in distribution of powers should be replaced by new relationships and engagement on both sides. Thus, also conflicts between the two partners could be reduced (Bontenbal and Lindert, 2008, pp. 379–380). Furthermore, mutuality implies that information sharing must not be a one way flow from north to south, but should involve both parties. According to Ewijk and Baud (2009) and Devers-Kanoglu (2009), there are several learning possibilities for more developed partners as well. Among them is for example gaining information about innovations in less developed governances (Ewijk and Baud, 2009, p. 221), (Devers-Kanoglu, 2009, p. 202). Buis (2009) concludes that open discussion of motives, joint analysis of problems, joint steps in implementation, joint review of progress, and joint monitoring and evaluation are necessary for successful partnerships.

### Selecting Objectives and Working on Projects

Next, the question of which objectives to choose and how to work on projects is another issue, which was already discussed by various researchers. In general, it can be said that it seems that some objectives are better for co-operations between certain cities than others (Tjandradewi and Marcotullio, 2009, p. 168). Municipalities are often more willing to work on projects in areas with which they are familiar with. To give an example, Andreasson and Königson (2003) examined Swedish twinning initiatives aimed at improving living conditions for the urban poor in slums of developing countries. They noted that only six out of the 33 projects, which they evaluated in their paper, were slum-related, the rest focused on other issues. They concluded that the reason for this could have been that Swedish municipalities have no practical experiences with slum-related problems and were therefore also not able to share relevant knowledge about it. In their case, the general focus on improving living conditions for the urban poor has therefore been shifted towards other objectives, which were more familiar to Swedish municipalities (Andreasson and Königson, 2003, p. 1). Accordingly, it can be said that it might make more sense if the twinning co-operation's objectives are selected by the parties who are directly involved into the project as objectives, which are set by external partners or only one party, are sometimes out of touch with reality. This is also true for financial issues. More precisely, budgets or funds allocated by external institutions, which oftentimes come hand in hand with external regulations regarding the length of a project or others, might not fit to the situation and the twinning partnership at hand. Another problem is established by definitions that are made by such external partners. The terms *achievement* and *development* might be mistaken by one or more parties involved into the twinning initiative – purpose and results of the partnership have to be clear to both sides (Buis, 2009, p. 192), (Wallberg, 2000, pp. 2–4), (Lindert, 2009, p. 173). Furthermore, projects and objectives, which were set by only one twinning partner – usually in the north, are also more likely to fail. The reason for this is that those projects are sometimes not targeted on what really has to be done in the partner municipalities (Nitschke et al., 2009, p. 139). The northern partner should keep clearly in mind that southern municipalities have their own expectations and ideas about what has to be done (Bontenbal, 2009b, p. 103). Additionally, it has to be mentioned that Villiers et al. (2007) proved empirically that partnerships are more likely to succeed where projects are based on a business plan as well as extensive communication and where the management of the partnership is of high quality (Villiers et al., 2007, pp. 9–10), (Villiers, 2009, p. 150). Buis (2009) mentioned regular contact as a success factor as well.

As those lessons learned seem to be relevant, the most important issues of this chapter are summarized in the following table.

<p><b>Prerequisites for Successful City Partnerships</b></p>	<p><b>Resources</b></p> <ul style="list-style-type: none"> <li>- Money, staff and expertise</li> </ul> <p><b>Dedication</b></p> <ul style="list-style-type: none"> <li>- Of all parties involved</li> <li>- Compensates lack of resources to a certain extent</li> <li>- Mutual understanding</li> </ul>
<p><b>Mutuality and Equal Distribution of Powers</b></p>	<ul style="list-style-type: none"> <li>- Donor vs. recipient of money, expertise and information – has to be avoided</li> <li>- Mutual project development leads to better results and less conflicts</li> <li>- Two-way flow of information</li> </ul>
<p><b>Selecting Objectives and Working on Projects</b></p>	<ul style="list-style-type: none"> <li>- Choose familiar topics</li> <li>- Objectives and financial issues have to be developed by the partner cities and not dictated by one party</li> <li>- Regular contact and extensive communication</li> <li>- Having a plan and good management of that plan</li> </ul>

**Table 3:** Findings Regarding City Partnerships Retrieved from Current Literature

In addition to those learnings, Villiers (2009) has developed a conceptual framework of city-to-city partnership formation and management, which is described in the following text.

**Brain power**

By 2020, wind could provide one-tenth of our planet's electricity needs. Already today, SKF's innovative know-how is crucial to running a large proportion of the world's wind turbines.

Up to 25 % of the generating costs relate to maintenance. These can be reduced dramatically thanks to our systems for on-line condition monitoring and automatic lubrication. We help make it more economical to create cleaner, cheaper energy out of thin air.

By sharing our experience, expertise, and creativity, industries can boost performance beyond expectations. Therefore we need the best employees who can meet this challenge!

The Power of Knowledge Engineering

Plug into The Power of Knowledge Engineering. Visit us at [www.skf.com/knowledge](http://www.skf.com/knowledge)

**SKF**



Villiers' Conceptual Framework of C2C Partnership Formation and Management

The following figure, which was developed by Villiers (2009), illustrates six steps for effective formation and management of C2C partnerships, namely (1) strategize, (2) identify, (3) evaluate, (4) negotiate, (5) implement and learn, and (6) alliance capability.

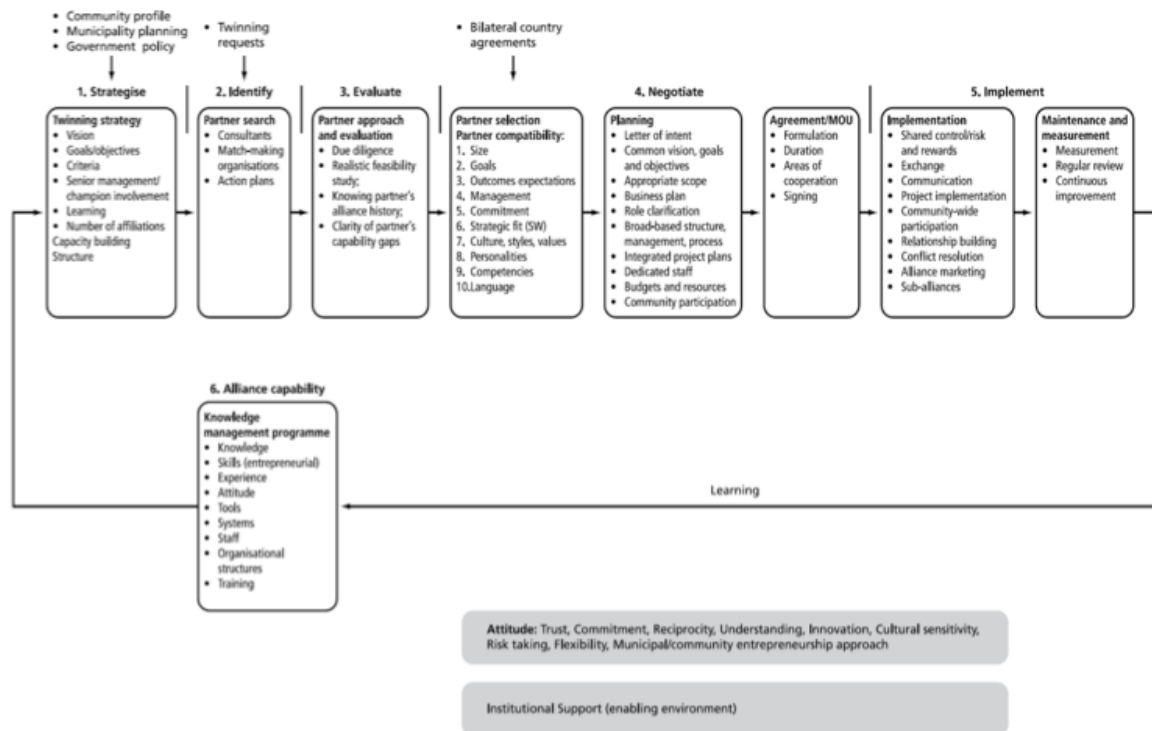

**Figure 8:** A Conceptual Framework of C2C Partnership Formation and Management  
 Picture retrieved from Villiers, 2009, p. 151

Step 1 'Strategize' suggests that every city, which wants to be connected to other cities via partnership agreements, needs to formulate a general alliance strategy first of all (i.e. an internationalization strategy) and determine criteria for partner selection. Then, step 2 'Identify' can follow, which refers to looking for possible partner cities that meet the criteria determined throughout the alliance strategy. Furthermore, those cities have to be evaluated (step 3 'Evaluate'), and preferred partners selected (step 4a 'Negotiate'). This is followed by a negotiation phase and the signing of an agreement (step 4b and step 4c 'Negotiate'). Afterwards, step 5 'Implementation' starts. This phase includes the co-operations between the partners (step 5a), and further the maintenance and measurement of the relationship (step 5b). In the end, the city should learn from that process and develop alliance capability through experience, which might influence the city's alliance management in future. Thus, this framework can be seen as an ongoing cycle (Villiers, 2009, pp. 151–154).

Altogether it can be said that those lessons learned by different municipalities, which were located in European countries mainly, provide insights on avoiding and/or solving problems related to city partnership activities.



## 4.9 References

1. Abrahamsen, R. (2004). The power of partnerships in global governance. *Third World Quarterly*, 25(8), 1453–1467. Retrieved from EBSCO Host database.
2. Andréasson, B. & Königson, L. (2003). *Sida's program twinning co-operation between municipalities in Sweden and in countries of the South – Sida Evaluation 03/39*. Stockholm/Sweden: Swedish International Development Co-operation Agency (SIDA). Retrieved from OECD database.
3. Bontenbal, M. & Lindert van, P. (2008). Bridging local institutions and civil society in Latin America: Can city-to-city co-operation make a difference? *Environment and Urbanization*, 20, 464–481. Retrieved May 7, 2010, from Sage Publications database.
4. Bontenbal, M. (2009b). Understanding North-South municipal partnership conditions for capacity development: A Dutch-Peruvian example. *Habitat International*, 33, 100–105. Retrieved May 7, 2010, from Science Direct database.
5. Buis, H. (2009). The role of local government associations in increasing the effectiveness of city-to-city co-operation. *Habitat International*, 33, 190–194. Retrieved from Science Direct database.
6. CEMR (Council of European Municipalities and Regions). (2008). Town Twinning. Information available from CEMR's webpage <http://www.ccre.org/en/actualites/view/2434>
7. CITYNET. (2010). Information available from CITYNET's official website <http://www.citynet-ap.org/>

With us you can  
shape the future.  
Every single day.

For more information go to:  
[www.eon-career.com](http://www.eon-career.com)

Your energy shapes the future.

**e-on**



8. City of Graz. (2010). Information available from City of Graz's official website <http://www.graz.at/>
9. City of Graz. (2006). *Internationalisierungsstrategie (Internationalization Strategy)*. Graz (Austria): Referat für internationale Beziehungen (Office for International Relations).
10. Devers-Kanoglu, U. (2009). Municipal partnerships and learning: Investigating a largely unexplored relationship. *Habitat International*, 33, 202–209. Retrieved from Science Direct database.
11. Dixelius, P. & Haglund, P. (2003). *Promotion of the Swedish participation in EU phare-twinning – Sida Evaluation 03/14*. Stockholm/Sweden: Swedish International Development Co-operation Agency (SIDA). Retrieved from OECD database.
12. EC (European Commission). (2009). Europe for Citizens Program 2007–2013: Program guide. Document available from EC's webpage [http://eacea.ec.europa.eu/citizenship/programme/programme\\_guide\\_en.php](http://eacea.ec.europa.eu/citizenship/programme/programme_guide_en.php)
13. EC. (2010). *Citizenship: Twinning towns for unity*. Available from the European Commission's webpage [http://sampac.nl/EUKN2015/www.eukn.org/E\\_library/Skills\\_Capacity\\_Building/Skills\\_Capacity\\_Building/CEMR\\_s\\_European\\_Twinning\\_website.html](http://sampac.nl/EUKN2015/www.eukn.org/E_library/Skills_Capacity_Building/Skills_Capacity_Building/CEMR_s_European_Twinning_website.html)
14. Ewijk van, E. & Baud, I. (2009). Partnerships between Dutch municipalities and municipalities in countries of migration to the Netherlands; knowledge exchange and mutuality. *Habitat International*, 33, 218–226. Retrieved from Science Direct database.
15. Habitat International (2009). Transnational city-to-city co-operation: Issues arising from theory and practice (Editorial). *Habitat International*, 33, 131–133. Retrieved from Science Direct database.
16. Hewitt, W.E. (1999). Cities working together to improve urban services in developing areas: The Toronto-Sao Paulo example. *Studies in Comparative International Development*, Spring 1999, 27–44. Retrieved from EBSCO Host database.
17. Hoetjes, B.J.S. (2009). Trends and issues in municipal twinnings from the Netherlands. *Habitat International*, 33, 157–164. Retrieved from Science Direct database.
18. Johnson, H. & Wilson, G. (2009). Learning and mutuality in municipal partnerships and beyond: A focus on Northern partners. *Habitat International*, 33, 210–217. Retrieved from Science Direct database.
19. Keiner, M. & Kim, A. (2007). Transnational city networks for sustainability. *European Planning Studies*, 15(10), 1369–1395. Retrieved from Routledge database.
20. Lindert van, P. (2009). Transnational linking of local governments: The consolidation of the Utrecht-León municipal partnership. *Habitat International*, 33, 173–180. Retrieved from Science Direct database.
21. Mega-Cities Project. (2010). Information available from Mega-Cities Project's official website <http://www.megacitiesproject.org/>
22. Nitschke, U., Held, U. & Wilhelmy, S. (2009). Challenges of German city2city co-operation and the way forward to a quality debate. *Habitat International*, 33, 134–140. Retrieved from Science Direct database.
23. People to People International (PTPI). (2011). *About PTPI*. Information available from PTPI's webpage [http://www.ptpi.org/about\\_us/](http://www.ptpi.org/about_us/)

24. SCI (Sister Cities International). (2010). *About Sister Cities*. Information available from Sister Cities International's official website  
<http://www.sister-cities.org/about-sister-cities-international>
26. Tjandradewi, B.I. & Marcotullio, P.J. (2009). City-to-city networks: Asian perspectives on key elements and areas for success. *Habitat International*, 33, 165–172. Retrieved from Science Direct database.
27. UNDG (United Nations Development Group). (2015). Delivering the post-2015 development agenda. Retrieved from  
<http://www.undp.org/content/dam/undp/library/MDG/Post2015/UNDP-MDG-Delivering-Post-2015-Report-2014.pdf>
28. UNDP. (2010). The UNDP: About UNDP and the millennium development goals. Information available from UNDP's official website <http://www.undp.org/>
29. UN-Habitat & WACLAC, 2003
30. Villiers de, J.C. (2009). Success factors and the city-to-city partnership management process – from strategy to alliance capability. *Habitat International*, 33, 149–156. Retrieved from Science Direct database.
31. Wallberg, B. (2000). *Twinning co-operation between Swedish and Bosnian municipalities – Sida Evaluation 00/15*. Stockholm/Sweden: Swedish International Development Co-operation Agency (SIDA). Retrieved from OECD database.

© 2013 Accenture. All rights reserved.

be > your degree

Bring your talent and passion to a global organization at the forefront of business, technology and innovation. Discover how great you can be.  
Visit [accenture.com/bookboon](http://accenture.com/bookboon)

Be greater than.  
consulting | technology | outsourcing

accenture  
High performance. Delivered.



# 5 System of indicators for measuring performance development of cities

*Nothing focuses the mind better than the constant sight of a competitor who wants to wipe you off the map.*  
(Wayne Calloway)

Recommended additional reading:

- Annoni, P., & Dijkstra, L. (2013). *EU Regional Competitiveness Index 2013*. JRC Policy and scientific reports. Retrieved from Portal European Commission. <https://ec.europa.eu/jrc/sites/default/files/lbna26060enn.pdf>
- Archibugi, F. (2000). *City Effect and Urban Overloas as Program Indicators of the Regional Policy*. The 40th Congress of European Regional Science Association. Barcelona: University of Barcelona. Retrieved from [http://www.francoarchibugi.it/pdf/2000\\_barcelona%5Be%5D.pdf](http://www.francoarchibugi.it/pdf/2000_barcelona%5Be%5D.pdf).
- Belton, V., & Stewart, T.J. (2002). *Multiple Criteria Decision Analysis: An Integrated Approach*. Boston: Kluwer Academic Publishers.

## 5.1 Chapter Overview

Recognizing that cities are becoming generators of economic development and a source of growth for the national economy, there is an increasing urge to identify the stages of development and positioning of cities upon which the adequate preparation of strategic and development guidelines is dependent. Comparison upon the level of their development efficiency calls for indicators, which measure the performance of cities, are representative and comparable between countries. In the case of medium-sized cities we consequently have to question the applicability of the methodology and indicators used mostly in cases of large, global cities by internationally recognized institutions. With the established set of qualitative indicators and assistance of computer program for multi-parameter decision-making processes (DEXi) this chapter also seeks to compare the performance development of selected European cities.

Learning outcomes

By the end of this chapter successful students will be able to:

1. Understand the theoretical background and applied practice for measuring performance of cities
2. Understand selection criteria for cities and indicators
3. Understand the multi-attribute decision – making
4. Interpret results of comparison.

## 5.2 Introduction

Existing methodologies of comparison in the field of city performance and quality of urban city structure affect more or less a wider field of urban and regional disparities, wherein specific approaches cover only limited areas. Hence, Nijkamp (1986, p. 1–21) focuses exclusively on infrastructure impacts, Callois and Aubert (2007, p. 809–821), however, empirically analyze the impact of social capital on regional development. An overview of sustainable development indicators give Singh et al. (2009, p. 189–212) as well as Slottje (1991, p. 684–693), Somarriba and Pena (2009, p. 115–133), but the interpretation of the quality of life indicators is missing. In the field of competitiveness Winter (2010, p. 52–53) presents synopsis of indicators measuring urban competitiveness on a European scale, while Parris and Kates (2003, p. 559–586) indicate the multilayered nature of sustainable development and consequently incompleteness of a measuring indicator's clear definition. Missing thematic indicators can also be found in the context of measuring regional disparities at the broader level of the European countries (Tausch et al. 2007; Oliveira Soares et al. 2003, p. 121–135). Comparing cities by the use of indicators, representing diverse aspects of urban life, is only possible with the meaningful formation of structured system; simply adding many of indicators to obtain a single index may result in criticism of [uncertainty](#). Similar effects can also be reached by using a larger set of non-aggregated indicators; therefore identification of appropriate, small number of relevant indicators is crucial. In the process of system formation, inclusion of indicators with higher impact on the general differences between selected cities in different countries is necessary, at an additional assumption of environmental, human and social capital as well as the demographic point of view's integration.

In this paper we want to present the concept of measuring the urban development, based on different theoretical background and applied practices, through which the most appropriate, tailored concept (European Common Indicators or ECI) is introduced as the baseline for the study, considering the specific criteria, followed by selection of the qualitative, descriptive performance development indicators. Based on the structure and categorization of gathered data (by survey, taken in 5 EU cities), the applied DEXi method is introduced as the option in the multi-criteria decision making process (city management). The method's case applicability is further discussed by the results and their interpretation.

## 5.3 Theoretical background and applied practice

In accordance with the Charter on European Sustainable Cities and Towns Voula (1996, p. 133–154) lists six key areas of sustainable development and urban transformation: the active city/town, beautiful town, green city/town, town with a better environment, cooperation for a better city, and the town catalogue. The strategy of urban sustainability consequently includes urban performance indicators such as: 1) local involvement (citizen's participation), 2) employment, 3) city deficit, 4) economic growth, 5) urban mobility, 6) urban metabolism, resources, consumption, 7) environment and social expenditure, 8) urban safety, 9) public health, 10) social justice, and 11) global change.

Indicators of sustainable development show the complex and dynamic structure of the urban surroundings. After adoption of Agenda 21 (1992) this type of indicators developed many institutions (e.g. United Nations – Urban Indicators Program, World Health Organization (2009)) as the analytical tools for studying the quality of life in the urban environment. The wider set represent also SUD-LAB European Commission project’s indicators with an extended database of European cities, where indicators are divided into the following categories: a) air quality, b) composed environment, c) cultural endowments, d) social disparities, e) transportation quality, f) urban administration, and g) waste management (Bănica 2010, p. 340).

Bănica (2010) defines the *index of local development* as an integrated indicator, including the importance of individual elements (weights), namely, category of infrastructure (4), followed by the economy (3), local community (2) and public administration (1):

$$I_{di} = \frac{I_i + I_e + I_c + I_a}{4} \quad (1)$$

meaning:

- $I_{di}$  – local development index,
- $I_i$  – infrastructure index: utilities, transport and health infrastructure, natural resources,
- $I_e$  – local economy index: financial services and insurance, labour and public budget,

“I studied English for 16 years but...  
...I finally learned to speak it in just six lessons”  
Jane, Chinese architect

ENGLISH OUT THERE

Click to hear me talking before and after my unique course download



$I_{mc}$  – *local community index* (community spirit): safety of citizens, tourist attractions, cultural / sports facilities, and cultural / historical heritage.

$I_{ap}$  – *public administration index*: services and support to small and medium-sized enterprises, urban planning, communication and information dissemination.

## 5.4 Selection of cities

Methodology for the comparison of medium-sized cities includes selection of an appropriate sample, defined by: *location* (criterion 1: European cities), *inclusion in the databases* (criterion 2: city's inclusion in Urban Audit database), *definition in terms of a smart city* (criterion 3: city is placed in the Smart Cities base), *comparability in terms of the urban size* (criterion 4: population size: from 100,000 to 200,000 inhabitants) and *regional significance* (criterion 5: capital of the region or an important regional centre). The cities that have fulfilled the above stated criteria and were included in our research are Maribor (Slovenia), Pleven (Bulgaria), Linz (Austria), Erfurt (Germany), Trieste (Italy), and Brugge (Belgium).

## 5.5 Selection of indicators

The selection of qualitative indicators results from conceptual understanding of *urban sustainability* indicators, based on the ECI – European Common Indicators, first established in the period 1999–2003 under the guidance of the research institute Ambiente Italia. Among more than 1,000 indicators, reflecting trends in urban development in accordance with the principles of the social inclusion, local governance and democracy, local/global city integration, local economy, environment, cultural heritage, and quality of the institutional environment, in the context of ECI 10 key indicators, pointers of sustainable development of European cities were selected (Ambiente Italia 2003; Riga City Council 2005):

area 1: citizens' satisfaction with the local community – *indicator 1: average satisfaction with the local community*,

area 2: local contribution to global climate changes – *indicator 2: CO<sub>2</sub> emissions per capita*,

area 3: local mobility and transportation – *indicator 3: percentage of trips by private motorized transport*,

area 4: availability of local public open areas and services – *indicator 4: percentage of people, living within 300 meters of a public open area > 5000 m<sup>2</sup>*,

area 5: quality of the local ambient air – *indicator 5: emissions of particulate matter (PM<sub>10</sub>)*,

area 6: children's journeys' to and from school – *indicator 6: percentage of children going to school by car*,

area 7: sustainable management through the local authorities and local enterprises – *indicator 7: percentage of environmental certificates with reference to the total of enterprises*,

area 8: pollution (noise) – *indicator 8: percentage of the population exposed at night to noise levels >55 dB*,

area 9: sustainable land use – *indicator 9: percentage of protected areas*,

area 10: products promoting sustainability – *indicator 10: percentage of population favouring "sustainable products"*.

The quoted methodology that we found suitable for the study's baseline, was developed according to a bottom up approach, involving local authorities as the main actors in the process and improving synergies with the existing indicators set. This showed, on the one hand, to what extent the ethos (fundamental values peculiar to a specific person, people, culture, or movement) was actually based upon understanding the real needs of municipalities, and on the other, the possibilities of achievement of policy objectives for actions that shall bridge more than one level of governance. Indicators initiative was focused on monitoring urban sustainability at the local level, with the aim to help a local authority, interested in beginning to monitor the progress in the field of quality of its urban environment. Towns and cities can adapt the proposed set of 10 indicators to suit local circumstances. Respondents' distribution (from 14 EU countries) covered all classes of urban dimension (cities or aggregations of cities): 13 large (population > 350,000), 18 medium-sized (100,000 < population < 350,000) and 11 small (population < 100,000).

For countries and their cities (especially on a European scale, in transition countries and consequently, Slovenian cities) with a smaller population settlement, measurement concepts, formerly presented in the introductory part of this chapter may be partially or wholly inadequate. The selection of meaningful indicators, tailored to a specific city sample (e.g. medium-sized, European), situation and decision-making problem (city management), depends on the defined focused areas of city development. Selection of appropriate indicators in terms of narrow, specific measurement for future development's effectiveness from this perspective proves to be relevant.

The ECI concept was used in the study due to its successful implementation and effective city policy development's purpose. Based on its principles (the measurement method, definitions and scale values, which will be presented in sub-chapter 5.7, by introducing the specific areas from 1 to 5, qualitative performance indicators of urban development were selected in the study (Table 4).



Indicator	Scale value			
<b>Perception of local community</b>				
The overall level of satisfaction with the local community	very satisfied	moderately satisfied	unsatisfied	
Public transport	easy accessible	difficult to access	inaccessible	
Social and health services	Appropriate	acceptable	unacceptable	
Quality of the institutional environment	High	solid	unsatisfactory	
Education (number of educational facilities in your city)	1	1–5	more than 5	
Accommodation options and accessibility	high	medium	low	
Employment opportunities	frequent	occasional	rare	
<b>Local mobility</b>				
Systematic displacements (home – school and home – work)	private transport	public transport	non-motorized	
Number of daily trips (per capita), unsystematic	1–5	to 10	more than 10	
Access to basic services (bakeries, public transport, health facilities)	in the range of 300 m	in the range of 2 km	more than 2 km	
Accessibility to educational institutions (schoolchildren, students)	by foot, bicycle	public transport	private transport	
<b>Enterprises</b>				
Enterprises (sectoral)	mainly service sector	balanced industrial and service sector	mainly industrial sector	
Enterprises R&D	1–5	6–9	≥ 10	
SMEs and large enterprises	mainly SMEs	balanced SMEs and large enterprises	mainly large enterprises	
<b>Environment</b>				
Noise exposure	55–64 dB	65–74 dB	≥75 dB	
Environmental protection (opinion)	good	average	satisfactory	
Preference for eco-products	my preferen	high costs	occasionally available, diverse habits	I don't trust them
<b>QOL</b>				
Subjective perception of poverty (local environment)	high	moderate	low	
Subjective perception of safety (local environment)	completely safe environment	stable environment	lower safety	

**Table 4:** City performance indicators – qualitative; descriptive  
 Source: KWIK Surveys Questionnaire (2011).

## 5.6 Data structure and categorization

In the cities Maribor, Pleven, Linz, Erfurt, Trieste, and Brugge, a survey (By planning the survey, the recommendations of the sample survey approach were followed (see Tominc 2006, p. 10)), based on a questionnaire implementing method CAWI (Computer Assisted Web Interviewing employing application KWIK Surveys (SOZ 2011)) was carried out. The size of a representative sample was calculated by using standard deviation of the observed variable for statistical population, which can be determined from previous studies and on predicted confidence interval base (Bastič 2006). Standard deviation's ( $\sigma$ ) value for the studied variable in the statistical population is 3.607, error probability is 0.5; value of the variable  $t$  at  $t_{0,05}$  is 1.96.

Calculation of the sample size  $n$  was the following:

$\sqrt{n} = 1.96 * 3.607 / 0,5$ ;  $n = 199.92$ ,  $n = 200$ , respectively. Sampling was conducted according to the principle of non-random quota sampling, judgement sampling and partly also at random using a social network.

In  $n = 200$ , we obtained 184 correctly completed questionnaires, representing the sampling fraction:

$$p = (184/200 = 0.92); SE \text{ (standard error of estimate)} = (\sqrt{0.92 (1-0.92) / 200}) * 100 = 1.9. \quad (2)$$

**DUKE**  
THE FUQUA  
SCHOOL  
OF BUSINESS

**BUSINESS HAPPENS**

**HERE.**

[www.fuqua.duke.edu/globalmba](http://www.fuqua.duke.edu/globalmba)

**Learn More >**



Click on the ad to read more

Considering the error probability,  $z$ -value (standard score  $z$  at the selected error probability) was calculated:

$$\alpha = 1 - 0.95 = 0.05; \alpha/2 = 0.025; z_{\alpha/2} = z_{0,975} = 1.96. \quad (3)$$

At the standard error of estimate SE (without correction factor) of 1.9 percent, lower confidence limit was determined:

$$8\% - 1.96 * 1.9\% = 2.4. \quad (4)$$

The questionnaire consisted of 20 closed questions, to which respondents (aged 20 to over 60 years, wherein this range didn't predefine the target group) replied with a choice between anticipated, mutually exclusive answers. In a single case dichotomous question (of two completely opposite directions type, i.e. male, female) had been used, a selection of multiple answers was not admissible. By using the Likert scale, respondents expressed their level of agreement/disagreement with a rank of viewpoints, semantic differential was not included.

### Interpretation of the survey results

On the survey sample ( $n = 200$ ) it was measured that at the indicator *the perception of poverty*, 66.7 percent of respondents assigned most votes to the *alternative b) moderate*. If the results are induced to the population, in accordance to the sample size, we will be able to predict with 95 percent probability that between 60.1 and 73.3 percent of population believe in the existence of moderate perception of poverty. The aim of the survey does not represent a projection of the results to the entire population in particular cities, but a creation of the database for setting up a DEXi decision model (a "case study" of qualitative database's processing possibilities using artificial intelligence decision-making methods). In the qualitative research it is necessary to consider the limitations of subjectivity and perception; the results are yield of the respondents' answers (subjective, reflecting their self-image, which is not inevitably consistent with objective indicators), attention must be drawn also to the social desirability of responses (overvalued shares).

## 5.7 Multi-attribute decision – making using program DEXi

With an established system of descriptive city performance development indicators the study wants to enable qualitative decision-making in a systematic way by using a multi-attribute model in complex situations with a large number of factors and variables. By Grünig and Kühn (2005, p. 7), problem solving can be done in several ways: intuitively, routinely – by adopting formerly employed procedures or by random selection and systematic rational thinking, supported by relevant information. The general approach of the decision analysis originates from the axioms of the game theory by John von Neumann and Oskar Morgenstern (1953). Its main steps represent: problem structuring, estimating the likelihood of possible outcomes, determining their utility and evaluating alternatives as well as selecting strategies (Belton & Stewart 2002, p. 6; Čančer & Mulej 2005; Čančer 2007).

In this study, we conclude to use DEXi (Decision Expert) multi-attribute decision method, developed at the Jožef Stefan Institute (on the methodology DECKMAK or DECisionMAKIng), which includes a result analysis of the evaluated variants (Bohanec & Rajkovič 1990, p. 145–157, Bohanec & Rajkovič 1995, p. 427–438, Špendl, Rajkovič & Bohanec 1996, p. 3). DEXi uses discrete and qualitative criteria, whose values are in general words, such as: good, excellent, unacceptable, unlike AHP – analytic hierarchy process as a numerical method, which for determining the importance of the criteria uses weights (e.g. the **Saaty Rating Scale** (1990)). Like AHP, the DEXi method is based on the decomposition of the decision problem to the hierarchical structure of criteria, where instead of words, intervals of numerical values can be used. The difference is noticeable also at the lower – level criteria aggregation functions into the final assessment, where the program instead of weights uses decision rules of “if-then” type. DEXi allows evaluation of variants also in the case of their incomplete and inaccurate information (Bohanec 2011).

In the first phase of the study, we identified the criteria, hierarchically reordered in a tree of attributes for building the decision model. Following this purpose, for each attribute (basic and aggregate) description and scale values were determined. Basic criteria represent the perception of the local community, local mobility, enterprises, environment, and QOL (“Quality of Life”).

Area 1: Indicator: *satisfaction with the local community*. An important component of a sustainable society characterizes general welfare of its members or living in conditions, which include safe and affordable housing, the availability of basic services (schools, health, etc.), interesting and satisfying work, as well as opportunities to participate in local planning and decision-making. For this indicator there aren't any validated goals, only a general recognition that the welfare of citizens and their satisfaction with the local community are important elements of sustainability (European Commission 2002, p. 1–3).

Indicator *public transport (accessibility)*, adopted from the models of sustainable urban development, is related to accessibility, availability of transport/transportation, social connectivity, access to motor vehicles and travel perceptions. Integrated accessibility is defined as the spatial distribution of potential destinations, as well as the quality and characteristics of the involved activities (Zahavi et al. 1981; Handy & Niemeier 1997). According to Wegener et al. (2000) accessibility is defined as a construct of two functions, one representing the activities and opportunities, respectively, and the other representing effort, time, distance or the costs of achieving them:

$$S_L = \sum_M J(\cdot) \cdot I(F_L)M, \tag{5}$$

where  $A_i$  represents the accessibility of the area  $i$ ,  $W_j$  activity  $W$  on the area  $j$  and  $c_{ij}$  the cost of reaching the area  $j$  from the area  $i$ . Functions  $g(W_j)$  and  $f(c_{ij})$  are defined as activity functions.

Among the indicators of area 1 the study also included: *social and health services, accommodation options and accessibility, as well as employment opportunities*. Their selection was based on the Eurobarometer Survey “Perception survey on quality of life in European cities 2009” (Eurobarometer 2009), which indicated significant variations in the level of satisfaction with health services between EU cities; 80 percent majority at the possibility “moderate” or “very satisfied” was noticed for residents of western European cities, while the level of satisfaction in many southern and eastern European cities was significantly lower (Eurobarometer 2009, p. 4). Considering the methodologies of Eurobarometer survey and the Urban Audit Perception Survey (Urban Audit 2004, p. 4–5) indicators *accommodation options and accessibility*, as well as *employment opportunities* were selected for our study. The results of the stated surveys show a pessimistic view on the labor market, with the expected inverse relationship between the availability of jobs and the availability of accommodation options.

Area 2: *local mobility* indicators include: 1) *systematic displacements* (home – school and home – work), 2) *the number of daily trips (per capita), unsystematic*, 3) *access to basic services* (bakeries, schools, public transport, health facilities), and 4) *the accessibility to educational institutions*. The set of indicators derives from theoretical principles of European Common Indicators (ECI), where the indicators of local mobility and transport include the percentage of trips by private motorized transport. Systematic trips (per capita) represent daily displacements to work/school and back, while unsystematic trips are made for other reasons, e.g. shopping, recreation and others. Model of citizens local mobility in the urban context is important in terms of quality of life (promoting alternative modes of transport; public transport, cycling). *Access to basic services* (bakeries, schools, public transport, health facilities) in sustainable community is vital for the quality of life and performance of the local economy.

The selection of the indicator is based on the headline indicator *availability of public open areas and services* (see ECI). Accessibility is defined as a percentage of people living within 300 meters of a public open area or other basic services and collective transport routes that, at least for part of a normal business day, have a minimum frequency (half-hourly service); public school (compulsory education); bakery, greengrocery, and primary public health services. European Environment Agency, Directorate-General for Regional Policy and ISTAT (**Istituto nazionale di statistica** – Italian National Bureau of Statistics) apply the concept “within 15 minutes by foot” for determining the accessibility. Absence of stores, selling fresh fruits and vegetables is an indicator of social exclusion and health risk (European Commission 2002, p. 15–18). Methodological principles of the indicator *accessibility to educational institutions* are also found in the context of ECI indicators, where the headline indicator of the area “children’s journeys to and from school” represents the percentage of children going to school by car. The value of the attribute in the study refers to the modes of transport, used for children’s journey to and from school (public and private transport), including also the possibility “walk, bike” (European Commission 2002, p. 25). A sustainable society is namely the one, which in terms of the traffic safety and crime seems safe enough to parents to allow the children street walking, cycling and using public transport.

*Indicators of the area 3 (enterprises)* are represented by: enterprises (sectoral), enterprises R&D, followed by SMEs (small and medium-sized enterprises) and large enterprises. The selection of indicators is based on the study “The Economic Map of Urban Europe” (Laakso & Kostianen, 2007, p. 12–15), which in the context of the city’s economic structure emphasizes the importance of service and manufacturing sector. The results of the study show specialization of the service sector (concentration of administrative functions), which in some capitals (e.g. Vienna) includes the dominant share of employment. In other capitals (e.g. Barcelona) markedly closer balance between service and manufacturing sector was noticed (Laakso & Kostianen, 2007, p. 12). Production in the European Union on average employs 25 percent of the workforce, despite the de-industrialization plays an important role in the economy of many European urban regions. Industrialized European cities are seldom cities in economic decline, on the contrary, some of them are among the most dynamic and economically robust ones in Europe (Laakso & Kostianen, 2007, p. 14). Considering the importance of both, the service and manufacturing sector, in the formation of decision rules for cities the equilibrium principle (balanced service sector and industry) is preferred in our study.

## Join American online LIGS University!

Interactive Online programs  
BBA, MBA, MSc, DBA and PhD

### Special Christmas offer:

- ▶ enroll **by December 18th, 2014**
- ▶ **start studying and paying only in 2015**
- ▶ **save up to \$ 1,200** on the tuition!
- ▶ Interactive Online education
- ▶ visit [ligsuniversity.com](http://ligsuniversity.com) to find out more!

Note: LIGS University is not accredited by any nationally recognized accrediting agency listed by the US Secretary of Education. More info [here](#).



The selection of *indicators SMEs and large enterprises*, as well as *enterprises R&D* is argued on the basis of the ECORYS (2012) research and the Eurostat database (2013). The results of the research show that despite the crisis in the euro area and the strained economic situation, small and medium-sized enterprises (SMEs) in the EU represent an important role in the Union's economy. According to the 2012 data, 20.7 million of SMEs contributed to 67 percent of total employment and 58 percent of total gross value added (ECORYS 2012). "Small Business Act – SBA" for Europe (newer version from 2011) recognizes the importance of the SMEs' role in the EU economy with the aim of striving to strengthen it in terms of reducing the administrative barriers, accessing new markets, ensuring free competition, promoting R&D, and supporting SMEs in regional and environmental context of the Europe 2020 key objectives – smart, sustainable and inclusive growth. Many SMEs are faced with so-called "non-recruitment growth" (or "jobless growth"), but the dynamic, despite the delicate economic environment, demonstrates increased enterprise (EU) activity in the "high-tech and knowledge-based industries and services". According to the EU-27 area's Eurostat data almost balanced contribution of micro and SMEs as well as large enterprises to the added value can be seen in average. Considering the above starting-points regarding the role of SMEs and large companies and their added value, the decision rules (*indicator SMEs and large companies*) in our study are related to their balanced distribution in the urban environment of medium-sized cities. The importance of high technology sector and knowledge based services leads to a preference for a higher number of R&D enterprises in selected urban areas.

Area 4 relates to the environment and includes indicators: 1) exposure to noise, 2) environmental protection (opinion) and 3) preference for eco products. Selection results from the set of European common indicators, which cover the area of noise pollution (European Commission 2002, p. 33–36; Ambiente Italia 2003, p. 113–114), where the headline indicator represents the percentage of the population exposed to noise  $L_{night}$  (at night)  $> 55$  dB(A) (Abbreviation for DeciBels Adjusted, dB(A) is the noise power, calculated in dB.). On the quoted basis the indicator of noise exposure with scale values of 55–64 dB, 65–74 dB and  $\geq 75$  dB (noise level), which do not relate to a specific time of day (e.g. by day, by night) was used in the study. A sustainable society should combine urban functions such as housing, work and mobility without exposing residents to excessive noise. Selection of the indicator environmental protection (opinion) refers to the Urban Audit Perception Survey (Urban Audit 2004, 5), which in the context of the local perception of quality of life measurement (QOL) in 31 European cities uses indicator of a "clean city". Interestingly, between cities, where most of the population believes that the city is clean, the majority of the population feels also completely safe. The baseline of the indicator preference for eco products represent the European common indicators (Ambiente Italia 2003, p. 127–128) in the field of sustainability promoting products (the headline indicator "percentage of people buying sustainable products", respectively). The indicator includes eco-labeled products, organic products, energy-efficient products, FLO fair trade products (Fairtrade Labelling Organizations), and eco products (e.g. Blauer Engel/Germany, the Nordic Swan/Scandinavian countries and the EU-Ecolabel /European Union).

Indicators of area 5 – QOL (“Quality of Life”) are represented by: a) *subjective perception of poverty (the local environment)* and b) *subjective perception of safety (the local environment)*. Indicator subjective perception of poverty is based on the Eurostat database (2011) indicator “population at risk of poverty or exclusion; NUTS2”. Selection of the indicator *subjective perception of safety* refers to the Urban Audit Perception Survey (Urban Audit 2004, p. 5) about the local perception of quality of life (QOL) in European cities.

The decision model consists of 22 attributes (Figure 10), hereof 16 basic and 6 aggregate. In the next phase of our study an adequate value, which in DEXi consists of words or numerical intervals (Jereb, Bohanec & Rajkovič 2003, p. 17), is assigned to each attribute. The rule “if-then” is used by DEXi in the table rows, which represent the utility function or decision rules. By setting the first (representing the worst options’ combination) and the latest rule (best value) using Function Editor and by setting appropriate weights, the program automatically calculates other values, which, if found as unacceptable, can still be properly edited.

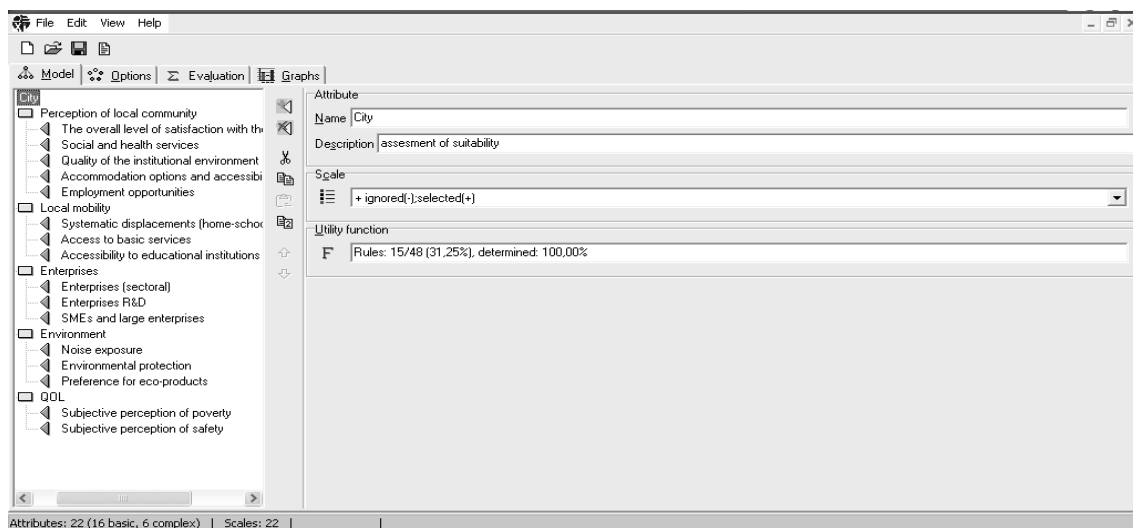

**Figure 9:** The model page of DEXi model window  
 Source: DEXi processing of collected data.

*Interpretation of the decision rules for the attribute environment* (Figure 11): in the case of noise exposure, greater than 75 dB, regardless of the scale value (represents any value) referring to the attributes environmental protection and preference for eco-products, the decision for the city selection is not taken. Decision rules are formed with reference to previously presented European Union environmental policy, wherein the headline indicator represents the percentage of the population exposed to night noise levels > 55 dB(A). Correspondingly still acceptable daily noise level up to 75 dB was considered in the study.



Decision rules				
	Noise exposure	Environmental protection	Preference for eco-products	Environment
	41%	36%	22%	
1	more than 75 dB	*	*	Ignored
2	<= 65-74 dB	<u>satisfactorily</u>	*	Ignored
3	<=65-74 dB	<=average	<=occasional available	Ignored
4	*	<u>satisfactorily</u>	<=high costs	Ignored
5	*	<=average	<=diverse habits	Ignored
6	*	*	<=I don't trust	Ignored
7	>=65-74 dB	>=average	>=high costs	<b>Selected</b>
8	>=65-74 dB	<b>Good</b>	>=diverse habits	<b>Selected</b>

**Figure 10:** Decision rules for attribute environment  
 Source: DEXi processing of collected data

Selection is confirmed in the case of the attribute scale value “65–74” (weight of 41 percent), environmental protection with a scale value “good” and preference for eco-products with a scale value “diverse habits”. After entering attribute values (Figure 12) for *all options* (Maribor, Pleven, Linz, Erfurt, Trieste, Brugge), obtained by completed survey questionnaires (value selection is determined by the percentage majority), the study includes *evaluation of alternatives*. Option with the highest evaluation is generally the best, but the analysis based on the mutual comparison is essential because of reasonable, proven solutions given (Jereb, Bohanec & Rajković 2003, p. 14).

**ie business school**

#1 EUROPEAN BUSINESS SCHOOL  
FINANCIAL TIMES 2013

**#gobeyond**

**MASTER IN MANAGEMENT**

**Because achieving your dreams is your greatest challenge.** IE Business School's Master in Management taught in English, Spanish or bilingually, trains young high performance professionals at the beginning of their career through an innovative and stimulating program that will help them reach their full potential.

- Choose your area of specialization.
- Customize your master through the different options offered.
- Global Immersion Weeks in locations such as Rio de Janeiro, Shanghai or San Francisco.

**Because you change, we change with you.**

www.ie.edu/master-management | mim.admissions@ie.edu | f t in YouTube U



Option City	Maribor	Pleven	Linz	Erfurt	Trieste	Brugge
Perception of the local community	no	no	<i>selected</i>	i no	i no	no
The overall level of satisfaction with the local community	no	no	<i>selected</i>	o i	i no	<i>Selected</i>
Social and health services	o t ti i	o t ti i	<i>very satisfied</i>	<i>very satisfied</i>	o t ti i	<i>very satisfied</i>
Quality of institutional environment	pt	pt	<i>appropriate</i>	<i>appropriate</i>	<i>appropriate</i>	<i>appropriate</i>
Accommodation options and accessibility	o i	o i	<i>high</i>	o i	o i	<i>High</i>
Employment opportunities	i	i	i	i	i	i
Local mobility		<i>frequent</i>	<i>frequent</i>	o ion	o ion	<i>frequent</i>
Systematic displacements (home-school and home work)	<i>Selected</i>	<i>selected</i>	<i>selected</i>	<i>selected</i>	i no	<i>selected</i>
Access to basic services	<i>private transport</i>	p i t n po t	<i>private transport</i>	<i>private transport</i>	<i>private transport</i>	p i t n po t
Accessibility to educational institutions	<i>in the range of 300 m by foot, bicycle</i>	<i>in the range of 300 m by foot, bicycle</i>	<i>in the range of 300 m by foot, bicycle</i>	in t n o	in t n o	<i>in the range of 300 m by foot, bicycle</i>
Enterprises	no	<i>selected</i>	<i>selected</i>	<i>selected</i>	<i>selected</i>	i no
Enterprises (sectoral)	in i	<i>balanced industrial and service sector</i>	<i>balanced industrial and service sector</i>	in i	<i>balanced industrial and service sector</i>	<i>balanced industrial and service sector</i>
Enterprises R&D			<i>more than 10</i>	<i>more than 10</i>		
SMEs and large enterprises	in	<i>balanced SMEs and large enterprises</i>	<i>balanced SMEs and large enterprises</i>	in	<i>balanced SMEs and large enterprises</i>	in
Environment	no	<i>Selected 55-64 dB</i>	<i>selected</i>	<i>selected 55-64 dB</i>	<i>selected</i>	i no <i>55-64 dB</i>
Noise exposure			<i>good</i>	<i>Good</i>		
Environmental protection						
Preference for eco-products	t bnt	t i o	tmy <i>preference</i>	i i	i to i	i i
QOL	no	no	i no	no	i no	i no
Subjective perception of poverty	o t	o t	o	o t	o	o t
Subjective perception of safety	t n i no nt	t n i no nt	t n i no nt	t n i no nt	t n i no nt	t n i no nt

Figure 11: Options' evaluation results  
Source: DEXi processing of collected data.

### 5.8 Results and their interpretation

Comparison of options (cities) Maribor (unselected) and Linz (selected) shows parallel values of both cities, namely: values according to weights and decision rules for Maribor illustrate moderate satisfaction with the local community, the acceptability of health services, solid quality of the institutional environment, predominantly services and SMEs, 65–74 dB of noise exposure, average environmental protection, distrust of eco-products, moderate subjective perception of poverty, and stable environment (median values, positioned neither in the critical nor in the selection interval).

Comparison of options		Maribor	Linz
Attribute	City	ignored	selected
<b>Perception of local community</b> ignored selected □			
– The overall level of satisfaction with the local community	satisfied	moderately	<i>very satisfied</i>
– Social and health services	acceptable		<i>appropriate</i>
– Quality of the institutional environment	solid		<i>high</i>
– Accommodation options and accessibility	medium		
– Employment opportunities	rare		<i>frequent</i>
<b>Local mobility</b> selected			
– Systematic displacements (home - school and home - work)			<i>private transport</i>
– Access to basic services			<i>in the range of 300 m</i>
– Accessibility to educational institutions			<i>by foot, bicycle</i>
<b>Enterprises</b> ignored selected			
– Enterprises (sectoral)	mainly services		<i>balanced industrial and service sector</i>
– Enterprises R&D	1-5	≥10	
– SMEs and large enterprises		mainly SMEs	<i>balanced SMEs and large enterprises</i>
<b>Environment</b> ignored selected			
– Noise exposure	65 –74 dB		
– Environmental protection	average		<i>good</i>
– Preference for eco-products		I don't trust them	<i>my preference</i>
<b>QOL</b> ignored			
– Subjective perception of poverty		moderate	low
– Subjective perception of safety	stable environment		

Figure 12: Comparison of options Maribor-Linz  
Source: DEXi processing of collected data.

Determinant values for city’s non-selection include rare employment opportunities and the extremely small number (up to 5) of R&D enterprises (the importance of this weight amounts 47 percent), as non-selected also common combination of aggregate criteria values is characterized. Values, favorably affecting the choice, represent private transport within the systematic mobility (the latter is independent from the use of public transport), rapid access to basic services and the availability of educational institutions (proximity to schools). For the city of Linz all listed values express maximal selection influence (Figure 14).

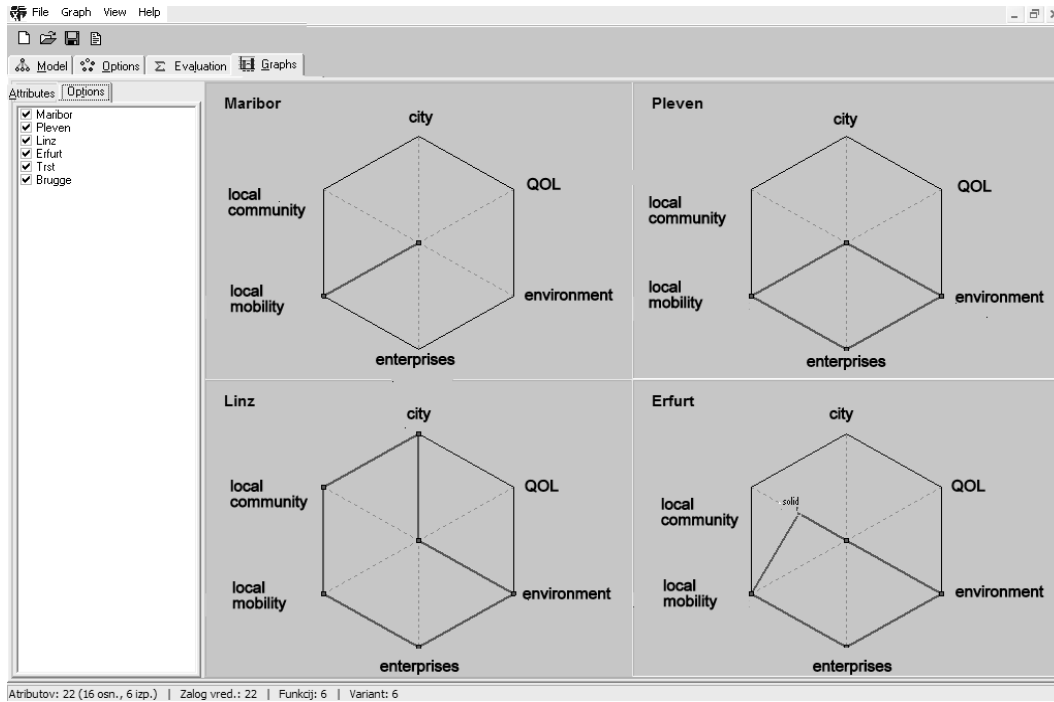

**Figure 13:** Radar chart (star plot) – comparison of options’ (cities) attributes  
 Source: DEXi processing of collected data.

FREE  
 30 days trial!

# SMS from your computer

...Sync'd with your Android phone & number

Go to  
BrowserTexting.com

and start texting from  
 your computer!

... **BrowserTexting**



By the size of the star plot radarchart (Figure 14) and the pursuance of the weights, selection's decision criteria are met only by the city of Linz. Bottom option represents the city of Maribor with the best evaluation of the attribute local mobility. The evaluation results can be interpreted more clearly in a graphic form with a *star diagram*, taking into consideration the extent of the surface area (star) or criteria importance.

City of Erfurt is better than Pleven in the area of local community perception (solid), while the plot areas of Trieste and Brugge are identical (Figure 15), with the difference that Trieste is being better evaluated at the attributes enterprise and the environment and Brugge at the attributes local community perception and local mobility. Interesting is the area of QOL with the attributes subjective perception of poverty and safety under the assumption of strict selection's decision rules, namely; the option (city) is chosen only in the case of imperceptible poverty and stable environment or imperceptible poverty and completely safe environment (QOL expresses an important attribute of evaluation), whereby the decision rules of this attribute are not met by any city, included in our study.

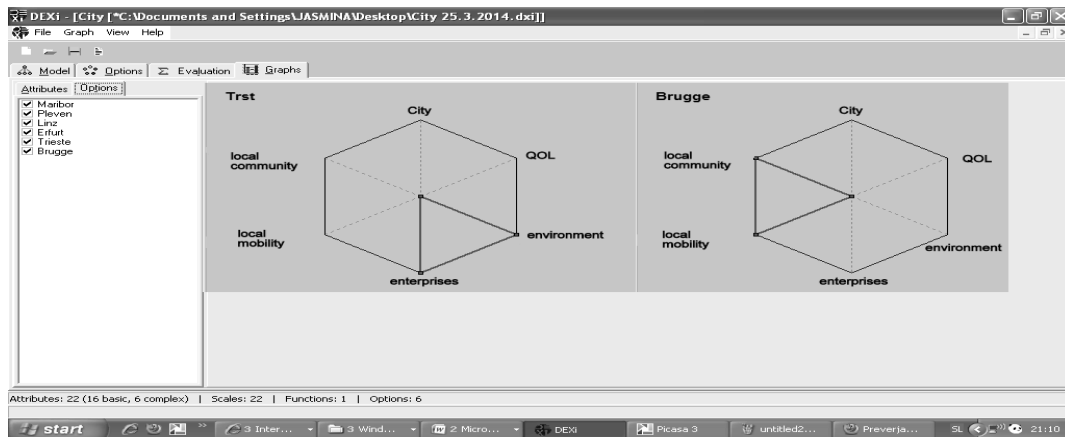

**Figure 14:** Radar chart (star plot) – comparison of options' (cities) attributes  
 Source: DEXi processing of collected data.

## 5.9 Conclusion

The purpose of our study is to compare the performance development of chosen European cities on the basis of the established set of qualitative indicators and the assistance of computer program for multiparameter decision-making processes, by using ECI methodology in national and international (European) comparable cities' sample, whose selection followed certain criteria. Determination of appropriate measurement indicators, closely related to the evaluation of well-known methodological concepts (ECI indicators, indicators of urban status and sustainability) and collected relevant databases (questionnaire, KWIK Survey) resulted in obtaining useful tool: an enlistment of selected descriptive indicators, reasonably divided into five areas and measurement categories, allowing selection of the most suitable option (city). By using multi-attribute decision-making and supporting software tool DEXi for qualitative data analysis, the decision model of the city selection consisted of 22 criteria, among them 16 basic and 6 aggregate. Evaluation of options offered clarity in multi-criteria decision-making in accordance with the specified hierarchy and the importance of decision criteria (decision model, rules and option evaluation). Achieving the best possible decision often requires a trade-off between perfect modelling and usability of the model.

Meanwhile multi-criteria decision-making program DEXi allows verbal assessment (scale values: ignored, selected), it also offers a graphical user interface (the star diagrams – comparison of the options' attributes). It is reasonable to draw attention also to the trend of combining other methods. Namely, in addition to the use of DEXi, in the phase of decision making method's selection also programs as DEXiTree and Vredana can be employed. The latter uses mixed qualitative and quantitative evaluation, where to options beside qualitative also numerical assessment (numerical interval) is given, enabling them to differ even within a single qualitative value.

## 5.10 References

1. Ambiente Italia. (2003). *European Common Indicators (ECI). Final Project Report*. Retrieved from: [http://ec.europa.eu/environment/urban/pdf/eci\\_final\\_report.pdf](http://ec.europa.eu/environment/urban/pdf/eci_final_report.pdf)
2. Bănica, A. (2010). Sustainable Urban Development Indicators Case Study: Târgu Ocna Town. *Present Environment and Sustainable Development*, 4, 346–347.
3. Bastič, M. (2006). *Metode raziskovanja*. Maribor: Ekonomsko-poslovna fakulteta.
4. Belton, V., & Stewart, T.J. (2002). *Multiple Criteria Decision Analysis: An Integrated Approach*. Boston: Kluwer Academic Publishers.
5. Bohanec, M. (2011). *Program for Multi-Attribute Decision Making, User's Manual, Version 3.03*. Ljubljana: Jožef Stefan Institute.
6. Bohanec, M., & Rajkovič, V. (1990). DEX: An expert system shell for decision support. *Sistemica*, 1 (1), 145–157.
7. Bohanec, M., & Rajkovič, V. (1995). Večparametrski odločitveni modeli. *Organizacija*, 28 (7), 427–438.
8. Callois, J. M., & Aubert, F. (2007). Towards Indicators of Social Capital for Regional Development Issues: The Case of French Rural Areas. *Regional Studies*, 41 (6), 809–821.

9. Čančer, V. (2007). Okvirni postopek za večkriterijsko odločanje. *Organizacija*, 40 (5), A160–A167.
10. Čančer, V., & Mulej, M. (2005). *The Roles of Creative Thinking and Decision Making Tools for Building Knowledge Societies*. Retrieved from: JAIST Repository: <https://dspace.jaist.ac.jp/dspace/bitstream/10119/3962/1/20005.pdf>
11. European Commission. (2002). *Približevanje lokalnemu trajnostnemu profilu – skupni evropski indikatorji*. Retrieved from: [http://ec.europa.eu/environment/urban/pdf/methodology\\_sheet\\_sl.pdf](http://ec.europa.eu/environment/urban/pdf/methodology_sheet_sl.pdf)
12. Eurobarometer. (2009). *Perception survey on quality of life in European cities*. Retrieved from: [http://ec.europa.eu/public\\_opinion/flash/fl\\_277\\_en.pdf](http://ec.europa.eu/public_opinion/flash/fl_277_en.pdf)
13. ECORYS. (2012). *EU SMEs in 2012: at the crossroads. Annual report on small and medium sized enterprises in the EU, 2011/12*. Retrieved from: [http://ec.europa.eu/growth/smes/business-friendly-environment/performance-review/files/supporting-documents/2012/annual-report\\_en.pdf](http://ec.europa.eu/growth/smes/business-friendly-environment/performance-review/files/supporting-documents/2012/annual-report_en.pdf)
14. EUROSTAT. (2011). *European cities – demographic challenges*. Retrieved from [http://epp.eurostat.ec.europa.eu/statistics\\_explained/index.php/European\\_cities\\_demographic\\_challenges](http://epp.eurostat.ec.europa.eu/statistics_explained/index.php/European_cities_demographic_challenges)
15. EUROSTAT. (2013). *Business economy – size class analysis*. Retrieved from: [http://epp.eurostat.ec.europa.eu/statistics\\_explained/index.php/Business\\_economy\\_size\\_class\\_analysis](http://epp.eurostat.ec.europa.eu/statistics_explained/index.php/Business_economy_size_class_analysis)
16. Grünig, R., & Kühn, R. (2005). *Successful Decision-making: A Systematic Approach to Complex Problems*. Berlin: Springer, New York: Heidelberg.

**The Wake**  
the only emission we want to leave behind

Low-speed Engines Medium-speed Engines Turbochargers Propellers Propulsion Packages PrimeServ

The design of eco-friendly marine power and propulsion solutions is crucial for MAN Diesel & Turbo. Power competencies are offered with the world's largest engine programme – having outputs spanning from 450 to 87,220 kW per engine. Get up front! Find out more at [www.mandieselturbo.com](http://www.mandieselturbo.com)

Engineering the Future – since 1758.  
**MAN Diesel & Turbo**



17. Handy, S.L., & Niemeier, D.A. (1997). Measuring accessibility: An exploration of issues and alternatives. *Environment and Planning A*, 29 (7), 1175–1194.
18. Jereb, E., Bohanec, M., & Rajkovič, V. (2003). DEXi- Računalniški program za večparametrsko odločanje. Kranj: Moderna organizacija.
19. KWIK Surveys Questionnaire. (2011). Retrieved from: <http://kwiksurveys.com/>
20. Laakso, S. & Kostianen, E. (2007). The Economic Map of Urban Europe: A Comparative Study of 45 European Metropolises. *Statistics* 42: 12–16.
21. Nijkamp, P. (1986). Infrastructure and Regional Development: A Multidimensional Policy Analysis. *Empirical Economics*, 11 (1), 1–21.
22. Oliveira Soares, J., Lourenço Marquês, M. M., & Ferreira Monteiro, C. M. (2003). A Multivariate Methodology to Uncover Regional Disparities: A Contribution to Improve European Union and Governmental Decisions. *European Journal of Operational Research*, 145 (1), 121–135.
23. Parris, T.M., & Kates, R.W. (2003). Characterizing and Measuring Sustainable Development. *Annual Review of Environment and Resources*, 28 (1), 559–586.
24. Riga City Council. (2005). Managing Sustainability – An organisational Plan for the City of Riga. Retrieved from: [http://www.urbanworks-toolkit.eu/en/documents/Managing\\_sustainability\\_plan\\_Riga.pdf](http://www.urbanworks-toolkit.eu/en/documents/Managing_sustainability_plan_Riga.pdf).
25. Saaty, T.L. (1990). How To Make a Decision: The Analytic Hierarchy Process. *European Journal of Operational Research*, 48, 9–26.
26. Singh, R.K., Murty, H.R., Gupta, S.K., & in Dikshit, A.K. (2009). An Overview of Sustainability Assessment Methodologies. *Ecological Indicators*, 9 (2), 189–212.
27. Slottje, D.J. (1991). Measuring the Quality of Life across Countries. *The Review of Economics and Statistics*, 73 (4), 684–693.
28. Somarriba, N., & Pena, B. (2009). Synthetic Indicators of Quality of Life in Europe. *Social Indicators Research*, 94 (1), 115–133.
29. SOZ. Slovensko združenje oglaševalskih agencij. (2011). *Raziskave v tržnem komuniciranju*. Retrieved from: [http://www.soz.si/sites/default/files/dp7\\_raziskave\\_v\\_trznem\\_komuniciranju.pdf](http://www.soz.si/sites/default/files/dp7_raziskave_v_trznem_komuniciranju.pdf)
30. Špendl, R., Rajkovič, V., & Bohanec, M. (1996). *Primerjava kvalitativnih in kvantitativnih odločitvenih metod: DEX in AHP pri ocenjevanju projektov*. Retrieved from: <https://dk.um.si/Dokument.php?id=67644>
31. Tausch A., Heshmati, A., & Bajalan, C.S.J. (2007). *On the Multivariate Analysis of the Lisbon*.
32. Tominc, P. (2006). *Metodologija v teorijah podjetništva. Učno gradivo pri predmetu Teorije podjetništva*. Maribor: EPF.
33. United Nations. (1992). *Agenda 21*. Retrieved from: <http://sustainabledevelopment.un.org/content/documents/Agenda21.pdf>
34. Urban Audit. (2004). *Urban Audit Perception Survey*. Retrieved from: [http://ec.europa.eu/public\\_opinion/flash/fl\\_156\\_en.pdf](http://ec.europa.eu/public_opinion/flash/fl_156_en.pdf)



35. Von Neumann, J., & Morgenstern O. (1953). *Theory of Games and Economic Behaviour*. Retrieved from: [https://archive.org/stream/theoryofgamesand030098mbp/theoryofgamesand030098mbp\\_djvu.txt](https://archive.org/stream/theoryofgamesand030098mbp/theoryofgamesand030098mbp_djvu.txt)
36. Voula, M. (1996). Our city, our future: towards sustainable development in European cities. *Environment and Urbanization*, 8 (1), 133–154.
37. Wegener, M., Eskelinen, H., Fürst, F., Schürmann, C., & Spiekermann, K. (2000). *Geographical Position. Study Programme on European Spatial Planning, Working Group 1.1, Final Report, Part 1*. Dortmund: Institute of Spatial Planning at the University of Dortmund (IRPUD).
38. Winter, A. (2010). *Competitiveness of the City of Graz in the Knowledge-Based Economy*. Graz: FHJ.
39. World Health Organization. (2009). *Urban Indicators Guidelines: Better Information, Better Cities*. Retrieved from: [http://www.who.int/kobe\\_centre/publications/urban\\_indicators\\_unhabitat/en/](http://www.who.int/kobe_centre/publications/urban_indicators_unhabitat/en/)
40. Zahavi, Y., Beckmann, K.J., & Golob, T.F. (1981). *The UMOT/Urban Interactions*. Washington, D.C.: US Department of Transportation, Washington.

## TURN TO THE EXPERTS FOR **SUBSCRIBE** CONSULTANCY

Subscribe is one of the leading companies in Europe when it comes to innovation and business development within subscription businesses.

We innovate new subscription business models or improve existing ones. We do business reviews of existing subscription businesses and we develop acquisition and retention strategies.

Learn more at [linkedin.com/company/subscribe](https://www.linkedin.com/company/subscribe) or contact  
Managing Director Morten Suhr Hansen at [mha@subscribe.dk](mailto:mha@subscribe.dk)

**SUBSCRIBE** - to the future



# 6 Foreign direct investment and cities

*“Globalization and free trade do spur economic growth, and they lead to lower prices on many goods.”*  
(Robert Reich)

Recommended additional reading:

- McFarland, K.C. & McConnell, J.K. (2011). Strategies for globally competitive cities. Local roles in Foreign direct investment and International Trade. Center for Research and Innovation. *National League of Cities, Washington, D.C. 20004*
- Mehta, P.S., in M. Dugal. (2003). *ABC of FDI. Monographs on Globalisation and India – Myths and Realities*. 3. CUTS Centre for International Trade, Economics & Environment.

## 6.1 Chapter Overview

International capital flows are important for economic development of cities. Foreign direct investments as one of the form of international capital flows bring a lot of benefits to the city. Studies that analyse effects of foreign direct investments on host cities show that they bring new skills in the city, generate direct and indirect employment, transfer technology and provide financial sources for local economic development. On the other side, foreign direct investments bring also some challenges for cities. They are most frequent in the form of fear or frustration for being unsuccessful by attracting foreign direct investments, a lot of cities have problems by changing policies to suit foreigners, very frequent threat from international capital flows is crowding out local entrepreneurs and businesses etc. During the period of increased volume of foreign direct investments a lot of cities developed and implemented their own strategy for attracting and supporting these processes. Such strategies seemed to be a very effective tool for maximizing the benefits and minimizing threats of foreign direct investments in cities.

Learning outcomes

By the end of this chapter successful students will be able to:

1. Define different forms of international capital flows
2. Understand effects of inward foreign direct investments on the host economy
3. Define factors that influence foreign direct investment flows
4. Define the most important steps for attracting and supporting foreign direct investments in the city.

## 6.2 FDI definition

Foreign direct investments (FDI) present one of the forms of international capital flows. Three major types of international capital flows are: FDI, foreign portfolio investment (FPI) and debt. The main characteristic of FDI and FPI is their stability and smaller proneness to reversals, while the main difference between them is that FPI lacks the element of lasting interest and control. FDI involve an equity stake of minimum 10%. Regarding benefits it is proved that FDI are more beneficial because of more direct control in management. Debt flows as a third form of international capital flows are bonds and bank loans and are more volatile.

UNCTAD (2013) defines FDI as investments that acquire long lasting interest in enterprises that operates outside of the country of the investor. FDI consist of reinvested earnings, equity capital and other capital (mainly intra-company loans). Also licensing, franchising, management contracts, product sharing, subcontracting, alliances, goodwill or grants named non-equity forms of investment can be FDI.

FDI can be classified in different forms regarding the type of classification. If classified on the base of entry modes of the foreign investor, FDI can be in the form of cross-border mergers and acquisitions (C-B M&As) or Greenfield investments. While Greenfield investments mean establishment of a wholly new operation in a foreign country, C-B M&As present takeover or merger with an existing local firm.

If classified from the recipient country view, FDI are classified as follows:

- Export-enhancing FDI, when FDI affects in transferring a new type of technology in order to increase host country export competitiveness.
- Import-substituting FDI, when FDI produce goods for the host country which is at that time imported from another country.

Classification from the point of investor view, categorize the following types of FDI:

- Horizontal FDI, when FDI produce the similar or the same product in the foreign country. The main goal is the exploitation of monopolistic advantages in the foreign country.
- Vertical FDI, when FDI acquire or build an operation that fulfils the role of a supplier or the role of a distributor. By the role of supplier, FDI seek to improve to the supply of certain key components or to the costs of raw material. By the role of distributor foreign investments are the response to the problem of finding distributors for a specific market.
- Conglomerate FDI include horizontal and vertical FDI.

By defining FDI, it is necessary also to distinguish between FDI net inflows and FDI net outflows. While the first ones present the value of inward direct investments made by non-resident investors in the reporting economy, the second ones present the value of outward direct investments made by the residents of the reporting economy to external economies (OECD 2013).

### 6.3 Development of FDI

Due to the differentiation in evaluating FDI then and now, the role of FDI in international capital transactions was much less notable before the First World War as it is today. The main difference is that the concept of FDI in that period did not differ from other forms of investments in foreign companies that come from the private sector (Lipsey 2001).

Although the First World War reduced international confidence and increased interventionism of national governments, FDI flows to overseas colonies increased because of high reconstruction costs and war debts. United States played the largest role as investor and the same happened also after the Second World War. After 1980 FDI increased even more because of the good general climate for FDI. The increase of FDI in the period from 1983 to 1989 was three times faster than global export growth and four times faster than global GDP growth (29% vs. 9.4% and 7.8% annually). The main factors influencing the increase of FDI were trade liberalisation and privatising and liberalizing of investments on national level (UNCTAD 1991 and Lipsey 1999).

**wethrive.net**

**How to retain your top staff**  
**FIND OUT NOW FOR FREE**

**DO YOU WANT TO KNOW:**

- What your staff really want?
- The top issues troubling them?
- How to make staff assessments work for you & them, painlessly?

**Get your free trial**  
 Because happy staff get more done



In 2000, overall inward FDI recorded \$1,300 billion but WTC attack in 2001 caused strong reduction of the volume of FDI. After 2003, FDI started to stabilise and in 2005 already recorded \$982 billion. In 2007 (UNCTAD 2008, p. 3–9), worldwide FDI reached record levels of \$1,970 billion but in 2008 the economic crisis interrupted the growth of international capital flows and the volume of global FDI reduced. After 2013, FDI flows started upward trend again and rose by 9 per cent to \$1,450 billion. In the following Figure we are presenting inflows of FDI by groups of economies from 1995 to 2013.

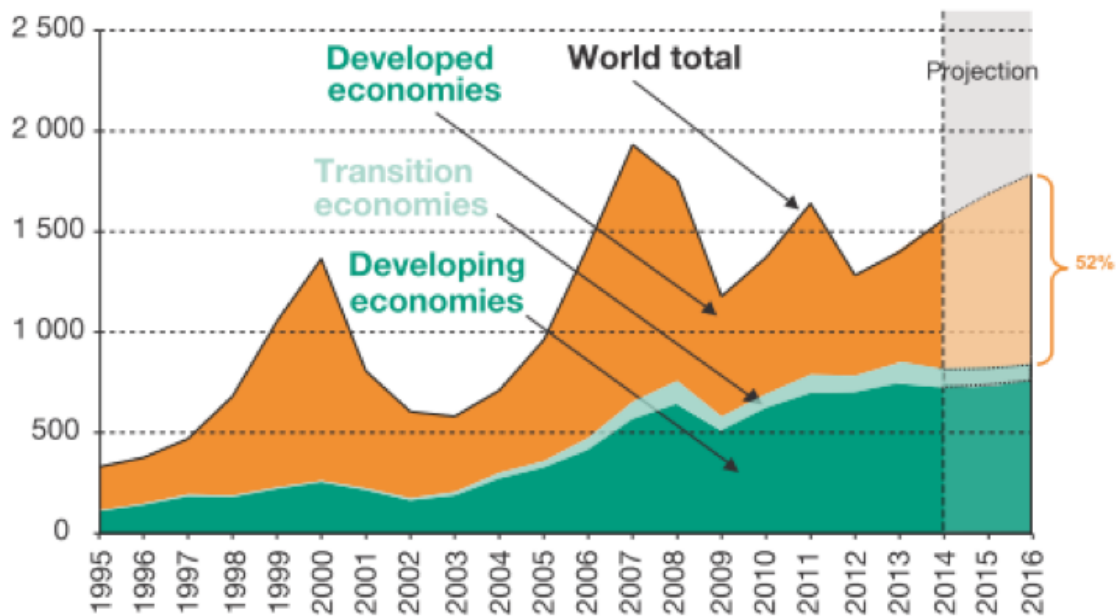

**Figure 15:** FDI inflows by groups of economies, 1995–2013  
Source: UNCTAD, 2014.

In the Figure 1 it is shown that for a long period, the highest volume of worldwide FDI recorded developed countries, while in 2010 transition and developing economies together for the first time attracted more than half of global FDI flows. In 2013 FDI inflows increased in developed, transition and developing economies, while FDI flows to developing economies accounted 54 per cent of global inflows.

Regarding the structure of the FDI, most investments before World War II were in natural resources and infrastructure. Manufacturing investments became the predominant form of FDI in the post-war period. Nowadays, the most important sector for FDI are services. According to UNCTAD report (2014) the most important target industry is currently information technology and business services, followed by agriculture and tourism.

According to the Global cities of the future 2014/2015 report (Mullan 2014), Singapore is the most FDI's global city of the future, following by the London and Hong Kong. Analysis includes 130 locations. Singapore presents an attractive location for investors because of its economic potential and business friendliness. Between 2008 and 2013 Singapore recorded almost 2000 Greenfield FDI. London is ranked at the second place because of the human capital and connectivity categories. Foreigners invest in London mostly because of proximity to markets and customers. In 2013 London recorded 300 Greenfield FDI. These two cities can present good practice from which other cities can learn about things that are important for attracting FDI.

#### 6.4 Why do companies invest in the foreign market?

The issue of FDI motives has crossed different streams of economic literature: theory of the firm, international business and international trade theory. The most famous and cited taxonomy of FDI motives is proposed by Dunning (1993). The economist John Dunning classified four primary motives foreign investors have when investing abroad. The taxonomy of motives is developed from the OLI paradigm (Dunning 1977). It includes three types of advantages: ownership, internationalization and location advantage. Ownership advantage explains why a company want to become a multinational, internationalization advantage explains how (in what way) a company want to enter foreign market and the location advantage explains the location where a company will probably invest. The taxonomy is created of the following categories (Dunning 1993, p. 59):

- **Resource seeking:** foreign investor wants to acquire particular resources that are missing (raw materials or natural resources) or are more expensive (unskilled cheap labour) in the home country.
- **Market seeking:** foreign investor is searching new buyers for their goods and services.
- **Strategic asset seeking:** foreign investors invest in foreign companies to help building strategic assets, for example distribution networks or new technology.
- **Efficiency seeking:** foreign investors invest in foreign country because of a lower cost structure. They want to gain from different cultures, factor endowments, economic systems, institutional arrangements, market structures and policies and by intensifying production in a limited number of locations for supplying multiple markets.

#### 6.5 Effects of FDI

FDI bring a lot of different effects to the host economy. Survey articles show inconclusive evidence in the literature regarding vertical and horizontal spillover effects of FDI. While some studies show positive effects of FDI on domestic companies, there are also some analysis proving neutral and also negative effects of these processes (some of the studies: Barro 1991; Aitken & Harrison 1999; Lipsey 2000; Liu et al. 2000; Gorg and Greenaway 2001; Balamoune-Lutz 2004; Lipsey and Sjöholm 2004).

The earliest studies of FDI effects relate to FDI impact on firm's productivity. Caves (1974) concluded that effects of FDI on productivity in a domestic firm are positive. Also Blomström & Persson (1983), Nadiri (1991), Chuang & Lin (1999) and Driffield (2001) came to the same conclusion when analysing FDI effects on the productivity.

Another analyses of positive FDI effects in several studies showed that FDI transfer new knowledge and technology, develop economy potential, generate additional tax revenue for the state, reduce unemployment, support the strategies for development of individual sectors, develop management knowledge and increase engagement of local companies in supplier and subcontractor networks (some of the studies: Findlay 1978; Estrin et al. 1997; Xu 2000; Perez 2008 and Lin 2008).

Very frequent in the literature is also the analysis of how FDI affect economic growth. The results differ. While Blomström (1986), Mody & Wang (1997) and Lensink & Morrissey (2006) concluded that inward FDI positively affect economic growth in the host country, Haddad & Harrison (1993) and Smarzynska Javorcik (2004) concluded that FDI does not affect economic growth and Kawai (1994) and Mencinger (2004) even proved that FDI negatively affect economic growth.

**Struggling to get interviews?**

Professional CV consulting & writing assistance from leading job experts in the UK.

Visit site

 Take a short-cut to your next job!  
Improve your interview success rate by 70%.

 **TheCVagency**  
Visit [theagency.co.uk](http://theagency.co.uk) for more info.

  **Click on the ad to read more**

FDI benefits are not self-evident and are different among countries. Lin (2008, p. 31) proved that FDI bring benefits if an investment environment is open and has active competition policies. Also democratic investment regime and trade, privatisation, deregulation and macroeconomic stability are very important factors by helping maximizing benefits of FDI. The distribution of FDI effects is depending on the business environment and economic policy regarding these processes in the host country as well as on other factors that affect their consequences. According to Reisen (1999) effects of FDI are positive with a time lag, while Cantwell (1989) and Perez (1998) believe that the positive effects of FDI depend on the sector in which the investment is entered.

On the other side, a lot of studies demonstrate negative effects of FDI. They often occur if conditions for FDI are unfavourable. Besides rising unemployment due to rationalization, uncompetitive behaviour of foreign owned companies, reduction of productivity of the host country, concentration increase in the domestic market (Kokko 2006; Aitken & Harrison 1999; Blonigen & Taylor 2000; Aslanoglu 2000; Haller 2005; UNCTAD 2007), closure of local firms, shrinking domestic stock market, low pricing for sold assets, pressure on current account and elimination of competition in the domestic market (Tsang & Hauck 2007; UNCTAD 2007, p. 123; Maček 2009; Maček & Ovin 2014) are the most important threats mentioned in the literature. However, in the last period minimizing the control in strategic industries and threatening the national autonomy and sovereignty appeared to be an important negative effect of FDI too (Lin 2008).

Mehta & Dugal (2003, p. 24–26) summarized effects of FDI that can regarding the conditions in the host country appear as a benefit or as a threat. For example FDI transfers technology and skills into the host country, but some countries cannot absorb high technology brought by foreign firms. FDI can improve market access of goods but if international capital flows enter the country only to exploit domestic markets, than there is no contribution to greater market access for domestic country exports. Although FDI often lead to increased employment in the host country, this is more often in well-developed urban sectors with high levels of education and infrastructure. In some cases FDI can improve the balance of payments, but on the other side through an increase in imports of inputs and through remittances of royalties and dividends abroad by the subsidiaries FDI could have also negative impact on the balance of payments of the host country. Effects of FDI depend on the form of international investment and mainly on the conditions for FDI in the host country.



When analysing benefits of FDI for cities, researchers often expose FDI as an important factor for economic development of cities. If summarized, the most frequent benefits of FDI for cities mentioned in the literature are the following:

- FDI bring new skills which can be later transferred to local workers and managers.
- FDI generate direct or indirect employment.
- FDI exchange technology, policy ideas and other forms of knowledge.
- FDI provide finance for economic development as international investments speed the construction of infrastructure, information systems and other basic conditions for development.
- With FDI city can improve human resources, marketing and other activities to strengthen the competitiveness of a city.

Generally, FDI helps to raise the profile of the cities. Local areas that have competed successfully for FDI in the past are highly attractive for more investment in the future.

On the other hand, the most common obstacles and challenges cities face regarding FDI are the following:

- Cities that are unsuccessful by attracting FDI can be frustrated.
- A lot of cities have problems by adopting policies for FDI (for example, policies to assist development at the urban periphery might contribute to transportation problems).
- FDI might push out local entrepreneurs and businesses.
- Foreign investors sometimes repatriate their profits to their own home countries instead of leaving them in the host city.
- The costs of offering incentives to foreign investors might lower the possible economic gains of investment.

As the main goal of each city and country is the maximization of benefits and minimization of costs of FDI the effective government regulation and friendly environment for investors is of high importance in ensuring effective utilisation of FDI.

#### Case Study 1: FDI in Singapore

In 1965 the city-state Singapore faced a lot of challenges, such as a lack of natural resources, small economic base and high unemployment. Today Singapore has one of the most open economies in the world. Openness is within the main reasons for rapid economic growth of this city. Since independence in 1965 Singapore has relied heavily on international trade and FDI for its economic development. During the period between 1965 and 1980 government introduced several steps to attract FDI. They developed one of the most liberal and open-trade regimes in the world, adapted national standards in the way that most industries are open to FDI and took concrete steps to protect intellectual property. They also prepared and implemented a strategic plan for creation of polytechnic schools and technological universities and made friendly environment for investors with investments in infrastructure (new roads, airports, and telecommunications).

From 1960 there was a significant increase of foreign share of GDP. FDI as a percent of GDP rose from 4.85 in 1970 to 21.4 in 2012. FDI in chemicals, petroleum, transportation equipment, electronic equipment and other manufacturing areas helped by developing those industries. From an economy that was primarily involved in manufacturing consumer goods in labor-intensive industries in the 1960s, Singapore moved to one that produces high value-added goods and a variety of complex services in the 2000s. Investment policies supported high-value added industries as well as targeted cluster activities, including those in logistics, research and development and biomedical sciences. In 2013 the values of FDI in Singapore recorded \$848.9 billion. The main investor countries in Singapore were United States, Netherlands, Japan, British Virgin Islands and United Kingdom (Hsu 2012; Mullan 2014).

### Case study 2: FDI in London

London is ranked on the top of European destination for FDI. The most FDI London attracts in the business services, financial intermediation, software sectors, security broking, insurance and pension. According to data from Greenfield investment monitor fDi Markets London recorded 300 Greenfield investments in 2013. Within Europe London led the ranking, ahead of Paris with 115 projects, Dublin with 89 and Moscow with 85.

**gaieteye**  
Challenge the way we run

**EXPERIENCE THE POWER OF FULL ENGAGEMENT...**

**RUN FASTER.  
RUN LONGER..  
RUN EASIER...**

**READ MORE & PRE-ORDER TODAY  
WWW.GAITEYE.COM**

London is known as a city that has an investor friendly policy. The government has established London Development Agency for providing all the necessary information and support to investors. This agency promotes foreign investments in the city in the form of several programmes. The agency is important by taking London towards a path of sustainable development and contributes to the development of the skills of the local people. Furthermore, London has also other agencies such as ‘Think London’ which was established for the promotion of London as a city for investments and for assisting investors with the complete important infrastructure for developing a business in the city.

If analysing the whole Europe the most popular sectors for inward FDI in 2013 were IT services and software, business services, textiles and financial services. Software and IT services created an estimated 14,829 jobs in 2013, while automotive components created 14,743 jobs and consumer products created 9,969 jobs. The most active investors in Europe in 2013 were from the Germany, US and the UK (Kaczmarek 2014).

## 6.6 Factors influencing FDI flows

In the literature factors, such as political risk, infrastructure, investment environment, judicial transparency, red tape, bureaucratic hurdles, regulatory framework and the magnitude and complexity of corruption in the host country are often mentioned as factors that influence international capital flows (Mottaleb 2007, p. 4). Also the availability of skilled labour, the country risk rating, the host country size (Nonnemberg & de Mendonça, 2004, p. 2), labour costs and the market openness (Taylor & Francis Group, 2004) are important factors that influence inward FDI flows. Chen (1996) and Bevan & Saul (2000) highlight also gravity factors, transport infrastructure and development and research capacity in the host country as important factors that influence on FDI flows.

In World Investment Report (UNCTAD 1998, p. 91) there is a list of factors that influence FDI flows classified as follows:

- factors related to natural resource extraction, new markets acquiring and greater efficiency named as microeconomic factors,
- political and economic factors meaning international FDI agreements, privatisation policy, the trade and fiscal policy and
- factors related to FDI promotion, location attractiveness, incentives for investments and other factors that are related to business facilitation.

Within them microeconomic factors are the most important while successful cities widely use incentives for attracting investment. With incentives policymakers stimulate investments in specific industries, activities or disadvantaged regions. The most common definition of incentives is that they presents non-market benefits used to influence the behaviour of investors. Incentives can be given in many different forms from national, regional and local governments. Different forms of incentives can be classified in three basic categories regarding benefits they offered: regulatory benefits, fiscal benefits and financial benefits. According to the UNCTAD report (2014) the most important type within incentives are fiscal incentives, while regulatory and financial incentives are less important policy tools for attracting FDI.

Blomstrom & Kokko (2006, p. 22) highlighted general country's industrial policy is the main determinant for attracting FDI and maximizing their benefits. A lot of countries and especially cities within them developed their own strategy for gaining the most positive effects of international capital flows. The main components of such strategies are presented below.

## 6.7 A City strategy for attracting FDI

Cities play an important role by attracting FDI. As already written FDI inflows depends on many different factors, but practice show that city can strong influence on the effects of international investments. The most important things are that they attract the appropriate investments and offer the conditions in which investment gives the most positive effects. When locating the business, investors seek the following:

- a stable regulatory and macro-economic environment,
- natural factors, such as climate, geography and endowment of natural resources,
- market access and open competition,
- human factors such as skilled labour,
- manageable regulation and taxation system,
- social factors such as infrastructure of each locality and a good quality of life.

By answering the question “How to become an attractive destination for investors” the most successful cities developed and implemented their own model or strategy for attracting and supporting FDI. McFarland & McConnel (2011, p. 9–15) define the following 5 steps, which help cities to attract and support FDI.

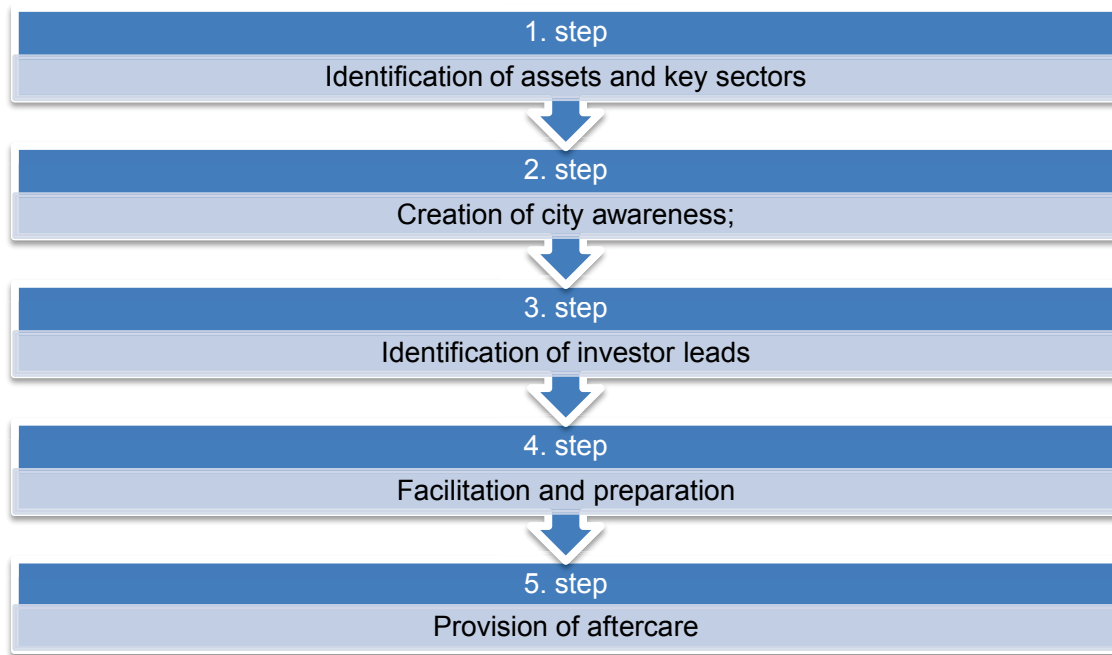

**Figure 16: Strategy for attracting and supporting FDI in the cities**

Source: McFarland & McConnel (2011, p. 9–15).

### 1. Identification of cities’ Assets and Key Sectors

In the first step city should make an analysis of its strengths and weaknesses. An analysis should include also city’s access to technology, workforce skills, quality of life and physical infrastructure. As local and regional assets are very important for FDI attraction, cities should accelerate already existing assets and provide clear specification for the types of businesses or industries it can support.

The most effective way is that city focus on its own location and competitive advantages. City should focus on business and industries whose strategic needs match local assets, that have a tendency to invest in foreign capacity and in which the city has distinct strengths in the sector compared with other places competing for investment. The result of this step should be the list of the most important sectors. Important are also sectors that involve local actors as that signals that there is supporting infrastructure, workforce, technologies, services and suppliers for their industry. Foreign investors often favour to invest in the sectors that already have a strong local presence.

### 2. Creation of City Awareness

The second step city should do when preparing the strategy for FDI attraction is developing and promoting the awareness of cities assets. In achieving this goal most cities build their own image or brand, which helps them to raise the visibility of their strengths and opportunities. An image should have the goal to differentiate the city from others that compete for inward FDI.

Deep support among key partners and local and regional leaders is also important for foreign investors because local chambers, elected officials and regional organizations have influence on the success of a business or economic development project.

After developed image city should create the awareness of the image. This can easy be done with videos of city and print brochures presenting specific assets of interest, including a list of investment opportunities. An important way for city promotion is also a multilingual website of the city, which should be easy to use. It is important that the advantages of a city are communicated through different industry channels. Furthermore, city should contact firms targeted as potential investors directly with tailored information.

### 3. Identification of Investor leads

The main aim of third step is to generate greater quantity and quality of business leads in the city. Proactive lead generation is of importance by ensuring that investments are supporting the overall economic goals of the city.



This e-book  
*is made with*  
**SetaPDF**

**SETASIGN**

PDF components for **PHP** developers

[www.setasign.com](http://www.setasign.com)

For proactive lead generation a lot of cities have specific local strategies that rely especially on networking and relationship building. For better effectiveness of attracting FDI cities should be engaged in these activities for identification of leads and for ensuring that it is well-positioned when an investment opportunity appears. Specific local strategies contain:

- A list of experts from industry that help generating leads. They are important for maintaining and strengthening the existing networks and present the main base of knowledge when potential investors have questions;
- A plan for business networks with economic development organizations in foreign cities that have similar or complimentary industry targets. This is important for beneficial partnerships;
- Connection with state agencies and providing them with city's investment portfolio.

It's important to know that the most positive for host city are investments for which city have the right assets to meet investment needs.

#### 4. Facilitate and Prepare

City should understand the business environment and prepare itself with supportive environment, resources and guidance to simplify the international business. Within this step it is advisable for city to build a city advisory committee with an aim that of providing resources and information quickly if an investment deal is appearing. The best is if committee is composed of people who can qualitative and quick answer technical questions about the city to the potential investors (bankers, real estate lawyers, environmental lawyers, regulators). Member of the committee should be fast responsive as this proves that the city is committed and serious.

City should also fulfil the investors' needs regarding strategically using resources, such as establishing a foreign trade zone, workforce training, clearing land or providing financial incentives. Having in mind that there are stages of the site-selection process it's necessary to understand what kind of incentives is beneficial for the investor at a particular moment. If other basic factors, for example, quality of life is of greater concern of investors an incentives package is irrelevant. Blomstrom & Kokko 2003, p. 22) suggest that incentives are focused on the activities with strongest potential for spillovers.

Foreign firms often search similar conditions for business as they have in their own country. Cities can help foreign investors by managing their expectations and understanding of the business requirements and environment in the city. Barriers such as language or different legal system can be overcome with offering translators, lawyers, accountants etc. The main goal of this step is that investors recognize the city as the one that they can count on.

## 5. Monitor and Provide Aftercare

The last important step is city awareness that the support and concentration to the foreign investment and firm should not end after the deal is secured. Activities within this step include evaluating the success of each investment. City should analyse for example: the number of jobs created, new or improved technology and other economic benefits foreign investment brought to the city.

Investors' aftercare is also important because it facilitates retention and the early and continued success of the investment, generates new leads more easily and quickly and continues to leverage the investment for economic growth. Aftercare provision usually includes continued support to the business, such as constant communication with the investor.

A city will have the greatest success by attracting investments in industries where it has a competitive advantage. Practice shows that FDI strategies succeed when the city has the ability to support investments and budget is appropriate. City should have well prepared marketing strategy and follow-up procedures. And the last, but very important thing is that people involved in attracting foreign investors are aware of cities' strengths and understand investment needs.

# Free eBook on Learning & Development

By the Chief Learning Officer of McKinsey

[Download Now](#)

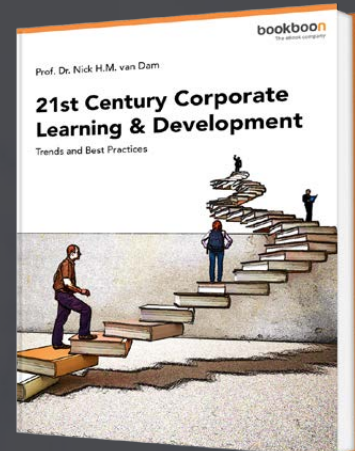

[Click on the ad to read more](#)



Case study 3: Best practice tools for attracting FDI in cities

Many successful cities attract inward foreign direct investment. For improving the flow of private investments in cities simplified administration, clarity in policy, contamination remediation, targeted private sector initiatives and clarity of procedures were found to be the most important. In the following table we are showing what tools selected cities have implemented in order to increase international capital flows.

City	Governance	Tools
Amsterdam	A voluntary public/private partnership named Amsterdam Economic Board promotes investment across 25 local and 2 regional councils. Official FDI agency is Amsterdam inbusiness.	Webpage includes presentation of information on key industries for investments and success stories of existing investors. (see: <a href="http://www.iamsterdam.com">http://www.iamsterdam.com</a> )
Barcelona	Council's Barcelona Activa is the IPA.	Webpage includes presentation of all necessary information for investors. (see: <a href="http://www.barcelonactiva.cat">www.barcelonactiva.cat</a> )
Birmingham	A public/private partnership named Marketing Birmingham is responsible for inward foreign investments.	Webpage includes information on case studies, events, 3D video on the economic zones and other important information for investors. (see: <a href="http://businessbirmingham.com">businessbirmingham.com</a> )
Edinburgh	A public-private body named Marketing Edinburgh promotes city for investments.	Webpage includes invest map, Invest Edinburgh magazine, deals, blogs, development hotspots and other important information for investors. (see: <a href="http://www.investinedinburgh.com/">http://www.investinedinburgh.com/</a> )
Hamburg	HWF Hamburg Business Development Corporation is the city's joint public-private IPA.	Webpage presents introduction for establishing a business in the city and other important information for investors. (see: <a href="http://www.hamburg-economy.de">www.hamburg-economy.de</a> )
Paris	Paris Développement is council's economic development agency acting as IPA.	Webpage presents projects and opportunities for investments in Paris. (see: <a href="http://www.investinparis.com/en">www.investinparis.com/en</a> )
Singapore	Attracting investors is part of the work of Contact Singapore, an alliance of the Singapore Economic Development Board and Ministry of Manpower.	Webpage offers information on business parks and presents online guide for potential investors. ( <a href="http://www.contactsingapore.sg/investors_business_owners/">http://www.contactsingapore.sg/investors_business_owners/</a> )

**Table 5:** Strategies for attracting FDI in cities  
Source: Waterfront Development Agency, 2014.

From the table it can be noticed that the prevailing governance structure is an integrated, enabling council-led Investment Promotion Agency (IPA) for the whole city or region and a public-private model for specific districts. The functions of the IPA usually include investor facilitation and servicing, image building and policy advocacy. To be effective, the IPA should have a high degree of political visibility, active private sector involvement, and operate in a good investment environment. The main tool cities use is one-stop shop (OSS) website with the main focus of FDI in key sectors and development zones. All presented cities also offer many incentives for investors. Normally incentives include tax holidays, policy reforms and infrastructure improvements.

## 6.8 Conclusion

Foreign direct investments present an important source of capital and are considered as an effective instrument for the distribution of know-how and skills in the global economy. Among the most frequent positive effects in the form of increasing of employment, technology and know-how transfer and rising productivity international investments can also improve management systems and transfer the best practices in accounting rules, corporate governance and legal traditions across borders. Although inward FDI has wider positive effects we should be aware also of threats that international capital flows can present for the cities. These are the most frequent in the form of frustration for being unsuccessful by attracting foreign direct investments, crowding out local entrepreneurs and businesses etc. With the goal of maximizing the benefits and minimizing the costs of foreign investments it is advisable that cities develop an own strategy for attracting and supporting foreign investments. In such a way city identify key assets and sectors with potential to invest, identify the investor leads, prepare the environment for investments and support the investors in many different ways. With the appropriate and favourable conditions for investments city can gain such benefits from investments that strongly contribute to economic development of the city.

## 6.9 References

1. Aitken, B. & Harrison, A. (1999). Do domestic firms benefit from direct foreign investment? Evidence from Venezuela. *The American Economic Review*, 89 (3), 605–618.
2. Aslanoglu, E. (2000). Spillover effects of foreign direct investments on Turkish manufacturing industry. *Journal of International Development*, 12, 1111–1130.
3. [Baliamoune-Lutz](#), M.N. (2004). Does FDI Contribute to Economic Growth? *The Journal of the National Association for Business Economics*, XXXIX (2).
4. Barro, R. (1991). Economic Growth in a Cross Section of Countries. *Quarterly Journal of Economics*, CVI (2), 407–444.
5. Bevan, A.A. & Saul, E. (2000). The Determinants of Foreign Direct Investment in Transition Economies, William Davidson Institute Working Paper 342.
6. Blomström, M. (1986). Foreign Investment and Productive Efficiency: The Case of Mexico. *Journal of Industrial Economics*, 15, 97–110.

7. Blomström, M. and H. Persson (1983). Foreign Investment and Spillover Efficiency in an Underdeveloped Economy: Evidence from the Mexican Manufacturing Industry. *World Development*, 11, 493–501.
8. Blonigen, B. & Taylor, C. (2000). R&D activity and acquisitions in High Technology Industries: Evidence from the US Electronics Industry. *Journal of Industrial Economics*, 47 (1), 47–71.
9. Cantwell, J. (1989). *Technological Innovation and Multinational Corporations*, p. 239, ISBN 0631138471, Basil Blackwell, Oxford.
10. Caves, R.E. (1974). Multinational firms, Competition and Productivity in Host-Country Markets. *Economica*, 41 ( 162), 176–193.
11. Chen, C. (1996). Regional determinants of foreign direct investment in Mainland China. *Journal of Economic Studies*, 23, 18–30.
12. Chuang, Y.C. and C.M. Lin. (1999). Foreign Direct Investment, R&D in Spillover Efficiency: Evidence from Taiwan's Manufacturing Firms. *Journal of Development Studies*, 35, 117–137.
13. Driffield, N. (2001). The Impact on Domestic Productivity of Inward Investment in the UK. *The Manchester School*, 69 (1), 103–119.
14. Dunning, J. (1977). *Trade, Location of Economic Activity and the Multinational Enterprise: a search for an eclectic approach*. London: Macmillan.
15. Dunning, J.H. (1993). *Multinational Enterprises and the Global Economy*. Harlow: Addison-Wesley.



**YOU THINK.  
YOU CAN WORK  
AT RMB**

**RAND  
MERCHANT  
BANK**  
A division of FirstRand Bank Limited  
Traditional values. Innovative ideas.

Rand Merchant Bank uses good business to create a better world, which is one of the reasons that the country's top talent chooses to work at RMB. For more information visit us at [www.rmb.co.za](http://www.rmb.co.za)

Thinking that can change your world

Rand Merchant Bank is an Authorised Financial Services Provider



Click on the ad to read more

16. Estrin, S., K. Hughes and S. Todd. (1997). *Foreign Direct Investment in Central and Eastern Europe*. London: Cassell.
17. Findlay, R. (1978). Relative Backwardness, Direct Foreign Investment, and the Transfer of Technology: A Simple Dynamic Model. *Quarterly Journal of Economics*, February, 92 (1), 1–16.
18. Görg, H. & Greenaway, D. (2001). Foreign direct investment and intra-industry spillovers: a review of the literature. *Research paper / Leverhulme Centre for Research on Globalisation and Economic Policy*, 2001, 37.
19. Haddad, M. & Harrison, A. (1993). Are there positive spillovers from foreign direct Investment? *Journal of Development Economics*, 42, 51–74.
20. Haller, S.A. (2005). *The Impact of Multinational Entry on Domestic Market Structure and R&D*. Economics Working Papers 16. European University Institute.
21. Hsu, L. (2012). Inward FDI in Singapore and its policy context. Columbia FDI profiles. Retrieved from: [http://ccsi.columbia.edu/files/2014/03/Singapore\\_IFDI\\_-\\_FINAL\\_-\\_31\\_May\\_2012.pdf](http://ccsi.columbia.edu/files/2014/03/Singapore_IFDI_-_FINAL_-_31_May_2012.pdf).
22. Kaczmarek, M. (2014). London leading European destination for FDI in 2013. *fDi Magazine*. Retrieved from: <http://www.fdiintelligence.com/Locations/Europe/Russia/London-leading-European-destination-for-FDI-in-2013>.
23. Kokko, A. (2006). The Home Country Effects of FDI in Developed Countries. Working paper, 225.
24. Lensink, R. & Morrissey, O. (2006) Foreign Direct Investment: Flows, Volatility, and the Impact on Growth. *Review of International Economics* 14, 478–493.
25. Lin, C.H. (2008). Role of Foreign Direct Investment in Telecommunication Industries: A Developing Countries' Perspective. *Contemporary Management Research*, 4 (1), 29–42.
26. Lipsey, R.E. (1999). The role of foreign direct investment in international capital flows. National Bureau of Economic Research Working Paper 7094.
27. Lipsey, R.E. (2000). Interpreting Developed Countries' Foreign Direct Investment. Working paper 7810. Retrieved from: <http://www.nber.org/papers/w7810>.
28. Lipsey, R.E. (2001). Foreign Direct Investment and the Operations of Multinational Firms: Concepts, History and Data, National Bureau of Economic Research Working Paper 8665.
29. Lipsey, R.E. & Sjöholm, F. (2004). Foreign direct investment, education and wages in Indonesian manufacturing. *Journal of Development Economics*, Elsevier, 73 (1), 415–422.
30. Liu, X., P. Siler, C Wang and Y. Wei. (2000). Productivity Spillovers from Foreign Direct Investment: Evidence from UK Industry Level Panel Data. *Journal of International Business Studies*, 31 (3), 407–425.
31. Maček, A. (2009). *Čezmejne združitve in prevzemi kot dejavniki tranzicije v EU*, Doktorska disertacija. Maribor: Ekonomsko-poslovna fakulteta.
32. MAČEK, A. & OVIN, R. (2014). Does economic interventionism help strategic industries? Evidence from Europe. *E+M*, 17 (3), 5–14.

33. McFarland, K.C. & McConnell, J.K. (2011). Strategies for globally competitive cities. Local roles in Foreign direct investment and International Trade. Center for Research and Innovation. National League of Cities, Washington, D.C. 20004
34. Mehta, P.S., in M. Dugal. (2003). ABC of FDI. Monographs on Globalisation and India – Myths and Realities. CUTS Centre for International Trade, Economics & Environment.
35. Mencinger, J. (2004). Tuje neposredne naložbe-mana z neba? *Gospodarska gibanja*, 362, 25–44.
36. Mody, Ashoka, and Fang-Yi Wang. 1997. Explaining Industrial Growth in Coastal China: Economic Reforms...and What Else? *World Bank Economic Review* 11 (2):293–325.
37. Mottaleb, K. A. (2007). Determinants of Foreign Direct Investment and Its Impact on Economic Growth in Developing Countries, 04.03.2009, Retrieved from: [http://mpira.ub.uni-muenchen.de/9457/1/MPRA\\_paper\\_9457.pdf](http://mpira.ub.uni-muenchen.de/9457/1/MPRA_paper_9457.pdf).
38. Mullan, C. (2014). Global cities of the Future 2014/15 Winners. Retrieved from: <http://www.fdiintelligence.com/Locations/Global-Cities-of-the-Future-2014-15-the-winners>
39. Nonnemberg, M.B. & de Mendonça M.J.C. (2004) The Determinants of Foreign Direct Investment in Developing Countries. In: *Anais do XXXII Encontro Nacional de Economia* 61, 02.02.2009. Retrieved from: <http://ideas.repec.org/p/anp/en2004/061.html>.
40. OECD. (2013), *OECD Factbook 2013: Economic, Environmental and Social Statistics*, OECD Publishing, Paris. DOI: <http://dx.doi.org/10.1787/factbook-2013-en>.
41. Perez, R.P. (2008). A regional approach to study technology transfer through foreign direct investment: The electronics industry in two Mexican regions. *Research Policy*, 37 (5), 849–860.
42. Perez, T. (1998). *Multinational Enterprises and Technological Spillovers*. Amsterdam: Harwood.
43. Reisen, H. (1999). *After the Great Asian Slump: Towards a Coherent Approach to Global Capital Flows*. Policy Brief 16. Paris: OECD Development Centre.
44. Smarzynska Javorcik, B. (2004). Does Foreign Direct Investment Increase the Productivity of Domestic Firms? In *Search of Spillovers Through Backward Linkages*. *American Economic Review*, 94(3): 605–627.
45. Taylor & Francis Group. (2004). *Determinants Of Foreign Direct Investment: Empirical Evidence From EU Accession Candidates*, 02.04.2009, Retrieved from: <http://jobfunctions.bnet.com/abstract.aspx?docid=313929>.
46. Tsang, M. & Hauck, D. (2007) *Stock Markets Contract as M&A Overtakes Equity Sales*. In: *Bloomberg.com*, 05.06.2008, Retrieved from: <http://www.bloomberg.com/apps/news?pid=20601087&sid=aOgjATE5e50s&refer=>.
47. UNCTAD – United Nations Conference on Trade and Development. (1991). *World Investment Report 1991, The Triad in Foreign Direct Investment*. New York.
48. UNCTAD – United Nations Conference on Trade and Development. (1998). *World Investment Report 1998. Trends and Determinants*. New York.
49. UNCTAD – United Nations Conference on Trade and Development (2007). *World Investment Report 2007, Transnational Corporations, Extractive Industries and Development*. ISBN 978-92-1-112718-8, New York and Geneva.

50. UNCTAD – United Nations Conference on Trade and Development. (2008). World Investment Report 2008, Transnational Corporations and the Infrastructure Challenge. ISBN 978-92-1-112755-3, New York and Geneva.
51. UNCTAD – United Nations Conference on Trade and Development (2013). Definitions of FDI. Retrieved from: <http://unctad.org/en/Pages/DIAE/Definitions-of-FDI.aspx>
52. Waterfront Development Agency. (2014). Best practice inward investment strategies for the city centre. Retrieved from: <http://www.waterfrontauckland.co.nz/getmedia/bcf7b8ce-5c93-4c6a-bb0c-47cf7262b6bb/Best-practice-inward-investment-strategies.pdf?ext=.pdf>
53. Xu, B., (2000). Multinational Enterprises, Technology Diffusion, and Host Country Productivity Growth. Journal of Development Economics 62, 477–493.



Discover the truth at [www.deloitte.ca/careers](http://www.deloitte.ca/careers)

**Deloitte.**

© Deloitte & Touche LLP and affiliated entities.



Click on the ad to read more

# 7 Innovations for sustainability

*“To raise new questions, new possibilities, to regard old problems from a new angle, require creative imagination and marks real advance in science.” (Albert Einstein)*

Recommended additional reading:

- Smart City Reference Model: Assisting Planners to Conceptualize the Building of Smart City Innovation Ecosystems (Zygiaris, S.J. 2013, p. 4(2), 217–231).
- Will the real smart city please stand up? Intelligent, progressive or entrepreneurial City? (Hollands 2008, 12(3), 303–320).

## 7.1 Chapter overview

Understanding the concept of sustainable innovation is an urgent fundament to create development projects for community progress. Financing them is not such a big problem as it seems at first look if we have in mind that cooperation between as many different stakeholders as possible is the key for success. Every community has its own needs. It is not important if the community is organized as a small town or even village or if it is a big urban centre. Truth is that around 50% of population lives in big urban centres but there is a fact that the other half lives in smaller communities. Generally we cannot and may not talk about progress by forgetting the needs of that other half. The sustainable development is only possible if every sphere is developing equally.

Learning outcomes

Your goals for this “Innovations for sustainability” chapter are to learn about:

- the concept of sustainability,
- innovations – what they are and why are they so essential for social and economic development,
- different ways of financing innovations in public services,
- the basic concept of private investments in public infrastructure,
- the need of analogy between big cities and small communities.

## 7.2 Sustainability – A concept or just a fashion?

Man’s attitude towards the environment has through thousands of years presented itself in exploitation of natural resources that have been inferior to the needs a human as the “absolute master with the right to an unlimited use and exploitation.” (Pichler 1997, p. 1291)

In the last hundred and fifty years in which the human kind managed to achieve the biggest technologic progress in history it became evident that the uncontrolled desire for an economic expansion, without any respect for the consequences, endangered its own existence. The first recognition, that due to endangering our own kind it is necessary to protect the environment in which humans live was followed by implementation of rules, restrictions and later different regulations which (except a handful of people) not many thought of as significant. The second recognition, that a healthy environment is in fact a foundation for a healthy life resulted in the beginning of the development of the Environmental Law.

In spite of the environment protection with the help of the numerous national and international legal norms the uncontrolled industrialization and urbanization caused an enormous damage to the environment that consequently resulted in emergence of eco-remediations that could be defined, not only as environment protection but also as systems for regeneration of the environment, which take into consideration the meaning, structure and functioning of ecosystems. In the second half of the previous century most of the modern countries added the environmental care in their directives of the “ economic and social development” as a responsibility towards the global community.

The fact that the uncontrolled use and exploitation of the natural resources caused not only thinning of the ozone layer, the green house effect, animal and plant species extinction etc., but also a lack of natural resources had in our opinion been the reason for growing tendencies for replacement of non-recyclable natural resources with the recyclable or limited with the unlimited, with which we could ensure a permanent use of natural resources.

Brundland (1987, UN report Our common future)) has in her report popularized the term ‘Sustainable development’ and made its definition that has since then been, in addition to the World Bank, used in numerous governments and international documents. She believed that a sustainable development means satisfying the needs of today without jeopardizing the future generations in fulfilment of their needs. Surely, sustainable development is by no means only the use of natural resources. In the same report Desai illustrated the sustainable development by using an image of a bridge connecting economy, ecology and ethics and emphasised that is necessary to link different sectors (agriculture, energy, commerce, investments) and integrate the sectors into the development planning. He also points out that it is necessary to expand the concept of the sustainable development onto all sector policies and the most important: onto the key private sphere stake-holders.

The very report meant a turning point in perception of development policies and the term “ economic and social development” that had often been used before got replaced by the term “Sustainable Development”.



Lukman (2009, p. 82) claims that a “sustainable development emphasises the evolution of society with a responsible economic acting that is in accordance with environmental and natural processes. The political dimension for him represents the key element to it. In the sustainable development the paradigm of the economic, social and environmental resources limitations with intent to contribute to the welfare of the future generations is contained. It can be applied on a local, national or global level; anywhere it always bases on political decisions.”

The role of the politics lies within the development guidelines of any field whatsoever may it be the economic, social or environmental and is important indeed. However we believe that without an efficient cooperation (vertical as well as horizontal) of all stakeholders, politics cannot fulfil its basic task which is to achieve those sustainable goals towards which the development of the society has to be oriented towards in order to ensure its present as well as the future welfare.

According to Sharachchandra (1991, p. 607–621) the term Sustainable Development is merely a phrase, that not only does not offer a satisfactory definition but even more, it demonstrates the lack of an actual content in interpretations of the concept and an inability to form a picture of an efficient model of a sustainable institution.

[bookboon.com](http://bookboon.com)

# Corporate eLibrary

See our Business Solutions for employee learning

[Click here](#)

Management    Time Management

Problem solving    Self-Confidence    Effectiveness

Project Management    Goal setting    Motivation    Coaching

Click on the ad to read more

We, his critics can give our consent since it is impossible to trace the unified definition of the sustainable development in theory and it is usually linked with the context in which it is used in EU's documents where we can also find the term "the sustainable growth" and an interpretation that bases on Brundland's report when explaining the term. And if the report on our joint future has in fact set a frame for a definition, it has within that left a vast space for different interpretations. This on its own is, of course, not bad. The problem however is, and we should agree with Sharachchandra on this one as well, that with the popularization of the term came also an uncontrolled phraseology. "Sustainable, sustaining etc." became adjectives that often simply get patched on to numerous different terms only because it is more likeable.

The logical consequence of such examples is that it is difficult indeed to extract the content out of such expressions. In case there was an efficient model of executing a sustainable activity, such and other similar nebulousness could be avoided but now even though a well designed frame of a definition of sustainable development, as a consequence of the stated above, creates a (false) impression that the sustainable development is nothing but a phrase.

A similar opinion was also expressed by Temple (1992, p. 1) when he wrote that the term "Sustainable" is overdosed and that "the word 'sustainable' is these days used in far too many instances and ecologic stability is one of the instances that is confusing for numerous people. You have heard about the sustainable development, the sustainable growth, the sustainable economies, the sustainable societies and the sustainable agriculture. Everything is sustainable."

Not considering the critiques, the problems of sustainable development has been from year to year becoming more enforced.

In the year 1992, within the frame of the Conference of the United Nations RIO+10, on the basis of the Brundald's report a discussion had been opened on development projects and adopted an important document named Agenda 21. As a conclusion document the Agenda has defined the key environmental problems as well as the necessary measures and references for reaching a sustainable development. Important guidelines were given in the Agenda's part where it recommends transferring the executing principles and producing concrete plans for a sustainable development onto the lower political spheres which means from the international onto the national and hence from onto the local level.

Agenda 21 has referenced redefining and encouraging the institutional changes that have according to Write (2004, p. 761–768) an essential role in achieving the sustainable development. The role of the local communities is in this respect particularly important. Developing individual sustainable goals oriented on specific needs or tasks of a specific local community including all the stakeholders (public administration, economies, public sector, civil society, inhabitants) on the basic development areas (economic, social and environmental) brings benefits to the community as well as to the inhabitants. At the same time it represents an “important demonstration of the ways necessary to achieve the wanted values and performance within the whole community.” (Cortese 2003, p. 15–22)

The World Forum 2005 has placed the strategy of the sustainable development in three pillars that support each other:

- the economic development
- the social development
- protecting the environment.

According to some United Nations’ Forums we should in the lines of the general declaration on cultural diversity also have the fourth pillar, represented by the cultural diversity.

Protection of natural resources is embedded in all the spheres of the sustainable development and represents an efficient use of energy (heating, cooling, lighting), environment protection and eco-remediation (managing the agricultural, forest land, building plots, water systems, litter, air), the use of the green technologies (broad-range connections and internet services, roads, public transport, railways) as well as the care for healthy food and a reasonable planning and executing the plans for the non-economic activities as are health-care and education. In doing so, a concern for the environment and a responsible use of natural resources also have to be a part of the strategy of economic development. In addition to a consistent concern for the environment the economic development has to focus on all members of the community and not just on a few.

According to Schoeman (2013) when social development is concerned there is a distinctive problem within the poor communities that are for the most part overlooked in the big development plans, which needs to be overcome in striving to achieve a real sustainable development. The indicators of the sustainable social development are mainly the length of life-time, education and GDP per person.

From the three pillars of sustainable development it is evident that the development applies on the environment as well as on the economy and social strata of people. In case it is executed on all three levels at the same time, then we can actually talk about a real development. The imbalance of the spheres or simply a “development” that is profit oriented cannot be marked as a sustainable one.

The United Nation's conference RIO+20 in 2012 has for many been a disappointment. Considering the fact that it has been 25 years since the Brundland's report was published and 20 years since the first world forum (where the Agenda 21 was accepted) happened, there has been, with the exception of numerous polemics, meetings and conferences, done very little. As the main reason, too big expectations from the national and the intergovernmental administrations without cooperation, public rising of awareness, educating the general public and those active in the field of economy was pointed out. (Halle, Najam and Beaton 2013, p. 1–14)

EU has in its contribution for the conference singled out that in spite of efforts from the sides of government and non-government organizations in all the Countries sustainable development still is not a priority on political agendas, also that the goals are still not specifically defined and that there is simply not enough cooperation between ministries in governments. To be able to annulate the gap in practice it is important to stimulate wholesome strategies, public interest, raising awareness and efficient administration. Above all however, it is urgent to start imputing new mechanisms of coordination and establish an active cooperation among all involved: the government and the non-government organizations, local authorities, civil society and the private sector. The cooperation between the public and the private sector in transition to a sustainable development is crucial for EU.

The sustainable consciousness has to be introduced to all organizational structures; it needs to become a part of the research, development and innovativeness, teaching, learning and expert work, as well as, all the activities have to be carried out in graduate baby steps and goals. In addition to this, it is necessary to firstly focus on the local level and spread the new realisations horizontally and only then spread them vertically.

Due to the definitions quoted that are in fact more or less politically prejudiced, the formal specification of sustainable development from the point of view of the Theory of Systems or the Theory of Systems Management is indeed extremely demanding. Both disciplines have been developing since the 1960s. (Hasegawa 2013, p. 1–7)

Let us abstract the sustainable development as a management system (P) that has a multitude of outputs (y) in time (t). Those outputs define the economical, social and environmental indicators. The sensor (F) enables the detection of the selected indicators. According to the soft definition it should detect the economic statistics, public opinion surveys as well as the results of measurements of environmental physical quantities. The measured differences (e) among the desirable values (r) and the measured output values (y) are then brought into the controller (C). The later has to generate such inputs (u) that draw the output values towards the desired values (r).

The controller in such a context has to react on both levels, on the legislation level as well as on the monitoring and undertaking compulsory measures (e.g. financial, tax, environmental control). Unforeseen disturbances (i) from the system surroundings influence the mirroring of the inputs (u) onto the outputs (y). The principle of system management leaning towards graduate reductions of the difference (e) between the wanted condition (r) and the actual condition (y) is in theory of management called the principle of the management system with a negative loopback (Figure 17).

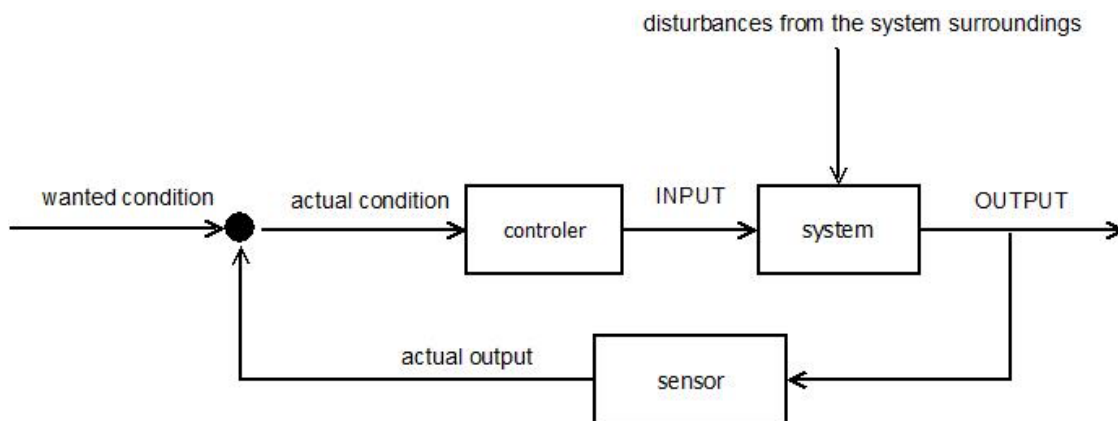

**Figure 17:** Principle of the management system with a negative loopback  
 Source: Own, 2014

# Brain power

By 2020, wind could provide one-tenth of our planet's electricity needs. Already today, SKF's innovative know-how is crucial to running a large proportion of the world's wind turbines.

Up to 25 % of the generating costs relate to maintenance. These can be reduced dramatically thanks to our systems for on-line condition monitoring and automatic lubrication. We help make it more economical to create cleaner, cheaper energy out of thin air.

By sharing our experience, expertise, and creativity, industries can boost performance beyond expectations. Therefore we need the best employees who can meet this challenge!

The Power of Knowledge Engineering

Plug into The Power of Knowledge Engineering.  
 Visit us at [www.skf.com/knowledge](http://www.skf.com/knowledge)



Such a weakly defined system of sustainable development is practically uncontrollable, unobservable and consequently instable. Some brilliant scientists such as Piere-Simon Laplace (Z-transformations, Theory of Probability), Aleksander Lyapunov (Theory of Stability), Norbert Wiener (Cybernetics), Harry Nykvist (Criteria of stability), Richard Bellman (dynamic programming), Andrej Kolmogorov (Wiener-Kolmogorov's filter), Kalman (Kalman's filter), Lev Pontrjagin (maximum and bang-bang principles) have been working on solving these problems.

The very concept of stability could be used as an analogy for sustainable development. Let us enumerate only the most important obstacles for management system with a negative loopback:

- measuring of the output of variables: a) there is no consensus on recruitment of the output variables and b) different delays in taking the measurements (e.g. from milliseconds in environmental measurements to several months in opinion surveys and economy statistics) and c) a sensor has to measure multiple variables simultaneously since it is the so called MIMO system in question (multiple inputs, multiple outputs),
- a dynamic setting of the desired values: in addition to the emergence of new indicators (and letting go of the old ones) the set point values of the outputs change with time,
- Building a robust and at the same time responsive and in addition to that also a precise controller would demand a lot of cooperation and efforts from different participants (from science to economy, law, organizing via concise legislation and an efficient inter-sector control as well as efficient implication of sanctions.

Evethough, the realisation of the concepts of the Theory of Management into a sustainable development seems in the present to be a distant future, there are however essential conditions such as cooperation and expert knowledge of the participants (civil society, entrepreneurs, different fields' experts, legislators) that have to be met first.

The effect of raising of awareness and educating brings stronger and better results than the passing of a new legislations, declarations and regulations that are sadly going to, without a concrete change of understanding and expertise of the processes on the field of sustainable development that considers social interactions between the subjects involved that are a part of the process, stay merely mechanisms for constraint and by no means a way towards a sustainable development. By that we mean the development of the society as a whole that builds welfare today and the present then becomes a foundation for the welfare of the society of the tomorrow, where when achieving the set goals all cooperate evenly and equally no matter the economic or legal position, the public service as well as the executants and users.

### 7.3 What are innovations?

The term "innovation" has in the last decades in governmental and international documents been very popular. It has turned over from the educational and research institutions onto the enterprises where it became clear that both the world economy and especially the society depend on knowledge and communication. The efficiency of products, production processes and systems on all levels, all areas is the key for a permanent competitive position as well as for the society as a whole.

Many authors have and are still dealing with the answer to the question What is innovation? When trying to make a definition we cannot overlook the term “invention” for in real life both terms are often used, sometimes wrongly with the same, one explanation for the two. Dictionaries in our opinion do not offer an adequate content line of separation between the two terms since they explain innovation as a new occurrence or a novelty but at the same time they explain that innovativity means something referring to a (significant) improvement. We could deduct that an innovation means “invention” of something new and innovating merely improving something that already exists but both only possible on a technical field. Invention is explained as inventiveness or imagination. Deducting from the later an invention could be a new idea or an idea on how to improve, change or use etc. something that already exists. A separate distinction (excluding the restriction that it has to be technical) is therefore not offered there.

The traditional concept of innovation had at first indeed been focused on the development of technology and closely linked to the internal research of an individual company. Lately however, the concept often also integrates into the remaining business spheres. (Manochehri 2010, p. 4–14)

In theory, many authors deal with trying to define both terms where a special emphasis is given mostly to the meaning and the content of the term innovation. Some think that innovation is an idea that can in time offer an added value (Bessant and Tidd 2011, p. 4–14) but most of their opinions are that we can only talk about innovation when it is in fact implemented in practice and gets its value through commercialization (Hartley 2005, p. 27–34, Verloop 2004, p. 1–142, Freeman 2002, p. 191–211, Achilladelis and Antonakis 2001, p. 535–588). Among the authors there is no dilemma about innovation being something new or improved, the differences are in determining the moment when a “novelty” actually gets defined as an innovation.

Mulej and others (2008, p. 8) define invention as a pre-stage of innovation by defining the invention as “an idea that promises to maybe someday – usually with a lot of effort and investing – become an innovation.” Innovation however, (according to the international definition) defines as “any novelty, useful according to experience and evaluation of the customers/clients”.

We can conclude that an invention is only an idea (it could be totally new or it can improve something that already exists) that only after a successful transfer into practice turns into an innovation. Given, that it is not necessary for an invention to turn into an innovation, Schumpeter (1939, p. 84) distinctly divides the process of invention and the process of innovation and even believes that the later can emerge even without an invention.

The experience and the evaluation from the users can be equated with commercialization though. In the case of a positive response from the users or a positive commercialization the innovation gains its value.

In spite of different meanings innovation and invention are indeed correlated. Invention on its own does not have any economic or social value until (and if) it is implemented into practice – until it becomes an innovation. We believe though that innovation could not exist without a previous invention.

Because of this correlation Mulej (2008, p. 10) talks about an inventive – innovative process, demonstrated in the picture below.

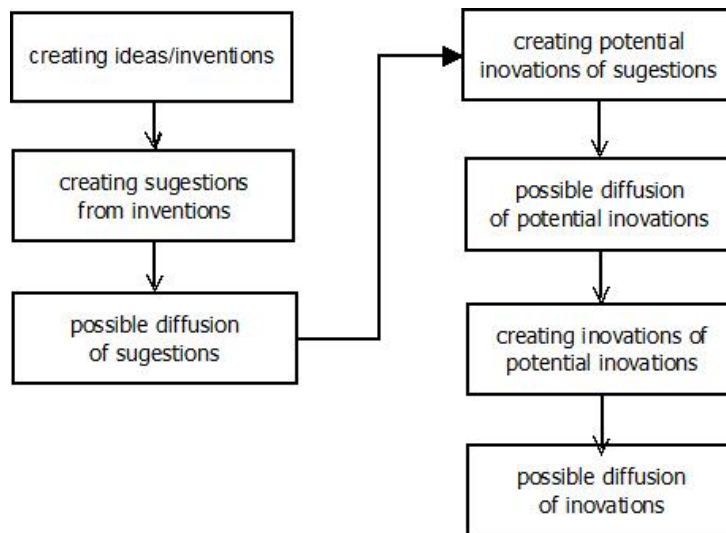

**Figure 18:** Inventive – innovative process  
Source: Adapted after Mulej, 2008

With us you can  
shape the future.  
Every single day.

For more information go to:  
[www.eon-career.com](http://www.eon-career.com)

Your energy shapes the future.





Mulej (2008, p. 10) writes the conditions for a creation of an innovation in the equation:

$$\text{Innovation} = \text{invention} \times \text{enterprise and entrepreneurship} \times \text{integrity} \times \text{management and leadership} \times \text{staff} \times \text{culture} \times \text{suppliers} \times \text{clients} \times \text{competitors} \times \text{social environment} \times \text{the natural environment} \times \text{random events} / \text{luck}$$

### Types of innovations

When classifying innovations in theory, we come across some rather different points of view that depend on individual research focuses.

Damanpour and Goplkrishanan (2001, p. 18–20) are focusing mainly on product – based and process-based innovations. They divide the first into the new products or services that are presented either within an organization or on an outer market and the process innovations that are divided into organization of production or services.

We can also divide innovations with respect to public or private interests. Innovations of the public interest are innovations that have consequences for a broad public; their stakeholders are usually collective entities such as countries, states, organizations and social movements. They are mostly innovations from the fields of social or political circumstances. (Wejnert 2002, p. 299) Those innovations often have long-term or even historical consequences for they can lead toward reforms also in the field of human rights.

Innovations with private interest on the other hand have mainly influence on stakeholders that are usually either individuals or small organizations. Their purpose is mainly to improve the quality of an individual's life or it is a matter of organizational and social reforms. (ibid.)

North and Smallbone (2000, p. 145–157) divide innovations into five main ranks namely on the product-based and service-oriented, development-marketing, methodology – marketing ones, process and technology based innovations for administrative purposes.

A wide classification however is presented by Mulej (2008, p. 122–123) who distinguishes between no less than 20 different types of innovations and divides them according to:

- the content of innovations (programme based, technically-technological ones, organizational, managerial, methodological),
- the consequences of innovations (distinction between the radical, that wreck the given knowledge and the applicability of equipment and to the tiny ones that strengthen the pre existing knowledge),
- the professional duty to innovate (the differences are in the ownership of an innovation; within the work related duty the owners are the employers, outside of the work related duty they are innovators themselves.).

OECD (2005, p. 18-20) defines innovation activities as all scientific, technological, organizational and commercial steps, which lead to the implementation of innovation. Some of these activities are innovative per se, whereby others or not; but are still crucial for the implementation of innovation. Research and development understatements contain innovation activities, which are not directly linked with the development of a certain innovation. Further it classifies innovation activities into three stages:

- Successfully ended and implemented innovation, by which a successful commercialization isn't a condition;
- Period of innovation activities, which didn't yet result in an innovation implementation;
- Stopping the activity even before the implementation of the innovation.

In most occasions though in the official documents the OECD systematic is quoted distinguishing innovations into four types, be they new to a company, new on a market or new to the world, as follows:

- Product-based innovations, those include a new or improved service. Here we can find also important improvements of technical specifications of components and materials, incorporated software, customer friendly and other functional characteristics;
- Process-based innovations include a new or significantly improved production or a delivery method. That includes important changes in technology, equipment and/or software;
- Marketing innovations include new marketing methods with important changes in a form of a product or packaging, division of products and their promotion or evaluation;
- Organizational innovations, including a new organizational method of a business practice of a company, organization of workplaces or organizing contacts with outer partners.

### Innovations types in public services

Most research from the field of innovations and innovating models is tied to companies that can with a successful implementation of innovations into their operation ensure themselves a competitive advantage, an efficient development and also profit. Despite the fact that the value of innovation is indeed measured in inputs and outputs (material, human, with respect to time, financial etc.) we can still not measure everything according to the win/lose principle.

Public services like healthcare, education and social security cannot generate profit but they have an enormous impact on quality of millions of peoples' lives. Implementation of good ideas leads to added value of public services, the already existing ones and the potential future ones. (Bessant and Tidd 2011, p. 6)

Particularly in time of an economic crisis are innovations the key to good development projects also in the field of carrying out of public services or building of public infrastructure, not only on national levels but mainly on the lower levels like local communities. Those can define their advantages and recognize their weaknesses much easier in their development plans.

With respect to issues of public services and the construction or maintenance /management of infrastructural facilities we could, according to the OECD (2005, p. 47–53) classification, briefly define the innovations in local communities as:

- Product-based innovations, those include a good or an improved public service, where we can also add a new or in an important way improved infrastructure facilities, customer friendly services and new or importantly improved information system and such.
- Process-based innovations include a new or significantly improved method of carrying out processes including the process of adopting legislation or issuing provisions, resolutions and the like. They can also include important changes in technology, equipment and/or in software.
- Marketing innovations may include new methods of raising awareness of a population in the sense of sustainable development, a new way of charging for public services, new methods for promotion of the public – private partnership in the sense of co operations between all the stakeholders in creating a development policy and the like.
- Organizational innovations include a new organizational method of a business practice of a municipality or of a carrier of public services, an improved organization of workplaces and tasks or a new way of organizing the workload between the carriers of public services in the population and the like.

© 2013 Accenture. All rights reserved.

be > your degree

Bring your talent and passion to a global organization at the forefront of business, technology and innovation. Discover how great you can be.

Visit [accenture.com/bookboon](http://accenture.com/bookboon)

Be greater than.

consulting | technology | outsourcing

accenture

High performance. Delivered.

[Click on the ad to read more](#)

### Significance of innovations

Without any regard to differences in defining and classifying innovations the theory stays unified in the consciousness that innovations are fundamental tools of public and private sectors for improving competitiveness and productivity, and crucial to achieving a sustainable development of the society as a whole. The need for innovations is a necessity without which it is impossible to even talk about a development.

Innovations are naturally not something simple or could be taken for granted. Numerous big companies lost many projects after a change on a market occurred. (Hamel and Prahalad 1994, p. 79–117) The main reasons had been that they were convinced they were good enough and given the fact that they had not been able to adapt to the changes in their environment quickly enough. (Leonard-Barton 1992, p. 111–126)

Innovations mean big changes in organizations of all sizes and legal forms as a response to the changes in the environment. Bessant and Tidd (2001, p. 5) claim that the logic is very simple: "...if we do not change our offer (products and services) and the way on which we produce then we risk to be taken over by others that are going to do just that." Those who are going to survive are the ones who are going to react to changes in time, focused and regularly. Especially the later is of extreme importance since development means that it is necessary to react to each and every change. That what was yesterday considered an innovation could tomorrow already be obsolete. It is vital to adapt to change regularly, as one goes along.

The companies where the process of innovating is a constant stay competitive and successful in their activity. There is however possible to detect at least two things in all of them and these are that they master the management of changes and are flexible enough and adaptable enough to survive at least one innovation crisis. (Kelley and Gibson 2010, p. 2)

It is essential for the public sector to be aware of the importance of innovations mostly for two fundamental reasons:

- The quality of public services has an influence on people's lives in the whole society. Without an innovative, sustainable, accessible and efficient public service and local autonomy it is impossible to even imagine a development of cities, hamlets and villages and with that of wholesome regions.
- Innovations in public services have positive effects on access to information, a faster execution of services for monetary operations and for citizens/ members of community. In addition to that they contribute to competitiveness and innovativeness of companies.

Numerous governmental and international documents witnessed the importance of innovations. With their guidelines and strategies they are trying to influence the development of innovations and the innovating culture as well as in the public as in the private sector especially:

- a) To release the innovations,
- b) To encourage people to innovate,
- c) Encouraging and using the knowledge,
- d) Use of innovations to solve global and social challenges,
- e) Improvement of management and evaluating innovation policies.

The necessity of innovating and with this, also financing innovations has since long raised awareness in the economy. Progressive companies have their own sectors for research and development within their own organizational structure or they execute that important part of their development policies through other institutions. They spend a good part of their income to finance innovations and are at the same time trying to use numerous opportunities and financial encouragements for development of innovations through invitations for tender applications for governmental and international institutions (banks, development funds and similar). Often the problem of financing innovations appears to be in the small to medium size companies that are not yet established on the market or in development of new products or services that can take years.

Demographic pressures, bigger public expectations and strained fiscal circumstances are the reasons why municipalities and the public sector in general have to direct themselves into searching for innovation development solutions. For the key public services it is necessary to form wholesome innovation strategies. An execution of innovative projects or executing innovation practice or rules is impossible only from the budgetary resources. Therefore it is necessary to find alternative sources of financing just as the innovation design bases on cooperation with the private sector and on a joint search for possibilities of financing in numerous programmes in EU initiatives.

Innovations are a building stone of sustainable development of Smart communities (cities and smaller towns) and we cannot and should not characterize them as merely one of the indicators of development success or of an information and communications industry. They act as an interface on all the areas of sustainable development due to which also local communities can find in the programmes and EU initiatives numerous possibilities for financing strategically important innovation projects.

Hinter (2011) claims that innovation is the life blood of most organizations in the 21st century, but most of them regularly do things to snuff out innovation wherever it rears its head. He says that “Unfortunately, it’s easier to mess it up than to get it right, and the result is that employees end up confused, frustrated, and stifled.” and lists the following five things that a lot of leaders and companies do to stifle innovation:

- Lack of project leader,
- To many layers of management,
- Ignoring the brainstorming rules,
- Rely too heavily on data and dashboards,
- Under-resource your hidden opportunities.

Avoiding the well known mistakes by promoting innovation sometimes means restructuring the work organization or/and developing o new, fresh and creating space for generating ideas and managing new projects. According to the fact that archival services are public and established by the law, some changes are not easy to achieve. But on the other way such changes could represent an organizational innovation by themselves. (Hinter, 2011)

#### Brief overview of innovation models

The problematic of innovation models demonstrated in numerous researches in the fields of innovations and that can roughly be divided in the closed models and the open ones presents itself mostly on two levels. The first is that the innovations are mostly oriented only towards the companies' operating or IT development. The second is, as stated Eveleens (2010, p. 1), who theoretically explained that processes simply are not at a point yet where they could be used in specific situations in practical work of problem solving.

The closed innovation models have been and are still used mostly in big and strong corporations. The base paradigm of the closed innovations is namely in the conviction that successful innovations have to be controlled and protected from the public eye and in the (inaccurate) comprehension that they have within a company enough human and material resources for innovation and consequently for a successful performance on the market.



"I studied English for 16 years but...  
...I finally learned to speak it in just six lessons"  
Jane, Chinese architect

ENGLISH OUT THERE

Click to hear me talking before and after my unique course download

The main reason for the range of dissemination of the closed innovation models has been in the immoderate trials of protecting the intellectual ownership and at the same time within the legally and politically insufficiently specified frame for protection of intellectual ownership. The problem that has occurred as a consequence of the closed innovation models was the lack of connection between the theory and practice. On one side the research centres of the academic institutions did not apply their research and innovative conclusions onto practice, nor did they try to market them. On the other hand, the big companies that needed innovations for the development of their field and for making a place on a market for themselves consequently organized their own research centres within companies where all the innovation activities were carried out in a highly restricted environment inside which no outside subjects were included.

Chesbrough (2003, p. 35–41) is convinced that a close innovation system does not meet the wanted development objectives and that companies should not rely only on their own knowledge but should instead also reach for the knowledge of others, at the same they should also share their own innovations that are not being used in their operations with the outer environment and in this way gain additional benefits.

He defines an open innovation model as a paradigm that anticipates that companies are able to and should use as much of the outer as the inner ideas as well as the inner and outer ways to reach a market if they wish to attain a progress of their own technology.

Marais and Schutte (2009, p. 96–116) distinguish between five types of open innovation models, namely the *Product platforming* (this model bases on a discussion on a half-product or a product development with intent to contribute to its functionalism and the added value), the *idea competition* (the model enables a competition organizer to gain as big a number of good ideas as possible, in an inexpensive way and at the same time get an insight in their customers' needs), the *inclusion of customers* (that model is intended for including the customers into the last stage of product production or the testing of a product in which way the company receives the feedback instantaneously), the *joint designing and developing of a product* (a company hands over the creating and the development of a product to outside partners. Such model is cheaper and usually faster as an independent product development.), the *innovation networks* (the model is intended for a target oriented problem solving in relation to research and product development).

An open innovation model as an “anti-thesis to the traditional vertical integration model” (Chesbrough, Vanhaverbeke and West 2006, p. 1) has in comparison to the closed model numerous advantages. It reduces the cost of organizing one's own research, offers possibilities for productivity improvements, and includes numerous stakeholders in the process of the very beginning of development, increases accuracy of market research and ensures a faster and simpler marketing. Its weaknesses are however mostly in the danger of information leaks, theft of an intellectual ownership, a complex approach to a supervision of innovations and selection of outer innovations as well as in the frequent corrigenda of the development strategies in order to ensure a bigger profit due to including outer innovations. (Chesbrough 2003, p. 21–63)

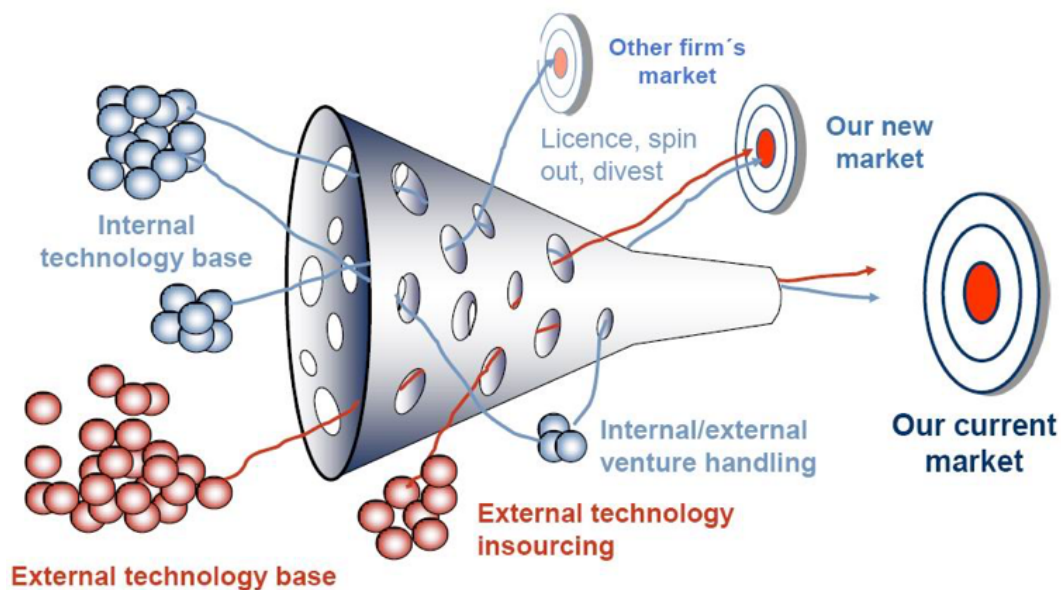

**Figure 19:** Open innovation model  
 Source: Chesbrough, 2003

Innovation models are closely linked with business processes in a company and consequently coincide with them according to their structure. In the picture below we show the structure of a traditional innovation process.

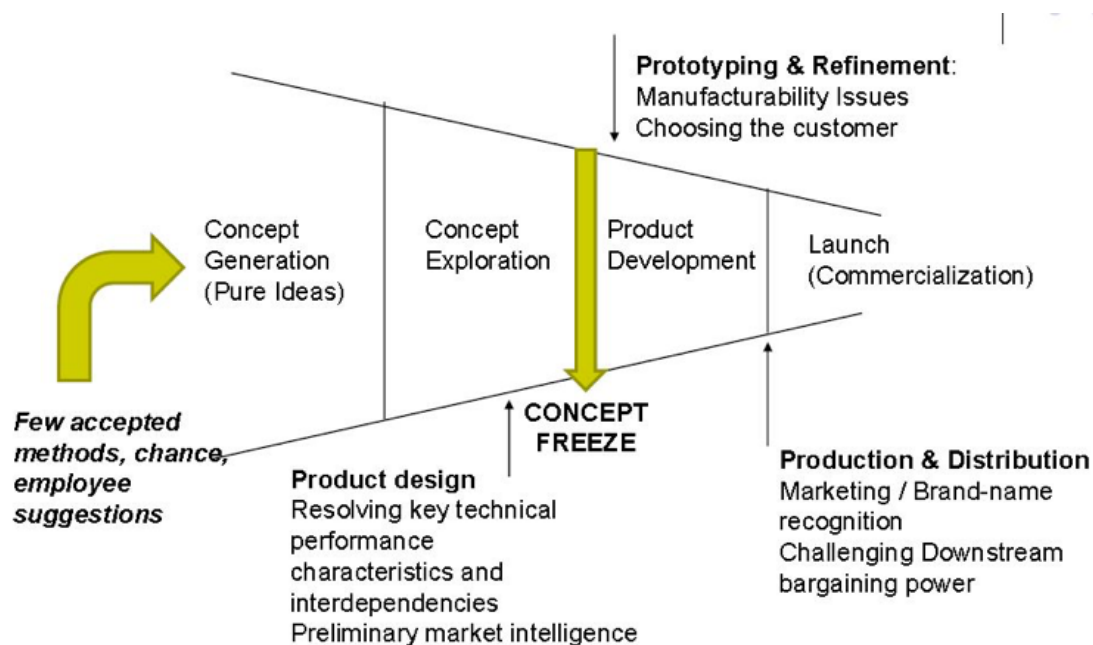

**Figure 20:** Traditional innovation model  
 Source: Murray, 2008



Unlike the traditional model the phase model of innovation process (demonstrated in picture below) has a clearer structure and is for a general understanding of project development much more appropriate. It is a formalized process of project management that is able to oversee more development processes at the same time. It enables a possibility of defining, tracking and an oversight of a project in accordance with the decision making criteria and a series of key business decisions. It simplifies reporting on individual phases of a project, since it includes standard terminology, integrates business functions and at the same time anticipates termination of those projects which do not fulfil the expectations. Somewhat problematic is only the inflexibility when introducing the changes within a process (due to the conditions on a market, replacement of the staff or equipment).

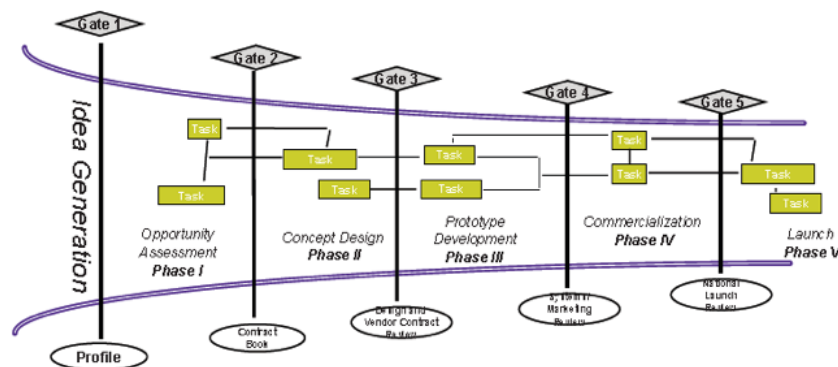

Figure 21: Phase gate model

Source: Murray, 2008

The banner is for Duke University's Fuqua School of Business. It features the school's logo in the top left. The background is a light grey world map. On the right, there is a circular collage of diverse people's faces. In the center of the collage, the word 'HERE.' is written in large, bold, black letters. Below the collage, the text 'BUSINESS HAPPENS' is written in large, black, sans-serif font. At the bottom left, the website 'www.fuqua.duke.edu/globalmba' is displayed. At the bottom center, there is an orange button with the text 'Learn More >'.



In our opinion the key advantage of the phase innovation process is the structure that is because of the time, content and process transparency the most appropriate one for co-funding.

Notwithstanding the fact that the models of innovation are in theory adapted mainly for business operating, they may also be applied to the innovation activities of the public sector or local communities. Considering the fact that local communities do not have sufficient material and personnel resources for innovating on their disposal, the close innovation model is entirely inappropriate. Its unfitness is further demonstrated also in the exclusion of all outer stakeholders, which is from the point of view of the concepts of sustainable development or smart cities simply unacceptable.

An open innovation model however can meet the needs of local communities because it bases on a wide inclusion of all participants (the public sector, the private sector, users) and in addition to that does not demand huge personnel or material resources. The structure of the phase model of innovation process is also in addition to that simply ideal for the co-funded projects. In the period when local communities are struggling more and more with the financial deficits while they are legally obligated to fulfil their legally based tasks and at the same time reach the sustainable goals of development strategies, the open innovation models can offer a rather good way for carrying out the co-financed projects.

#### 7.4 Financing innovations in public services

In the past the role of local government in the performance of public infrastructure was relatively simple. Local communities, provinces or districts were the primarily investors into the public infrastructure (energy [heating, cooling, lighting], management of agriculture, wood and building land, hospitals, roads, railways, public transport, schools, waterworks, garbage, air, broadband, and internet services for the citizens, healthy food). All this needs were covered predominantly from budget sources or with direct barrowing through local communities. Very common forms of financing were as well self-imposed contributions from citizens. Duo to the public sectors inability of covering the financial burden on one side and new technologies and innovation on the other side, this form of financing does not satisfy any more the growing needs for public standard. This means that local communities and government will be forced to look not just after new sources but as well after new ways of financing. At this point special attention has to be given to new technologies, with which local community and government would have to be acquainted with in order to keep on track with the progress, and innovation, which can be of crucial importance to sustainable development. Some experts from the field of innovation (Cooper 2005, p. 4–6, Kaplan and Norton 1992, p. 70, Albury 2005, p. 51–56) think that innovation are the key to survival of an organization, wherein it isn't important if the organization is market orientated or it works as an operator or manager of public services. Cooper (2005, p. 4–6) even claims: "This is war. Innovate or die."

The transformation of European cities requires considerable investment. Unfortunately, the debt crisis seriously affected a number of municipal budgets. The fundamental problem of financing new development projects is that cities, in addition to the large investments have neither the resources nor good credit ratings for searching cheap sources of financing. Additional austerity governmental measures restrict resources in municipal budgets. Thus leads to congestion in the transformation of cities and decarbonisation, which is a prerequisite for reducing greenhouse gas emissions. These in turn have a negative impact on the industry to develop low-carbon sector, employment and ultimately the key economic sectors such as energy, transport and ICT.

The main problems in financing of innovative solutions for the development of public services can be briefly defined as follows:

- high perception of risk for innovative solutions in the field of energy efficiency,
- uncertain energy prices and political uncertainty about the price of fossil fuels,
- very large investments,
- long term of repayment of the investment,
- limited capacity of public funds (there is no money in the budget, inability of seeking funds in the capital markets).

Given the strategic importance of cities it is an urgent need to find all possible financial tools for the implementation of development projects in smart cities and to develop mechanisms for pooling projects and create them attractive for banks and investors to attract long-term loans from specialized institutions and to develop new systems with off-balance sheet investment mechanisms of private capital and public private partnerships.

The main models for financing innovation projects for development of smart cities are:

- budget funding (state or municipal budget),
- combined budget funding of several municipalities for the joint project,
- budget funding in combination with funds from EU programs (there are several possible combinations:
  - budget of one municipality + EU funds,
  - budgets of several municipalities + EU funds,
  - combined budget funds of State and Municipalities + EU funds),
- funds from EU programs,
- private equity investment – public-private partnership,
- Crowd financing.

## 7.5 Public private Partnership

Local communities are more and more facing the problem of financing public services, especially in managing and building infrastructure. The resources for financing public services are getting smaller but on the other side the technological development is speeding the needs of higher public standard.

To help financing the city development projects EU developed some programmes and initiatives. In their frame the municipalities can develop innovative projects and candidate for the missing resources. Cohesion policies together with European Fund for Competitiveness and Innovation (Horizon 2020, COSME) also enable development of investments in integrated energies, transport and ICT.

Despite the relatively well-conceived legislation and numerous programs of European Union from which they can draw on the necessary resources, local communities still have problems with ideas, preparation and application-oriented projects sustainable.

Crowd financing is the newest form of financing projects. It is a form of massive investment of private capital individuals in the project, which for various reasons, believe that the project is enough innovative, attractive and important. As the main “channel” for the mobilization of financial resources does the Internet work. Although this funding mechanism is still in its infancy, the data show that gradually gaining ground. Estimated investment in projects in 2010 reached €400 million in 2011 €1.2 billion in 2012 more than 2.2 billion €. With such growth crowdfunding or crowd financing can respectively be classified in the ways of financing large projects for smart urban development.

The classic way of financing the construction of infrastructure from the state budget has become unacceptable; consequently the last three decades have brought radical changes around the world.

As a consequence of these changes two interdependent trends have emerged:

1. The withdrawal of the state from the field of infrastructure construction and operative management and
2. The evolving definition of the state’s role as a regulator of infrastructural activities increasingly provided by the private sector.

According to Milutinovič (2000, p. 442–451) in the procurement of the funds for public infrastructure financing, three different methods have become dominant, depending on the available resources:

- a) Financing from the current revenue; it foresees that infrastructure investment expenses are covered directly from the current budget revenue of the local authorities or state grants;
- b) Loans; comprises the covering of financial sources for infrastructure by issuing securities or raising loans in the capital market;
- c) Public-private joint ventures, including privatisation, that involve a partnership and contractual cooperation of the public and private sectors according to one of the possible forms of the cooperation of private subjects.

The interweaving of public and private interests can materialize in several different forms, and most often in the following three combinations:

- Public ownership of objects and public management;
- Public ownership and private management;
- Private ownership and private management.

The involvement of private capital (both human and material) in public infrastructure is not new in the world. The centre of gravity of the problem is the protection of individual interests either in the private or public sector, which does not allow a true partnership and is rarely able to overcome the relationship of client – contractor.

## Join American online LIGS University!

Interactive Online programs  
BBA, MBA, MSc, DBA and PhD

### Special Christmas offer:

- ▶ enroll **by December 18th, 2014**
- ▶ **start studying and paying only in 2015**
- ▶ **save up to \$ 1,200** on the tuition!
- ▶ Interactive Online education
- ▶ visit [ligsuniversity.com](http://ligsuniversity.com) to find out more!

Note: LIGS University is not accredited by any nationally recognized accrediting agency listed by the US Secretary of Education. More info [here](#).



Several variants of infrastructure projects with private funding exist:

**BOT – Build – Operate – Transfer**

This is the basic variant, where the infrastructure is owned by the state after the project is finished. To that point it is owned and operated by the concessionaire/private partner.

**BTO – Build – Transfer – Operate**

In this variant the infrastructure is owned by the state immediately after construction. The concessionaire is rewarded with the right to operate the object for a limited time.

**BROT – Build – Rent – Operate – Transfer or BLOT – Build – Lease – Operate – Transfer**

During the contract term the infrastructure object is put up for lease by the concessionaire.

**BOOT – Build – Own – Operate – Transfer**

In such projects the concessionaire is obliged to construct, finance and operate the object. In return they can levy the taxes and costs from the users. In such projects the concessionaire owns the object until they transfer the ownership to the state or the local community.

**BOO – Build – Own – Operate**

This abbreviation stands for projects where the concessionaire owns the object they operate and have no obligation to transfer ownership to the state or the local community.

Private investments in the infrastructure can be fully realized in BOT model projects. The short-form BOT characterizes a business relationship form, whereby the government or the local community grant a concession to a group of investors (a project consortium) for development, administrative and commercial marketing of a specific project. The consortium or the legal person who establishes such a concession-project is liable for developing the project and managing the concession in accordance to the contract.

The element of project development is a key element that separates this type of operation from an ordinary public concession. The development of a project in reality translates into the construction of necessary infrastructure. In a classic investment operation the investor takes charge of the entire financial burden. In BOT operations the financing is handled by the building contractor, motivated by the prospect of income from the operation of the concession to pay off any loans.

As the state/local community isn't required to invest in the infrastructure, they could be expected to maintain a passive attitude, expecting just to collect the concession taxes or to gain from the free infrastructure, and use their monopoly to entice the investors to make their best offers. But of course such a perspective would be too simplistic. The state or the local community should be aware of the following:

- In the end they will be the owners of the infrastructure and will need to ensure the continuity of services after the concession ends;
- Due to the heavy burdens and an unequal distribution of risks, the private sector will not be interested in such projects unless the state ensures an environment that will be legally and administratively favourable for the investors;
- The concession operation has to be controlled, as the issuer of the concession is obliged to provide the public services at a fair price.

As a result of these factors the state/local community has to display interest in the technological design of the project and at the same time offer guarantees and initiatives in order to even the distribution of risks and attract private operators and financiers.

The BOT model has become a globally established scheme for larger, especially international projects. We could say that the model is suitable for the establishment of infrastructure for public offices that are based on a profit-oriented supply of services and have to be economically justifiable. The question is, whether the BOT model could be used as a fulcrum in order to ensure the progress and realisation of both large and small, difficult and simple, international and national projects, which our societies, both developed and undeveloped, need very badly.

All these forms of BOT model have their advantages and weaknesses. The latter lay mostly in the difficult distribution of risks and interests. The public owner may not want to engage in the providing of services, and at the same time worries about the fate of infrastructure and the respect for public interests if the activities are taken over by the private sector. On the other side the private partner, despite the entrepreneurial spirit, won't be willing to invest in the infrastructure unless there are guarantees concerning the income and duration of the services. (Ilešič 2000, p. 62)

#### Disadvantages of BOT projects

The transition to partnership between the public and private sectors has found its legality in the roles taken by the public authority and the private subjects. The former is responsible for providing the essential services to the population according to the needs of the society. The latter service providers implement the services according to the cost/benefit criteria. Partnership of the two enables the association of both roles. Still, decisions must be rational, and the public authority needs to review all possible risks of such cooperation and thoroughly study the procedures of partnership formation to create successful partnerships (Jankovič 2006, 151).

What's essential in the entire process is the project itself. It should dictate the distribution of risks in order to stay in line. Taking charge of a risk should be compensated, and the efforts to reduce costs may influence the risks. A typical example is the risk of construction, which can be mainly controlled by the private party and therefore the insurance against that risk is reasonable. For example, the insurance costs can be incorporated in the construction price. In contrast, the commercial risk is often very big and the insurance for the risk can be costly for the private party. That is immediately evident from the higher price and higher subsidies in case the project is not self-sustainable. If the community takes charge of that risk, there is a danger that they may have to pay the compensation for the lack of revenue. Still, that can be acceptable if the project serves an important socio-economic interest.

The main categories of risks are (Aoust et al 2002, p. 28–46):

- Technical risks (design, construction);
- Financial risks;
- Demand risks (exploitation);
- Revenue related risks;
- Higher force risks;
- Macroeconomic risks;
- Legal risks.

**ie business school**

#1 EUROPEAN BUSINESS SCHOOL  
FINANCIAL TIMES 2013

**#gobeyond**

**MASTER IN MANAGEMENT**

**Because achieving your dreams is your greatest challenge.** IE Business School's Master in Management taught in English, Spanish or bilingually, trains young high performance professionals at the beginning of their career through an innovative and stimulating program that will help them reach their full potential.

- Choose your area of specialization.
- Customize your master through the different options offered.
- Global Immersion Weeks in locations such as Rio de Janeiro, Shanghai or San Francisco.

**Because you change, we change with you.**

www.ie.edu/master-management | mim.admissions@ie.edu | f t in YouTube





Some of these risks are limited to the private sector, e.g. the non-remunerative investments, and some to the public administration (inefficiency of public offices).

It is otherwise true that the risk in itself is not a disadvantage yet. However, when we talk about disadvantages risks are most likely to fall into this category. They transform into disadvantages at the moment when we are least prepared or when we do not know how to or cannot avoid them.

In comparison to the traditional form financing an infrastructure the BOT model brings on the following disadvantages:

- BOT projects are much more demanding than traditional investment programs, in the financial sense as well as in the legal sense;
- A big trap is having insufficient knowledge about the BOT model and not being qualified for using it in the real world;
- The BOT model demands clear and transparent legal regulations and foreseeable conditions for carrying out the activity;
- The costs for preparing and financing BOT projects are usually higher than for traditional forms of financing;
- In most cases, successful realization of a BOT project means a higher price for end-users of the service;
- BOT projects usually create revenues in domestic currency, while creditors can also be foreign partners. This creates a great risk in exchange rates, currency risks and risks in transferring capital (Perrot J.Y. et al 1994);

Simplifying the matter we can say that the state/local community, whereby the concessionary is a foreign partner, does not get much or anything at all from a BOT project. The capital in which a foreign partner has invested into an infrastructure shall be returned them in the form of payment for services and not to the state/local community. However, it is true that the state/local community has fulfilled its obligation in ensuring public services. Besides this, when talking about traditional BOT business, the ownership and administrative rights of the infrastructural building are transferred to public partner after the duration of the contract.

### The advantages of BOT projects

It is noticeable that intervening with partnerships between the public and private sectors ensures the operation of public services and infrastructures and offers numerous advantages although; it remains somewhat complicated for its realization and constant monitoring.

A BOT project is based on a partnership between the public/private sector and investors, whose aims are to draw-up, plan, construct and manage infrastructure projects that are usually ensured by using traditional mechanisms such as public tenders.

This partnership does not only mean intervening in the private sector for financing investment projects on the basis of revenues from the infrastructure, but also taking into consideration the competence, knowledge and experience in managing the private sector for the realization and operation of public projects in the most effective way (Namlard 2002, p. 8).

### **Reducing budgetary requirements**

Many times, the BOT model allows for the development of projects with little or even no usage of their own funds (many times, a fixed level of subventions is often needed), as private funds can be used. In many cases, the costs of the services can be transferred to the end-users (utility costs...). A price is calculated, which is close to the real cost, which is done with the aid of an acceptability campaign carried out by the public administration.

Some projects, which are financially profitable even enable for the establishment of new sources by sharing the profits amongst the contractors and the public administration (tolls, taxes...).

It is possible to develop a project without increasing the debt burdens or the affected state/municipal budget. Public sources can therefore be disposed of for other purposes.

The state's image or their ranking is better and enables them to access less expensive capital markets and as a result also attract foreign investors more easily.

### **Counter value of invested funds**

Besides reducing the burden on the budget, the BOT model (under the condition that we use it for suitable projects) allows for the optimization of projects and increasing profits for the allotted investment. These advantages appear in the following elements:

- Linking and synergy during the planning, constructing and operational phases. Of course under the conditions that we have all three phases under one tender;
- Innovation plan, reengineering and effective management;
- Emphasis on the quality of the service for the end-user;
- The way it is dealt with, which tries to reduce the total costs of the project throughout the whole life cycle: investment + maintenance + operations;
- Better usage of capital and creating additional revenues.

**The optimal distribution and transferring part of the risks to the private sector**

Projects regarding public and private partnerships almost always bring on a really high level of risks. Especially, because of the great financial amounts that are at stake, because of the uncertainty related to the costs of construction including operations and the uncertainty of revenues. The financial construction within the framework of the BOT model is based on the adjustment of distributing the risks after these have already been identified and enables that a certain part are transferred to the private partner if they are easier to control than the public administration.

The public administration can greatly reduce their exposure to risks, whereby in spite of everything it ensures the optimization of the project in this area.

**Realistic development and being in command of the costs**

The financial construction of the BOT model in the public administration enables for a better evaluation of the real costs of the project. A precise and real evaluation of costs is also necessary for the sheer promotion of the project as it aids attracting financing in the form of capital and loans. With its aid, we can avoid the cost deviations of the project, which are frequent in public infrastructure tenders. With the transfer of responsibility to the private partner in a BOT model, we can also avoid the undervaluation of real costs ex ante. Real costs enable for a comparison with the standard, which can serve as a basis for improving the quality and effectiveness of other public services in the future.

**SMS from your computer**  
 ...Sync'd with your Android phone & number

**FREE 30 days trial!**

Go to [BrowserTexting.com](http://BrowserTexting.com)

and start texting from your computer!

**BrowserTexting**



**Economic and social benefits**

If the worries of the participants are merely of a financial character, then the BOT project will most certainly suffer as a whole. We must not forget that the economic and social benefits must stay at the forefront of the partners' interests in the BOT project especially, because the project will be financed to a great extent from the revenues that will originate from it. It must be planned in a way that the best service for the best price will be ensured, which will satisfy as many end-users as possible.

The principle, which is hidden behind the term partnership between the public and private sectors, is based on the fact that the public administration remains responsible for the services it provides for its citizens and is not necessarily responsible for the investments themselves. This is how the public administration with the help of a financial construction in the form of a BOT model can relieve the burden of investments by devoting itself, above all, to the quality control of the service. On the other hand, the private partner possibilities in optimizing its investments (which is their job) so they can ensure the quality that is being demanded.

**Fast realization and the reliability in executing the project, which stimulates economic development**

If the project was evaluated as being beneficial to society, its installation in the form of a partnership between the public and private sectors can allow for the acceleration of its final realizations. At this level, the decision to a great extent depends on the disposability of budgetary funds, which can also be the reason for its postponement to a later date.

In this case, the projects get a more political dimension. On the other hand, its quick realization will also ensure a quick benefit for society as well as for politicians who connect a certain name with a certain project. This holds true regardless of the level of development in a country, which realizes its projects on the basis of partnerships between public and private sectors.

**The modernisation of the economy and the indirect benefits**

By accelerating the realization of projects, we also enable the acceleration in modernising the economy. Developing infrastructures and implementing new technologies is faster and because the realization of projects is directed towards the quality of the service it is more possible to take into consideration the needs regarding demand and adapt them to development more quickly resulting in enabling fast modernisation of the economy. The result is numerous indirect benefits for the country's economic development (i.e. higher standard of services, the use of environmental protection and modern technologies and the implementation of technical knowledge, etc.)

**Access to financial markets and development of the local financial market**

The use of private forms of financing for environmental protection projects has a completely positive macroeconomic financial effect for countries in development. Their access to financial markets is improving. By obtaining international capital, they strengthen the country's image in markets and they base themselves on huge operators, who have privileged access to international markets.

The private form of financing enables for a timely development of the local financial market. These complex constructions actually limit the number of financial sources and are often effective as a catalyst for the local market, which has to modernise and adapt itself.

**Social advantages: improving public services**

If we enable for a better identification of costs and a reduction in budgetary expenses for public administrations, the big project constructions under the BOT model allow for a better concentration of funds for financing that part of the project, which they have to ensure themselves, but is not profitable. Freeing up financial sources for other public services where a partnership between the public and private sectors is not possible or is possible just in a smaller form (healthcare, education, social protection, etc.) can allow the public administration to direct its funds and energy towards other social tasks.

**Enabling lasting development**

Contrary to widespread belief, intervention via the private sector with the BOT method can enable better consideration of all dimensions in development. The construction of infrastructures, which are necessary for the proper operation of public services, demands a great amount of investment and flexibility for operations. BOT models enable for faster realization of public services and lower costs for public finances.

On the other hand, entire public service cooperation with huge international groups means accessibility to the most modern technologies, which take into consideration the needs in the development sense, adapt themselves to the regulations around the world and are capable of innovating and adapting their offers in developing needs in the area of public services.

The implementation of the BOT model also enables for solutions that are better adapted to the demands according to the quality of the service, economic capacity and the public administration.

**The role of the state in concentrating on their initial tasks**

As the BOT model frees up the public administration from its administrative tasks, it simultaneously allows for it to concentrate on its initial tasks. As a result of this method, it can identify the needs and costs for public services more easily. It can also, in a very effective way optimally evaluate the level of public services, which the society wants and the costs involved. As a result, it can decide on economic and social effectiveness more easily.

### Technological benefits

BOT projects enable for the arrival of important professionals with international experience such as constructors, operators, engineers, legal advisers, systems analysts and financial analysts, etc. We can find these professionals alongside private partners as well as in public administrations. This has resulted in an important transfer of technologies, know-how and experience, which can be seen in many areas such as:

- Construction and systems for optimizing economic consumption (it is possible to offer the most modern technology and it is possible to adapt to local attributes);
- Managing the project and economic consumption;
- Financing engineering;
- Institutional engineering;
- The quality of software (The operations of the majority of industries in the economy has significantly changed with the forceful penetration of internet technology and as professor Leskovar states, the paradox of is that individuals and organisations are forcing themselves in the intense usage of program equipment, which frequently changes, is not user friendly for the entire population and is expensive (Leskovar 2000, p. 491–496);
- And many others.

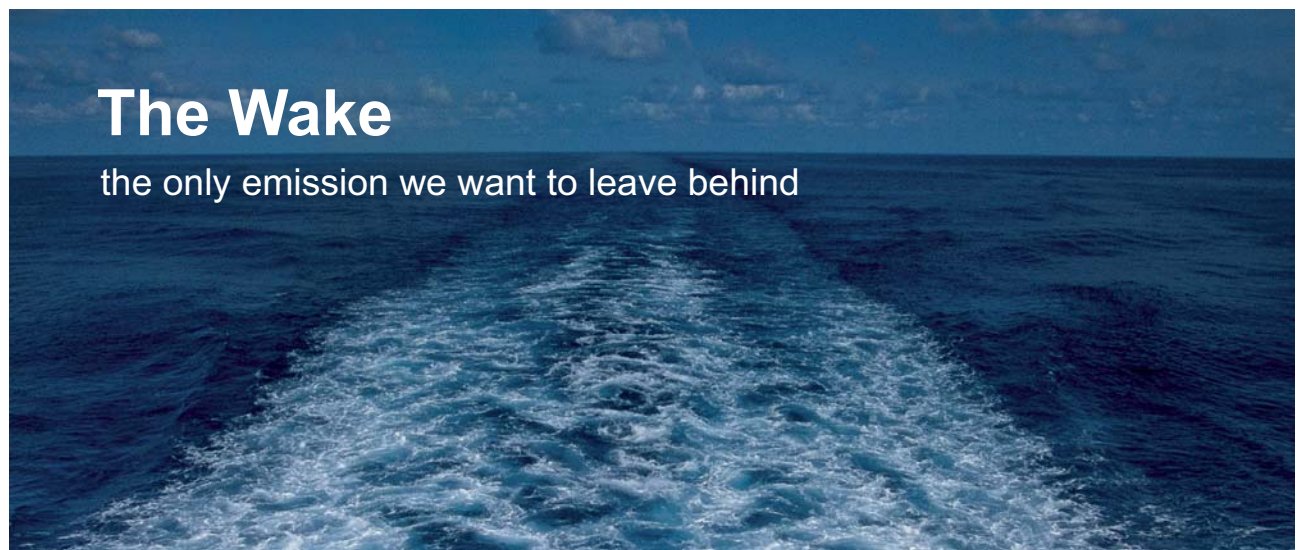

## The Wake

the only emission we want to leave behind

Low-speed Engines Medium-speed Engines Turbochargers Propellers Propulsion Packages PrimeServ

The design of eco-friendly marine power and propulsion solutions is crucial for MAN Diesel & Turbo. Power competencies are offered with the world's largest engine programme – having outputs spanning from 450 to 87,220 kW per engine. Get up front!  
Find out more at [www.mandieselturbo.com](http://www.mandieselturbo.com)

Engineering the Future – since 1758.  
**MAN Diesel & Turbo**



Click on the ad to read more

The transfer of technologies, know-how and experience first occurs in local companies that directly cooperate in projects as well as the rest of the companies at the local level. It also has an influence on the administration, which monitors the project, the local financial organisation, etc. An important factor is certainly the training and qualification of the local labour force. Foreign international companies that are part of the project will especially try to focus on the local labour force who they will adequately train. On their part, they will only send the most necessary group of staff, who are necessary for completing the transitional phase.

### **The new role of public administration**

The political advantages that originate from this are certainly not negligible. By directing public administration operations towards their initial tasks and intervening with the partnership between the public and private sectors, once again it is possible to define their role as a subject that directs and supervises and no longer as a subject in the role of owner and manager of property. Besides the benefits, which these projects bring to society, they also enable for stimulating the development of effective services, which have been better adapted to meet the demand. As a result, public administrations come out on top because they ensure a better quality of services, by directing its funds in way that takes into consideration the social points of view more strongly. Furthermore, implementing BOT projects allows for the rethinking of the distribution of roles between the public and private sectors.

### **The assignment and “non-resignation” functions**

BOT projects allow for alluring private investors, whereby connecting public projects with personal profit does not occur. In essence, we can define BOT projects as delegating the implementation of public services for a defined period of time. Just as well it does not alienate public property within infrastructures. Infrastructures, that had already existed before the contract and new ones as well that have originated on the basis of concessions in fine, become owned by the administration that gives the concession.

The public authority preserves its function in appointing public service projects and assures their legal regulation.

A partnership between the public and private sectors allows for the preservation of the essential “public” part of these services and avoids the accusation of saying that it is “giving” the property to foreigners or third parties.

## Stability

The above described social and economic advantages evidently positively influence economic and political stability, as well. Besides this, the contracts are signed for a period of time that is longer than the political mandates. In general, public services are, directly as well as indirectly less touchy for the outcomes of “elections”. The maintenance and the quality of services are also less subject to this type of risk and the projects must show a true social-economic character in order to be chosen. On the other hand, with the improvement of public services without any excessive pressure in the area of taxation, BOT models conjure up economic and social stability.

In spite of this fact, it is worth emphasising once again that it is necessary to avoid rashness.

It is essential that we take enough time to prepare society and administrations really well, foresee the time period of transition so people can come to terms with the fact that it is necessary to pay for the service (or at least a part of the service) and that we ensure good regulations, which will help us prevent immoderations.

## Conclusion on Public private partnerships

BOT projects are a specific combination between traditional projects and ones with concessions. However, in spite of the many advantages it is especially necessary to take into consideration the basic methodologies of BOT projects, which are:

- Well structured financing of the project in the framework of a partnership between the public and private carriers enables for the improvement of this project. Moreover, the incorporation of the financiers is a guarantee for their quality and optimization. However, it cannot ensure the life cycle of the project, which in itself does not have sufficient economic and social good;
- Financers closely monitor the quality of the participants and the quality of the project and the project's environment: the institutional and economic framework, the quality and incorporation of builders, the legal and technical abilities of the concession giver, and the economic parameters of the contract...;
- The ad hoc structure of the company for the project is also important, which is the project carrier and connects the active items of the project and links up the partners in the project;
- The intervention of the public administration in the area of financing the project, which is in the form of a partnership between public and private carriers is often times necessary and founded because of their social-economic interest. Intervention is only possible with the input of assets, funds or guarantees;
- The traditional forms are no longer adapted to levels of risk (few assets, revenues are founded only on the flow of funds, which are evaluated with a specific level of uncertainty), the value nor the duration of the partnership between public and private carriers.



BOT projects are also effective for the state and local communities and are the best possible method (with the lowest costs) for building a public infrastructure and realizing its usage in the economy by ensuring the best possible services. The reason is in the lack of funds as well as in the lack of adequate human resources. In the case of a BOT project, where the concessionary is a foreign party both the state as well as a local community will have to come to terms with the fact that the profits are going to go abroad. Evidently, this problem will have to be solved somewhat pragmatically, especially when legitimate interest for implementing a public service project exists.

Last but not least, we cannot and must not forget the end-users (thus the citizens). For them, BOT projects are going to represent two different sides of a coin. Legislation will represent quality and an undisturbed service, which by all means will satisfy it. The other side of the coin represents the payment aspect for its implementation. Regardless of the fact if the concessionary is a foreigner or a domestic legal person, the service will have to be paid for. The price will be higher than in the case if the state/local community would carry out the activity in another form (for which it will probably not have the human resources or the funds). Not only will the profit have to be paid for but also the interest on the capital, which the concessionary will take.

## TURN TO THE EXPERTS FOR **SUBSCRIBE** CONSULTANCY

**Subscribe is one of the leading companies in Europe when it comes to innovation and business development within subscription businesses.**

**We innovate new subscription business models or improve existing ones. We do business reviews of existing subscription businesses and we develop acquisition and retention strategies.**

**Learn more at [linkedin.com/company/subscribe](https://www.linkedin.com/company/subscribe) or contact  
Managing Director Morten Suhr Hansen at [mha@subscribe.dk](mailto:mha@subscribe.dk)**

**SUBSCRIBE** - to the future

The end-users will simply have to radically change their standpoint on service consumption in which public administrations have assured in one form or another and it will be necessary to come to terms with the fact that services simply cost more.

The latter is of course necessary to add an awareness of the importance of sustainable and balanced regional development, but without the support of adequate resources (both material and human) it remains just a wish.

## 7.6 Smart municipalities

Forming different strategies in order to reach urban growth in metropolises of different regions had at first been based on information – communications technologies (IT) and has consequently caused a vast range of research in the field of urban development, urban innovations and IT sector innovations. An undue prominence (merely) in the field of IT as the main (and the only) foundation for the assessment of urban development has avalanched critiques out of which we can read out that such a strategy of development neglects numerous other possibilities of development of cities and at the same time it underestimates the negative influences from the new technologies (Hollands 2008, p. 306–319). Paskaleva (2009, p. 405–422) and Odendal (2003, p. 585–607) claim that the advantages and the possibilities offered by IT in fact do need to be used however; the urban development has to be built on perspectives that enable integration of more participants, more sectors and more levels.

The definition of a “smart city” that has for long been tightly linked to IT development has started to change and supplement. Komnitos (2002, p. 337–355) believes though that is mostly due to distinguishing between the terms “smart city” and “digital city” where he defines the later as an intelligent city that is oriented in a strong integration of three main dimensions of intelligences existing in a city, namely the human, joint and artificial intelligence. (Komnitor 2006, p. 17–18, 2008, p. 122–123) A special characteristic of an intelligent city that is to say a highly developed area of innovations that are in addition to the ability to solve new problems, the main characteristics of intelligence. (Komnitos 2006, p. 53–61)

We are convinced that merely setting a line of division between the smart and the intelligent cities was not in fact the only reason for redefining the definition of smart cities. The more likely reasons could be in establishing that the innovations only in the field of IT and a revolutionary development of the sector were simply not enough to achieve the wanted effects as well as in the deficit of an active cooperation of multiple sectors which would contribute to a more even development of cities.

The concept of a smart city differs from the concept of digital or intelligent cities by focusing rather on the human capital and education as a driving force of an urban development than simply on the role of the IT infrastructure. (Jung, Phaal and Sang-ho 2013, p. 286–306)

Nor the definition nor the concepts in theory on their own are unified which is no surprise considering that the goal is to achieve a sustainable development for which again there is no unified definition. Some authors have been, when setting the priorities of the concept, leaning towards a more efficient, sustainable and a live model of urban development that has a fundamental vision of environmental and social durability. A smart city is therefore simply called a sustainable city. (Cozens 2008, p. 429–444, Marshall and Toeffel 2005, p. 673–682)

Having stated that, the fact that the concepts of development and consequently the definitions are indeed changing due to the additionally acquired knowledge, innovations, possibilities and last but not least the new, different needs of people as well as of the environment, should not be overlooked.

**wethrive.net**

**How to retain your top staff**  
**FIND OUT NOW FOR FREE**

**DO YOU WANT TO KNOW:**

- What your staff really want?
- The top issues troubling them?
- How to make staff assessments work for you & them, painlessly?

**Get your free trial**  
 Because happy staff get more done



Zygiaris (2013, p. 218–224) claims that a smart city is a “generic term describing an innovative urban ecosystem based on information technology”. As a help to the designers of innovation ecosystems he conceptualizes a model constructed of seven areas within which the cities should find their priorities, put them into action and in such a way accomplish a sustainable development. The areas he defines are the following:

- A city ( a tradition of their own, an identity of a city, smart priority tasks, people as the driving force of cities and the behavioural impact on the city’s historical and cultural heritage.)
- A green city ( new urban theories with an emphasis on environment and natural resources protection)
- Networking ( spreading of the green economies and the broadband economy)
- Responsiveness ( a new generation of the interactive technologies)
- Free integration ( open source internet services)
- Applicability ( infrastructure, smart networks, gaining energy from recyclable sources and the like)
- Innovations (creating a fertile innovation environment for new business opportunities).

A smart city should by content mean a modern, urban centre in which the development would with intent to increase the competitiveness run equally in the IT area as well as in the social and environmental areas, claims Caragliu (2009, p. 2–14). It is necessary however to take into the consideration the six important factors in order to be able to call a city smart. If we summoned up the results of the final report on the smart cities prepared by the Centre for regional sciences at the Vienna Technology University (2007, p. 10–12) we can establish that they are in some way consistent with the traditional and the neo-classicist theories of urban growth and development. Especially, since they are based on the theories of regional competitiveness, transport, IT, economy, the natural resources, the human and social capital, the quality of living and cooperation of citizens in city management. We can therefore say a city is a smart city only when the investments in the human and private capital as well as in the traditional and modern communication infrastructure enable a sustainable economic development, a high quality of life and a wise managing of natural resources with a cooperation of the inhabitants.

In the direction of smart cities there are a lot of efforts at European level in research and financial programs and supporting initiatives. Definition “smart city” by itself and its content in form relate primarily to large or medium-sized cities. With regard to the high concentration of people in big cities these efforts are understandable.

However, we believe that even small local communities are an important part of society and they should be treated just as seriously as the big cities, especially in regions where there are no metropolitan areas and the population is inhabited in many smaller local communities.

In ensuring sustainable development, both big cities and small local community has substantially the same functions in terms of development of regional competitiveness, transport, ICT, economy (in small rural municipalities Agriculture is also an important factor), natural resources, human and social capital, quality of life and citizen participation in the management of the community in which they live.

Thus, large cities and small municipalities are obliged to provide public services, both economic and non-economic. Commonly to a lesser extent but still the well-being of the population in small municipalities is also measured by the quality and accessibility of public services.

A quick comparison of non-economic areas shows that large cities usually have universities, opera houses, clinical centers, etc. Small municipalities that do not have (what actually no one really expected), but there must be guaranteed at least basic health care and basic (sometimes even secondary) education. Usually the smaller places traditionally have their local theater or performance spaces.

If, as the main problems of big cities air pollution and the environment due to industrialization and transport and uncontrolled release of greenhouse gases can be considered, the main problems of rural areas and small towns definitely are pollution of groundwater by herbicides, poor accessibility (road networks, broadband) and the impact of climate change on agriculture.

It is certain that both big cities and smaller municipalities have the same needs. The difference is only in the setting of priorities and due to small size (both territorial and demographic) the size of the investments. In doing so, we should not ignore the following facts:

- large cities have several options for implementation of high technology and promoting innovation because they have more resources within reach (both financial and human),
- most of the research in the field of urban development relates primarily to the metropolis and big cities. Medium-sized and small cities, where the development rules are different (in the struggle for competitiveness they have less critical mass of resources and organizational options) remain insufficiently explored.

Promoting sustainable and smart development of major cities, disregarding the different needs of the population of small towns or medium-sized and smaller cities could eventually lead to excessive migration to large cities and the abandonment of activities which are typical for the smaller villages (disappearance of traditional crafts, etc.) and culture. That could also mean supersaturation of the population in large cities and regression instead of the development of small towns.

This problem is well known in the abandonment of agricultural activities and migration of population in larger cities. Analogy smart cities and smart municipalities (smart communities) is consequently a logical and urgent need.

## 7.7 References

1. Achilladelis, B. in Antonakis, N. The dynamics of technological innovation: the case of the pharmaceutical industry. *Research Policy*. 2001. p. 30, 535–588.
2. Albury, D. *Fostering Innovation in Public Services*. *Public Money & Management*. 2005, p. 51–56.
3. Aoust, J.M., Bennet, C. in Fiselson, R. *L'analyse et le partage des risques, des partenariats clés entre les secteurs public et privé*. Presses de l'École nationale des Ponts et chaussees. Paris, 2002, p. 28–46.
4. Bessant, J. in Tidd, J. *Innovation and Entrepreneurship*, 2nd edition. Wiley E-Text. Hoboken. 2011. p. 4–14.
5. Brundland, United Nations, “Report of the World Commission on Environment and Development.” General Assembly Resolution 42/187.
6. Caragliu, A., Del Bo, C. in Nijkamp, P. *Smart cities in Europe*. Serie Research Memoranda 0048 (VU University Amsterdam, Faculty of Economics, Business Administration and Econometrics). 2009, 2–14. URL.: <http://degree.uvu.vu.nl/repec/vua/wpaper/pdf/20090048.pdf>
7. Centre of regional science. *Smart cities, Ranking of European medium-sized cities, Final report*. Vienna University of Technology. Vienna, 2007. p. 5.
8. Chesbrought, H.W. *The era of open innovation*. Massachusetts. MIT Sloan Management review Spring. 2003 Vol.44 issiu 3, p. 35–41.

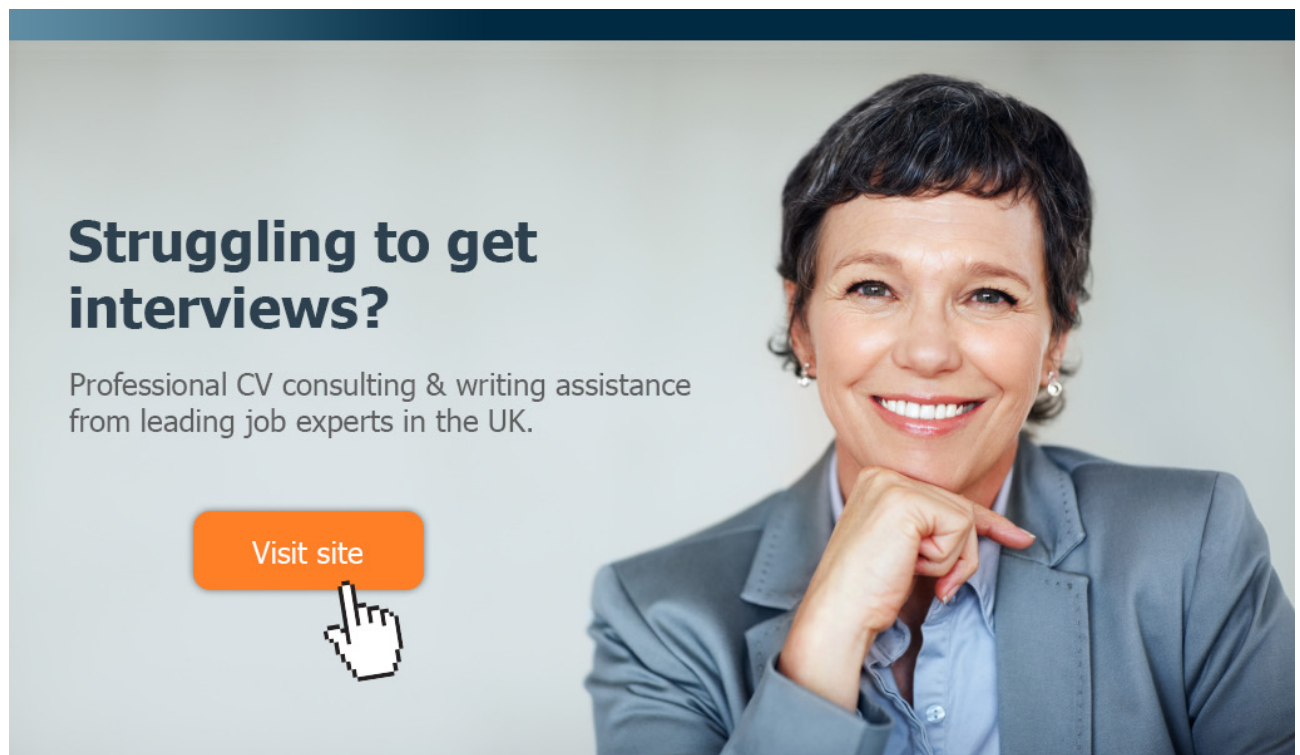

**Struggling to get interviews?**

Professional CV consulting & writing assistance from leading job experts in the UK.

Visit site

 Take a short-cut to your next job!  
Improve your interview success rate by 70%.

 **TheCVagency**  
Visit [theagency.co.uk](http://theagency.co.uk) for more info.



Click on the ad to read more

9. Chesbrought, H.W., Vanhaverbeke, W., West, J. eds. *Open Innovation: Researching a New Paradigm*. Oxford: Oxford University Press, 2006. ISBN: 0-19-929072-5, p. 1.
10. Cooper, R.G. (2005). *Product Leadership*. USA: Basic Books, p. 4-6.
11. Cortese, A.D. The critical role of higher education in creating a sustainable future. *Plan high educ.* 2003. p. 31, 3, 15–22.
12. Cozens, M. New urbanism, crime and the suburbs: a review of the evidence. *Urban Policy and Research*. 2008. p. 26, 4, 429–444.
13. Damanpour, F. in Gopalakrishnan, S. *The Dynamics of the Adoption of Product and Process Innovation in Organizations*. *Journal of Management Studies*. 2011. p. 38, 1, 45–65.
14. Eveleens, C. (2010). *Innovation management; a literature review of innovation process models and their implications*. Nijmegen, NL, pp. 1–16.
15. Freeman, C. (2002). *Research Policy. Continental, national and sub-national innovation systems – complementarity and economic growth*, p. 191–211.
16. Halle, M., Najam, A. in Beaton, C. *The Future of Sustainable Development: Rethinking sustainable development after Rio+20 and implications for UNEP*. International institute for sustainable development. Canada, 2003. p. 1–14.
17. Hamel, G., and C. Prahalad. *Competing for the Future*. Boston: Harvard Business School Press, 1994. p. 79–117.
18. Hartley, J. *Creative industries*. Blackwell Publishing. UK, 2005. p. 27–34.
19. Hasegawa, Y. *Control Problems of Discrete-Time Dynamical Systems*. V: THOMA, M., ALLGÖWER, F. in MORARI, M. (ur.). *Lecture Notes in Control and Information Sciences*. Springer-Verlag. Berlin Heidelberg, 2013. p. 1–7.
20. Hiner, J. *How to kill innovation in five easy steps*, Tech sanity check, TechRepublic, USA, 2011.
21. Hollands, R.G. *Will the real smart city please stand up?*. *City*. 2008. p. 12, 3, 303–320.
22. Ilešič, M. *Javne koncesije in pogodbe BOT*, Ekspert's report of the "Inštitut za gospodarsko pravo v Mariboru" (Institute of Commercial Law in Maribor): Organiziranje gospodarskih javnih služb v okviru nove pravne ureditve lokalne samouprave v Republiki Sloveniji, Maribor, 2000, p. 62.
23. Jankovič, P. *The risks of private capital participation in public projects*. V: JAŠKOVÁ, M. (ur.). *ECON '05: [selected research papers]*, (Research works proceedings, 12, 2005). Technical University of Ostrava, Faculty of Economics. Ostrava, 2005, p. 149–156.
24. Kaplan, R. in Norton, D. *The Balanced Scorecard – Measures that drive performance*. Harvard Business Review. Boston. 1992, p. 70.
25. Kelley, B. in Gibson, R. *Stocking your innovation bonfire. A Roadmap to a Sustainable Culture of Ingenuity and Purpose*. John Wiley and Sons, Inc. Hoboken, New Jersey, 2010. p. 2.
26. Komninos, N. *Intelligent cities: innovation, knowledge systems and digital spaces*. Spon Press. London, 2002. p. 10–15, 337–355.
27. Komninos, N. *The Architecture of intelligent Cities*, Conference Proceedings Intelligent Environments 06. Institution of Engineering and Technology. Athens. 2006. p. 17–18, 53–61.
28. Komninos N. *Intelligent Cities and Globalization of Innovation Networks*. Routledge. London in New York, 2008. p. 122–123.

29. Lee, J.H., Phaal, R. In Lee, S.-H. An integrated service-device-technology roadmap for smart city development. *Technological Forecasting & Social Change*. 2013. p. 80, 2, 286–306.
30. Leonard-Barton, D. (1992) core capabilities and core rigidities: a paradox in managing new product development. *Strategic Management Journal*, Summer Special Issue 13: p. 111–126.
31. Leskovar, R. Kakovost programske opreme v novi ekonomiji. *Organizacija*. 2000, vol. 33, No. 7, p. 491–496.
32. Lukman, R. Trajnostni razvoj v visokem šolstvu: Učinkovita in okoljsko odgovorna univerza, Doktorska disertacija. Univerza v Mariboru. Maribor, 2009. p. 40–90.
33. Marais, S.J. in Schutte, C.S.L. The development of open innovation models to assist the innovation process. Department of Industrial Engineering University of Stellenbosch, South Africa. SAIIE 2009, Roodevallei, Gauteng, 2009. p. 96–116.
34. Marshall, D. in Toffel, W. Framing the elusive concept of sustainability: a sustainability hierarchy. *Environ Sci Technol*. 2005. p. 39, 3, 673–682.
35. Manoochehri, G. Measuring Innovation: Challenges and Best Practices. *California Journal of Operations Management*. 2010. p. 8, 1, 67.
36. Milunovič, V. (2000). Zagotavljanje lokalnih javnih služb z vidika projektnega financiranja. *Ekonomsko-poslovna fakulteta Maribor: Naše Gospodarstvo*. Letnik 46, št.2–3, str. 442–451.
37. Mulej, M. in soavtorji. *Invencijsko-inovacijski management z uporabo dialektične teorije sistemov: (podlaga za uresničitev ciljev Evropske unije glede inoviranja)*. Korona plus. Ljubljana, 2008. p. 8–10, 122–123.
38. Murray, F. *Managing Innovation & Entrepreneurship*. MIT Sloan School of Management. OpenCourseWare 2008. P. 23–28.  
URL: [http://ocw.mit.edu/courses/sloan-school-of-management/15-351-managing-innovation-and-entrepreneurship-spring-2008/lecture-notes/10\\_lec.pdf](http://ocw.mit.edu/courses/sloan-school-of-management/15-351-managing-innovation-and-entrepreneurship-spring-2008/lecture-notes/10_lec.pdf)
39. Namlard, C. *Traitement pragmatique des partenariats entre institutions publiques et privées*. Presses de l'École nationale des Ponts et chaussees. Paris, 2002, 8.
40. North, D. in Smallbone, D. The Innovativeness and Growth of Rural SMEs during the 1990s. *Regional Studies*. 2000. p. 34, 2, 145–157.
41. OECD, 2005, "The Measurement of Scientific and Technological Activities: Guidelines for Collecting and Interpreting Innovation Data: Oslo Manual, Third Edition" prepared by the Working Party of National Experts on Scientific and Technology Indicators, OECD, Paris.
42. Odendal, N. Information and communication technology and local governance: understanding the difference between cities in developed and emerging economies. *Computers, Environment and Urban Systems*. 2003. p. 27, 6, 585–607.
43. Paskaleva, K. Enabling the smart city: The progress of e-city governance in Europe. *International Journal of Innovation and Regional Development*. 2009. p. 1, 4, 405–422(18).
44. Perrot J.Y., Chatelus G., Namlard C., Bezancon X., Aoust J.M., Craug Bennett T., Fiselson R., Oliver J.L., Esseg f., Farina H., Delelis P., Lecrivain A., *Le financement prive des infrastructures publiques*, Paris 1994.
45. Pichler, D. *Odgovornost do narave in ekologizacija prava*. Podjetje in delo. Ljubljana, 1997, 1291.



46. Schoeman, A. Three Pillars of Sustainability and What They Mean to Sustainable development. URL.: <http://www.theinnovationdiaries.com/2641/three-pillars-of-sustainability-and-what-they-mean-to-sustainable-development/>.
47. Schumpeter, J.A. Business cycles. A theoretical, historical and statistical analysis of the capitalist process. Volume 1. McGraw- Hill Book Company. New York, 1939. p. 84.
48. Sharachchandra, M.L. Sustainable development: A critical review. 1991. URL.: <http://www.sciencedirect.com/science/article/pii/0305750X9190197P>.
49. Temple, S. Old Issue, New Urgency?. Wisconsin Environmental Dimensions. 1992, p. 1.
50. Verloop, J. (2004) Insight in Innovation: Managing innovation by understanding the Laws of Innovation. Elsevier Science. str. 1–142.
51. Wejnert, B. Integrating Models of diffusion of innovations: A conceptual framework. Annual Reviews. 2002. p. 28, 299.
52. Wright, S.T. A. The Evolution of sustainability Declarations in higher Education. V: Corcoran, P.B. in Wals, A.E.J. (eds.). Higher Education and the Challenge of Sustainability: Problematics, Promise, and Practice. Kluwer Academic Publishers. Dordrecht, 2004. p. 761–768.
53. Zygiaris, S. Smart City Reference Model: Assisting Planners to Conceptualize the Building of Smart City Innovation Ecosystems. J Knowl Econ. 2013. p. 4, 2, 217–231.

**gaieteye**  
Challenge the way we run

**EXPERIENCE THE POWER OF FULL ENGAGEMENT...**

.....

**RUN FASTER.  
RUN LONGER..  
RUN EASIER...**

**READ MORE & PRE-ORDER TODAY  
WWW.GAITEYE.COM**

# About the authors

Vito Bobek, Ph.D., Associate Professor



Prof. Vito Bobek currently works as a professor of international management at the University of applied sciences FH Joanneum (Graz, Austria) and at the University of Maribor (Slovenia). He is also a manager and owner of Palemid – Consulting, Research, Education LLC.

His teaching activities at the FH Joanneum are associated with the master programme Business in Emerging Markets where he is responsible for two courses: Introduction to Emerging Markets and Cross-Cultural Management. At under-graduate level of the Faculty of Economics and Business, University of Maribor he teaches the course International Economic Relations, at the Faculty of Tourism and Hospitality Management, University of Rijeka, Croatia he delivers the course in Macroeconomics within the Ph.D. programme. Finally, at the Faculty of European and Public Studies in Brdo pri Kranju, Slovenia, he teaches Management of European Projects.

His other positions are: Member of supervisory board at KBM Infond (Investment company, Maribor, Slovenia), Member of managing board at AREMA (Academy of Regional Management, Slovenia), Regional editor for Central and Eastern Europe at “European Journal of International Management”, Member of editorial board at “International Journal of Trade and Global Markets”, Member of editorial board at “Imago Europae” (Florence, Italy), Member of “Team Europe Slovenia”.

In the past he served as a partner in 'Dr. Ferk & Partner Management Consultants' (München – Maribor - Ljubljana), as a member of 'Team Europe Slovenia', and as a vice-dean for international cooperation at the Faculty of Management Koper, University of Primorska as a local module director at master programme 'The Process of Building Europe' at the University of Siena, Italy and as an adviser to the minister of Economic Relations and Development of Slovenia for conducting Strategy of International Economic Relations.

During the last five years, he has been involved in the following international projects: Cooperation Programme INTERREG V-A Slovenia-Hungary 2014-2020; Cooperation Programme INTERREG V-A Slovenia-Austria 2014-2020; Developing Regional Actions to Promote SMEs in Health Sector and Stimulate Economic Growth - Health4Growth (Interreg IV C); Internationalization Model for Companies in Five Steps: Rain-Maker - Slovenian Trade and Investment Promotion Office; European Union for Youth – Life Long Learning Programme, Jean Monnet Programme and Managing Migration and its Effects in SEE - Transnational Actions Towards Evidence Based Strategies – South East Europe, Transnational Cooperation Programme.

His research interests are related to International Business, Strategic Management, Regional Economic Integration, Cross-Cultural Management and Management of Cities and Regions.

Anita Maček



Anita Maček defended her Ph.D. in 2009 at the University of Maribor, Faculty of Economics and Business. Currently she is a researcher and an Assistant Professor at the Doba Faculty Maribor, Slovenia and at the International Business School Ljubljana, Slovenia.

Since 2010 she is she is a deputy editor of “IBS Poročevalec” and since 2015 a member of editorial board for “Mednarodno inovativno poslovanje”. Since 2009 she also acts as a member of Management board in Union of economists of Slovenia.

In the past she acted as a research assistant at the Institute for Economic Law at the Faculty, research assistant at the Institute for Economic and Corporate Government (IECG) in Maribor and consultant at the consulting company Dr. Ferik & Partner Management Consultants (München – Maribor - Ljubljana).

She has been involved in a number of research projects. Some of them are: Cooperation Programme INTERREG V-A Slovenia-Hungary 2014-2020; Cooperation Programme INTERREG V-A Slovenia-Austria 2014-2020; Developing Regional Actions to Promote SMEs in Health Sector and Stimulate Economic Growth - Health4Growth (Interreg IV C); Vision and Development Strategy for Municipality of Kidričevo; Project management and development of regional projects for Podravje region (NUTS -3) in the years 2014-2020; Internationalization Model for Companies in Five Steps: Rain-Maker - Slovenian Trade and Investment Promotion Office etc.

The focus of her research published in numerous national and international journals are Cross – Border Mergers and Acquisitions, International Capital Flows, Foreign Direct Investments, International Business and Regional and Local Development. Between 2004-2014 she published 64 units. For details see: <http://izumbib.izum.si/bibliografije/Y20150402125112-A68065123.html>

She speaks English, German, Serbian, Croatian and Slovenian.

Mrs. Patricija Jankovič



Mrs. Patricija Jankovič is a founding president of AREMA – Academy of Regional Management, which was established in year 2012 to promote, distribute and create new knowledge and skills for responsible and sustainable management of regional resources. As Chairman of Senate and Head of Commission for research and study she is in charge of AREMA's academic affairs.

She is also CEO and chairman of ISMA – Institute for Innovative System Methods and Applications. By establishing ISMA in year 2010, her goal and guidance was creating interdisciplinary and multicultural teams of experts to research and consult in the field of leadership, public administration, regional and local development, innovation management and law.

Mrs. Jankovič is a lawyer and university lecturer for law and innovation management. She is expecting her Ph.D. degree in Public administration in May 2015. Her research focus is in integration of leadership education, law, innovations and management in public administration. She is a member of Research group for regional management, registered by Slovenian research agency.

As university lecturer she is a holder of several study modules, among them are European political, economic and legal system, Innovation management, Public private partnership systems and Contract and business law. At University College of Health Sciences, Slovenia and University College of Physiotherapy, Slovenia, she teaches in courses for Health and social law.

In her 30 years long carrier she acted as a consulter for regional management, public administration, business law and educational programmes. From 2000 till 2002 she was a President of the Committee for international affairs by the Community of Municipalities of Slovenia. As a member or chef of project teams she was involved in several international projects, such as ISO standard enforcement Project at University of Maribor, Faculty of organizational sciences (2005-2007), CERO - organization and financing of public services – public infrastructure; Municipality of Celje (2006-2007), ERDF, Central Europe Programme; Project "ET STRUCT - Economic Educational Territorial Structure (2010-2013), ERDF, Central Europe Programme; IDEA – Innovative Development of European Areas by Fostering Transnational Knowledge Development (2010-2013), Developing Regional Actions to Promote SMEs in Health Sector and Stimulate Economic Growth - Health4Growth; Interreg IV C (2012-2014), etc. In years 2002 – 2005 she was International project evaluator in Frame programmes in EU commission.

In year 2012 she expanded her work and became a member of editorial board for “Physiotherapy” (Collections of scientific papers published by Fizioterapevtika, Slovenia) and Chef Editor of publishing at AREMA Slovenia (Collections of scientific papers and study books).

While giving the invited lectures in India in 2013 at three different universities (Amity University, New Delhi/Noida, BIMTECH University, Birla Institute of Management Technology, Greater Noida, WE School Welingkar Education, Institute of Management Development & Research, Mumbai) she became a member of WILL FORUM (New Delhi, India) and a member of Advisory Board New Women’s Networking (Mumbai, India).

Beside her contributions in science and professional conferences, she is the author of several university study programmes. Speaking five languages (English, German, Slovenian, Serbian and Croatian) she contributed her knowledge and research in multiple international conferences, scientific and professional papers and discussions. She has also written two university textbooks in the field of commercial law. Her publication contains 98 units (1993 - 2012); more than 20 in foreign languages. For details see: <http://izumbib.izum.si/bibliografije/Y20150402111451-A8304227.html>

### **Contact**

Postal Address:

Patricija Jankovič

Zgornja Kungota 10j,

2201 Zgornja Kungota, Slovenija

### **Phone and E-mail:**

++386 315 615

patricija.jankovic@guest.arnes.si